









Global Instruments Inc.

**A Trusted Supplier of a Variety of
Surgical Instruments**

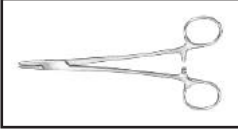

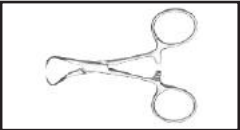
Instrument Catalogue

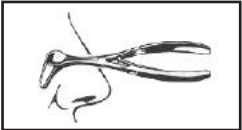
Table of Contents

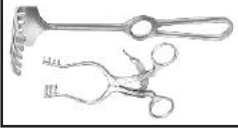
	SCISSORS
PAGE 01 TO 05	
	NEEDLE HOLDER
PAGE 06 TO 08	
	DRESSING & TISSUE FORCEPS
PAGE 09 TO 13	
	TOWEL CLAMPS
PAGE 14	
	HEMOSTATIC INSTRUMENTS
PAGE 15 TO 22	
	DIAGNOSTIC INSTRUMENTS
PAGE 23 TO 25	
	E.N.T INSTRUMENTS
PAGE 26 TO 39	
	NEURO SURGERY INSTRUMENTS
PAGE 40 TO 45	
	RETRACTORS
PAGE 46 TO 54	











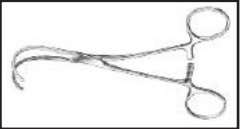

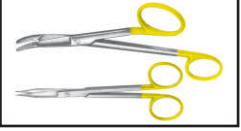
	ATRAUMATIC INSTRUMENTS
PAGE 55 TO 56	
	GYNECOLOGICAL & OBSTETRICAL INSTRUMENTS
PAGE 57 TO 67	
	TONGSTEN CARBIDE INSTRUMENTS (T.C)
PAGE 68 TO 78	
	BONE SURGERY INSTRUMENTS
PAGE 79 TO 94	
	ORAL INSTRUMENTS
PAGE 95 TO 97	
	HOLLOWARE
PAGE 98 TO 1100	
	EYE INSTRUMENTS
PAGE 101 TO 110	
	EXTRACTING FORCEPS
PAGE 111 TO 113	

Table of Contents

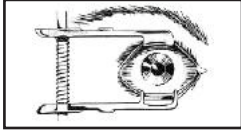
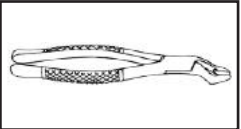
	ELEVATORS
PAGE 114 TO 117	
	MIRROR + HANDLE
PAGE 118	
	AMALGAM CARRIERS & SYRINGES
PAGE 119 TO 120	
	MISCELLANEOUS
PAGE 121	
	TUFFLIMIRE, CALIPERS ETC
PAGE 122	
	GENERAL DENTISTRY INSTRUMENTS
PAGE 123 TO 131	
	RUBBER DAM FORCEPS & CLAMPS
PAGE 132 TO 133	
	PLIERS
PAGE 134 TO 135	

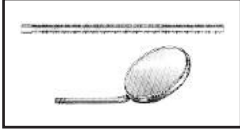
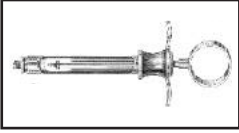
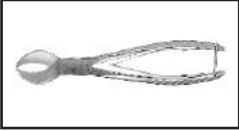
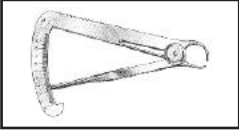
	E.M.S
136 TO 139	
	VETERINARY INSTRUMENTS
PAGE 140 TO 142	
PAGE 143 TO 148	BEAUTYCARE INSTRUMENTS

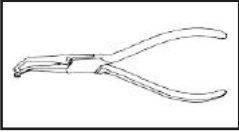

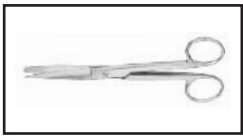
SCISSORS

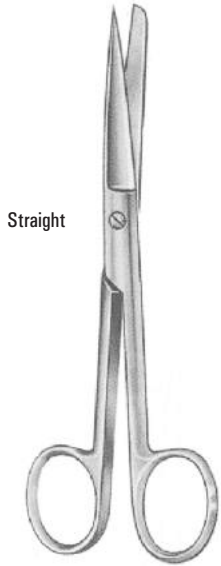

Straight

Operating Scissors

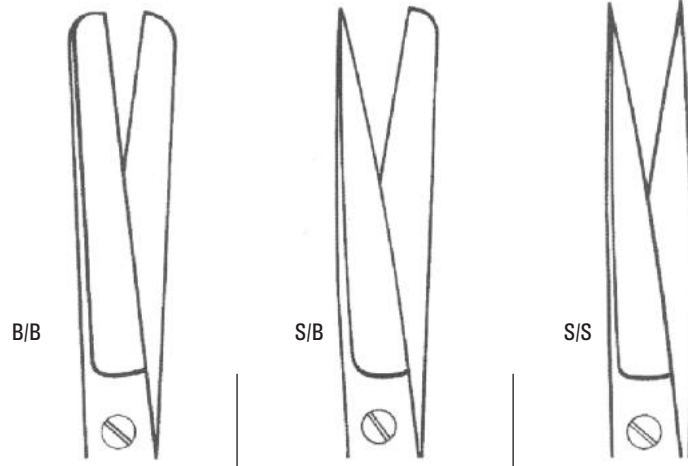

SIZE	B/B	S/B	S/S
4¼" (11.5 cm)	GII-103	GII-100	GII-101
5" (13.0 cm)	GII-1421	GII-1422	GII-1423
5½" (14.5 cm)	GII-107	GII-106	GII-108
6" (15.5 cm)	GII-1424	GII-1425	GII-1426
6½" (16.5 cm)	GII-1427	GII-110	GII-112
7" (17.5 cm)	GII-1427	GII-1428	GII-1429
7¼" (18.5 cm)	GII-1430	GII-1431	GII-1432
8" (20.0 cm)	GII-1433	GII-1434	GII-1435

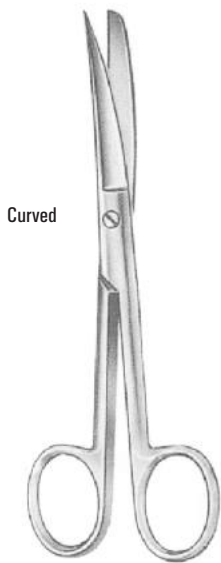

Curved

Operating Scissors

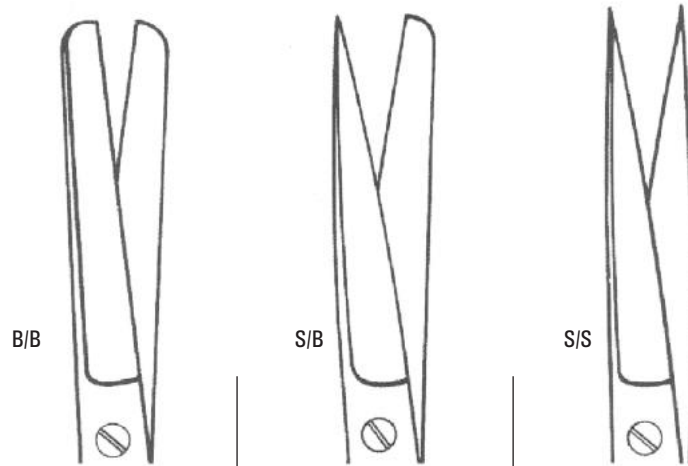

SIZE	B/B	S/B	S/S
4¼" (11.5 cm)	GII-103c	GII-100c	GII-101c
5" (13.0 cm)	GII-1450	GII-1451	GII-1452
5½" (14.5 cm)	GII-109c	GII-106c	GII-108c
6" (15.5 cm)	GII-1436	GII-1437	GII-1438
6½" (16.5 cm)	GII-1439	GII-1440	GII-111
7" (17.5 cm)	GII-1441	GII-1442	GII-1443
7¼" (18.5 cm)	GII-1444	GII-1445	GII-1446
8" (20.0 cm)	GII-1447	GII-1448	GII-1449



SCISSORS

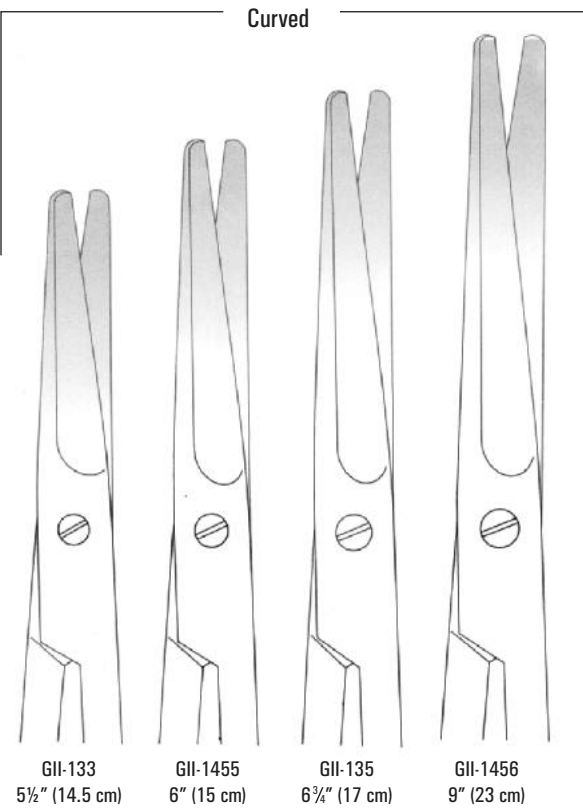
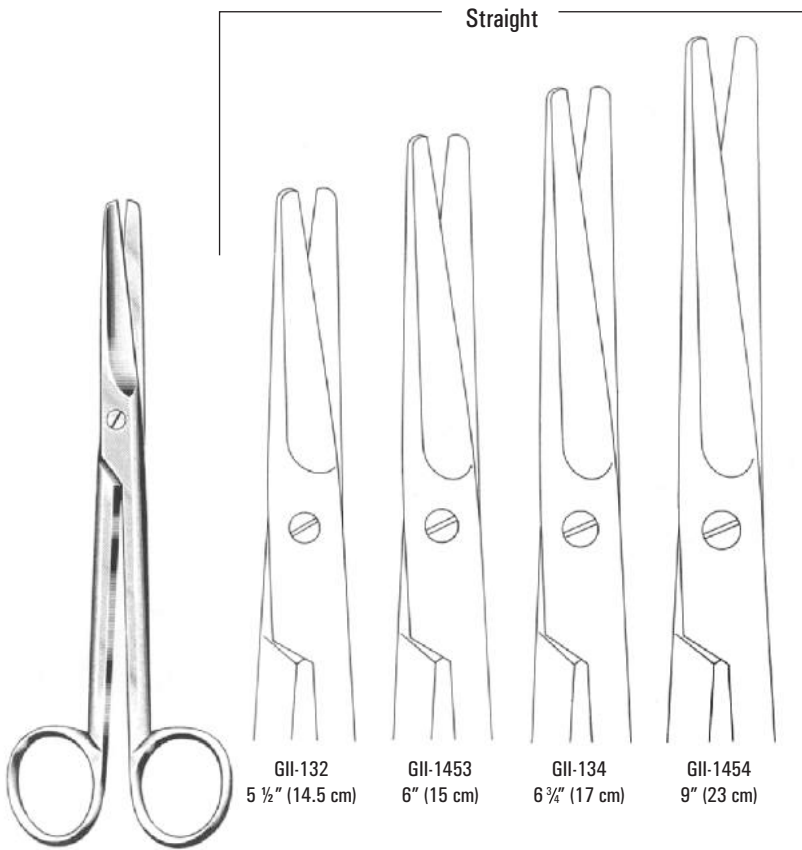
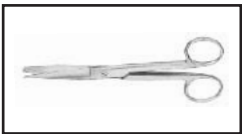

Mayo Dressing Scissors

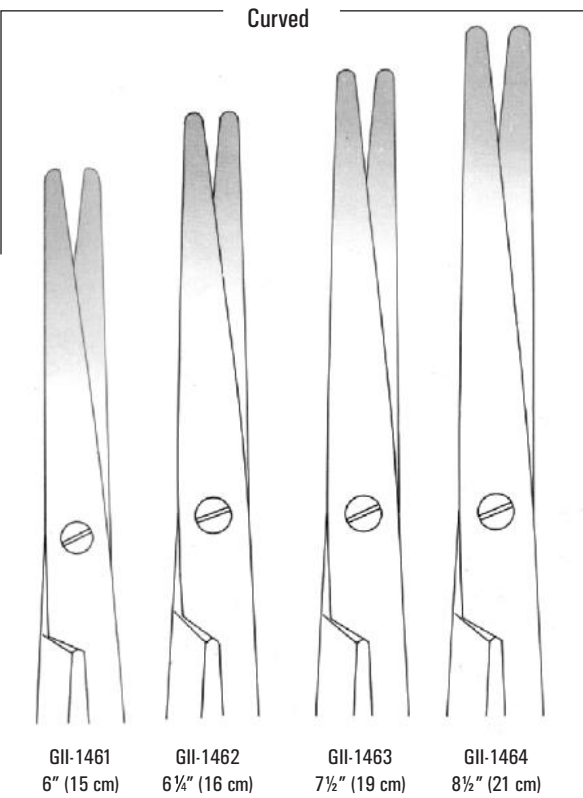
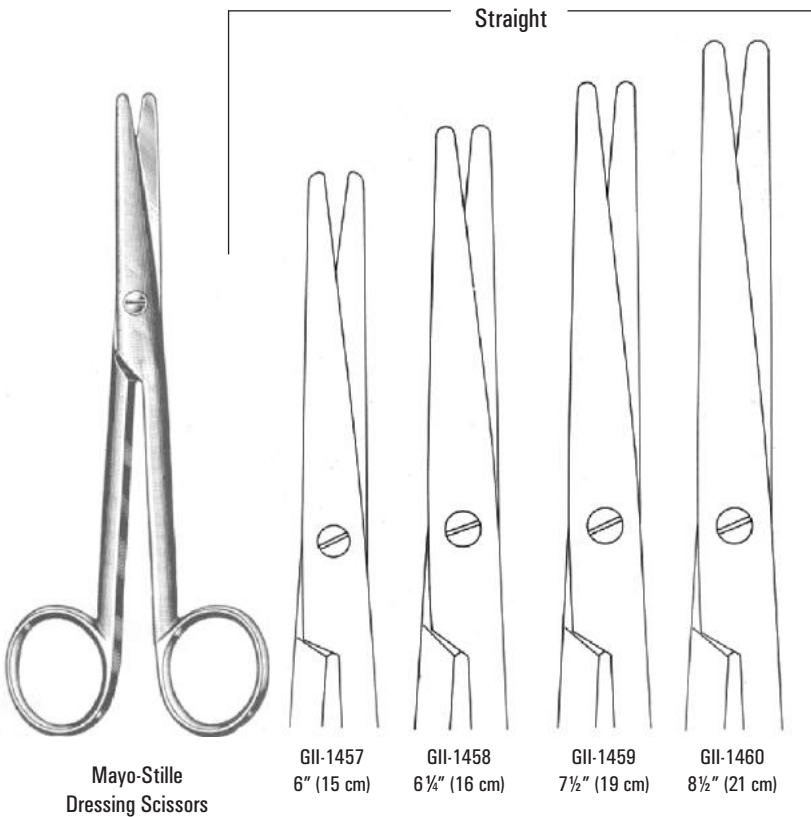

Mayo-Stillle Dressing Scissors

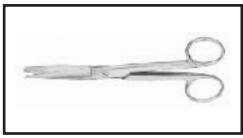

SCISSORS



Straight

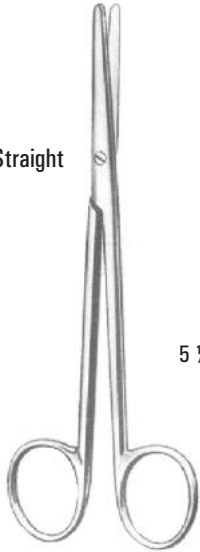

Metzenbaum Scissors



GII-136
5 1/2" (14 cm)



GII-138
7" (18 cm)



GII-1465
8" (20 cm)



GII-1466
9" (23 cm)



GII-1467
10" (25 cm)



GII-1468
11" (28 cm)



GII-1469
12" (30 cm)

Curved

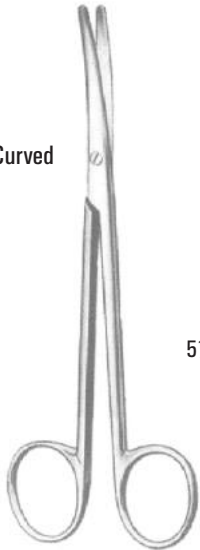

Metzenbaum Scissors



GII-137
5 1/2" (14 cm)



GII-1380
7" (18 cm)



GII-1470
8" (20 cm)



GII-1471
9" (23 cm)



GII-1472
10" (25 cm)



GII-1473
11" (28 cm)



GII-1474
12" (30 cm)



SCISSORS

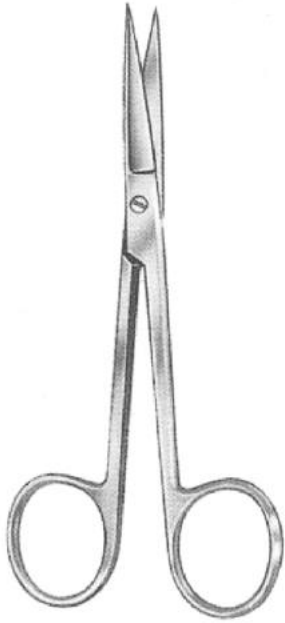

Iris Scissors

ARTICLE # Straight	ARTICLE # Curved	SIZE
GII-1475	GII-088	3 ½" (9 cm)
GII-1476	GII-089	4" (10 cm)



Stevens Strabismus Scissors

ARTICLE # Straight	ARTICLE # Curved	SIZE
GII-1477	GII-1478	4" (10 cm)
GII-144	GII-145	4 ½" (11 cm)

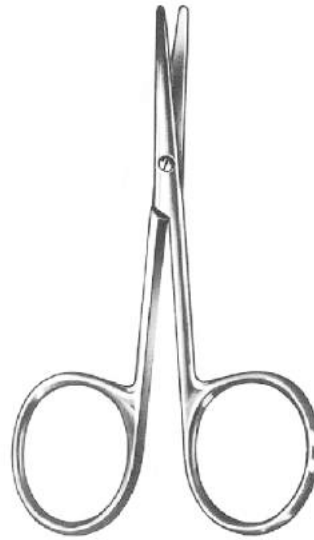

Lexer-Baby Scissors

ARTICLE # Straight	SIZE
GII-1479	4 ¼" (11 cm)
GII-1480	5" (12,5 cm)

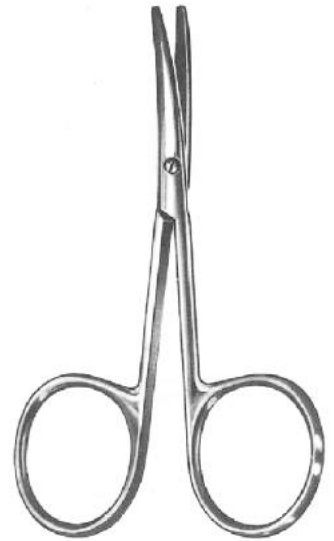

Lexer-Baby Scissors

ARTICLE # Curved	SIZE
GII-1481	4 ¼" (11 cm)
GII-1482	5" (12,5 cm)

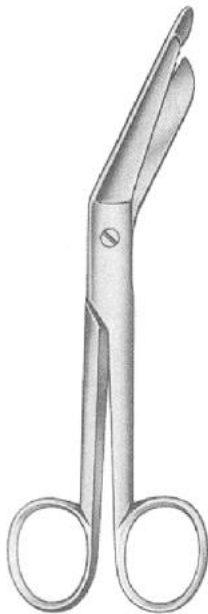

Lister Bandage Scissors

ARTICLE #	SIZE
GII-118	3 ½" (9 cm)
GII-119	4 ½" (11 cm)
GII-123	5 ½" (14 cm)
GII-124	7" (18 cm)
GII-125	8" (20 cm)

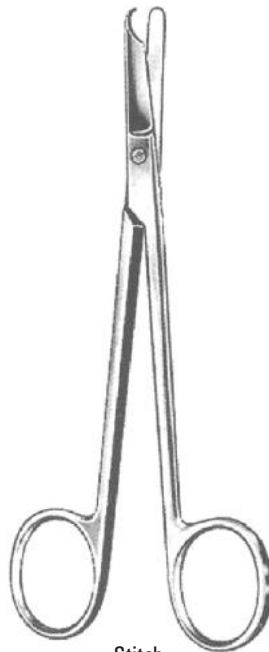

**Stitch
Ligature Scissors**

ARTICLE #	SIZE
GII-146	3 ½" (9 cm)
GII-147	4 ½" (11 cm)
GII-148	5 ½" (14 cm)

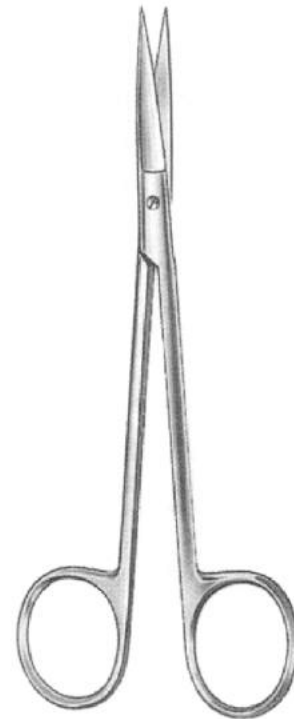

**GII-1483
Joseph Scissors
5 ¾" (14.5 cm)**

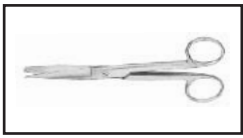

SCISSORS

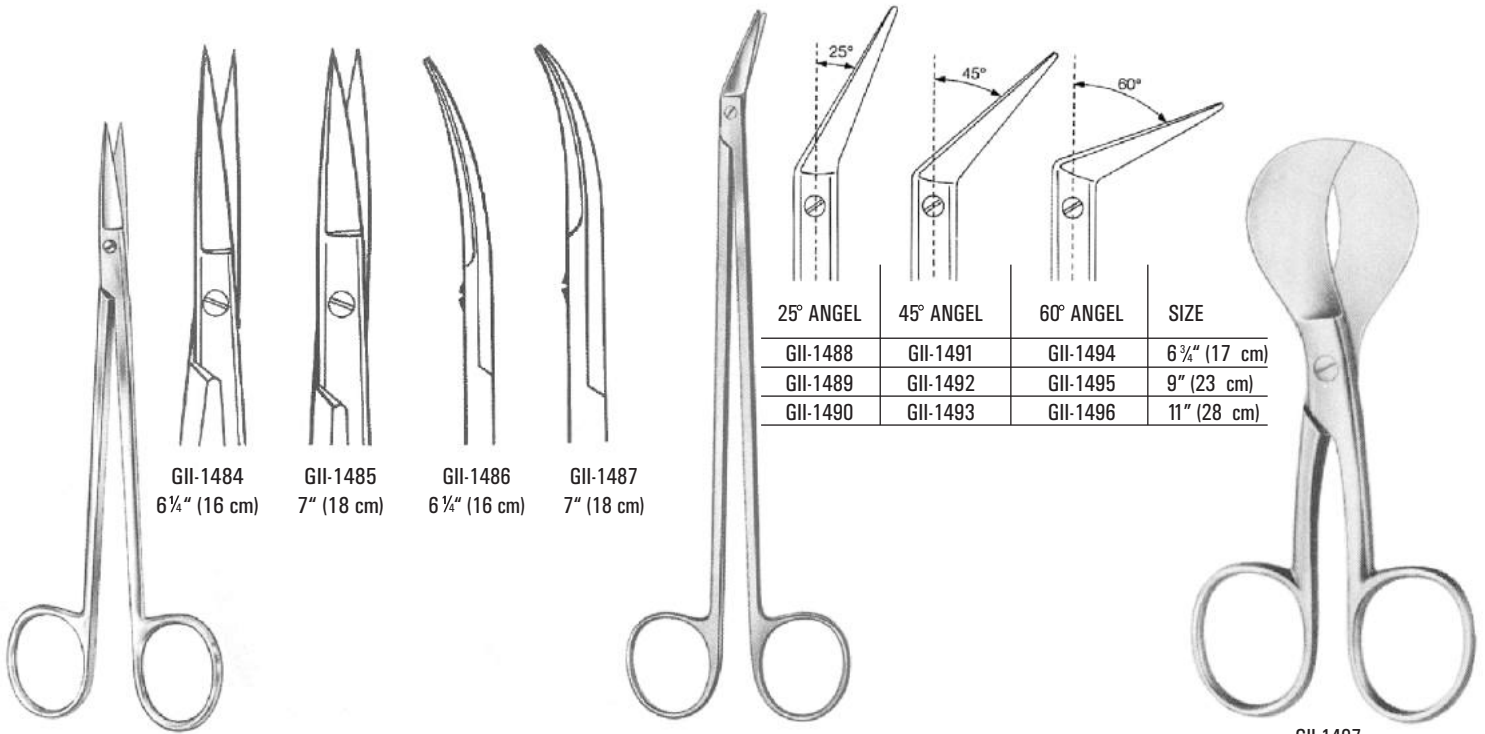

GII-1484 6 1/4" (16 cm)
 GII-1485 7" (18 cm)
 GII-1486 6 1/4" (16 cm)
 GII-1487 7" (18 cm)

25° ANGEL	45° ANGEL	60° ANGEL	SIZE
GII-1488	GII-1491	GII-1494	6 3/4" (17 cm)
GII-1489	GII-1492	GII-1495	9" (23 cm)
GII-1490	GII-1493	GII-1496	11" (28 cm)

Kelly Scissors

De-Bakey Scissors

GII-1497
 US Umbilical Scissors
 4 1/4" (10,5 cm)

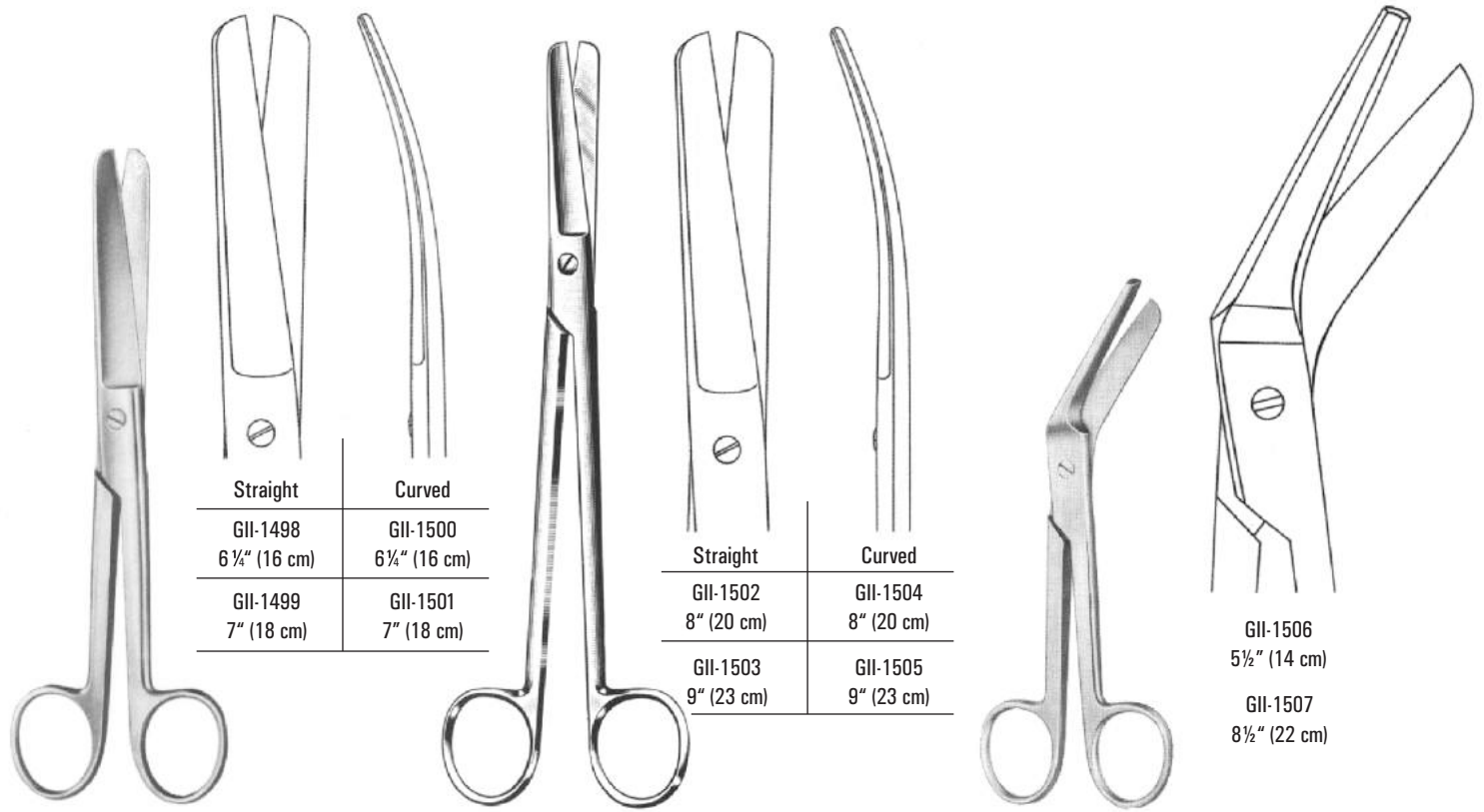

Straight	Curved
GII-1498 6 1/2" (16 cm)	GII-1500 6 1/4" (16 cm)
GII-1499 7" (18 cm)	GII-1501 7" (18 cm)

Straight	Curved
GII-1502 8" (20 cm)	GII-1504 8" (20 cm)
GII-1503 9" (23 cm)	GII-1505 9" (23 cm)

GII-1506
 5 1/2" (14 cm)
 GII-1507
 8 1/2" (22 cm)

Doyen
 Abdominal Scissors

Parametrium Scissors

Braun-Stadler Scissors

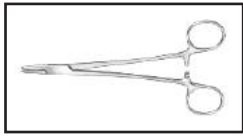

NEEDLE HOLDER



GII-06S-001
4 3/4" (12 cm)



GII-1508
5" (12.5 cm)

Derf Needle Holder
GII-250



GII-1509
Collier Needle Holder
5" (12.5 cm)



GII-252
Webster Needle Holder
5" (13 cm)



GII-252f
Halsey Needle Holder
5" (13 cm)



GII-1510
Neivert Needle Holder
5" (13 cm)



GII-1511
Hegar-Baumgartner Needle Holder
5 1/2" (14 cm)



ARTICLE #	SIZE
GII-06S-008	5" (12.5 cm)
GII-06S-009	7" 18 cm)

Brown Needle Holder
GII-1512



NEEDLE HOLDER

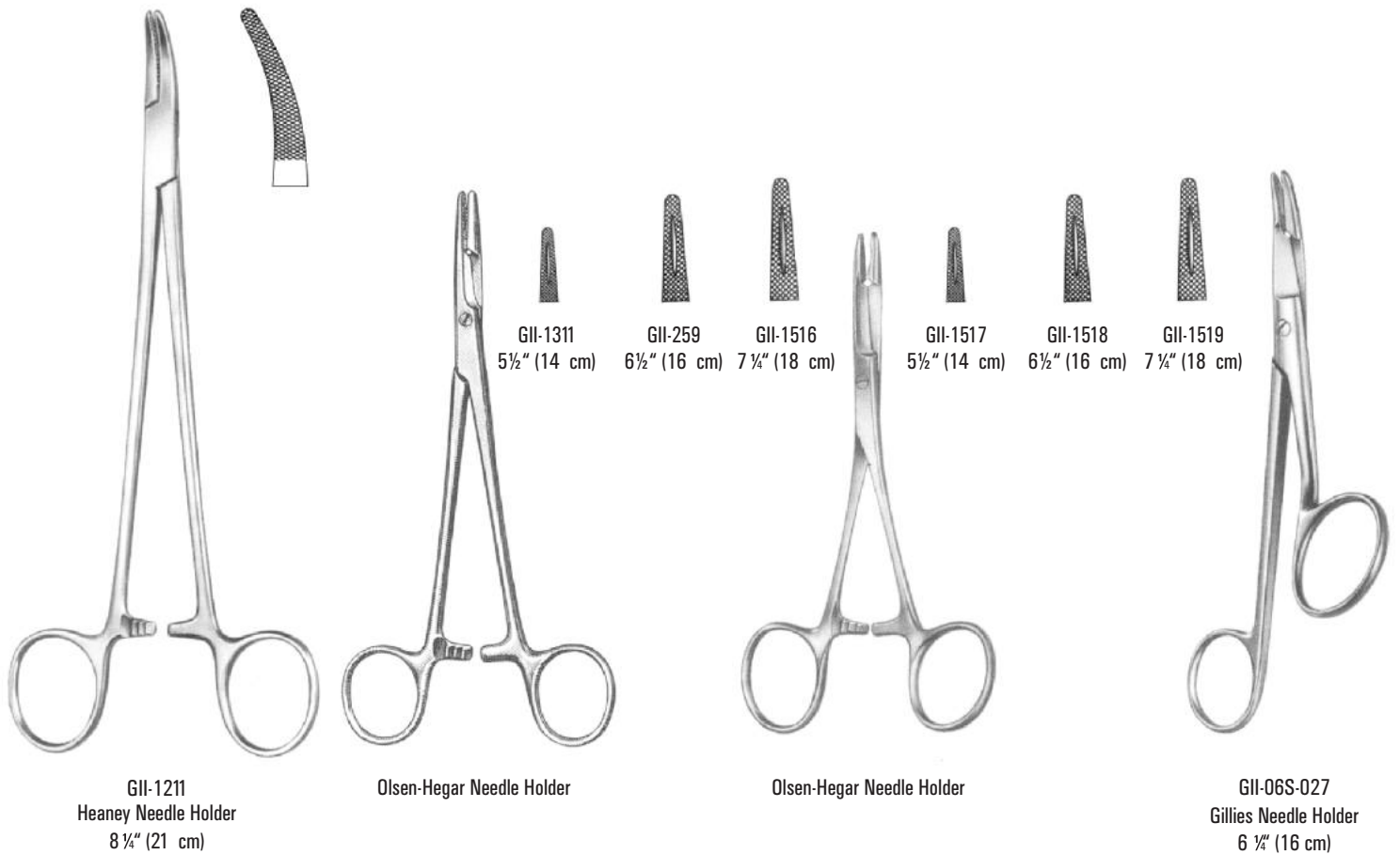
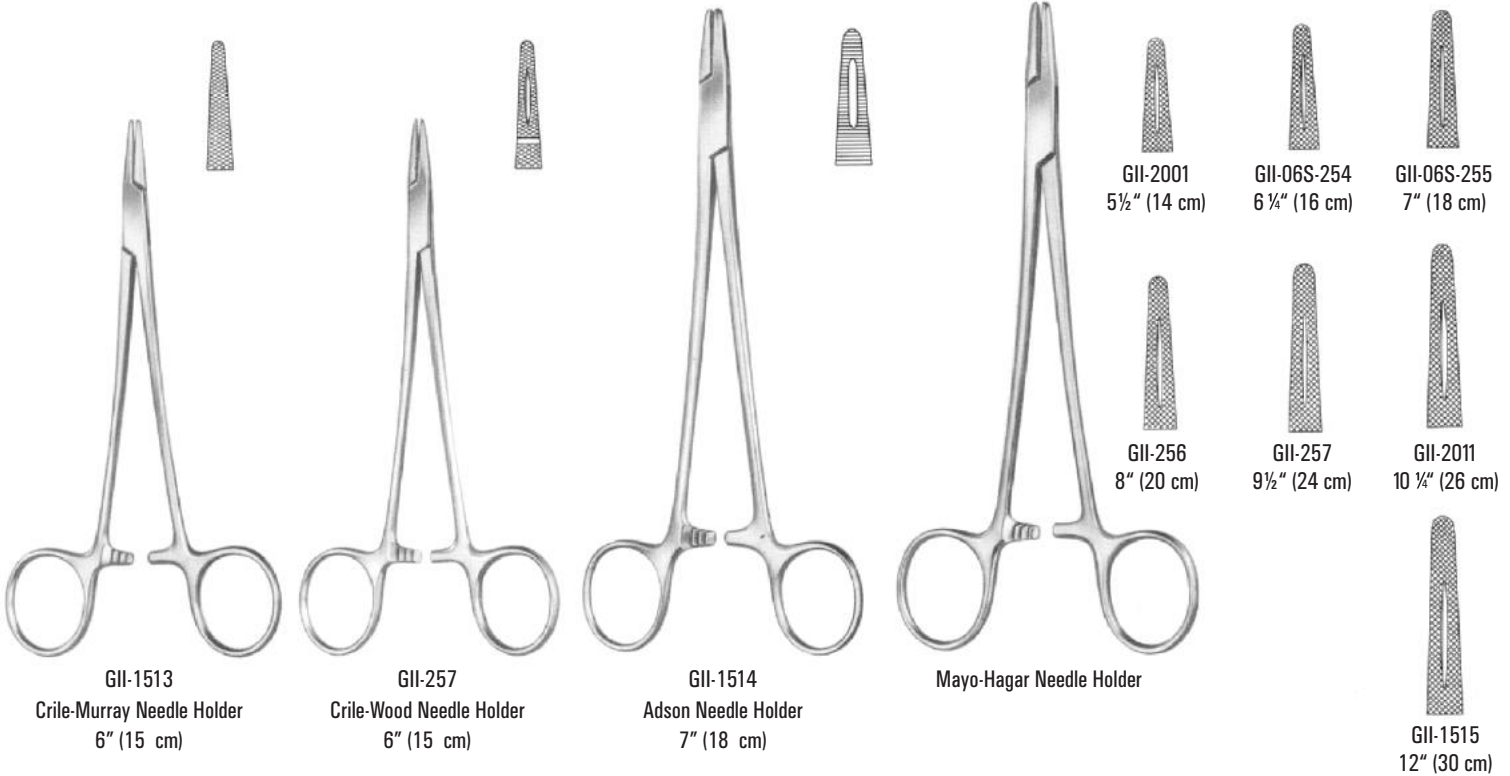
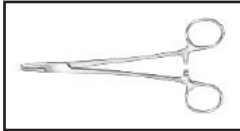

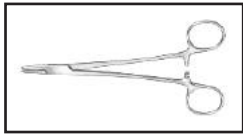

NEEDLE HOLDER



GII-1520
Crile Needle Holder
6" (15 cm)



Mathieu Needle Holder



GII-955
5½" (14 cm)



GII-1521
6¾" (17 cm)



GII-1522
8" (20 cm)



Mathieu Needle Holder

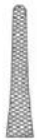

GII-1523
5½" (14 cm)



GII-1524
6¾" (17 cm)



GII-1525
Toennis Needle Holder
7" (18 cm)

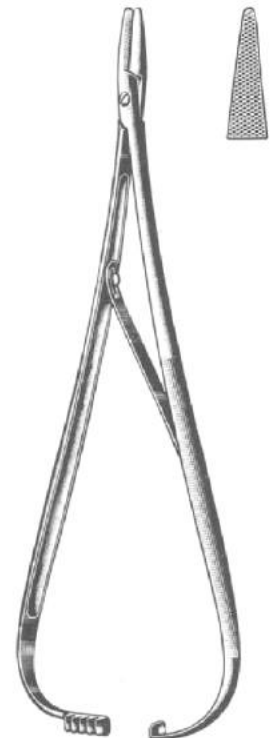

GII-1526
Lichtenberg Needle Holder
8" (20 cm)



DRESSING & TISSUE FORCEPS



SERRATED

1X2 TEETH

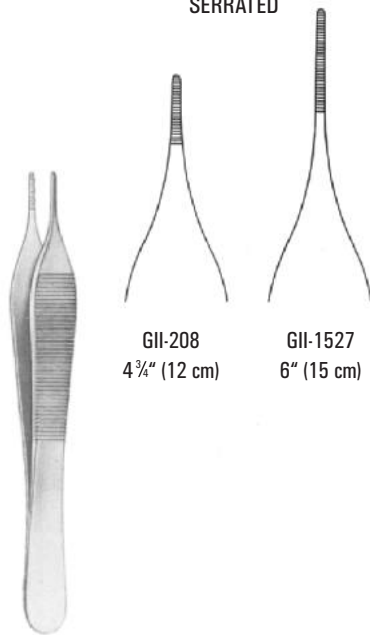

GII-208
4 3/4" (12 cm)

GII-1527
6" (15 cm)

GII-209
4 3/4" (12 cm)

GII-1528
6" (15 cm)

Adson Forceps



GII-1356
Adson-Brown Forceps
4 3/4" (12 cm)



GII-208f
Adson Forceps
Serrated
4 3/4" (12 cm)

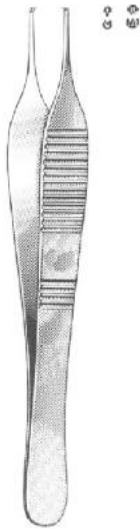

GII-209f
Adson Forceps
1X2 TEETH
4 3/4" (12 cm)

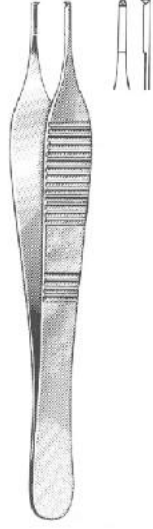

GII-2208
Adson Forceps
1X2 TEETH
WITH TYING PLATFORM
4 3/4" (12 cm)



GII-2209
Adson Brown Forceps
4 3/4" (12 cm)

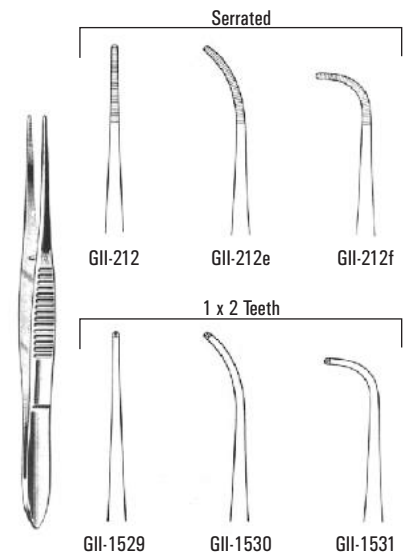

Splinter Forceps
4 1/2" (11.5 cm)

GII-212

GII-212e

GII-212f

GII-1529

GII-1530

GII-1531



DRESSING & TISSUE FORCEPS



Dressing Forceps

GII-194 4½" (11.5 cm)	GII-195 5" (13 cm)	GII-196 5½" (14.5 cm)	GII-197 6¼" (16 cm)	GII-05S-020 7" (18 cm)	GII-05S-021 8" (20 cm)	GII-1204 10" (25 cm)	GII-2010 12" (30 cm)



Tissue Forceps

GII-1532 4¾" (11 cm)	GII-1533 4½" (11.5 cm)	GII-199 5" (13 cm)	GII-203 5½" (14.5 cm)	GII-198 6¼" (16 cm)	GII-1534 7" (18 cm)	GII-1535 8" (20 cm)	GII-1536 10" (25 cm)	GII-1537 12" (30 cm)



DRESSING & TISSUE FORCEPS



McIndoe Forceps



GII-1538
6" (15 cm)



Gillies Dressing Forceps



GII-1539
6" (15 cm)

Serrated



Semken Dressing & Tissue Forceps



GII-1540
5" (12.5 cm)

Serrated



GII-1541
6" (15.5 cm)



GII-1542
5" (12.5 cm)

1 x 2 Teeth

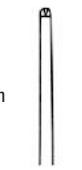

GII-1543
6" (15.5 cm)



Taylor Dressing & Tissue Forceps



GII-1544
7" (17 cm)



GII-1547
7" (17 cm)



Taylor Dressing & Tissue Forceps



GII-1545
7" (18.5 cm)



GII-1546
7" (18.5 cm)



Gerald Dressing & Tissue Forceps



Serrated

GII-1548
7" (18 cm)



GII-1549
7" (18 cm)



1 x 2 Teeth

GII-1550
7" (18 cm)



GII-1551
7" (18 cm)



Cushing Dressing & Tissue Forceps



Serrated

GII-1552
7" (17.5 cm)



GII-1553
7" (17.5 cm)



1 x 2 Teeth

GII-1554
7" (17.5 cm)



Potts-Smith Dressing & Tissue Forceps



Serrated

GII-1555
7" (18 cm)



1 x 2 Teeth

GII-1558
7" (18 cm)

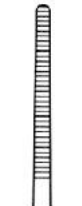

GII-1556
8 1/4" (21 cm)



GII-1559
8 1/4" (21 cm)

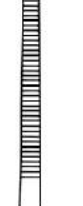

GII-1557
10" (25 cm)



GII-1560
10" (25 cm)



DRESSING & TISSUE FORCEPS



GII-1561
5½" (14.5 cm)

GII-1562
6¼" (16 cm)

GII-1563
8" (20 cm)

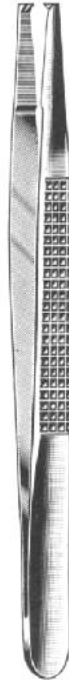

GII-1564
7" (18 cm)



GII-1565
6" (15 cm)



GII-1566
6" (15 cm)

Durante Tissue Forceps

Stone Tissue Forceps

Lerche Tissue Forceps

Bonney Tissue Forceps

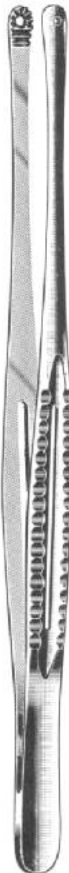

GII-1567
9" (23 cm)



GII-1568
9" (23 cm)



GII-1569
6" (15 cm)

GII-1570
8" (20 cm)

GII-05S-066
10" (25 cm)



GII-1571
5½" (14.5 cm)



GII-1572
8" (20 cm)

Mayo-Russ.
Tissue Forceps

Singley-Tuttle
Tissue Forceps

Russ. Modell
Tissue Forceps

Duval
Tissue Forceps

Collin-Duval
Grasping Forceps



DRESSING & TISSUE FORCEPS



GII-1573
Carhalt Splinter Forceps
4 1/4" (11 cm)



GII-1574
Carhalt Splinter Forceps
4 1/4" (11 cm)



Walter Splinter Forceps



GII-1575
4 1/2" (11.5 cm)



GII-1576
4 1/2" (11.5 cm)



GII-1577
Feilchenfeld
Splinter Forceps 3" (8 cm)



GII-1578
Splinter Forceps
with Magnify Glass
3" (8 cm)



GII-1579
Physicians Splinter Forceps
5" (12.5 cm)



Williams Splinter Forceps



GII-1580
6" (15 cm)



GII-1581
6" (15 cm)

GII-1582
5 1/2" (14 cm)



Virtus Splinter



GII-1583
5 1/2"

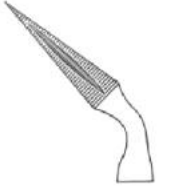

GII-1584
5 1/2"

Swiss Jeweler Forceps



GII-1585
4 3/4" (12 cm)



GII-1586
4 3/4" (12 cm)



GII-1587
4 3/4" (12 cm)



GII-1588
4 3/4" (12 cm)

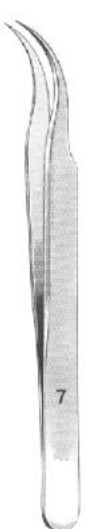

GII-1589
4 3/4" (12 cm)



TOWEL CLAMPS

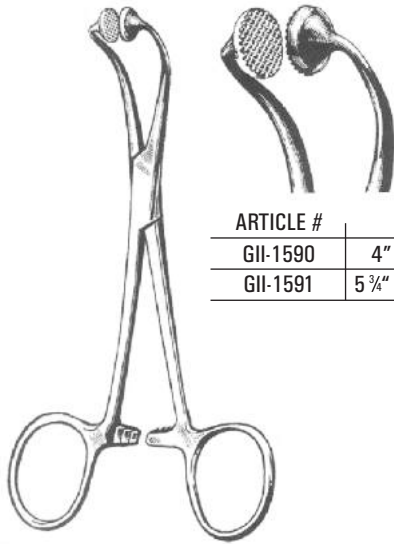
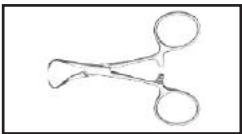

ARTICLE #	SIZE
GII-1590	4" (10 cm)
GII-1591	5 3/4" (14.5 cm)

Hoff Towel Clamp
Stainless Steel



GII-1592
Roeder Towel Clamp
with Ball Stop
5" (13 cm)



GII-1593
Jones Towel Clamp
3 1/2" (9 cm)



GII-1594
Schaedel Towel Clamp
3 1/2" (9 cm)



Ball & Socket Towel Clamp

ARTICLE #	SIZE
GII-1595	3 3/4" (10 cm)
GII-1596	5 1/2" (14 cm)
GII-1597	6" (15 cm)



Lorna Towel Clamp

ARTICLE #	SIZE
GII-1598	4" (10 cm)
GII-1323	5" (13 cm)

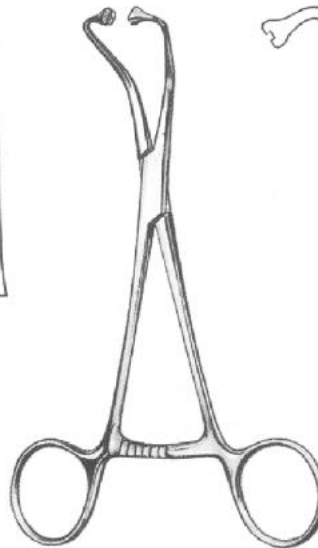

GII-1599
Peers Towel Clamp
5 3/4" (14.5 cm)

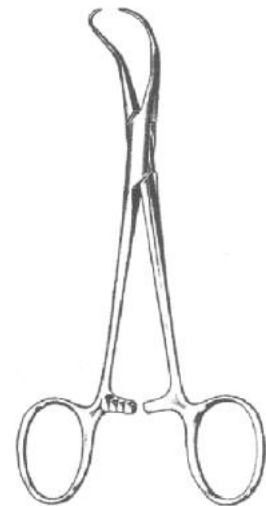

Backhaus Towel Clamp

ARTICLE #	SIZE
GII-184	3.5" (9 cm)
GII-1600	4 1/2" (11 cm)
GII-185	5" (13 cm)
GII-1601	6" (15 cm)



HEMOSTATIC INSTRUMENTS

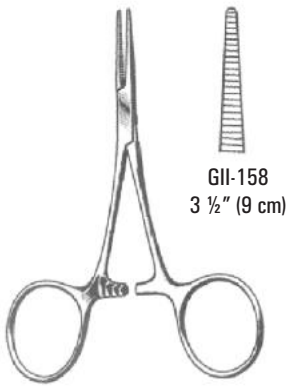
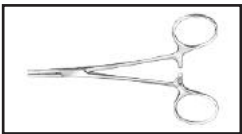

GII-158
3 1/2" (9 cm)



GII-159
3 1/2" (9 cm)

Baby-Mosquito Forceps
(HARTMANN)

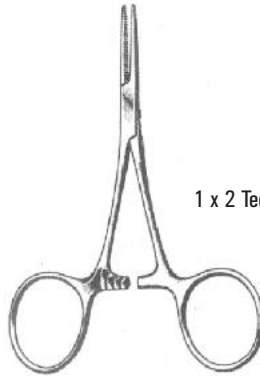

1 x 2 Teeth

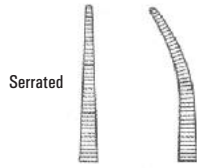

Serrated

GII-1602
3 1/2" (10 cm) GII-1603
3 1/2" (10 cm)

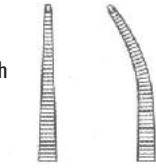

GII-1604
3 1/2" (10 cm) GII-1605
3 1/2" (10 cm)

Micro-Mosquito Forceps

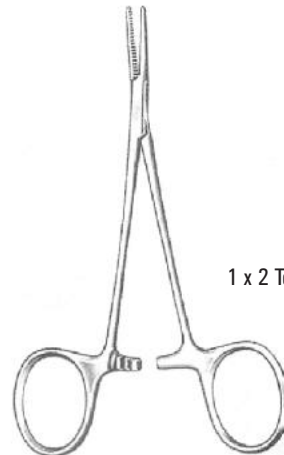

1 x 2 Teeth

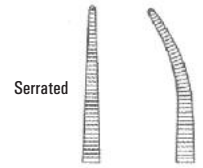

Serrated

GII-160f
5" (12 cm) GII-161f
5" (12 cm)

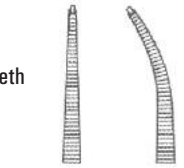

GII-1606
5" (12 cm) GII-1607
5" (12 cm)

Micro-Halstead-Mosquito Forceps

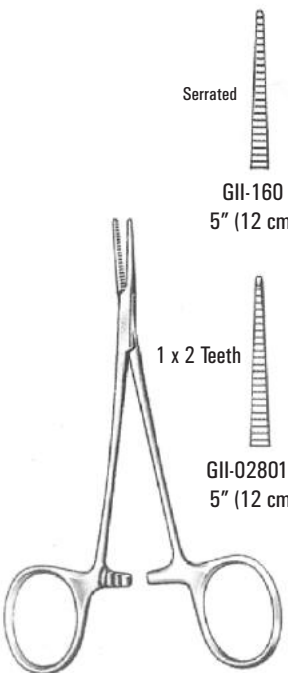

1 x 2 Teeth

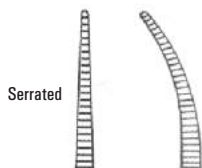

Serrated

GII-160
5" (12 cm) GII-161
5" (12 cm)

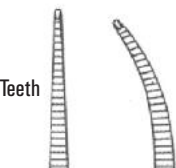

GII-028013
5" (12 cm) GII-02S-014
5" (12 cm)

Halstead-Mosquito Forceps

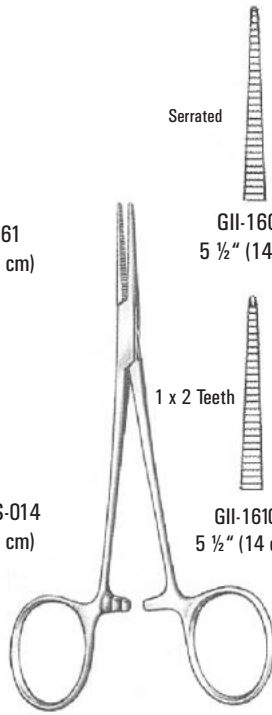

1 x 2 Teeth

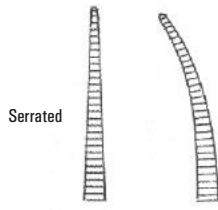

Serrated

GII-1608
5 1/2" (14 cm) GII-1609
5 1/2" (14 cm)

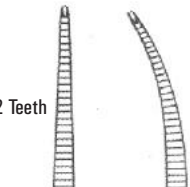

GII-1610
5 1/2" (14 cm) GII-1611
5 1/2" (14 cm)

Halstead-Mosquito Forceps

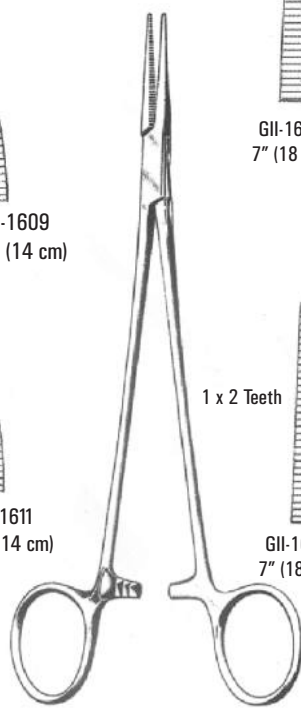

1 x 2 Teeth

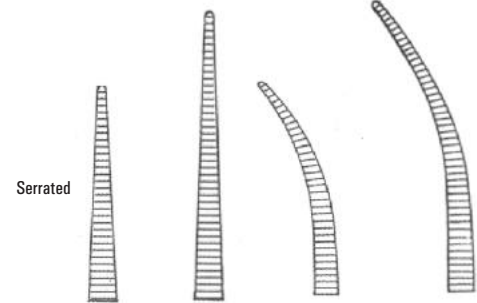

Serrated

GII-1612
7" (18 cm) GII-1613
8" (20 cm) GII-1614
7" (18 cm) GII-1615
8" (20 cm)

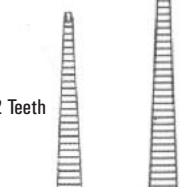

GII-1616
7" (18 cm) GII-1617
8" (20 cm) GII-02S-025
7" (18 cm) GII-1618
8" (20 cm)

Halstead-Mosquito Forceps

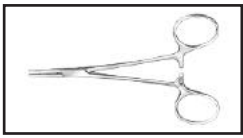

HEMOSTATIC INSTRUMENTS



Kelly Hemostatic Forceps

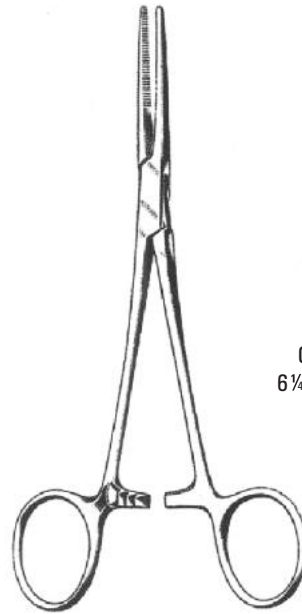

Kelly-Rankin Hemostatic Forceps

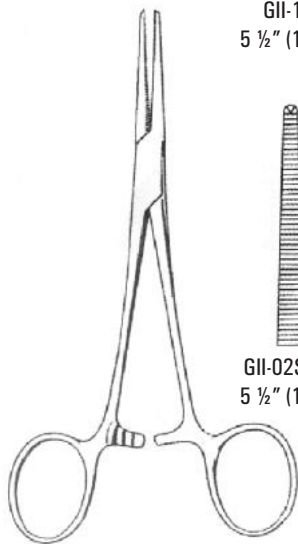
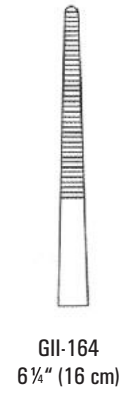

Crile-Hemostatic Forceps

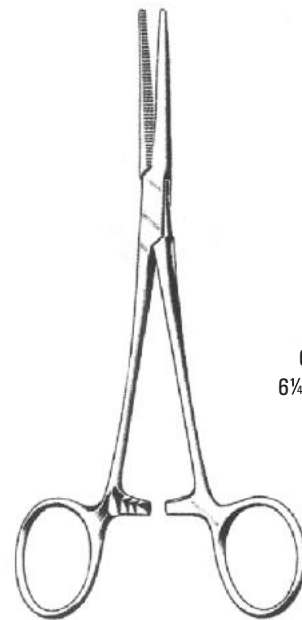
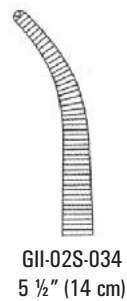
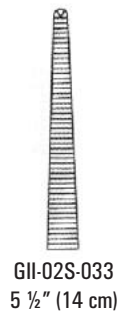
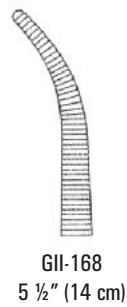
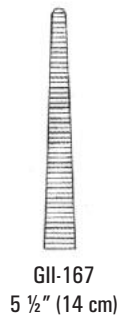

Crile-Rankin Hemostatic Forceps

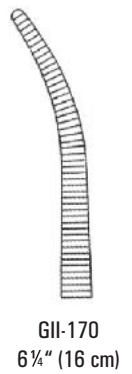
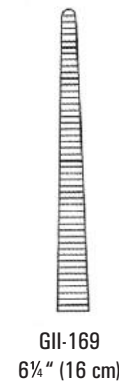



HEMOSTATIC INSTRUMENTS



Kocher Hemostatic Forceps 1 x 2 Teeth

ARTICLE # Straight	Size	ARTICLE # Curved
GII-1619	5 1/2" (14 cm)	GII-02S-045
GII-1620	6 1/2" (16 cm)	GII-02S-046
GII-1621	7" (18 cm)	GII-02S-047
GII-1622	8" (20 cm)	GII-02S-048
GII-1623	8 3/4" (22 cm)	GII-02S-049
GII-1624	9 1/2" (24 cm)	GII-02S-050
GII-1625	10 1/4" (26 cm)	GII-02S-051
GII-162+	12" (30 cm)	GII-02S-052



Rochester Pean Forceps Serrated

ARTICLE # Straight	Size	ARTICLE # Curved
GII-172	6 " (16 cm)	GII-173
GII-174	7 1/4" (18 cm)	GII-175
GII-176	8" (20 cm)	GII-177
GII-618	8 " (22 cm)	GII-619
GII-624	9 1/2" (24 cm)	GII-625
GII-620	10 " (26 cm)	GII-621
GII-622	12 1/4" (30 cm)	GII-622

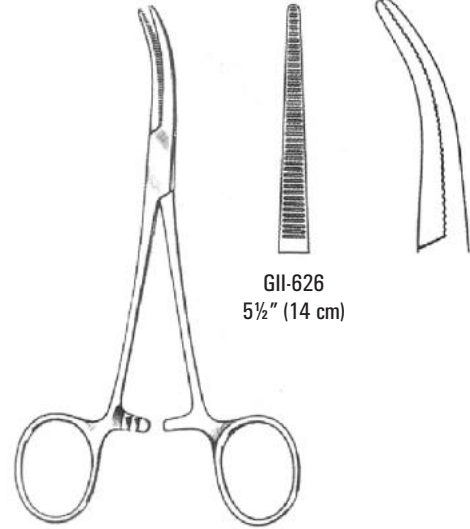

GII-626
5 1/2" (14 cm)

Dandy Hemostatic Forceps

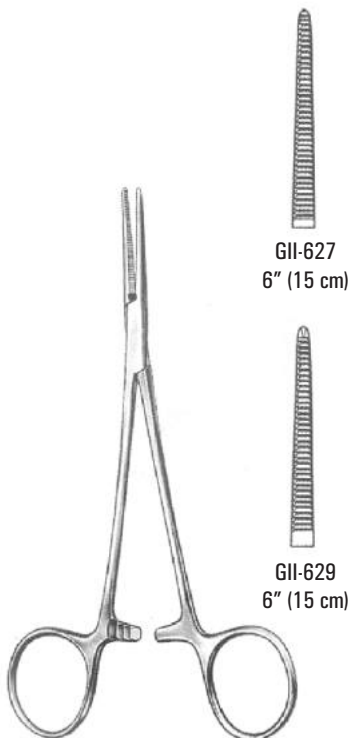

Leriche Hemostatic Forceps

GII-627
6" (15 cm)

GII-629
6" (15 cm)

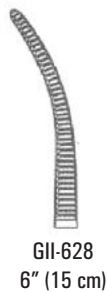

GII-628
6" (15 cm)



GII-630
6" (15 cm)

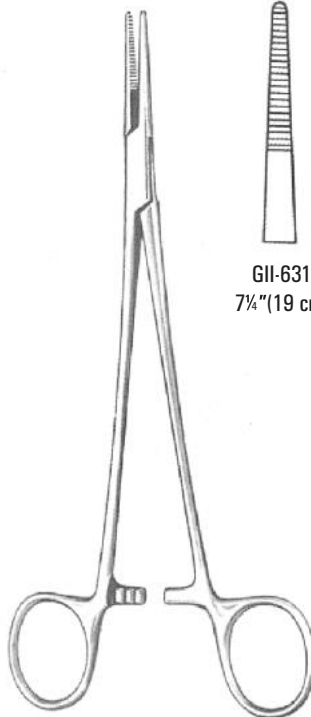

Adson Hemostatic Forceps

GII-631
7 1/4" (19 cm)

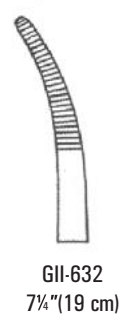

GII-632
7 1/4" (19 cm)

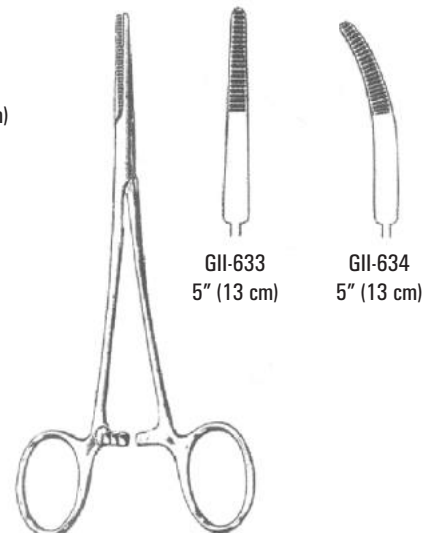

**Providence-Hospital
Hemostatic Forceps**

GII-633
5" (13 cm)

GII-634
5" (13 cm)

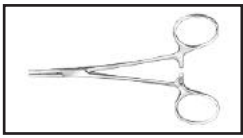

HEMOSTATIC INSTRUMENTS

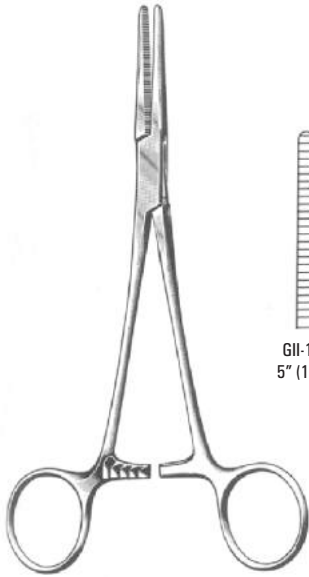

Spencer-Wells Artery Forceps

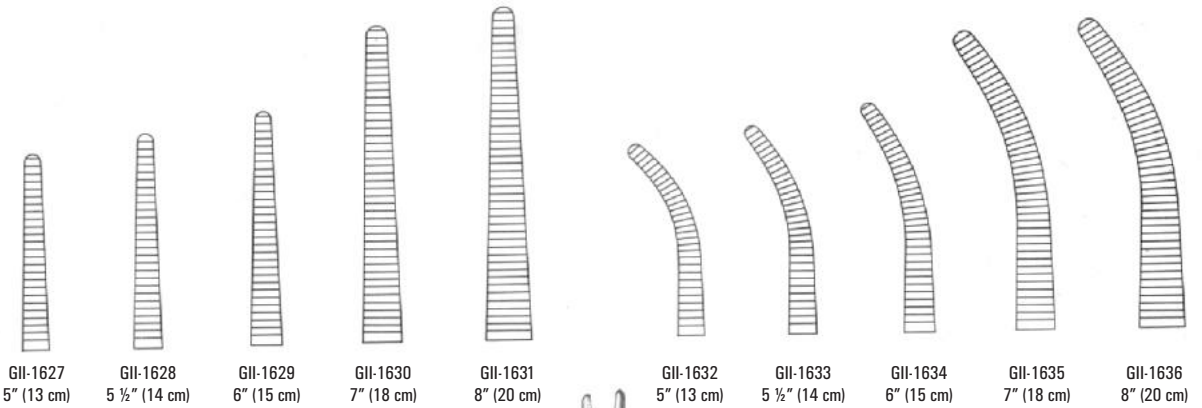

Rochester-Carmalt Forceps

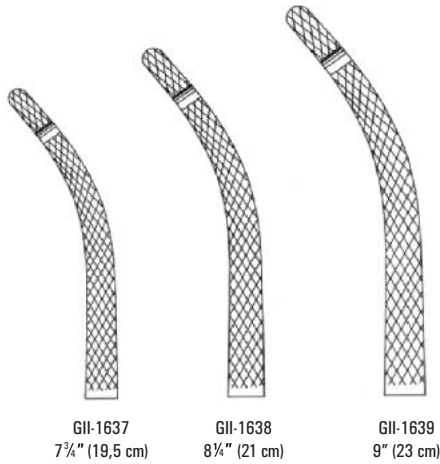
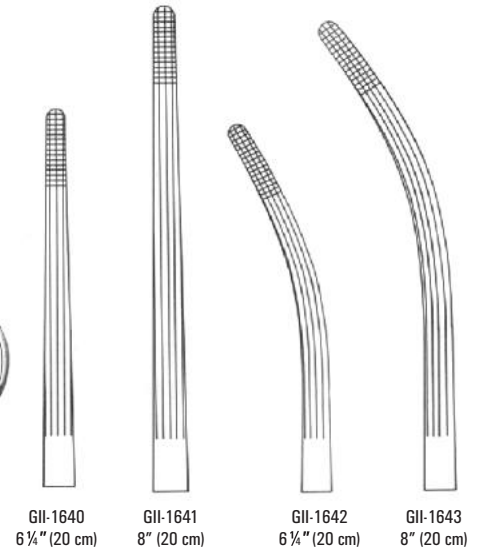

Heaney Hemostatic Forceps

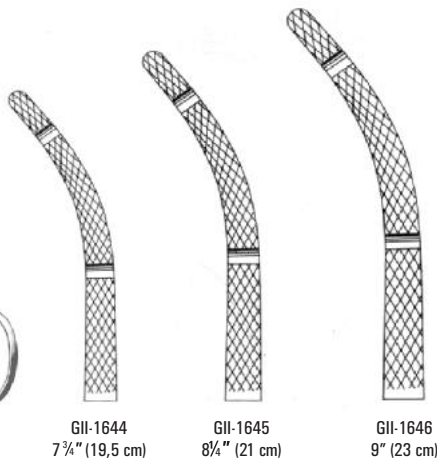

Mixer Artery Forceps

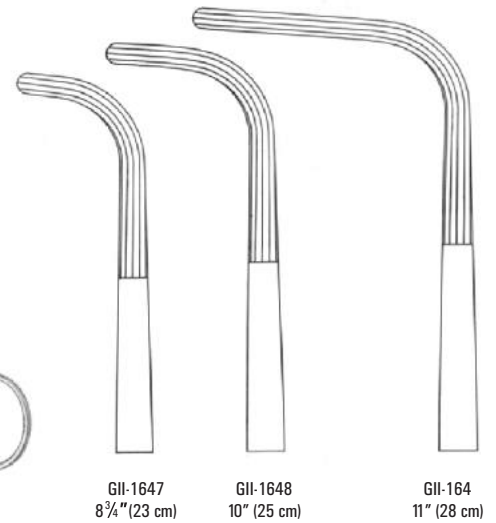



HEMOSTATIC INSTRUMENTS

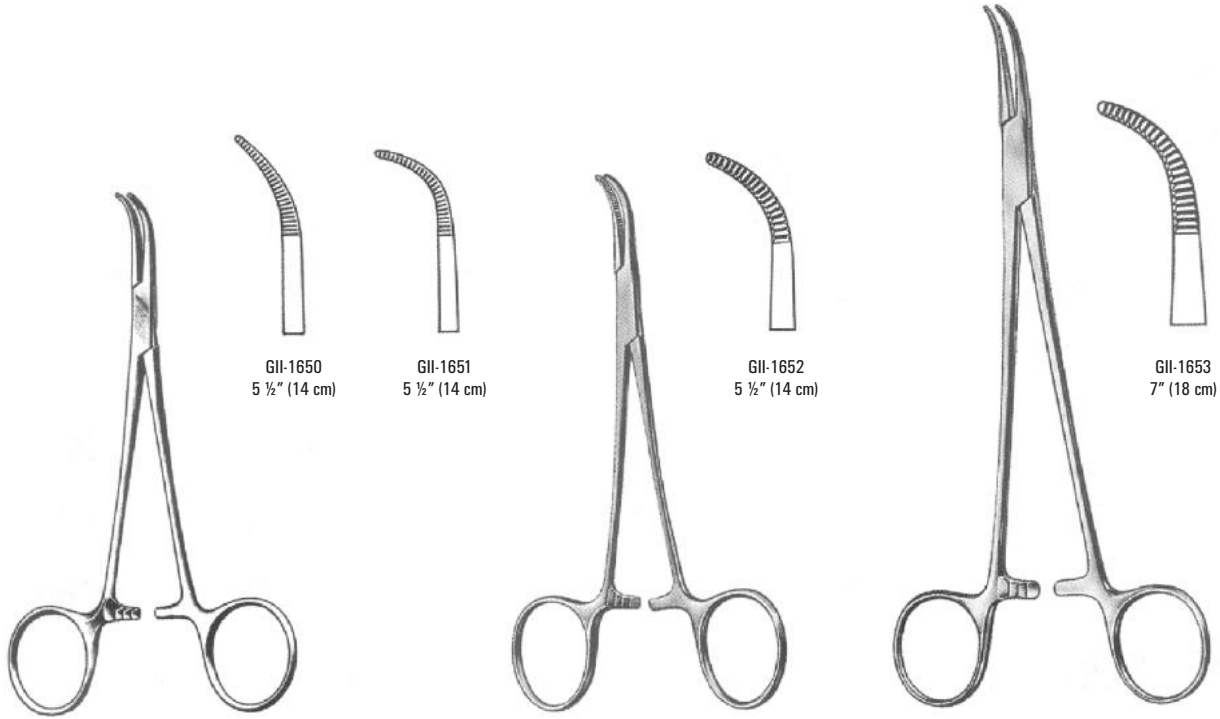

Baby-Mixer Forceps

Baby-Mixer Forceps

Baby-Mixer Forceps

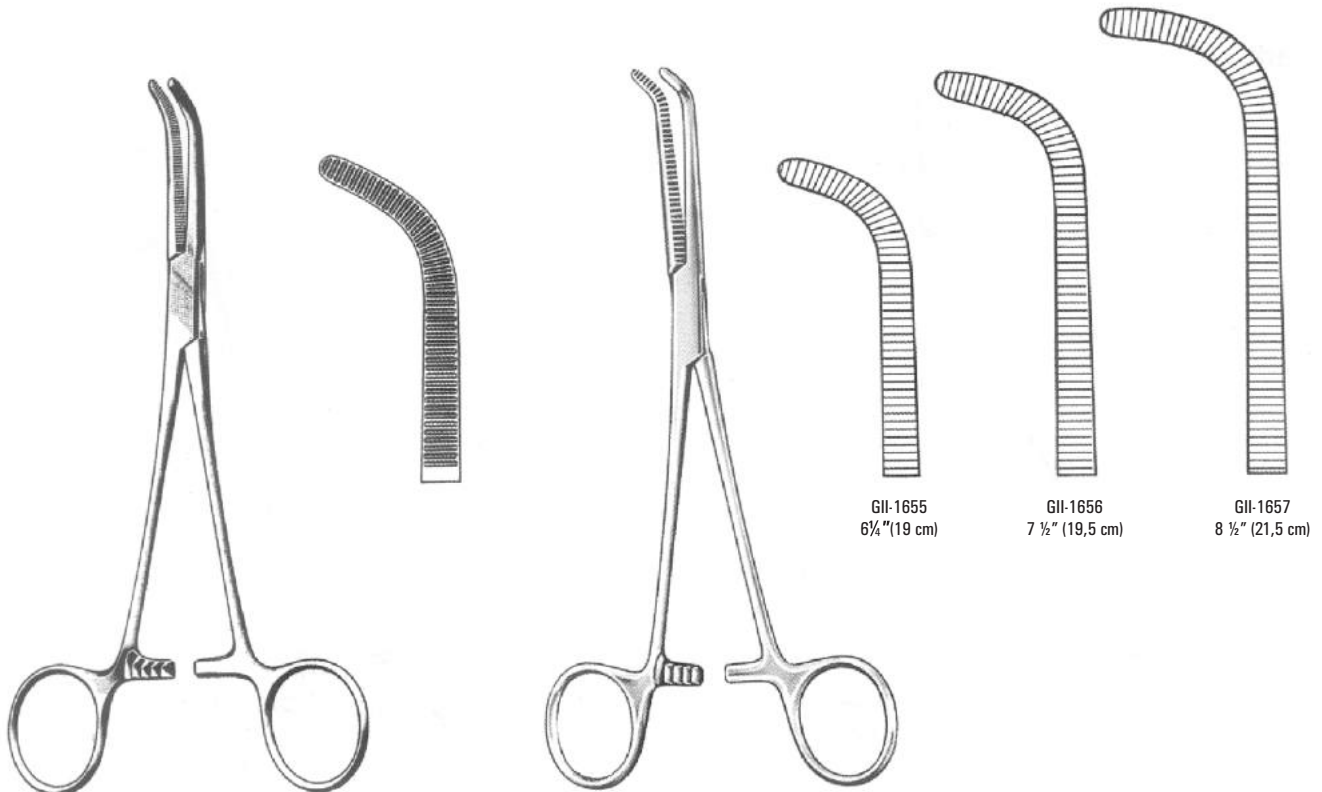

GI-1654
Mixer Oschner Artery Forceps
7 1/2" (19 cm)

Mixer Artery Forceps

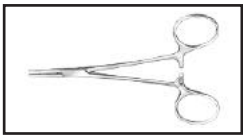

HEMOSTATIC INSTRUMENTS



Gemini Hemostatic Forceps

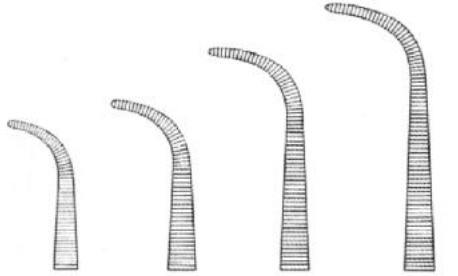

GII-1658 5 1/2" (14 cm)
GII-1659 6 1/4" (16 cm)
GII-1660 7" (18 cm)
GII-1661 8" (20 cm)

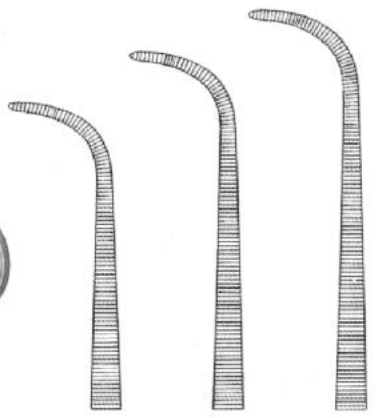

GII-1666 9" (23 cm)
GII-1667 10" (25 cm)
GII-1668 11" (28 cm)

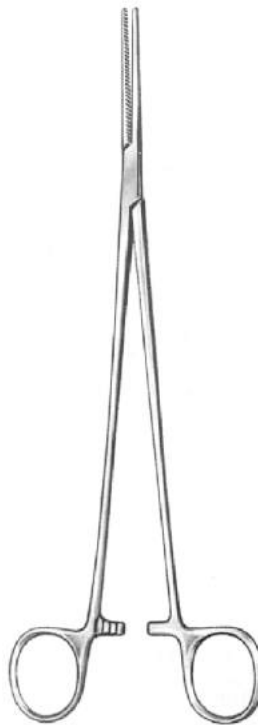

Bangolea Hemostatic Forceps

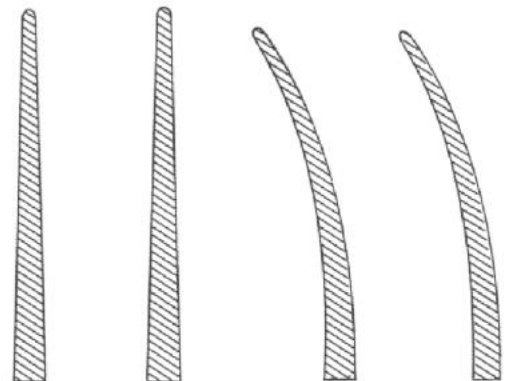

GII-1662 9 1/2" (24 cm)
GII-1663 10 1/4" (26 cm)
GII-1664 9 1/2" (24 cm)
GII-1665 10 1/4" (26 cm)

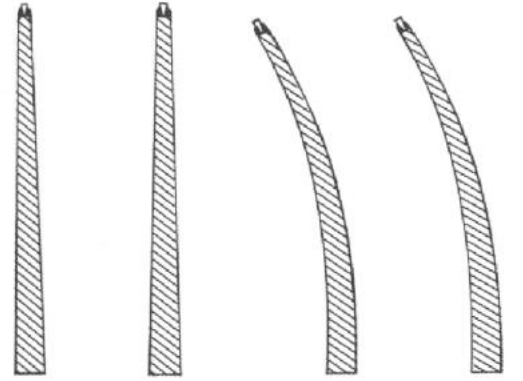

GII-1669 9 1/2" (24 cm)
GII-1670 10 1/4" (26 cm)
GII-1671 9 1/2" (24 cm)
GII-1672 10 1/4" (26 cm)

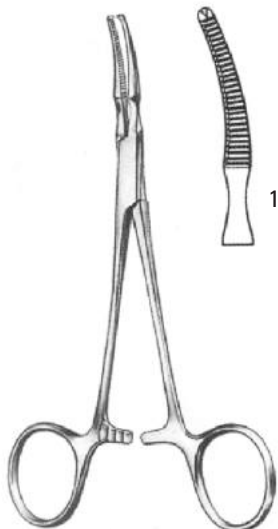

GII-1673
Baby-Mikulicz Peritoneal
Clamp Forceps
5 1/2" (14 cm)



1 x 2 Teeth

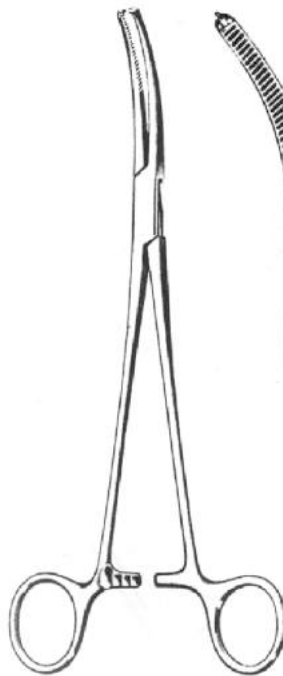

GII-1674
Mikulicz Peritoneal
Clamp Forceps
8" (20,5 cm)



1 x 2 Teeth

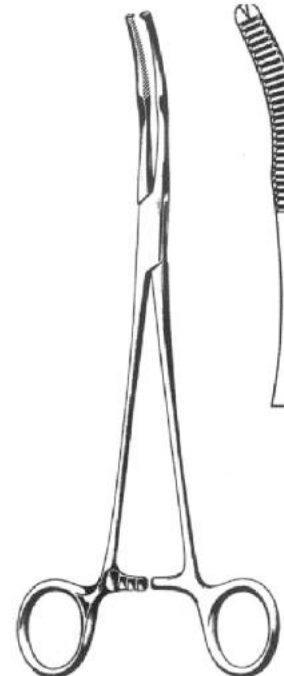

GII-1675
Mikulicz Peritoneal
Clamp Forceps
8 1/2" (21,5 cm)



1 x 2 Teeth



HEMOSTATIC INSTRUMENTS



2x3 Teeth 3x4 Teeth 4x5 Teeth 4x5 Teeth 5x6 Teeth 6x7 Teeth

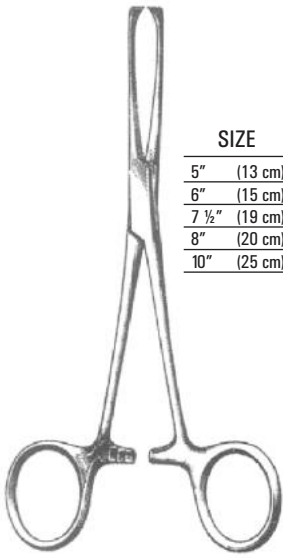

Allis Forceps

SIZE	Allis	Judd-Allis	Baby-Allis	Allis	Allis	Thomas-Allis
5" (13 cm)	GII-1676	GII-1681	GII-1686	GII-1690	GII-1695	GII-1700
6" (15 cm)	GII-1677	GII-1682	GII-218	GII-1691	GII-1696	GII-1701
7 1/2" (19 cm)	GII-1678	GII-1683	GII-1687	GII-1692	GII-1697	GII-1702
8" (20 cm)	GII-1679	GII-1684	GII-1688	GII-1693	GII-1698	GII-1703
10" (25 cm)	GII-1680	GII-1685	GII-1689	GII-1694	GII-1699	GII-1704



ARTICLE #	SIZE
GII-1705	5.5" (14,5 cm)
GII-1706	6.5" (16 cm)
GII-1707	7" (18 cm)
GII-1708	8.5" (21 cm)
GII-1709	9.5" (24 cm)

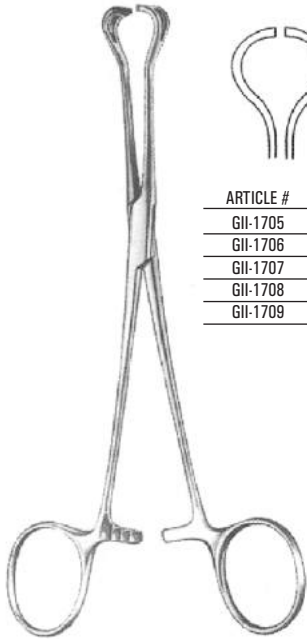

Babcock Forceps



Duval Forceps



ARTICLE #	A (mm)	SIZE
GII-1710	14 mm	8" (20 cm)
GII-1711	18 mm	8" (20 cm)
GII-1712	28 mm	8" (20 cm)
GII-1713	14 mm	9" (23 cm)
GII-1714	18 mm	9" (23 cm)
GII-1715	28 mm	9" (23 cm)



GII-888
6" (15,5 cm)

GII-889
8" (20 cm)

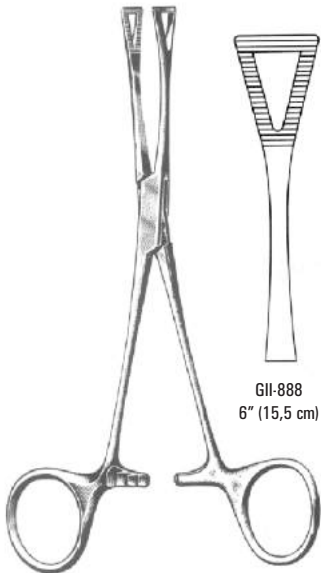

Pennington Forceps

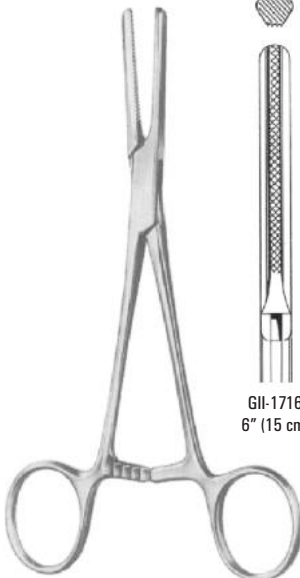

Tube Occluding Forceps



GII-1716
6" (15 cm)



GII-1717
7" (18 cm)

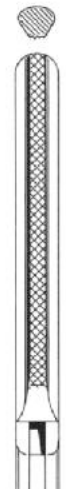

GII-1718
8" (20 cm)

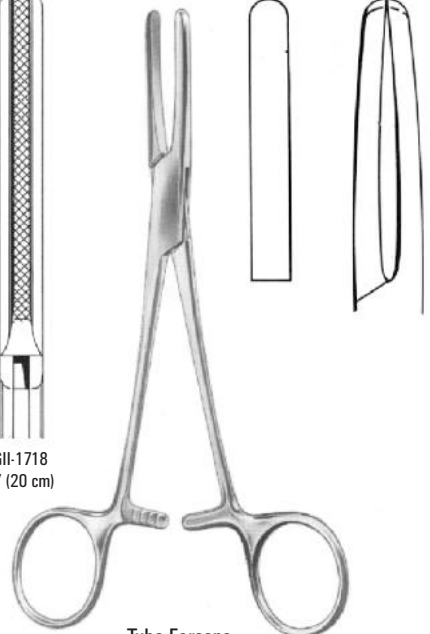

Tube Forceps

ARTICLE #	SIZE
GII-261	5 1/2" (14 cm)
GII-262	6 1/2" (16,5 cm)
GII-263	7 1/4" (18 cm)

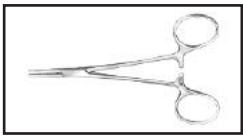

HEMOSTATIC INSTRUMENTS

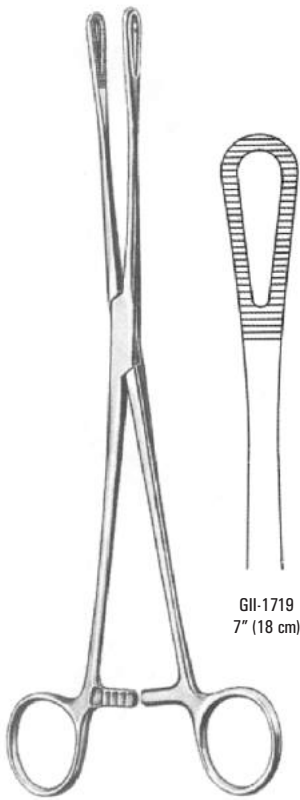

GII-1719
7" (18 cm)

Rampley Sponge Forceps



GII-1720
10" (25 cm)

Gross-Maier Dressing Forceps

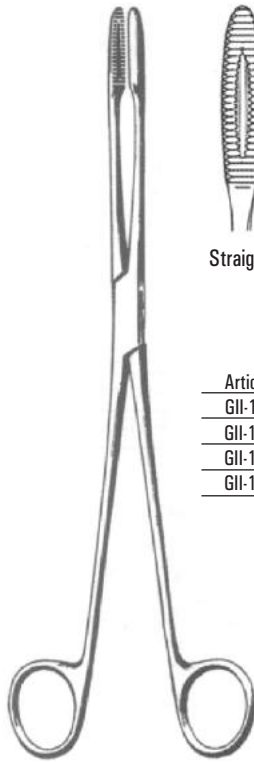

Straight



Curved

Article #	Size
GII-1721	8" (20 cm)
GII-1722	9" (23 cm)
GII-1723	10" (25 cm)
GII-1724	10 1/2" (27 cm)

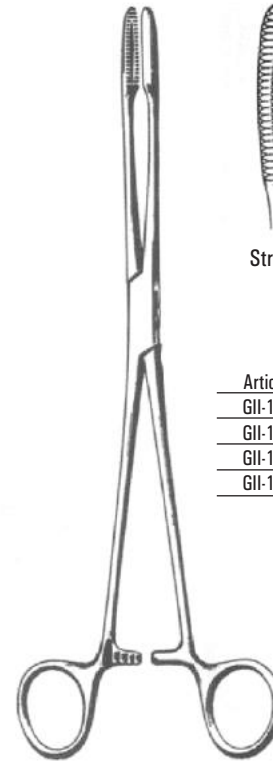

Straight

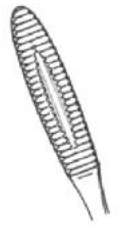

Curved

Article #	Size
GII-1725	8" (20 cm)
GII-1726	9" (23 cm)
GII-1727	10" (25 cm)
GII-1728	10 1/2" (27 cm)

Gross-Maier Dressing Forceps

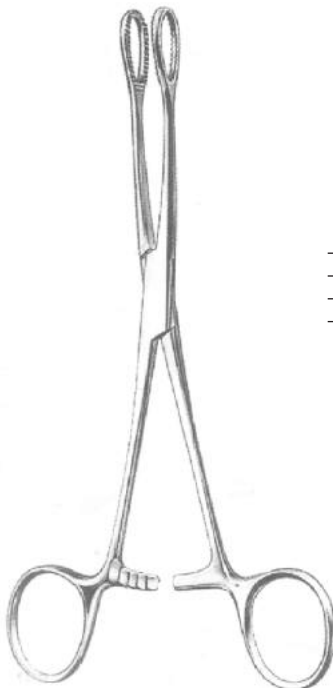

Foerster Sponge Forceps

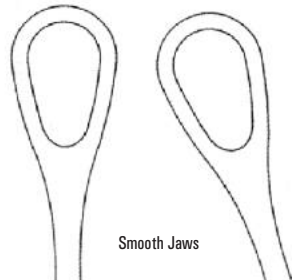

Smooth Jaws

Article #	Size	Article #	Size
GII-1729	7" (18 cm)	GII-1732	7" (18 cm)
GII-1730	8" (20 cm)	GII-1733	8" (20 cm)
GII-1731	10" (25 cm)	GII-1734	10" (25 cm)

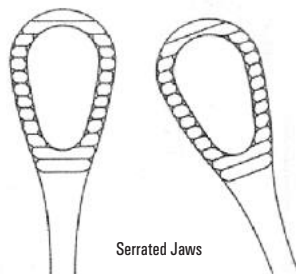

Serrated Jaws

Article #	Size	Article #	Size
GII-189	7" (18 cm)	GII-189c	7" (18 cm)
GII-1735	8" (20 cm)	GII-1736c	8" (20 cm)
GII-191	10" (25 cm)	GII-192	10" (25 cm)

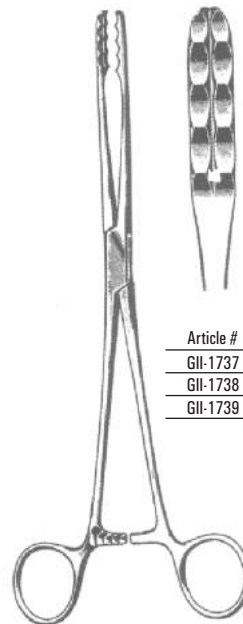

Ulrich Cotton Swab Forceps

Article #	Size
GII-1737	9" (23 cm)
GII-1738	10" (25 cm)
GII-1739	10 1/2" (27 cm)

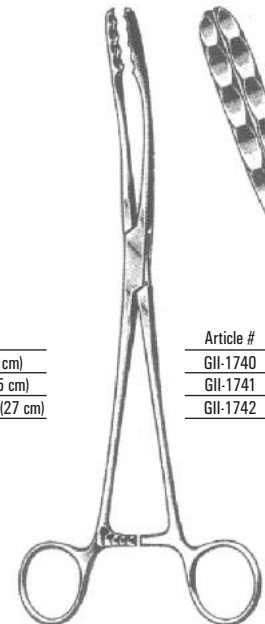

Ulrich Cotton Swab Forceps

Article #	Size
GII-1740	9" (23 cm)
GII-1741	10" (25 cm)
GII-1742	10 1/2" (27 cm)



01S

DIAGNOSTIC INSTRUMENTS



Box of 100 Pcs

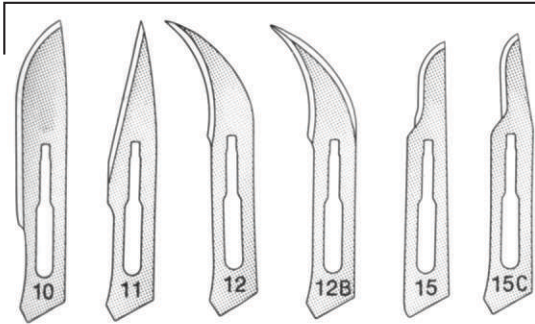

(Fits handles # 3, 3L, 3LA, 7, 9,)

GII-1748 GII-1749 GII-1750 GII-1751 GII-1752 GII-1753

Carbon Steel Sterile Surgical Blades

Box of 100 Pcs

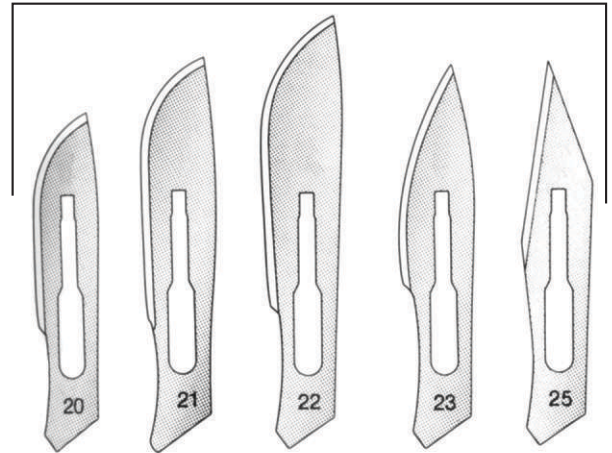

(Fits handles # 4, 4L,)

GII-1754 GII-1755 GII-1756 GII-1757 GII-1758

Carbon Steel Sterile Surgical Blades

Scalpel Handles

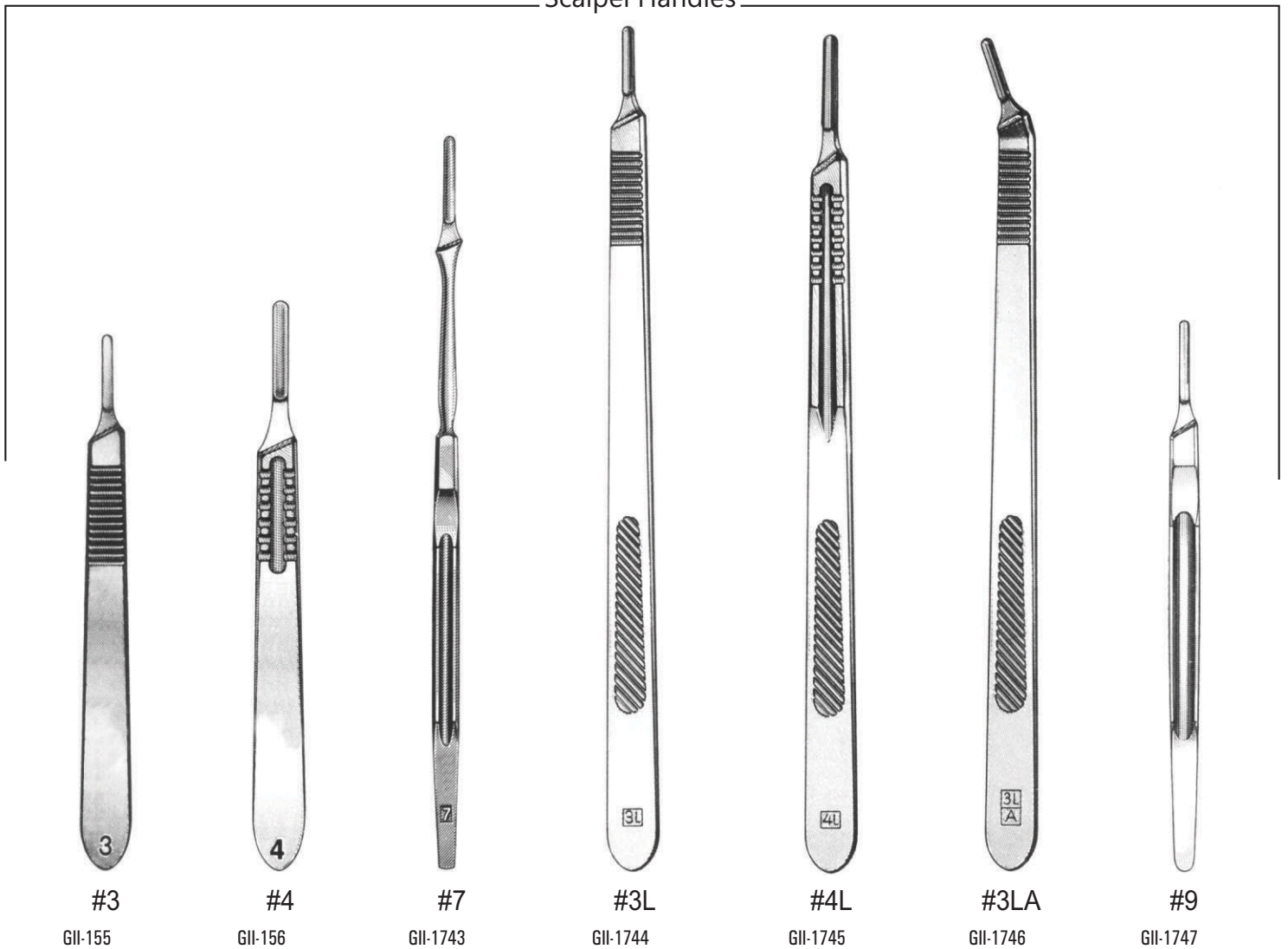

#3

GII-155

#4

GII-156

#7

GII-1743

#3L

GII-1744

#4L

GII-1745

#3LA

GII-1746

#9

GII-1747



DIAGNOSTIC INSTRUMENTS

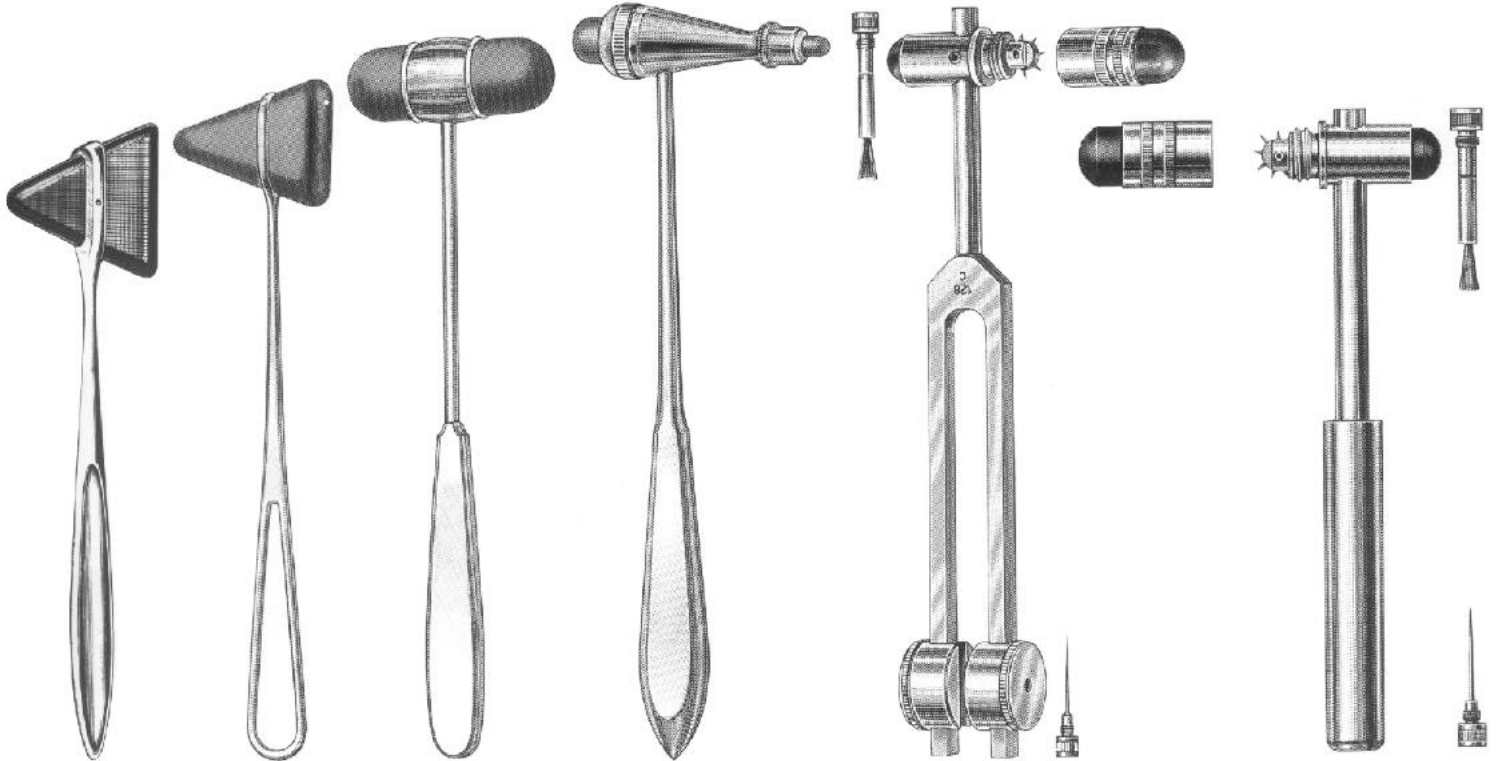

GII-01S-019
Taylor Percussion Hammer
7 1/2" (19 cm)

GII-01S-020
Taylor Percussion Hammer
9" (22 cm)

GII-01S-021
Dejerine Percussion Hammer
9 1/2" (24 cm)

GII-01S-022
Tromner Percussion Hammer
9 3/4" (24,5 cm)

GII-01S-023
Combo-5 Neuro Diagnostic Set
C-128 Tuning Fork, Buck Hammer,
Pin Wheel, Brush & Needle

GII-01S-024
Combo-4 Neuro Diagnostic Set
Buck Hammer,
Pin Wheel, Brush & Needle

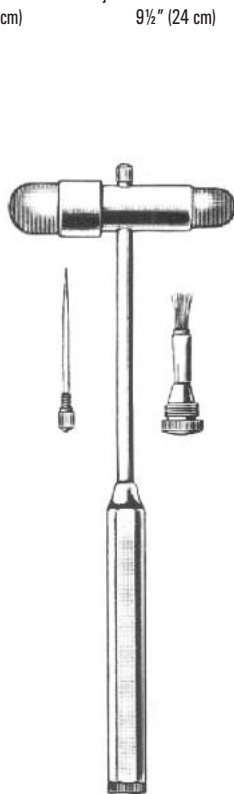

GII-01S-025
Buck Neurological Hammer with Brush
and Needle (screw into handle) chrome
7 3/4" (19,7 cm)

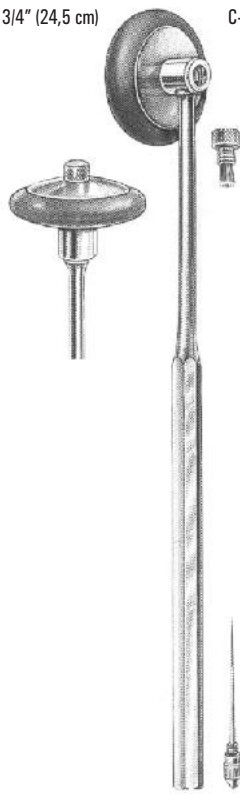

GII-01S-026
Rabiner Neurological Hammer with Brush
and Needle (screw into handle) chrome
9" (22,9 cm)



GII-01S-027
Wartenberg Neurological Pin Wheel
7" (17, 8 cm)



DIAGNOSTIC INSTRUMENTS



Probes, Double End

ARTICLE #	SIZE
GII-1111	4 1/2" (11,4 cm)
GII-1112	5" (12,7 cm)
GII-1113	5 1/2" (14 cm)
GII-1114	6" (15,2 cm)
GII-1115	7" (17,8 cm)
GII-1116	8" (20,3 cm)
GII-1117	10" (25,4 cm)



Probes, With Eye

ARTICLE #	SIZE
GII-1118	4 1/2" (11,4 cm)
GII-1119	5" (12,7 cm)
GII-1120	5 1/2" (14 cm)
GII-1121	6" (15,2 cm)
GII-1122	7" (17,8 cm)
GII-1123	8" (20,3 cm)
GII-1124	10" (25,4 cm)



GII-01S-042
Probe with Myrtle Leaf
5" (12,7 cm)



Grooved Directors With Tongue Tie

ARTICLE #	SIZE
GII-1125	4 1/2" (11,4 cm)
GII-1126	5" (12,7 cm)
GII-1127	5 1/2" (14 cm)
GII-1128	6" (15,2 cm)
GII-1129	8" (20,3 cm)



Grooved Directors With Probe Tip
& Tongue Tie

ARTICLE #	SIZE
GII-1130	4 1/2" (11,4 cm)
GII-1131	5" (12,7 cm)
GII-1132	5 1/2" (14 cm)
GII-1133	6" (15,2 cm)
GII-1134	8" (20,3 cm)



GII-01S-053
Larry Probe and Grooved Director
7" (17,8 cm)



GII-1135
Pinard Fetal Head Stethoscope (Aluminum)

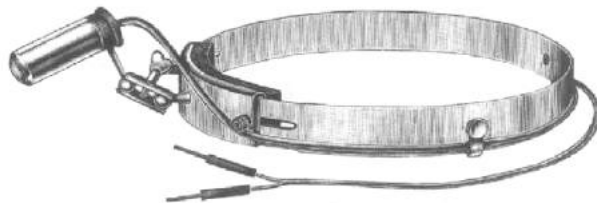

GII-1136
Head Light



GII-1137
Mirror Head



E.N.T INSTRUMENTS

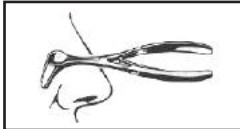

Hartmann-Halle Nasal Speculum
5½" (14 cm)

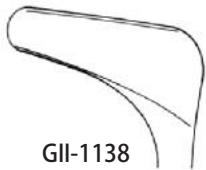

GII-1138

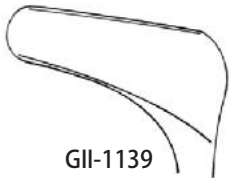

GII-1139

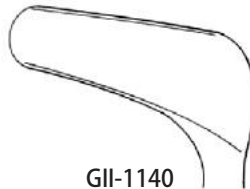

GII-1140



Hartmann Nasal Speculum
5½" (14 cm)

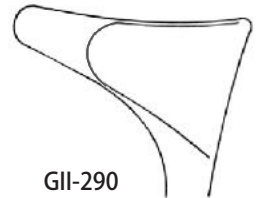

GII-290

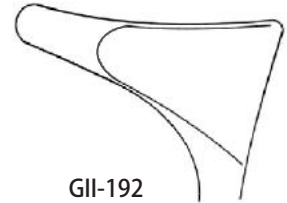

GII-192

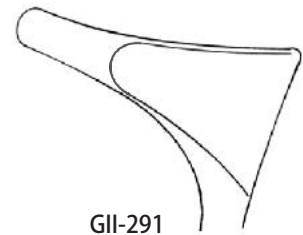

GII-291



Tieck-Halle Nasal Speculum
5¼" (13.5cm)



GII-1141



GII-1142



GII-1143
Beckmann Nasal Speculum
5" (13 cm)



Beckmann Nasal Speculum
5½" (14 cm)



GII-1144



GII-1145

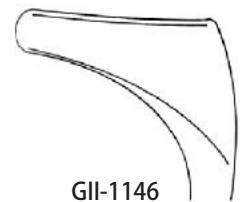

GII-1146

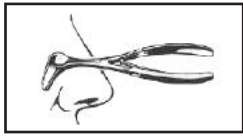

E.N.T INSTRUMENTS



Killian Nasal Speculum
5" (13 cm)

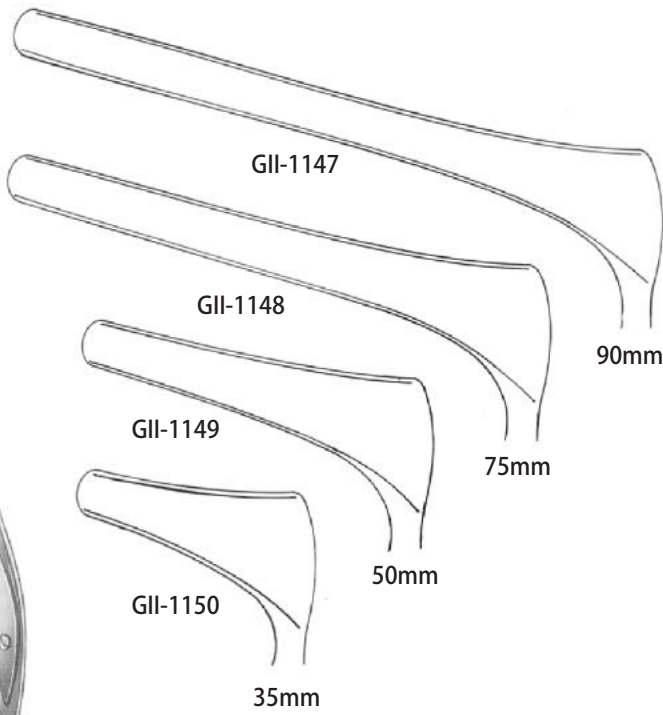

Vienna Nasal Speculum
5 1/2" (14 cm)

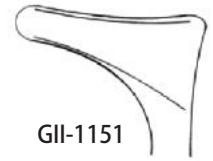

GII-1151

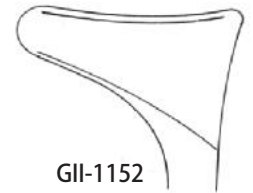

GII-1152

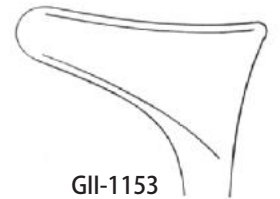

GII-1153



GII-1157



GII-1158



GII-1159



GII-1154



GII-1155



GII-1156



Thudichum
(Goldsmith) Nasal Speculum
2 1/2" (6.5cm)



Voltolini (Duplay) Nasal Speculum



E.N.T INSTRUMENTS

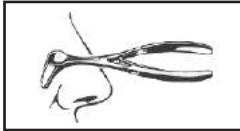

Politzer Ear Speculum



Toynbee Ear Speculum



Hartmann Ear Speculum



Gruber Ear Speculum

- 047
- 048
- 049
- 050

	Politzer Ear Speculum	Toynbee Ear Speculum	Hartmann Ear Speculum	Gruber Ear Speculum
2.0	GII-1748	GII-1755	GII-1762	GII-1769
3.0	GII-1749	GII-1756	GII-1763	GII-1770
3.5	GII-1750	GII-1757	GII-1764	GII-1771
4.0	GII-1751	GII-1758	GII-1765	GII-1772
5.0	GII-1752	GII-1759	GII-1766	
6.5	GII-1753	GII-1760	GII-1767	
7.5	GII-1754	GII-1761	GII-1768	



GII-1173

Ear Syringe (Complete Set)



GII-09S-052

Politzer Air Bag (Complete Set with 4 Tips)



GII-1774

4 mm Ø



GII-1775

15 mm Ø



GII-1776

17 mm Ø



GII-1777

22 mm Ø

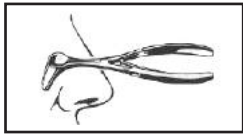

E.N.T INSTRUMENTS

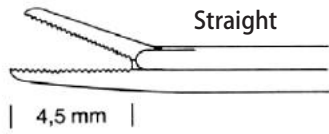

GII-1778

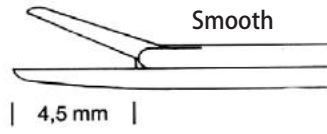

GII-1779

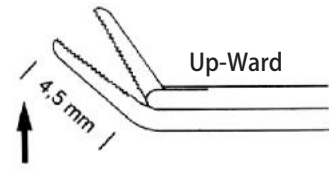

GII-1780

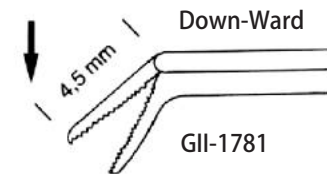

GII-1781

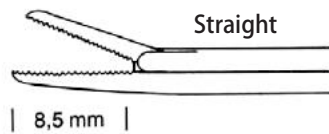

GII-1782

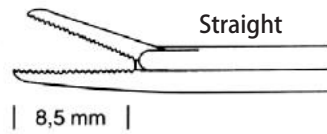

GII-1783



Micro Ear Forceps

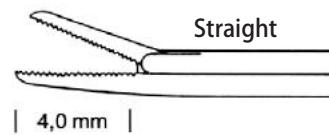

GII-1784

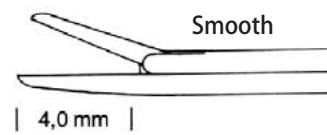

GII-1785



E.N.T INSTRUMENTS

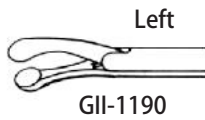
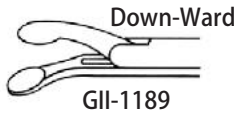
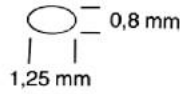
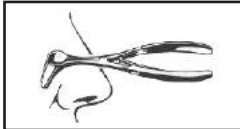

Micro Ear Forceps

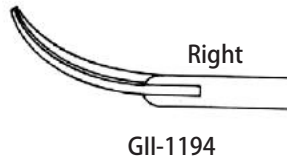
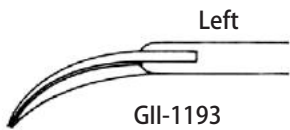
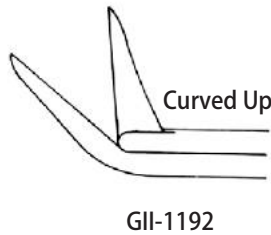
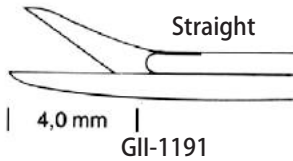

Bellucci Micro Ear Forceps

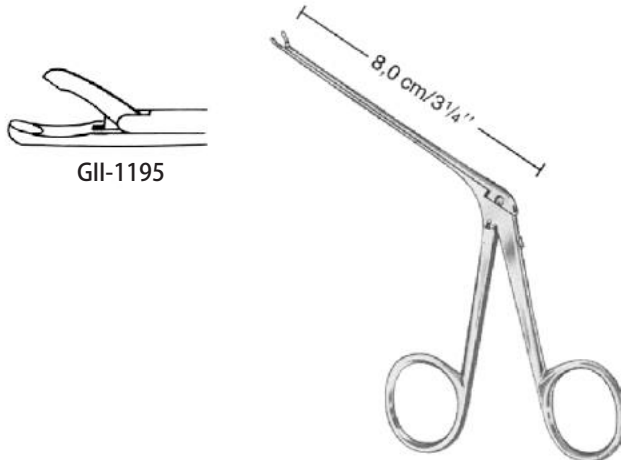

Crura-Nipper Micro Ear Forceps

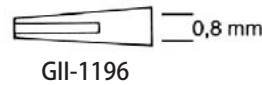
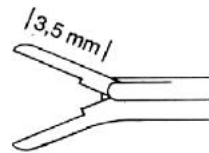

McGEE Ear Forceps

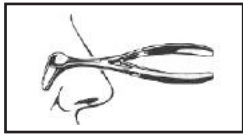

E.N.T INSTRUMENTS



GII-1197
Hartmann-Wullstein



GII-1198
Hartmann-Wullstein



ARTICLE #	SHAFT
GII-1199	3 1/2" (8.5cm)
GII-1200	5 1/2" (14 cm)

Hartmann



ARTICLE #	SHAFT
GII-1201	3 1/2" (8.5cm)
GII-1202	5 1/2" (14 cm)

Hartmann



GII-1203
Hartmann-Noyes



GII-1204
Duckbill



GII-1205
Weingartner



ARTICLE #	CUP
GII-1206	2.0mm
GII-1207	2.5mm
GII-1208	3.0mm

Hartmann



ARTICLE #	CUP
GII-1209	2.0mm
GII-1210	2.5mm
GII-1211	3.0mm

Hartmann



GII-1212
Strompel



GII-1213
Hartmann



GII-1214
Hartmann



GII-1215
Hartmann-Hoffmann



E.N.T INSTRUMENTS

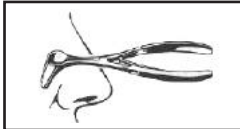

GII-1216
Hartmann
4 3/4" (12 cm)

GII-1217
Hartmann
5 1/2" (14 cm)

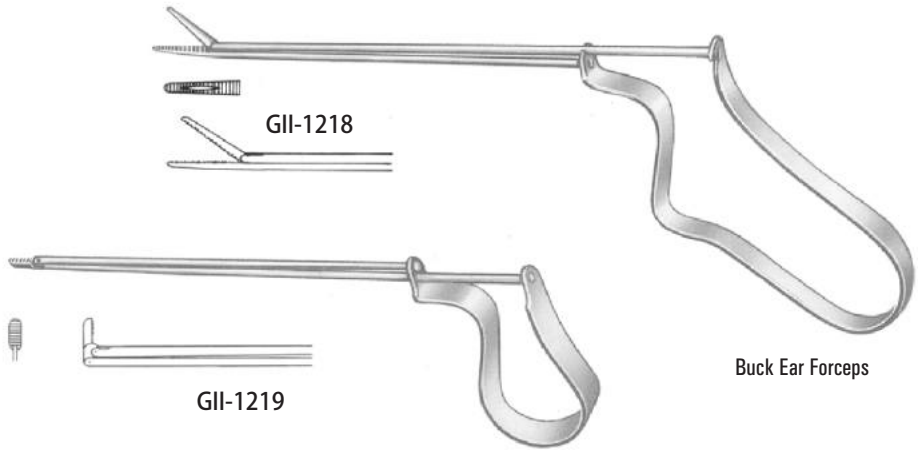

GII-1218

GII-1219

Buck Ear Forceps

Quire Ear Forceps



ARTICLE #	SIZE
GII-1220	6 1/4" (16 cm)
GII-1221	8" (20 cm)

Hartmann



GII-1222
Heymann-Knight Nasal Polypus Forceps
7" (18 cm)



GII-1223
Lubet-Barbon
8" (20 cm)



GII-1224
killian
6 3/4" (17 cm)



Westmacott
8" (20 cm)



GII-1225



GII-1226



GII-1227
Hartmann Nasal Polypus Forceps
7 1/2" (19 cm)

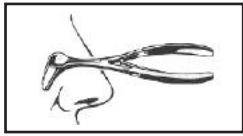

E.N.T INSTRUMENTS

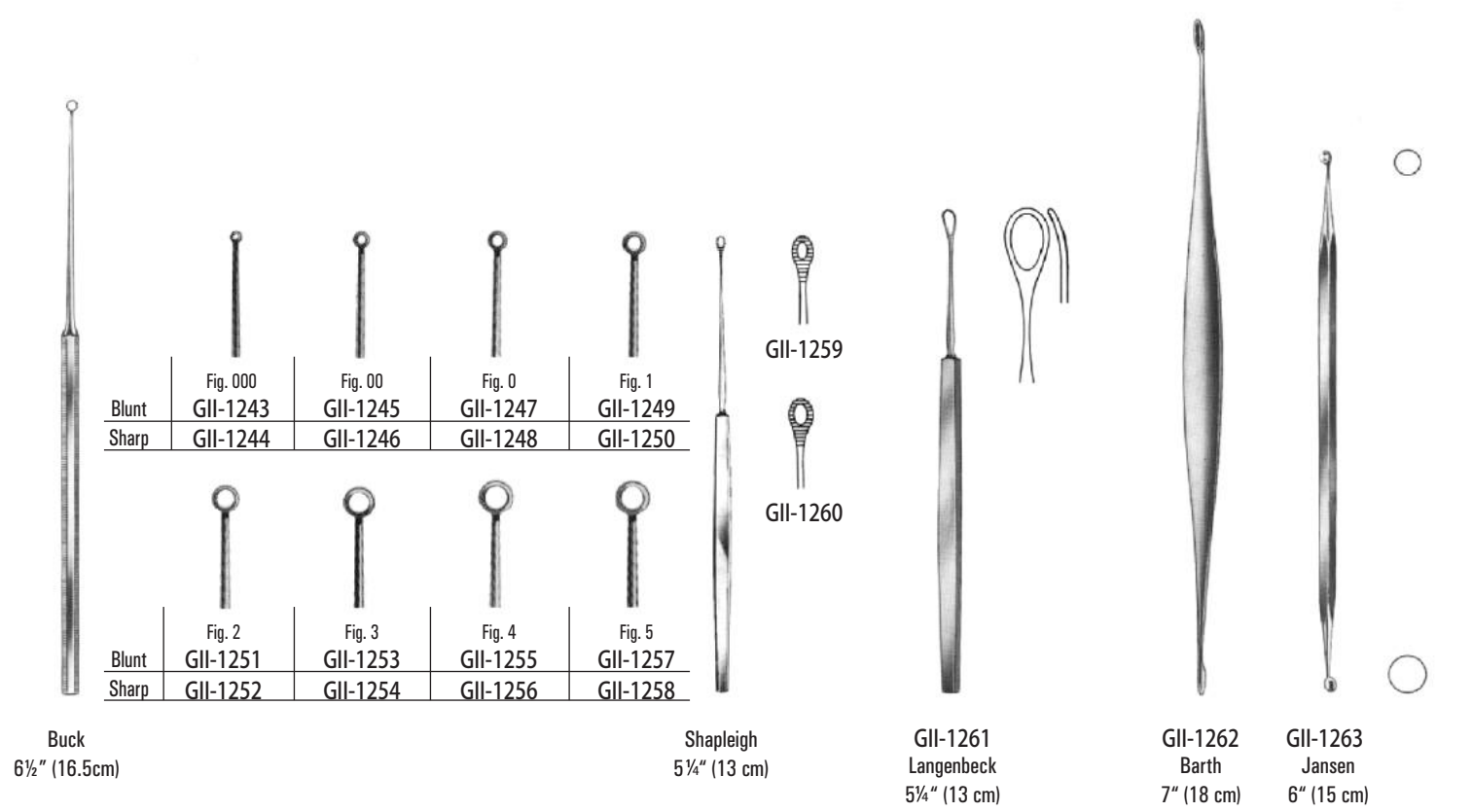
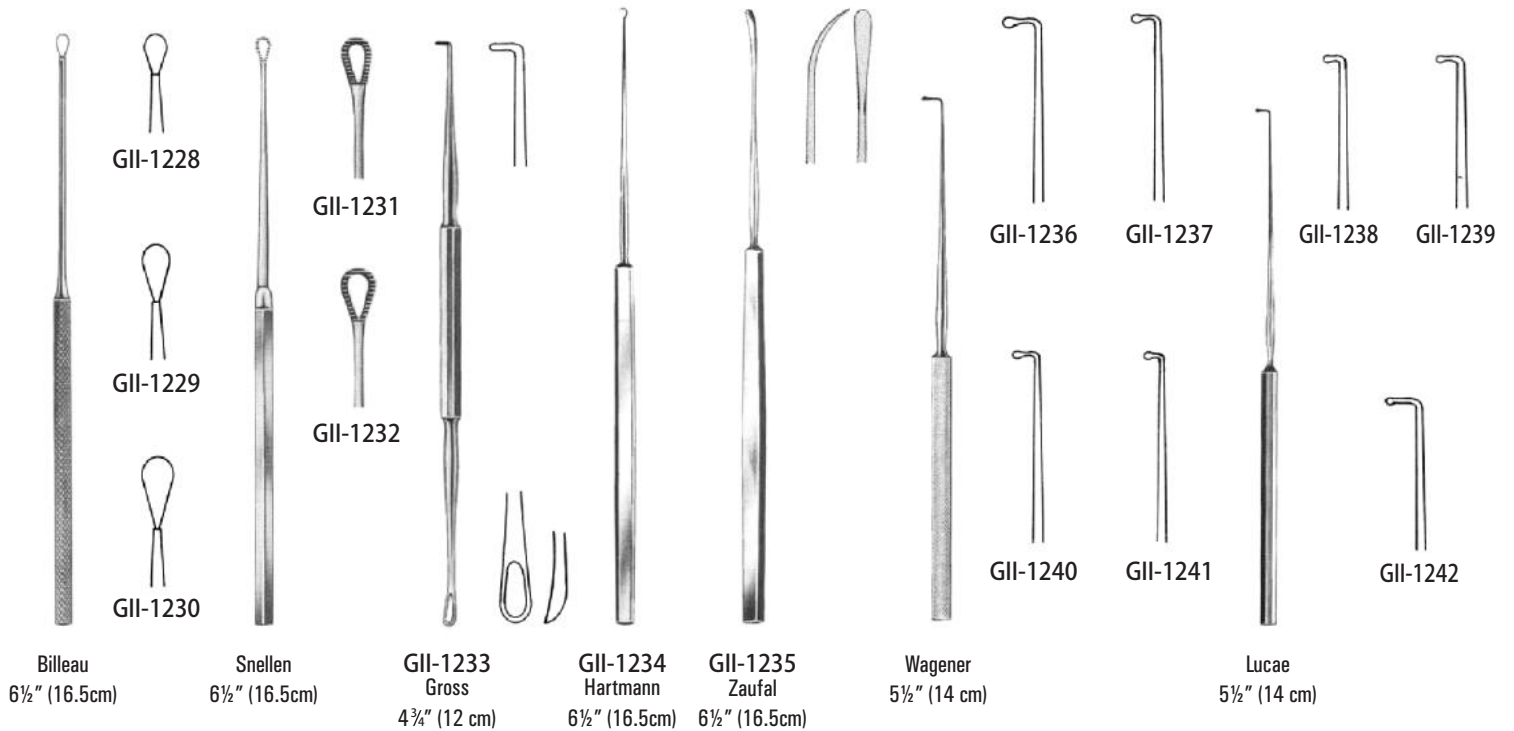



E.N.T INSTRUMENTS

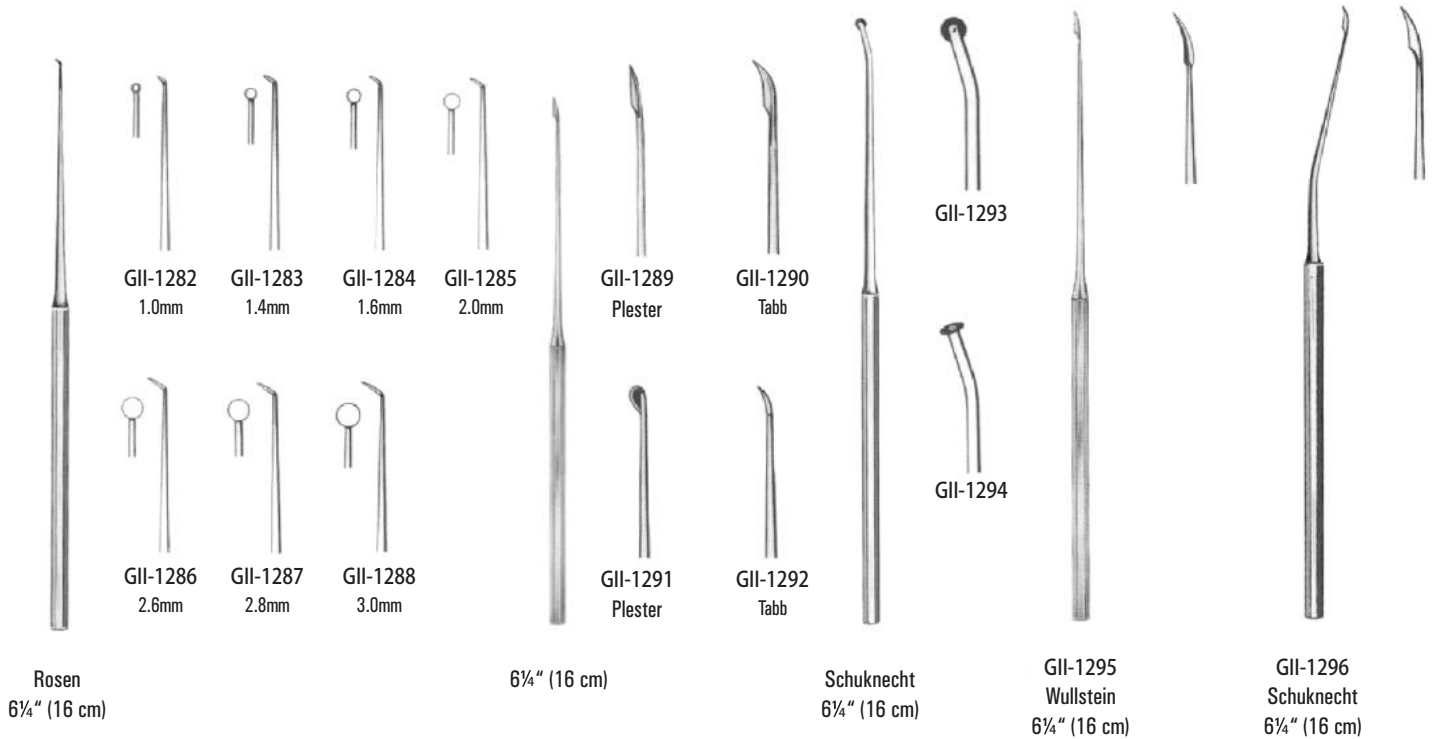
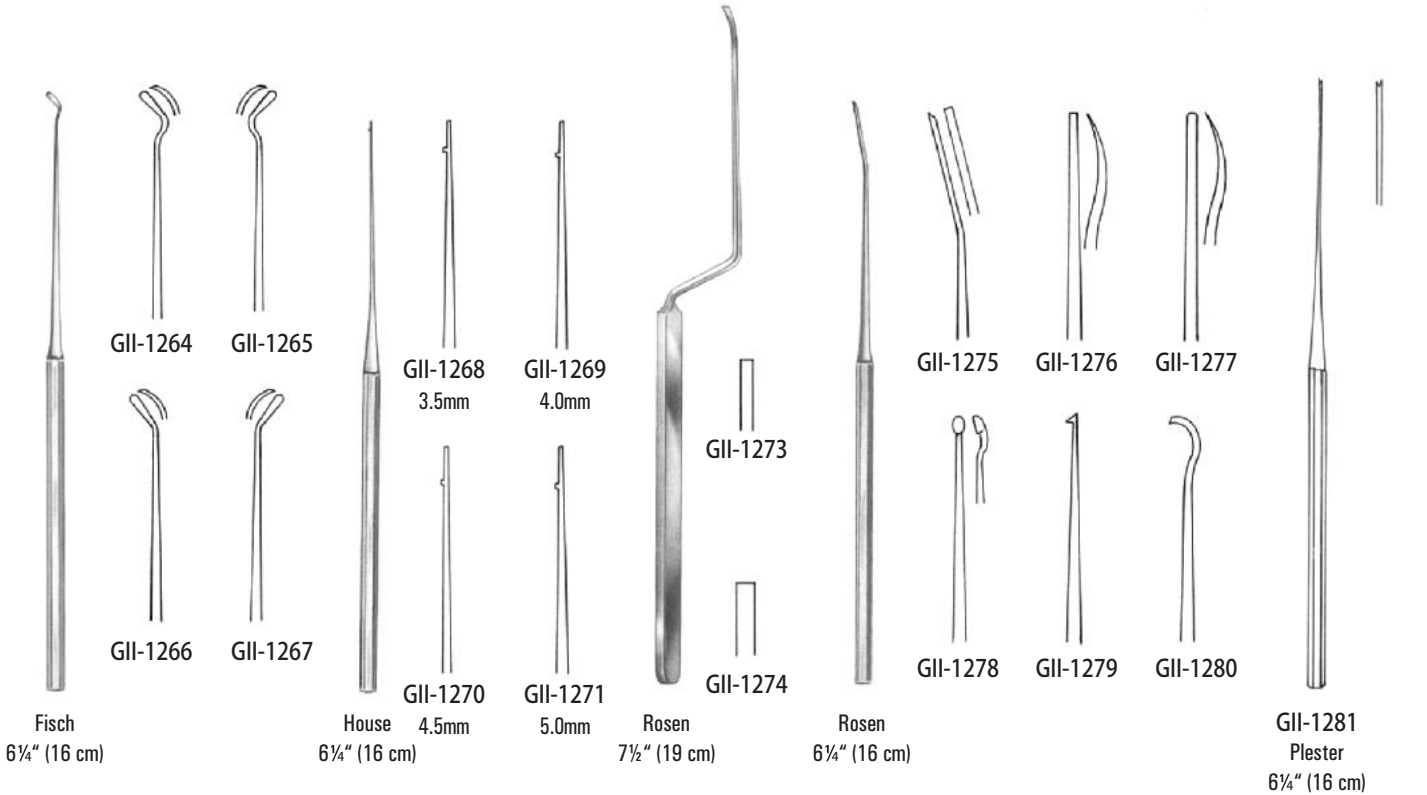
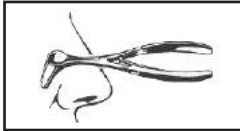

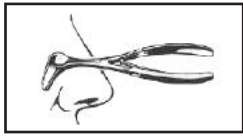

E.N.T INSTRUMENTS



 1.0mm 1.2mm GII-1297 House Foot Plate Hand Instruments 6" (15 cm)	 1.5mm 2.8mm GII-1298 House Foot Plate Hand Instruments 6" (15 cm)	 1.5 x 2.5mm GII-1299 Shear Foot Plate Hand Instruments 6 1/4" (16 cm)	 1.5 x 2.5mm GII-1300 Shear Foot Plate Hand Instruments 6 1/4" (16 cm)	 1.5 x 2.5mm Foot Plate Hand Instruments 6 1/4" (16 cm)	 GII-1301 Buckingham	 GII-1302 Larkin	 GII-1303 Buckingham	 GII-1304 Larkin	 GII-1305 Buckingham	 GII-1306 Larkin						
 Lempert Curettes 8 1/4" (21 cm)	 Wullstein Curettes 6 1/4" (16 cm)	 GII-09S-194 Lempert Curettes 6 1/4" (16 cm)	 GII-09S-195 Shambaugh-Derlacki Curettes 6 1/4" (16 cm)	 Lempert Curettes 6 3/4" (17 cm)	 GII-1307 Fig.0	 GII-1308 Fig.00	 GII-1309 Fig.000	 GII-1310 Fig.0000	 GII-1311 Fig.00000	 GII-1312 2.2mm	 GII-1313 3.2mm	 3mm	 GII-1317 2mm	 GII-1318 3mm	 GII-1319 4mm	 GII-1320 5mm



E.N.T INSTRUMENTS

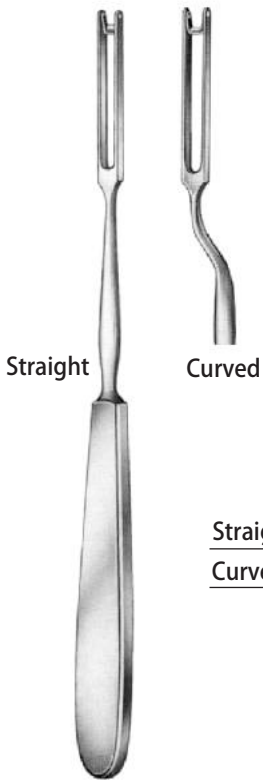
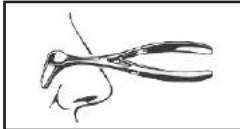

Ballenger Spetum Knives
8"(20 cm)

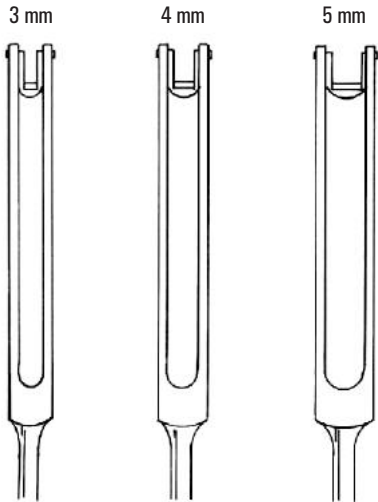

Straight	GII-1321	GII-1322	GII-1323
Curved	GII-1324	GII-1325	GII-1326

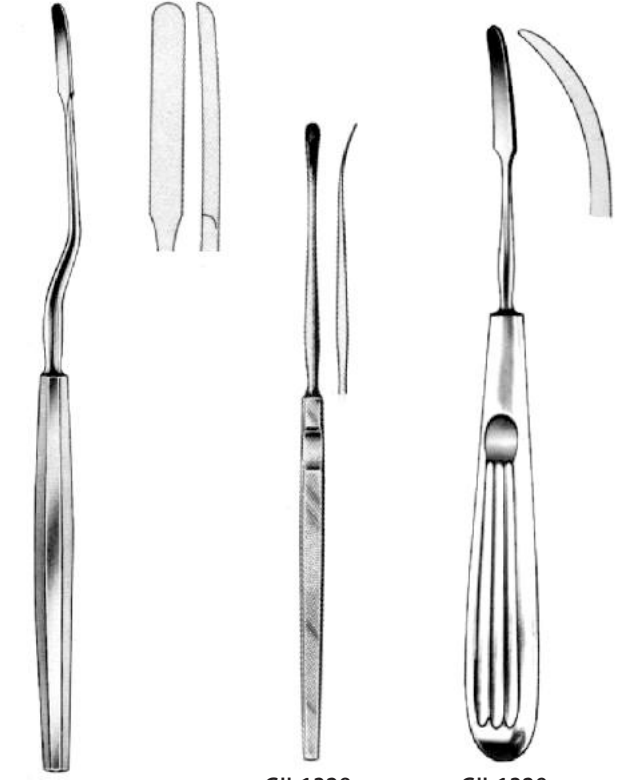

GII-1327
Joseph-Masing
8¾"(22 cm)

GII-1328
Halle
Periosteal Elevators
6½"(16.5cm)

GII-1329
Joseph
Periosteal Elevators
6½"(16.5cm)

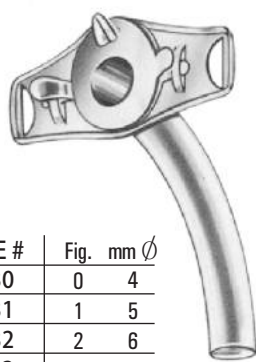
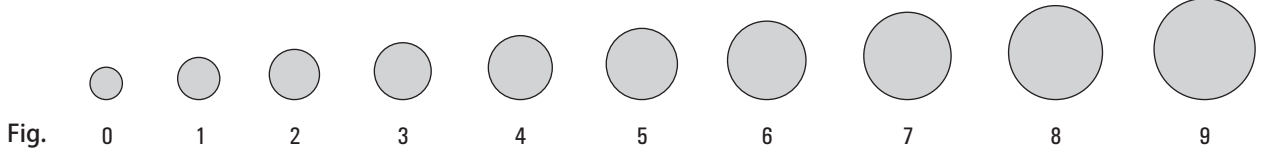

Luer

ARTICLE #	Fig.	mm Ø
GII-1330	0	4
GII-1331	1	5
GII-1332	2	6
GII-1333	3	7
GII-1334	4	8
GII-1335	5	9
GII-1336	6	10
GII-1337	7	11
GII-1338	8	12
GII-1339	9	13

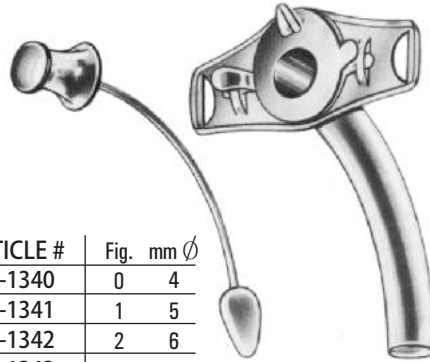

Chevalier-Jackson

ARTICLE #	Fig.	mm Ø
GII-1340	0	4
GII-1341	1	5
GII-1342	2	6
GII-1343	3	7
GII-1344	4	8
GII-1345	5	9
GII-1346	6	10
GII-1347	7	11
GII-1348	8	12
GII-1349	9	13

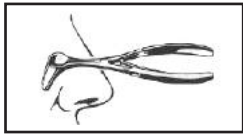

E.N.T INSTRUMENTS



GII-1350
Krause Nasal Snares
6 3/4" (16 cm)



GII-1351
Krause-Voss Nasal Snares
6 3/4" (16 cm)



GII-1352
Lange-Wilde Nasal Snares
6 3/4" (16 cm)

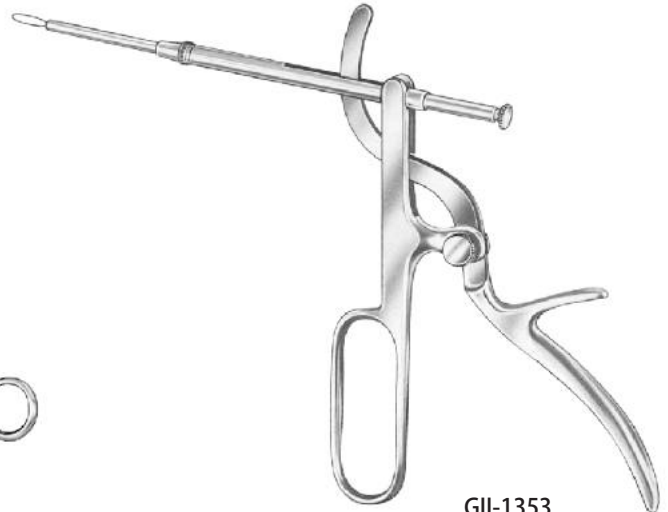

GII-1353
Tonsil Snares



Hartmann
Otology Instruments
5 1/2" (14 cm)

- GII-1354**
- GII-1355**
- GII-1356**
- GII-1357**
- GII-1358**
- GII-1359**



GII-09S-249 - GII-09S-255
Frazier Suction Tubes
7 1/2" (19 cm)

ARTICLE #	Fr.
GII-1360	6
GII-1361	7
GII-1362	8
GII-1363	9
GII-1364	10
GII-1365	11
GII-1366	12



GII-09S-256 - GII-09S-258
Baron Suction Tubes

ARTICLE #	Fr.
GII-1367	3
GII-1368	5
GII-1369	7



GII-1370
Suction Tubes
11 3/4" (30 cm)



E.N.T INSTRUMENTS

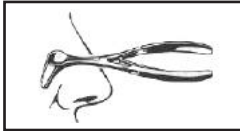

Lewis
7" (18 cm)

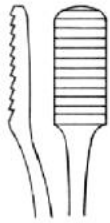

GII-1371

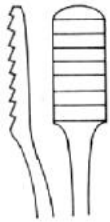

GII-1372



GII-1373
Cottle
8 3/4" (21 cm)

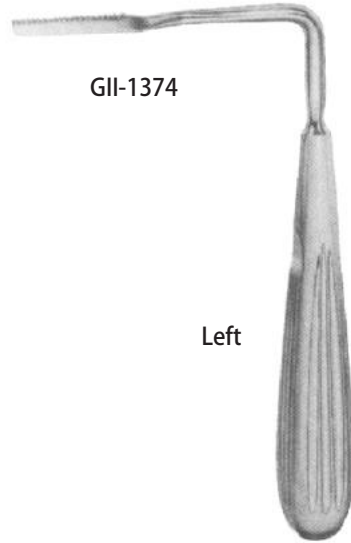

GII-1374

Left

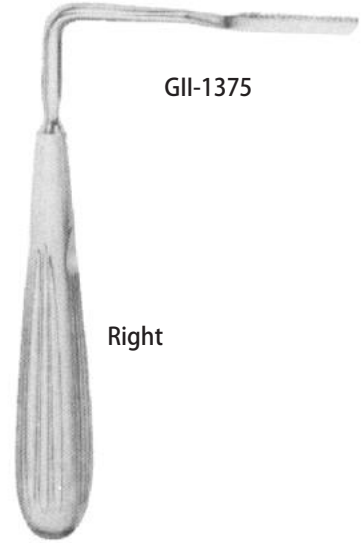

GII-1375

Right

Joseph
6 3/4" (17 cm)



GII-1376
Maltz
7" (18 cm)

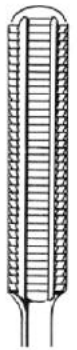

Joseph
7 1/2" (19 cm)



GII-1377

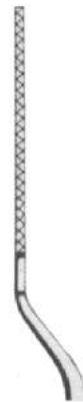

GII-1378



GII-1379



Aufrecht
8 3/4" (21 cm)

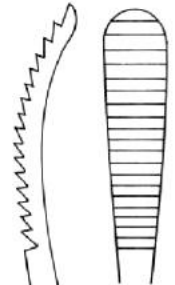

GII-1380

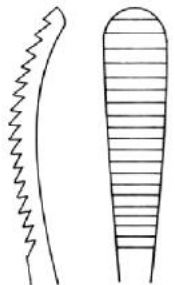

GII-1381

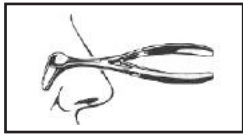

E.N.T INSTRUMENTS



GII-09S-271- GII-09S-276
Hartmann
Tuning Fork

GII-1382	C 128
GII-1383	C 256
GII-1384	C 512
GII-1385	C 1024
GII-1386	C 2048
GII-1387	C 4096

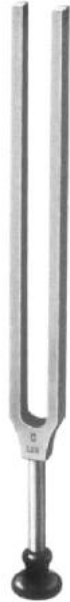

GII-09S-277- GII-09S-282
Lucae
Tuning Fork

GII-1388	C 128
GII-1389	C 256
GII-1390	C 512
GII-1391	C 1024
GII-1392	C 2048
GII-1393	C 4096

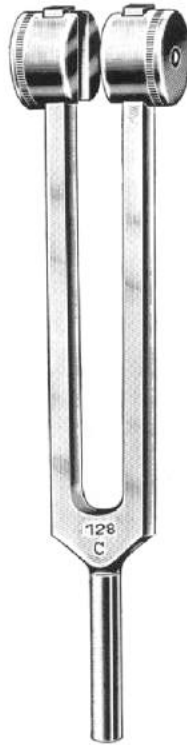

GII-09S-283- GII-09S-285
Koenig A-109
Tuning Fork

GII-1394	C 64
GII-1395	C 128
GII-1396	C 256

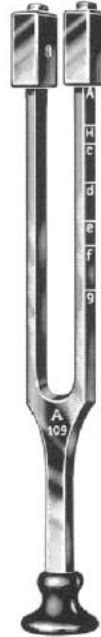

GII-1397
Rydel-Seiffer
C64/C128
Tuning Fork

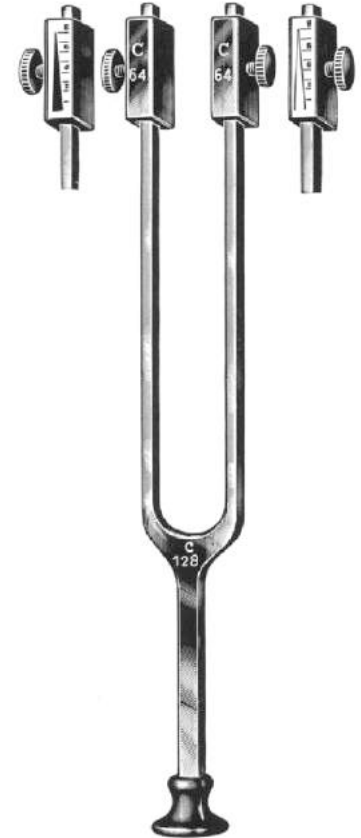

GII-1398
Rydel-Seiffer
C128
Tuning Fork

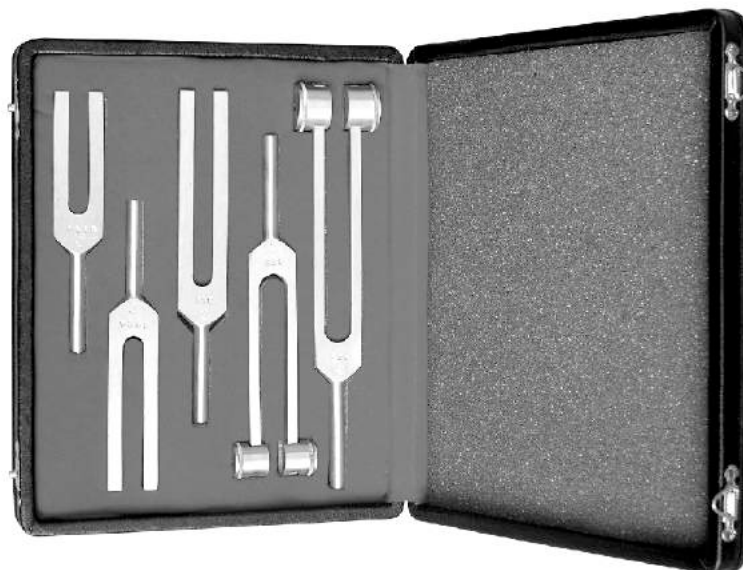

GII-1399
Set of Tuning Forks
C 128
C 256
C 512
C 1024
C 2048



NEURO SURGERY INSTRUMENTS

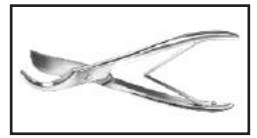

GII-1748
Bone & Rib Shears
9" (23 cm)



GII-1749
Bone & Rib Shears
8 3/4" (22 cm)



GII-1750
Gluck
Bone & Rib Shears
8 3/4" (22 cm)

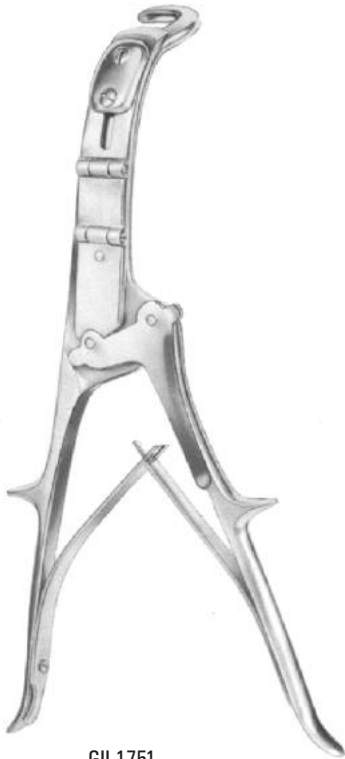

GII-1751
Brunner Sternum Scissors
12 1/2" (32 cm)



GII-1752
Giertz-Stille
Sternum Scissors
10 1/2" (27 cm)



GII-1753
Sauerb-Ruch
Sternum Scissors
10 1/4" (26 cm)



GII-1754
Lebsche
Sternum Scissors
9 3/4" (25 cm)

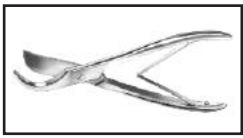

NEURO SURGERY INSTRUMENTS



Cooley Rib Spreader

Art.No	A	B	C	D
GIL-1755	20mm	45mm	140mm	110mm
GIL-1756	30mm	50mm	180mm	145mm
GIL-1757	30mm	50mm	200mm	145mm

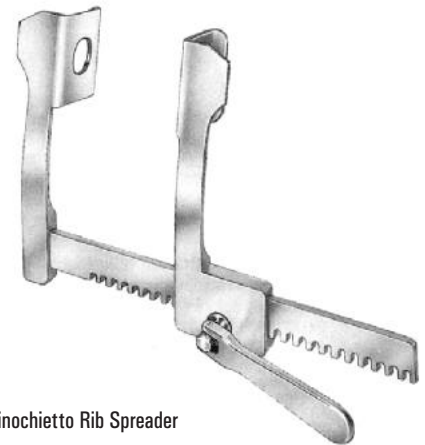
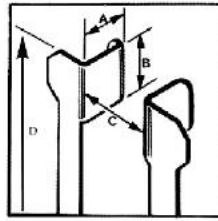

Finochietto Rib Spreader

Art.No	A	B	C	D
GIL-1758	30mm	45mm	140mm	110mm
GIL-1759	42mm	62mm	175mm	140mm
GIL-1760	75mm	65mm	200mm	140mm

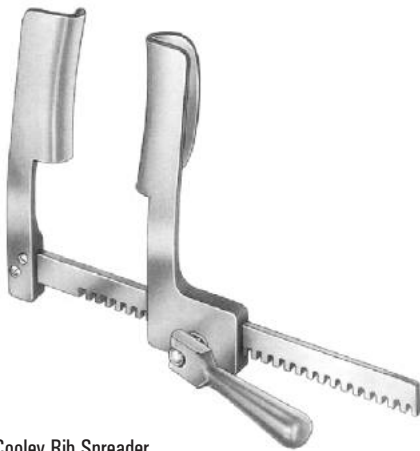

Cooley Rib Spreader

Art.No	A	B	C	D
GIL-1761	35mm	100mm	180mm	180mm
GIL-1762	35mm	115mm	230mm	205mm



Burford-Finochitto Rib Spreader

Art.No	A	B	C	D
GIL-1763	45mm	62mm	180mm	200mm
GIL-1764	45mm	62mm	250mm	200mm
GIL-1765	45mm	62mm	300mm	200mm

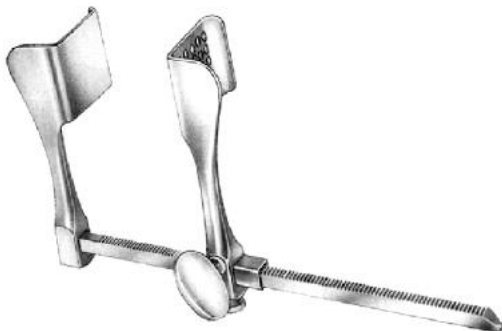

Tuffier Rib Spreader

Art.No	A	B	C	D
GIL-1766	42mm	45mm	170mm	110mm

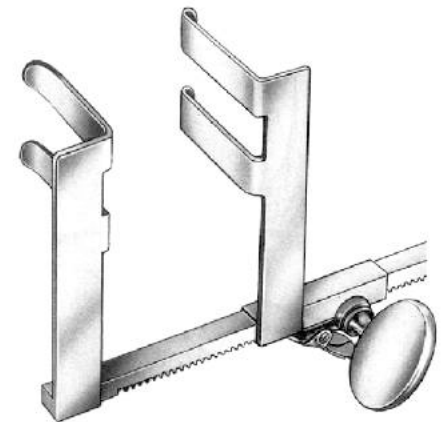

Mini Thoracotomy Rib Spreader

Art.No	A	B	C	D
GIL-1767	38mm	12mm	70mm	90mm



NEURO SURGERY INSTRUMENTS

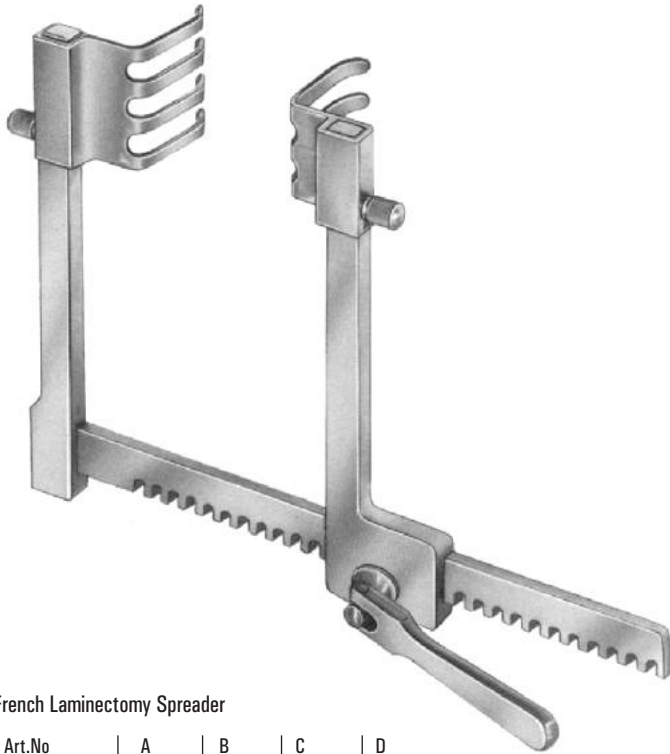

French Laminectomy Spreader

Art.No	A	B	C	D
GII-1768	38mm	32mm	130mm	125mm

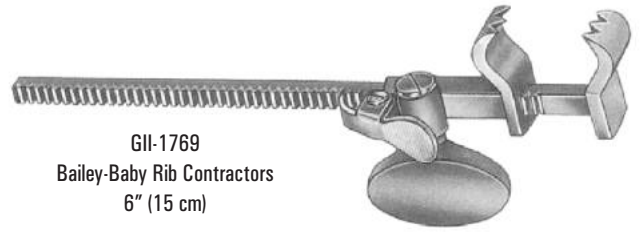

GII-1769
Bailey-Baby Rib Contractors
6" (15 cm)

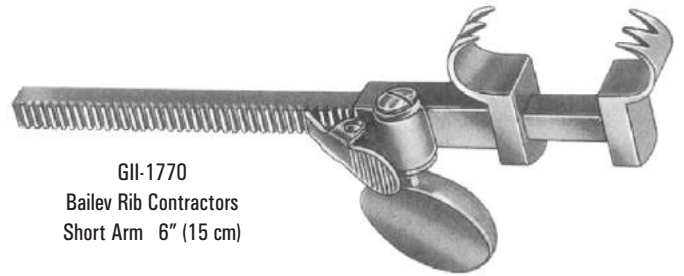

GII-1770
Bailev Rib Contractors
Short Arm 6" (15 cm)

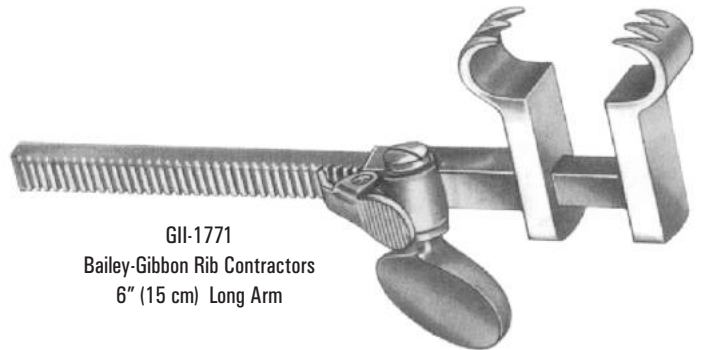

GII-1771
Bailey-Gibbon Rib Contractors
6" (15 cm) Long Arm



GII-1774
Casper Retractor for Spine



GII-1772	50 x 25 mm
GII-1773	60 x 25 mm

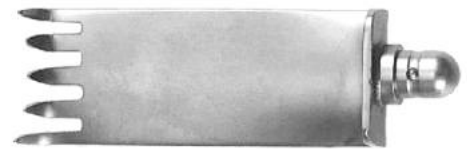

GII-1780	40 x 23 mm
GII-1781	45 x 23 mm
GII-1782	50 x 23 mm
GII-1783	55 x 23 mm
GII-1784	60 x 23 mm

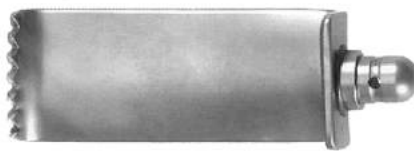

GII-1775	40 x 23 mm
GII-1776	45 x 23 mm
GII-1777	50 x 23 mm
GII-1778	55 x 23 mm
GII-1779	60 x 23 mm



GII-1785	45 x 23 mm
GII-1786	50 x 23 mm
GII-1787	55 x 23 mm
GII-1788	60 x 23 mm
GII-1789	65 x 23 mm

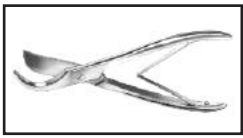

NEURO SURGERY INSTRUMENTS



GII-1790
Crutchfield Traction
Cervical Tongs Small



GII-1791
Crutchfield Traction
Tongs Medium



GII-1792
3.5mm \varnothing



GII-1793
5mm \varnothing



GII-1794
Dahlgren Instruments
8" (20 cm)



GII-1795
De Vibiss Instruments
8 1/4" (21 cm)



GII-1796
Lange Lamina Spreader
10 3/4" (27 cm)



GII-1797
Lange Lamina Spreader
6 1/2" (16 cm)



GII-1798
Cloward Lamina Spreader
6 1/2" (16 cm)



NEURO SURGERY INSTRUMENTS



ARTICLE #	SIZE
GII-1799	6" (15 cm)
GII-1800	7½" (19 cm)

McKenzie
Clip Applying Forceps
Curved

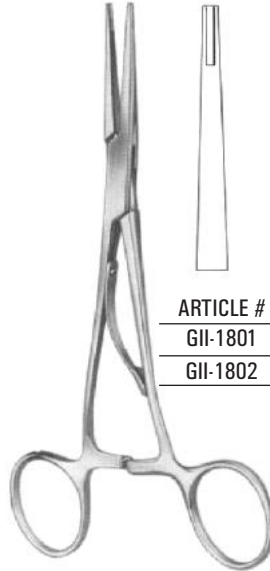

ARTICLE #	SIZE
GII-1801	6" (15 cm)
GII-1802	7½" (19 cm)

McKenzie
Clip Applying Forceps
Straight

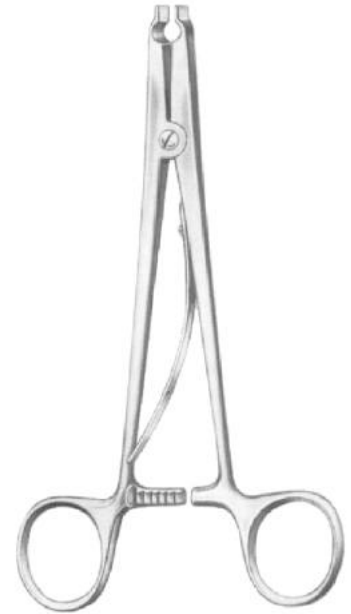

GII-1803
Raney
Hemostatic Clip Applying Forceps
6" (15 cm)

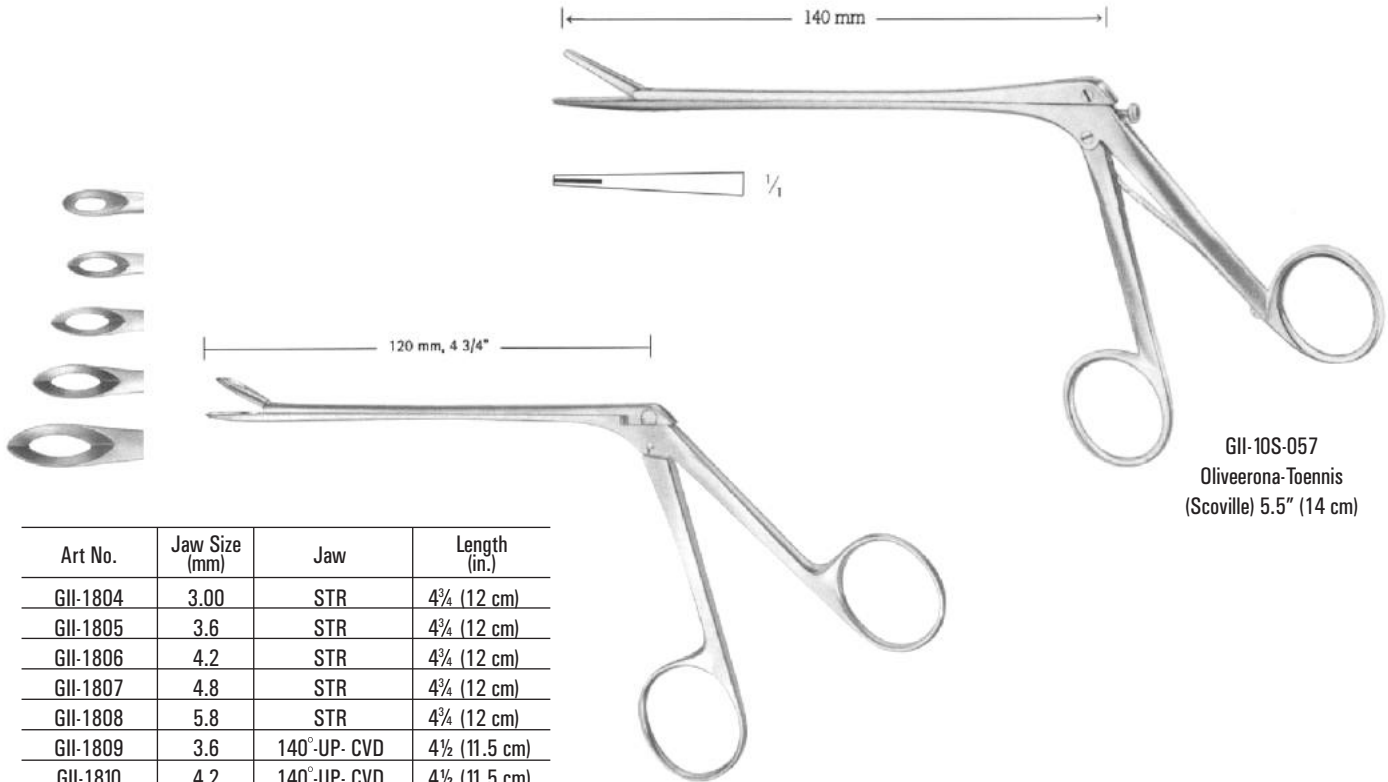

GII-10S-057
Oliveirona-Toennis
(Scoville) 5.5" (14 cm)

Art No.	Jaw Size (mm)	Jaw	Length (in.)
GII-1804	3.00	STR	4¾ (12 cm)
GII-1805	3.6	STR	4¾ (12 cm)
GII-1806	4.2	STR	4¾ (12 cm)
GII-1807	4.8	STR	4¾ (12 cm)
GII-1808	5.8	STR	4¾ (12 cm)
GII-1809	3.6	140°-UP- CVD	4½ (11.5 cm)
GII-1810	4.2	140°-UP- CVD	4½ (11.5 cm)
GII-1811	4.8	140°-UP- CVD	4½ (11.5 cm)

GII-10S-058 to GII-1812
Weil-Blakesley Roungeur

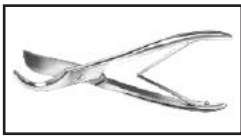

NEURO SURGERY INSTRUMENTS

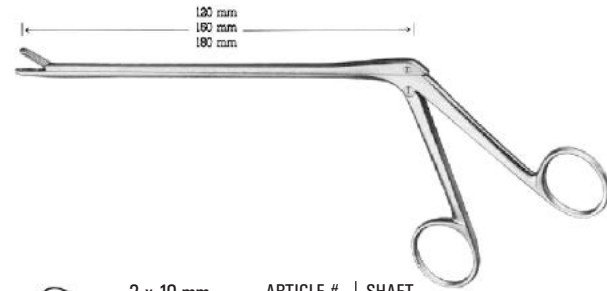

2 x 10 mm	ARTICLE #	SHAFT
	GII-1813	120 mm
	GII-1814	150 mm
	GII-1815	180 mm

3 x 10 mm	ARTICLE #	SHAFT
	GII-1816	120 mm
	GII-1817	150 mm
	GII-1818	180 mm

4 x 10 mm	ARTICLE #	SHAFT
	GII-1819	120 mm
	GII-1820	150 mm
	GII-1821	180 mm

ARTICLE #	SHAFT	2 x 10 mm / 45°
GII-1822	120 mm	
GII-1823	150 mm	
GII-1824	180 mm	

ARTICLE #	SHAFT	3 x 10 mm / 45°
GII-1825	120 mm	
GII-1826	150 mm	
GII-1827	180 mm	

ARTICLE #	SHAFT	4 x 10 mm / 45°
GII-1828	120 mm	
GII-1829	150 mm	
GII-1830	180 mm	

2 x 10 mm / 45°	ARTICLE #	SHAFT
	GII-1831	120 mm
	GII-1832	150 mm
	GII-1833	180 mm

3 x 10 mm / 45°	ARTICLE #	SHAFT
	GII-1834	120 mm
	GII-1835	150 mm
	GII-1836	180 mm

4 x 10 mm / 45°	ARTICLE #	SHAFT
	GII-1837	120 mm
	GII-1838	150 mm
	GII-1839	180 mm

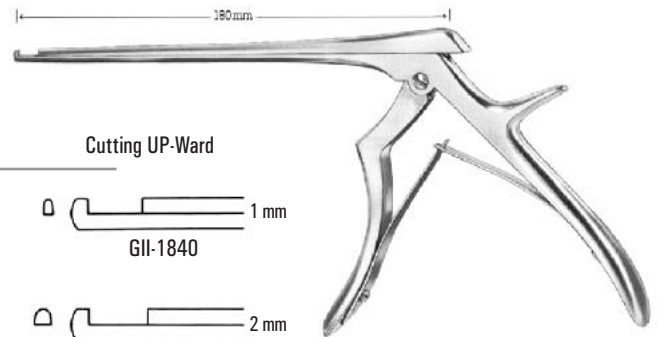

Ferris-Smith-Kerrison

Cutting UP-Ward



GII-1840



GII-1841



GII-1842

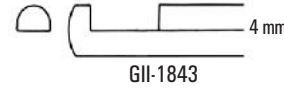

GII-1843

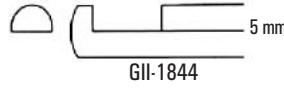

GII-1844

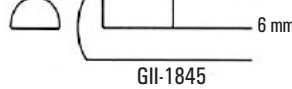

GII-1845

Cutting Down-Ward



GII-1852



GII-1853



GII-1854



GII-1855



GII-1856



GII-1857

Cutting 40° Angle



GII-1846



GII-1847



GII-1848

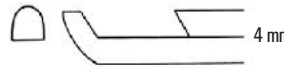

GII-1849

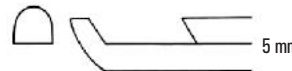

GII-1850









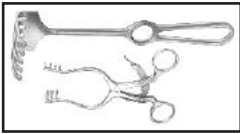





GII-1851



RETRACTORS

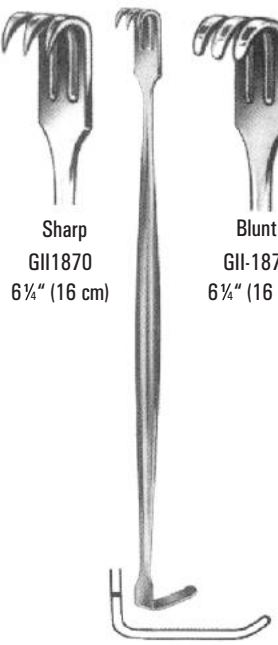

 Small GII-1859	 Medium GII-1861	 Large GII-1860	 Extra Large GII-1862	 Tyreel Hook 5" (12.5 cm)	<table border="1" style="margin-left: auto; margin-right: auto;"> <tr> <td style="text-align: center;">GII-1864</td> <td style="text-align: center;">Sharp</td> </tr> <tr> <td style="text-align: center;">GII-1865</td> <td style="text-align: center;">Blunt</td> </tr> </table>	GII-1864	Sharp	GII-1865	Blunt	 Frazier Dura Hook 5" (12.5 cm)	<table border="1" style="margin-left: auto; margin-right: auto;"> <tr> <td style="text-align: center;">GII-1858</td> <td style="text-align: center;">Sharp tip</td> </tr> <tr> <td style="text-align: center;">GII-1863</td> <td style="text-align: center;">Blunt tip</td> </tr> </table>	GII-1858	Sharp tip	GII-1863	Blunt tip	 GII-1866 Guthrie Skin Hook 5" (12.5 cm) 2 Prong	 GII-1867 Wiener Skin Hook 5" (12.5 cm), sharp	 GII-1868 Wiener Skin Hook 5" (12.5cm), Blunt
GII-1864	Sharp																	
GII-1865	Blunt																	
GII-1858	Sharp tip																	
GII-1863	Blunt tip																	

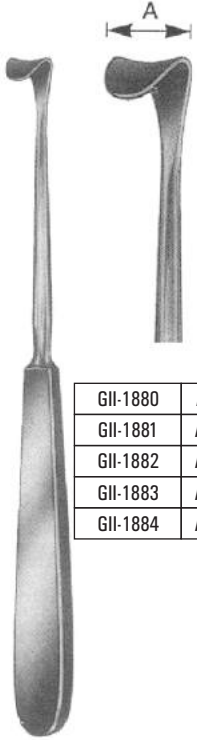
 8 x 4 mm 15 x 5.5 mm GII-1869 Ragnell Davis Retractor 5 1/2" (14 cm)	<table border="1" style="margin-left: auto; margin-right: auto;"> <tr> <td style="text-align: center;">Sharp</td> <td style="text-align: center;">Blunt</td> </tr> <tr> <td style="text-align: center;">GII-1870</td> <td style="text-align: center;">GII-1871</td> </tr> <tr> <td style="text-align: center;">6 1/4" (16 cm)</td> <td style="text-align: center;">6 1/4" (16 cm)</td> </tr> </table>	Sharp	Blunt	GII-1870	GII-1871	6 1/4" (16 cm)	6 1/4" (16 cm)	 Senn-Mueller Retractor	 Trachea Retractor 6 1/2" (16 cm)	<table border="1" style="margin-left: auto; margin-right: auto;"> <tr> <td style="text-align: center;">Blunt</td> <td style="text-align: center;">Sharp</td> </tr> <tr> <td style="text-align: center;">1 Progn</td> <td style="text-align: center;">1 Progn</td> </tr> <tr> <td style="text-align: center;">GII-1872</td> <td style="text-align: center;">GII-1873</td> </tr> <tr> <td style="text-align: center;">2 Progn</td> <td style="text-align: center;">2 Progn</td> </tr> <tr> <td style="text-align: center;">GII-1874</td> <td style="text-align: center;">GII-1875</td> </tr> <tr> <td style="text-align: center;">3 Progn</td> <td style="text-align: center;">3 Progn</td> </tr> <tr> <td style="text-align: center;">GII-1876</td> <td style="text-align: center;">GII-1877</td> </tr> <tr> <td style="text-align: center;">4 Progn</td> <td style="text-align: center;">4 Progn</td> </tr> <tr> <td style="text-align: center;">GII-1878</td> <td style="text-align: center;">GII-1879</td> </tr> </table>	Blunt	Sharp	1 Progn	1 Progn	GII-1872	GII-1873	2 Progn	2 Progn	GII-1874	GII-1875	3 Progn	3 Progn	GII-1876	GII-1877	4 Progn	4 Progn	GII-1878	GII-1879	 A <table border="1" style="margin-left: auto; margin-right: auto;"> <tr> <td style="text-align: center;">GII-1880</td> <td style="text-align: center;">A = 10mm</td> </tr> <tr> <td style="text-align: center;">GII-1881</td> <td style="text-align: center;">A = 20mm</td> </tr> <tr> <td style="text-align: center;">GII-1882</td> <td style="text-align: center;">A = 30mm</td> </tr> <tr> <td style="text-align: center;">GII-1883</td> <td style="text-align: center;">A = 40mm</td> </tr> <tr> <td style="text-align: center;">GII-1884</td> <td style="text-align: center;">A = 50mm</td> </tr> </table>	GII-1880	A = 10mm	GII-1881	A = 20mm	GII-1882	A = 30mm	GII-1883	A = 40mm	GII-1884	A = 50mm
Sharp	Blunt																																						
GII-1870	GII-1871																																						
6 1/4" (16 cm)	6 1/4" (16 cm)																																						
Blunt	Sharp																																						
1 Progn	1 Progn																																						
GII-1872	GII-1873																																						
2 Progn	2 Progn																																						
GII-1874	GII-1875																																						
3 Progn	3 Progn																																						
GII-1876	GII-1877																																						
4 Progn	4 Progn																																						
GII-1878	GII-1879																																						
GII-1880	A = 10mm																																						
GII-1881	A = 20mm																																						
GII-1882	A = 30mm																																						
GII-1883	A = 40mm																																						
GII-1884	A = 50mm																																						

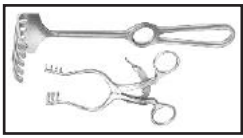

RETRACTORS

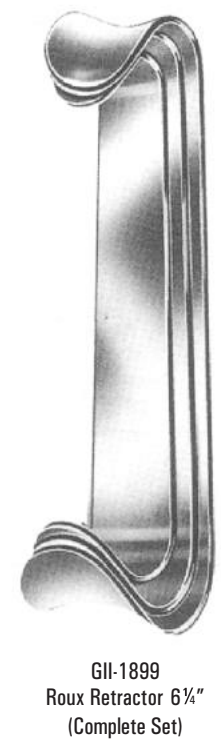
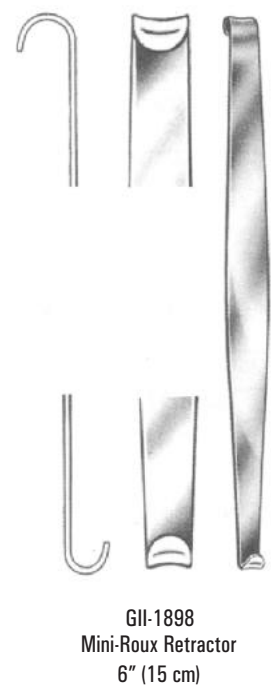
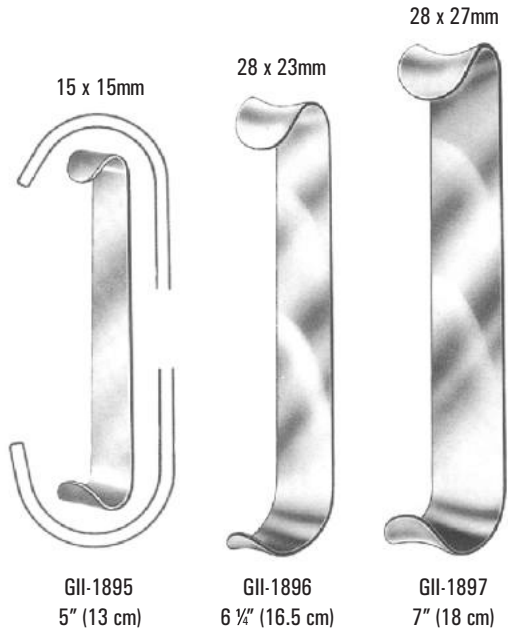
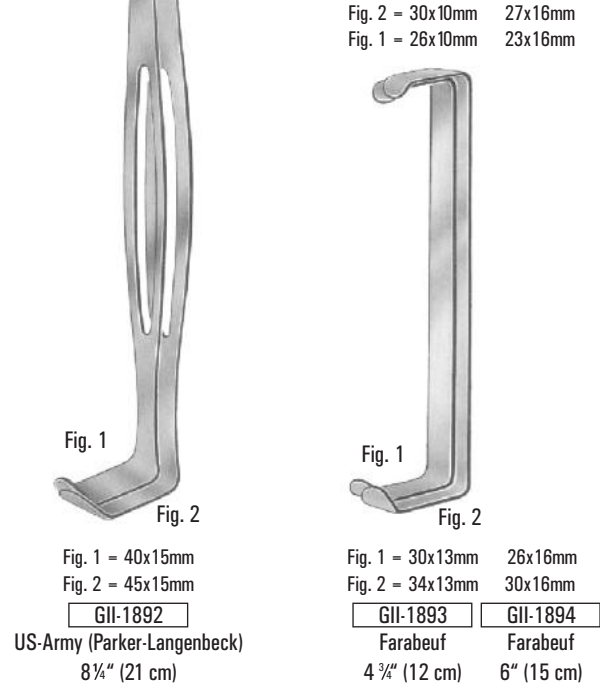
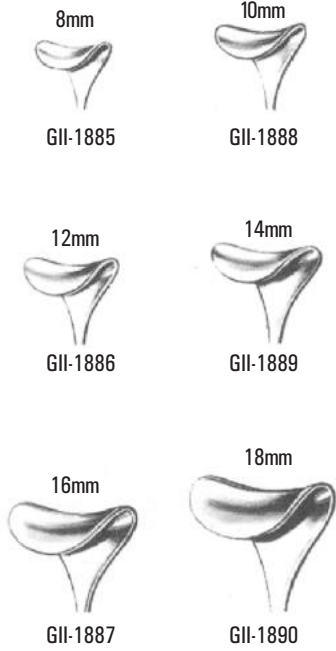
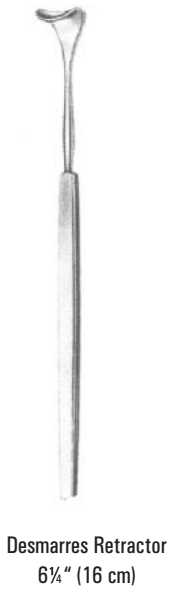



RETRACTORS

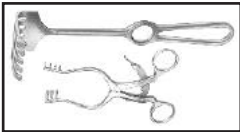

Deaver Retractor



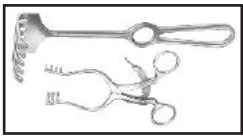

RETRACTORS



Volkmann Retractor

	9 x 8mm	9 x 13mm	9 x 19mm	9 x 29mm	9 x 40mm		
Sharp							
	GII-1908	GII-1909	GII-1910	GII-1911	GII-1912	GII-1913	
							8½" (21.5 cm)
Blunt							
	GII-1914	GII-1915	GII-1916	GII-1917	GII-1918	GII-1919	
							8½" (21.5 cm)
Semi-Blunt							
	GII-1920	GII-1921	GII-1922	GII-1923	GII-1924	GII-1925	
							8½" (21.5 cm)



Mini Langenbeck Retractor
6¼" (16 cm)

10 x 6mm	20 x 6mm
GII-1926	GII-1927
75 x 5mm	28 x 8mm
GII-1928	GII-1929

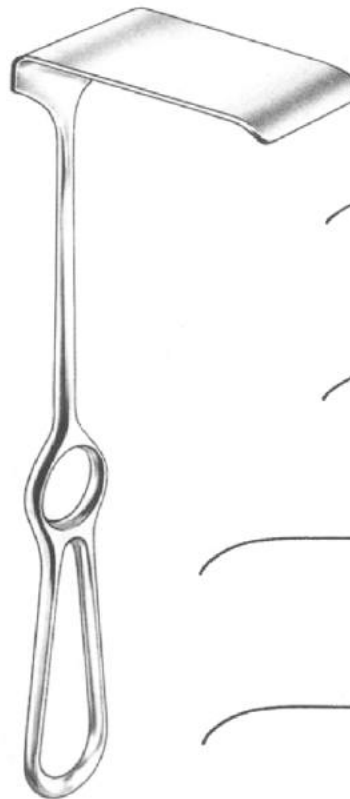

Kocher Retractor
9" (23 cm)

	GII-1930 40 x 18mm
	GII-1931 60 x 20mm
	GII-1932 60 x 25mm
	GII-1933 75 x 30mm
	GII-1934 75 x 40mm



RETRACTORS

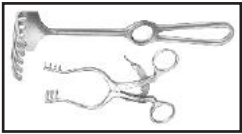

Kocher-Langenbeck Retractor
8½" (21.5 cm)



GII-1939
35 x 15mm



GII-1940
40 x 11mm



GII-1941
55 x 11mm



GII-1935
25 x 6mm



GII-1936
25 x 8mm



GII-1937
35 x 8mm



GII-1938
35 x 11mm



GII-1942
70 x 14mm

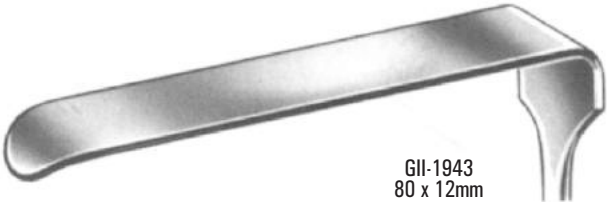

GII-1943
80 x 12mm



GII-1944
80 x 16mm

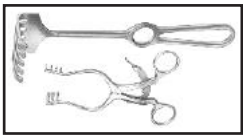

RETRACTORS



Middeldorpf Retractor

ARTICLE #	WIDE	SIZE
GII-1945	14x17mm	8 1/4" (21.5 cm)
GII-1946	20x22mm	8 3/4" (22.0 cm)
GII-1947	26x30mm	9" (23.5 cm)



Richardson Retractor

ARTICLE #	WIDE	SIZE
GII-1948	28x20mm	9" (24 cm)
GII-1949	36x28mm	9" (24 cm)
GII-1950	44x38mm	9" (24 cm)
GII-1951	52x22mm	9" (24 cm)

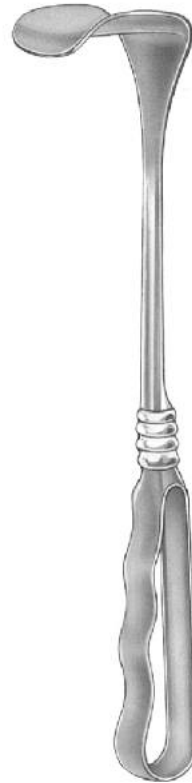

GII-1952
Kelly Retractor 65 x 50 mm
10" (26 cm)

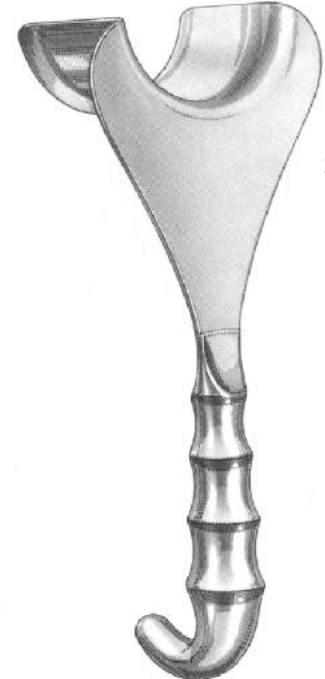

2 3/4" x 2"

GII-1953
Delee Retractor

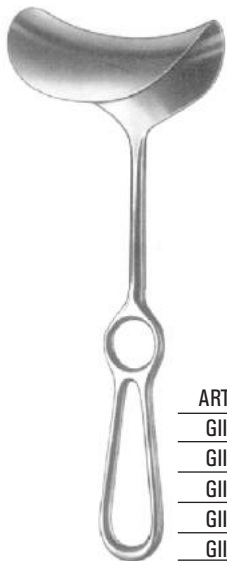

Fritsch Retractor
9 1/2" (24 cm)

ARTICLE #	WIDE
GII-1954	45x40mm
GII-1955	45x50mm
GII-1956	45x60mm
GII-1957	45x75mm
GII-1958	65x85mm

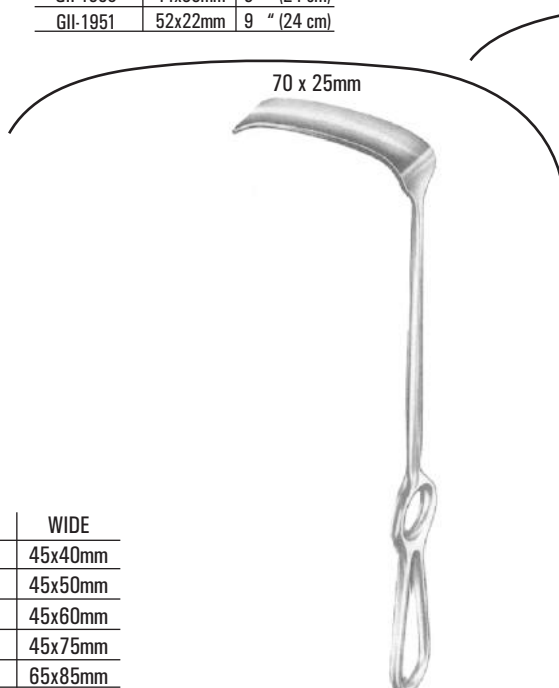

GII-1959
Kocher Retractor
8 3/4" (22.5 cm)



Kocher Retractor
9 3/4" (25 cm)

ARTICLE #	WIDE
GII-1960	80x42mm
GII-1961	80x50mm
GII-1962	80x60mm



RETRACTORS

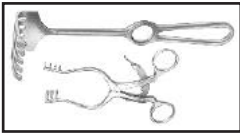

Gelpi Retractor

ARTICLE #	SIZE
GII-1963	5" (13.5 cm)
GII-1964	7" (17.5 cm)

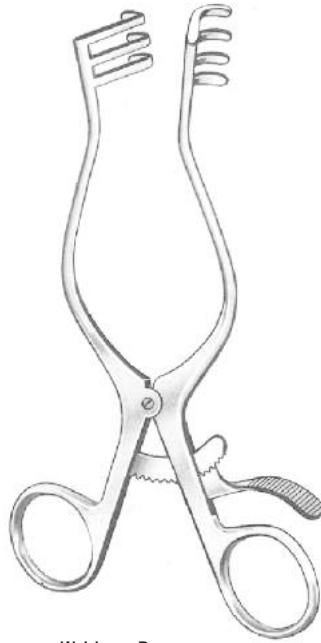

Weitlaner Retractor

Sharp	Blunt	Length	Prongs
GII-1965	GII-07S-114	4 1/4" (10 cm)	2 x 3
GII-1966	GII-07S-115	5" (13 cm)	3 x 4
GII-1967	GII-07S-116	6 1/4" (16 cm)	3 x 4
GII-1968	GII-07S-117	8" (20 cm)	3 x 4
GII-1969	GII-07S-118	9 3/4" (25 cm)	3 x 4

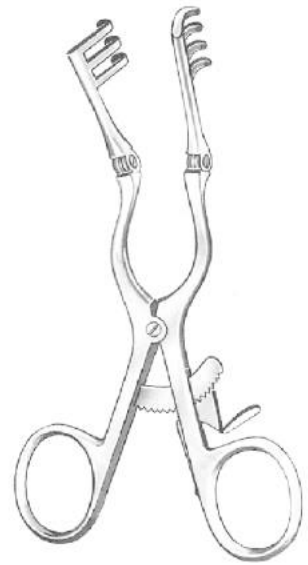

Cone Retractor

Sharp	Blunt	Length	Prongs
GII-1970	GII-07S-122	5" (13 cm)	3 x 4
GII-1971	GII-07S-123	6 1/4" (16 cm)	3 x 4
GII-1972	GII-07S-124	8" (20 cm)	3 x 4



Alm Retractor

Sharp	Blunt	Length
GII-1973	GII-1973	4" (10 cm)
GII-1974	GII-1974	2 3/4" (7 cm)



**GII-1975
Markham-Meyerding Retractor**
7" (18 cm)



**GII-1976
Miskimon Retractor**
7 1/2" (19 cm)

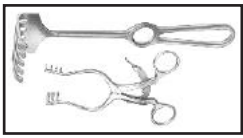

RETRACTORS

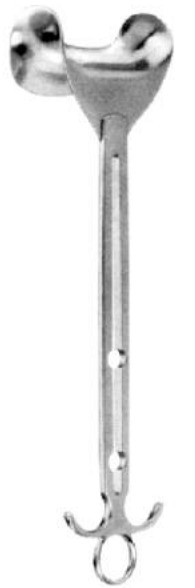
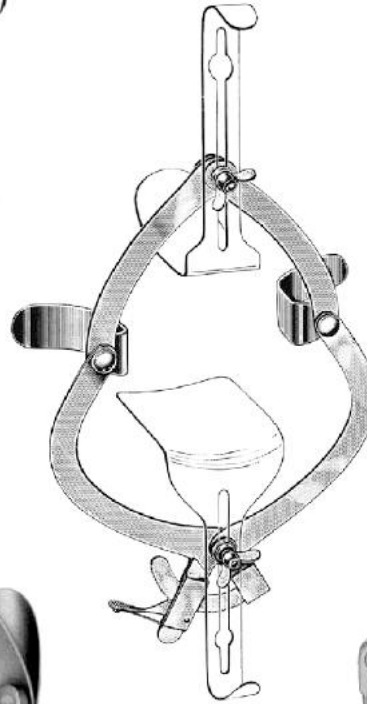
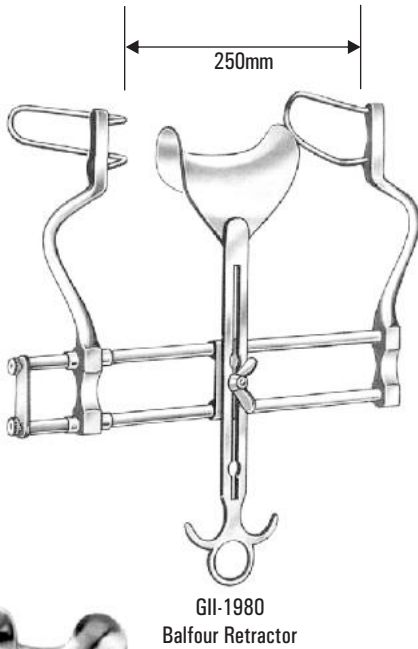
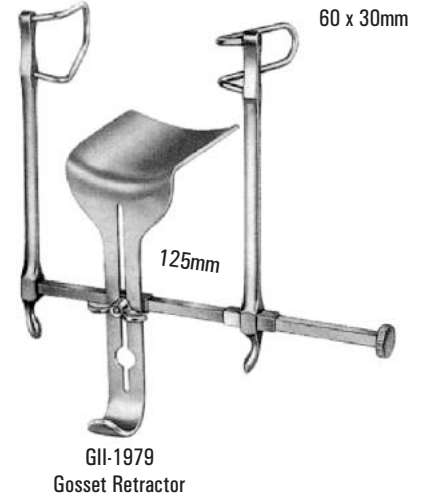
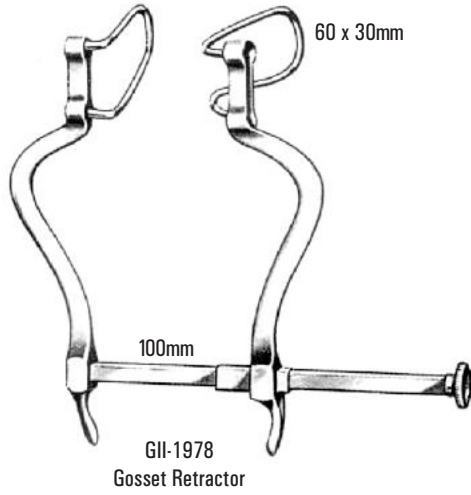
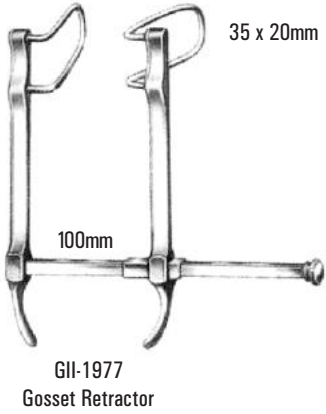

ARTICLE #	SIDE BLADE	CENTER BLADE
GII-1984	38 x 60mm	38 x 55mm
GII-1985	38 x 80mm	50 x 75mm



RETRACTORS

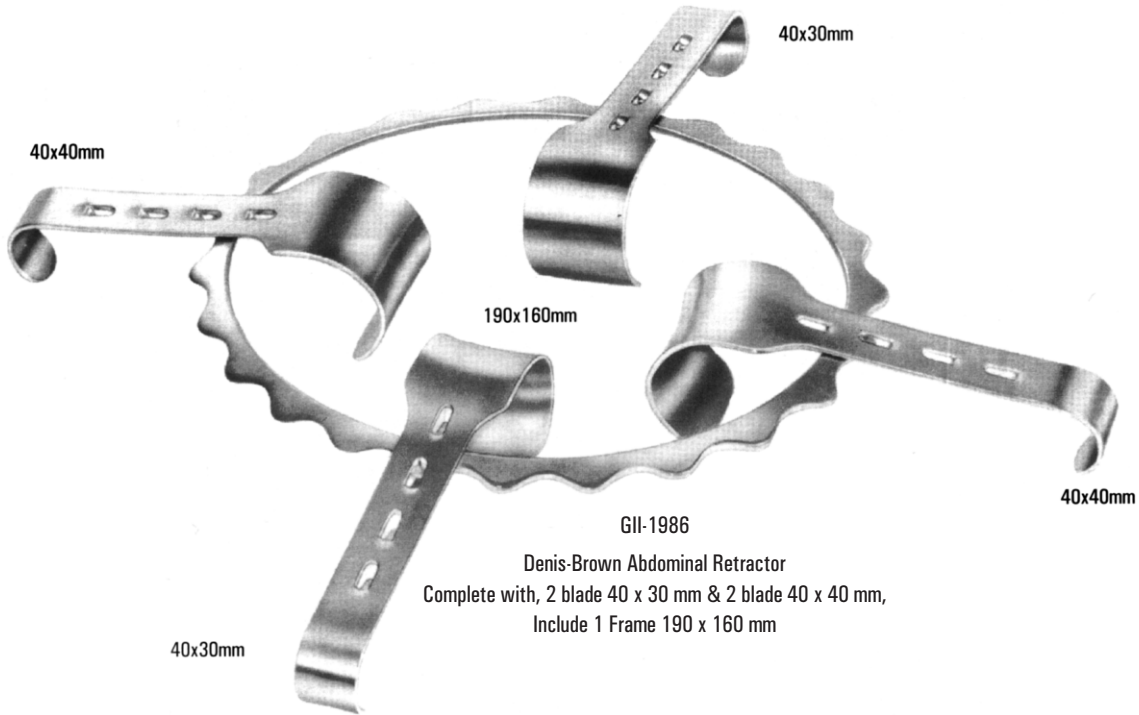
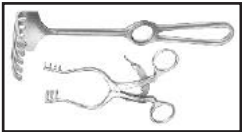

GII-1986
Denis-Brown Abdominal Retractor
Complete with, 2 blade 40 x 30 mm & 2 blade 40 x 40 mm,
Include 1 Frame 190 x 160 mm

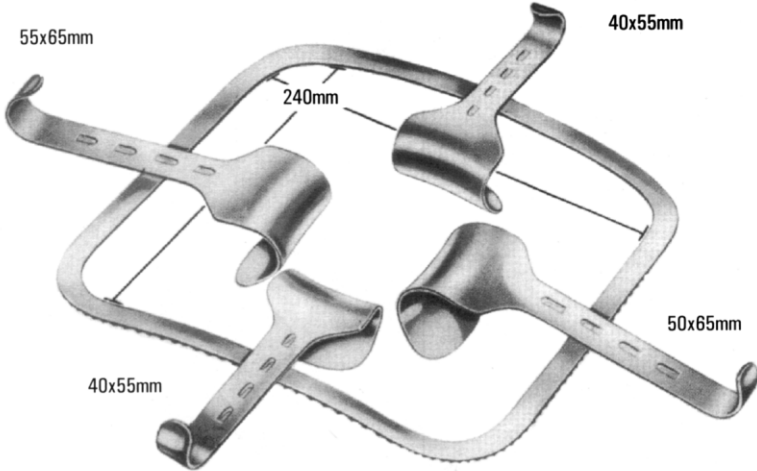

GII-1987
Kirschner Abdominal Retractor
Complete with, 2 blade 40 x 35 mm & 2 blade 50 x 65 mm,
Include 1 Frame Rigid, 240 x 240 mm

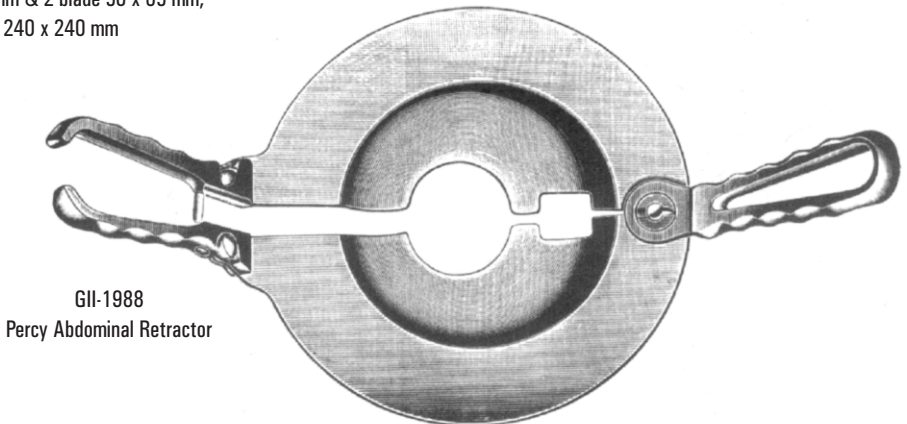

GII-1988
Percy Abdominal Retractor

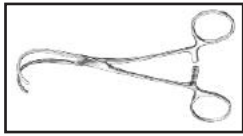

ATRAUMATIC INSTRUMENTS

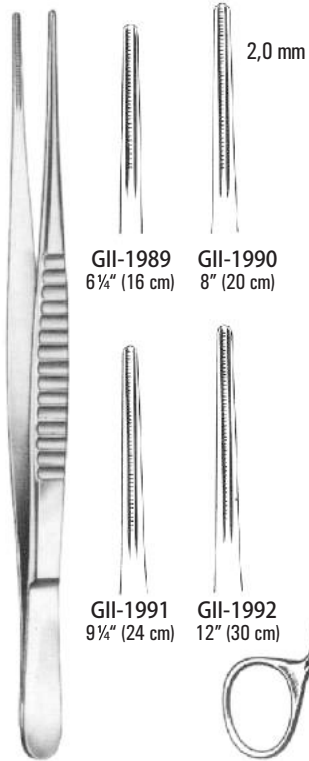

De-Bakey
Atrauma Dressing Forceps

GII-1989
6 1/4" (16 cm)

GII-1990
8" (20 cm)

GII-1991
9 1/4" (24 cm)

GII-1992
12" (30 cm)

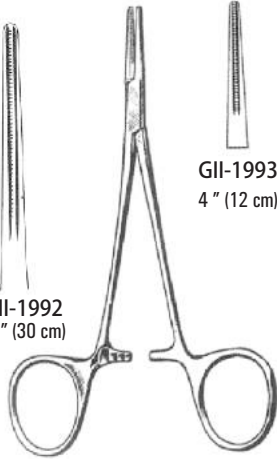

De-Bakey-Mosquito

GII-1993
4" (12 cm)

GII-1994
4" (12 cm)

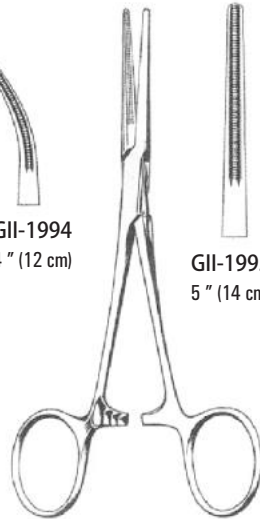

De-Bakey-Kelly

GII-1995
5" (14 cm)

GII-1996
5" (14 cm)

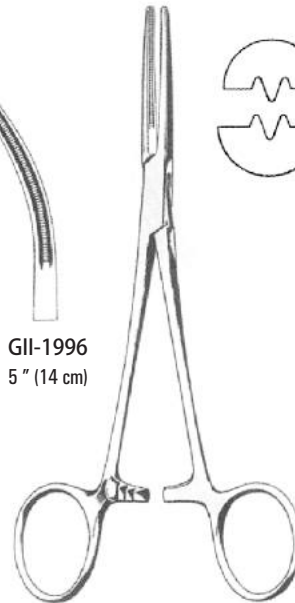

De-Bakey-Rankin

GII-1997
6 1/4" (16 cm)

GII-1998
6 1/4" (16 cm)

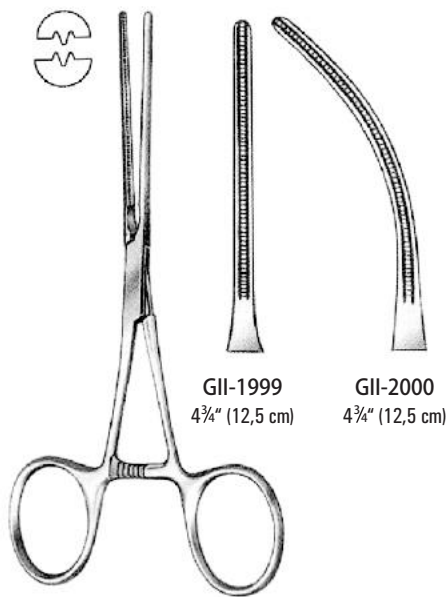

De-Bakey-Atraumatic Vascular Clamps

GII-1999
4 3/4" (12,5 cm)

GII-2000
4 3/4" (12,5 cm)

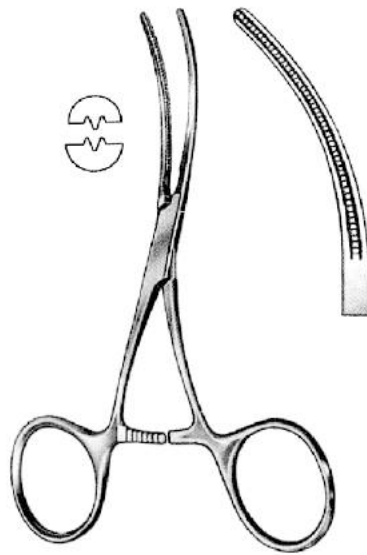

GII-2001
De-Bakey-Atraumatic Vascular Clamps
4 3/4" (12,5 cm)

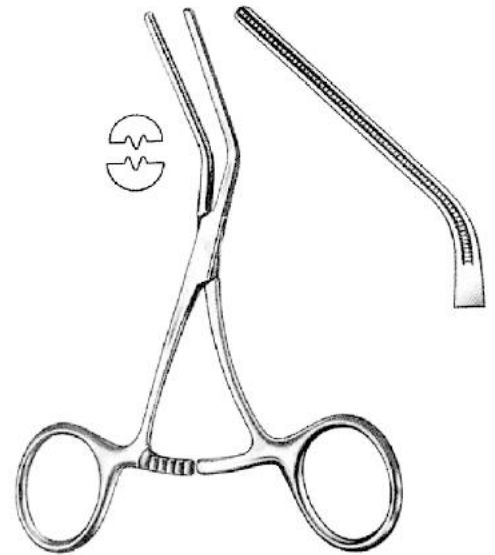

GII-2002
De-Bakey-Atraumatic Vascular Clamps
4 3/4" (12,5 cm)



ATRAUMATIC INSTRUMENTS

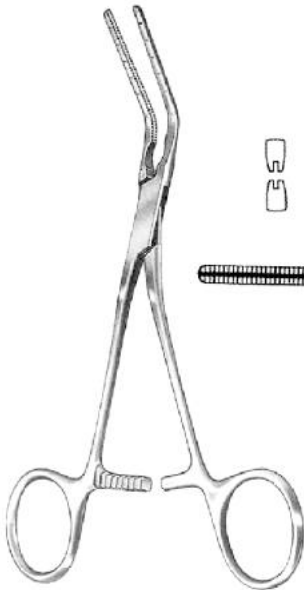
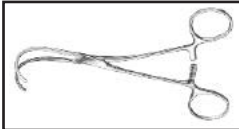

Cooley
Atraumatic Vascular Clamps

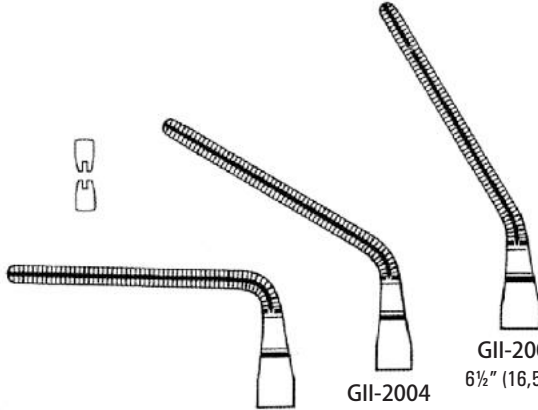

GII-2003
5 1/2" (14,5 cm)

GII-2004
6 1/4" (16 cm)

GII-2005
6 1/2" (16,5 cm)

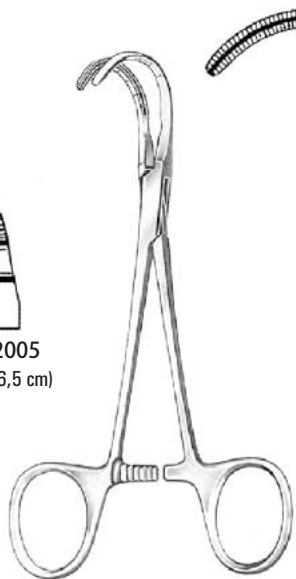

Cooley-Beck
Atraumatic Vascular Clamps

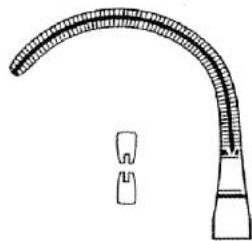

GII-2006
6 1/2" (16,5 cm)



GII-2007
6" (15 cm)

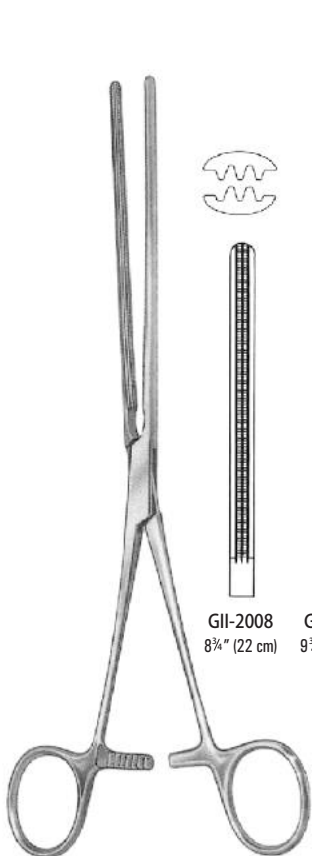

De-Bakey
Atraumatic Intestinal Clamps

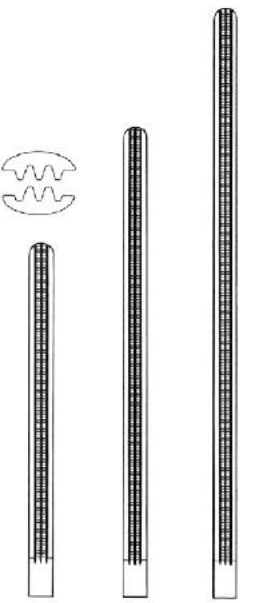

GII-2008
8 3/4" (22 cm)

GII-2009
9 3/4" (25 cm)

GII-2010
11" (28 cm)

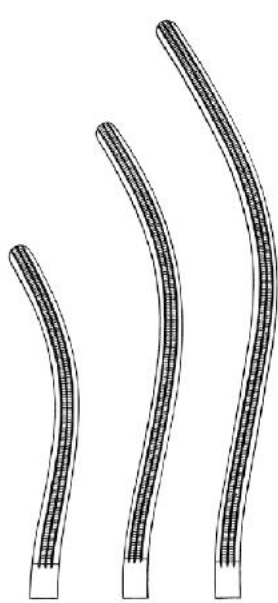

GII-2011
8 1/2" (21,5 cm)

GII-2012
9 1/2" (24,5 cm)

GII-2013
10 1/2" (27 cm)

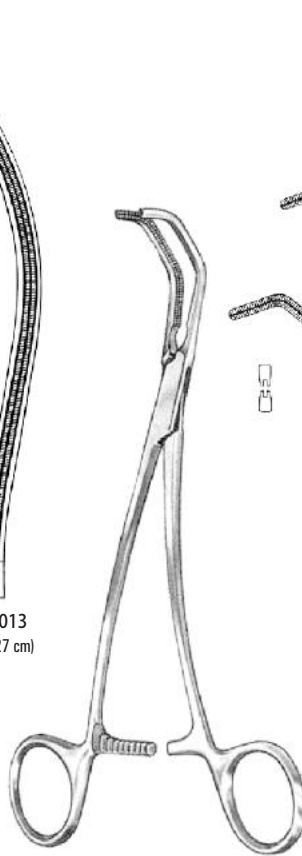

Cooley
Atraumatic Vascular Clamps

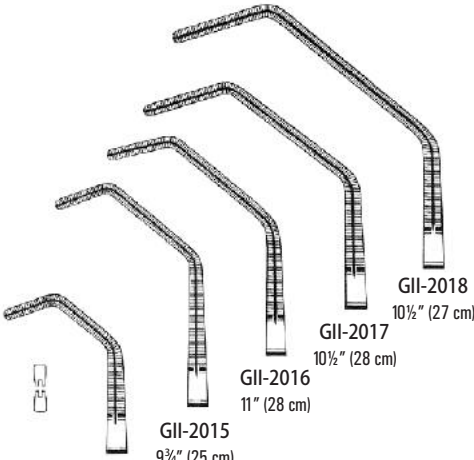

GII-2014
8" (20 cm)

GII-2015
9 3/4" (25 cm)

GII-2016
11" (28 cm)

GII-2017
10 1/2" (28 cm)

GII-2018
10 1/2" (27 cm)



GYNACOLOGICAL & OBSTETRICAL INSTRUMENTS

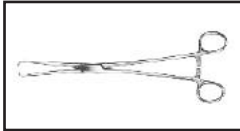

GII-2019
Pozzi Tenaculum Forceps
10" (25 cm)

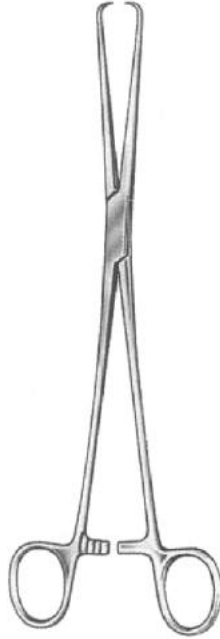

GII-2020
Schroeder Tenaculum Forceps
10" (25 cm)



GII-2021
Barrett Tenaculum Forceps
7" (18 cm)

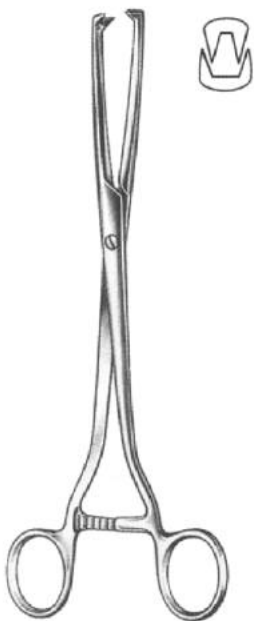

Meseux Tenaculum Forceps, Straight

ARTICLE #	SIZE	WIDE AT TIP
GII-2022	9½" (24cm)	6 mm
GII-2023	9½" (24cm)	8 mm
GII-2024	9½" (24cm)	10 mm



Meseux Curved Tenaculum Forceps

ARTICLE #	SIZE	WIDE AT TIP
GII-2025	9½" (24cm)	6 mm
GII-2026	9½" (24cm)	8 mm
GII-2027	9½" (24cm)	10 mm

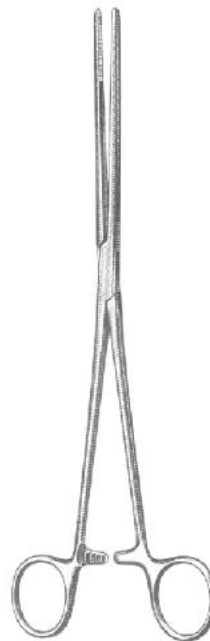

GII-2028
Bozeman Uterine Dressing Forceps
10½" (26,5 cm)



GII-2029
Bozeman Uterine Dressing Forceps
10½" (26,5 cm)

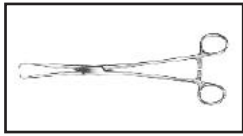

GYNACOLOGICAL & OBSTETRICAL INSTRUMENTS

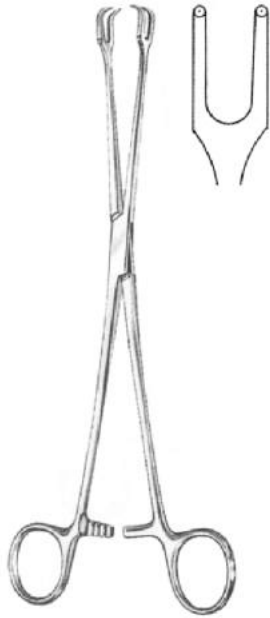

GII-2030
Schroeder 2x2 Tenaculum Forceps
9½" (24 cm)

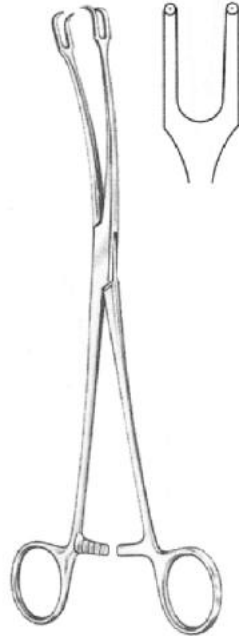

GII-2031
Schroeder 2x2 Curved
Tenaculum Forceps
9¾" (25 cm)



GII-2032
Pratt Tenaculum Forceps
10" (26 cm)



GII-2033
Jacobs Tenaculum Forceps
8¾" (21 cm)



GII-2034
Jacobs Tenaculum Forceps
8¾" (21 cm)



GII-2035
Teale Tenaculum Forceps
9" (23 cm)



GYNAECOLOGICAL & OBSTETRICAL INSTRUMENTS



Hegar Dilator, Single End

GII-2036A	Set of 14 Pcs	14 to 17 mm
GII-2036B	Set of 26 Pcs	1 to 26 mm



Hegar Dilator, Double End

GII-2037C	Set of 8 Pcs	3/4 to 17/18 mm
GII-2037D	Set of 13 Pcs	1/2 to 25/26 mm

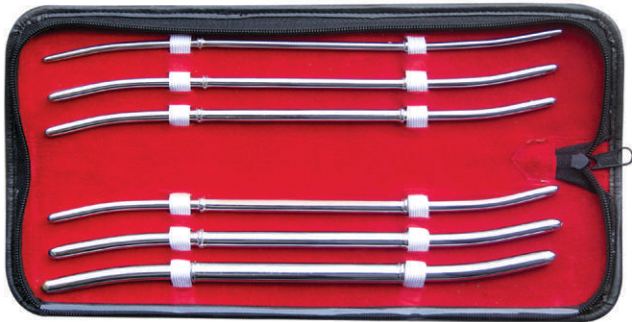

GII-2038
Hank Uterine Dilator
Set of 6 Pcs 9/10 to 19/20 FR

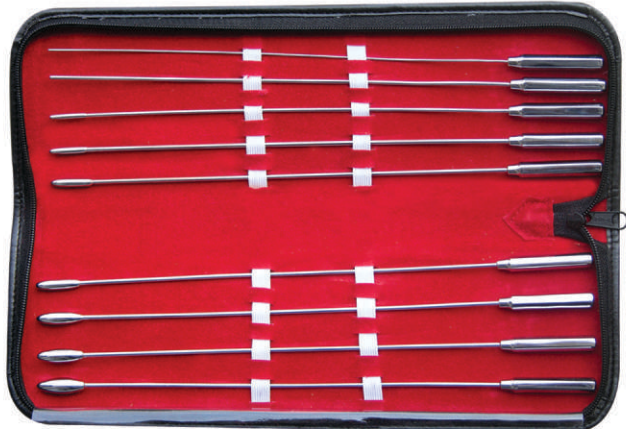

GII-2039
De-Bakey Vascular Dilator
Set of 9 Pcs, 2, 2.5, 3, 3.5, 4, 4.5, 5, 7, 9 mm

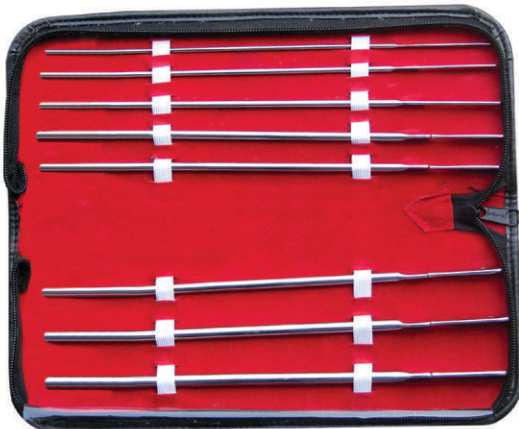

GII-2040
Dittel Sound Straight
Set of 8 Pcs, 8, 10, 12, 14, 16, 18, 20, 22 FR

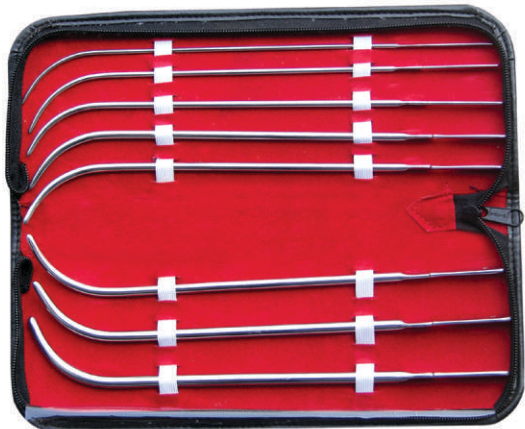

GII-2041
Van Buren Sound
Set of 8 Pcs, 8, 10, 12, 14, 16, 18, 20, 22 FR

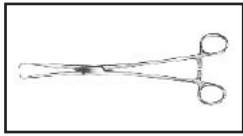

GYNACOLOGICAL & OBSTETRICAL INSTRUMENTS

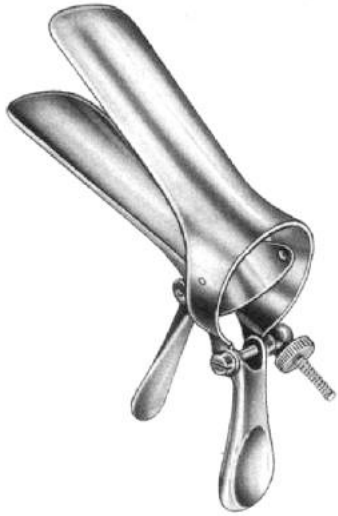

Cusco Vaginal Specula

ARTICLE #	SIZE
GII-2042	75 x 32mm
GII-2043	85 x 35mm
GII-2044	100 x 35mm
GII-2045	75 x 17mm

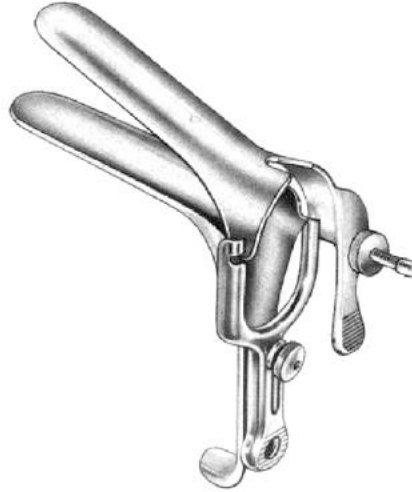

Pederson Vaginal Specula

ARTICLE #	SIZE
GII-2046	75 x 13mm
GII-2047	100 x 22mm
GII-2048	120 x 25mm

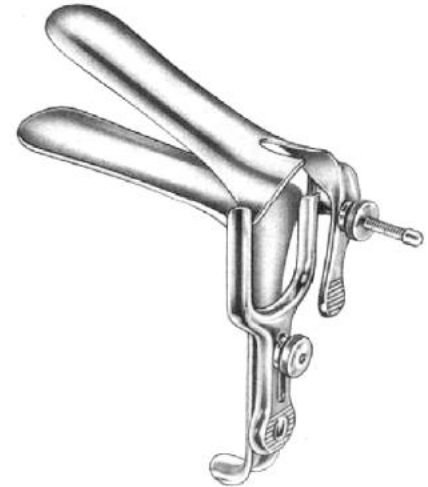

Grave Vaginal Specula

ARTICLE #	SIZE
GII-2049	75 x 20mm
GII-2050	95 x 35mm
GII-2051	115 x 35mm

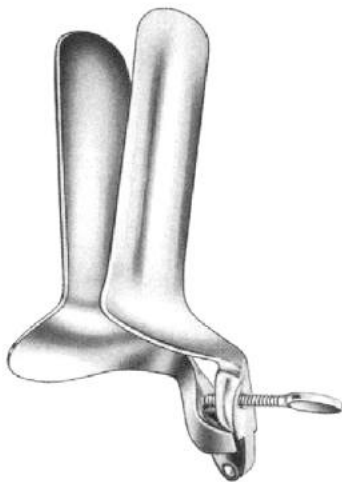

Collin Vaginal Specula

ARTICLE #	SIZE
GII-2052	85 x 30mm
GII-2053	100 x 35mm
GII-2054	110 x 40mm



Sims Vaginal Specula

ARTICLE #	SIZE
GII-2055	60 x 25/30mm
GII-2056	70 x 30/35mm
GII-2057	80 x 35/40mm



Auvarud Weighted Vaginal Specula

ARTICLE #	SIZE
GII-2058	2 lbs
GII-2059	2,5 lbs
GII-2060	3 lbs

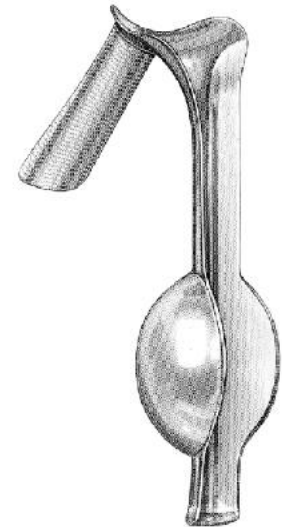

GII-2061
Weighted Vaginal Specula 2,5 lbs



GYNACOLOGICAL & OBSTETRICAL INSTRUMENTS

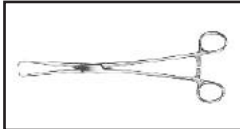

Kristeller Vaginal Specula

GII-2062	#000	70 x 27mm
GII-2063	#00	80 x 30mm
GII-2064	#0	90 x 36mm
GII-2065	#1	110 x 27mm
GII-2066	#2	110 x 30mm
GII-2067	#3	110 x 36mm



Kristeller Vaginal Specula

GII-2068	#000	75 x 23mm
GII-2069	#00	85 x 26mm
GII-2070	#0	100 x 32mm
GII-2071	#1	115 x 23mm
GII-2072	#2	115 x 26mm
GII-2073	#3	115 x 32mm



Kristeller Vaginal Specula Set

GII-2074	#000
GII-2075	#00
GII-2076	#0
GII-2077	#1
GII-2078	#2
GII-2079	#3

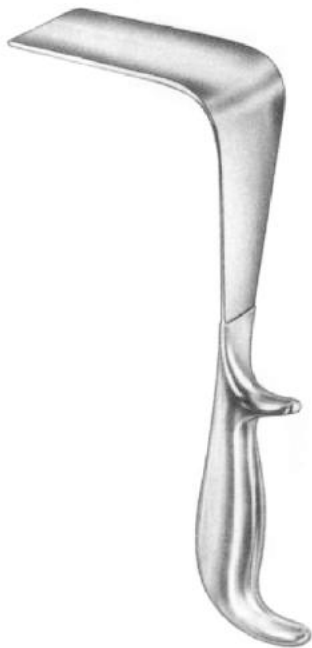

Doyen Vaginal Specula

GII-2080	55 x 35mm
GII-2081	85 x 35mm
GII-2082	115 x 35mm

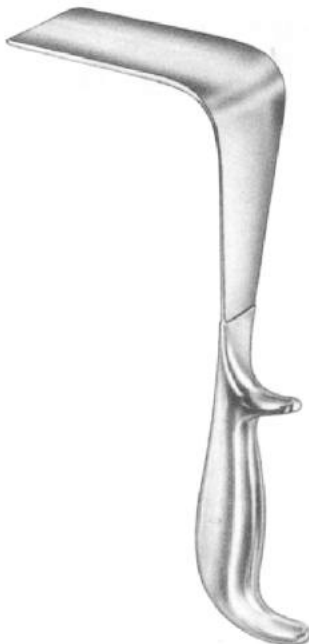

Doyen Vaginal Specula

GII-2083	55 x 45mm
GII-2084	85 x 45mm
GII-2085	115 x 45mm

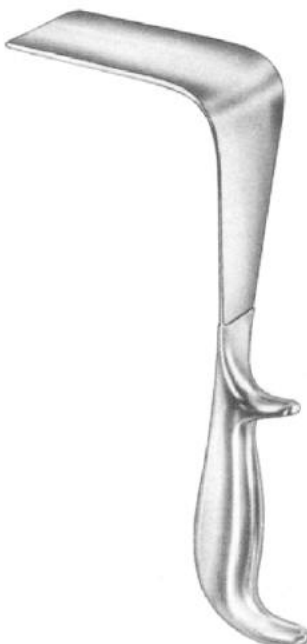

Doyen Vaginal Specula

GII-2086	55 x 60mm
GII-2087	85 x 60mm
GII-2088	115 x 60mm

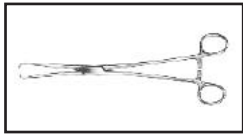

GYNACOLOGICAL & OBSTETRICAL INSTRUMENTS

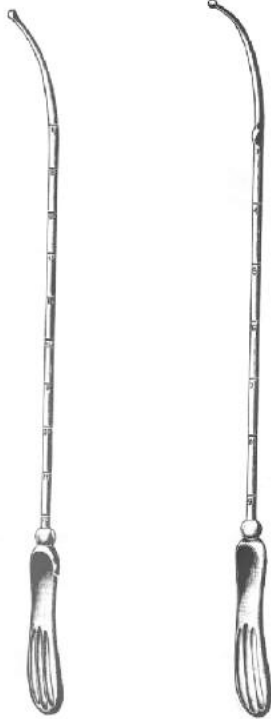

GII-2089
Sims Uterine Sound
13" (32 cm)

GII-2090
Martin Uterine Sound
13" (32 cm)

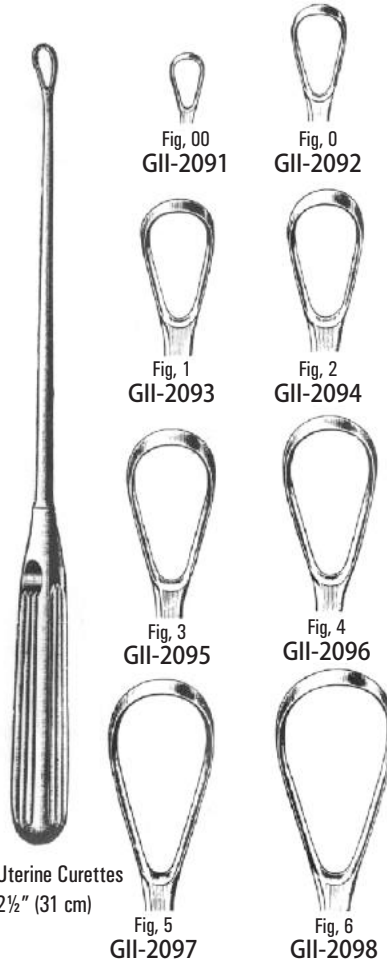

Sims Uterine Curettes
12½" (31 cm)

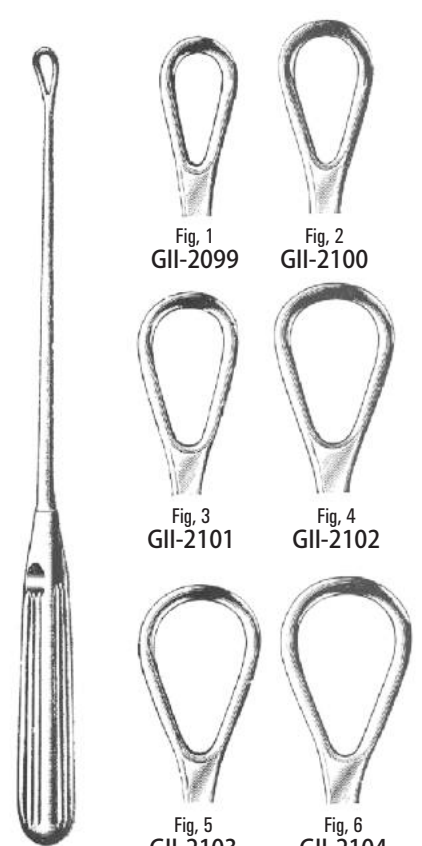

Thomas Uterine Curettes
12½" (31 cm)

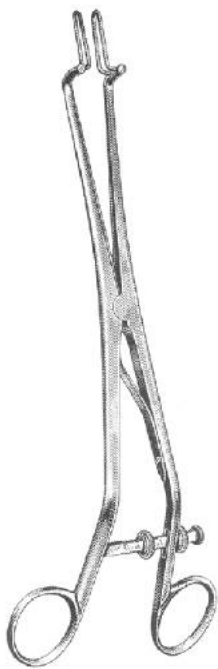

GII-2105
Kogan Endocervical Speculum
9½" (24 cm)

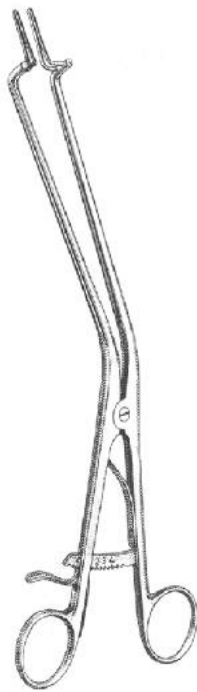

GII-2106
Kogan Endocervical Speculum
11" (28 cm)

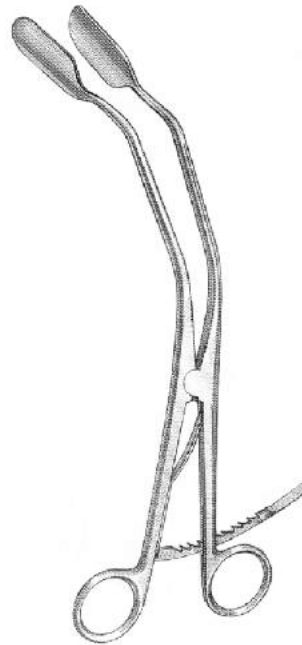

GII-2107
Leep Lateral Vaginal Retractor
8¼" (21 cm)

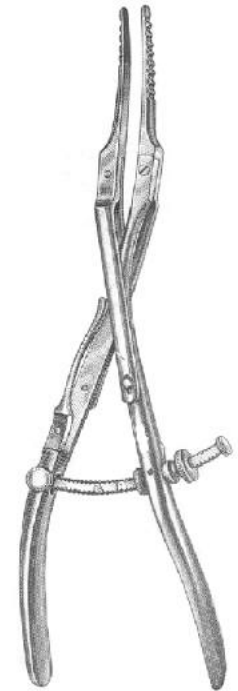

GII-2108
Goodell Uterine Dilator
10½" (26,5 cm)



GYNACOLOGICAL & OBSTETRICAL INSTRUMENTS

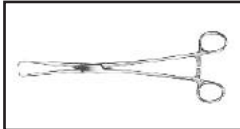

GII-2109
Gaylor Uterine Biopsy Forceps
8½" (21,5 cm)



Thomas-Gaylor Uterine Biopsy Forceps

ARTICLE #	SIZE
GII-2110	8½" (21,5 cm)
GII-2111	9½" (24 cm)

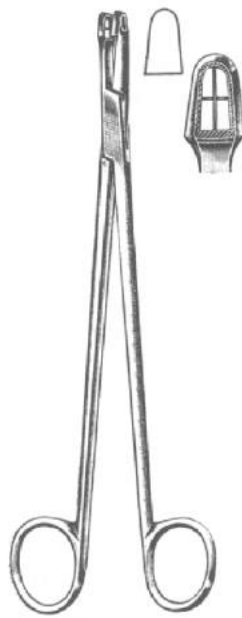

GII-2112
Schubert Uterine Biopsy Forceps
8½" (21,5 cm)



GII-2113
Schubert Uterine Biopsy Forceps
8½" (21,5 cm)

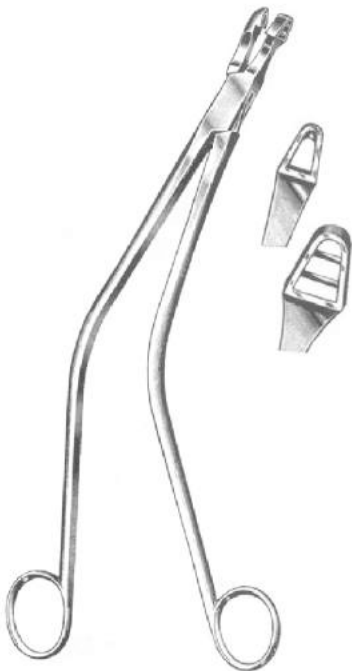

GII-2114
Schubert Uterine Biopsy Forceps
11" (28 cm)

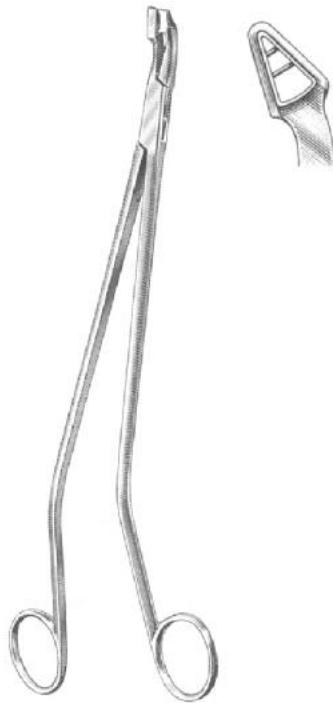

GII-2115
Schubert Uterine Biopsy Forceps
11" (28 cm)

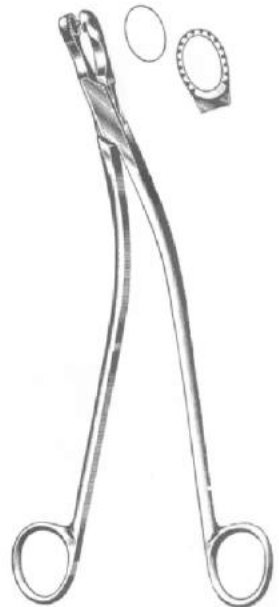

GII-2116
Gellborn Uterine Biopsy Forceps
9½" (24 cm)

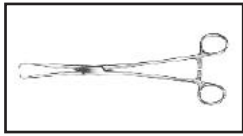

GYNACOLOGICAL & OBSTETRICAL INSTRUMENTS



|----- SHAFT -----|

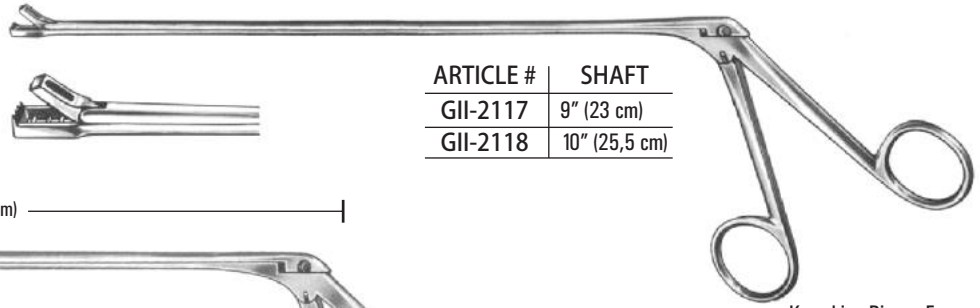

ARTICLE #	SHAFT
GII-2117	9" (23 cm)
GII-2118	10" (25,5 cm)

Kevorkian Biopsy Forceps

|----- 9 1/2" (24 cm) -----|



Schumacher Biopsy Forceps
9 1/2" (24 cm)



GII-2119
Fig. 1
5 mm

GII-2120
Fig. 2
7 mm

|----- SHAFT -----|

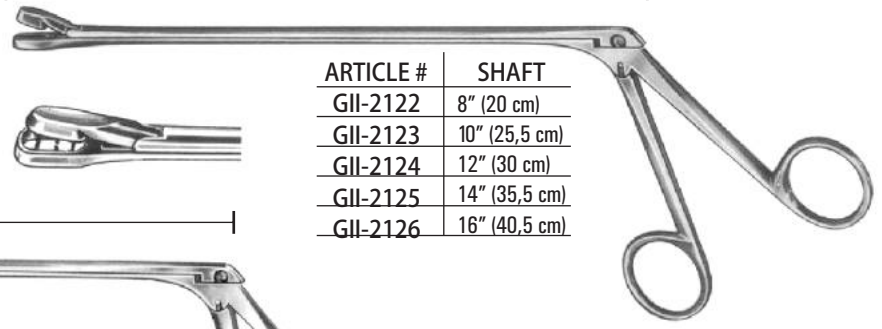

ARTICLE #	SHAFT
GII-2122	8" (20 cm)
GII-2123	10" (25,5 cm)
GII-2124	12" (30 cm)
GII-2125	14" (35,5 cm)
GII-2126	16" (40,5 cm)

Doyen Biopsy Forceps

|----- 9" (23 cm) -----|

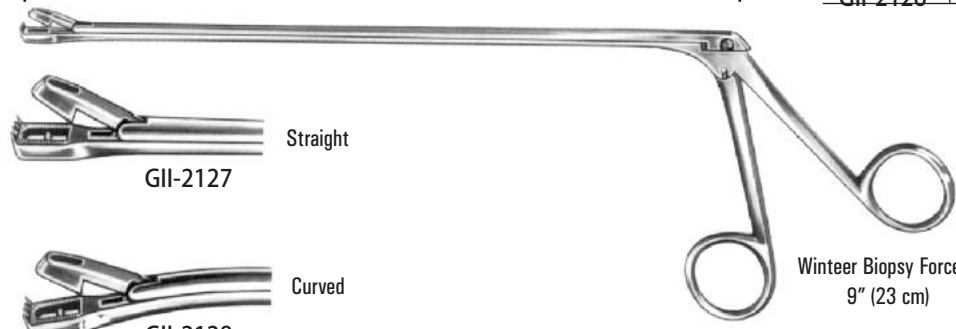

Winteer Biopsy Forceps
9" (23 cm)

Straight
GII-2127

Curved
GII-2128

|----- SHAFT -----|

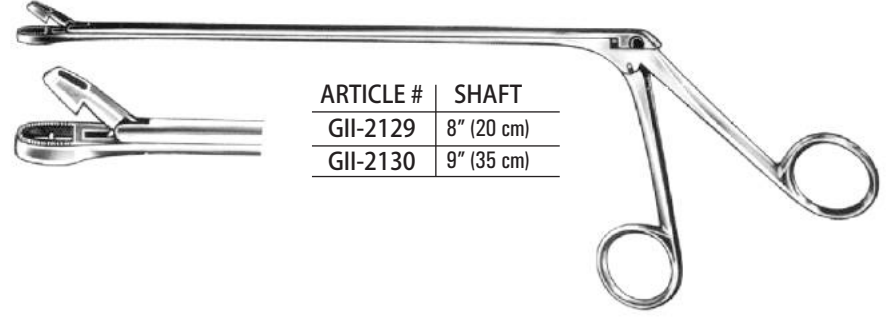

ARTICLE #	SHAFT
GII-2129	8" (20 cm)
GII-2130	9" (35 cm)

Eppendorf Biopsy Forceps



GYNACOLOGICAL & OBSTETRICAL INSTRUMENTS

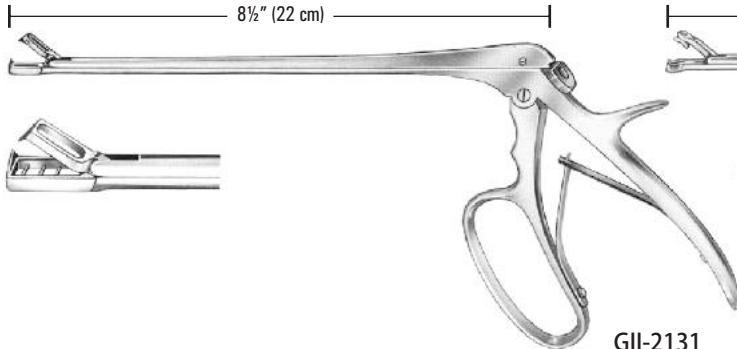
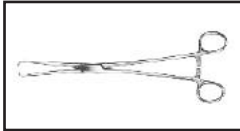

GII-2131
Tischler-Kevrokian Biopsy Forceps

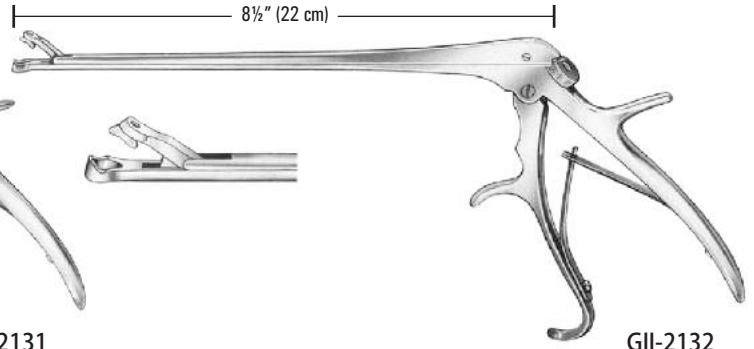

GII-2132
Burke Biopsy Forceps

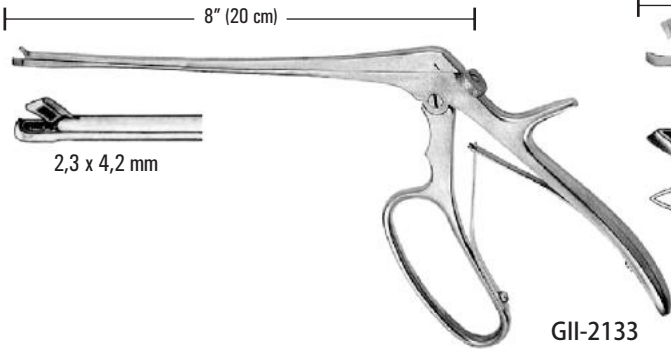

GII-2133
Baby-Tischler Biopsy Forceps

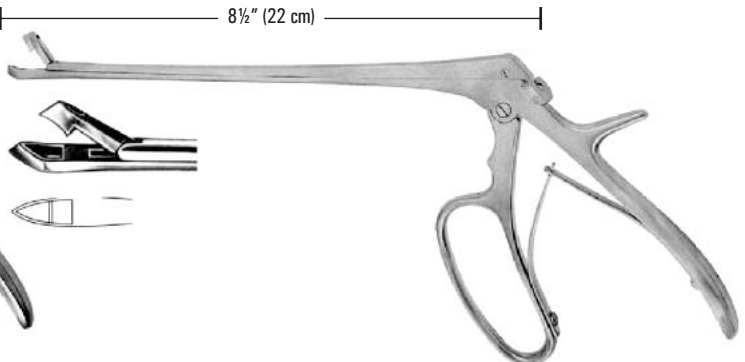

GII-2134
Tischler Biopsy Forceps

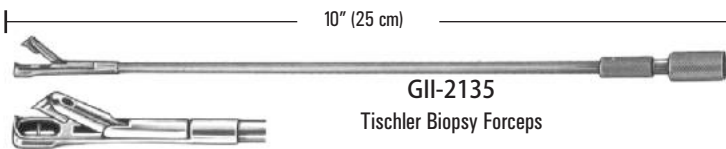

GII-2135
Tischler Biopsy Forceps

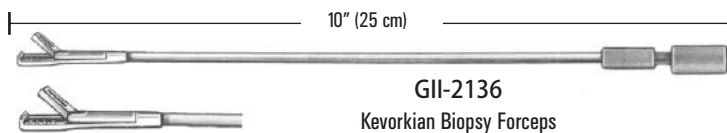

GII-2136
Kevorkian Biopsy Forceps

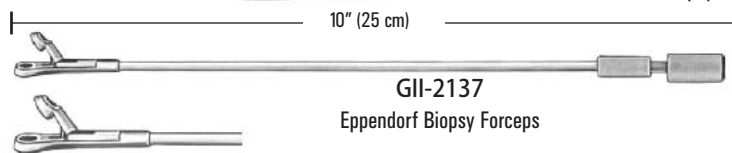

GII-2137
Eppendorf Biopsy Forceps



GII-2138
Mini-Townsend Biopsy Forceps



GII-2139
Handle

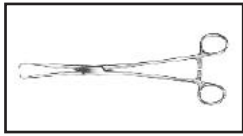

GYNACOLOGICAL & OBSTETRICAL INSTRUMENTS

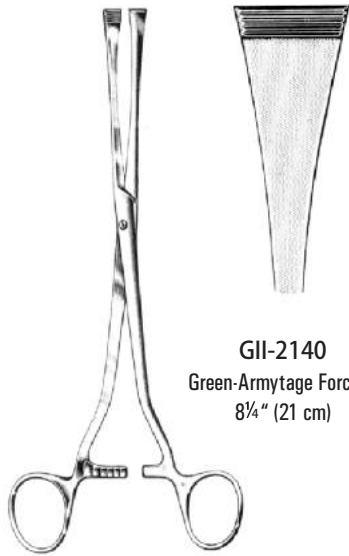

GII-2140
Green-Armytage Forceps
8 1/4" (21 cm)



GII-2141
Sellhein Forceps
11" (28 cm)

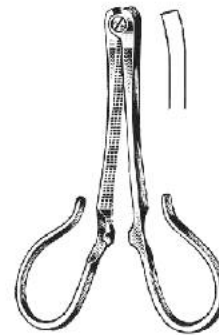

GII-2142
Kane Clamps
3 1/2" (8,5cm)

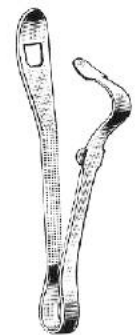

GII-2143
Collin Clamps
3 1/2" (9 cm)



GII-2144
Straight

GII-2145
Curved

Saenger Forceps
10 1/2" (27 cm)

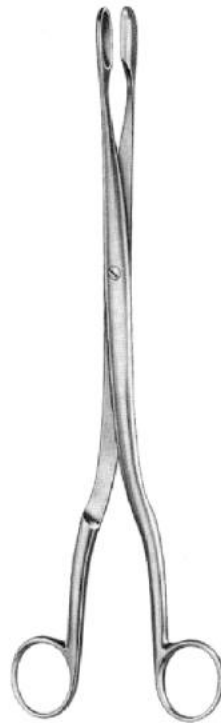

Winter Forceps
11" (28 cm)
GII-2146

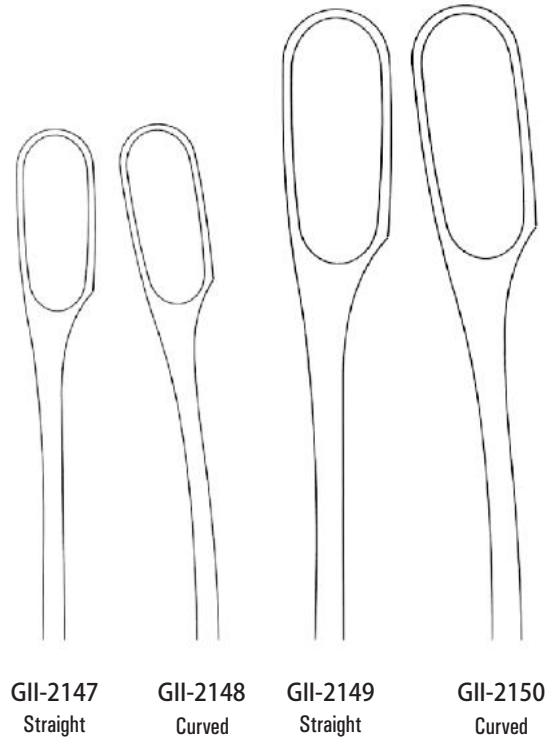

GII-2147
Straight

GII-2148
Curved

GII-2149
Straight

GII-2150
Curved



GYNACOLOGICAL & OBSTETRICAL INSTRUMENTS



GII-2151

GII-2151
Martin Pelvineter
13½" (34 cm)



Cuzzi Spoon
12" (30 cm)



14½mm



GII-2153

18mm

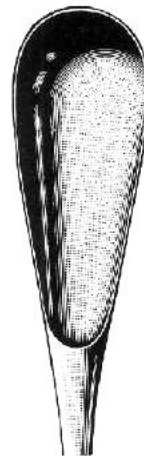

GII-2154

20mm

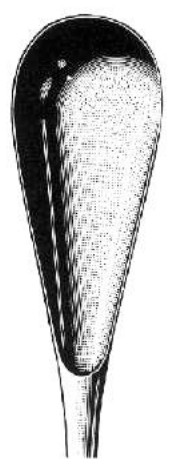

GII-2155

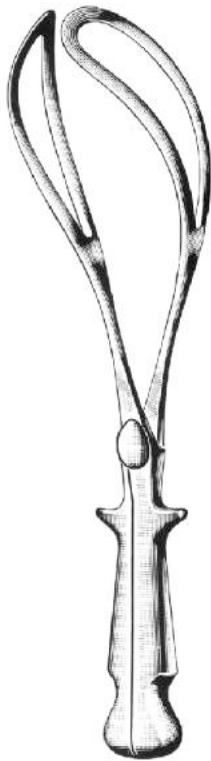

Naegele Obstetrical Forceps

GII-2156	14" (36 cm)
GII-2157	16" (40 cm)

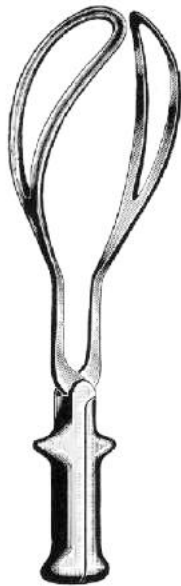

GII-2158
Simpson Obstetrical Forceps
12" (30 cm)

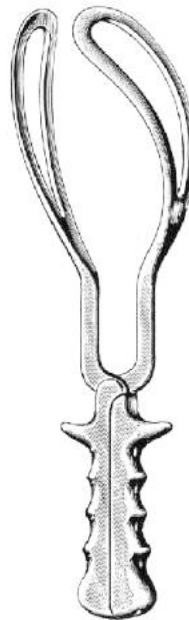

GII-2159
Simpson-Braun Obstetrical Forceps
14" (36 cm)

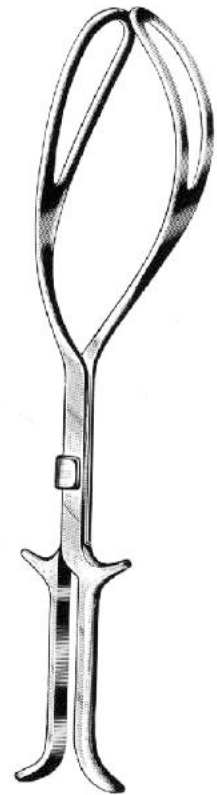

GII-2160
Kielland Obstetrical Forceps
16" (41 cm)

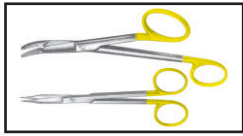

TUNGSTEN CARBIDE INSTRUMENTS (T.C)

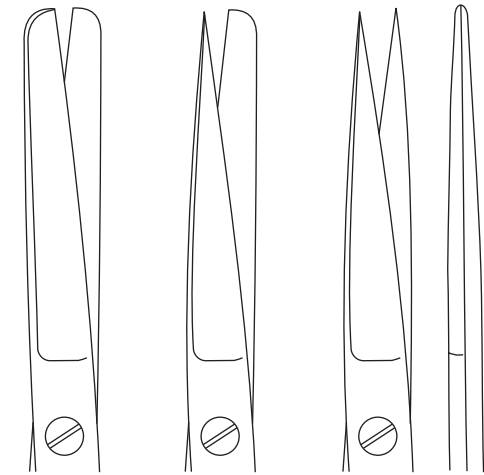

GII-5000
5½" (14,5 cm)

GII-5001
5½" (14,5 cm)

GII-5002
5½" (14,5 cm)

Dressing Scissors, Straight T.C

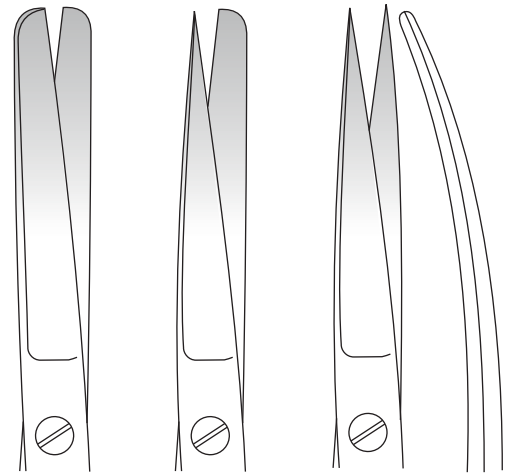

GII-5003
5½" (14,5 cm)

GII-5004
5½" (14,5 cm)

GII-5005
5½" (14,5 cm)

Dressing Scissors, Curved T.C

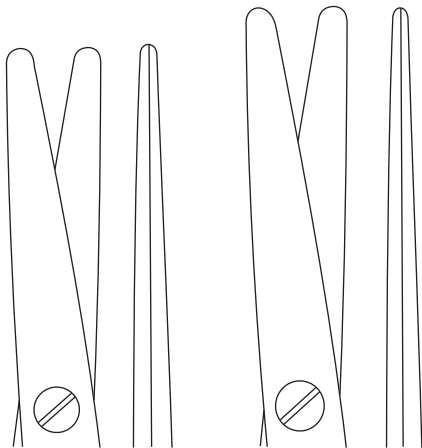

GII-5006
6" (15 cm)

GII-5007
7" (17 cm)

Mayo Stille Scissors, Straight T.C

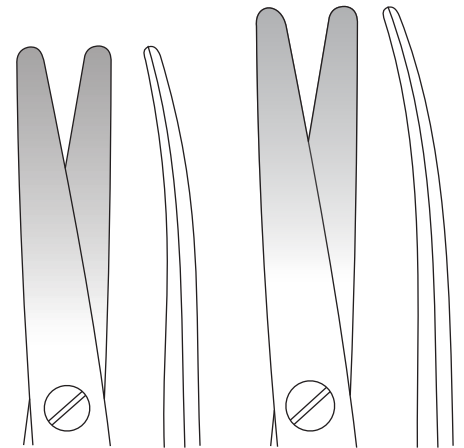

GII-5008
6" (15 cm)

GII-5009
7" (17 cm)

Mayo Stille Scissors, Curved T.C



TUNGSTEN CARBIDE INSTRUMENTS (T.C)



Mayo Scissors, Straight T.C

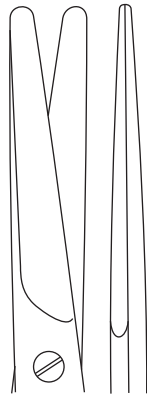

GII-5010
5½" (14 cm)

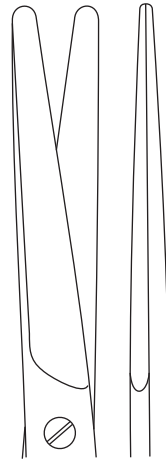

GII-5011
7" (17 cm)

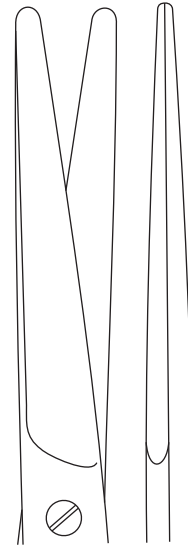

GII-5012
9" (23 cm)



Mayo Scissors, Curved T.C



GII-5013
5½" (14 cm)



GII-5014
7" (17 cm)



GII-5015
9" (23 cm)

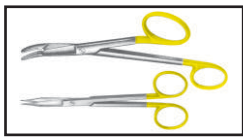

TUNGSTEN CARBIDE INSTRUMENTS (T.C)



Metzenbaum Scissors
Straight T.C

GII-5016 5½" (14 cm)	GII-5017 7" (18 cm)	GII-5018 8" (20 cm)	GII-5019 9" (23 cm)	GII-5020 10" (25 cm)	GII-5021 11" (28 cm)	GII-5022 12" (30 cm)	GII-5022 12" (30 cm)



Metzenbaum Scissors
Curved T.C

GII-5027 5½" (14 cm)	GII-5028 7" (18 cm)	GII-5027 8" (20 cm)	GII-5026 9" (23 cm)	GII-5027 10" (25 cm)	GII-5027 11" (28 cm)	GII-5028 11" (28 cm)	GII-5029 12" (30 cm)



TUNGSTEN CARBIDE INSTRUMENTS (T.C)



Iris Scissors T.C

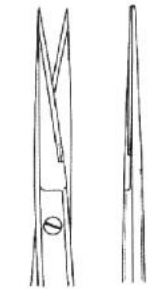

GII-5030
4½" (11 cm)

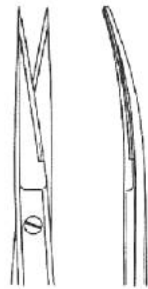

GII-5031
4½" (11 cm)

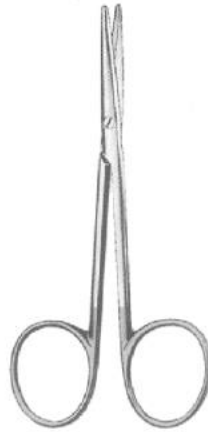

Strabismus Scissors T.C



GII-5032
4½" (11 cm)



GII-5033
4½" (11 cm)



Potts Smith Scissors T.C



GII-5034
7½" (19 cm)

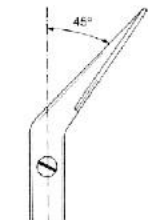

GII-5035
7½" (19 cm)

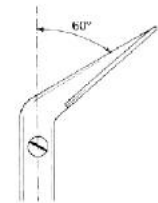

GII-5036
7½" (19 cm)

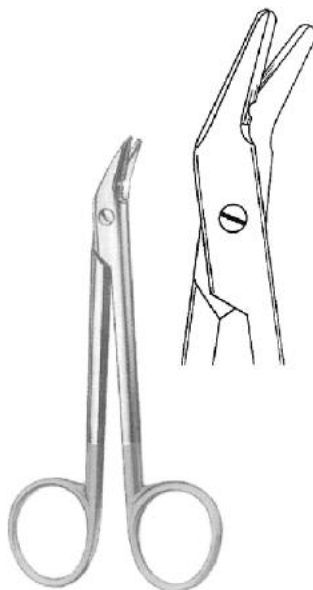

GII-5037
Wire Cutter Universal T.C
4¾" (12 cm)

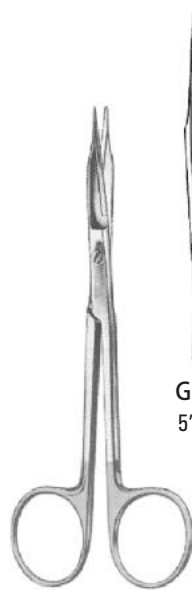

Tenotomy Scissors T.C



GII-5038
5" (13 cm)

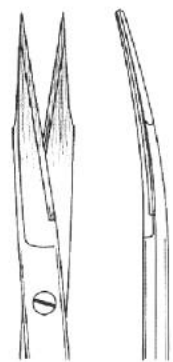

GII-5039
5" (13 cm)

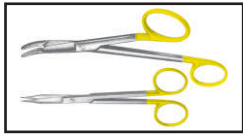

TUNGSTEN CARBIDE INSTRUMENTS (T.C)

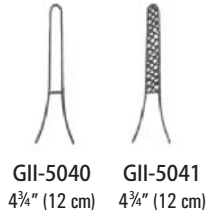

Adson Forceps T.C

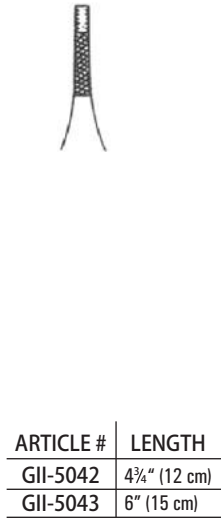

Adson-Brown T.C

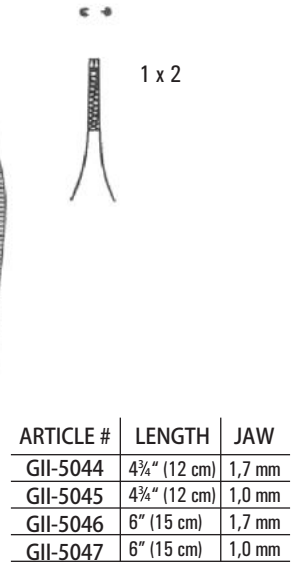
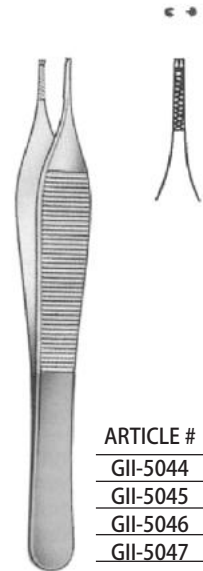

Micro-Adson T.C



Wangensteen Forceps T.C

ARTICLE #	LENGTH
GII-5048	6" (15 cm)
GII-5049	9" (23 cm)
GII-5050	9¾" (25 cm)



GII-5051
McIndoe Forceps T.C
6" (15 cm)



Bayonet Forceps T.C

ARTICLE #	LENGTH
GII-5052	5½" (14 cm)
GII-5053	6½" (16 cm)



TUNGSTEN CARBIDE INSTRUMENTS (T.C)

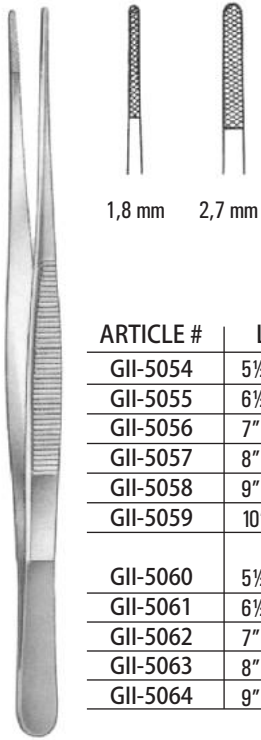

1,8 mm 2,7 mm

ARTICLE #	LENGTH	JAW
GII-5054	5½" (14,5 cm)	1,8 mm
GII-5055	6½" (16 cm)	1,8 mm
GII-5056	7" (18 cm)	1,8 mm
GII-5057	8" (20 cm)	1,8 mm
GII-5058	9" (23 cm)	1,8 mm
GII-5059	10" (25 cm)	1,8 mm
GII-5060	5½" (14,5 cm)	2,7 mm
GII-5061	6½" (16 cm)	2,7 mm
GII-5062	7" (18 cm)	2,7 mm
GII-5063	8" (20 cm)	2,7 mm
GII-5064	9" (23 cm)	2,7 mm

Dressing Forceps T.C



1,8 mm

With Dissector:

ARTICLE #	LENGTH
GII-5065	7" (18 cm)
GII-5066	8¾" (21 cm)
GII-5067	9" (23cm)
GII-5068	10" (25 cm)

Potts-Smith Dressing Forceps T.C

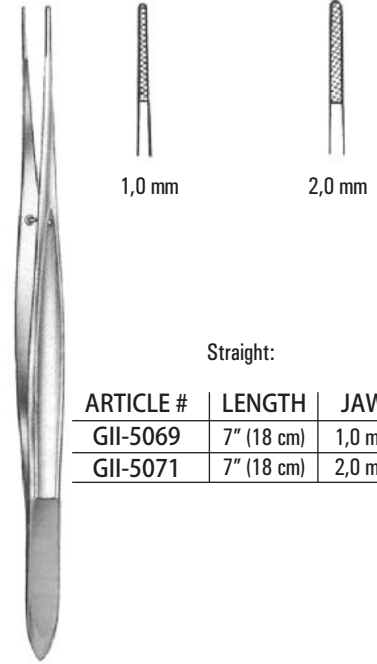

1,0 mm 2,0 mm

Straight:

ARTICLE #	LENGTH	JAW
GII-5069	7" (18 cm)	1,0 mm
GII-5071	7" (18 cm)	2,0 mm

Cushing Dressing Forceps T.C

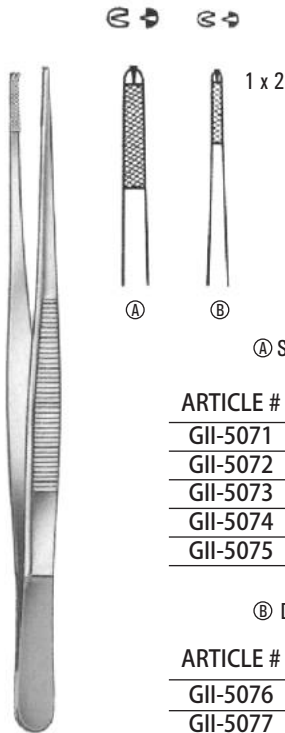

1 x 2

Ⓐ Standard:

ARTICLE #	LENGTH
GII-5071	5½" (14,5 cm)
GII-5072	6½" (16 cm)
GII-5073	7" (18 cm)
GII-5074	8" (20 cm)
GII-5075	10" (25 cm)

Ⓑ Delicate:

ARTICLE #	LENGTH
GII-5076	5½" (14,5 cm)
GII-5077	6½" (16 cm)
GII-5078	7" (18 cm)
GII-5079	8" (20 cm)
GII-5080	10" (25 cm)

Dehler Tissue Forceps T.C

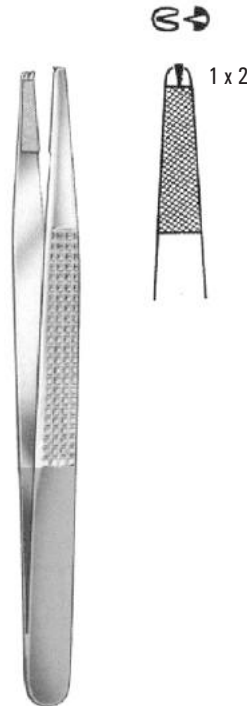

1 x 2

GII-5081 Bonney Tissue Forceps T.C
6¾" (17 cm)

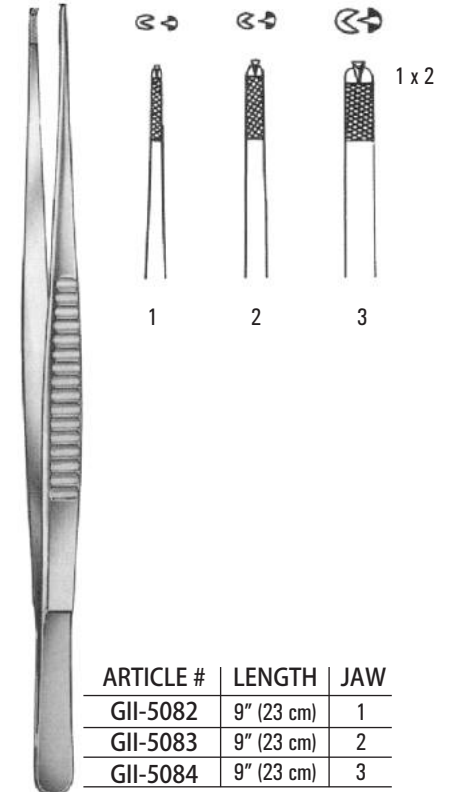

1 x 2

ARTICLE #	LENGTH	JAW
GII-5082	9" (23 cm)	1
GII-5083	9" (23 cm)	2
GII-5084	9" (23 cm)	3

Skinner Tissue Forceps T.C

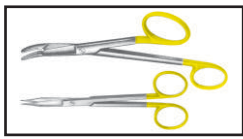

TUNGSTEN CARBIDE INSTRUMENTS (T.C)

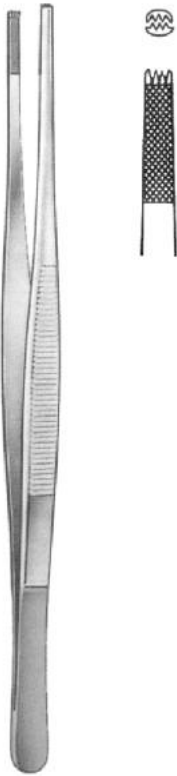

GII-5085
Williams Tissue Forceps T.C
8" (20 cm)



GII-5086
Mod. USA, Dressing Forceps T.C
8" (15 cm)

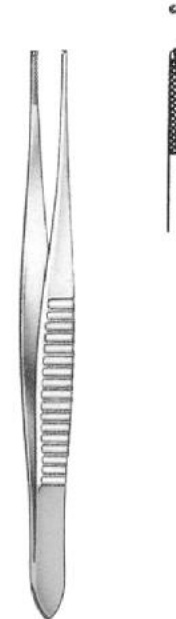

GII-5087
Gillies Tissue Forceps T.C
6" (15 cm)



GII-5088
Gerald Dressing Forceps T.C
7" (18 cm)

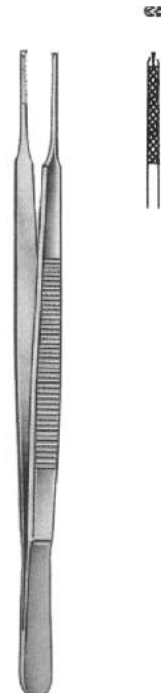

GII-5089
Gerald Tissue Forceps T.C
7" (18 cm)

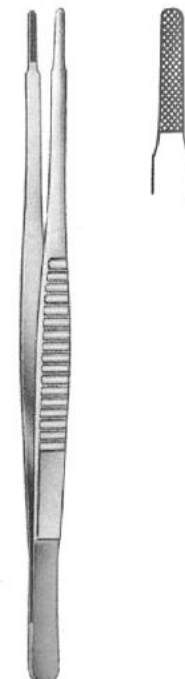

GII-5090
Evans Tissue Forceps T.C
9¾" (25 cm)



TUNGSTEN CARBIDE INSTRUMENTS (T.C)



GII-5091 Derf Needle Holder T.C 4 3/4" (12 cm)	GII-5092 Halsey Needle Holder T.C 5" (13 cm)	GII-5093 Webster Needle Holder T.C 5" (13 cm)	GII-5095 5" (13 cm) GII-5096 5 1/2" (14 cm)

GII-5097 Mayo-Hegar Needle Holder T.C 5 1/2" (14 cm)	GII-5098 6 1/4" (16 cm)	GII-5099 7" (18 cm)	GII-5100 8" (20 cm)		GII-5101 Crile-Wood Needle Holder T.C 10" (26 cm)	GII-5102 7" (18 cm)	GII-5103 8" (20 cm)	GII-5104 9" (23 cm)	
	GII-5105 9 1/2" (24 cm)	GII-5106 10" (26 cm)	GII-5107 12" (30 cm)			GII-5108 10" (26 cm)	GII-5109 12" (30 cm)		

GII-5110 De-Bakey Needle Holder T.C 7" (18 cm)	GII-5111 8" (20 cm)	GII-5112 9" (23 cm)		GII-5113 Intracardiac Needle Holder T.C 7" (18 cm)	GII-5114 8" (20 cm)		GII-5117 Olsen-Hegar Needle Holder T.C 5 1/2" (14 cm)	GII-5118 6 1/2" (16,5 cm)	GII-5119 7" (18 cm)	
	GII-5115 10" (26 cm)	GII-5116 12" (30 cm)			GII-5115 9" (23 cm)	GII-5116 10" (26 cm)				

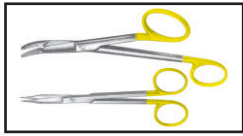

TUNGSTEN CARBIDE INSTRUMENTS (T.C)



GII-2120
Gillies Needle Holder T.C
6½" (16 cm)

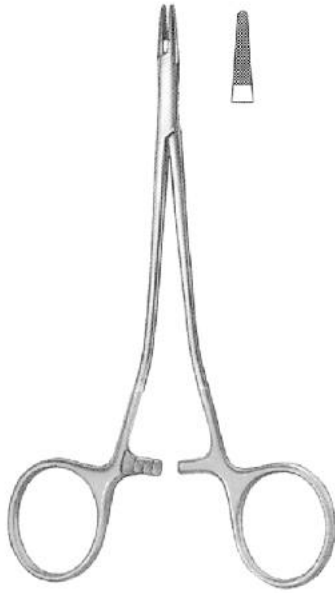

GII-2121
Swedish Needle Holder T.C
5½" (14,5 cm)



GII-2122
Neivert Needle Holder T.C
5" (13 cm)



GII-2123
Tonnies Needle Holder T.C
7½" (19 cm)



Mathieu Needle Holder T.C



GII-2124
5½" (14 cm)



GII-2125
6¾" (17 cm)



GII-2126
8" (20 cm)



Mathieu Needle Holder T.C



GII-2127
6¾" (17 cm)



GII-2128
8" (20 cm)



GII-2129
9" (23 cm)



GII-2130
Zweifel Needle Holder T.C
8" (20 cm)



TUNGSTEN CARBIDE INSTRUMENTS (T.C)



GII-5131
5½" (14 cm)



GII-5132
5½" (14 cm)



GII-5133
5½" (14 cm)



GII-5134
5½" (14 cm)



GII-5135
7" (18 cm)



GII-5136
7" (18 cm)



GII-5137
7" (18 cm)



GII-5138
7" (18 cm)



GII-5139
Kalt Needle Holder T.C
5¼" (13,5 cm)

Castroviejo
Needle Holder T.C

Castroviejo
Needle Holder T.C

Castroviejo
Needle Holder T.C

Castroviejo
Needle Holder T.C



GII-5140
Castroviejo Blade Breaker
5¼" (13 cm)



GII-5141
Potts-Smith Blade Breaker
8¾" (22 cm)

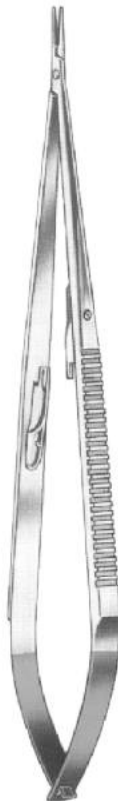

GII-5142
Jacobson Needle Holder T.C

GII-515-145
8¾" (21 cm)



GII-515-146
8¾" (21 cm)

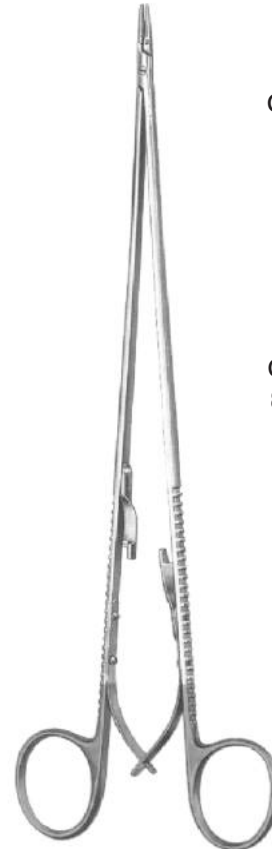

Diethrich Needle Holder T.C

GII-15S-147
6¾" (16 cm)

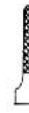

GII-15S-148
7" (18 cm)



GII-5143
8" (20 cm)



GII-5144
9" (23 cm)



GII-5145
10¼" (26 cm)



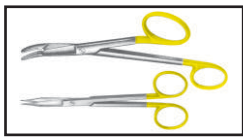

TUNGSTEN CARBIDE INSTRUMENTS (T.C)



GII-5146 6½" (16 cm)	GII-5147 6½" (16 cm)
GII-5148 7" (18 cm)	GII-5149 7" (18 cm)

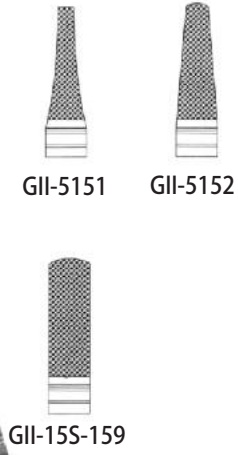

Wire Twisting Forceps

GII-5150
Wire Holding Plier
7" (18 cm)

Flat Nose Plier
7" (18 cm)

GII-5153
Wire Cutting Plier
5½" (14 cm)

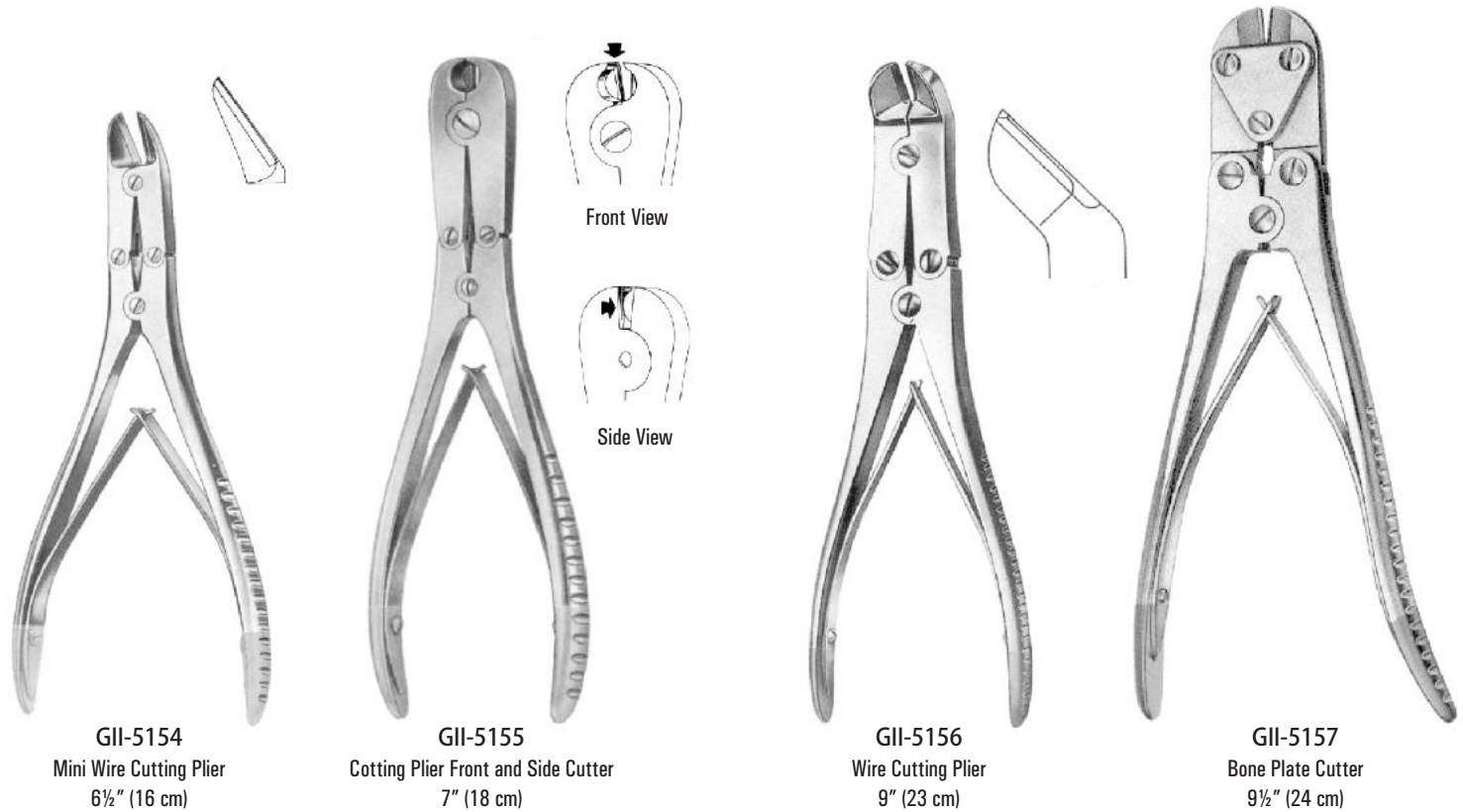

GII-5154
Mini Wire Cutting Plier
6½" (16 cm)

GII-5155
Cotting Plier Front and Side Cutter
7" (18 cm)

GII-5156
Wire Cutting Plier
9" (23 cm)

GII-5157
Bone Plate Cutter
9½" (24 cm)



BONE SURGERY INSTRUMENTS



GII-7000
Bone Hand Drills
5½" (14 cm)



GII-7001
Bone Hand Drills
5½" (14 cm)



GII-7002
Moore Hand Drills



GII-7003
9 cm
Ø 3,2mm



GII-7004
7 cm
Ø 3,2mm



GII-7005
Hudson Bone Hand Drills
10" (27 cm)



GII-7006
9 mm Ø



GII-7007
14 mm Ø



GII-7008
16 mm Ø



GII-7009
22 mm Ø



GII-7010
Cushing
14 mm Ø



GII-7011
2 mm Ø



GII-7012
McKenzie
13 mm Ø



GII-7013
Errico
16 mm Ø



BONE SURGERY INSTRUMENTS



GII-7014
Gigli Saw Handle



GII-7015
Gigli Strully Saw Handle



GII-7016
Gigli Strully Saw Handle

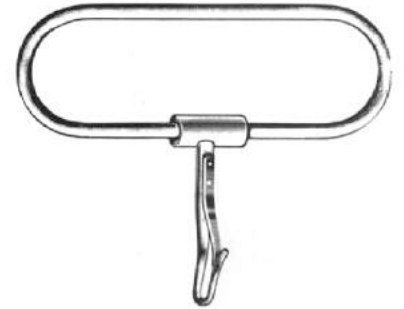

GII-7017
Gigli Strully Saw Handle

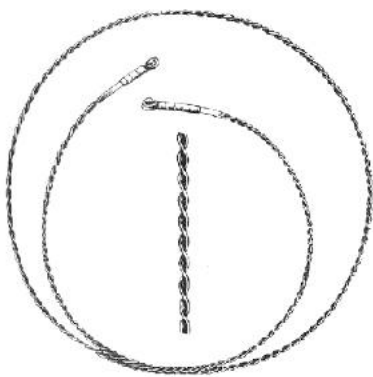

Gigli Saw Wire

ARTICLE #	SIZE
GII-7018	12" (30 cm)
GII-7019	20" (51 cm)
GII-7020	30" (76 cm)



Saw Blade
GII-7021
15mm



GII-7022
Charriere Resection Saw
14" (35 cm)



GII-7023
Langenbeck Saw
9" (23 cm)



GII-7024
Charriere Saw
10½" (27 cm)



GII-7025
Satterlee Saw
13¼" (31 cm)



BONE SURGERY INSTRUMENTS



Schede Bone Curettes
6½" (16 cm)

- Fig, 000
GII-7026
- Fig, 00
GII-7027
- Fig, 0
GII-7028
- Fig, 1
GII-7029
- Fig, 2
GII-7030
- Fig, 3
GII-7031
- Fig, 4
GII-7032

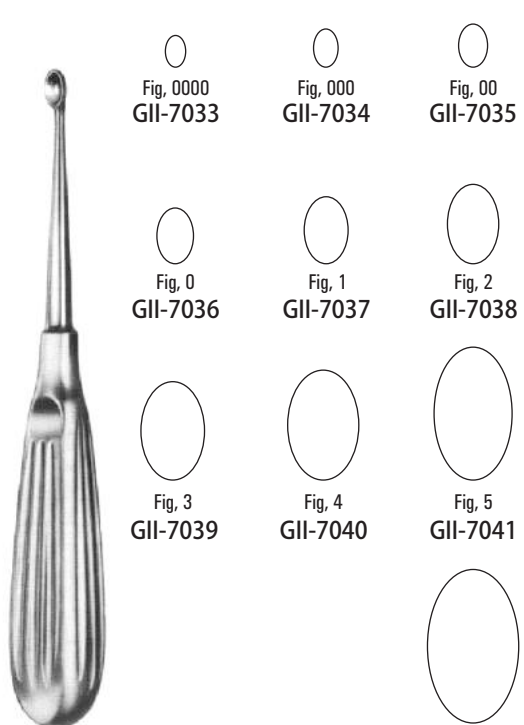

Volkmann Bone Curettes
6½" (16 cm)

- Fig, 0000
GII-7033
- Fig, 000
GII-7034
- Fig, 00
GII-7035
- Fig, 0
GII-7036
- Fig, 1
GII-7037
- Fig, 2
GII-7038
- Fig, 3
GII-7039
- Fig, 4
GII-7040
- Fig, 5
GII-7041
- Fig, 6
GII-7042

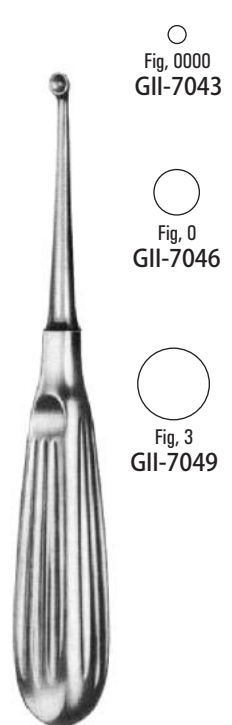

Bruns Bone Curettes
6½" (16 cm)

- Fig, 0000
GII-7043
- Fig, 000
GII-7044
- Fig, 00
GII-7045
- Fig, 0
GII-7046
- Fig, 1
GII-7047
- Fig, 2
GII-7048
- Fig, 3
GII-7049
- Fig, 4
GII-7050
- Fig, 5
GII-7051
- Fig, 6
GII-7052

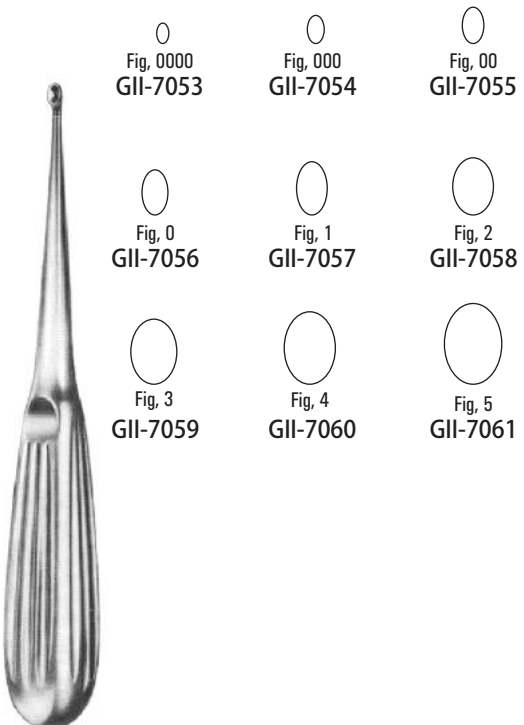

Spratt Bone Curettes
6½" (16 cm)

- Fig, 0000
GII-7053
- Fig, 000
GII-7054
- Fig, 00
GII-7055
- Fig, 0
GII-7056
- Fig, 1
GII-7057
- Fig, 2
GII-7058
- Fig, 3
GII-7059
- Fig, 4
GII-7060
- Fig, 5
GII-7061



BONE SURGERY INSTRUMENTS

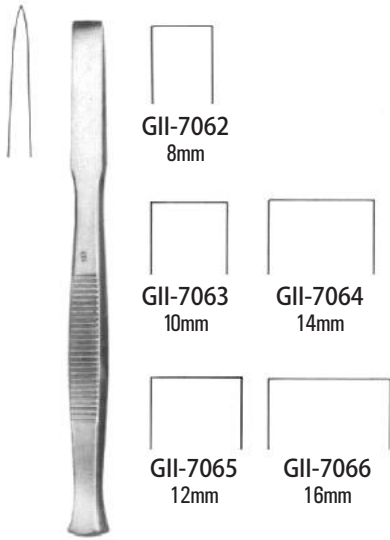

GII-7062
8mm

GII-7063
10mm

GII-7064
14mm

GII-7065
12mm

GII-7066
16mm

Bone Chisels
5 1/4" (13,5cm)

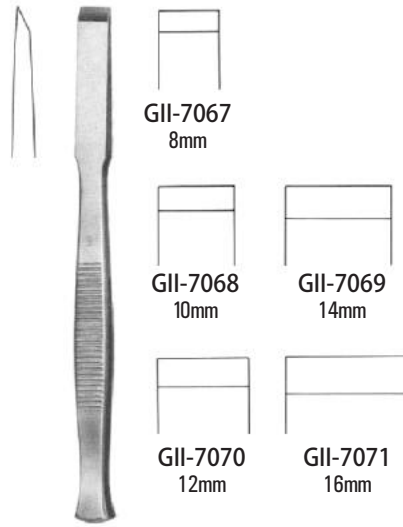

GII-7067
8mm

GII-7068
10mm

GII-7069
14mm

GII-7070
12mm

GII-7071
16mm

Bone Chisels
5 1/4" (13,5cm)

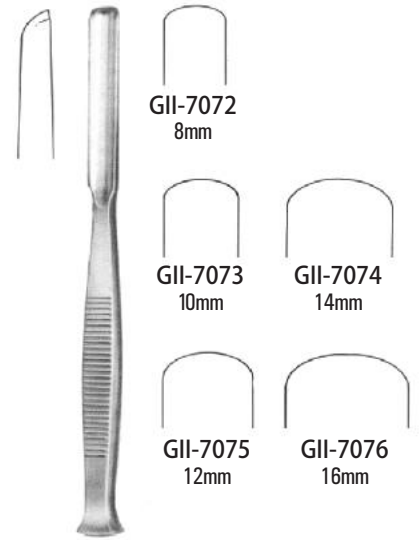

GII-7072
8mm

GII-7073
10mm

GII-7074
14mm

GII-7075
12mm

GII-7076
16mm

Bone Gouge
5 1/4" (13,5cm)

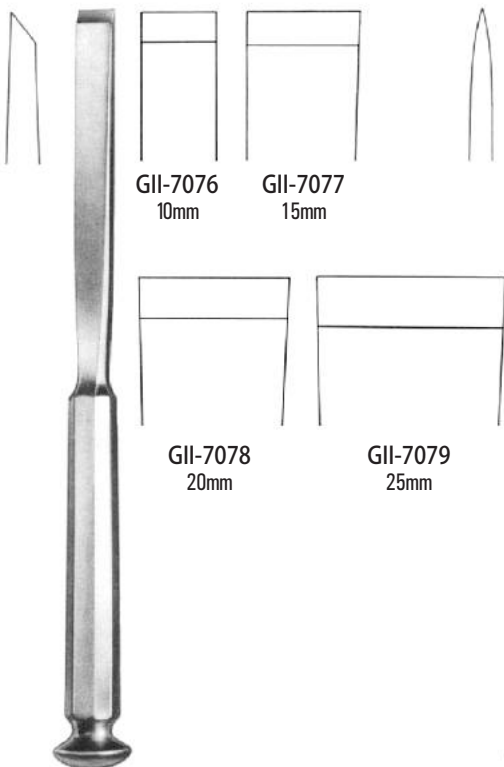

GII-7076
10mm

GII-7077
15mm

GII-7078
20mm

GII-7079
25mm

Stille Bone Chisels
8" (20 cm)

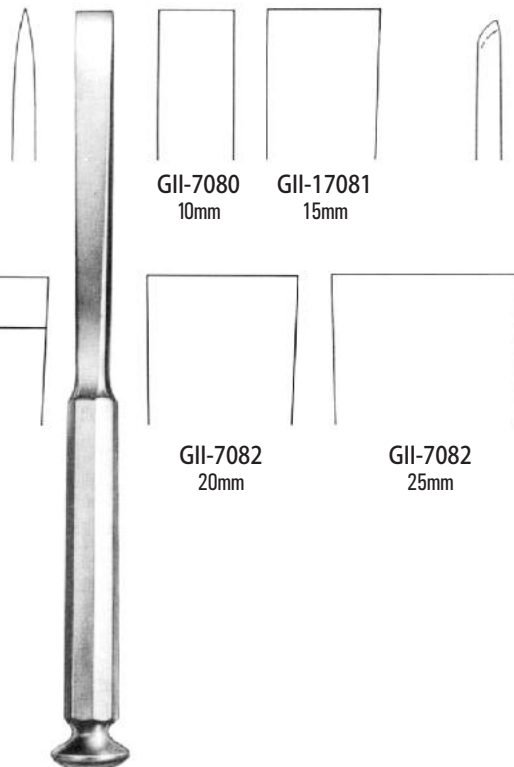

GII-7080
10mm

GII-17081
15mm

GII-7082
20mm

GII-7082
25mm

Stille Bone Chisels
8" (20 cm)

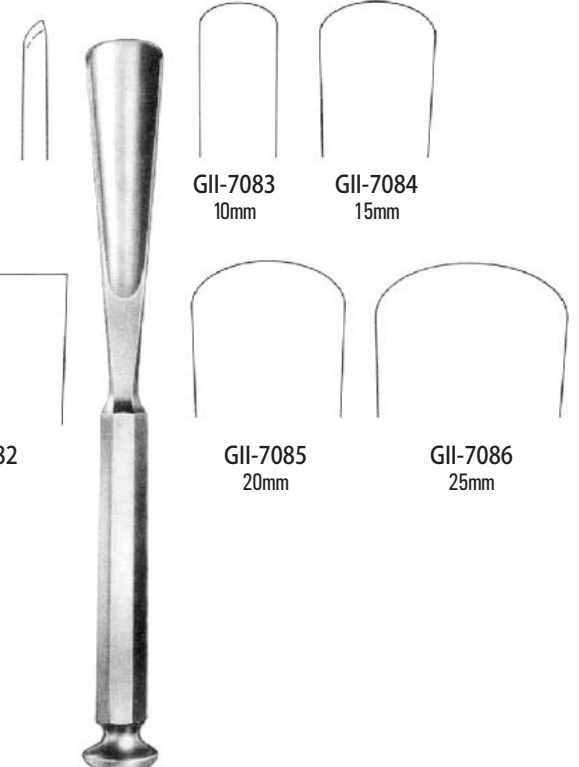

GII-7083
10mm

GII-7084
15mm

GII-7085
20mm

GII-7086
25mm

Stille Bone Gouge
8" (20 cm)



BONE SURGERY INSTRUMENTS

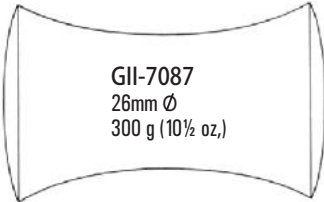

GII-7087
26mm Ø
300 g (10½ oz.)

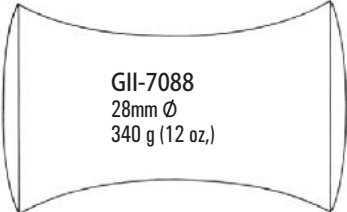

GII-7088
28mm Ø
340 g (12 oz.)

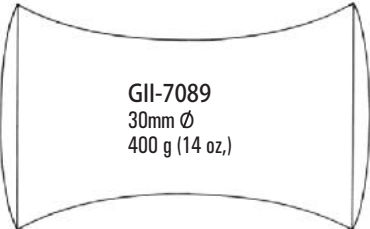

GII-7089
30mm Ø
400 g (14 oz.)

Williger Hammer
9½" (24 cm)



Head Weight
227 G

GII-7090
Gerog Mallet Hammer
Weight



Doyen Hammer
8¼" (21 cm)

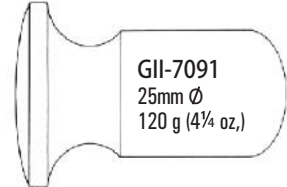

GII-7091
25mm Ø
120 g (4¼ oz.)

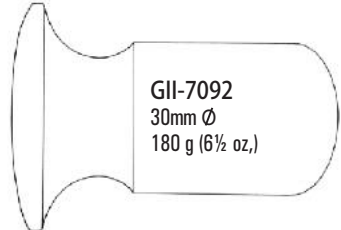

GII-7092
30mm Ø
180 g (6½ oz.)

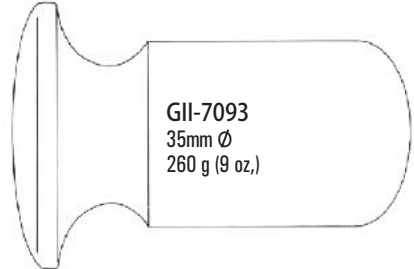

GII-7093
35mm Ø
260 g (9 oz.)



GII-7094
220 g (7¾ oz.)

Collin Hammer
8" (20 cm)



Lucae Hammer
7½" (19 cm)



GII-7096
19mm Ø
230 g (8 oz.)

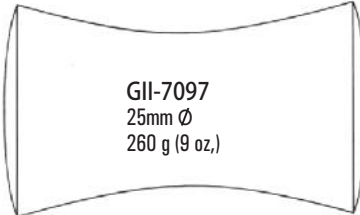

GII-7097
25mm Ø
260 g (9 oz.)



Head Weight
450 G

GII-7095
Miltex Mallet
11" (27.9cm)



BONE SURGERY INSTRUMENTS

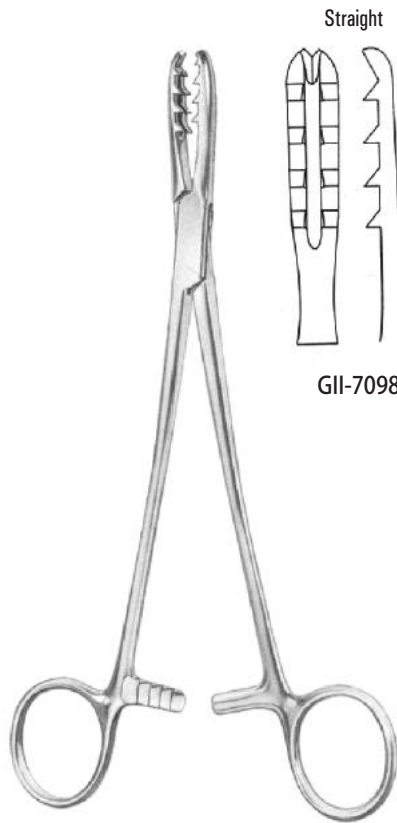

Bircher-Ganske Forceps
8" (20 cm)

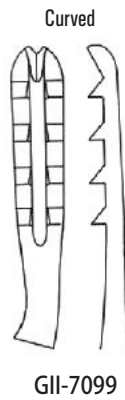
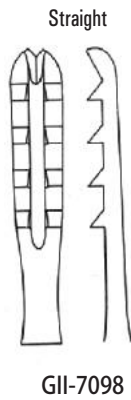

GII-7100
Lewin
7" (17,5 cm)



GII-7101
Bone Holding Forceps
5 1/4" (13,5cm)

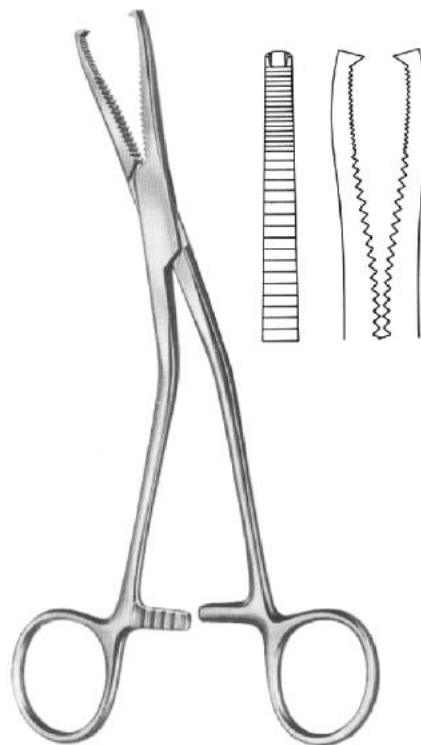

GII-7102
Dingmann Bone Forceps
7 1/2" (19 cm)



GII-7103
Martin Bone Forceps
7 1/2" (19 cm)



BONE SURGERY INSTRUMENTS



GII-7104
Bone Holding Forceps
5½" (14 cm)



GII-7105
Bone Holding Forceps
5¼" (13,5cm)



GII-7106
Langenbeck
Bone Holding Forceps
8¼" (21 cm)



GII-7107
Fergusson Bone Holding Forceps
8¼" (21 cm)



GII-7108
Frosch Bone Holding Forceps
7" (18 cm)



GII-7109
Bone Holding Forceps
8" (20 cm)



BONE SURGERY INSTRUMENTS

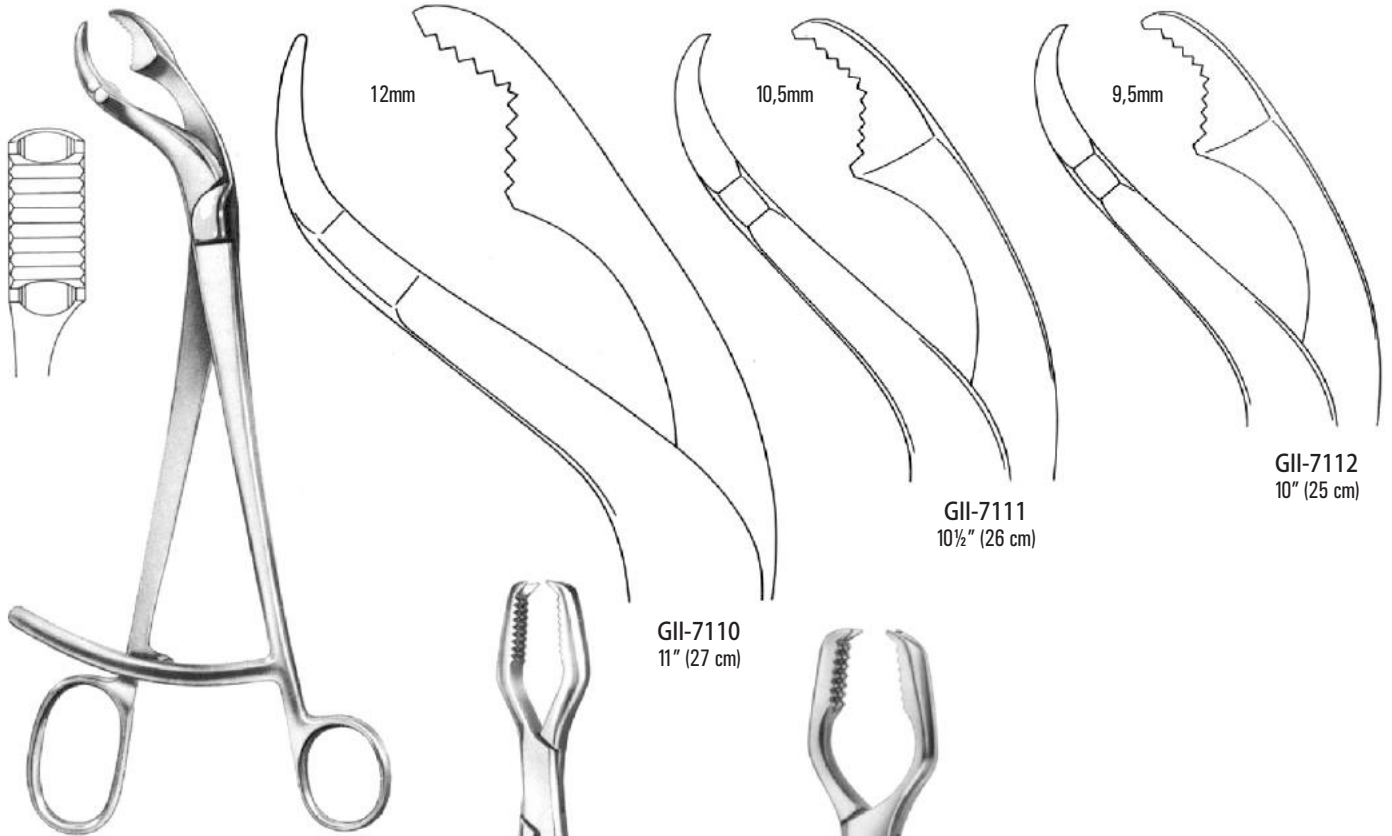

Verbrugge Bone Holding Forceps

GII-7110
11" (27 cm)

GII-7111
10½" (26 cm)

GII-7112
10" (25 cm)



GII-7113
Verbrugge Bone Holding Forceps
6¾" (17,5cm)



GII-7114
LANE Bone Holding Forceps
13" (33 cm)



GII-7115
LANE Bone Holding Forceps
13" (33 cm)



GII-7116
Lowmann Bone Holding Forceps
7" (18 cm)



BONE SURGERY INSTRUMENTS



Kern Bone Holding Forceps

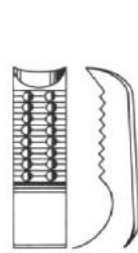

GII-7117
6¾" (17 cm)

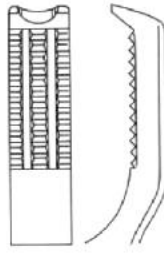

GII-7118
8¼" (21 cm)



GII-7119
Semb Bone Holding Forceps
7½" (19 cm)

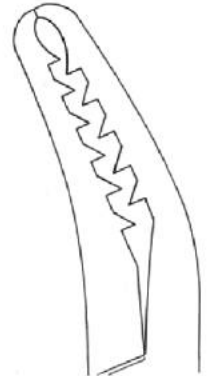

Farabeuf Bone Holding Forceps

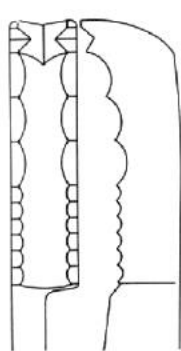

ARTICLE #	SIZE
GII-7120	9" (23 cm)
GII-7121	10¼" (26 cm)

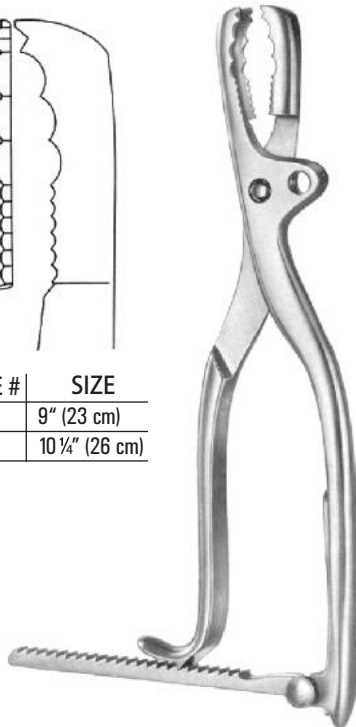

GII-7122
Farabeuf-Lambotte
Bone Holding Forceps
10¼" (26 cm)

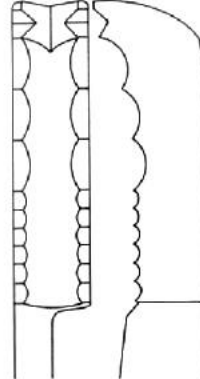

Lambotte Bone Holding Forceps

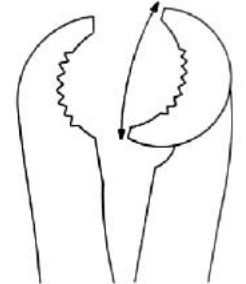

ARTICLE #	SIZE
GII-7123	8" (22 cm)
GII-7124	10½" (27 cm)
GII-7125	12" (30 cm)



BONE SURGERY INSTRUMENTS



GII-7126
Hennig Spreader
11" (28cm)

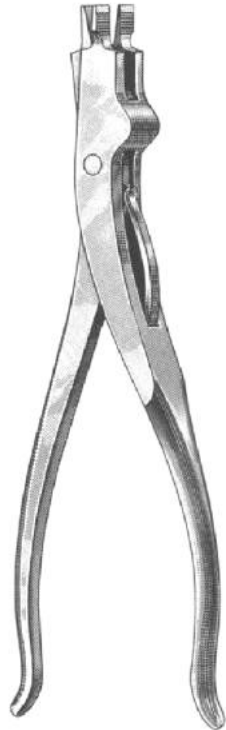

GII-7127
3 Prong Cast Spreader
9" (23 cm)



GII-7128
Eangle Saw



Wolfe Buechier Cast Breaker



GII-7129
7" (18 cm)



GII-7130
10" (24 cm)



Stille- Cast Shears

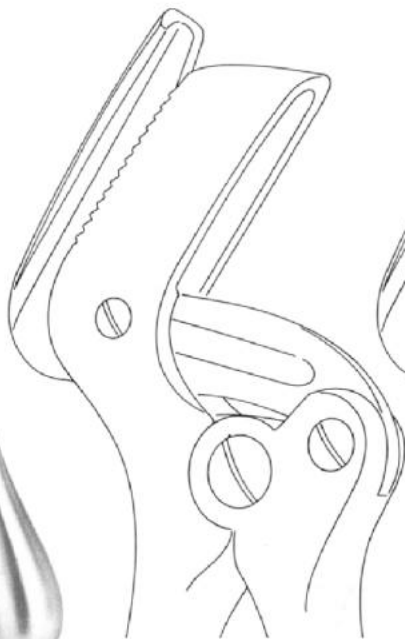

GII-7131
8" (23 cm)

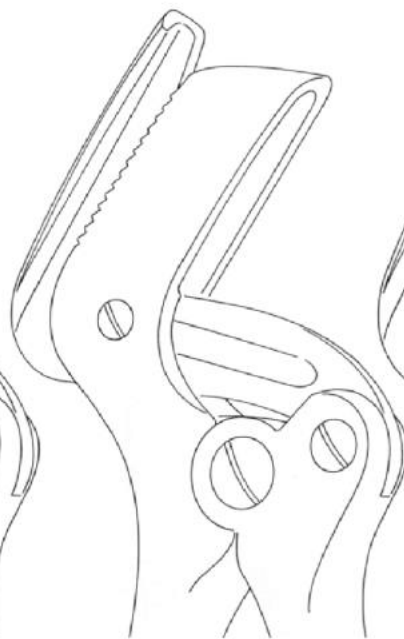

GII-7132
11" (26 cm)

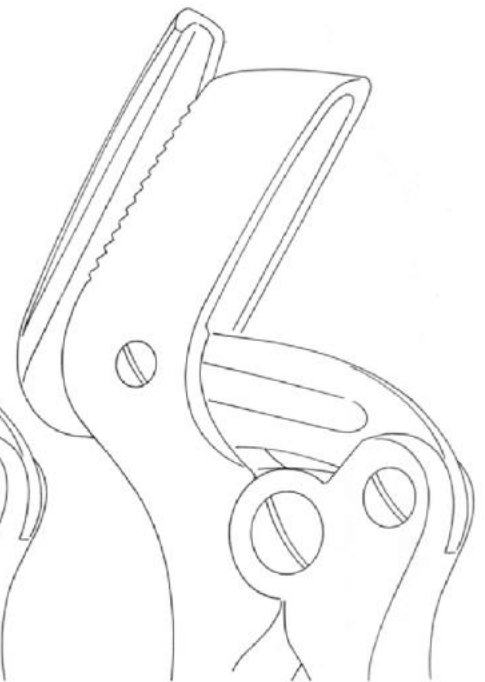

GII-7133
15" (37 cm)



BONE SURGERY INSTRUMENTS



GII-7134



GII-7135



GII-7136



GII-7137



GII-7138



GII-7139



GII-7140

Blumenthal Bone Rongeur
6" (15 cm)

Luer Bone Rongeur
7" (15 cm)

Hartmann Bone Rongeur
7" (18,5cm)



GII-7141



GII-7142

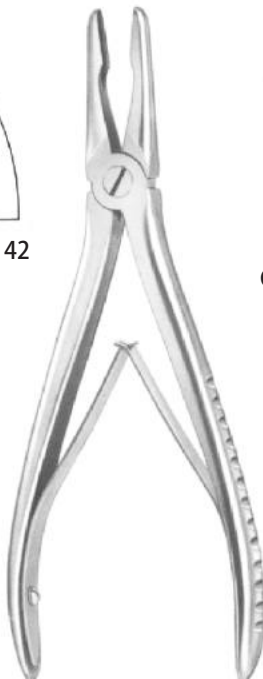

GII-7143



GII-7144



GII-7145



GII-7146



Luer Bone Rongeur
7" (18 cm)

Jansen Bone Rongeur Forceps
7" (18 cm)

Lempert Bone Rongeur Forceps
7½" (19 cm)



BONE SURGERY INSTRUMENTS

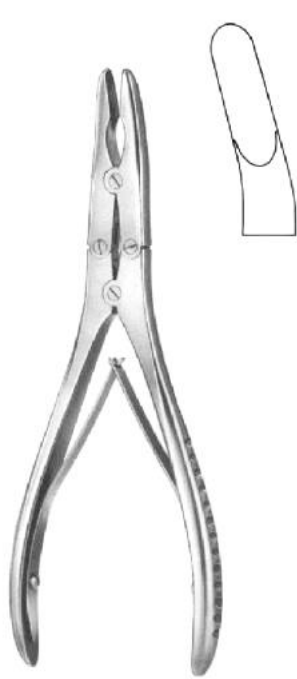

GII-7147
Ruskin Bone Rongeur Forceps
7" (18 cm)



GII-7148
Ruskin Bone Rongeur Forceps
9" (23 cm)



GII-7149
Stille-Ruskin
Bone Rongeur Forceps
9" (23 cm)



GII-7150
Stille Bone Rongeur Forceps
9" (23 cm)



GII-115-155

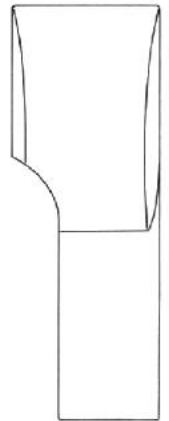

GII-115-158



GII-7151



GII-7152



Echlin Bone Rongeur Forceps
9" (23 cm)



GII-7153



Stille-Luer Bone Rongeur Forceps
8 3/4" (22 cm)



GII-7154



GII-7155
Semb Bone Rongeur Forceps
9" (23 cm)



**Sauerbruch
Bone Rongeur Forceps**
12" (30 cm)

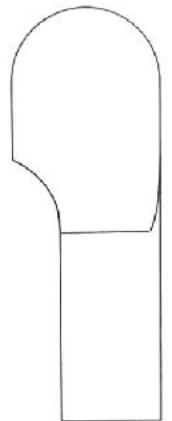

GII-7156



BONE SURGERY INSTRUMENTS



Liston Bone Cutting Forceps
Straight



GII-7157
5½" (14 cm)



GII-7158
6¾" (17 cm)



GII-7159
7½" (19 cm)



GII-7160
8¾" (22 cm)



Liston Bone Cutting Forceps
Curved



GII-7161
5½" (14 cm)



GII-7162
6¾" (17 cm)



GII-7163
7½" (19 cm)



GII-7164
8¾" (22 cm)



GII-7165
Rusking Bone Cutting Forceps
6" (15 cm)



GII-7166
Markwelder Bone Cutting Forceps
8" (20 cm)

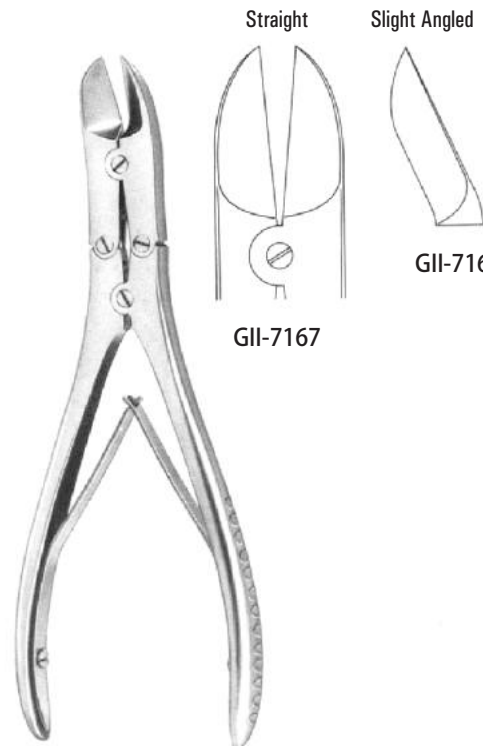

Ruskin-Liston
Bone Cutting Forceps
7½" (18,5cm)

Slight Angled

GII-7168



BONE SURGERY INSTRUMENTS



GII-7169
Cleveland
Bone Cutting Forceps
7" (17 cm)



GII-7170
Cleveland
Bone Cutting Forceps
6" (15 cm)

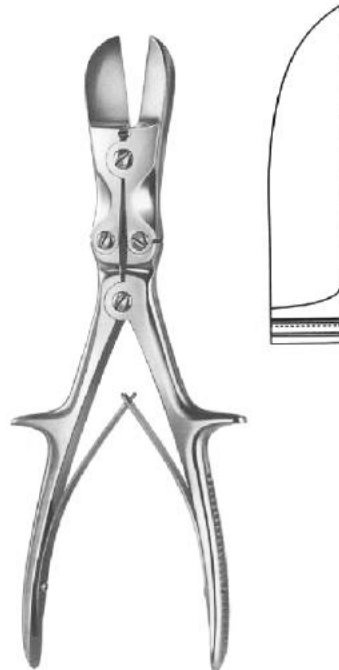

GII-7171
Stille-Liston
Bone Cutting Forceps, Straight
10½" (27 cm)

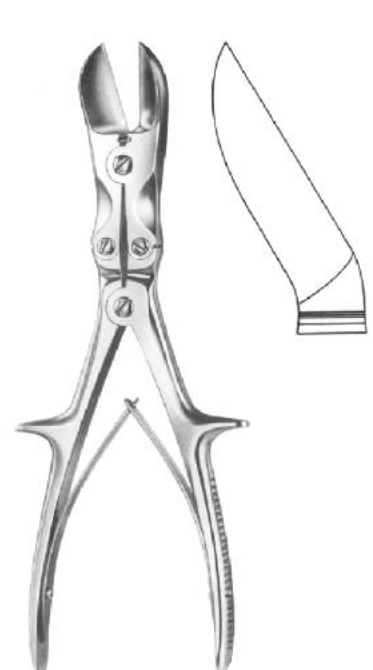

GII-7172
Stille-Liston
Bone Cutting Forceps, Curved
10½" (27 cm)

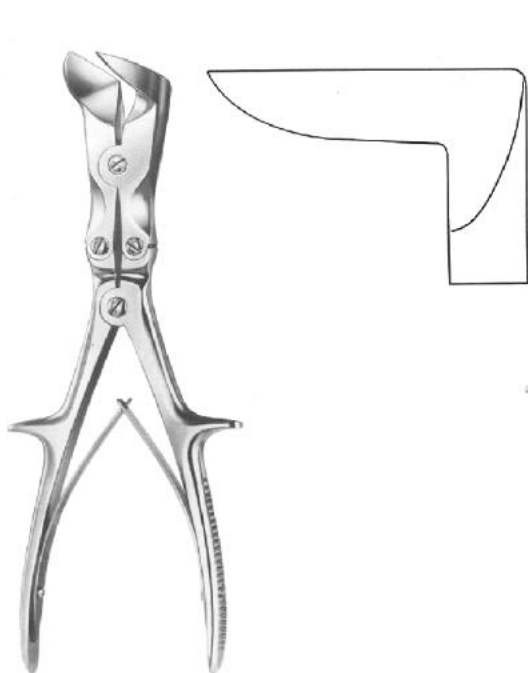

GII-7173
Stille-Liston
Bone Cutting Forceps
10½", Curved

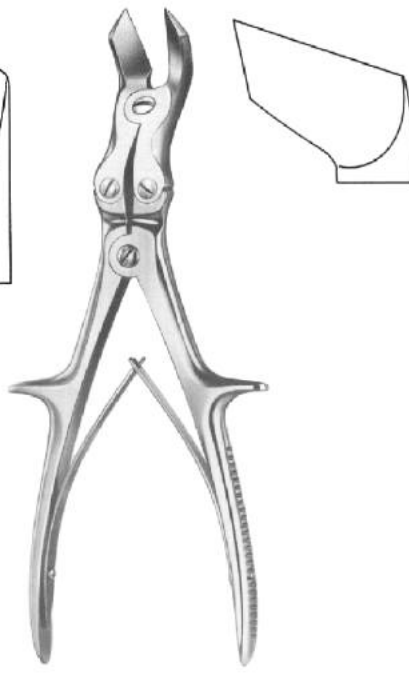

GII-7174
Liston-Key
Bone Cutting Forceps
10½" (27 cm)

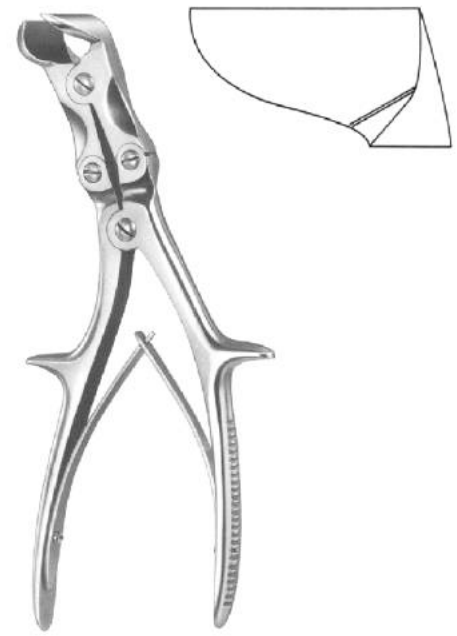

GII-7175
Semb
Bone Cutting Forceps
9" (24 cm)



BONE SURGERY INSTRUMENTS



GII-7176
Flat Nose Plier
6½" (17 cm)

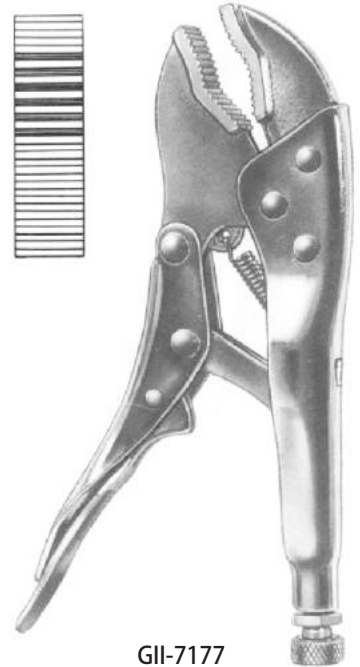

GII-7177
Grip Plier
7" (18 cm)

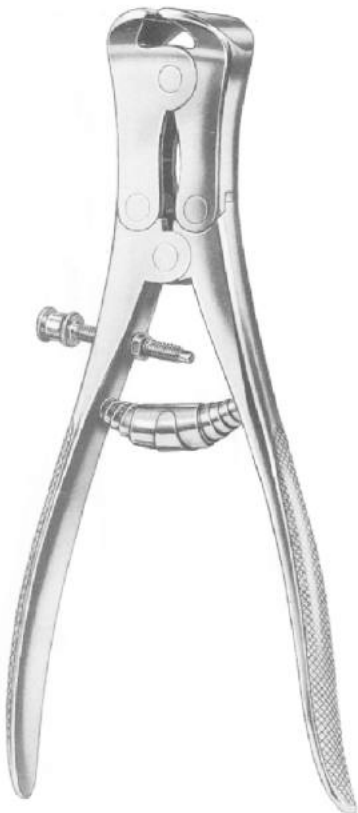

GII-7178
Wire Cutting Plier
9" (23 cm)



GII-7179
Bolt Cutter
12" (30 cm)



GII-7180
Pin Cutter
18½" (47 cm)



BONE SURGERY INSTRUMENTS



GII-7181
Wire Cutting Pliers
6" (16 cm)



GII-7182
Diamant Wire Cutting Pliers
6" (16 cm)



GII-7183
Diamant Wire Cutting Pliers
6" (15 cm)



GII-7184
Flat Nose Pliers
7" (17 cm)



Flat Nose Pliers
7" (18 cm)



GII-7185



GII-7186



GII-7187



Flat Nose Pliers
7" (18 cm)



GII-7188

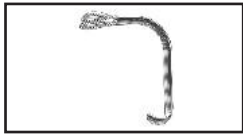

ORAL INSTRUMENTS



GII-8000
Tongue Depressors
7½" (19 cm)



GII-8001
28mm

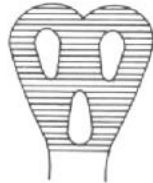

GII-8002
32mm

Wieder Tongue Depressors
5½" (14 cm)



Magil Forceps

ARTICLE #	SIZE
GII-8003	6" (16 cm)
GII-8004	8" (20 cm)
GII-8005	10" (25 cm)
GII-8006	11" (28 cm)

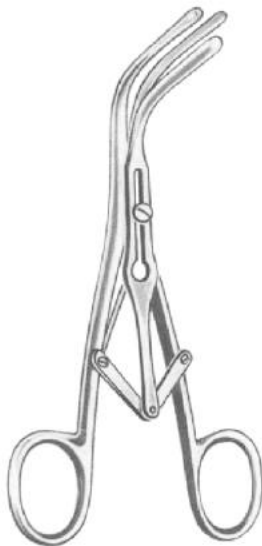

GII-8007
Trocars
Laborde Dilators
5½" (14 cm)



GII-8008
Trocars Dilatory
Trousseau
5½" (14 cm)



GII-8009
Tongue Holding Forceps
Collin
6¼" (16 cm)



GII-8010
Young Tongue Forceps
6¾" (17 cm)



GII-8011
Spare Rubber



ORAL INSTRUMENTS

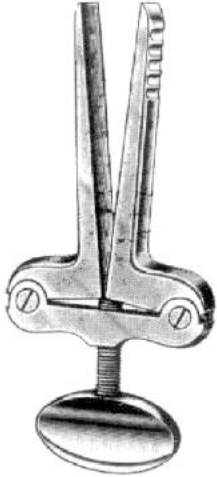

GII-8012
Meister Mouth Gag
 5" (13 cm)

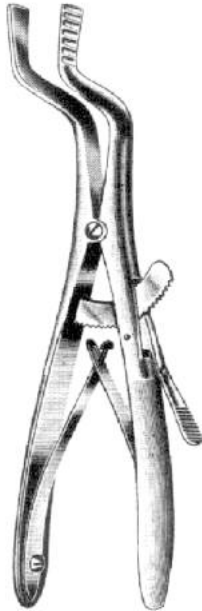

Roser-Konig Mouth Gag

ARTICLE #	SIZE
GII-8013	6½" (16 cm)
GII-8014	7½" (19 cm)

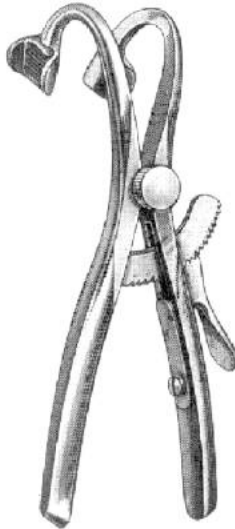

GII-8015
Denhardt Mouth Gag
 6" (15 cm)

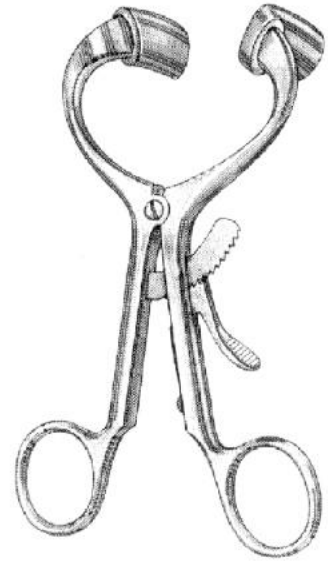

Molt Mouth Gag

ARTICLE #	SIZE
GII-8016	4" (10 cm)
GII-8017	4½" (11,5 cm)
GII-8018	5½" (14 cm)



Whitehead Mouth Gag

ARTICLE #	SIZE
GII-8019	3½" (9 cm)
GII-8020	4¾" (11 cm)
GII-8021	5" (13 cm)
GII-8022	6" (15 cm)

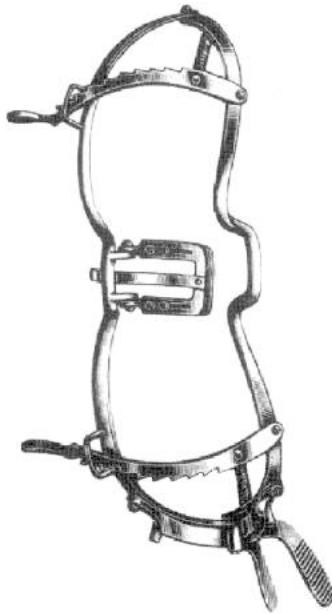

Whitehead Mouth Gag

ARTICLE #	SIZE
GII-8023	3½" (9 cm)
GII-8024	4¾" (11 cm)
GII-8025	5" (13 cm)
GII-8026	6" (15 cm)



Jennings Mouth Gag

ARTICLE #	SIZE
GII-8027	3½" (9 cm)
GII-8028	4¾" (11 cm)
GII-8029	5" (13 cm)
GII-8030	6" (15 cm)

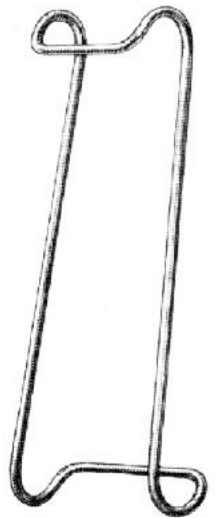

Columbia Lip Retractor Double End

ARTICLE #	SIZE
GII-8031	4¾" (12 cm)
GII-8032	5½" (14 cm)
GII-8033	6¾" (16 cm)

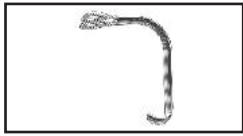

ORAL INSTRUMENTS

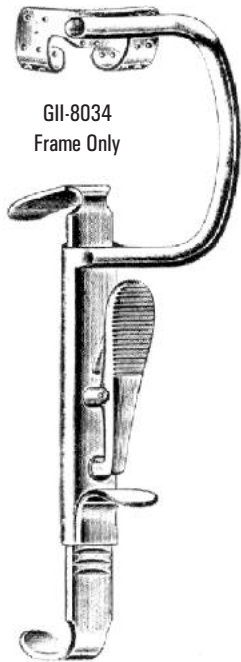

GII-08S-041
Negus Mouth Gag
(Complete Set)

GII-8034
Frame Only

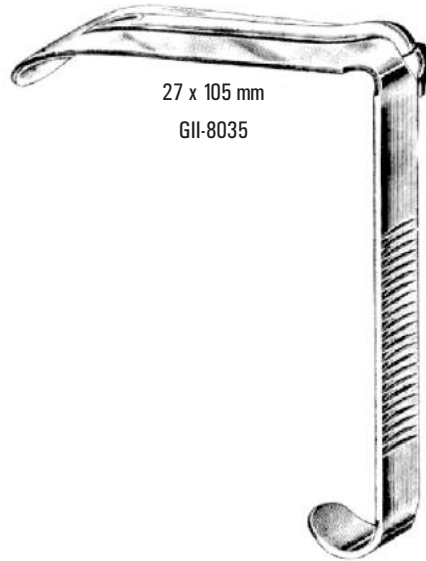

27 x 105 mm
GII-8035

Davis-Boyle Mouth Gags



25 x 90 mm
GII-8036

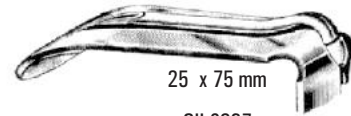

25 x 75 mm
GII-8037



22 x 60 mm
GII-8038

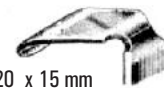

20 x 15 mm
GII-8039

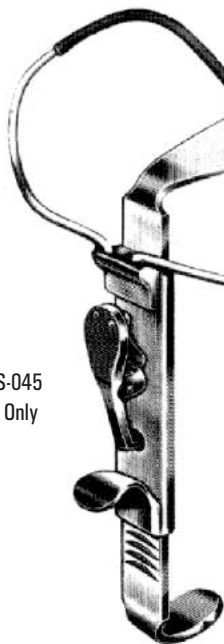

GII-08S-045
Frame Only

GII-8040
McIvor Mouth Gag
(Complete Set)



27 x 95 mm
GII-8041

22 x 85 mm
GII-8042

22 x 70 mm
GII-8043



HOLLOWWARE



Forceps Jar
ARTICLE # SIZE
 GII-8200 2" x 5"
 GII-8201 4" x 8"



GII-8202
Ointment Jar
 Size: 08oz



GII-8203
Cotton Wool Dispenser



GII-8204
Cotton Wool Dispenser



GII-8205
Alcohol Lamp

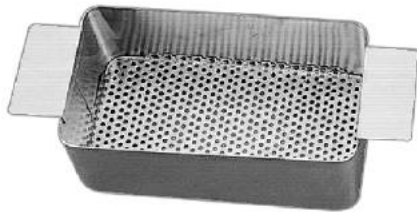

GII-8206
Sterilizing Tray
 8½" x 4½" x 3"



Kidney Tray
ARTICLE # SIZE
 GII-8207 150 mm
 GII-8208 170 mm
 GII-8209 200 mm
 GII-8210 250 mm
 GII-8211 280 mm
 GII-8212 300 mm



Instrument Tray
ARTICLE # SIZE
 GII-8213 150 x 100 x 40 mm
 GII-8214 200 x 150 x 40 mm
 GII-8215 255 x 200 x 40 mm
 GII-8216 300 x 150 x 40 mm
 GII-8217 300 x 200 x 50 mm
 GII-8218 300 x 255 x 50 mm
 GII-8219 310 x 200 x 60 mm
 GII-8220 330 x 250 x 50 mm
 GII-8221 355 x 255 x 50 mm
 GII-8222 355 x 300 x 50 mm
 GII-8223 400 x 300 x 55 mm
 GII-8224 460 x 300 x 55 mm
 GII-8225 460 x 360 x 55 mm



Instrument Tray with Lid
ARTICLE # SIZE
 GII-8226 150 x 100 x 40 mm
 GII-8227 200 x 150 x 40 mm
 GII-8228 255 x 200 x 40 mm
 GII-8229 300 x 150 x 40 mm
 GII-8230 300 x 200 x 50 mm
 GII-8231 300 x 255 x 50 mm
 GII-8232 310 x 200 x 60 mm
 GII-8233 330 x 250 x 50 mm
 GII-8234 355 x 255 x 50 mm
 GII-8235 355 x 300 x 50 mm
 GII-8236 400 x 300 x 55 mm
 GII-8237 460 x 300 x 55 mm
 GII-8238 460 x 360 x 55 mm



Catheter Tray
ARTICLE # SIZE
 GII-8039 300 x 75 x 40 mm
 GII-8040 350 x 90 x 50 mm
 GII-8041 400 x 100 x 50 mm



Mayo Tray
ARTICLE # SIZE
 GII-8042 400 x 300 x 20 mm
 GII-8043 450 x 320 x 20 mm
 GII-8044 460 x 360 x 20 mm



HOLLOWWARE

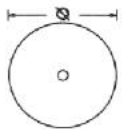

Cotton Wool Container

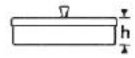

Lid with Knob

Ø x h	
75 x 60	GII-8245
75 x 75	GII-8246
100 x 60	GII-8247
100 x 100	GII-8248
125 x 80	GII-8249
125 x 125	GII-8250
150 x 150	GII-8251

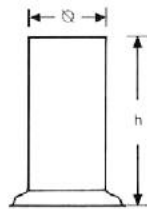

JAR

Ø x h	Jar without Lid	Lid Only	Lid Only with Triangle hole
30 x 90	GII-8252		
50 x 100	GII-8253	GII-8260	GII-8267
50 x 130	GII-8254	GII-8261	GII-8268
50 x 175	GII-8255	GII-8262	GII-8269
75 x 100	GII-8256	GII-8263	GII-8270
75 x 130	GII-8257	GII-8264	GII-8271
100 x 175	GII-8258	GII-8265	GII-8272
100 x 200	GII-8259	GII-8266	GII-8273

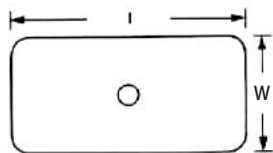

Instrument Box

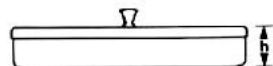

Size in mm l x b x h	Lid with Knob	Lid without Knob
165 x 85 x 35	GII-8274	GII-8282
200 x 100 x 35	GII-8275	GII-8283
200 x 100 x 50	GII-8276	GII-8284
230 x 130 x 50	GII-8277	GII-8285
260 x 150 x 50	GII-8278	GII-8286
270 x 235 x 50	GII-8279	GII-8287
300 x 200 x 50	GII-8280	GII-8288
325 x 275 x 50	GII-8281	GII-8289



GII-8290
Bucket Only
Size:
Dia: 335 mm
Height: 240 mm
Base: 215 mm

GII-8291
Bucket Kick Stand
(Stand Only)



HOLLOWWARE



Sterilizer Drum

ARTICLE #	SIZE
GII-8292	80 x 80 mm
GII-8293	120 x 120 mm
GII-8294	140 x 140 mm
GII-8295	160 x 120 mm
GII-8296	160 x 150 mm
GII-8297	190 x 150 mm
GII-8298	190 x 190 mm
GII-8299	240 x 160 mm
GII-8300	240 x 240 mm
GII-8301	290 x 160 mm
GII-8302	290 x 240 mm
GII-8303	340 x 160 mm
GII-8304	340 x 240 mm
GII-8305	390 x 190 mm
GII-8306	390 x 290 mm



Emises Basin

GII-8307	12" (4 LTR)
GII-8308	13" (6 LTR)
GII-8309	14" (8 LTR)



GII-8310
Urinal - Male



GII-8311
Urinal - Female



GII-8312
Bedpan Slipper Type



GII-8313
Bedpan American

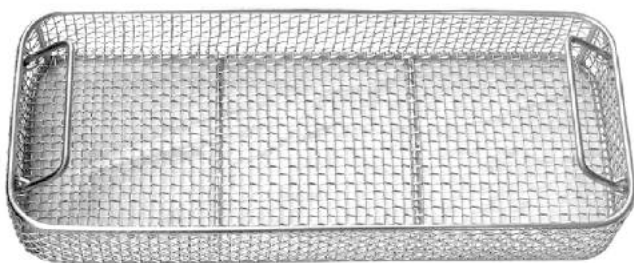

Wire Mesh Tray

ARTICLE #	SIZE
GII-8314	230 x 130 x 50 mm
GII-8315	240 x 130 x 50 mm
GII-8316	240 x 250 x 60 mm
GII-8317	480 x 250 x 50 mm
GII-8318	480 x 250 x 70 mm
GII-8319	500 x 300 x 50 mm
GII-8320	480 x 480 x 50 mm
GII-8321	300 x 300 x 60 mm
GII-8322	500 x 300 x 60 mm
GII-8323	600 x 300 x 60 mm



Sterilizing Container

ARTICLE #	SIZE
GII-8324	220 x 120 x 50 mm
GII-8325	230 x 130 x 50 mm
GII-8326	260 x 150 x 50 mm
GII-8327	300 x 200 x 50 mm

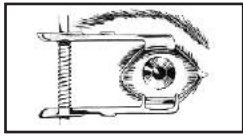

EYE INSTRUMENTS

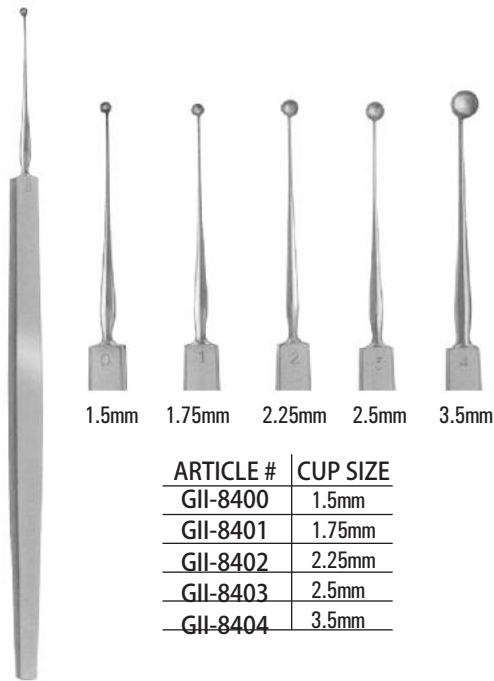

1.5mm 1.75mm 2.25mm 2.5mm 3.5mm

ARTICLE #	CUP SIZE
GII-8400	1.5mm
GII-8401	1.75mm
GII-8402	2.25mm
GII-8403	2.5mm
GII-8404	3.5mm

Meyerhoefer Curette

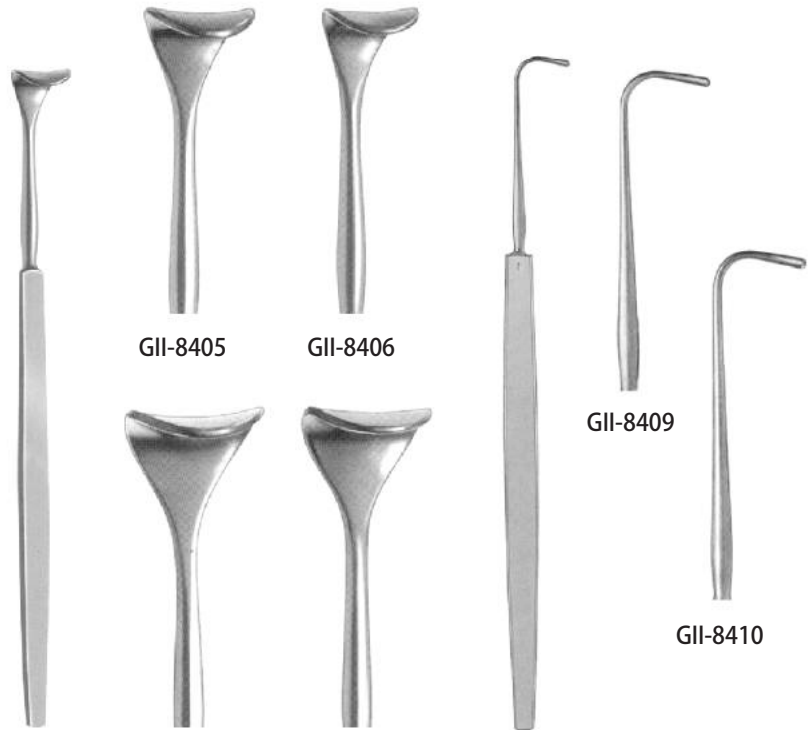

Desmarres Lid Retractor

GII-8407

GII-8408

Graefe Muscle Hook

GII-8409

GII-8410

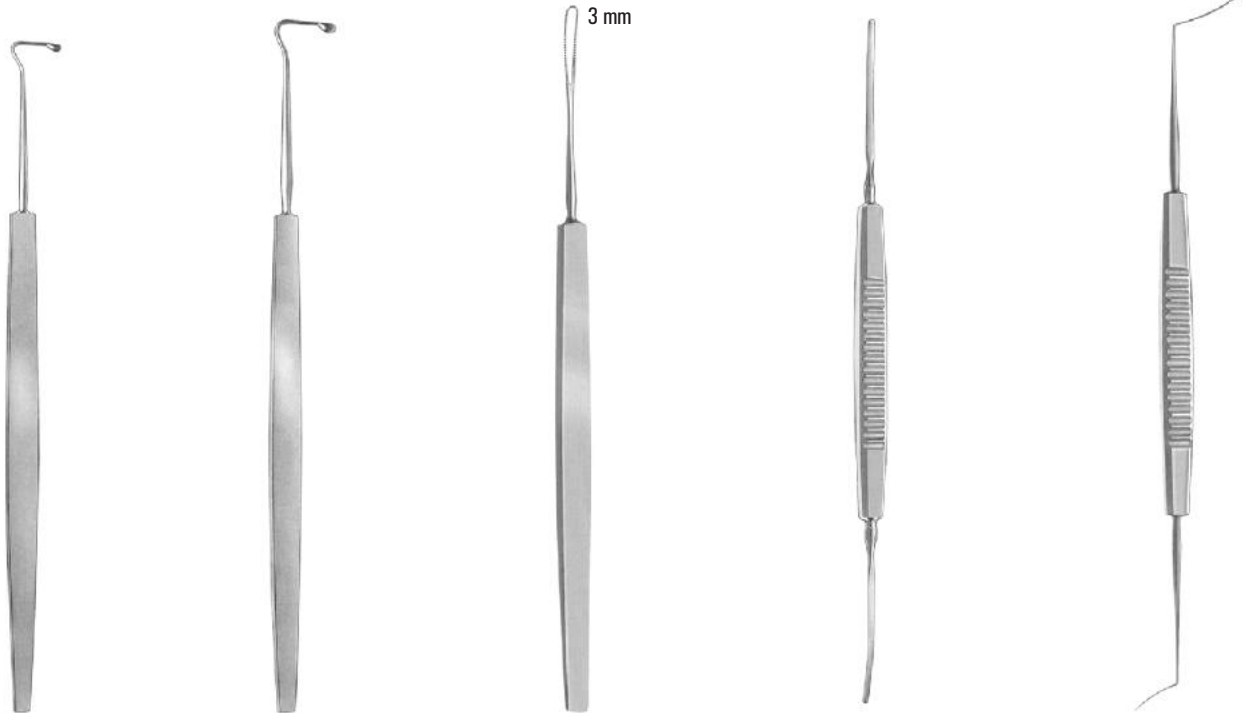

GII-8411

Jameson Muscle Hook small

GII-8412

Jameson Muscle Hook large

3 mm

GII-8413

Kansas Lens Loop

GII-8414

Wheeler Spatula 13cm

GII-8415

Castroviejo Spatula 0.5mm



EYE INSTRUMENTS

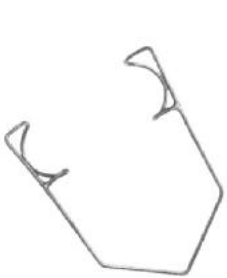
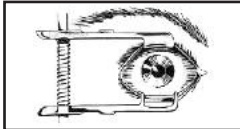

GII-8416
Barraquer Eye Speculum
small



GII-8417
Barraquer Eye Speculum
large

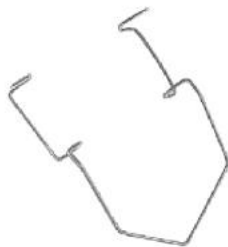

GII-8418
Kratz-Barraquer Eye Speculum
large



GII-8419
Kratz-Barraquer Eye Speculum
small



GII-8420
Barraquer
small



GII-8421
Barraquer
large



GII-8422
Lieberman
Eye Speculum, K-wire



GII-8423
Lieberman
Eye Speculum, V-wire



GII-8424
Lieberman
Eye Speculum, Pediatric
Thin Solid Blade



GII-8425
Lieberman
Eye Speculum, Pediatric
Thin Solid Blade



GII-13S-026
Castroviejo Caliper

GII-8426
Curved



GII-8427
Angled



GII-8428
Straight



GII-8429
Stevenson Lacrimal
Sac Retractor Solid Blade



GII-8430
Stevenson Lacrimal
Sac Retractor 3x3 Blunt Prong



GII-8431
Jaeger Lid Plate
Stainless Steel

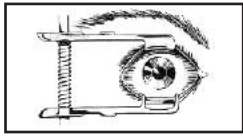

EYE INSTRUMENTS

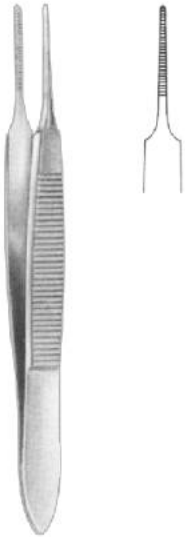

GII-8432
Graefe Iris Forceps
2 3/4" (7 cm)

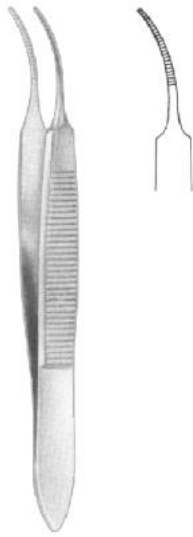

GII-8433
Graefe Iris Forceps
2 3/4" (7 cm)

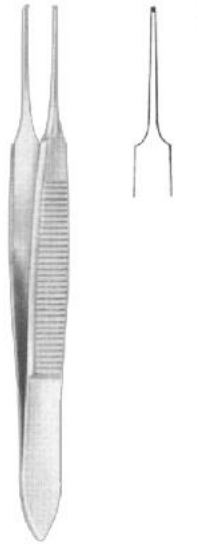

GII-8434
Graefe 1:2 Iris Forceps
2 3/4" (7 cm)

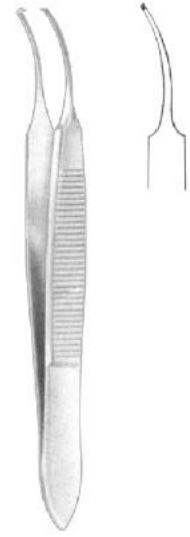

GII-8435
Graefe 1:2 Iris Forceps
2 3/4" (7 cm)



Graefe Iris Forceps
4 1/2" (11 cm)



GII-8436



GII-8437



GII-8438



GII-8439



GII-8440



GII-8441



(Colibri) Iris Forceps
2 3/4" (7 cm)



Troutman (Corneal) Iris Forceps
3" (7.5cm)



Troutman (Colibri) Iris Forceps
2 3/4" (7 cm)



EYE INSTRUMENTS

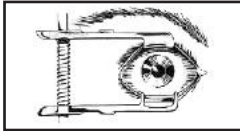

GII-8445
Bishop-Hartman Forceps
3½" (8.5cm)



GII-8446
Bishop-Hartman Forceps
3½" (8.5cm)



GII-8447
Bishop-Hartman Forceps
3½" (8.5cm)

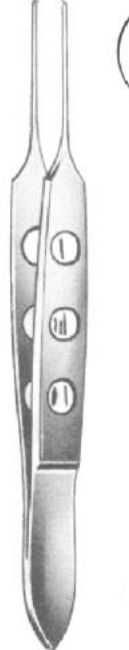

GII-8448
Bishop-Hartman Forceps
3½" (8.5cm)



GII-8449
Kirby Forceps
3½" (9 cm)



GII-8450
Erhardt Chalazion Forceps
3½" (9 cm)



GII-8451
Ayer Chalazion Forceps
3½" (9 cm)



GII-8452
Ayer Chalazion Forceps
3½" (9 cm)

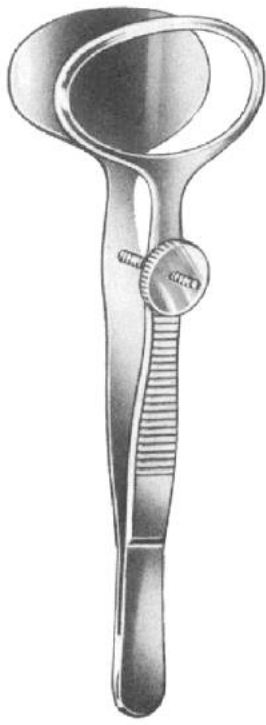

GII-8453
Desmarres Chalazion Forceps
3½" (9 cm)

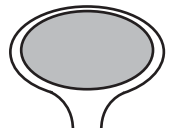

GII-8454

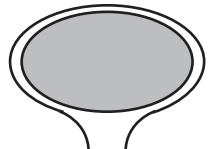

GII-8455

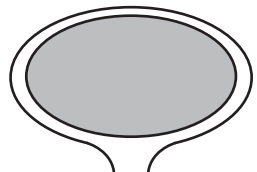

GII-8456

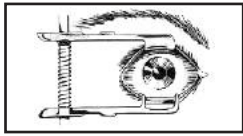

EYE INSTRUMENTS



GII-13S-057
Graefe Fixation Forceps
4" (10 cm)



Castroviejo 1:2
Fixation Forceps
4" (10 cm)

ARTICLE #	1x2 T Width
GII-8457	0.12mm
GII-5458	0.30mm
GII-8459	0.50mm
GII-8460	1.00mm
GII-8461	1.50mm



Castroviejo 1:2
Fixation Forceps
3 1/2" (9 cm)

Straight



GII-8462

Curved



GII-8463



GII-8464
Elsching 1:2 Fixation Forceps
4 1/2" (11 cm)

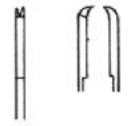

GII-8465
Paufigue 1:2 Suture Forceps
4" (10 cm)

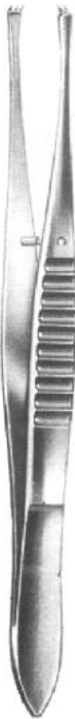

GII-8467
Elschnig 2:3 Fixation Forceps
4 1/2" (11 cm)

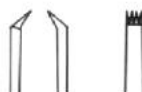

GII-8468
Elschnig 3:4 Fixation Forceps
4 1/2" (11 cm)



1:2
GII-13S-069



2:3
GII-13S-070

Lester Fixation Forceps
3 1/2" (9 cm)



GII-8469
Moorfield Fixation Forceps
4" (10 cm)



EYE INSTRUMENTS

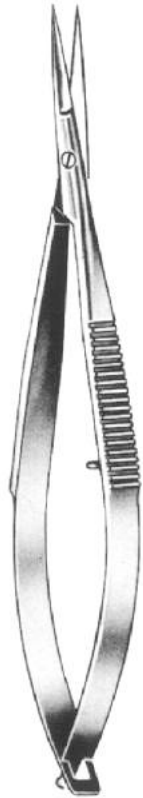
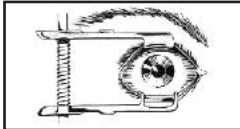

GII-8470
Noyes Iris Scissors
4 3/4" (12 cm)



GII-8471

GII-8472

GII-8473



GII-8474
Noyes Iris Scissors
4 3/4" (12 cm)



GII-8475
Wecker Scissors
4 1/2" (11 cm)



GII-8476



GII-8477



GII-8478



GII-8479
Barraquer Scissors
2 1/4" (5.5cm)

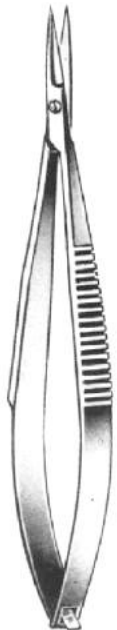

Castroviejo Scissors
3 1/2" (9 cm)



GII-8480

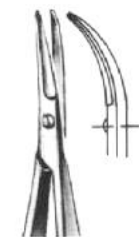

GII-8481



GII-8482



GII-9483

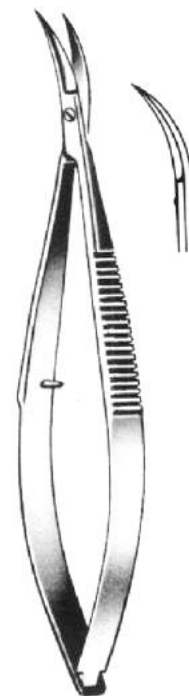

GII-8484
Castroviejo Scissors
4" (10 cm)

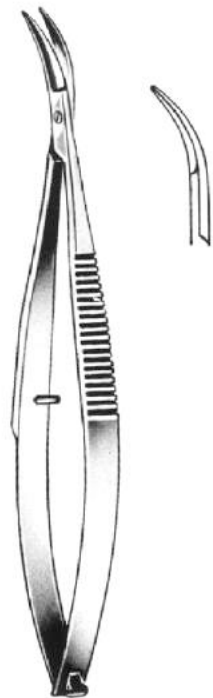

GII-8485
Castroviejo Scissors
4" (10 cm)

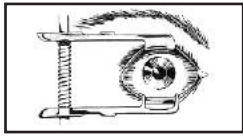

EYE INSTRUMENTS

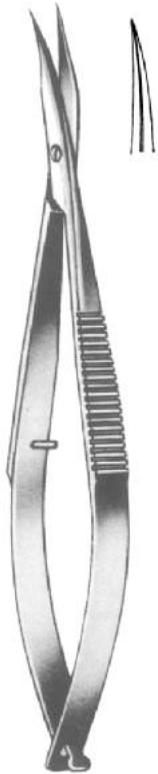

GII-8486
Westcott Tenotomy Scissors
4½" (11 cm)

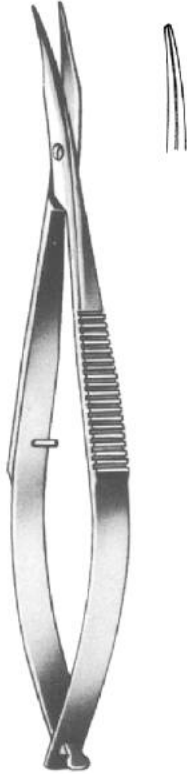

GII-8487
Westcott Tenotomy Scissors
4½" (11 cm)

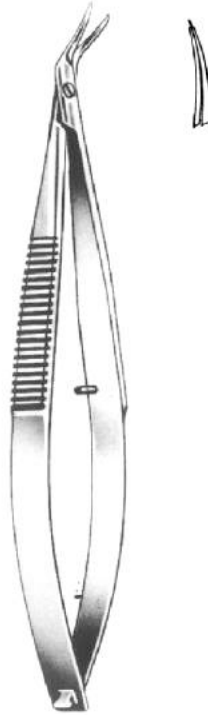

GII-8488
Castroviejo Corneal Scissors
4" (10 cm)

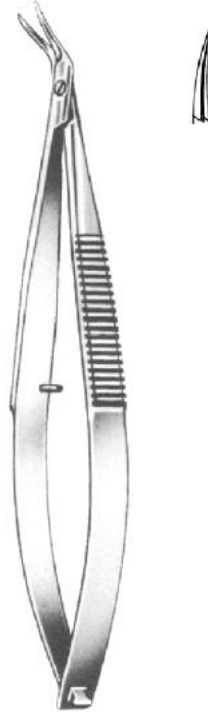

GII-8489
Castroviejo Corneal Scissors
4" (10 cm)

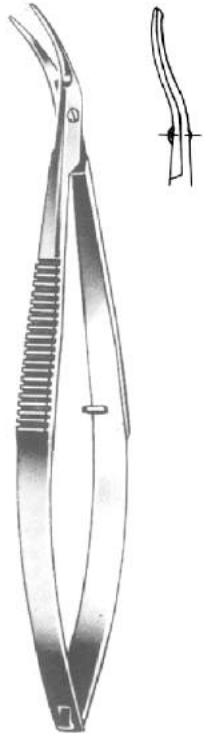
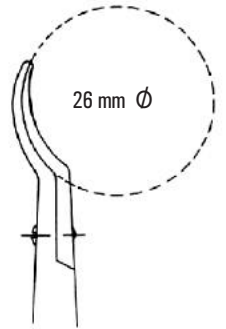

GII-8490
Castroviejo Corneal Scissors
4½" (11 cm)

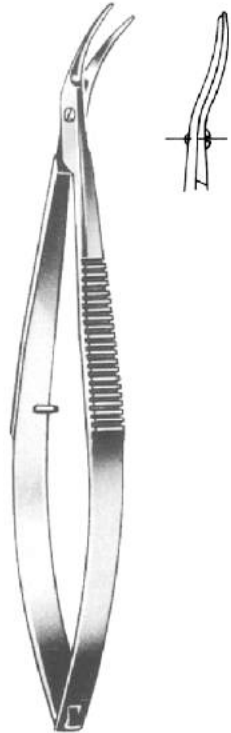

GII-8491
Castroviejo Corneal Scissors
4½" (11 cm)

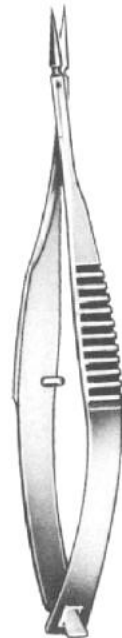

GII-8492
Vannas Scissors
Straight, 3½" (8.5cm)

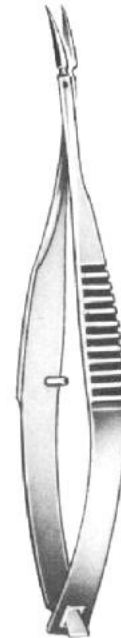

GII-8493
Vannas Scissors
Curved, 3½" (8.5cm)

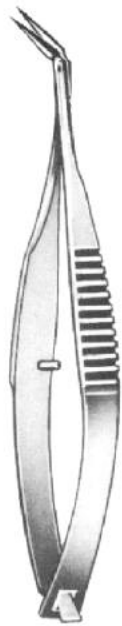

GII-8494
Vannas Scissors
Angled, 3½" (8.5cm)



EYE INSTRUMENTS

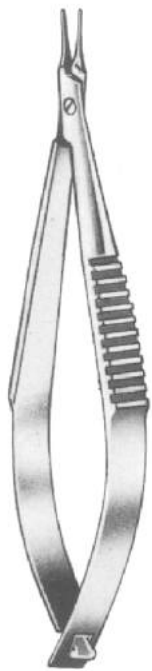
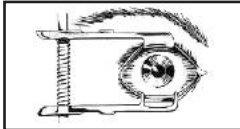

GII-8495

GII-8496

Castroviejo Needle Holders
3 1/2" (9 cm)

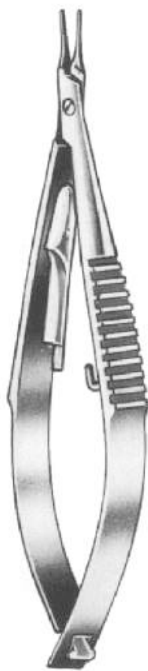

GII-8497

GII-8498

Castroviejo Needle Holders
3 1/2" (9 cm)



GII-8499

GII-8500

Castroviejo Needle Holders
5 1/2" (14 cm)



GII-8501

GII-8502

Castroviejo Needle Holders
5 1/2" (14 cm)



GII-8503

GII-8505



GII-8504

GII-8506

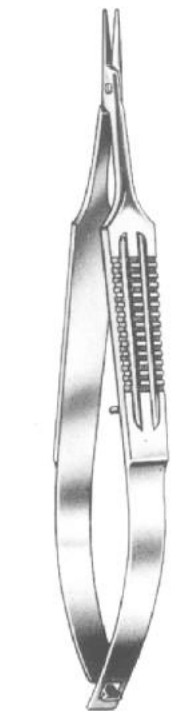

GII-8507



GII-8508

Castroviejo Needle Holders
5 1/2" (14 cm)

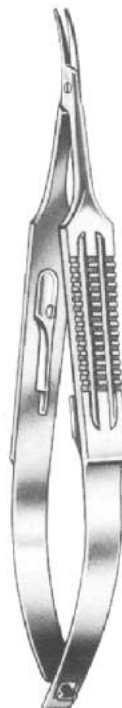

GII-8509



GII-8510

Castroviejo Needle Holders
5 1/2" (14 cm)



GII-8511
7" (18 cm)



GII-8512
8 1/4" (21 cm)

Jacobson Needle Holders

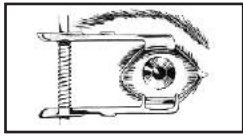

EYE INSTRUMENTS

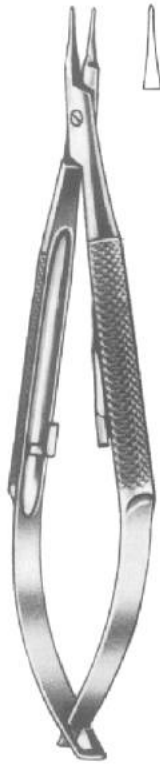

GII-8513
Barraquer-Troutman
Needle Holder
4" (10 cm)

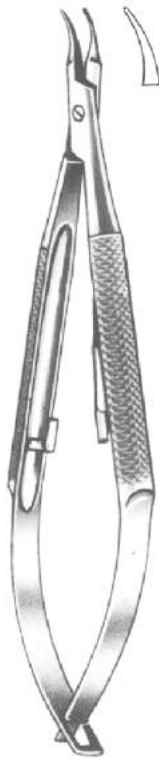

GII-18514
Barraquer-Troutman
Needle Holder
4" (10 cm)



GII-8515
Barraquer-Troutman
Needle Holder
4" (10 cm)



GII-8516
Barraquer-Troutman
Needle Holder
4" (10 cm)



GII-8517
Barraquer Needle Holder
4 1/4" (11 cm)



GII-8518
Barraquer Needle Holder
5" (13 cm)



GII-8519
Barraquer Needle Holder
5 1/2" (14 cm)



GII-8520
Barraquer Needle Holder
5 1/2" (14 cm)



GII-8521
Barraquer Needle Holder
5 1/2" (14 cm)



EYE INSTRUMENTS

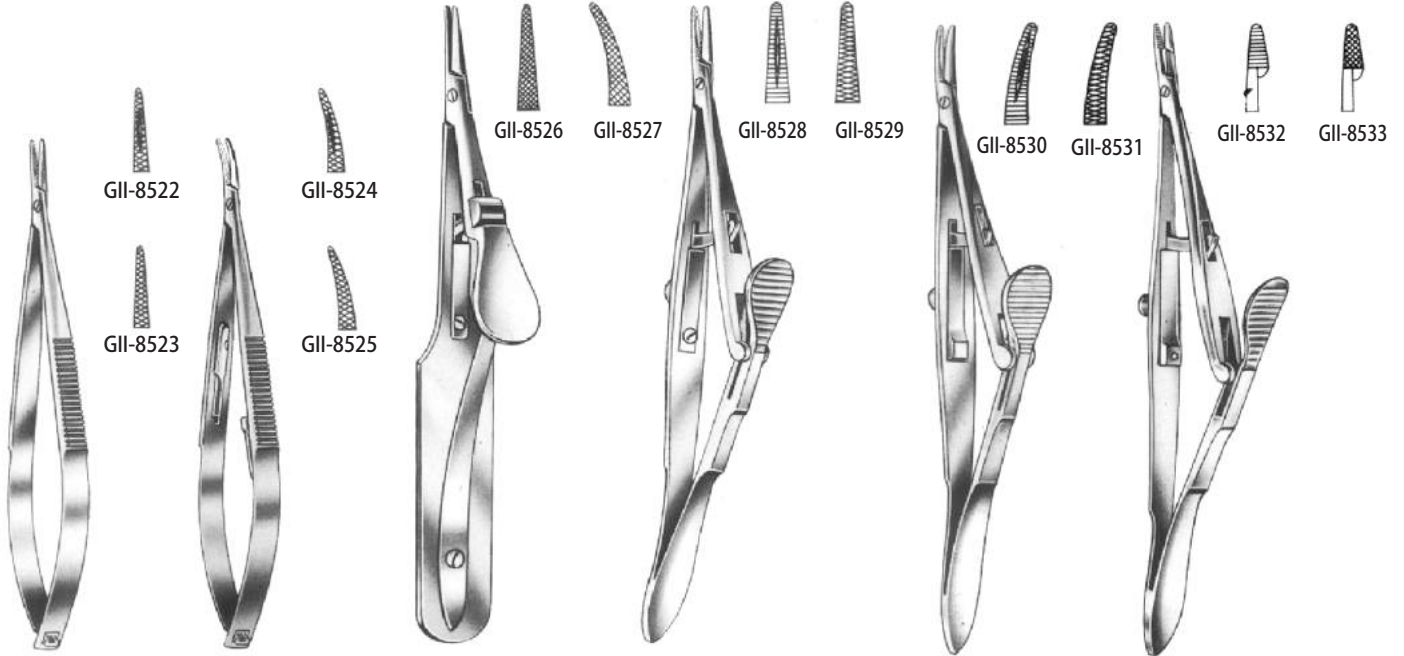
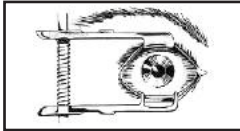

Paton Needle Holder
4½" (11 cm)

Paton Needle Holder
4½" (11 cm)

Arruga Needle Holder
5½" (14 cm)

Kalt Needle Holder
5½" (14 cm)

Kalt-Arruga Needle Holder
5½" (14 cm)

Castroviejo-Kalt Needle Holder
5¼" (13.5 cm)

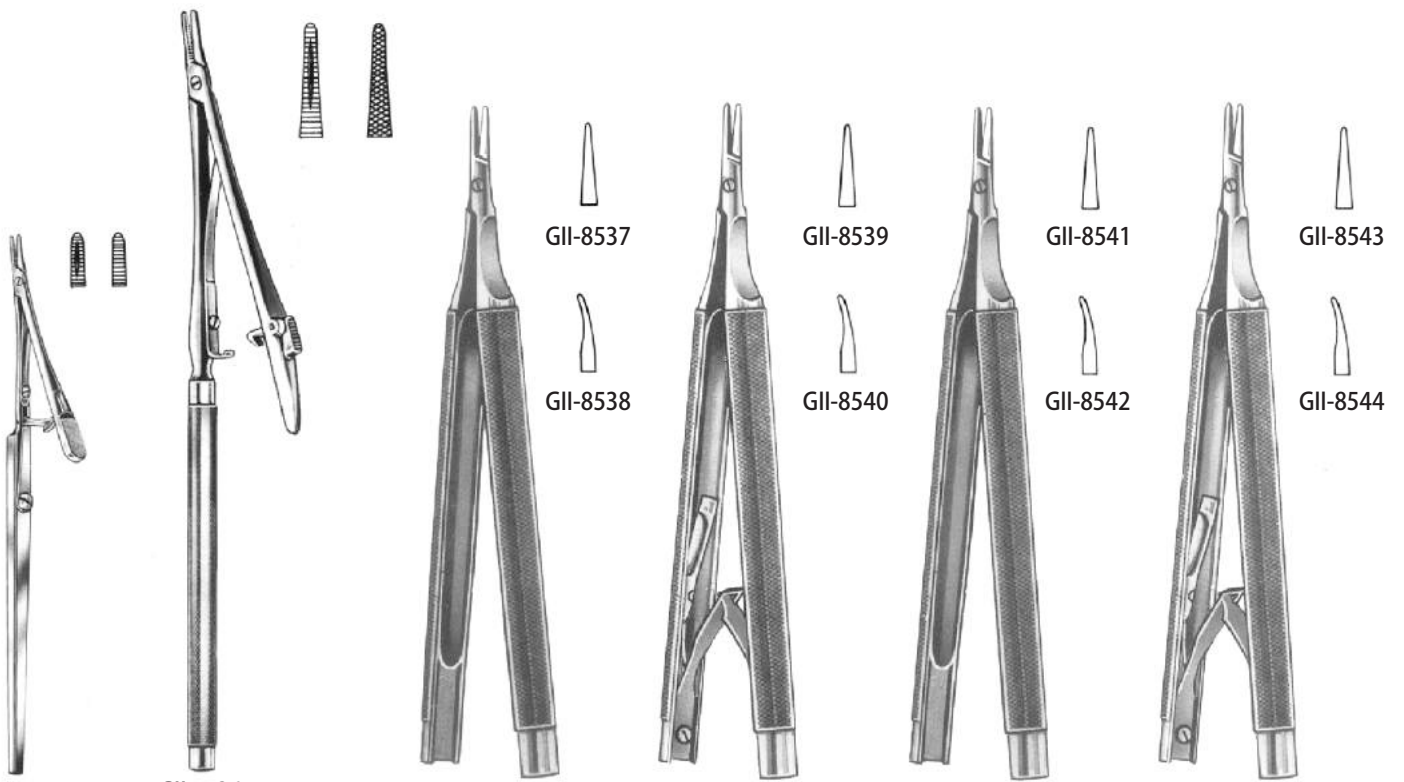

Stevens Needle Holder
ARTICLE # | SIZE
GII-8534 | 5" (13 cm)
GII-8535 | 6" (15 cm)

GII-8536
Potts-Smith
Needle Holder
8¾" (22 cm)

Castroviejo Blade Breaker
5¼" (13 cm)

Castroviejo Blade Breaker
5¼" (13 cm)

Castroviejo Blade Breaker
5¼" (13 cm)

Castroviejo Blade Breaker
5¼" (13 cm)

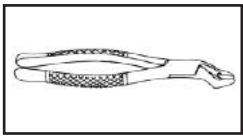

EXTRACTING FORCEPS

(American Pattern)

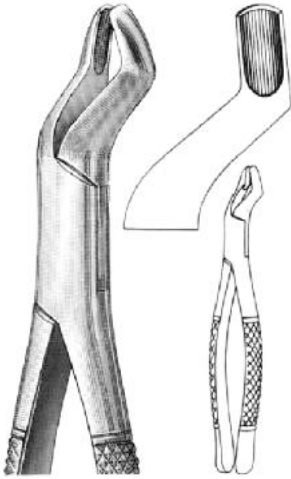

GII-8600
Upper Molars, Universal
10S

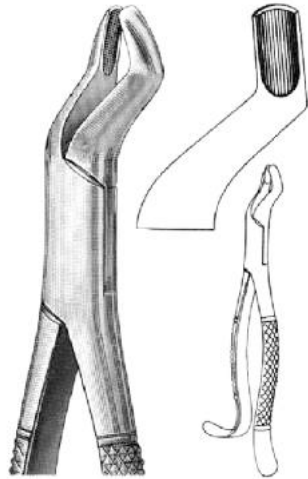

GII-8601
Upper Molars, Hook Handle,
Universal # 10H

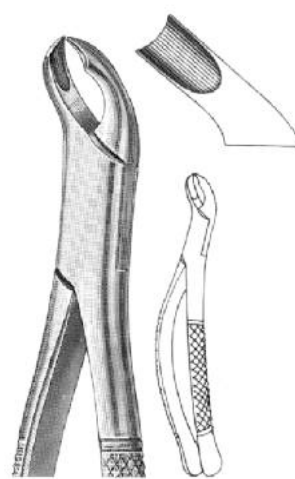

GII-8602
Upper Molars, Left
90

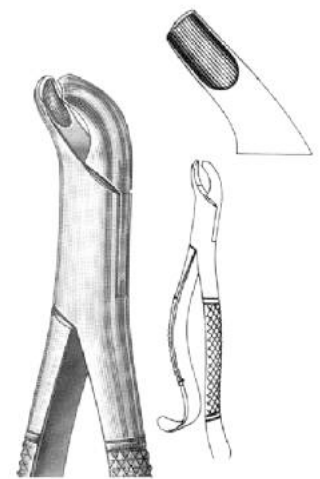

GII-8603
1st & 2nd Upper Molar, Left
18L

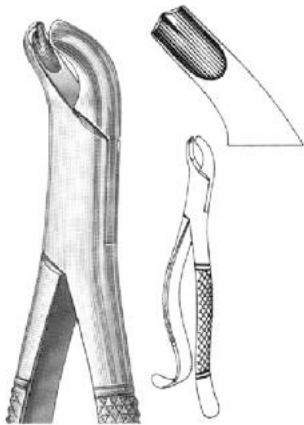

GII-8604
1st & 2nd Upper Molar, Right
18R

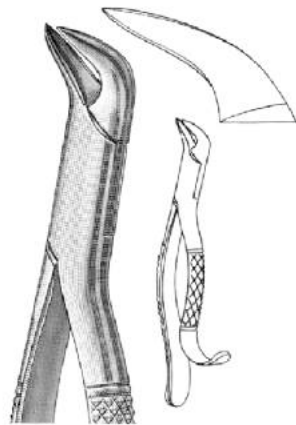

GII-8605
1st & 2nd Lower Molars,
Universal, Cow Horn # 16

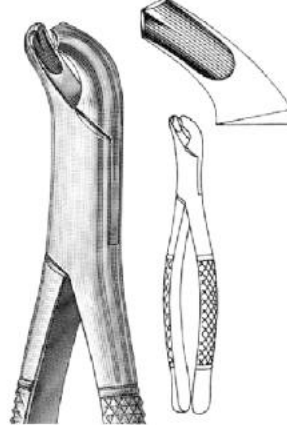

GII-8606
1st & 2nd Lower Molars,
Universal # 17

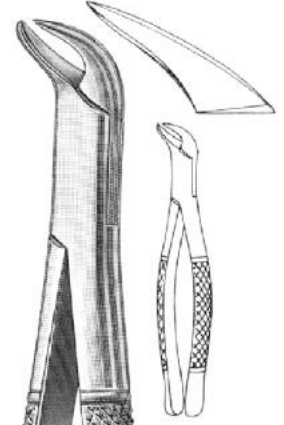

GII-8607
1st & 2nd Lower Molars,
Universal, Cow Horn # 23

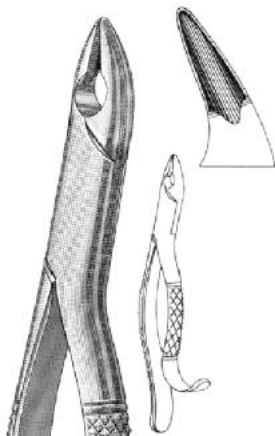

GII-8608
Lower Molars, Cuspids
& Bicuspids, Universal # 85

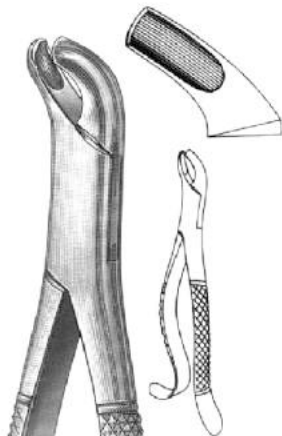

GII-8609
Upper Molars, Universal
24

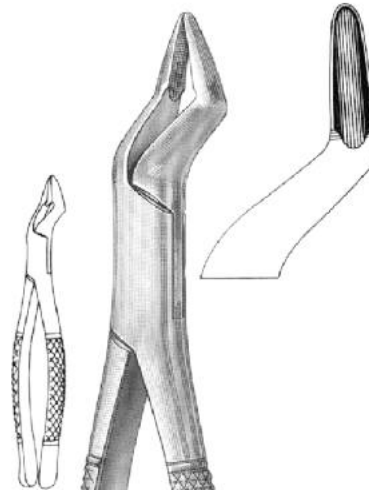

GII-8610
Upper Cuspid, Bicuspids
& Molars, Universal # 32

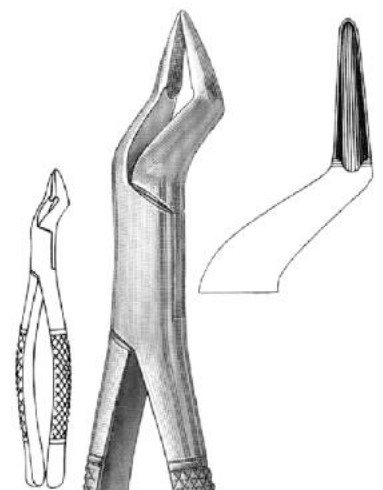

GII-8611
Upper Cuspid, Bicuspids
& Molars, Universal # 32A



EXTRACTING FORCEPS (American Pattern)

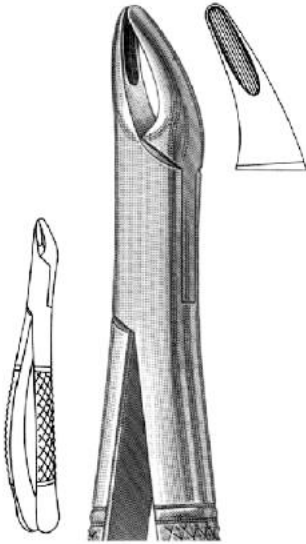
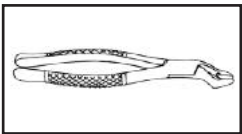

GII-8612

Upper Incisors, Cuspid, Bicuspid & Upper Anteriors; Split Beaks; Serrated & Roots; Universal # 150

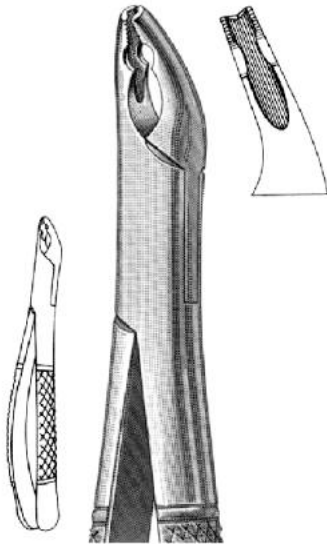

GII-8613

150AS

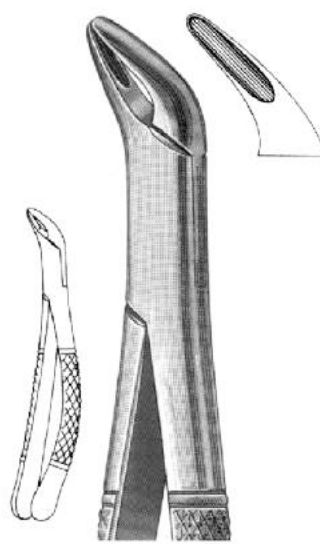

GII-8614

Lower Incisors, Cuspid, Bicuspids & Roots; Universal # 151

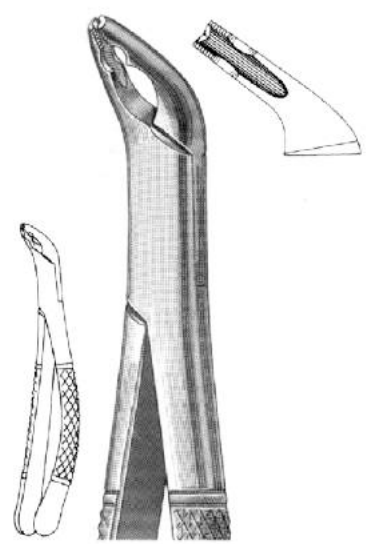

GII-8615

Lower Anteriors; Split Beaks; Serrated # 151 AS

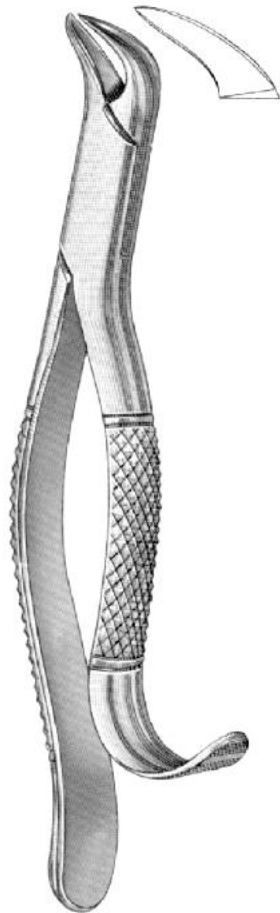

GII-8616

Pedo Lower Molars, Cow Horn # 16S

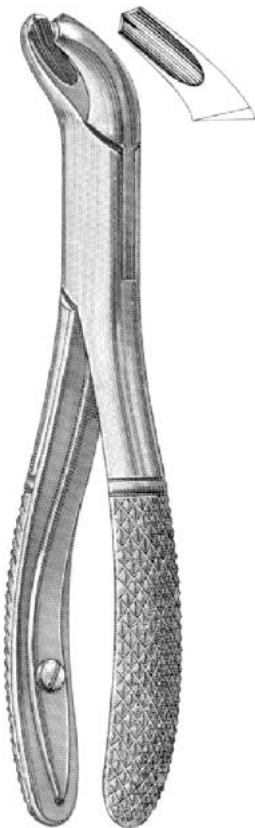

GII-8617

Pedo Lower Molars Universal, Spring Handle # 17S

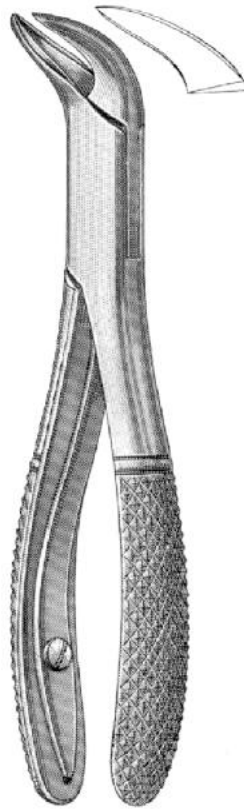

GII-8618

Pedo Lower Molars Universal, Spring Handle # 23S

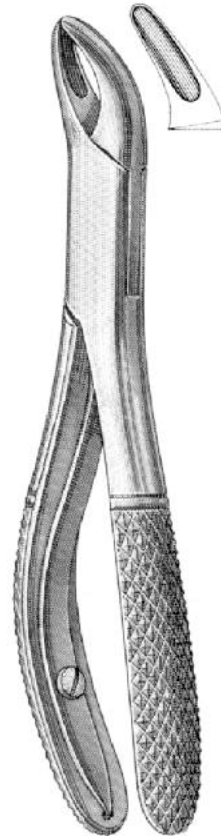

GII-8619

Pedo Upper Incisors, Bicuspid & Roots, Universal, Spring Handle # 150½S

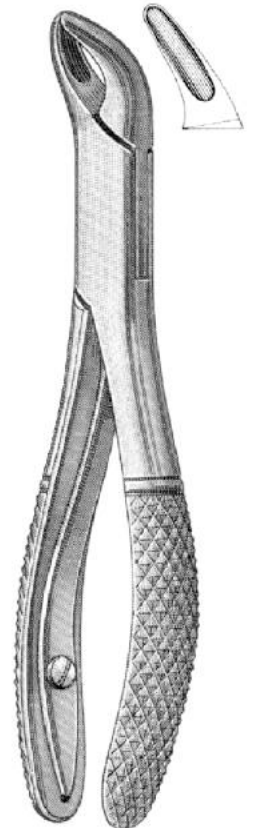

GII-8620

Pedo Lower Incisors, Bicuspids & Roots, Universal, Spring Handle # 151½S

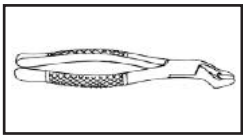

EXTRACTING FORCEPS

(European Pattern)

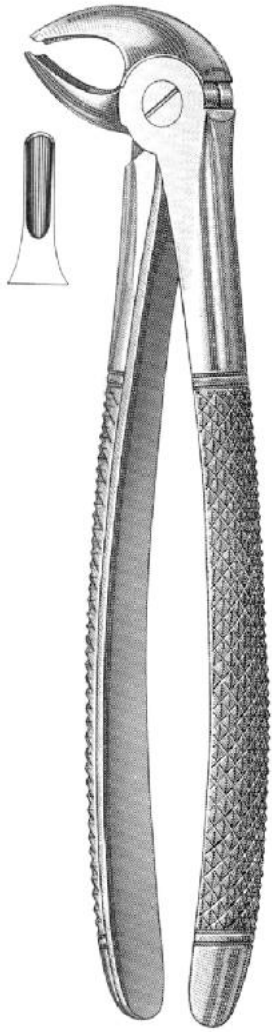

GII-8621
Lower Bicuspid, Universal
13

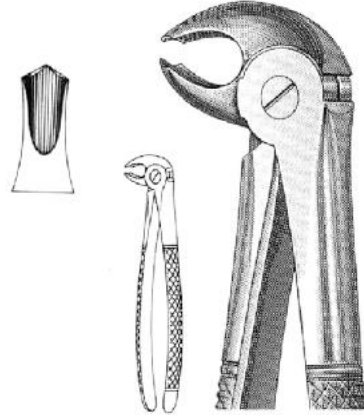

GII-8622
Lower Molars, Universal
22

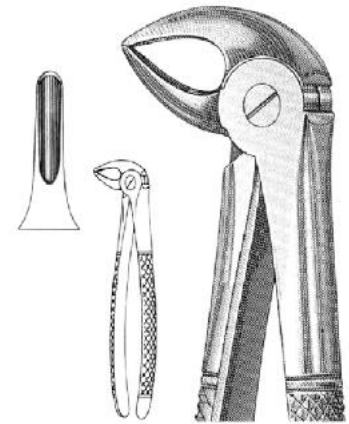

GII-8623
Lower Roots
23

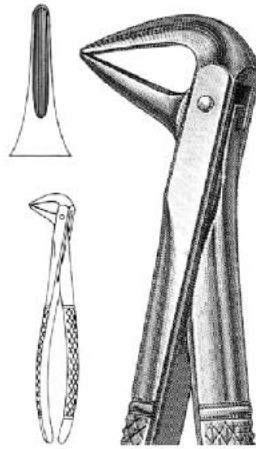

GII-8624
Lower Roots, Narrow Beaks
27

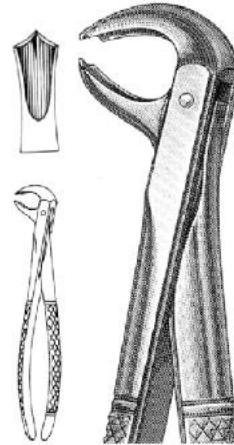

GII-8625
Lower Molars, Universal
73

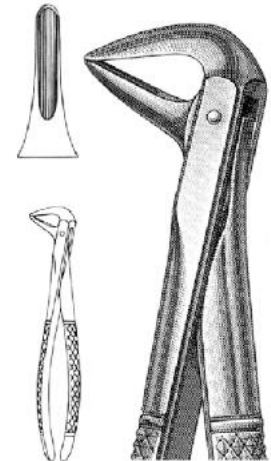

GII-8626
Lower Roots
74

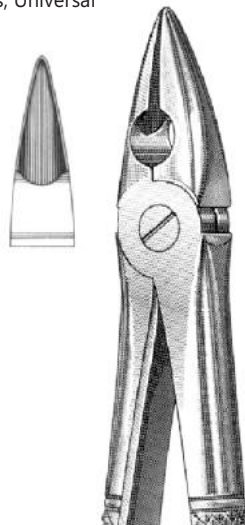

GII-8627

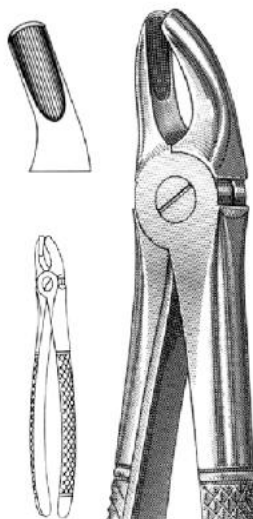

GII-8628

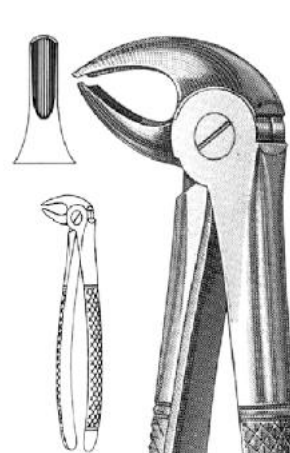

GII-8629

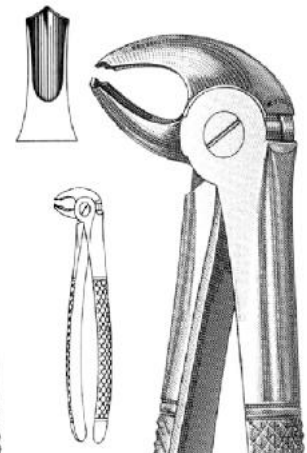

GII-8630

Upper Incisors, Cuspids, Bicuspid Upper 1st, 2nd and 3rd Lower Incisors, Cuspids, Bicuspid Lower 1st, 2nd and 3rd
and Roots, Mead, Universal # MD1 Molars, Mead, Universal # MD2 2nd Roots, Mead, Universal # MD3 Molars, Mead, Universal # MD4



ELEVATORS

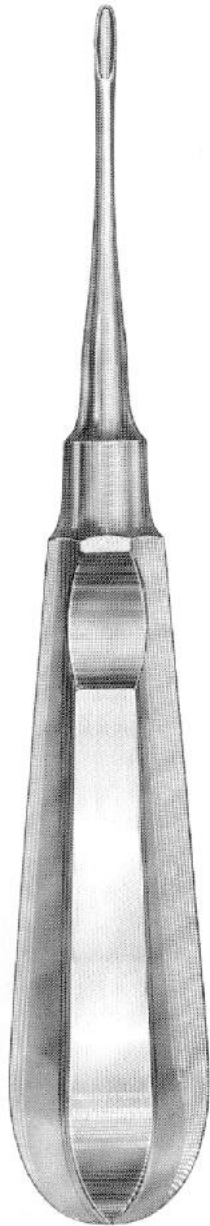
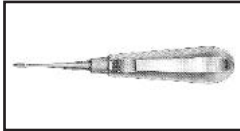

GII-8631



GII-8632



GII-8633



GII-8634



GII-8635

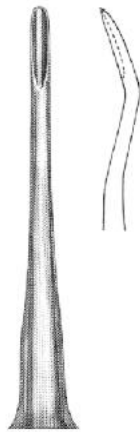

GII-8636



GII-8637

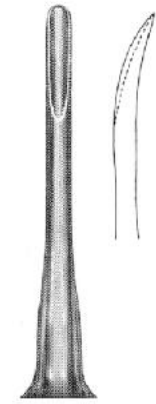

GII-8638



GII-8639



GII-8640



GII-8641



GII-8642

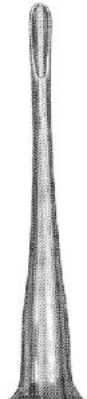

GII-8643

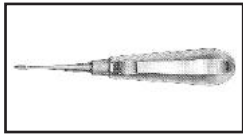

ELEVATORS



Root Tip



GII-8644



GII-8645



GII-8646

Heidbrink Root-Tip Picks

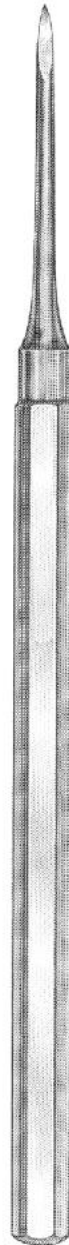

GII-8650



GII-8647



GII-8648

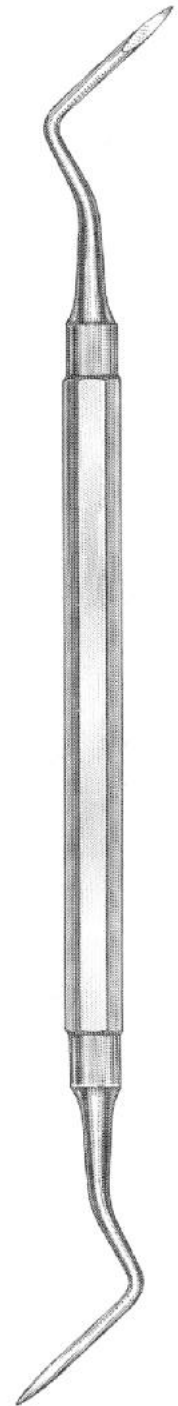

GII-8649



ELEVATORS

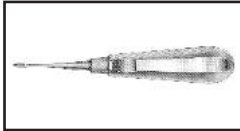

Potts Elevator

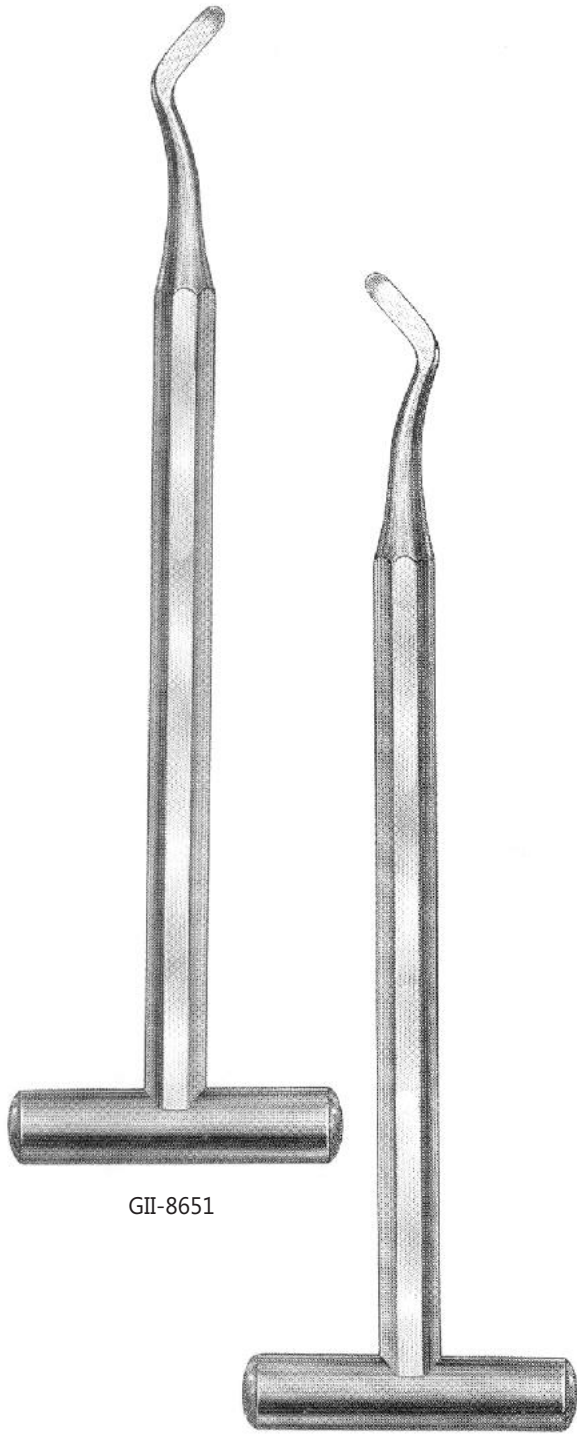

GII-8651

GII-8652

Priosteal Elevator

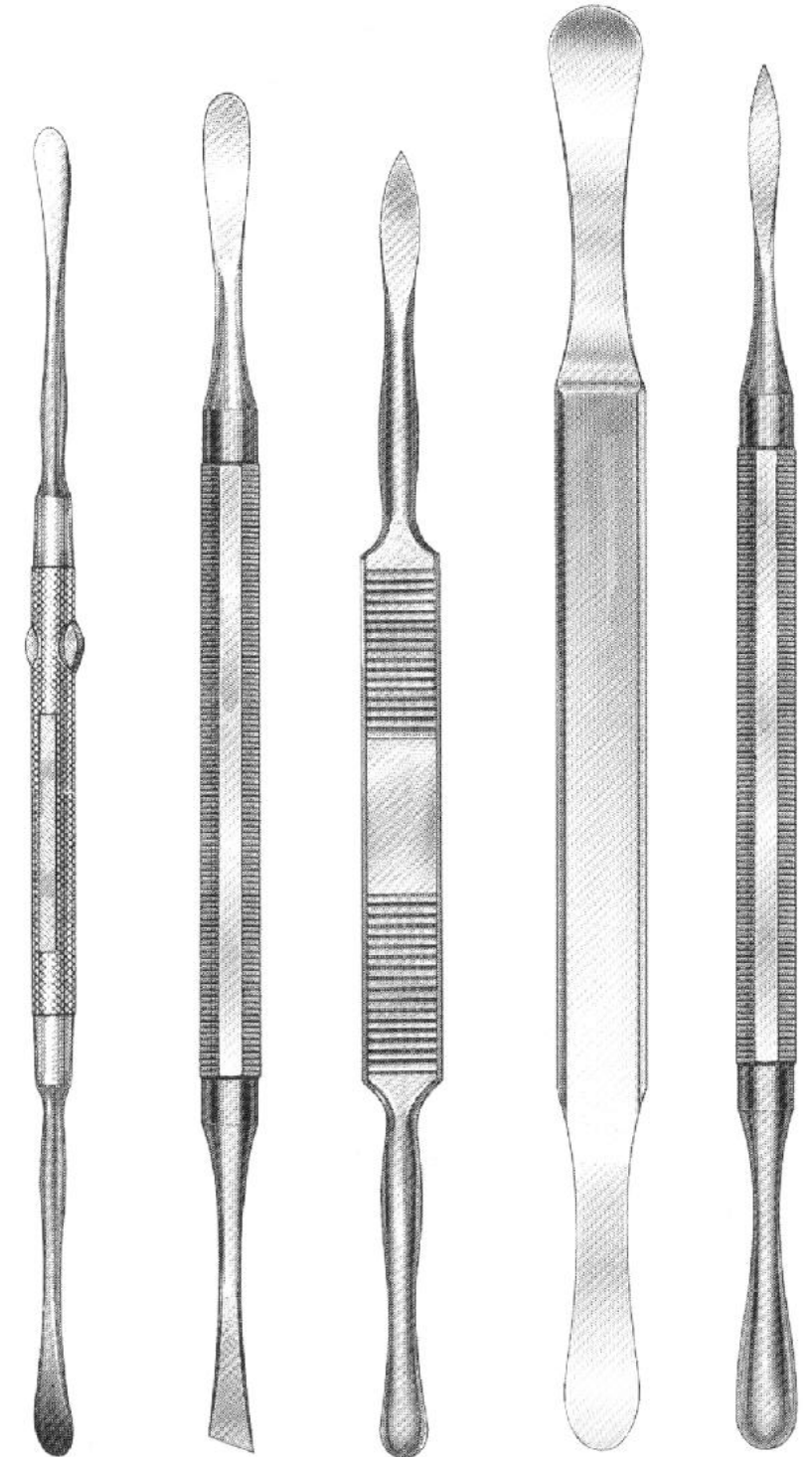

GII-8653
Freer

GII-8654
West

GII-8655

GII-8656
Seldin

GII-8657
Molt

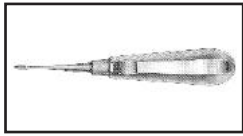

ELEVATORS



Lucas

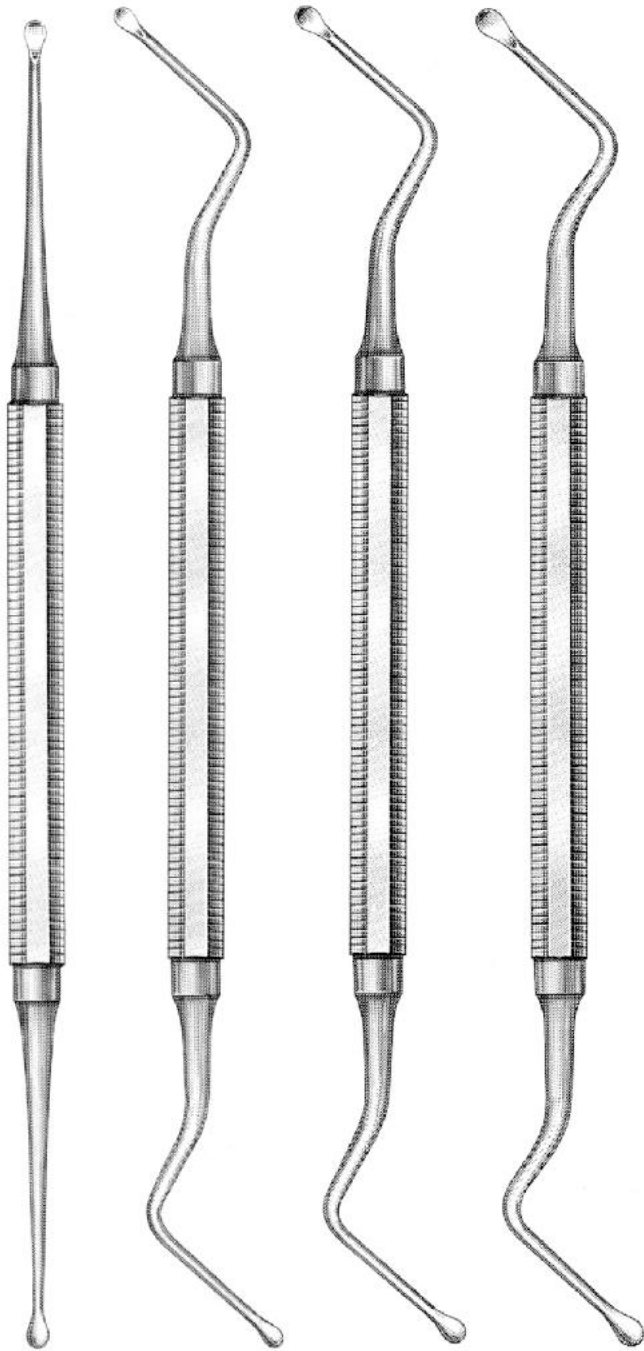

GII-8658

GII-8659

GII-8660

GII-8661

Muli

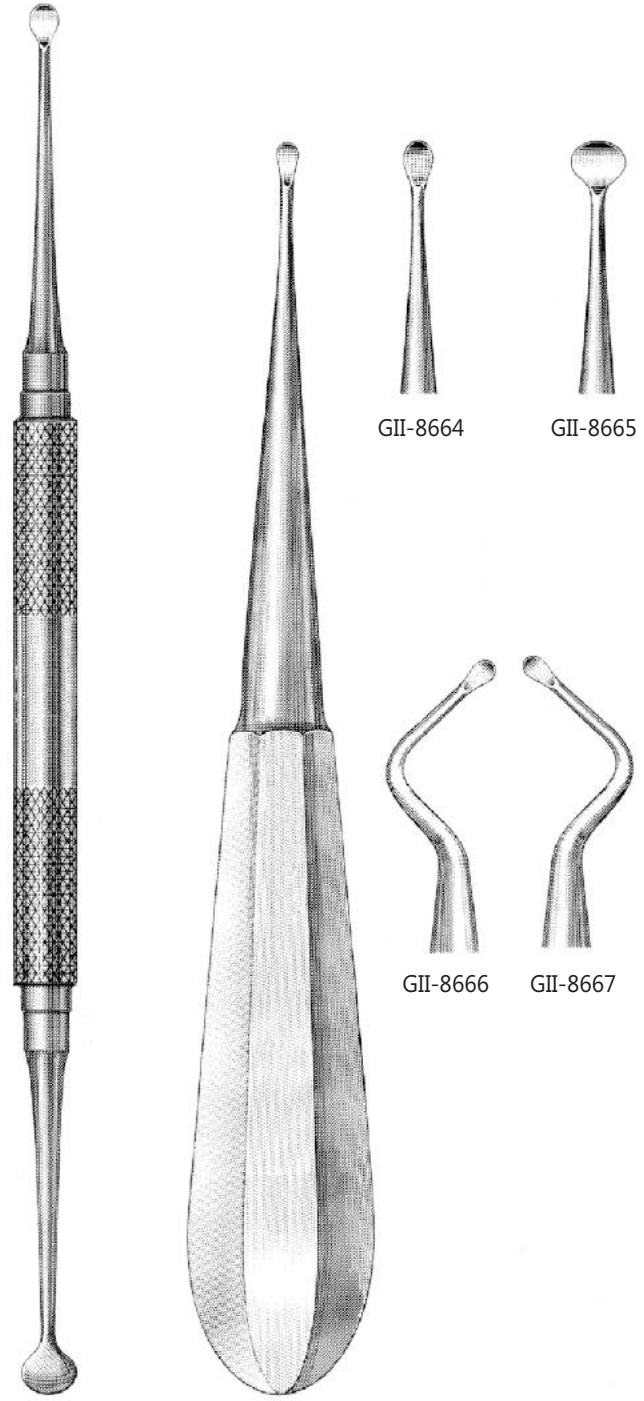

GII-8662

GII-8663

GII-8664

GII-8665

GII-8666

GII-8667



MIRROR + HANDLE

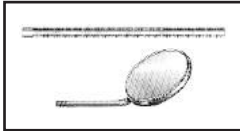

CONE SOCKET
Mirror Only

- GII-8668 #3
- GII-8669 #4
- GII-8670 #5



SIMPLE STEM
Mirror Only

- GII-8671 #3
- GII-8672 #4
- GII-8673 #5

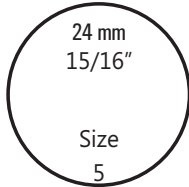
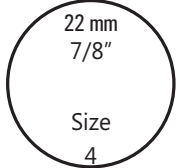
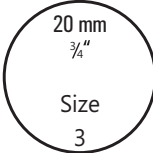

GII-8674
Octagonal Dental Mirror Handle



GII-8675
Delux Dental Mirror Handle



GII-8676
Octagonal Dental Mirror Handle, with millimeter rule

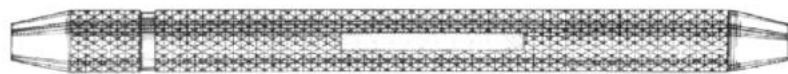

GII-8677
Double End Dental Mirror Handle



GII-8678
Autoclavable Front Surface Fiberglass Mirror

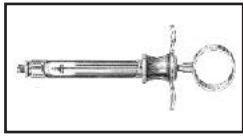

AMALGAM CARRIERS & SYRINGES



Amalgam Carriers Swiss Pattern

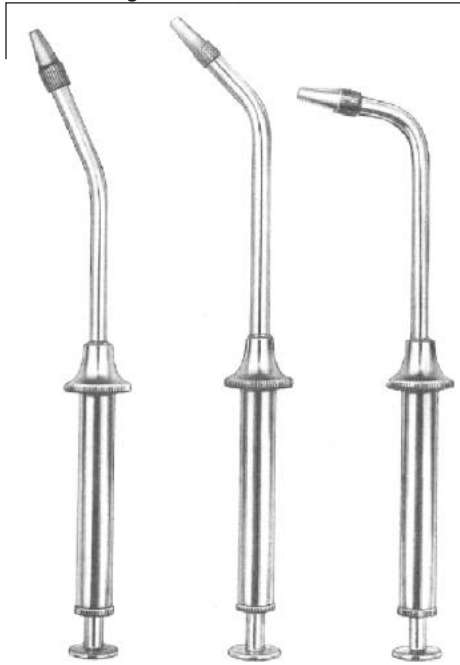

GII-8679

GII-8680

GII-8681

Amalgam Carriers

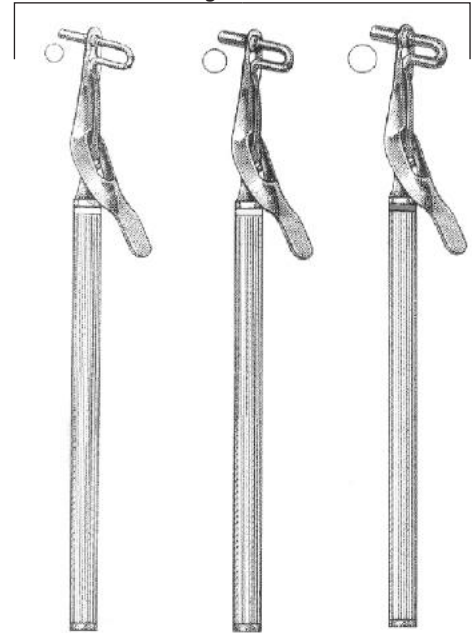

GII-8682
Small

GII-8683
Medium

GII-8684
Large

Amalgam Carriers (Double End)

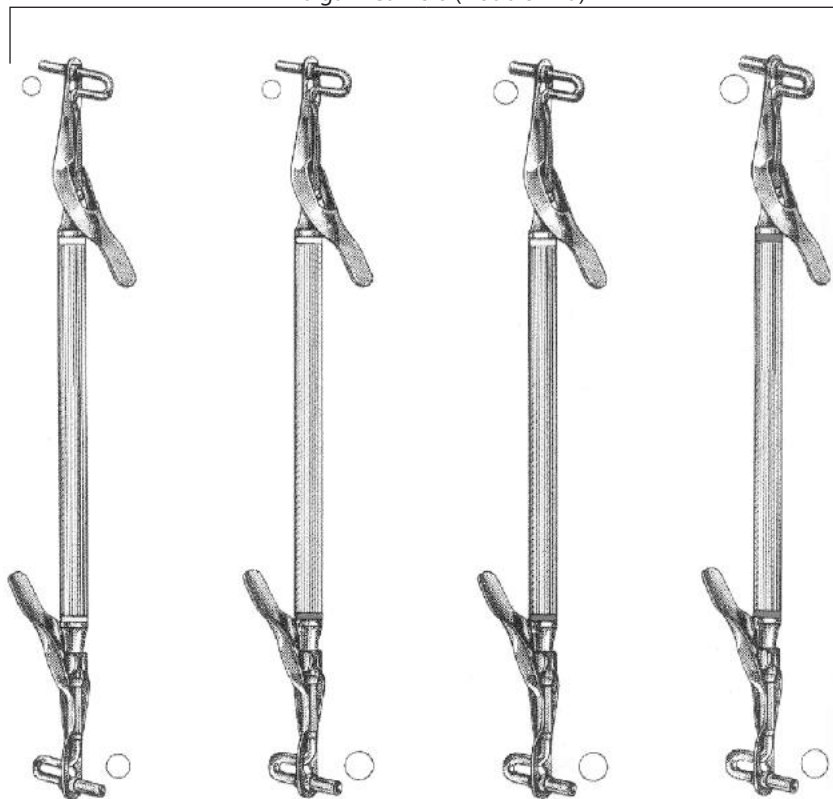

GII-8685
Large/Medium

GII-8686
Small/Large

GII-8687
Medium/Large

GII-8688
Large/Large



AMALGAM CARRIERS & SYRINGES

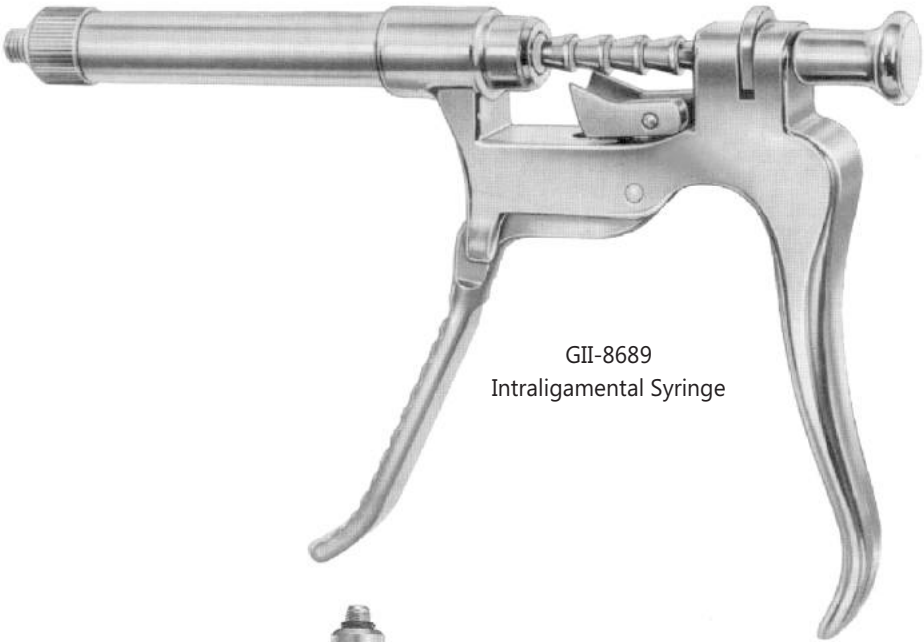

GII-8689
Intraligamental Syringe

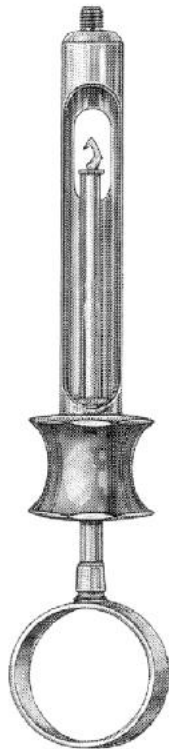

Aspirating Syringe

GII-8692	1,8 cc
GII-8693	2,2 cc



Self-Aspirating Syringe

GII-8694	1,8 cc
GII-8695	2,2 cc

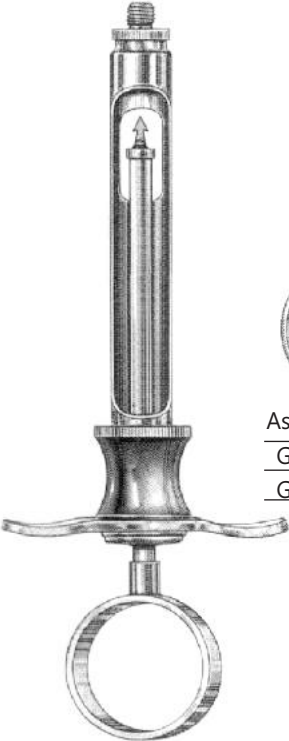

Aspirating Syringe

GII-8690	1,8 cc
GII-8691	2,2 cc

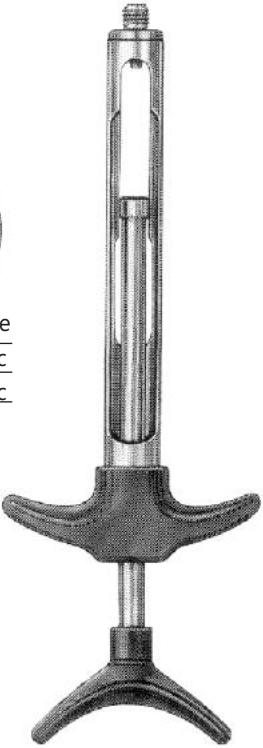

Self-Aspirating Syringe

GII-04D-015	1,8 cc
GII-04D-016	2,2 cc



Articulating Barrel Syringe
(Shown Open)

GII-8696	1,8 cc
GII-8697	2,2 cc

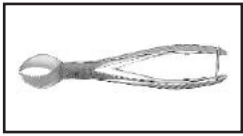

MISCELLANEOUS



GII-8698
Cow Horn



GII-8699
Stiff Blade

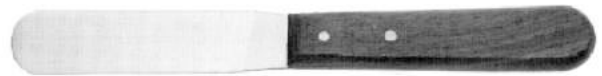

GII-8700
Stiff Blade



GII-8701
Extra Stiff Blade



GII-8702
Flexible Blade



GII-8703
Ball Chain



GII-8704
Non-Chill
Clear Plastic



TUFFLIMIRE, CALIPERS ETC

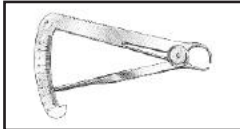

GII-8705

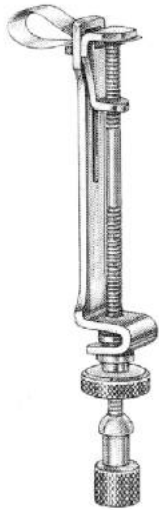

GII-8706

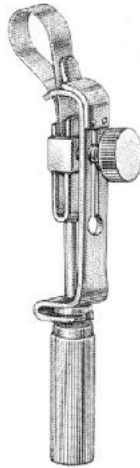

GII-8707



GII-8708
JUNIOR-CA



GII-8709
SENIOR-CA



GII-8710
Universal

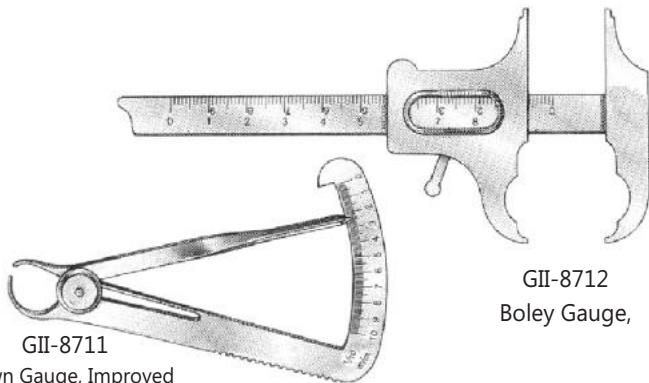

GII-8712
Boley Gauge,

GII-8711
Crown Gauge, Improved
Model with 2 Sided Scale

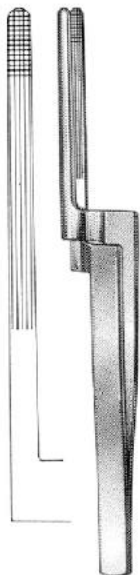

GII-8713

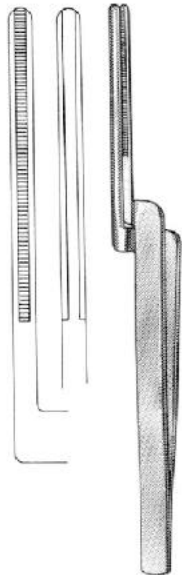

GII-8714

Standard Articulating Paper Forceps, POSIGRIP Articulating
Paper Forceps,



GII-8715
London College Tweezer
Smooth
6" (15 cm)



GII-8716
London College Tweezer
Serrated
6" (15 cm)



GII-8717
London College Tweezer
Serrated/with lock
6" (15 cm)



GII-8718
Meriam Serrated
6 1/4" (16 cm)



GII-8719
Meriam Smooth
6 1/4" (16 cm)



GENERAL DENTISTRY INSTRUMENTS



GRACEY CURETTE

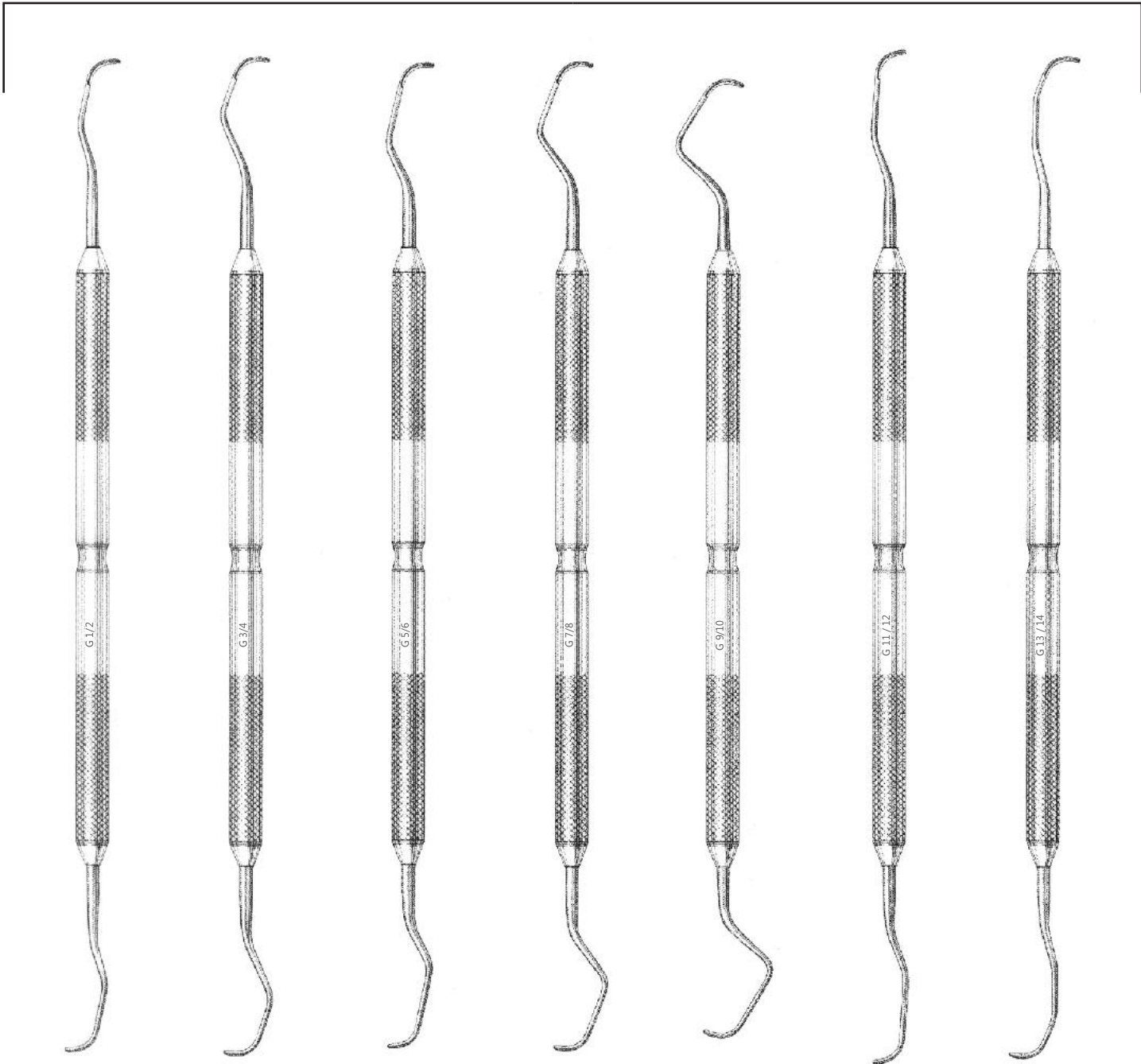

GII-8720

GII-8721

GII-8722

GII-8723

GII-8724

GII-8725

GII-8726



GENERAL DENTISTRY INSTRUMENTS



COLUMBIA CURETTES

MCCALLS CURETTES



GII-8727
4L-4R

GII-8728
13-14

GII-8729
2L-2R

GII-8730
13-14

GII-8731
13S-14S

GII-8732
17-18

GII-8733
17S-18S



GENERAL DENTISTRY INSTRUMENTS



WAX CARVERS

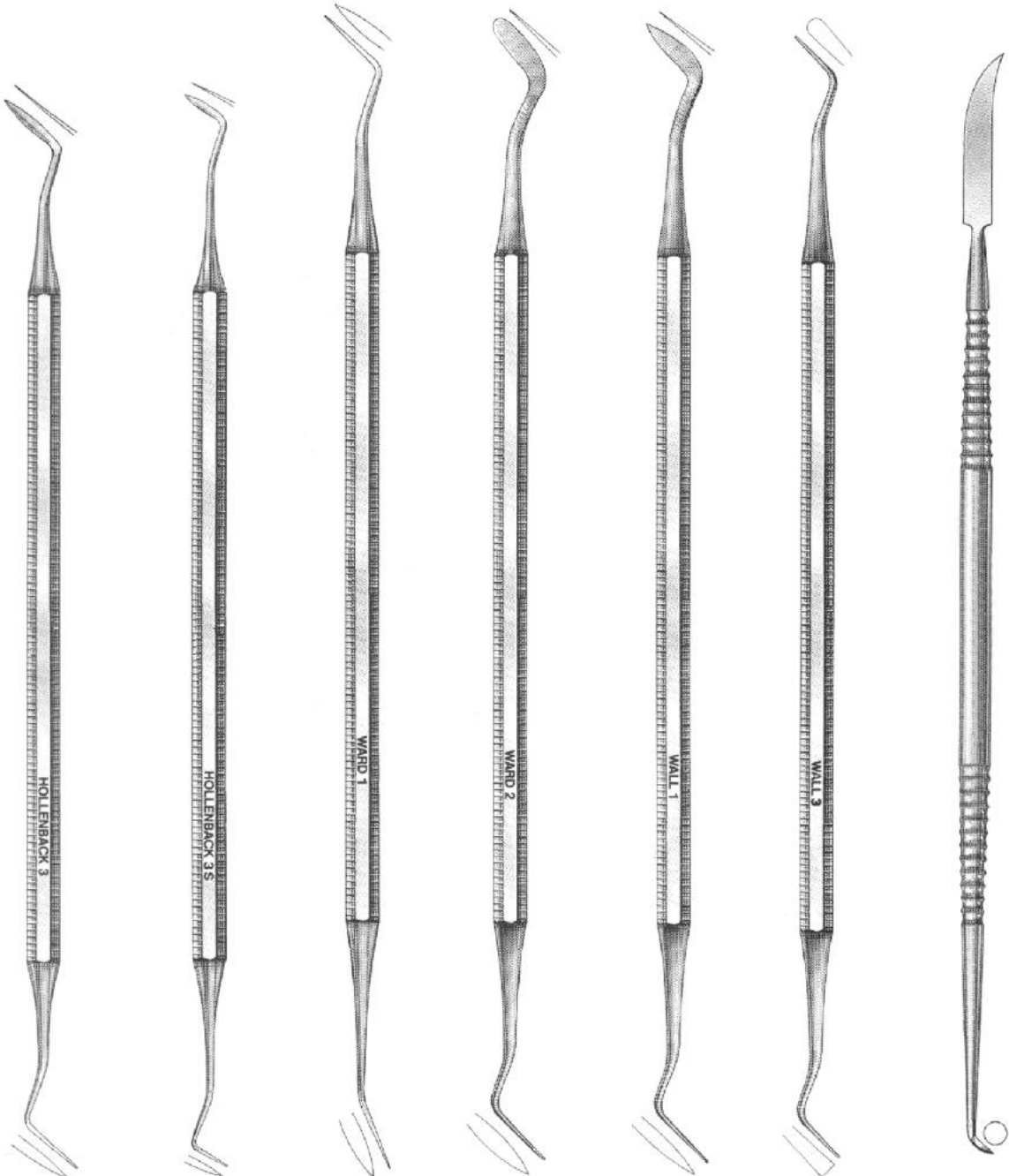

GII-8734
Hollenback

GII-8735
Hollenback

GII-8736
Ward

GII-8737
Ward

GII-8738
Wall

GII-8739
Wall

GII-8740
Lecron



GENERAL DENTISTRY INSTRUMENTS



EXCAVATORS

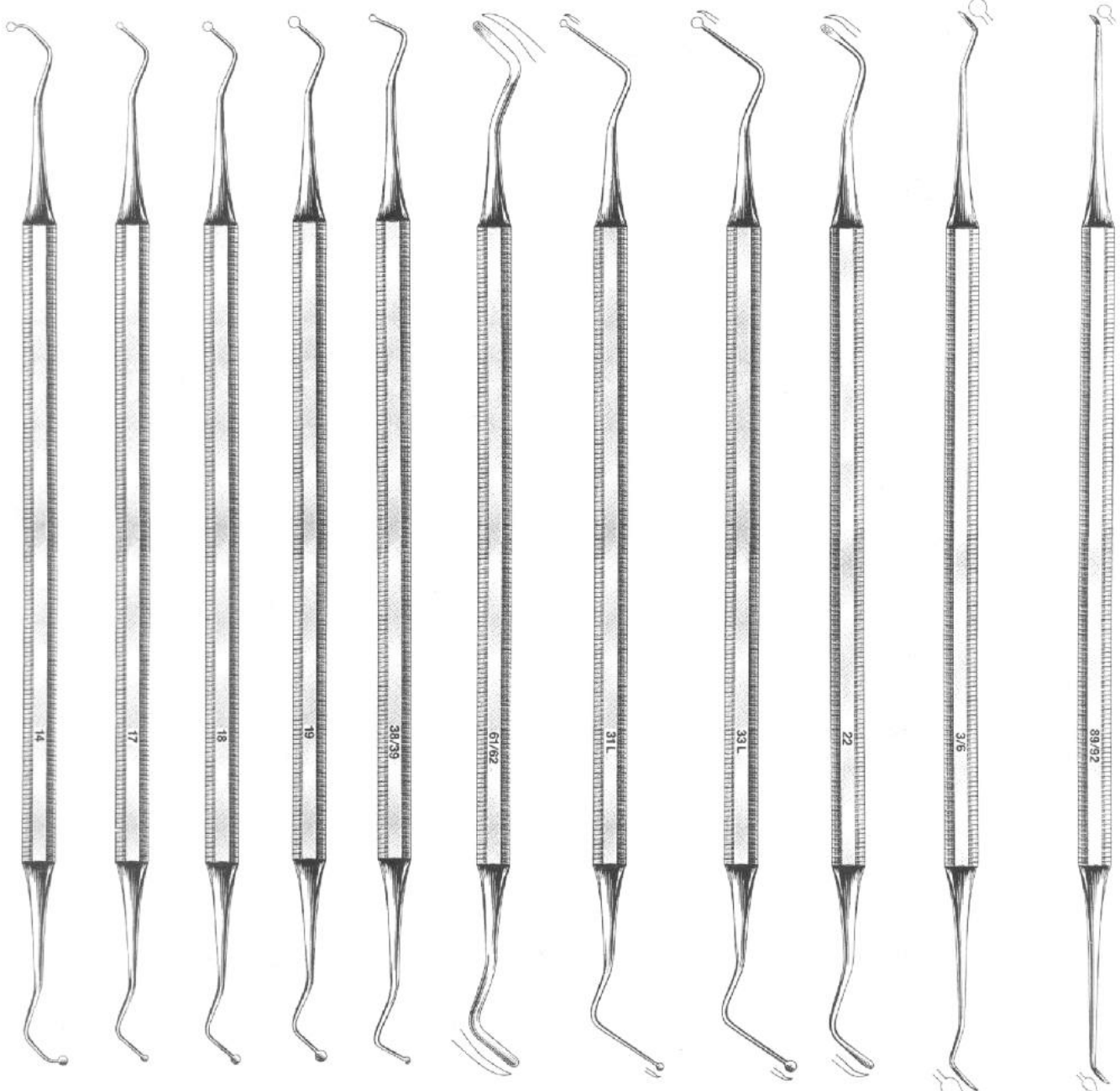

GII-8741

GII-8742

GII-8743

GII-8744

GII-8745

GII-8746

GII-8747

GII-8748

GII-8749

GII-8750
Cleoid/Discoid

GII-8751
Cleoid/Discoid



GENERAL DENTISTRY INSTRUMENTS



BURNISHERS



GII-8752

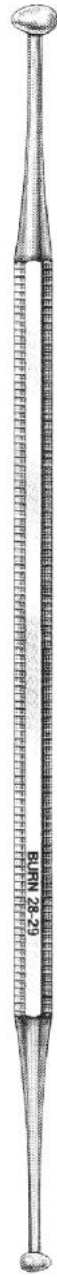

GII-8753

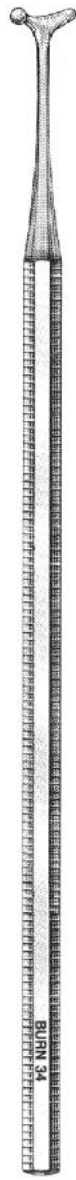

GII-8754

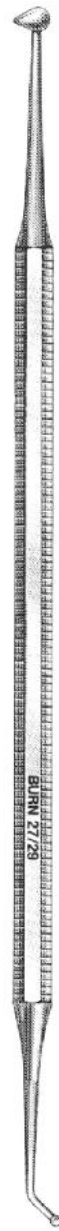

GII-8755

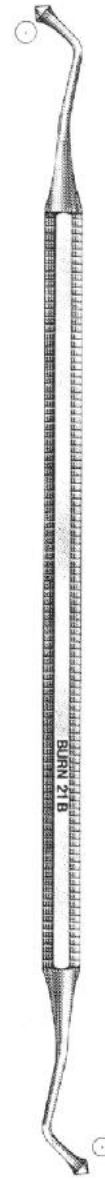

GII-8756

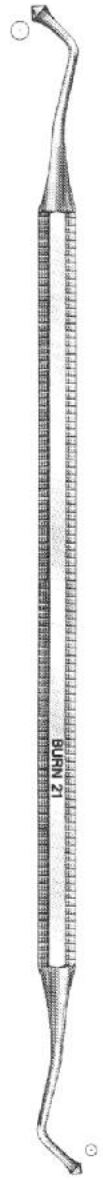

GII-8757



GENERAL DENTISTRY INSTRUMENTS



EXPLORERS





GENERAL DENTISTRY INSTRUMENTS



PROBES, EXPLORERS, CEMENT SPATULAS

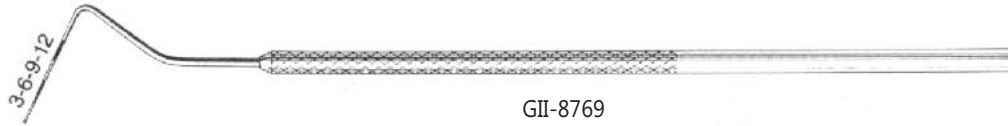

GII-8769



GII-8770
Probe/Explorer

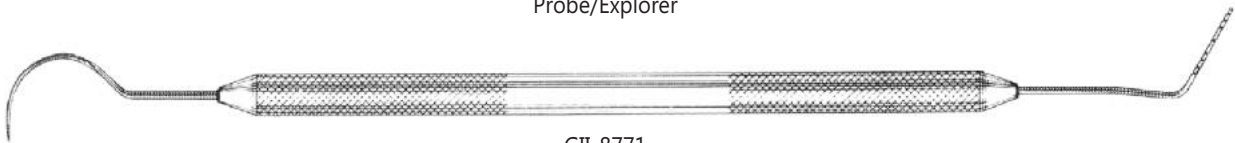

GII-8771
Probe/Explorer

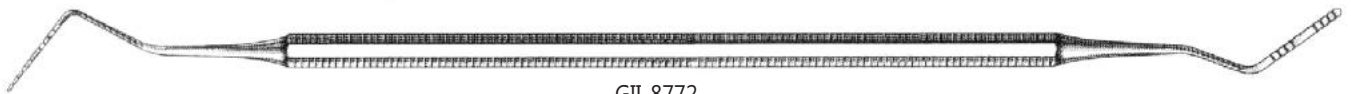

GII-8772
Probe

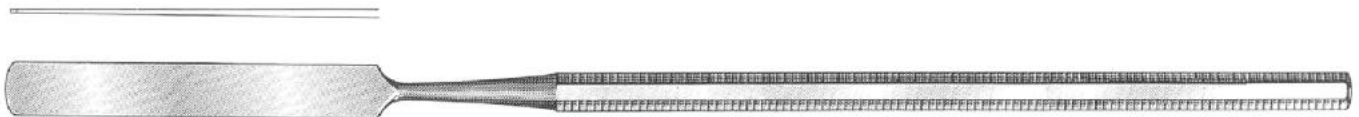

GII-8773
C-313

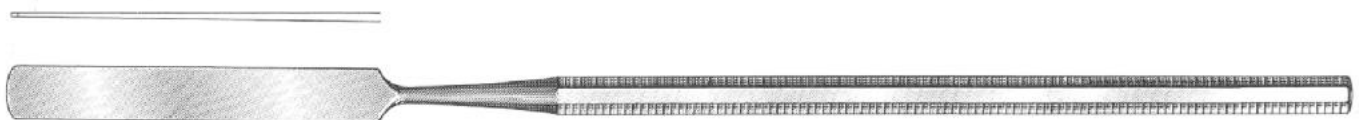

GII-8774

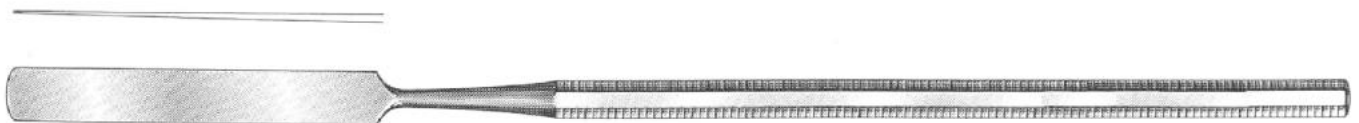

GII-8775



GII-8776



BONE FILES

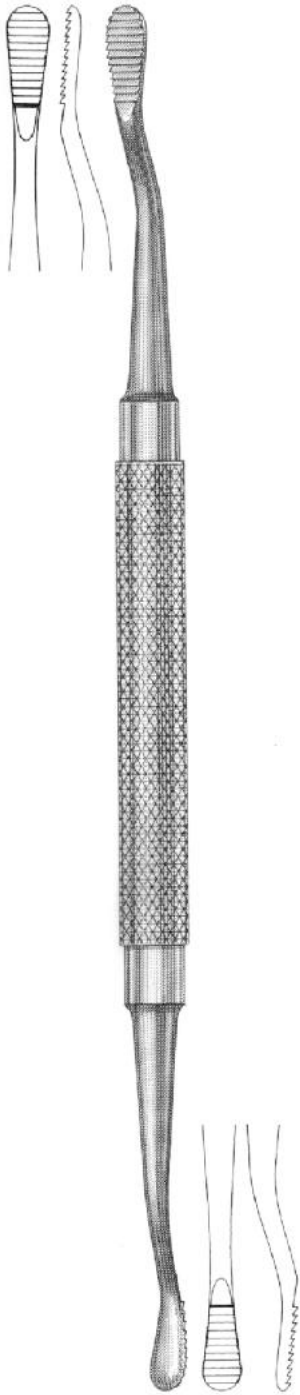

GII-8777
Howard

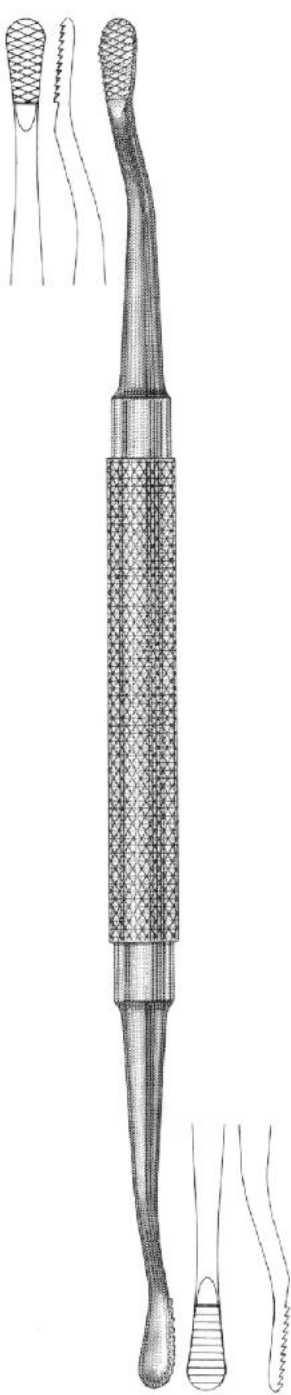

GII-8778
Howard

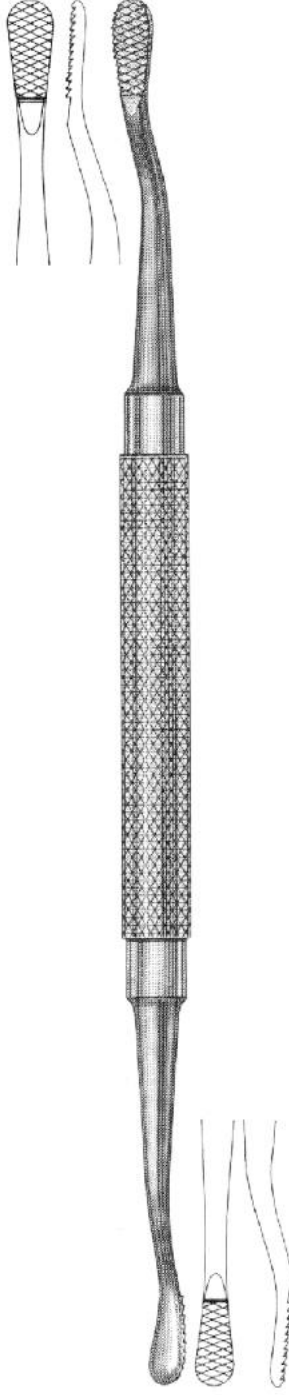

GII-8779
Howard

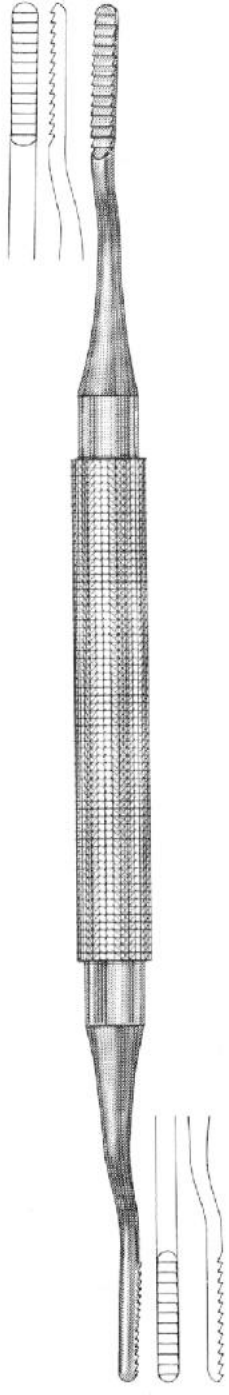

GII-8780
Polokoff



GENERAL DENTISTRY INSTRUMENTS



BONE CHISELS

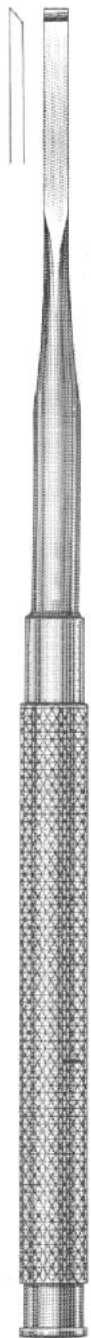

GII-8781
Gardner



GII-8782
Gardner



GII-8783
Gardner



GII-8784
Gardner



GII-8785
Wakefield

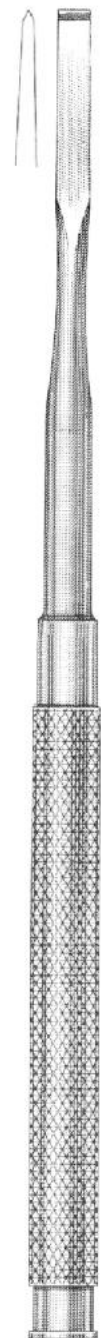

GII-8786
Wakefield



RUBBER DAM FORCEPS & CLAMPS



GII-8787
Brewer Rubber Dam Forceps



GII-8788
University of Washington
Rubber Dam Clamp Forceps



GII-8789
IV Type
Rubber Dam Clamp Forceps



GII-8790
IV Type Rubber Dam Punch



GII-8791
Ainsworth Rubber Dam Punch



GII-8792
Rubber Dam Frame



RUBBER DAM FORCEPS & CLAMPS



RUBBER DAM CLAMPS

LOWER MOLARS

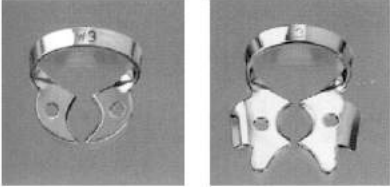

GII-8793



GII-8794



GII-8795



GII-8798



GII-8796



GII-8799



GII-8797



GII-8800



GII-8809



GII-8810



GII-8811



GII-8812



GII-8813



GII-8814

UPPER MOLARS



GII-8801



GII-8802



GII-8803



GII-8804

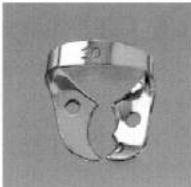

GII-8805



GII-8806



GII-8807



GII-8808

MOLARS

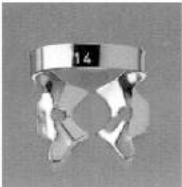

GII-8815



GII-8817



GII-8816



GII-8818



GII-8819

PRE MOLARS



GII-08D-023



GII-08D-024



GII-08D-025



GII-08D-026



GII-08D-027

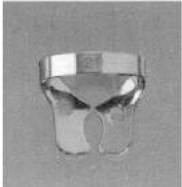

GII-08D-028

ANTERIOR



GII-8820



GII-8821

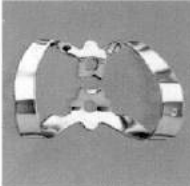

GII-8822

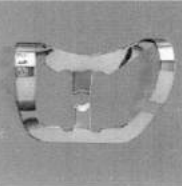

GII-8823



PLIERS

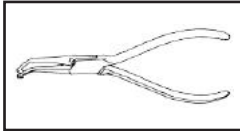

GII-8824
Pesse
5½" (14 cm)

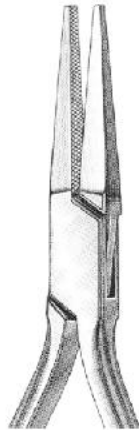

GII-8825
Lab and Office



GII-8826
Round Nose Plier
5½" (14 cm)



GII-8827
Langenbeck
Round Nose Plier
5½" (14 cm)

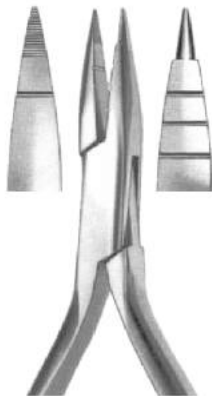

GII-8828
Also Suitable for Jaraback Technic
5½" (14 cm)



GII-8829
Angle
5 ⅞" (13 cm)



GII-8830
Angle
for wire up to 0.7 mm diam
5" (12,5 cm)



GII-8831
Adams
5" (12,5 cm)



GII-8832
Frevert
5" (12,5 cm)

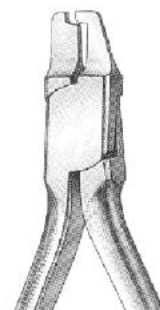

GII-8833
417-Crown and Shell

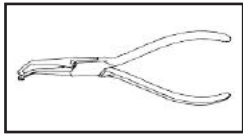

PLIERS

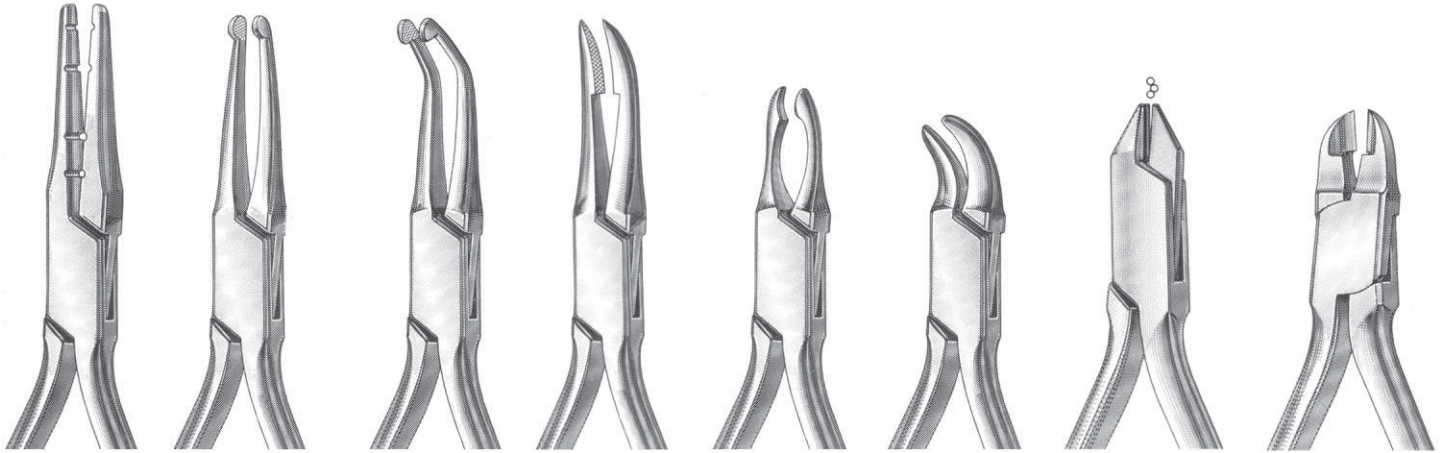

GII-8834 Wire Bending
 GII-8835 How Crown, Straight
 GII-8836 How Crown, Curved
 GII-8837 Weingart, Utility
 GII-8838 Johnson, Contouring
 GII-8839 Reynolds, Contouring
 GII-8840 Clasp Adjusting
 GII-8841 Carbide Tipped Ligature Cutter



GII-8842
 Universal Plier



GII-8843
 for wire up to 1.0 mm diam
 6 1/4 (16 cm)



GII-8844
 Angle Plier
 5 1/8 (13 cm)



GII-8845
 Angle Plier
 5 1/8 (13 cm)

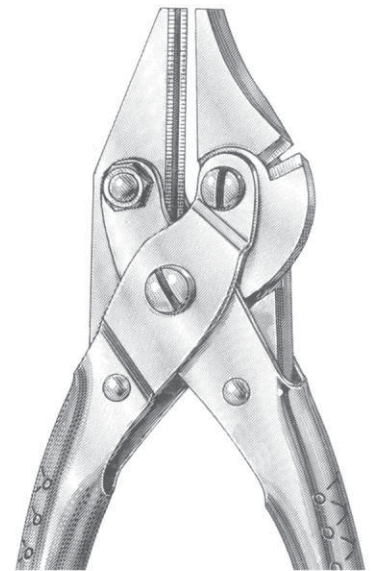

GII-8846
 Parallel Action Wire Cutter



E.M.S



GII-8847
Dissecting Set

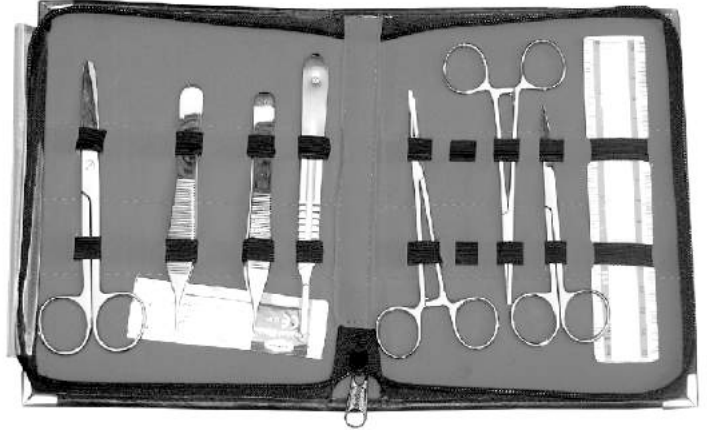

GII-8848
Dissecting Set



GII-8849
Advance Anatomy Dissecting Set



GII-8850
Professional Anatomy Dissecting Set

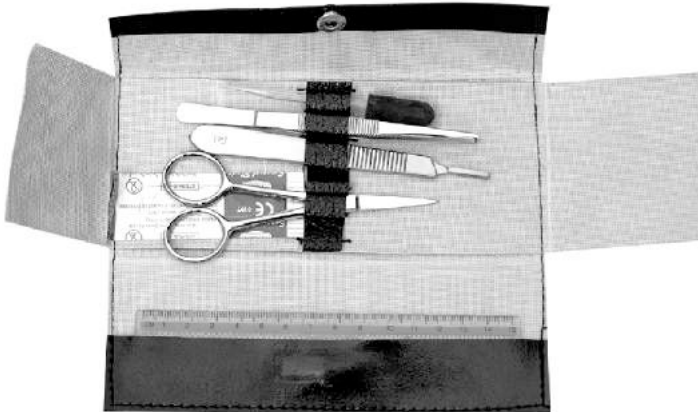

GII-8851
Comparative Anatomy Set

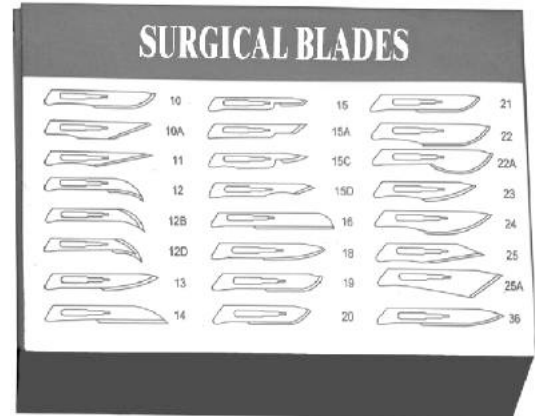

GII-8852
Surgical Blade Box of 100 Pcs
Available # 10, 11, 12, 13, 14, 20, 21, 22, 23, 24



E.M.S



Macintosh Laryngoscope Set
 GII-8853 Blade + 1 Handle
 GII-8854 Blade + 1 Handle
 GII-8855 Blade + 1 Handle



Macintosh Fiber Optical Laryngoscope Set
 GII-8856 Blade + 1 Handle
 GII-8857 Blade + 1 Handle
 GII-8858 Blade + 1 Handle



Miller Laryngoscope Set
 GII-8859 Blade + 1 Handle
 GII-8860 Blade + 1 Handle
 GII-8861 Blade + 1 Handle



Miller Fiber Optical Laryngoscope Set
 GII-8862 Blade + 1 Handle
 GII-8863 Blade + 1 Handle
 GII-8864 Blade + 1 Handle



GII-8864
 Diagnostic Set

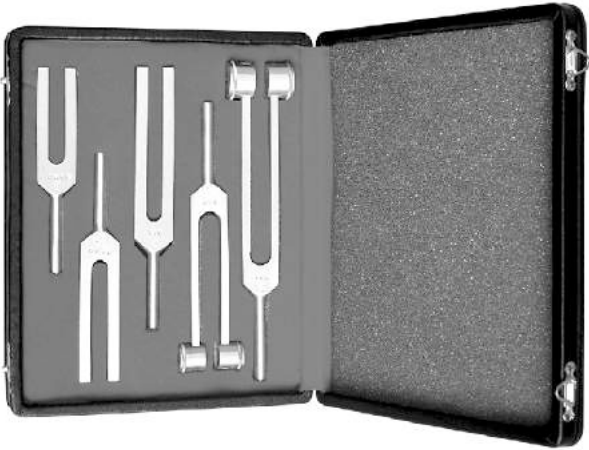

GII-8865
 Tuning Fork Set
 Consist:- C128, C256, C512, C1024, C2048



E.M.S



GII-8866
Sterile Scalpel Handle + Blade
(Disposable)



Utility Scissors

GII-8867	7¼"
GII-8868	5½"

Note: Mention Color Name After Article #



GII-8869
Lister Bandage Scissors 5½"
with Plastic Ring
Note: Mention Color Name After Article #

- Black
- Blue
- Red



GII-8870
Lister Bandage Scissors
5½" with Clip



GII-8871
Lister Bandage Scissors 5½"
Note: Mention Color Name After Article #

- Black
- Blue
- Red

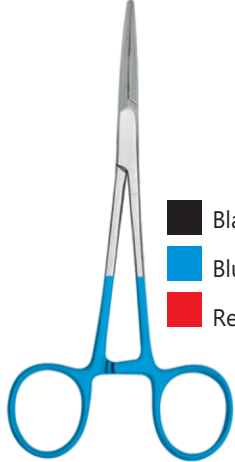

GII-8872
Kelly Forceps 5½"
Note: Mention Color Name After Article #

- Black
- Blue
- Red

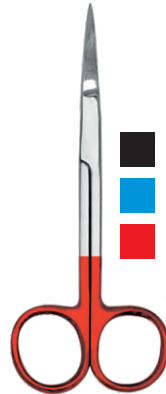

GII-8873
Iris Scissors 4½"
Note: Mention Color Name After Article #

- Black
- Blue
- Red



GII-8874
Splinter Forceps 4½"
Note: Mention Color Name After Article #

- Black
- Blue
- Red



GII-8875
Lister Bandage Scissors
3½" Full Gold



GII-8876
Rabiner Hammer



GII-8877
Taylor Hammer



GII-8878
Buck Hammer



GII-8879
Pin Wheel



GII-8880
Ring Cutter

GII-01E-035
Ring Cutter
Spare Blade



GII-8881
Ring Cutter with Safety Cap



GII-8882
Yong Tongue Forceps



Magil Forceps

GII-8883	6"
GII-8884	8"
GII-8885	10"
GII-8886	11"



E.M.S



GII-8887
Sterile Disposable Syringe
Box of 100 Pcs

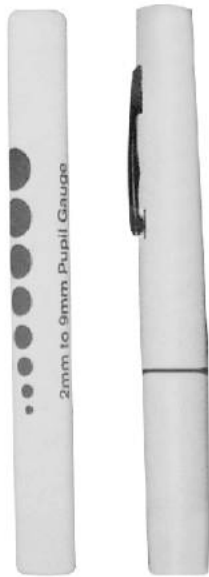

GII-8888
Pen Light with Pupil Gauge
Set of 6 Pcs



GII-8889
Thermometer Digital



GII-8890
Thermometer
Dual Mercury Scale



GII-8891
Window Puncher



GII-8892
Stethoscopes



GII-8893
Sterile Latex Gloves
Box of 12 Pcs



Glass Jar with Lid

GII-8894	3 x 3
GII-8895	7 x 4
GII-8896	7 x 3
GII-8897	6 x 6
GII-8898	5 x 5
GII-8899	4 x 4



GII-8900
Mayo Post Stand
(Single Post)



GII-8901
Mayo Post Stand
(Double Post)



VETERINARY INSTRUMENTS



GII-8902
Krey Schottler



GII-8903
Harms OB Hook



GII-8904
Ruggebergs
Spring Type
OB Double Eye Hook



GII-8905
Vienna Double Blunt Eye Hook
14 cm

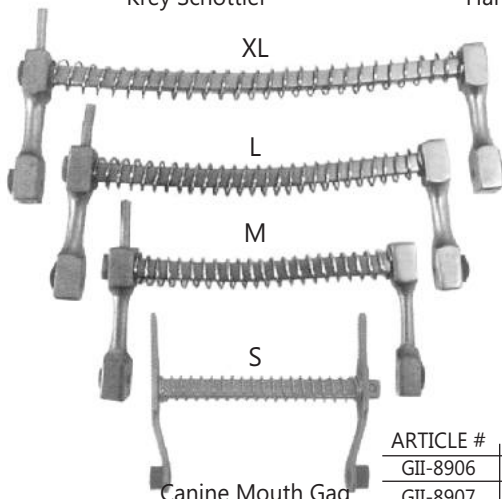

Canine Mouth Gag

ARTICLE #	SIZE
GII-8906	S
GII-8907	M
GII-8908	L
GII-8909	XL

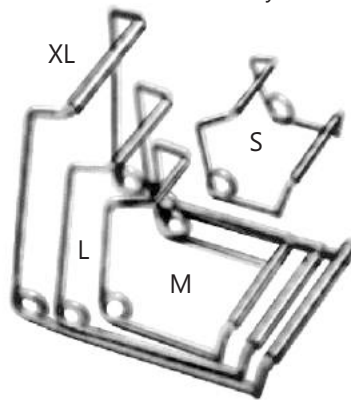

Smith Baxter Mouth Gag

ARTICLE #	SIZE
GII-8910	S
GII-8911	M
GII-8912	L
GII-8913	XL



GII-8914
Hoof Knife, Left



GII-8915
Hoof Knife, Right



GII-8916
Sheep Trimming Shears



GII-8917
White's Tonsil Scissors 4"



GII-8918
Molar Cutter

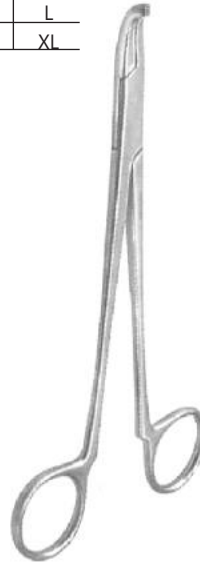

GII-8919
Molar Extraction
Forceps



GII-8920
Sheep Balling Gun
31,5 cm



GII-8921
Drench Pump



VETERINARY INSTRUMENTS



GII-8922
Bull Leap (Spring Loaded)
11 cm



GII-8923
Hauptner Hoof Tester
14½"



GII-8925
Bull Lead



GII-8924
Standard Hoof Tester
13"



GII-8927
Harm's Style Bull Lead
18 cm



GII-8928
Adjustable Hoof Tester



GII-8926
Bull Lead
without Chain
22 cm



GII-8930
Large Hoof Tester
13"



GII-8929
Bull Lead with Chain
22 cm



GII-8933
Steel Hoof Trimmer

GII-8931
Molar Cutter
56 cm, Straight

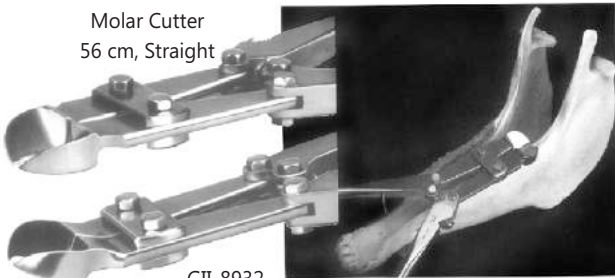

GII-8934
Hoof Trimmer
20"



GII-8932
Molar Cutter
56 cm, Curved

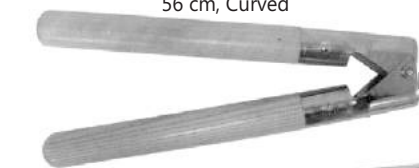

GII-8935
Barne's Dehorner
12"



GII-8937
Ryding Hoof Tester



GII-8936
Dehorner Heavy Duty
17"



VETERINARY INSTRUMENTS

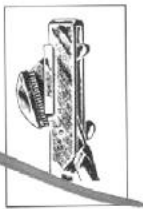
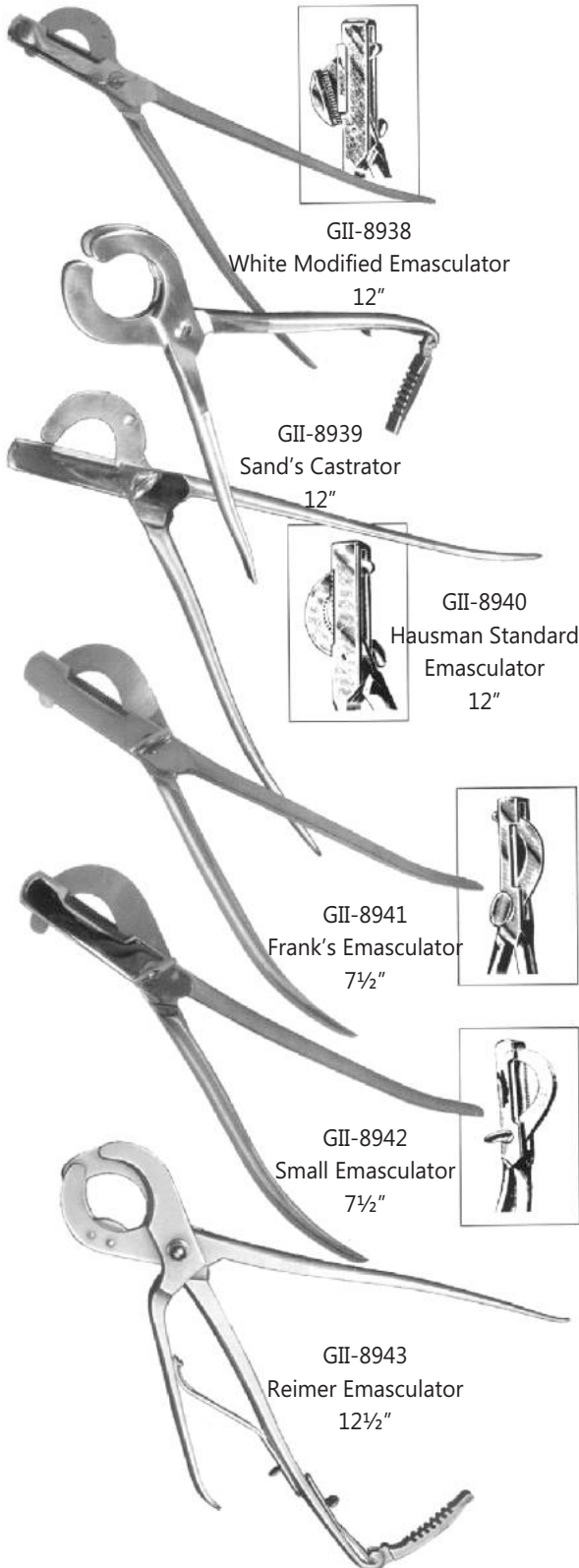

GII-8938
White Modified Emasculator
12"



GII-8940
Hausman Standard
Emasculator
12"



GII-8941
Frank's Emasculator
7½"



GII-8942
Small Emasculator
7½"

GII-8943
Reimer Emasculator
12½"

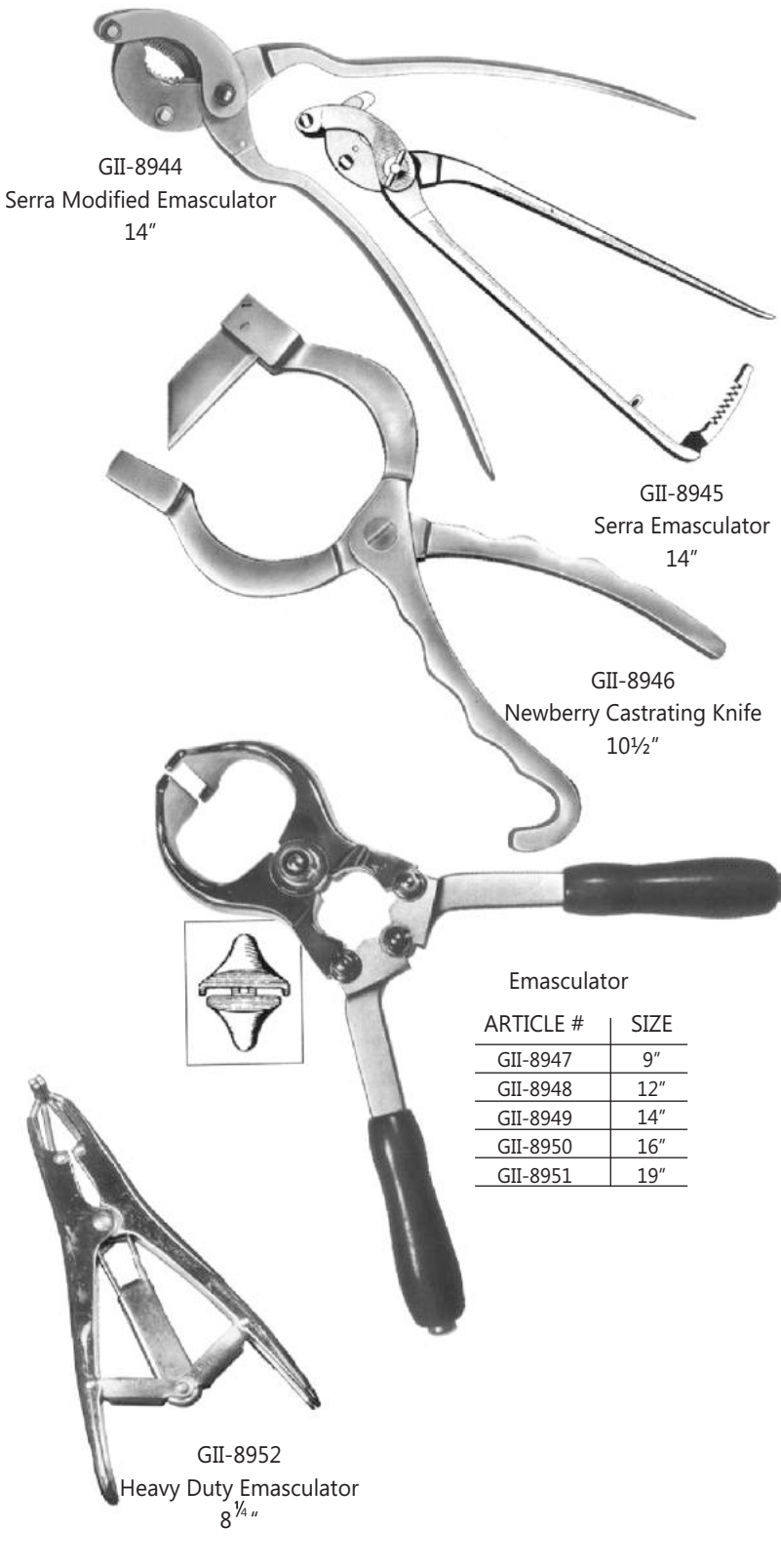

GII-8944
Serra Modified Emasculator
14"

GII-8945
Serra Emasculator
14"

GII-8946
Newberry Castrating Knife
10½"



Emasculator

ARTICLE #	SIZE
GII-8947	9"
GII-8948	12"
GII-8949	14"
GII-8950	16"
GII-8951	19"

GII-8952
Heavy Duty Emasculator
8¼"

Pedicure



GIB-01
Moon Shape



GIB-02
Half Moon Shape



GIB-03
Regular



GIB-04
Barral Spring



GIB-05
Heavy Duty
Multy Action



GIB-06
Single Spring
(small)



GIB-07
Ingrown
Single Spring



GIB-08
Ingrown
Double Spring



GIB-09
Ingrown
single Spring



GIB-10
Ingrown
single Spring



GIB-11
Ingrown
Scissor Handle



GIB-12
Ingrown
Scissor Handle



Manicure Nippers



GIB-13
Acrylic Nipper
Supreme



GIB-14
Acrylic Nipper
Gold Finish



GIB-15
Acrylic Nipper
Cobalt



GIB-16
Acrylic Nipper
Mirror Finish



GIB-17
Straight Handle
Cobalt Finish



GIB-18
Long Handle
Cobalt Finish



GIB-19
Short Finish
Cobalt Finish



GIB-20
Slimmer
Cobalt Finish



GIB-21
Delicate
Satin Finish



GIB-22
Delicate
Satin Finish



GIB-23
Economy
Mirror Finish



GIB-24
Deluxe
Gold

Manicure & Podicure Instruments

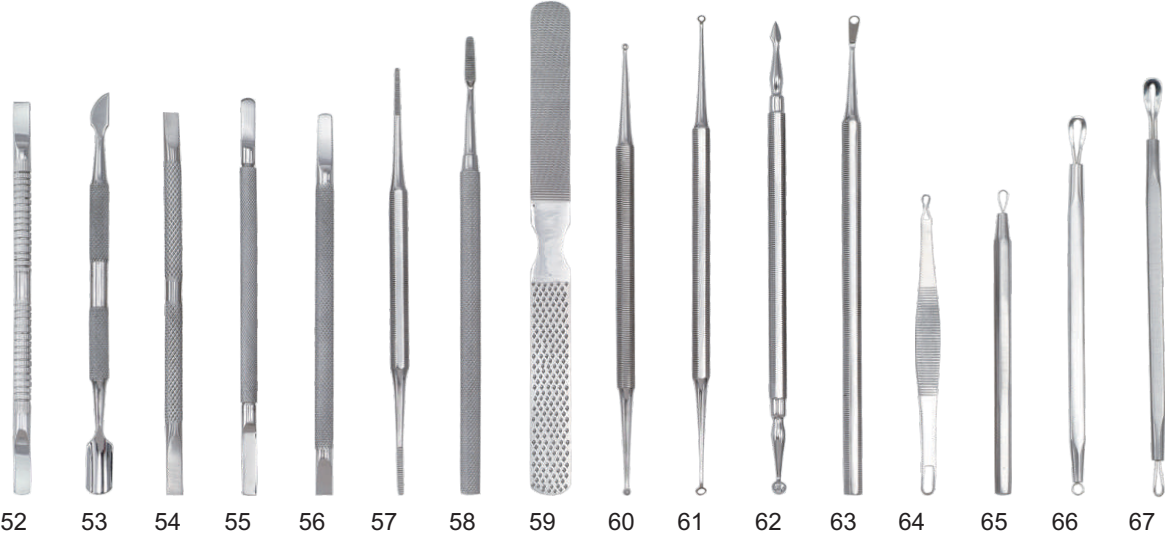
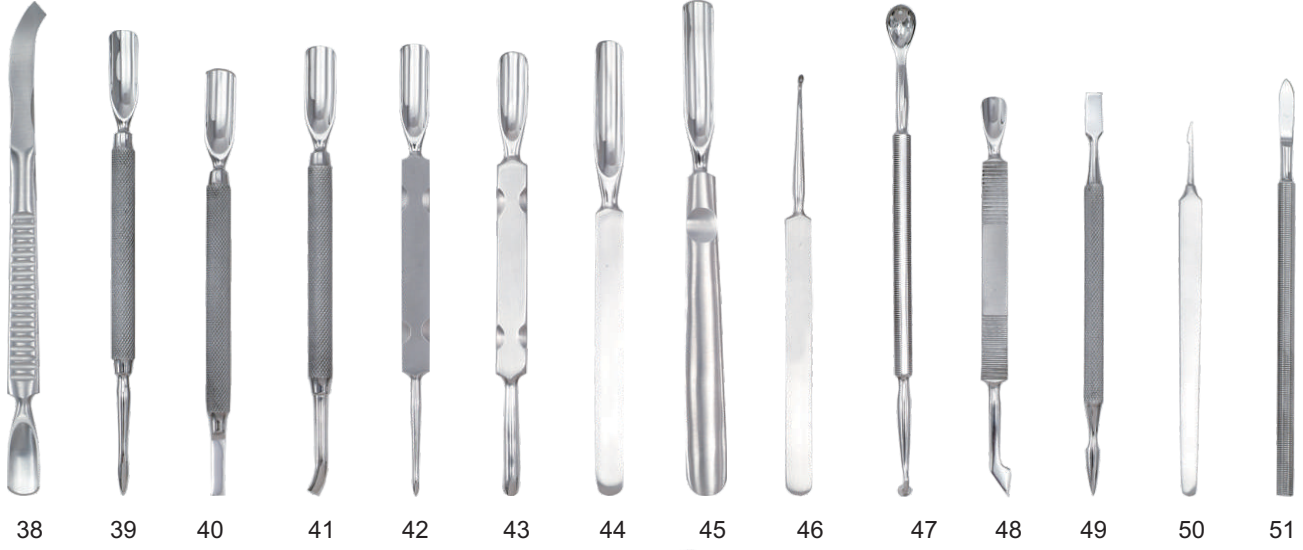
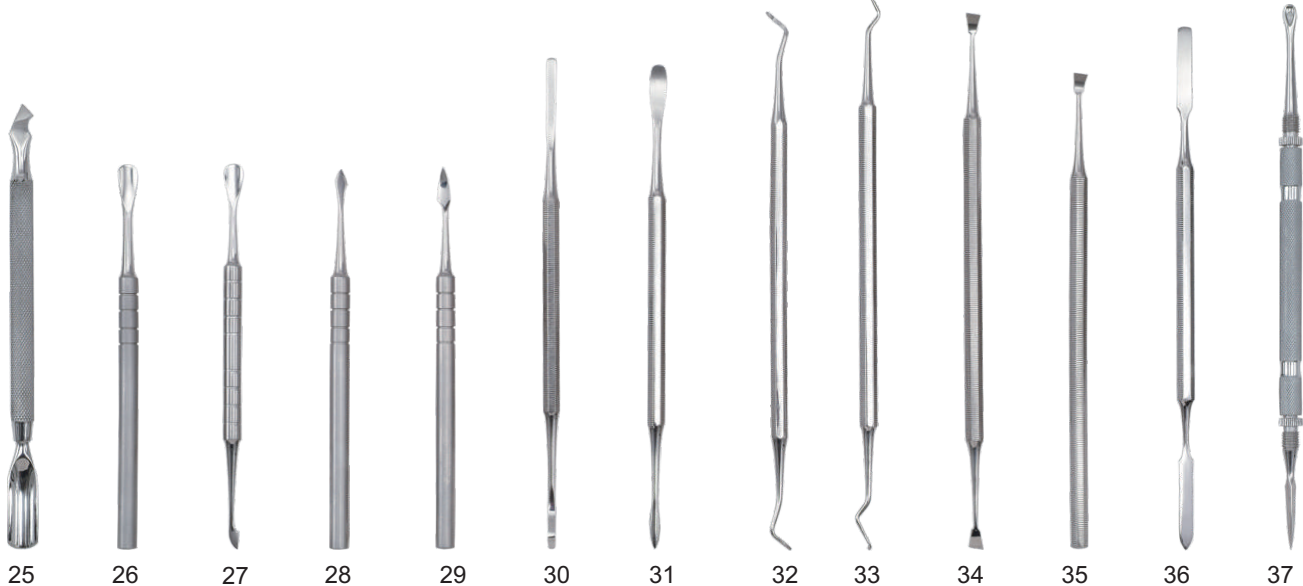



Hair Care



GIB 68

GIB 69

GIB 70

GIB 71

GIB 72

GIB 73

GIB 74

GIB 75

GIB 76

GIB 77

GIB 78

GIB 79

GIB 80

GIB 81

Twèezers & Small Scissors





Misc. & Care Kits





Global Instruments Inc.

ADDRESS:

675 Progress Center Ave, Suite G,
Lawrenceville, Georgia, 30043
U.S.A.

Toll-free : 1(800)385-8464

Assistance: (770)492-0733

Fax: (770)492-0735

E-Mail: suppliesin@aol.com

globalinstrumentsincusa@gmail.com