



Data sheet for Horizontal Lamps

[www.koollite.com](http://www.koollite.com)

616-485-4488



# 180LM/W IP67 Horizontal Lamps

## Product Features:

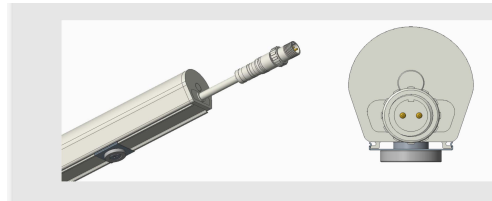

1. Contour diameter standard T8 size, smooth end cover and tube body, no steps, suitable for sliding adjustment position in the buckle without obstruction, hidden end cap, end cap and input- end waterproof power line integrated design, end cap reserved LOGO marking position, compact appearance and good consistency, end cap design with beautiful line and luminous direction icon, both beautiful and convenient construction, installation and identification. The bottom of the lamp is flat and can be fixed with strong 3M double-sided adhesive

2. 110-277v 3000k—4000k—5000k    10 YEAR WARRANTY    180 L/W    IP67 Water proof

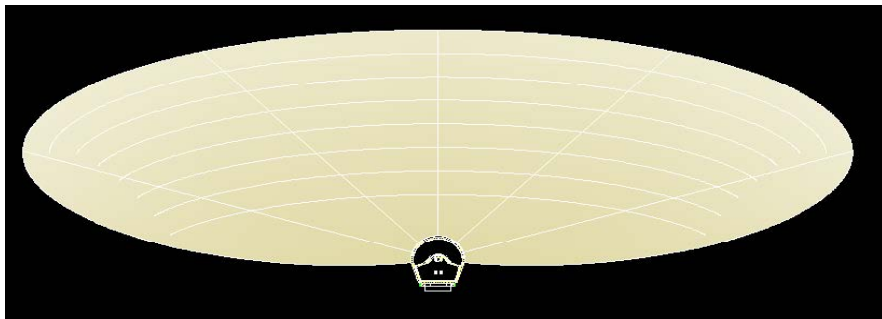

3. The lamp tube body is made of imported diffusion material with uniform diffusion and no light spots. The internal luminescence is made of "V" type radiator double lamp board scheme to ensure a large enough luminescence Angle and strengthen the light intensity on the 2 side of the light distribution curve, so as to achieve a large irradiation area and high luminosity uniformity. It is also an important energy-saving application to ensure that the radiator has enough margin and force strength when making high-power lamps, so as to maintain the heating and working temperature of the lamps themselves, maintain the temperature of the overall lighting environment will not rise, and do not increase the temperature load to the refrigerated cases.

# 180LM/W IP67 Horizontal Lamps

## Product Features:

4. The lamp work scheme adopts high efficiency built-in power supply, anti-surge, short circuit, open circuit protection, to ensure the safety of output, LED chip adopts SAN An (Epistar), BMTC and other leading Chinese LED industry high quality high efficiency chip, PCB board adopts UL high thermal conductivity aluminum substrate, to ensure that the LEDs heat conduction to the radiator with low thermal resistance state.

5. The internal design of the end cap adopts a special patent terminal male and female plug, to ensure the reliability and safety of the input circuit, the terminals with large current solid copper needle thick enough to ensure that the lamp series connection when the large current through is safe and reliable, the waterproof design of the end cap adopts non-adhesive double waterproof design, to ensure that the waterproof grade is enough IP67, When the first layer of waterproof ring fails, the second layer of waterproof is enabled to ensure the reliability of the lamp working in a bad environment for a long time. At the same time, the end cap is anti-demolition design, without any gap in the appearance, without any conductor, to ensure the safety and isolation of the lamp inside and outside. You can touch the lamp in the work at will, and the structure is extremely safe.

6. The installation of lamps with humanized design, can be matched with stainless steel strong magnetic stick buckle, installation construction and maintenance efficient and flexible, beautiful appearance, installation of lamps with overall texture is good, can be realized in the buckle fine tune lamp luminous direction, longitudinal without obstruction sliding,  
It can also be matched with patent plastic buckle, which is convenient and fast to open and close. At the same time, the buckle itself is light transmittance material, which can be installed in any position of the lamp body without blocking light, and the maintenance saves time and effort.

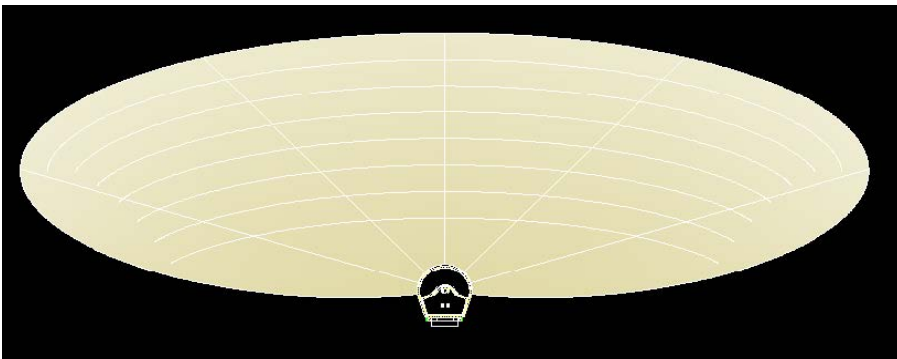
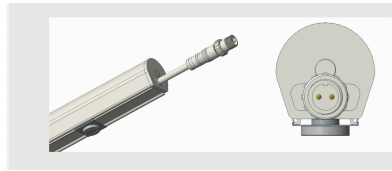

## Basic Technical Parameters

T8 IP67 Horizontal Lamp							
Model	Length	Size	PC Cover	Power	Efficiency	Lumen	IP Rate
D1VS-8WAC-2FT-40K-IP67-HM	2FT	863MM	Milky	8W	180M/W	1440lm Ra 97	IP67
D1VS-12WAC-3FT-40K-IP67-HM	3FT	1230MM	Milky	12W	180LM/W	2160lm Ra 97	IP67
<b>FDK-F0-FSL-048-096-30K-D DLC</b>	4FT	1396MM	Milky	15W	180LM/W	2700lm Ra97	IP67
D1VS-20WAC-5FT-40K-IP67-HM	5FT	1662MM	Milky	20W	180LM/W	3600lm Ra 97	IP67
D1VS-25WAC-6FT-40K-IP67-HM	6FT	1930MM	Milky	25W	180LM/W	4500lm Ra97	IP67

## Details of Parameters

Type	T8 Horizontal Lamp
Length	2FT/3FT /4FT /5FT/6FT
Power	8W/12W/15W/20W/25W
Efficiency	180LM/W
Input Voltage	100-277V /50/60HZ
PF Value	>0.92
LED Type	SMD2835
CCT	3000K/4000K/5000K /6000K
CRI	RA92
Beam Angle	240degree
Driver Type	Internal Driver
Dimmable	Dimmable and NON-Dimmable for options
SPD	1500V
Ingress Protection	IP67
Working Temperature	-40° ~ +50°

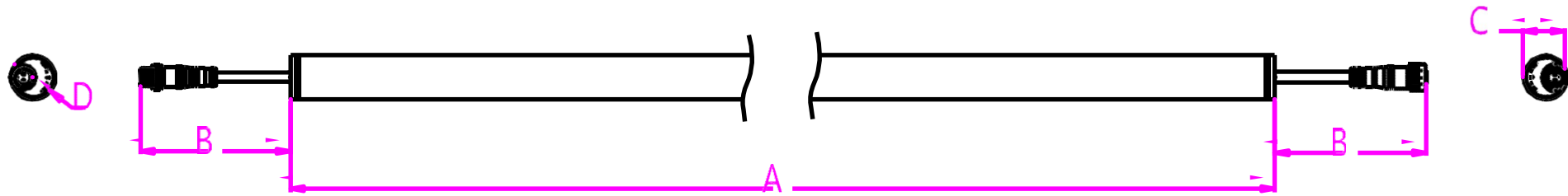

## Product Dimensions

Model Number	Length	A (mm)	B (mm)	C (mm)	D (mm)
D1VS-8WAC-2FT-40K-IP67-HM	2FT	533	165	25	26
D1VS-12WAC-3FT-40K-IP67-HM	3FT	900	165	25	26
<b>FDK-F0-FSL-048-096-30K-D DLC</b>	4FT	1066	165	25	26
D1VS-20WAC-5FT-40K-IP67-HM	5FT	1332	165	25	26
D1VS-25WAC-6FT-40K-IP67-HM	6FT	1600	165	25	26

# Size of Clips for Horizontal lamp

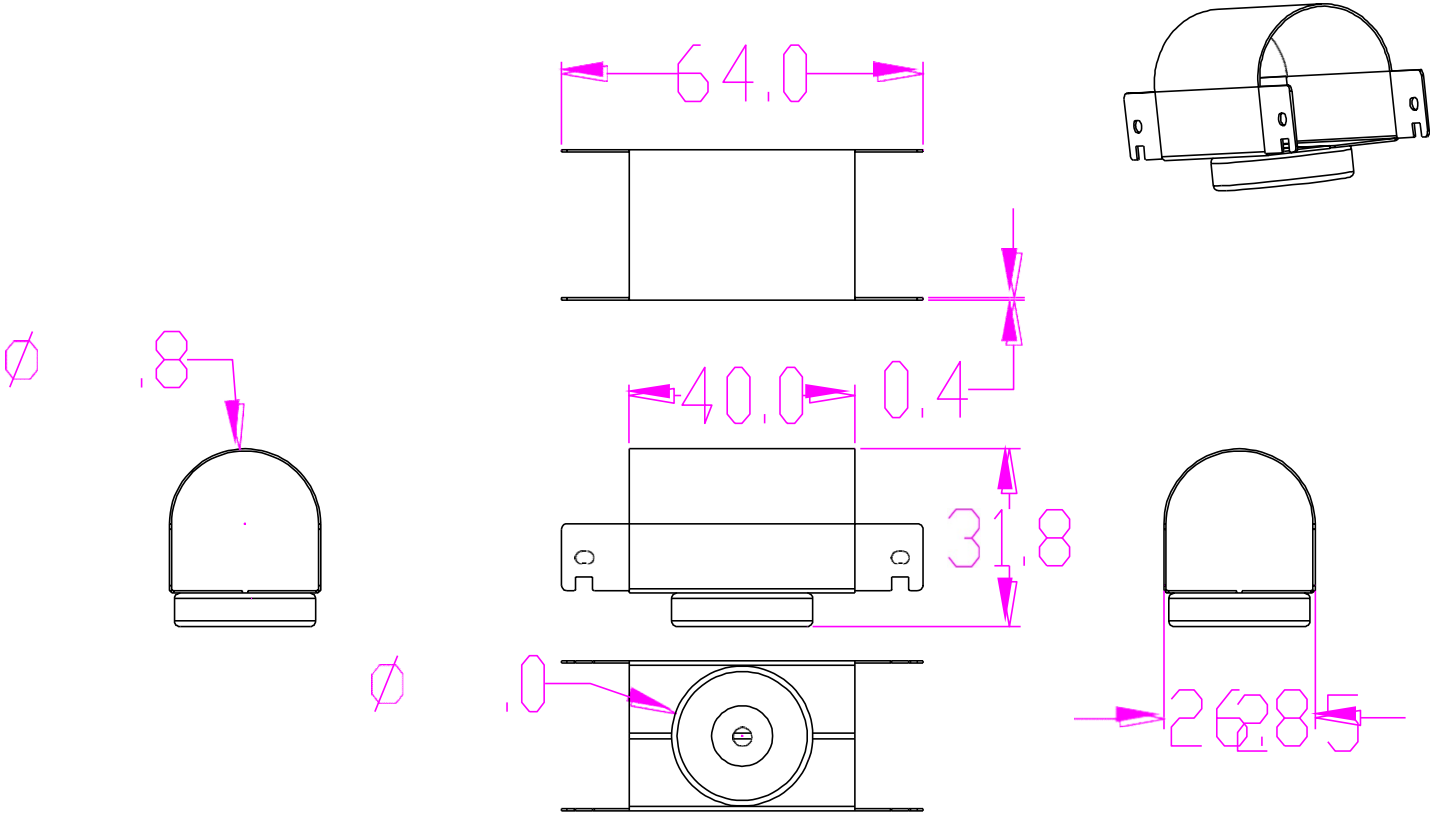

# Package and dimenstions

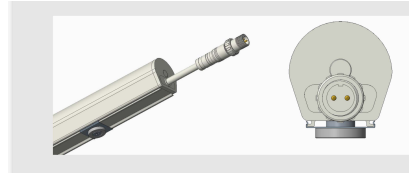

Model Number	Length	L(mm)	W(mm)	H(mm)	PCS/CTN	Weight /KG
D1VS-8WAC-2FT-40K-IP67-HM	2FT	642				
D1VS-12WAC-3FT-40K-IP67-HM	3FT	1010				
FDK-F0-FSL-048-096-30K-D DLC	4FT	1175	360	200	50	10
D1VS-20WAC-5FT-40K-IP67-HM	5FT	1442	360	200	50	18.5
D1VS-25WAC-6FT-40K-IP67-HM	6FT	1709	360	200	50	19