



QUANTUM<sup>®</sup>  
STORAGE  
SYSTEMS

**LOWEST PRICE  
GUARANTEED**



• BINS • WIRE SHELVING • CARTS • COMPLETE BIN SYSTEMS

# TABLE OF CONTENTS

## ULTRA BINS & SYSTEMS

- 4 Ultra Stack & Hang Bins **NEW**
- 5 Ultra Stack & Hang Bins **NEW**
- 6 Mesh Stack & Hang Bins **NEW**
- 7 Wire Louvered Panels
- 8 Louvered Panels
- 9 Louvered Panels & Bench Racks
- 10 Louvered Racks
- 11 Hanging Rail Systems
- 12 Complete Package Systems
- 13 Giant Open Hopper Steel Shelving Systems
- 14 Giant Open Hopper Wire Shelving Systems
- 15 Heavy-Duty 36" All-Welded Bin Cabinets
- 16 Heavy-Duty 36" & 48" Specialty Bin Cabinets
- 17 Heavy-Duty 48" All-Welded Bin Cabinets
- 18 Heavy-Duty 48" Cabinet & Rail Cart
- 19 Heavy-Duty 60" & 72" All-Welded Bin Cabinets

## CLEAR-VIEW BINS

- 20 Ultra Bins & Shelving Systems **NEW**
- 21 Ultra Bin Systems
- 22 HULK 24" Containers & Shelving Systems **NEW**
- 23 Giant Stack Containers & Shelving Systems
- 24 Economy 4" Shelf Bins & Shelving Systems
- 25 Economy 4" Shelf Bin Shelving Systems
- 26 Store-More 6" Shelf Bins & Shelving Systems
- 27 Store-More 6" Shelf Bin Shelving Systems
- 28 Store-Max 8" Shelf Bins
- 29 Store-Max 8" Shelf Bin Shelving Systems
- 30 Genuine stack and nest totes **NEW**
- 31 Dividable Grid Containers & Shelving Systems **NEW**

## BINS, TOTES & CONTAINERS

- 32 Stackable Shelf Bins
- 33 Stackable Shelf Bin Shelving Systems
- 34 HULK 24" Containers **NEW**
- 35 HULK 24" Container Steel Shelving Systems **NEW**
- 36 HULK 24" Container Wire Shelving Systems
- 37 HULK 30" & 36" Containers
- 38 HULK 30" Container Wire Shelving Systems
- 39 HULK 36" Container Wire Shelving Systems
- 40 Rackbin 42" Containers
- 41 Rackbin 42" Container Wire Shelving Systems
- 42 Giant Stack Containers
- 43 Giant Stack Container Storage Center
- 44 Giant Stack Container Wire Shelving Systems
- 45 MAGNUM Bins
- 46 MAGNUM Bin Steel Shelving Systems
- 47 MAGNUM Bin Wire Shelving Systems
- 48 Economy 4" Shelf Bins
- 49 Economy 4" Shelf Bin Steel Shelving Systems
- 50 Economy 4" Shelf Bin Sloped Shelving Systems
- 51 Economy 4" Shelf Bin Wire Shelving Systems
- 52 High Density Wire Shelving Systems
- 53 Store-More 6" Shelf Bins
- 54 Store-More 6" Shelf Bin Steel Shelving Systems
- 55 Store-More 6" Shelf Bin Sloped Shelving Systems
- 56 Store-More 6" Shelf Bin Wire Shelving Systems
- 57 Store-Max 8" Shelf Bins
- 58 Store-Max 8" Shelf Bin Steel Shelving Systems
- 59 Store-Max 8" Shelf Bin Wire Shelving Systems
- 60 Super Tuff Euro Drawers
- 61 Super Tuff Euro Drawer Steel Shelving Systems
- 62 Super Tuff Euro Drawer Sloped Shelving Systems

- 63 QuickPick Bins & Wire Shelving Systems
- 64 Latch Containers & Wire Shelving System **NEW**
- 65 Dividable Grid Containers **NEW**
- 66 Genuine stack and nest totes
- 67 Wire Shelving Systems
- 68 Cross Stack Tubs & QuanTub Nesting Tote
- 69 Tub Racks **NEW**
- 70 Stacker Straight Wall Containers
- 71 Attached Top Distribution Containers
- 72 Collapsible Bulk Box
- 73 Removable Tray Trucks
- 74 MAGNUM Bin Transport Trucks
- 75 Polymer Utility Carts & Tool Rack
- 76 Tool Caddy & Box, Economy Nesting Bin, Wrench Holder **NEW**
- 77 Labels

## SPECIALTY

- 78 Plastic Drawer Cabinets **NEW**
- 79 Organizers **NEW**
- 80 Clear Compartment Storage Boxes **NEW**
- 81 Recycled Bins **NEW**
- 82 Conductive Bins & Hanging Systems
- 83 Conductive Shelf Bins & Wire Shelving Systems
- 84 Conductive Dividable Grid Containers & Bin Carts **NEW**
- 85 Conductive Wire Utility Carts, Trays & Tray Carts
- 86 Computer Work Center, Reel & Stencil Shelving Units **NEW**
- 87 Clear Tip Out Bins
- 88 Dividable & Individual Clear Tip Out Bins & 669 Bin Set **NEW**
- 89 Clear Tip Out Bin Rails & Frames
- 90 Clear Tip Out Bin Floor Stands
- 91 Mobile Clear Tip Out Bin Floor Stands
- 92 Clear Tip Out Bin Free Standing & Gondola Slider Systems
- 93 Clear Tip Out Bin Cabinets, Cart & Spinner **NEW**
- 94 Interlocking Storage Cabinets
- 95 Interlocking Storage Cabinet Floor Stands
- 96 IRONMAN 22 Gauge Steel Shelving

## WIRE

- 97 Wire Shelving System Finishes
- 98 Wire Shelves **NEW**
- 99 Posts & Solid Shelves **NEW**
- 100 54" Wire Shelving Units
- 101 63" Wire Shelving Units
- 102 74" Wire Shelving Units
- 103 86" Wire Shelving Units
- 104 Galvanized Steel Solid Shelving Units
- 105 Galvanized Steel Solid Shelving Units
- 106 Stainless Steel Solid Shelving Units
- 107 Stainless Steel Solid Shelving Units
- 108 Convenient 1 Box Chrome Wire Shelving Units
- 109 Wire Plastic Mat Shelving Units **NEW**
- 110 Corner Wire Shelving **NEW**
- 111 Reel Shelving Units **NEW**
- 112 PARTition Wall Systems
- 113 PARTition Wall Systems **NEW**
- 114 PARTition Wall Systems **NEW**
- 115 PARTition Wall Systems - Accessories **NEW**
- 116 Smart Grid Mounted Systems **NEW**
- 117 Smart Grid Mounted Systems - Accessories **NEW**
- 118 Wall Mount Cantilever Systems **NEW**
- 119 Wall Mount Cantilever Systems
- 120 Modular Wire Stacking Baskets
- 121 Wire Basket Units

- 122 Post Baskets & Mobile Units
- 123 Labels **NEW**
- 124 PARTition Store Pull Out Basket Carts
- 125 PARTition Store Pull Out Basket & Single Bay Carts
- 126 PARTition Store Double Bay Carts - Accessories
- 127 Shelves & Frames **NEW**
- 128 Dunnage & Platform Racks **NEW**
- 129 Dunnage & Platform Racks
- 130 Slanted Shelf Carts
- 131 Slanted Shelf Carts
- 132 Bin Carts
- 133 Double & Triple Bay Bin Carts
- 134 Utility Carts
- 135 Modular Trays & Tray Carts
- 136 Cart Covers
- 137 Stem Caster Carts
- 138 Enclosure Carts
- 139 Enclosure Carts
- 140 Enclosure Carts
- 141 Security Units **NEW**
- 142 High Density Sliding Floor Track System
- 143 High Density Sliding Floor Track System
- 144 High Density Sliding Overhead Track System
- 145 High Density Sliding Overhead Track System
- 146 Wire Shelving - Accessories **NEW**
- 147 Wire Shelving - Accessories **NEW**
- 148 Wire Shelving - Accessories **NEW**
- 149 Wire Shelving - Accessories

## MEDICAL

- 150 Hamper & Sterile Wrap Carts
- 151 Stainless Steel Carts & Tables
- 152 Catheter Carts
- 153 Garment Racks & Patient Apparel Cart
- 154 Bin Transport Carts

- 155 Layout & Design Services
- 156 Index
- 157 Index
- 158 Index
- 159 Index



**Product video(s) available online when you see this icon throughout our catalog!**

**The most efficient, permanent, and economical solution to solve your exact storage needs!**

## ULTRA BINS & SYSTEMS



Ultra Stack & Hang Bins  
4-5



Mesh Stack & Hang Bins  
6



Wire Louvered Panels  
7



Louvered Panels  
8



Louvered Panels & Bench Racks  
9



Louvered Racks, Rails & Complete Systems  
10-12



Giant Open Hopper Steel Shelving Systems  
13



Giant Open Hopper Wire Shelving Systems  
14



Cabinets & Rail Cart  
15-19

## CLEAR-VIEW BINS



Ultra Bins & Shelving Systems  
20



Ultra Bin Systems  
21



Hulk 24" Containers & Shelving Systems  
22



Giant Stack Containers & Shelving Systems  
23



Economy 4" Shelf Bins & Shelving Systems  
24-25



Store-More 6" Shelf Bins & Shelving Systems  
26-27



Store-Max 8" Shelf Bin & Shelving Systems  
28-29



stack and nest totes & Shelving Systems  
30



Dividable Grid Containers & Systems  
31

## BINS, TOTES & CONTAINERS



Stackable Shelf Bins & Shelving Systems  
32-33

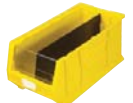

Hulk 24" Containers & Shelving Systems  
34-36



Hulk 30" & 36" Containers & Shelving Systems  
37-39



RackBin 42" Containers & Shelving Systems  
40-41



Giant Stack Containers & Shelving Systems  
42-44



Magnum Bins & Shelving Systems  
45-47



Economy 4" Shelf Bins & Shelving Systems  
48-52



Store-More 6" Shelf Bins & Shelving Systems  
53-56



Store-Max 8" Shelf Bins & Shelving Systems  
57-59



Super Tuff Euro Drawers & Shelving Systems  
60-62



Latch & Dividable Grid Containers  
64-65



Genuine Stack & Nest Totes & Wire Systems  
66-67



Cross Stack Tubs, QuanTub & Racks  
68-69



Stacker Straight Wall Containers  
70



Attached Top Distribution Containers  
71



Collapsible Bulk Box  
72



Removable Tray & Bin Transport Trucks  
73-74



Polymer Utility Carts & Tool Rack  
75

## SPECIALTY



Plastic Drawer Cabinets  
78



Organizers & Storage Boxes  
79-80



Recycled Bins  
81



Conductive Bins, Trays, Systems & Carts  
82-85



Work Center, Reel & Stencil Shelving Units  
86



Clear Tip Out Bins  
87-89



Clear Tip Out Bin Floor Stands & Gondolas  
90-92



Clear Tip Out Bin Cabinets, Cart & Spinner  
93



Interlocking Cabinets, Floor Stands & Steel Shelving  
94-96

## WIRE



Wire & Solid Shelves and Posts  
97-99



Wire Shelving Units  
100-103



Solid Galvanized Shelving Units  
104-105



Stainless Steel Shelving Units  
106-107



One Box & Plastic Mat Shelving Units  
108-109



Corner Shelving Units  
110



Reel Shelving Units  
111



PARTition Wall Systems  
112-115

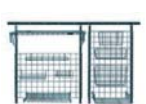

Smart Grid Mount System  
116-117



Wall Mount Systems  
118-119



Wire Basket Units  
120-121



Post Baskets & Mobile Units  
122



Labels  
123



PARTition Store Carts  
124-126



Shelves & Frames  
127



Dunnage & Platform Racks  
128-129



Slanted Shelf Carts  
130-131



Bin Carts  
132-133



Utility Carts  
134



Modular Trays & Tray Carts  
135



Cart Covers & Carts  
136-141



Sliding Floor Track Systems  
142-143



Sliding Overhead Track Systems  
144-145



Wire Shelving Accessories  
146-149



Hamper, Sterile Wrap & Stainless Carts & Tables  
150-151



Catheter Carts  
152



Garment Racks & Carts  
153-154

## MEDICAL

Ultra Stack & Hang Bins



PERFORMANCE FEATURES:

- Available in 23 sizes
- Standard colors: Blue, Green, Ivory, Red, Yellow, Black and Clear  
Pink and Stone color are available in select sizes  
*(additional colors available on request, subject to upcharge and minimum run quantity)*
- Bins are made from heavy-duty, virgin grade, high density FDA approved polypropylene
- Large label slot provide easy label insertion and parts' identification
- Extra wide stacking ledge ensures stability for high stacking
- Reinforced design adds strength and prevents spreading of side walls
- Will not rust or corrode, unaffected by weak acids and alkalis, and are waterproof
- Autoclavable up to 250°F
- Interchangeable with other manufactured brands of bins

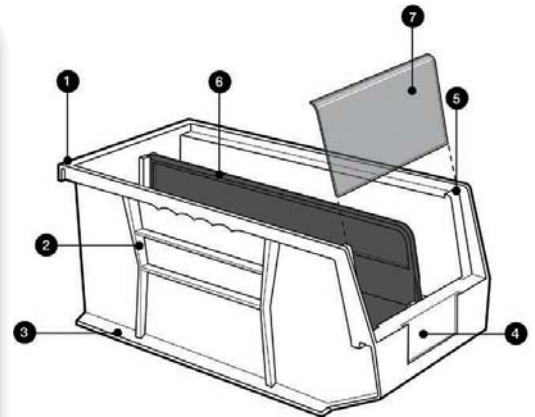

- 1 Full width hanger supports bin when hanging from louvered panels or rails
- 2 Reinforced rib design adds strength and prevents spreading of side walls
- 3 Extra-wide stacking ledge for secure stacking
- 4 Large front label slot allows larger bar code scanning and content identification
- 5 Anti-slide stop prevents stacked bins from shifting forward
- 6 Optional dividers increase storage options
- 7 Optional windows maximize storage capacity, prevent spillage and protect parts from dust and dirt

NEW CLEAR DIVIDERS



**QUS230 with COV230**  
Lid pivots up and down via insertion in holes in rear of bin  
*(Sold separately)*



**QUS239CL and QUS240**  
Shown with optional clear window front and dividers in clear or black  
*(Sold separately)*



CLEAR LABEL HOLDER

Clear label holders and laser label inserts slide into front label slot of all bins.  
*(Sold in packages of 25)*



MOBILE ULTRA BIN

Ideal for transport of heavy and bulky parts. Bin comes with 4 swivel, 3" polyurethane casters, all with brakes, allowing up to 250 lb. mobile load capacity



POLYMER DOLLY

**DLY-3018** Dolly with padded rubber trim, available in Blue. Dimensions 30"L x 18"W. Set of four 4" x 1-1/4" non-marking swivel poly casters, 1,000 lb. load capacity.  
*(Bin sold separately)*



**ATTACHED PULL RING**  
Allows dolly to be pulled with ease



32" Dolly Pull Rod with handle  
*Finish: Chrome*

MODEL NO.	DESCRIPTION	CTN WGT
<b>DLY-3018</b>	Dolly with Padded Rubber Trim	19 lbs
<b>HANDLE-DLY</b>	32" Dolly Pull Rod with Handle	2 lbs

*Bins sold separately*



**23 SIZES AND 9 COLORS AVAILABLE  
THE LARGEST SELECTION ANYWHERE**



AVAILABLE on pg. 20



**Ultra Stack & Hang Bins**



**HEAVY-DUTY  
LIFETIME USE**

**Bin Dimensions Guide**  
L (length) W (width) H (height)  
X (inside bottom length)

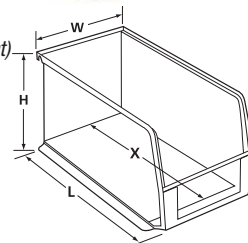

Organize your inventory with these strong bins, manufactured with FDA approved materials. Front, back and side grips for easy handling. Built-in rear hanger allows bins to hang from louvered panels or rails. Optional clear injection molded crystal styrene window front increases bin capacity and provides quick view of bin contents. Dividers, available in black or clear, maximize flexibility and keep contents organized. Wide stacking ledge and anti-slide lock keep stacked bins steady and prevent forward shifting. Water, rust, and corrosion proof. Easily cleaned with soap and water and impervious to most chemicals. Large molded front label slots for ID labels. Autoclavable up to 250°F and resistant to extreme cold. Guaranteed not to break or crack under normal load conditions. See **pg. 20** to order Clear Bins.

Available in: ● Blue ● Green ● Ivory ● Red ● Yellow ● Black ● Clear

**QUS210, QUS220, QUS224, QUS230, QUS234, QUS240, QUS250, QUS265, QUS270** also available in: ● Stone  
**QUS210, QUS230, QUS240, QUS250** also available in: ● Pink

MODEL NO.	OUTSIDE DIMENSIONS L" x W" x H"	INSIDE DIMENSIONS L" x W" x H"	X"	CTN QTY	CTN WGT	BIN LOAD CAPACITY*	CLEAR WINDOW	CTN QTY ***DIVIDER & CROSS DIVIDER	CTN QTY DIVIDER SLOTS	CLEAR LABEL HOLDER & INSERT	CLEAR LID	CTN QTY	
QUS200	5" x 4-1/8" x 3"	4-3/8" x 3-7/16" x 2-13/16"	3-1/2"	24	5 lbs	13 lbs	-	-	DUS200	6	1	LTR-1300	-
QUS210	5-3/8" x 4-1/8" x 3"	4-3/4" x 3-7/16" x 2-13/16"	4"	24	6 lbs	15 lbs	-	-	DUS210	6	1	LTR-1300	COV210 24
QUS220	7-3/8" x 4-1/8" x 3"	6-3/4" x 3-7/16" x 2-13/16"	6"	24	8 lbs	15 lbs	-	-	DUS220	6	1	LTR-1300	COV220 24
QUS221	9-1/4" x 6" x 5"	8-1/2" x 5-1/8" x 4-1/2"	7-1/4"	12	6 lbs	25 lbs	WUS221	12	DUS221	6	1	LTR-1754	-
QUS224	10-7/8" x 4-1/8" x 4"	10-1/4" x 3-3/16" x 3-3/4"	9"	12	8 lbs	35 lbs	WUS224	12	DUS224	6	1	LTR-1253	COV224 12
QUS230	10-7/8" x 5-1/2" x 5"	10-1/4" x 4-3/8" x 4-3/4"	9"	12	10 lbs	35 lbs	WUS230/234	12	DUS230/235	6	1	LTR-1754	COV230 12
QUS232	NEW 5-3/8" x 11" x 3"	4-3/4" x 10-1/8" x 2-13/16"	4"	8	5 lbs	35 lbs	-	-	DUS210	6	3	LTR-1300	COV232 8
QUS234	14-3/4" x 5-1/2" x 5"	14-1/16" x 4-3/8" x 4-3/4"	12-13/16"	12	14 lbs	55 lbs	WUS230/234	12	DUS234	6	1	LTR-1754	-
QUS235	10-7/8" x 11" x 5"	10-1/4" x 10" x 4-3/4"	9"	6	10 lbs	55 lbs	WUS235	6	DUS230/235	6	3	LTR-1754	COV235 6
QUS236	NEW 7-3/8" x 11" x 3"	6-3/4" x 10-1/8" x 2-13/16"	6"	8	9 lbs	35 lbs	-	-	DUS220	6	3	LTR-1300	COV236 8
QUS238	NEW 18" x 5-1/2" x 5"	17-1/8" x 4-3/8" x 4-3/4"	15-7/8"	12	16 lbs	45 lbs	WUS230/234	12	DUS238 CRDUS238	6 6	3	LTR-1754	COV238 12
QUS239	10-3/4" x 8-1/4" x 7"	10" x 6-9/16" x 6-3/4"	8"	6	10 lbs	55 lbs	WUS239/240	6	DUS239	6	1	LTR-1754	COV239 6
QUS240	14-3/4" x 8-1/4" x 7"	14" x 6-9/16" x 6-3/4"	12"	12	24 lbs	65 lbs	WUS239/240	6	DUS240/250	6	1	LTR-1754	COV240 12
QUS241	13-5/8" x 8-1/4" x 6"	12-1/2" x 6-3/4" x 5-3/8"	11-1/8"	12	22 lbs	65 lbs	WUS241	12	DUS241	6	1	LTR-1754	-
QUS242	13-5/8" x 8-1/4" x 8"	12-1/2" x 6-3/4" x 7-3/8"	11-1/8"	12	25 lbs	65 lbs	WUS242	12	DUS242	6	1	LTR-1754	-
QUS245	10-7/8" x 16-1/2" x 5"	9-3/4" x 15" x 4-3/4"	9"	6	13 lbs	65 lbs	WUS245	6	DUS245	6	3	LTR-1754	-
QUS248	NEW 18" x 8-1/4" x 7"	17" x 6-1/2" x 6-1/2"	15-1/4"	6	19 lbs	80 lbs	WUS239/240	6	DUS248 CRDUS248	6 6	3	LTR-1754	COV248 6
QUS250	14-3/4" x 16-1/2" x 7"	14" x 14-3/4" x 6-3/4"	12"	6	21 lbs	80 lbs	WUS250	6	DUS240/250	6	3	LTR-1754	-
QUS255	16" x 11" x 8"	15-1/8" x 10" x 7-3/4"	11-5/8"	4	14 lbs	80 lbs	WUS255	4	DUS255	6	3	LTR-1754	-
QUS260	18" x 11" x 10"	17" x 9-1/2" x 9-3/4"	14-3/16"	4	17 lbs	80 lbs	WUS260	4	DUS260	6	3	LTR-1754	-
QUS265	18" x 8-1/4" x 9"	17-1/8" x 6-3/4" x 8-1/4"	14-1/2"	6	17 lbs	65 lbs	WUS265	6	DUS265	6	1	LTR-1754	-
QUS270	18" x 16-1/2" x 11"	17-1/8" x 14-3/4" x 10-1/4"	14"	3	16 lbs	80 lbs	WUS270	3	DUS270 CRDUS270	6	3	LTR-2400	-
QUS275MOB	18" x 16-1/2" x 11"***	17-1/8" x 14-3/4" x 10-1/4"	14"	3	25 lbs	-	WUS270	3	DUS270 CRDUS270	6	3	LTR-2400	-

\*When attached to panels or rails \*\*With casters, overall height is 14" \*\*\*For clear dividers add CL suffix to divider Model No. DUS200CL

12 SIZES AVAILABLE

**NEW SIZES**



**Exclusive! Mesh Stack & Hang Bins**

QUANTUM STORAGE SYSTEMS **exclusive**



New patented wire Mesh Bins are an industry exclusive. Our innovative mesh design offers a bright-chrome finish and a 3/8" x 3/8" grid pattern allowing complete visibility of the bin's contents. This unique mesh pattern provides a dust and dirt free storage environment. Ultra strong design allows for superior hang capacity perfect for industrial parts storage or anything where hang capacities are vital. Quantum's Mesh Bins feature a rear hanger that allows them to hang from any louvered wall panel or rail system and optional side stacking ledge which allow bins to stack one on top of the other. The open hopper design allows for easy picking while allowing visual access to stored contents. Two styles of optional label holders are available for all Mesh Bins. **Finish:** Chrome

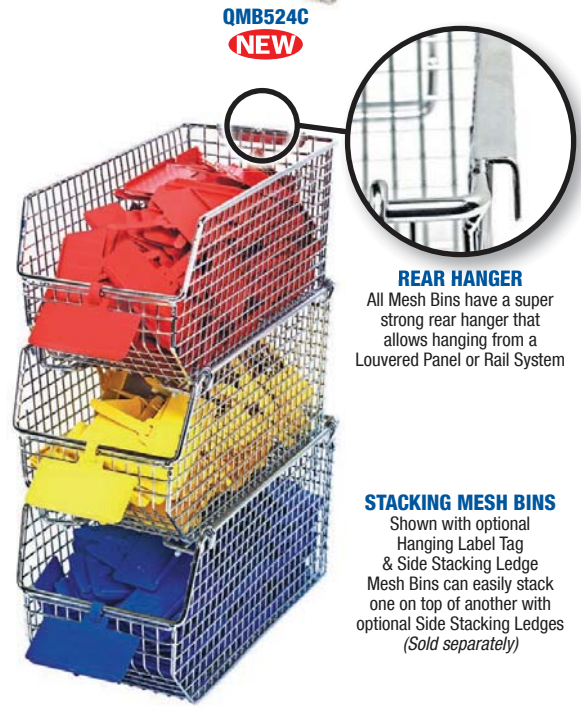

**REAR HANGER**  
All Mesh Bins have a super strong rear hanger that allows hanging from a Louvered Panel or Rail System

**STACKING MESH BINS**  
Shown with optional Hanging Label Tag & Side Stacking Ledge Mesh Bins can easily stack one on top of another with optional Side Stacking Ledges (Sold separately)

MODEL NO.	OUTSIDE DIMENSIONS L" x W" x H"	INSIDE DIMENSIONS L" x W" x H"	CTN QTY	CTN WGT	SIDE STACKING LEDGE SOLD PER PAIR	DIVIDER
QMB510C	5-1/4" x 4-1/4" x 3"	4-3/4" x 3" x 2-3/4"	20	12 lbs	HMB510C	DMB510C
QMB520C	7-1/4" x 4-1/4" x 3"	6-3/4" x 3" x 2-3/4"	20	15 lbs	HMB520C	DMB520C
QMB524C <b>NEW</b>	11" x 4-3/4" x 4"	10-3/8" x 3-1/2" x 3-3/4"	10	15 lbs	HMB530C/535C	DMB524C
QMB530C	10-3/4" x 5-1/2" x 5"	10-1/4" x 4" x 4-3/4"	10	12 lbs	HMB530C/535C	DMB530C/535C
QMB534C <b>NEW</b>	15" x 6" x 5"	14-1/4" x 4-3/4" x 4-3/4"	10	17 lbs	HMB540C/550C	DMB534C
QMB535C	10-3/4" x 11" x 5"	10-1/4" x 9-3/4" x 4-3/4"	10	19 lbs	HMB530C/535C	DMB530C/535C
QMB539C	10-1/2" x 8" x 7"	10" x 6-5/8" x 6-5/8"	10	20 lbs	HMB539C	DMB539C
QMB540C	14-1/2" x 8" x 7"	14" x 6-5/8" x 6-5/8"	10	30 lbs	HMB540C/550C	DMB540C/550C
QMB550C	14-1/2" x 16-1/4" x 7"	14" x 14-7/8" x 6-5/8"	5	17 lbs	HMB540C/550C	DMB540C/550C
QMB560C	18-1/2" x 11" x 10-1/8"	18" x 9-5/8" x 9-7/8"	5	21 lbs	HMB560C/570C	DMB560C/570C
QMB565C <b>NEW</b>	17-3/4" x 8-1/8" x 9"	17-1/8" x 5-1/4" x 8-3/4"	5	19 lbs	HMB565C	DMB565C
QMB570C	18-1/2" x 17-1/8" x 11-1/8"	18" x 15-5/8" x 10-7/8"	5	28 lbs	HMB560C/570C	DMB560C/570C

2 LABEL HOLDER OPTIONS



Shown with optional **Divider** (Sold separately)



Shown with optional **Side Stacking Ledge Pair** (Sold separately)

Accessories

**INSTANT VISIBILITY  
NO DUST OR DIRT  
BUILDUP  
ALL WELDED**



Shown with optional **HBL3C Clear Label Holder** Fits 1-1/8" x 3" Label (Sold separately)

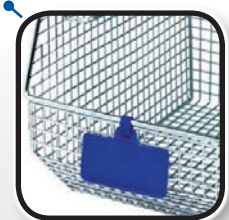

Shown with optional **PS-LH3 Hanging Label Tag** Fits 1-3/8" x 3" Label  
 Clear Red Yellow Blue  
 Green Orange Pink Purple  
 (Sold separately)

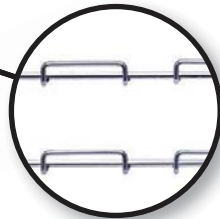

**WLP-1836C**  
36" L x 18" H  
Accepts all sizes of Ultra Stack & Hang Bins and Mesh Bins. Includes 8 direct mount clips. 175 lb. load capacity.

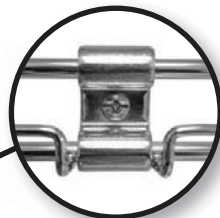

**WLP-3036C**  
36" L x 30" H  
Accepts all sizes of Ultra Stack & Hang Bins and Mesh Bins. Includes 12 direct mount clips. 250 lb. load capacity.

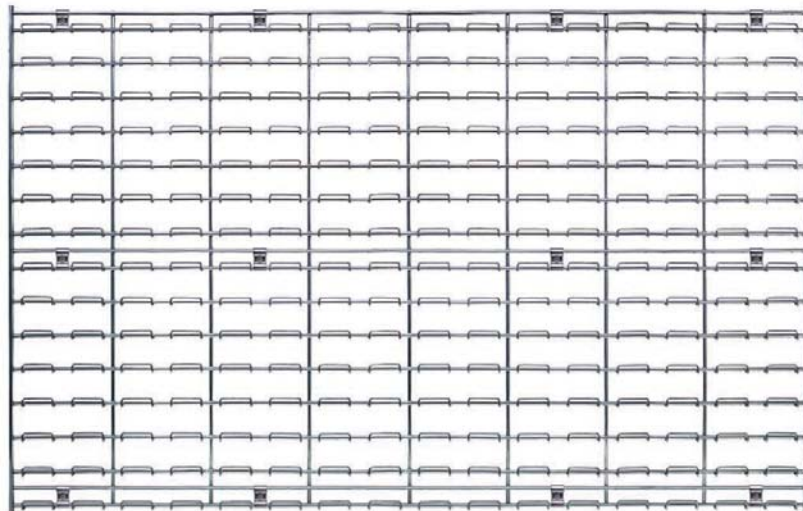

**Exclusive! Wire Louvered Panels**

Quantum's chrome Wire Louvered Panels offer a perfect mounting solution for all plastic hanging and wire mesh hanging bins. Quantum's exclusive offering of wire panels, available in three sizes, completely resist any buildup of dust or dirt. Included direct mounting clips enable fastening to any surface (*wall, wood, concrete, drywall, etc.*) a snap (**note: mounting screws are not included as they differ based on what type of surface the panels are being mounted to**). Offset mounting clips are also available, can be used in place of **WLP-DMC** if you want to have wire panel mounted offset (*away*) from a wall surface making it easier to clean behind the panel (*sold separately*). Manufactured of heavy-duty chrome wire, Quantum's wire panels will offer years of dependable and heavy-duty service.

MODEL NO.	DIMENSIONS L" x H"	CTN QTY	CTN WGT
<b>Wire Wall Mounted Louvered Panels</b>			
<b>WLP-1836C</b>	36" x 18" Wire Louvered Panel	1	12 lbs
<b>WLP-3036C</b>	36" x 30" Wire Louvered Panel	1	19 lbs
<b>WLP-3048C</b>	48" x 30" Wire Louvered Panel	1	26 lbs

**Accessories**



**WLP-DMC**  
Direct Mount Clips - 4 pack  
(Included with wire louvered panels)  
Extra packages available (*if needed*). (*Sold separately*)



**WLP-OSC**  
Offset Mount Clips - 4 pack  
Offsets panel from wall surface allowing easy access to clean behind panel  
(*Sold separately*)

**WLP-3048C**  
48" L x 30" H  
Accepts all sizes of Ultra Stack & Hang Bins and Mesh Bins. Includes 12 direct mount clips. 300 lb. load capacity.

**SIMPLE TO MOUNT  
EASY TO CLEAN  
ALL WELDED**

MODEL NO.	QUANTITY OF MESH BINS TO FIT LOUVERED PANELS											QUANTITY OF ULTRA BINS TO FIT LOUVERED PANELS																						
	QMB 510	QMB 520	QMB 524	QMB 530	QMB 534	QMB 535	QMB 539	QMB 540	QMB 550	QMB 560	QMB 565	QMB 570	QUS 200	QUS 210	QUS 220	QUS 221	QUS 224	QUS 230	QUS 232	QUS 234	QUS 235	QUS 236	QUS 238	QUS 239	QUS 240	QUS 241	QUS 242	QUS 245	QUS 248	QUS 250	QUS 255	QUS 260	QUS 265	QUS 270
<b>WLP-1836C</b>	32	32	18	18	18	9	8	8	4	3	4	2	32	32	32	18	18	18	12	18	9	12	18	8	8	8	8	6	8	4	6	3	4	2
<b>WLP-3036C</b>	56	56	30	30	30	15	16	16	6	6	8	6	56	56	56	30	30	30	21	30	15	21	30	16	16	16	16	10	16	6	9	6	8	6
<b>WLP-3048C</b>	77	77	40	40	40	20	20	20	8	12	15	6	77	77	77	40	40	40	28	40	20	28	40	20	20	20	20	10	20	8	12	12	15	6

See pgs. 5 & 6 for bin dimensions



Hanging Louvered Panels



Quantum Ultra and Mesh Bins will hang on louvered panels in a wide range of configurations designed to meet all application needs. Panels are formed from heavy-duty 16 gauge cold rolled steel and have a Gray or Oyster White powder coat finish which ensures years of heavy-duty use. Louvered panels may be mounted on any suitable wall surface. Fasten securely to assure adequate load bearing. Mounting hardware is not included.

MODEL NO.	DIMENSIONS L" x H"	CTN QTY	CTN WGT
<b>Gray Wall Mounted Louvered Panels</b>			
QLP-1819	18" x 19" Gray Louvered Panel	1	6 lbs
QLP-1861	18" x 61" Gray Louvered Panel	1	21 lbs
QLP-2721	27-3/4" x 21" Gray Louvered Panel	1	11 lbs
QLP-3612	36" x 12" Gray Louvered Panel	1	8 lbs
QLP-3619	36" x 19" Gray Louvered Panel	1	13 lbs
QLP-3661	36" x 61" Gray Louvered Panel	1	40 lbs
QLP-4819	48" x 19" Gray Louvered Panel	1	18 lbs
QLP-4861	48" x 61" Gray Louvered Panel	1	60 lbs
<b>Oyster White Wall Mounted Louvered Panels</b>			
QLP-1819HC	18" x 19" Oyster White Louvered Panel	1	6 lbs
QLP-1861HC	18" x 61" Oyster White Louvered Panel	1	21 lbs
QLP-3619HC	36" x 19" Oyster White Louvered Panel	1	13 lbs
QLP-3661HC	36" x 61" Oyster White Louvered Panel	1	40 lbs
QLP-4861HC	48" x 61" Oyster White Louvered Panel	1	60 lbs



**QLP-1819**  
18"L x 19"H

Accepts all sizes of Ultra and Mesh Bins.  
175 lb. load capacity. (Bins sold separately)

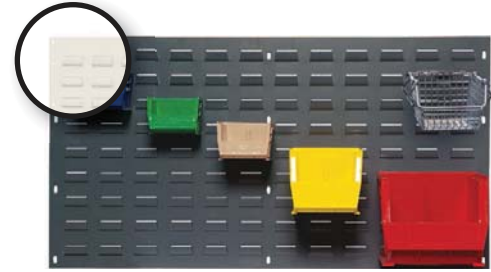

**QLP-3619**  
36"L x 19"H

Accepts all sizes of Ultra and Mesh Bins.  
200 lb. load capacity. (Bins sold separately)



**QLP-1861**  
18"L x 61"H

Accepts all sizes of Ultra and Mesh Bins.  
500 lb. load capacity. (Bins sold separately)



**QLP-3612**  
36"L x 12"H

Accepts all sizes of Ultra and Mesh Bins.  
175 lb. load capacity. (Bins sold separately)

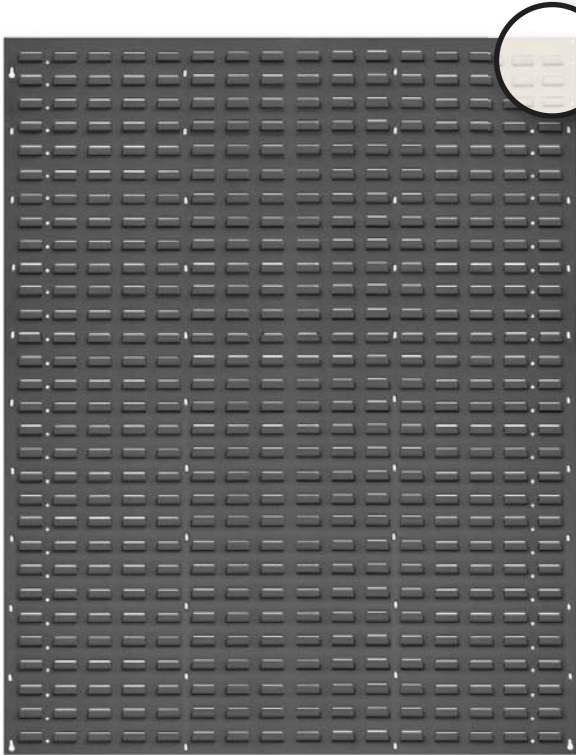

**QLP-4861**  
48"L x 61"H

Accepts all sizes of Ultra and Mesh Bins.  
1,000 lb. load capacity.

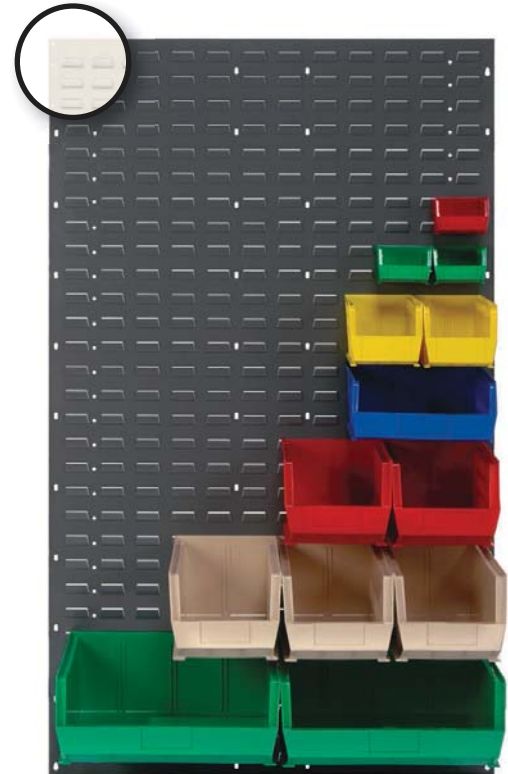

**QLP-3661**  
36"L x 61"H

Accepts all sizes of Ultra and Mesh Bins.  
1,000 lb. load capacity. (Bins sold separately)



**QLP-4819**  
48"L x 19"H

Accepts all sizes of Ultra and Mesh Bins.  
250 lb. load capacity. (Bins sold separately)

**OFFERED IN GRAY OR OYSTER WHITE COLOR**



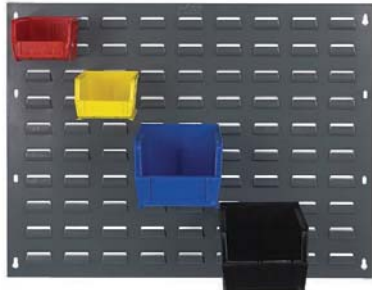

**QLP-2721**  
27-3/4" L x 21" H  
Accepts all sizes of Ultra and Mesh Bins.  
175 lb. load capacity. (Bins sold separately)



**QBR-3619**  
36" L X 8" W x 19" H  
Accepts all sizes of Ultra and Mesh Bins.  
150 lb. load capacity. (Bins sold separately)



**QBR-3612**  
36" L X 8" W x 12" H  
Accepts all sizes of Ultra and Mesh Bins.  
125 lb. load capacity. (Bins sold separately)



**QBR-1819**  
18" L X 8" W x 19" H  
Accepts all sizes of Ultra and Mesh Bins.  
140 lb. load capacity. (Bins sold separately)

**Accessories**



**WS-SR9C**  
9" Single Rod  
15 lb. load capacity



**WS-DR10C**  
10" Double Rod  
15 lb. load capacity



**WS-VTH**  
Vertical Tape/Reel Holder  
25 lb. load capacity



**WS-HDS6**  
Heavy-Duty 6" Spike  
65 lb. load capacity



**WS-HDS12**  
Heavy-Duty 12" Spike  
50 lb. load capacity

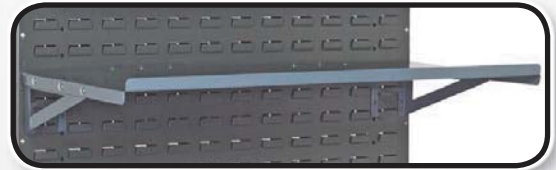

**SLP-1236 (12" D x 36" W) and SLP-1836 (18" D x 36" W)**  
Flat Shelf with 2 Brackets. Available in 12" or 18" Depth.  
75 lb. load capacity



**SLP-A1236 (12" D x 36" W) and SLP-A1836 (18" D x 36" W)**  
Slanted Shelf with 2 Slanted Brackets. Available in 12" or 18" Depth.  
75 lb. load capacity



**WS-HTH**  
Horizontal Tape/Reel Holder  
25 lb. load capacity

**CUSTOMIZE YOUR OWN UNIT**

1. Select the hanging unit of your choice.
2. Turn to pg. 5 and pg. 6 to choose the bin that best fits your need.
3. Go to the chart at the bottom of this page and determine how many bins fit on the unit you selected.
4. Place your order for both unit and bins.

**Bench Racks**

MODEL NO.	DIMENSIONS L" x W" x H"	CTN QTY	CTN WGT
<b>QBR-1819</b>	18" x 8" x 19" Bench Rack	1	11 lbs
<b>QBR-2721</b>	27-3/4" x 8" x 21" Bench Rack	1	16 lbs
<b>QBR-3612</b>	36" x 8" x 12" Bench Rack	1	14 lbs
<b>QBR-3619</b>	36" x 8" x 19" Bench Rack	1	19 lbs

MODEL NO.	QUANTITY OF MESH BINS TO FIT LOUVERED PANELS												QUANTITY OF ULTRA BINS TO FIT LOUVERED PANELS																						
	QMB 510	QMB 520	QMB 524	QMB 530	QMB 534	QMB 535	QMB 539	QMB 540	QMB 550	QMB 560	QMB 565	QMB 570	QUS 200	QUS 210	QUS 220	QUS 221	QUS 224	QUS 230	QUS 232	QUS 234	QUS 235	QUS 236	QUS 238	QUS 239	QUS 240	QUS 241	QUS 242	QUS 245	QUS 248	QUS 250	QUS 255	QUS 260	QUS 265	QUS 270	
<b>QLP-1819</b>	16	16	12	9	9	3	4	4	2	1	4	1	16	16	16	9	12	9	6	9	3	6	9	4	4	4	4	4	3	4	2	1	1	4	1
<b>QLP-1861</b>	60	60	30	30	30	15	14	14	7	5	12	5	60	60	60	30	30	30	15	30	15	15	15	14	14	14	10	4	7	7	5	12	5		
<b>QLP-2721</b>	30	30	12	12	12	6	6	6	2	4	6	1	30	30	30	12	12	12	10	12	6	10	12	6	6	6	6	3	14	2	4	4	6	1	
<b>QLP-3612</b>	18	18	12	12	12	6	4	4	2	3	8	2	18	18	18	12	12	12	9	12	6	9	12	4	4	4	4	4	6	2	6	3	8	2	
<b>QLP-3619</b>	40	40	24	18	18	9	8	8	4	3	8	2	40	40	40	18	24	18	12	18	9	12	18	8	8	8	8	6	4	4	6	3	8	2	
<b>QLP-3661</b>	120	120	80	60	60	30	28	28	14	15	24	10	120	120	120	60	80	60	45	60	30	45	60	28	28	28	28	20	8	14	21	15	24	10	
<b>QLP-4819</b>	55	55	24	24	24	12	10	10	4	8	10	2	55	55	55	24	24	24	16	24	12	16	24	10	10	10	10	6	28	4	8	8	10	2	
<b>QLP-4861</b>	165	165	80	80	80	40	35	35	14	20	30	10	165	165	165	80	80	80	60	80	40	60	80	35	35	35	35	20	10	14	28	20	30	10	
<b>QBR-1819</b>	16	16	12	9	9	3	4	4	2	1	4	1	16	16	16	9	12	9	6	9	3	6	9	4	4	4	4	3	35	2	1	1	4	1	
<b>QBR-2721</b>	30	30	12	12	12	6	6	6	2	4	6	1	30	30	30	12	12	12	10	12	6	10	12	6	6	6	6	3	6	2	4	4	6	1	
<b>QBR-3612</b>	18	18	12	12	12	6	4	4	2	3	8	2	18	18	18	12	12	12	9	12	6	9	12	4	4	4	4	4	4	2	6	3	8	2	
<b>QBR-3619</b>	32	32	32	18	18	9	8	8	4	3	8	2	32	32	32	18	32	18	12	18	9	12	18	8	8	8	8	6	8	4	6	3	8	2	

See pgs. 5 & 6 for bin dimensions



**QSS-3666H**

**Single Sided Louvered Rack**

36"L x 12-1/2"W x 66"H

800 lb. capacity. Single sided unit accepts all sizes of Ultra and Mesh Bins (up to 120 bins)  
Shown with QUS240 and QUS250 bins.  
(Bins sold separately)



**QDS-3666H**

**Double Sided Louvered Rack**

36"L x 25"W x 66"H

2,000 lb. capacity. Mobile unit accepts all sizes of Ultra and Mesh Bins (up to 240 bins)  
Shown with QUS235 bins.  
(Bins sold separately)



**QMD-36H**

**Mobile Double Sided Louvered Rack**

36"L x 25"W x 72"H

1,200 lb. capacity. Mobile unit accepts all sizes of Ultra and Mesh Bins (up to 240 bins). Comes complete with four 5" hard rubber, heavy-duty casters, 2 swivel with brake and 2 rigid. Easy-to-pull handle included.  
Shown with QUS230 and QUS240 bins.  
(Bins sold separately)



**QSS-1866H**

**Single Sided Louvered Rack**

18"L x 12-1/2"W x 66"H

375 lb. capacity. Single sided unit accepts all sizes of Ultra and Mesh Bins (up to 60 bins).  
Shown with QUS245 bins.  
(Bins sold separately)

Slanted Shelf  
see pg. 9

Flat Shelf  
see pg. 9

Wire Mesh Bins  
see pg. 6

Plastic Bins  
see pg. 5



**CUSTOMIZE YOUR OWN UNIT**

1. Select the hanging unit of your choice.
2. Turn to pg. 5 and pg. 6 to choose the bin that best fits your need.
3. Go to the chart at the bottom of this page and determine how many bins fit on the unit you selected.
4. Place your order for both unit and bins.

**Louvered Racks**



MODEL NO.	BIN DIMENSIONS L" x W" x H"	CTN QTY	CTN WGT
<b>Single Sided Unit - 375 lb. Capacity</b>			
QSS-1866H	18"L x 12-1/2"W x 66"H	1	40 lbs
<b>Single Sided Unit - 800 lb. Capacity</b>			
QSS-3666H	36"L x 12-1/2"W x 66"H	1	60 lbs
<b>Double Sided Unit - 2,000 lb. Capacity</b>			
QDS-3666H	36"L x 25"W x 66"H	1	106 lbs
<b>Double Sided Unit - Mobile Unit - 1,200 lb. Capacity</b>			
QMD-36H	36"L x 25"W x 72"H	1	155 lbs

**QUANTITY OF ULTRA BINS TO FIT LOUVERED RACKS**

MODEL NO.	QUS 200	QUS 210	QUS 220	QUS 221	QUS 224	QUS 230	QUS 232	QUS 234	QUS 235	QUS 236	QUS 238	QUS 239	QUS 240	QUS 241	QUS 242	QUS 245	QUS 248	QUS 250	QUS 255	QUS 260	QUS 265	QUS 270
QSS-1866H	60	60	60	30	30	30	15	30	10	15	30	15	14	14	14	10	14	10	7	5	12	5
QSS-3666H	120	120	120	60	80	60	45	60	30	45	60	28	28	28	24	20	28	14	21	15	24	10
QDS-3666H	240	240	240	120	160	120	90	120	60	90	120	56	56	48	40	28	56	42	30	40	40	20
QMD-36H	240	240	240	120	160	120	90	120	60	90	120	56	56	48	40	28	56	42	30	40	40	20

See pg. 5 for bin dimensions



**Hang-n-Stack Bins - Complete Packages**

Comes with 2 handy 12" plastic rails ideal for mounting to any surface. Bins can hang or stack securely providing an efficient bin storage system. Bins available in Blue, Yellow, Red, Green, Ivory, Black and Clear. Rails available in White.

MODEL NO.	BIN DIMENSIONS L" x W" x H"	DESCRIPTION	CTN WGT
HNS200	5" x 4-1/8" x 3"	6 bins + 2 rails	2 lbs
HNS210	5-3/8" x 4-1/8" x 3"	6 bins + 2 rails	2 lbs
HNS220	7-3/8" x 4-1/8" x 3"	6 bins + 2 rails	3 lbs
HNS230	10-7/8" x 5-1/2" x 5"	4 bins + 2 rails	5 lbs
HNS006	Extra Rails	2 rails	1 lb

**CUSTOMIZE YOUR OWN UNIT**

1. Select the hanging unit of your choice.
2. Turn to pg. 5 and choose the bin that best fits your need.
3. Go to the chart at the bottom of this page and determine how many bins fit on the unit you selected.
4. Place your order for both unit and bins.



Shown with 24 QUS240 bins.  
(Bins sold separately)

**QRU-12S**

**Single Sided Rack, 12 Rails**  
36"L x 15"W x 53"H

600 lb. capacity. Accepts 12 sizes of Ultra Bins (up to 96 bins). See chart for bin configurations.

**QRU-16S**

**Single Sided Rack, 16 Rails**

600 lb. capacity. Accepts 6 sizes of Ultra Bins (up to 48 bins). See chart for bin configurations.



Shown with 192 QUS220 bins.  
(Bins sold separately)

**QRU-12D**

**Double Sided Rack, 12 Rails**  
36"L x 20"W x 53"H

1,600 lb. capacity. Accepts 12 sizes of Ultra Bins (up to 192 bins). See chart for bin configurations.

**QRU-16D**

**Double Sided Rack, 16 Rails**

Accepts 6 sizes of Ultra Bins (up to 96 bins)  
1,600 lb. capacity. See chart for bin configurations.



GRAY OR

**NEW**

**Steel Rail**

**OYSTER WHITE COLOR**



48"L x 5/8"W x 3"H Steel Rail mounts to any surface or workbench and accepts 13 sizes of Ultra bins (up to 11 bins per rail). 125 lb. load capacity. Gray powder coat and oyster white finish.

MODEL NO.	DESCRIPTION	CTN QTY	CTN WGT
QRU-1W	48" Wall Rail	1	6 lbs
QRU-1WHC	48" Wall Rail Oyster White	1	6 lbs



Shown with 96 QUS230 bins.  
(Bins sold separately)

**QRU-16D + QRU-MOB**

**Double Sided Rack, 16 Rails with Mobile Kit**  
36"L x 20"W x 59"H

2 rigid, 1 swivel and 1 swivel with brake casters  
1,000 lb. capacity. Accepts 6 sizes of Ultra Bins (up to 96 bins). See chart for bin configurations.

**QRU-12D + QRU-MOB**

**Double Sided Rack, 12 Rails with Mobile Kit**

2 rigid, 1 swivel and 1 swivel with brake casters  
1,000 lb. capacity. Accepts 12 sizes of Ultra Bins (up to 192 bins). See chart for bin configurations.

**QUANTITY OF ULTRA BINS TO FIT RAIL UNITS**

MODEL NO.	DESCRIPTION	DIMENSIONS L" x W" x H"	QUANTITY OF ULTRA BINS TO FIT RAIL UNITS																					
			200	210	220	221	224	230	232	234	235	236	238	239	240	241	242	245	248	250	255	260	265	270
QRU-1W	48"L Steel Rail	48" x 5/8" x 3"	11	11	11	8	11	8	4	8	4	4	8	5	5	5	5	3	5	-	-	-	-	-
QRU-12S	Rack, 1 sided 12 rail	36" x 15" x 53"	96	96	96	-	-	-	36	-	-	36	-	24	24	24	20	-	24	12	12	12	20	8
QRU-16S	Rack, 1 sided 16 rail	36" x 15" x 53"	-	-	-	48	48	48	-	48	24	-	48	-	-	-	-	16	-	-	-	-	-	-
QRU-12D	Rack, 2 sided 12 rail	36" x 20" x 53"	192	192	192	-	-	-	72	-	-	72	-	48	48	48	40	-	48	24	24	24	40	16
QRU-16D	Rack, 2 sided 16 rail	36" x 20" x 53"	-	-	-	96	96	96	-	96	48	-	96	-	-	-	-	32	-	-	-	-	-	-
QRU-MOB	Mobile Kit - Mobilizes Double Sided Units																							

See pg. 5 for bin dimensions



**Single & Double Sided Rail Systems - Complete Packages**

**Single Sided Systems:** 36"L x 15"W x 53"H offers 600 lb. load capacity. Available in 4 different configurations.

**Double Sided Systems:** 36"L x 20"W x 53"H offers 1,600 lb. load capacity. Available in 3 different configurations. Mobilize double sided system with the addition of **QRU-MOB**.



QRU-16S-220230240

**Bench Racks - Complete Packages**

27-3/4"L x 8"W x 21"H and 36"L x 8"W x 19"H Bench Racks are available in 3 pre-configured choices. Bench Racks can be joined together to form continuous systems.



QBR-3619-210-32

**Louvered Panels - Complete Packages**

18"L x 19"H, 36"L x 19"H, 36"L x 61"H and 48"L x 61"H Louvered Panels are available in 3 configurations. Louvered Panels are available in Gray or Oyster White color. To order an Oyster White Louvered Panel add **HC** to the model number (i.e. **QLP-1819HC-210-18**). Mounting hardware is not included.



QLP-1819-220-16

**Mobile Double Sided Louvered Rack Systems - Complete Packages**

36"L x 25"W x 72"H Mobile Double Sided Louvered Rack System offers 1,200 lb. load capacity. 2 rigid, 2 swivel with brake hard rubber casters.



QMD-36H-230240



MODEL NO.	NO. OF BINS	BIN DIMENSIONS L" x W" x H"	SHIP WGT
<b>36"L x 15"W x 53"H - Single Sided Rail Systems</b>			
QRU-12S-220-96	96	7-3/8" x 4-1/8" x 3"	82 lbs
QRU-16S-230-48	48	10-7/8" x 5-1/2" x 5"	108 lbs
QRU-12S-240-24	24	14-3/4" x 8-1/4" x 7"	102 lbs
	16	7-3/8" x 4-1/8" x 3"	
QRU-16S-220230240	18	10-7/8" x 5-1/2" x 5"	108 lbs
	12	14-3/4" x 8-1/4" x 7"	
<b>36"L x 20"W x 53"H - Double Sided Rail Systems</b>			
QRU-12D-220-192	192	7-3/8" x 4-1/8" x 3"	113 lbs
QRU-16D-230-96	96	10-7/8" x 5-1/2" x 5"	155 lbs
QRU-12D-240-48	48	14-3/4" x 8-1/4" x 7"	153 lbs
QRU-MOB	Mobile Kit - Mobilizes Double Sided Systems		25 lbs

MODEL NO.	NO. OF BINS	BIN DIMENSIONS L" x W" x H"	SHIP WGT
<b>27-3/4"L x 8"W x 21"H - Bench Racks</b>			
QBR-2721-210-24	24	5-3/8" x 4-1/8" x 3"	23 lbs
QBR-2721-220-24	24	7-3/8" x 4-1/8" x 3"	25 lbs
QBR-2721-230-12	12	10-7/8" x 5-1/2" x 5"	28 lbs
<b>36"L x 8"W x 19"H - Bench Racks</b>			
QBR-3619-210-32	32	5-3/8" x 4-1/8" x 3"	29 lbs
QBR-3619-220-32	32	7-3/8" x 4-1/8" x 3"	31 lbs
QBR-3619-230-18	18	10-7/8" x 5-1/2" x 5"	37 lbs

MODEL NO.	NO. OF BINS	BIN DIMENSIONS L" x W" x H"	SHIP WGT
<b>18"L x 19"H - Louvered Panels</b>			
QLP-1819-210-16	16	5-3/8" x 4-1/8" x 3"	11 lbs
QLP-1819-220-16	16	7-3/8" x 4-1/8" x 3"	12 lbs
QLP-1819-230-9	9	10-7/8" x 5-1/2" x 5"	16 lbs
<b>36"L x 19"H - Louvered Panels</b>			
QLP-3619-210-32	32	5-3/8" x 4-1/8" x 3"	22 lbs
QLP-3619-220-32	32	7-3/8" x 4-1/8" x 3"	24 lbs
QLP-3619-230-18	18	10-7/8" x 5-1/2" x 5"	30 lbs
<b>36"L x 61"H - Louvered Panels</b>			
QLP-3661-220-120	120	7-3/8" x 4-1/8" x 3"	80 lbs
QLP-3661-230-60	60	10-7/8" x 5-1/2" x 5"	90 lbs
QLP-3661-240-28	28	14-3/4" x 8-1/4" x 7"	96 lbs
<b>48"L x 61"H - Louvered Panels</b>			
QLP-4861-220-165	165	7-3/8" x 4-1/8" x 3"	115 lbs
QLP-4861-230-80	80	10-7/8" x 5-1/2" x 5"	127 lbs
QLP-4861-240-35	35	14-3/4" x 8-1/4" x 7"	130 lbs

MODEL NO.	NO. OF BINS	BIN DIMENSIONS L" x W" x H"	SHIP WGT
<b>36"L x 25"W x 72"H - Mobile Double Sided Louvered Rack</b>			
QMD-36H-220	240	7-3/8" x 4-1/8" x 3"	174 lbs
QMD-36H-230	120	10-7/8" x 5-1/2" x 5"	212 lbs
QMD-36H-240	56	14-3/4" x 8-1/4" x 7"	208 lbs
QMD-36H-230240	72	10-7/8" x 5-1/2" x 5"	217 lbs
	24	14-3/4" x 8-1/4" x 7"	

**COMPLETE PACKAGES WITH BINS**

Bins available in: ● Blue ● Green ● Ivory ● Red ● Yellow ● Black ● Clear (One color per unit)



AVAILABLE on pg. 20

**Giant Open Hopper Steel Shelving Systems - Complete Packages**

These economical high density bin storage systems include heavy-duty giant stack bins with open hopper fronts for easy access. Optional clear window fronts maximize capacity, prevent spillage and convert the bin to a true tote. Optional dividers keep contents organized - available on **pg. 5**. Heavy-duty, industrial grade shelving with 400 lb. load capacity per shelf.

# COMPLETE PACKAGES WITH BINS

## 12" Deep Systems

## 18" Deep Systems



**QSBU-230240**

12"D x 36"W x 75"H  
10 shelves and 36 QUS230  
10-7/8"L x 5-1/2"W x 5"H bins  
and 12 QUS240  
14-3/4"L x 8-1/4"W x 7"H bins



**QSBU-239**

12"D x 36"W x 75"H  
8 shelves and 28 QUS239  
10-3/4"L x 8-1/4"W x 7"H bins



**QSBU-255**

18"D x 36"W x 75"H  
8 shelves and 21 QUS255  
16"L x 11"W x 8"H bins  
*(Windows sold separately)*



**QSBU-260**

18"D x 36"W x 75"H  
6 shelves and 15 QUS260  
18"L x 11"W x 10"H bins  
*(Windows and dividers sold separately)*



**QSBU-240**

12"D x 36"W x 75"H  
8 shelves and 28 QU240  
14-3/4"L x 8-1/4"W x 7"H bins



**QSBU-250**

12"D x 36"W x 75"H  
8 shelves and 14 QUS250  
14-3/4"L x 16-1/2"W x 7"H bins



**QSBU-265**

18"D x 36"W x 75"H  
7 shelves and 24 QUS265  
18"L x 8-1/4"W x 9"H bins



**QSBU-270**

18"D x 36"W x 75"H  
6 shelves and 10 QUS270  
18"L x 16-1/2"W x 11"H bins

Bins available in: ● Blue ● Green ● Ivory ● Red ● Yellow ● Black ● Clear *(One color per unit)*

Giant Open Hopper Wire Shelving Systems - Complete Packages

**CLEAR VIEW**  
AVAILABLE on pg. 20



MOBILIZE YOUR WIRE SHELVING

**DB - Donut Bumper**  
Non-marking donut bumper used to protect walls and help cushion impact.

**WR-00H (Mobile Kit)\***  
Set of four swivel thermoplastic resin 5" x 1-1/4" casters, two with brakes, 1,200 lb. load capacity. \*Mobile kits recommended only for shelves 18" and deeper.

COMPLETE PACKAGES WITH BINS

12" and 14" Deep Systems

18" Deep Systems



**WR8-239**  
12"W x 36"L x 74"H  
8 shelves and 28 QUS239  
10-3/4"L x 8-1/4"W x 7"H bins



**WR8-240**  
14"W x 36"L x 74"H  
8 shelves and 28 QU240  
14-3/4"L x 8-1/4"W x 7"H bins



**WR8-255**  
18"W x 36"L x 74"H  
8 shelves and 21 QUS255  
16"L x 11"W x 8"H bins



**WR6-260**  
18"W x 36"L x 74"H  
6 shelves and 15 QUS260  
18"L x 11"W x 10"H bins



**WR8-250**  
14"W x 36"L x 74"H  
8 shelves and 14 QUS250  
14-3/4"L x 16-1/2"W x 7"H bins



**WR10-230240**  
14"W x 36"L x 74"H  
10 shelves and 36 QUS230  
10-7/8"L x 5-1/2"W x 5"H bins and  
12 QUS240 14-3/4"L x 8-1/4"W x 7"H bins



**WR6-265**  
18"W x 36"L x 74"H  
6 shelves and 20 QUS265  
18"L x 8-1/4"W x 9"H bins



**WR5-270**  
18"W x 36"L x 74"H  
5 shelves and 8 QUS270  
18"L x 16-1/2"W x 11"H bins

Bins available in: Blue Green Ivory Red Yellow Black Clear (One color per unit)



**36" Wide All-Welded Bin Cabinet**



All-Purpose cabinets provide secure storage for your valuable parts and tools. Standard performance features: ships completely assembled, ready to use, 14 gauge all-welded construction, gray or beige powder-coated finish which ensures years of heavy-duty service, 3 point locking handle supplied with 2 keys. To order a Beige cabinet, add **BG** right after cabinet prefix (i.e. **QSC-BG-36** or **MESH-BG-240** or **QPR-BG-101**). See pg. 5 for bin dimensions.



**QSC-36-68** **NEW**

36"W x 24"D x 72"H. Deep Door model. Ship wt. 425 lbs. Total of **68** bins. **16 QUS232, 16 QUS236, 18 QUS230, 12 QUS240** and **6 QUS250**.

**COMPLETE PACKAGES WITH BINS**

Also Available:

**QSC-36**  
Total of **132** bins.  
**48 QUS210**  
**48 QUS220**  
**18 QUS230**  
**12 QUS240**  
**6 QUS250**

**NEW**

Also Available:

**QSC-36S-38**  
Total of **38** bins.  
**16 QUS232**  
**16 QUS236**  
**6 QUS250**



**QSC-36S**

36"W x 24"D x 72"H. Deep Door model. Ship wt. 465 lbs. Total of **102** bins. **48 QUS210, 48 QUS220, 6 QUS250** and **3** adjustable shelves. **800 lb.** capacity per interior shelf.

**CABINETS NOW AVAILABLE WITH 2 BIN COMBINATIONS TO CHOOSE FROM**

*(New wider bins on doors NOW AVAILABLE)*



**QSC-64-2S-6DS**

36"W x 24"D x 72"H. Deep Door model. Ship wt. 427 lbs. Total of **64** bins. **48 QUS220, 16 QUS240, 2** adjustable interior shelves and **6** door shelves. **800 lb.** capacity per interior shelf. **60 lb.** capacity per door shelf.

**NEW**

Also Available:

**QSC-32-2S-6DS**  
Total of **32** bins.  
**16 QUS236**  
**16 QUS240**

**NEW**

Also Available:

**QSC-36-32-4IS**  
Total of **32** bins.  
**32 QUS232**



**QSC-36-96-4IS**

36"W x 24"D x 72"H. Deep Door model. Ship wt. 377 lbs. Total of **96** bins. **96 QUS210** and **4** adjustable interior shelves. **800 lb.** capacity per interior shelf.

**CABINETS AVAILABLE IN GRAY OR BEIGE COLOR**

**14 GAUGE ALL-WELDED STEEL CONSTRUCTION**

**CABINET ARRIVES FULLY ASSEMBLED READY TO USE**



**QSC-36-FD**

36"W x 18"D x 72"H. Flush Door model. Ship wt. 359 lbs. Total of **36** bins. **18 QUS230, 12 QUS240** and **6 QUS250**.



**QSC-36-4IS-12DS**

36"W x 24"D x 72"H. Deep Door model. Ship wt. 308 lbs. **4** adjustable interior shelves and **12** door shelves. **800 lb.** capacity per interior shelf. **60 lb.** capacity per door shelf.

Bins available in: ● Blue ● Green ● Ivory ● Red ● Yellow ● Black ● Clear (One color per unit)



**QPR-101**

**Sloped Shelf Pick Rack Flow Cabinet**  
 36"W x 18"D x 78"H.  
 Flush Door model. Ship wt. 298 lbs.  
 Total of **72** bins. **Eight** sloped shelves  
 and **one** flat shelf total **72 QSB101** bins.  
 Additional cabinet configurations listed below.  
 400 lb. capacity per interior shelf.



MODEL NO.	NO. OF BINS	BIN MODEL NO.	SHIP WGT
QPR-101	72	QSB101	298 lbs
QPR-102	45	QSB102	294 lbs
QPR-107	36	QSB107	289 lbs

See pg. 48 for bin dimensions

**CABINETS AVAILABLE IN GRAY OR BEIGE COLOR**

**MESH-240**

**Wire Mesh Safe-View Bin Cabinet**  
 36"W x 18"D x 78"H.  
 Mesh Door model. Ship wt. 290 lbs.  
 Total of **36** bins. Louvered back wall fits  
**36 QUS240**. Additional cabinet  
 configurations listed below.

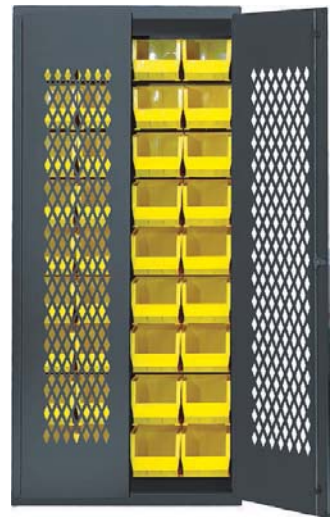

MODEL NO.	NO. OF BINS	BIN MODEL NO.	SHIP WGT
MESH-240	36	QUS240	290 lbs
MESH-240250	20 8	QUS240 QUS250	303 lbs
MESH-250	18	QUS250	288 lbs

See pg. 5 for bin dimensions

**COMPLETE PACKAGES WITH BINS**



**QSC-36-MIN**

**Counter High Cabinet**  
 36"W x 24"D x 36"H.

Ship wt. 218 lbs. Total of **66** bins. **24 QUS210**, **24 QUS220**, **12 QUS230**, **4 QUS240**  
 and **2 QUS250**. See pg. 5 for bin dimensions.

**QSC-C240250**

**Clear-View Security Bin Cabinet**  
 36"W x 18"D x 78"H.

Clear Acrylic Door model. Ship wt. 388 lbs.  
 Total of **28** bins. Louvered back wall fits  
**20 QUS240** and **8 QUS250**. Additional cabinet  
 configurations listed below.



MODEL NO.	NO. OF BINS	BIN MODEL NO.	SHIP WGT
QSC-C240	36	QUS240	390 lbs
QSC-C240250	20 8	QUS240 QUS250	388 lbs
QSC-C250	18	QUS250	392 lbs

See pg. 5 for bin dimensions

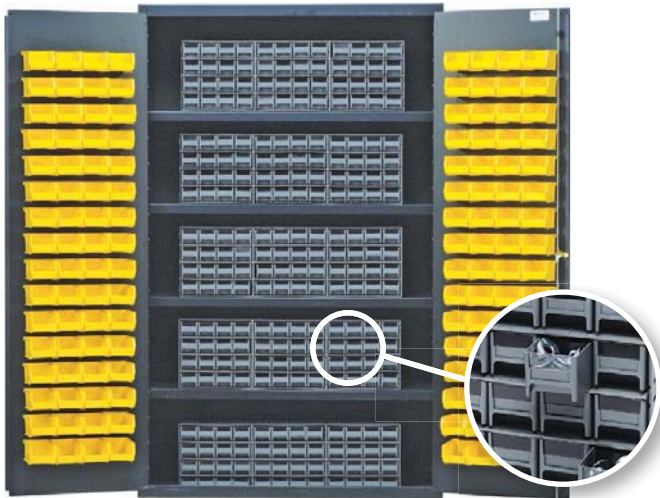

**QSC-QIC161**

**Interlocking Drawer Storage Cabinet**  
 48"W x 24"D x 78"H.

Ship wt. 507 lbs. Total of **128** bins and **15** Interlocking Drawer Cabinets. Louvered door fits  
**128 QUS210** bins (see pg. 5 for bin dimensions). Shelves hold **15** Interlocking Cabinet Units.  
 Interlocking Cabinets have a Gray exterior, Drawers are available in Blue, Red, Ivory and Gray.  
 Door bins available in Blue, Green, Ivory, Red, Yellow, Black and Clear.  
 400 lb. capacity per interior shelf.

MODEL NO.	CABINET MODEL NO.	NO. OF DRAWERS	SHIP WGT
QSC-QIC161	QIC-161	240	507 lbs
QSC-QIC122	QIC-122	180	507 lbs
QSC-QIC83	QIC-83	120	492 lbs
QSC-QIC64	QIC-64	90	492 lbs

See pg. 94 for cabinet and drawer dimensions



**QSC-3672-4D**

36"W x 24"D x 72"H.

Flush Door model. Ship wt. 663 lbs. Comes complete with **one** 18" deep adjustable shelf,  
**12** door shelves, **four** 31"W x 16"D drawers: **two** are 3" high, **one** is 5" high, **one** is 6" high.  
 Total of **58** bins. **36 QUS220**, **18 QUS230** and **4 QUS240**.  
 800 lb. capacity per interior shelf. 60 lb. capacity per door shelf.  
 See pg. 5 for bin dimensions.

Bins available in: ● Blue ● Green ● Ivory ● Red ● Yellow ● Black ● Clear (One color per unit)





**48" Wide All-Welded Bin Cabinets**



These 48" wide models offer all of the features of the 36", but with additional storage space. All cabinets are also available in Beige color. To order a Beige cabinet, add **BG** right after cabinet prefix (i.e. **QSC-BG-48** or **MESH-BG-240** or **QPR-BG-101**). See **pg. 5** for bin dimensions.



**QSC-48**

48"W x 24"D x 78"H. Flush Door Model. Ship wt. 522 lbs. Total of **171** bins. **64 QUS210, 64 QUS220, 24 QUS230, 13 QUS240** and **6 QUS250**.

**COMPLETE PACKAGES WITH BINS**



**QSC-48S**

48"W x 24"D x 78"H. Flush Door Model. Ship wt. 534 lbs. Total of **137** bins. **64 QUS210, 64 QUS220, 3 QUS240, 6 QUS250** and **3 adjustable shelves**. **400 lb. capacity per interior shelf**.



**QSC-4803**

48"W x 24"D x 78"H. Flush Door Model. Ship wt. 505 lbs. Total of **128** bins. **128 QUS210** and **4 adjustable interior shelves**. **400 lb. capacity per interior shelf**.

**CABINETS AVAILABLE IN GRAY OR BEIGE COLOR**



**QSC-4804**

48"W x 24"D x 78"H. Flush Door Model. Ship wt. 515 lbs. Total of **84** bins. **20 QUS240, 64 QUS220, 2 adjustable interior shelves** and **6 door shelves**. **400 lb. capacity per interior shelf. 60 lb. capacity per door shelf**.



**QSC-4805**

48"W x 24"D x 78"H. Flush Door Cabinet. Ship wt. 484 lbs. Total of **64** bins. **64 QUS210** and **punched panels on inside rear wall and doors, 2 adjustable interior shelves**. **400 lb. capacity per interior shelf**.

**PERFECT FOR JANITORIAL AND MAINTENANCE STORAGE**



**QSC-4IS-14DS**

48"W x 24"D x 84"H. Deep Door Model. Ship wt. 572 lbs. **4 adjustable interior shelves** and **14 adjustable door shelves**. **400 lb. capacity per interior shelf. 60 lb. capacity per door shelf**.

Bins available in: ● Blue ● Green ● Ivory ● Red ● Yellow ● Black ● Clear (One color per unit)

48" Wide All-Welded Cabinet



48" wide all-welded all purpose cabinet with 4 interior and adjustable shelves. Cabinet is also available in Beige color. To order Beige cabinet, add **BG** right after cabinet prefix (i.e. **QSC-BG-3IS**).

**CABINET AVAILABLE IN GRAY OR BEIGE COLOR**

**14 GAUGE ALL-WELDED STEEL CONSTRUCTION**

**CABINET ARRIVES FULLY ASSEMBLED READY TO USE**



**QSC-3IS**

48"W x 24"D x 78"H. Flush Door model. Ship wt. 323 lbs. 3 adjustable shelves. 400 lb. capacity per shelf.

Mobile Rail Cart



Mobilize your parts and supplies with this ultra-convenient storage and transport cart. Eliminates lugging heavy bins or loading them onto a regular cart. Multiple bin configurations to choose from. Flat top with raised edges contains more equipment and doubles as a work surface. 16-gauge cold-rolled steel with a powder coated gray finish. All-welded steel push handle. Two rigid and two swivel poly casters with brake. 800 lb. load capacity.

**800 lb. MOBILE LOAD CAPACITY**



**QRC-4D Mobile Ergonomic Cart**

36"L x 24"W x 35-1/2"H  
800 lb. load capacity.  
Accepts 6 sizes of Ultra Bins (up to 64 bins).  
Includes 2 rigid and 2 swivel, with brake, hard rubber casters.  
(Bins sold separately)

MODEL NO.	DESCRIPTION	QUS 200	QUS 210	QUS 220	QUS 230	QUS 235	QUS 239
<b>Quantity of Ultra Bins to Fit Rail Cart</b>							
<b>QRC-4D</b>	36" x 24" Rail Cart	64	64	64	48	24	16

See pg. 5 for bin dimensions

Bins available in: Blue Green Ivory Red Yellow Black Clear (One color per unit)



**Super-Wide Colossal Heavy-Duty Cabinets**



Super-Wide Colossal Cabinets offer 60" or 72" widths and 84" heights allowing for maximum and efficient storage while providing superior strength and security. Standard performance features: ships completely assembled, ready to use, 14 gauge all-welded construction, gray or beige powder-coated finish which ensures years of heavy-duty service, 3 point locking handle with provision for a padlock (*not included*) and 6" high legs make cabinets fork truck liftable. To order a Beige cabinet, add **BG** right after cabinet prefix (*i.e. QSC-BG-60 or MESH-BG-240 or QPR-BG-101*). See *pg. 5* for bin dimensions.



**QSC-60**  
60"W x 24"D x 84"H. Flush Door model. Ship wt. 860 lbs.  
Total of 227 bins. 80 QUS210, 90 QUS220, 30 QUS230, 18 QUS240 and 9 QUS250.



**QSC-60S**  
60"W x 24"D x 84"H. Flush Door model. Ship wt. 878 lbs.  
Total of 185 bins. 80 QUS210, 90 QUS220, 6 QUS240, 9 QUS250 and 3 adjustable shelves. 500 lb. capacity per interior shelf.

**CABINETS AVAILABLE IN GRAY OR BEIGE COLOR**

**COMPLETE PACKAGES WITH BINS**

**72" CABINETS NOW AVAILABLE WITH 2 BIN COMBINATIONS TO CHOOSE FROM**  
*(New wider bins on doors NOW AVAILABLE)*



**QSC-72**  
72"W x 24"D x 84"H. Flush Door model. Ship wt. 1,002 lbs.  
Total of 264 bins. 96 QUS210, 96 QUS220, 36 QUS230, 24 QUS240 and 12 QUS250.

**Also Available:**  
**QSC-72-136** **NEW**  
Total of 136 bins.  
32 QUS232  
32 QUS236  
36 QUS230  
24 QUS240  
12 QUS250



**Also Available:**  
**QSC-72S**  
Total of 212 bins.  
96 QUS210  
96 QUS220  
8 QUS240  
12 QUS250

**QSC-72S-84** **NEW**  
72"W x 24"D x 84"H. Flush Door model. Ship wt. 955 lbs.  
Total of 84 bins. 32 QUS232, 32 QUS236, 8 QUS240, 12 QUS250 and 3 adjustable shelves. 500 lb. capacity per interior shelf.

Bins available in: ● Blue ● Green ● Ivory ● Red ● Yellow ● Black ● Clear *(One color per unit)*



**Clear-View Ultra Stack & Hang Bins**



Organize your inventory with strong injection molded tri-clear virgin-grade polypropylene bins. Front, back and side grips for easy handling. Built in rear hanger allows bins to hang from louvered panels or rails. Optional clear injection molded crystal styrene window fronts increases bin capacity and provides quick view of bin contents. Dividers maximize flexibility and keep contents organized. Wide stacking ledge and anti-slide lock keep stacked bins steady and prevent forward shifting. Waterproof bins resist rust and corrosion. Large molded front label slots for ID labels. Autoclavable up to 250°F and resistant to extreme cold.



**CLEAR**  
**VIEW**

**NEW**  
**SIZES**

**QUANTUM IS CLEARLY YOUR STORAGE SOLUTION**

See pg. 5 for accompanying dividers, clear lids, clear window fronts and clear label holders.



**MOBILIZE YOUR WIRE SHELVING**

**DB - Donut Bumper**

Non-marking donut bumper used to protect walls and help cushion impact.

**WR-00H (Mobile Kit)\***

Set of four swivel thermoplastic resin 5" x 1-1/4" casters, two with brakes. 1,200 lb. load capacity. \*Mobile kits recommended only for shelves 18" and deeper.

**COMPLETE PACKAGES WITH BINS**



**WR8-240CL**



**QSBU-240CL**

Available in:  Clear

MODEL NO.	OUTSIDE DIMENSIONS L" x W" x H"	CTN QTY	CTN WGT
QUS200CL	5" x 4-1/8" x 3"	24	5 lbs
QUS210CL	5-3/8" x 4-1/8" x 3"	24	6 lbs
QUS220CL	7-3/8" x 4-1/8" x 3"	24	8 lbs
QUS221CL	9-1/4" x 6" x 5"	12	6 lbs
QUS224CL	10-7/8" x 4-1/8" x 4"	12	8 lbs
QUS230CL	10-7/8" x 5-1/2" x 5"	12	10 lbs
QUS232CL <b>NEW</b>	5-3/8" x 11" x 3"	8	5 lbs
QUS234CL	14-3/4" x 5-1/2" x 5"	12	14 lbs
QUS235CL	10-7/8" x 11" x 5"	6	10 lbs
QUS236CL <b>NEW</b>	7-3/8" x 11" x 3"	8	9 lbs
QUS238CL <b>NEW</b>	18" x 5-1/2" x 5"	12	16 lbs
QUS239CL	10-3/4" x 8-1/4" x 7"	6	10 lbs
QUS240CL	14-3/4" x 8-1/4" x 7"	12	24 lbs
QUS241CL	13-5/8" x 8-1/4" x 6"	12	22 lbs
QUS242CL	13-5/8" x 8-1/4" x 8"	12	25 lbs
QUS245CL	10-7/8" x 16-1/2" x 5"	6	13 lbs
QUS248CL <b>NEW</b>	18" x 8-1/4" x 7"	6	19 lbs
QUS250CL	14-3/4" x 16-1/2" x 7"	6	21 lbs
QUS255CL	16" x 11" x 8"	4	14 lbs
QUS260CL	18" x 11" x 10"	4	17 lbs
QUS265CL	18" x 8-1/4" x 9"	6	17 lbs
QUS270CL	18" x 16-1/2" x 11"	3	16 lbs
QUS275MOBCL	18" x 16-1/2" x 11"	3	25 lbs

\*With casters, overall height is 14"

**Clear-View Ultra Stack & Hang Bin Wire Shelving Systems - Complete Packages**

Bins available in:  Clear **800 lb. LOAD CAPACITY PER SHELF**

MODEL NO.	NO. OF SHELVES	NO. OF BINS	BIN DIMENSIONS L" x W" x H"	SHIP WGT
<b>12"W x 36"L x 74"H - Systems</b>				
WR8-239CL	8	28 QUS239CL	10-3/4" x 8-1/4" x 7"	103 lbs
WR7-245CL	7	24 QUS245CL	10-7/8" x 16-1/2" x 5"	111 lbs
<b>14"W x 36"L x 74"H - Systems</b>				
WR10-230240CL	10	36 QUS230CL 12 QUS240CL	10-7/8" x 5-1/2" x 5" 14-3/4" x 8-1/4" x 7"	146 lbs
WR8-240CL	8	28 QUS240CL	14-3/4" x 8-1/4" x 7"	128 lbs
WR8-250CL	8	14 QUS250CL	14-3/4" x 16-1/2" x 7"	129 lbs
<b>18"W x 36"L x 74"H - Systems</b>				
WR8-255CL	8	21 QUS255CL	16" x 11" x 8"	152 lbs
WR6-260CL	6	15 QUS260CL	18" x 11" x 10"	127 lbs
WR6-265CL	6	20 QUS265CL	18" x 8-1/4" x 9"	124 lbs
WR5-270CL	5	8 QUS270CL	18" x 16-1/2" x 11"	104 lbs

**Clear-View Ultra Stack & Hang Bin Steel Shelving Systems - Complete Packages**

Bins available in:  Clear **400 lb. LOAD CAPACITY PER SHELF**

MODEL NO.	NO. OF SHELVES	NO. OF BINS	BIN DIMENSIONS L" x W" x H"	SHIP WGT
<b>12"D x 36"W x 75"H - Systems</b>				
QSBU-239CL	8	28 QUS239CL	10-3/4" x 8-1/4" x 7"	99 lbs
QSBU-230240CL	10	36 QUS230CL 12 QUS240CL	10-7/8" x 5-1/2" x 5" 14-3/4" x 8-1/4" x 7"	122 lbs
QSBU-240CL	8	28 QUS240CL	14-3/4" x 8-1/4" x 7"	110 lbs
QSBU-245CL	7	24 QUS245CL	10-7/8" x 16-1/2" x 5"	111 lbs
QSBU-250CL	8	14 QUS250CL	14-3/4" x 16-1/2" x 7"	99 lbs
<b>18"D x 36"W x 75"H - Systems</b>				
QSBU-255CL	8	21 QUS255CL	16" x 11" x 8"	140 lbs
QSBU-260CL	6	15 QUS260CL	18" x 11" x 10"	120 lbs
QSBU-265CL	7	24 QUS265CL	18" x 8-1/4" x 9"	134 lbs
QSBU-270CL	6	10 QUS270CL	18" x 16-1/2" x 11"	117 lbs



QLP-1819-230-9CL



QBR-2721-220-24CL



Clear-View 12" Plastic Rail Systems - Complete Packages

Comes with 2 handy 12" Plastic Rails ideal for mounting to any surface. Bins can hang or stack securely providing an efficient bin storage system. Available in Clear. Rails available in White. Mounting hardware is not included.

Table with 4 columns: MODEL NO., BIN DIMENSIONS L" x W" x H", DESCRIPTION, SHIP WGT. Rows include HNS200CL, HNS210CL, HNS220CL, HNS230CL, and HNS006.

HNS230CL



COMPLETE PACKAGES WITH BINS

Clear-View Bench Racks & Louvered Panel Systems - Complete Packages

Bench Racks: 27-3/4"L x 8"W x 21"H and 36"L x 8"W x 19"H. Both Bench Racks are available in 3 pre-configured choices. Bench Racks can be joined together to form continuous systems.

Louvered Panels: 18"L x 19"H, 36"L x 19"H, 36"L x 61"H and 48"L x 61"H panels are available in 3 configurations. Louvered Panels are available in Gray or Oyster White color. To order an Oyster White Louvered Panel add HC to the model number (i.e. QLP-1819HC-210-18CL). Mounting hardware is not included.

Bins available in: Clear

Table with 4 columns: MODEL NO., NO. OF BINS, BIN DIMENSIONS L" x W" x H", SHIP WGT. Rows include Bench Rack Systems (27-3/4"L x 8"W x 21"H and 36"L x 8"W x 19"H) and Louvered Panel Systems (18"L x 19"H, 36"L x 19"H, 36"L x 61"H, 48"L x 61"H).

Clear-View Rail Systems - Complete Packages

Bins available in: Clear

Table with 4 columns: MODEL NO., NO. OF BINS, BIN DIMENSIONS L" x W" x H", SHIP WGT. Rows include Single Sided Rail Systems (36"L x 15"W x 53"H) and Double Sided Rail Systems (36"L x 20"W x 53"H).

Clear-View Mobile Double Sided Louvered Rack Systems - Complete Packages

Bins available in: Clear

Table with 4 columns: MODEL NO., NO. OF BINS, BIN DIMENSIONS L" x W" x H", SHIP WGT. Rows include Mobile Unit 1,200 lb. Capacity (36"L x 25"W x 72"H).



QMD-36H-240CL



QRU-12D-220-192CL + QRU-MOB Double Sided Rack, 12 Rails with Mobile Kit 1,000 lb. capacity. 2 rigid, 1 swivel and 1 swivel with brake hard rubber casters. Accepts 12 sizes of Ultra Bins (up to 192 bins).



Clear-View HULK 24" Containers



Organize and store your large and bulky items with these strong injection molded tri-clear virgin-grade polypropylene, stackable containers. These extra large stacking containers offer a generous 2 feet in length to store your larger items. Heavy-duty front, back and side grips allow for easy handling. Clear window fronts and dividers available on **pg. 34**. Wide stacking ledge and anti-slide lock keep stacked bins steady and prevent forward shifting. Waterproof bins resist rust and corrosion. Bins are autoclavable up to 250°F and are resistant to extreme cold.

Available in:  Clear

MODEL NO.	OUTSIDE DIMENSIONS L" x W" x H"	CTN QTY	CTN WGT
QUS950CL	23-7/8" x 8-1/4" x 7"	6	18 lbs
QUS951CL	23-7/8" x 8-1/4" x 9"	6	21 lbs
QUS952CL	23-7/8" x 11" x 7"	4	14 lbs
QUS953CL	23-7/8" x 11" x 10"	4	18 lbs
QUS954CL	23-7/8" x 16-1/2" x 11"	1	7 lbs
QUS964MOBCL	23-7/8" x 16-1/2" x 11"	1	9 lbs
QUS955CL	23-7/8" x 18-1/4" x 12"	1	8 lbs
QUS965MOBCL	23-7/8" x 18-1/4" x 12"	1	10 lbs
QUS957CL <b>NEW</b>	23-7/8" x 22-1/2" x 12"	1	8 lbs
QUS967MOBCL <b>NEW</b>	23-7/8" x 22-1/2" x 12"	1	10 lbs

\*With casters, overall height for mobile container will be increased by 3"

QUANTUM IS CLEARLY YOUR STORAGE SOLUTION

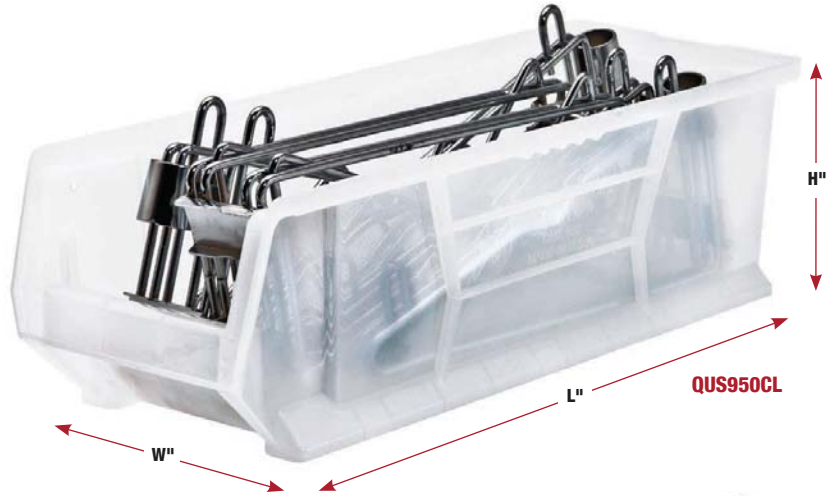

COMPLETE PACKAGES WITH BINS



Clear-View HULK 24" Container Wire Shelving Systems - Complete Packages

Bins available in:  Clear **800 lb. LOAD CAPACITY PER SHELF**

MODEL NO.	NO. OF SHELVES	NO. OF BINS	BIN DIMENSIONS L" x W" x H"	SHIP WGT
<b>24"W x 36"L x 74"H - Systems</b>				
WR8-950CL	8	28 QUS950CL	23-7/8" x 8-1/4" x 7"	205 lbs
WR8-950952CL	8	12 QUS950CL 12 QUS952CL	23-7/8" x 8-1/4" x 7" 23-7/8" x 11" x 7"	197 lbs
WR8-952CL	8	21 QUS952CL	23-7/8" x 11" x 7"	191 lbs
WR7-951CL	7	24 QUS951CL	23-7/8" x 8-1/4" x 9"	188 lbs
WR7-20-MIXCL	7	8 QUS950CL	23-7/8" x 8-1/4" x 7"	182 lbs
		4 QUS951CL	23-7/8" x 8-1/4" x 9"	
		3 QUS952CL	23-7/8" x 11" x 7"	
		3 QUS953CL	23-7/8" x 11" x 10"	
		2 QUS954CL	23-7/8" x 16-1/2" x 11"	
WR6-953CL	6	15 QUS953CL	23-7/8" x 11" x 10"	156 lbs
WR6-953954CL	6	9 QUS953CL	23-7/8" x 11" x 10"	159 lbs
		4 QUS954CL	23-7/8" x 16-1/2" x 11"	
WR6-954CL	6	10 QUS954CL	23-7/8" x 16-1/2" x 11"	164 lbs
<b>24"W x 42"L x 74"H - System</b>				
WR5-955CL	5	8 QUS955CL	23-7/8" x 18-1/4" x 12"	145 lbs
<b>24"W x 48"L x 74"H - System</b>				
WR6-957CL <b>NEW</b>	6	10 QUS957CL	23-7/8" x 22-1/2" x 12"	192 lbs

Clear-View HULK 24" Container Steel Shelving Systems - Complete Packages

Bins available in:  Clear **350 lb. LOAD CAPACITY PER SHELF**

MODEL NO.	NO. OF SHELVES	NO. OF BINS	BIN DIMENSIONS L" x W" x H"	SHIP WGT
<b>24"D x 36"W x 75"H - Systems</b>				
2475-950CL	8	28 QUS950CL	23-7/8" x 8-1/4" x 7"	213 lbs
2475-950952CL	8	12 QUS950CL 12 QUS952CL	23-7/8" x 8-1/4" x 7" 23-7/8" x 11" x 7"	195 lbs
2475-952CL	8	21 QUS952CL	23-7/8" x 11" x 7"	205 lbs
2475-951CL	7	24 QUS951CL	23-7/8" x 8-1/4" x 9"	199 lbs
2475-20MIXCL	7	8 QUS950CL	23-7/8" x 8-1/4" x 7"	189 lbs
		4 QUS951CL	23-7/8" x 8-1/4" x 9"	
		3 QUS952CL	23-7/8" x 11" x 7"	
		3 QUS953CL	23-7/8" x 11" x 10"	
		2 QUS954CL	23-7/8" x 16-1/2" x 11"	
2475-953CL	6	15 QUS953CL	23-7/8" x 11" x 10"	163 lbs
2475-953954CL	6	9 QUS953CL	23-7/8" x 11" x 10"	166 lbs
		4 QUS954CL	23-7/8" x 16-1/2" x 11"	
2475-954CL	6	10 QUS954CL	23-7/8" x 16-1/2" x 11"	171 lbs



MOBILIZE YOUR WIRE SHELVING

**DB - Donut Bumper**  
Non-marking donut bumper used to protect walls and help cushion impact.

**WR-00H (Mobile Kit)**  
Set of four swivel thermoplastic resin 5" x 1-1/4" casters, two with brakes. Can be used with all systems shown. 1,200 lb. load capacity.



QGH700CL



QGH705MOBCL

## COMPLETE PACKAGES WITH BINS

### Clear-View Giant Stack Containers



Multipurpose, wide open hopper front provides easy access for large part storage. Ideal for multiple applications in recycling, storing parts, tools and warehouse items. This bin will stack up to 6 bins high creating a sturdy, tall storage system. Injection molded from high density tri-clear virgin-grade polypropylene, easy to clean, resists rust and corrosion and impervious to most chemicals. Large label holder allows for quick identification. Optional clear window front increases storage capacity and allows for inspection of parts. Six 1/4" drill hole pattern on bottom of bin allows for easy hole insertion for drainage.

Available in:  Clear

MODEL NO.	OUTSIDE DIMENSIONS L" x W" x H"	CTN QTY	CTN WGT	WINDOW	CTN WGT
QGH600CL	17-1/2" x 10-7/8" x 12-1/2"	4	12 lbs	WGH600	4
QGH700CL*	15-1/4" x 19-7/8" x 12-7/16"	3	13 lbs	WGH700	3
QGH800CL*	17-1/2" x 16-1/2" x 12-1/2"	2	8 lbs	WGH800	2

\*With casters, overall height for mobile container will be increased by 3"



## QUANTUM IS CLEARLY YOUR STORAGE SOLUTION



WR5-600CL



### MOBILIZE YOUR WIRE SHELVING

#### DB - Donut Bumper

Non-marking donut bumper used to protect walls and help cushion impact.

#### WR-00H (Mobile Kit)

Set of four swivel thermoplastic resin 5" x 1-1/4" casters, two with brakes. Can be used with all systems shown. 1,200 lb. load capacity.



QSBU-700CL

### Clear-View Mobile Giant Stack Containers



- Ideal for transport of heavy and bulky parts
- Container comes with 4 swivel, 3" polyurethane casters, all with brakes, allowing for up to 250 lb. mobile load capacity
- Containers can stack with casters in place

Available in:  Clear

MODEL NO.	OUTSIDE DIMENSIONS L" x W" x H"	CTN QTY	CTN WGT	WINDOW	CTN WGT
QGH705MOBCL*	15-1/4" x 19-7/8" x 12-7/16"	3	22 lbs	WGH700	3
QGH805MOBCL*	17-1/2" x 16-1/2" x 12-1/2"	2	17 lbs	WGH800	2

\*With casters, overall height for mobile container will be increased by 3"

### Clear-View Giant Stack Wire Shelving Systems - Complete Packages

Bins available in:  Clear **800 lb. LOAD CAPACITY PER SHELF**

MODEL NO.	NO. OF BINS	BIN DIMENSIONS L" x W" x H"	SHIP WGT
<b>18"W x 36"L x 74"H - 5 Shelf Systems</b>			
WR5-600CL	12 QGH600CL	17-1/2" x 10-7/8" x 12-1/2"	104 lbs
WR5-600800CL	6 QGH600CL	17-1/2" x 10-7/8" x 12-1/2"	103 lbs
	4 QGH800CL	17-1/2" x 16-1/2" x 12-1/2"	
WR5-800CL	8 QGH800CL	17-1/2" x 16-1/2" x 12-1/2"	102 lbs
<b>18"W x 42"L x 74"H - 5 Shelf System</b>			
WR5-700CL	8 QGH700CL	15-1/4" x 19-7/8" x 12-7/16"	98 lbs

### Clear-View Giant Stack Steel Shelving Systems - Complete Packages

Smooth powder coat finish and cross bracing for increased stability. 400 lb. capacity per shelf and over 21 cubic feet of storage space.

Bins available in:  Clear **400 lb. LOAD CAPACITY PER SHELF**

MODEL NO.	NO. OF BINS	BIN DIMENSIONS L" x W" x H"	SHIP WGT
<b>18"W x 36"L x 75"H - 6 Shelf Systems</b>			
QSBU-600CL	12 QGH600CL	17-1/2" x 10-7/8" x 12-1/2"	116 lbs
QSBU-600800CL	6 QGH600CL	17-1/2" x 10-7/8" x 12-1/2"	114 lbs
	6 QGH800CL	17-1/2" x 16-1/2" x 12-1/2"	
QSBU-800CL	10 QGH800CL	17-1/2" x 16-1/2" x 12-1/2"	113 lbs
<b>18"W x 42"L x 75"H - 6 Shelf System</b>			
QSBU-700CL	10 QGH700CL	15-1/4" x 19-7/8" x 12-7/16"	123 lbs



**Clear-View Economy 4" Shelf Bins**



Quantum's tough, durable, high density Economy 4" Shelf Bins are the industry standard for quality. These tri-clear virgin-grade polypropylene bins feature a molded-in label holder, built-in rear hanglock which allows bins to tilt out for complete access when on shelving. A wide hopper front allows complete access to the contents of the bin. Edges are reinforced for added strength. They are designed for 12", 18" and 24" deep shelf units, racks or standard shelving. Bins are impervious to most chemicals. Dividers, bin cups and label holders available on **pg. 48**.



**QSB106CL**



**MOBILIZE YOUR WIRE SHELVING**

**DB - Donut Bumper**

Non-marking donut bumper used to protect walls and help cushion impact.

**WR-00H (Mobile Kit)\***

Set of four swivel thermoplastic resin 5" x 1-1/4" casters, two with brakes. 1,200 lb. load capacity. \*Mobile kits recommended only for shelves 18" and deeper.

**QUANTUM IS CLEARLY YOUR STORAGE SOLUTION**

**COMPLETE PACKAGES WITH BINS**



**WR12-107CL**



**WR6-36-1236-109CL**

Available in:  Clear

MODEL NO.	OUTSIDE DIMENSIONS L" x W" x H"	CTN QTY	CTN WGT
<b>QSB100CL</b>	11-5/8" x 2-3/4" x 4"	36	13 lbs
<b>QSB101CL</b>	11-5/8" x 4-1/8" x 4"	36	17 lbs
<b>QSB102CL</b>	11-5/8" x 6-5/8" x 4"	30	18 lbs
<b>QSB107CL</b>	11-5/8" x 8-3/8" x 4"	20	15 lbs
<b>QSB109CL</b>	11-5/8" x 11-1/8" x 4"	8	7 lbs
<b>QSB103CL</b>	17-7/8" x 4-1/8" x 4"	20	13 lbs
<b>QSB104CL</b>	17-7/8" x 6-5/8" x 4"	20	16 lbs
<b>QSB108CL</b>	17-7/8" x 8-3/8" x 4"	10	11 lbs
<b>QSB110CL</b>	17-7/8" x 11-1/8" x 4"	8	11 lbs
<b>QSB105CL</b>	23-5/8" x 4-1/8" x 4"	16	13 lbs
<b>QSB106CL</b>	23-5/8" x 6-5/8" x 4"	8	9 lbs
<b>QSB114CL</b>	23-5/8" x 8-3/8" x 4"	6	9 lbs
<b>QSB116CL</b>	23-5/8" x 11-1/8" x 4"	6	10 lbs



**Clear-View Complete Bin Center**

Complete bin systems are available with 4 different size bin options on a 12"W x 36"L x 36"H unit. This all-purpose bin center is an economical high density storage system that provides superior visibility to stored contents.

Bins available in:  Clear **800 lb. LOAD CAPACITY PER SHELF**

MODEL NO.	NO. OF BINS	BIN DIMENSIONS L" x W" x H"	SHIP WGT
<b>12"W x 36"L x 36"H - 6 Shelf Systems</b>			
<b>WR6-36-1236-101CL</b>	40 QSB101CL	11-5/8" x 4-1/8" x 4"	63 lbs
<b>WR6-36-1236-102CL</b>	25 QSB102CL	11-5/8" x 6-5/8" x 4"	50 lbs
<b>WR6-36-1236-107CL</b>	20 QSB107CL	11-5/8" x 8-3/8" x 4"	62 lbs
<b>WR6-36-1236-109CL</b>	15 QSB109CL	11-5/8" x 11-1/8" x 4"	64 lbs

**Clear-View Economy 4" Shelf Bin Wire Shelving Systems - Complete Packages**

Bins available in:  Clear **800 lb. LOAD CAPACITY PER SHELF**

MODEL NO.	NO. OF BINS	BIN DIMENSIONS L" x W" x H"	SHIP WGT
<b>12"W x 36"L x 74"H - 12 Shelf Systems</b>			
<b>WR12-101CL</b>	88 QSB101CL	11-5/8" x 4-1/8" x 4"	120 lbs
<b>WR12-102CL</b>	55 QSB102CL	11-5/8" x 6-5/8" x 4"	116 lbs
<b>WR12-107CL</b>	44 QSB107CL	11-5/8" x 8-3/8" x 4"	117 lbs
<b>WR12-109CL</b>	33 QSB109CL	11-5/8" x 11-1/8" x 4"	119 lbs
<b>18"W x 36"L x 74"H - 12 Shelf Systems</b>			
<b>WR12-103CL</b>	88 QSB103CL	17-7/8" x 4-1/8" x 4"	176 lbs
<b>WR12-104CL</b>	55 QSB104CL	17-7/8" x 6-5/8" x 4"	165 lbs
<b>WR12-108CL</b>	44 QSB108CL	17-7/8" x 8-3/8" x 4"	170 lbs
<b>WR12-110CL</b>	33 QSB110CL	17-7/8" x 11-1/8" x 4"	168 lbs
<b>24"W x 36"L x 74"H - 12 Shelf Systems</b>			
<b>WR12-105CL</b>	88 QSB105CL	23-5/8" x 4-1/8" x 4"	228 lbs
<b>WR12-106CL</b>	55 QSB106CL	23-5/8" x 6-5/8" x 4"	218 lbs
<b>WR12-114CL</b>	44 QSB114CL	23-5/8" x 8-3/8" x 4"	222 lbs
<b>WR12-116CL</b>	33 QSB116CL	23-5/8" x 11-1/8" x 4"	206 lbs





**QPRHA-100CL** **350 lb.**  
LOAD CAPACITY



**SLOPED SHELVES  
EASY ACCESS**

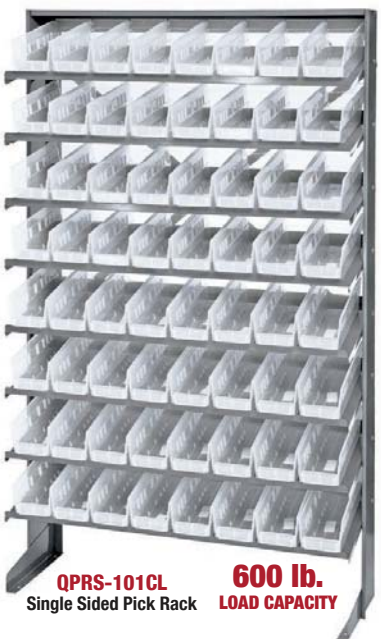

**QPRS-101CL** **600 lb.**  
Single Sided Pick Rack LOAD CAPACITY



**QPRD-109CL** **1,600 lb.**  
Double Sided Pick Rack LOAD CAPACITY

**COMPLETE  
PACKAGES  
WITH BINS**



**1239-107CL**



**1275-102CL**

**Clear-View Economy 4" Shelf Bin Sloped Shelving Systems - Complete Packages**

Pick Racks provide a convenient high density, easy access, sloped shelving system, available as bench units, single and double sided free standing and mobile units. Unit comes complete with Economical Shelf Bins. Sloped shelving unit keeps small and medium sized parts easily accessible. Open hopper front bins with label area, provide fast access to stored items. This all-in-one unit is easy to clean and will not rust or corrode. See chart for configurations. Additional 18" and 36" deep systems available on *pg. 50*. Bins available in Clear.

Bins available in:  Clear

MODEL NO.	NO. OF BINS	BIN DIMENSIONS L" x W" x H"	SHIP WGT
<b>12-1/2"L x 36"W x 23"H - 3 Shelf Bench Rack Systems</b>			
<b>QPRHA-100CL</b>	36 QSB100CL	11-5/8" x 2-3/4" x 4"	41 lbs
<b>QPRHA-101CL</b>	24 QSB101CL	11-5/8" x 4-1/8" x 4"	38 lbs
<b>QPRHA-102CL</b>	15 QSB102CL	11-5/8" x 6-5/8" x 4"	36 lbs
<b>QPRHA-107CL</b>	12 QSB107CL	11-5/8" x 8-3/8" x 4"	36 lbs
<b>QPRHA-109CL</b>	9 QSB109CL	11-5/8" x 11-1/8" x 4"	37 lbs
<b>12"L x 36"W x 60"H - Single Sided 8 Shelf Rack Systems</b>			
<b>QPRS-100CL</b>	96 QSB100CL	11-5/8" x 2-3/4" x 4"	99 lbs
<b>QPRS-101CL</b>	64 QSB101CL	11-5/8" x 4-1/8" x 4"	85 lbs
<b>QPRS-102CL</b>	40 QSB102CL	11-5/8" x 6-5/8" x 4"	80 lbs
<b>QPRS-107CL</b>	32 QSB107CL	11-5/8" x 8-3/8" x 4"	81 lbs
<b>QPRS-109CL</b>	24 QSB109CL	11-5/8" x 11-1/8" x 4"	83 lbs
<b>24"L x 36"W x 60"H - Double Sided 16 Shelf Rack Systems</b>			
<b>QPRD-100CL</b>	192 QSB100CL	11-5/8" x 2-3/4" x 4"	195 lbs
<b>QPRD-101CL</b>	128 QSB101CL	11-5/8" x 4-1/8" x 4"	169 lbs
<b>QPRD-102CL</b>	80 QSB102CL	11-5/8" x 6-5/8" x 4"	158 lbs
<b>QPRD-107CL</b>	64 QSB107CL	11-5/8" x 8-3/8" x 4"	160 lbs
<b>QPRD-109CL</b>	48 QSB109CL	11-5/8" x 11-1/8" x 4"	163 lbs
<b>QDU-00*</b>	Mobile Kit - Mobilizes All Double Sided Systems		25 lbs

\*1,200 lb. load capacity. 2 rigid, 2 swivel with brake hard rubber casters.

**Clear-View Economy 4" Shelf Bin Steel Shelving Systems - Complete Packages**

Bins available in:  Clear **350 lb. LOAD CAPACITY PER SHELF**

MODEL NO.	NO. OF BINS	BIN DIMENSIONS L" x W" x H"	SHIP WGT
<b>12"D x 36"W x 75"H - 13 Shelf Systems</b>			
<b>1275-100CL</b>	144 QSB100CL	11-5/8" x 2-3/4" x 4"	139 lbs
<b>1275-101CL</b>	96 QSB101CL	11-5/8" x 4-1/8" x 4"	117 lbs
<b>1275-102CL</b>	60 QSB102CL	11-5/8" x 6-5/8" x 4"	115 lbs
<b>1275-107CL</b>	48 QSB107CL	11-5/8" x 8-3/8" x 4"	120 lbs
<b>1275-109CL</b>	36 QSB109CL	11-5/8" x 11-1/8" x 4"	119 lbs
<b>12"D x 36"W x 39"H - 7 Shelf Systems</b>			
<b>1239-100CL</b>	72 QSB100CL	11-5/8" x 2-3/4" x 4"	75 lbs
<b>1239-101CL</b>	48 QSB101CL	11-5/8" x 4-1/8" x 4"	67 lbs
<b>1239-102CL</b>	30 QSB102CL	11-5/8" x 6-5/8" x 4"	63 lbs
<b>1239-107CL</b>	24 QSB107CL	11-5/8" x 8-3/8" x 4"	64 lbs
<b>1239-109CL</b>	18 QSB109CL	11-5/8" x 11-1/8" x 4"	65 lbs
<b>18"D x 36"W x 75"H - 13 Shelf Systems</b>			
<b>1875-103CL</b>	96 QSB103CL	17-7/8" x 4-1/8" x 4"	161 lbs
<b>1875-104CL</b>	60 QSB104CL	17-7/8" x 6-5/8" x 4"	155 lbs
<b>1875-108CL</b>	48 QSB108CL	17-7/8" x 8-3/8" x 4"	161 lbs
<b>1875-110CL</b>	36 QSB110CL	17-7/8" x 11-1/8" x 4"	158 lbs
<b>18"D x 36"W x 39"H - 7 Shelf Systems</b>			
<b>1839-103CL</b>	48 QSB103CL	17-7/8" x 4-1/8" x 4"	87 lbs
<b>1839-104CL</b>	30 QSB104CL	17-7/8" x 6-5/8" x 4"	84 lbs
<b>1839-108CL</b>	24 QSB108CL	17-7/8" x 8-3/8" x 4"	87 lbs
<b>1839-110CL</b>	18 QSB110CL	17-7/8" x 11-1/8" x 4"	86 lbs



**Clear-View STORE-MORE 6" Shelf Bins**



Maximize your storage space with durable, high density tri-clear virgin-grade polypropylene bins. Quantum's STORE-MORE 6" Shelf Bins are the industry standard for quality. These bins feature a molded-in label holder, built-in rear hang-lock which allows bins to tilt out for complete access when on shelving. A wide hopper front allows complete access to the contents of the bin. Edges are reinforced for added strength. They are designed for 12", 18" and 24" deep shelf units, racks or standard shelving. Optional dividers are a perfect solution to create a par level system. Bins are waterproof and corrosion-free. Dividers, bin cups and label holders available on *pg. 53*.



**MOBILIZE YOUR WIRE SHELVING**

**DB - Donut Bumper**  
Non-marking donut bumper used to protect walls and help cushion impact.

**WR-00H (Mobile Kit)\***  
Set of four swivel thermoplastic resin 5" x 1-1/4" casters, two with brakes. 1,200 lb. load capacity.  
*\*Mobile kits recommended only for shelves 18" and deeper.*

**QUANTUM IS CLEARLY YOUR STORAGE SOLUTION**

**COMPLETE PACKAGES WITH BINS**



**WR5-39-1236-209CL**

**WR9-202CL**

Available in:  Clear

MODEL NO.	OUTSIDE DIMENSIONS L" x W" x H"	CTN QTY	CTN WGT
<b>QSB201CL</b>	11-5/8" x 4-1/8" x 6"	36	19 lbs
<b>QSB202CL</b>	11-5/8" x 6-5/8" x 6"	30	20 lbs
<b>QSB207CL</b>	11-5/8" x 8-3/8" x 6"	20	17 lbs
<b>QSB209CL</b>	11-5/8" x 11-1/8" x 6"	8	9 lbs
<b>QSB203CL</b>	17-7/8" x 4-1/8" x 6"	20	15 lbs
<b>QSB204CL</b>	17-7/8" x 6-5/8" x 6"	20	18 lbs
<b>QSB208CL</b>	17-7/8" x 8-3/8" x 6"	10	13 lbs
<b>QSB210CL</b>	17-7/8" x 11-1/8" x 6"	8	13 lbs
<b>QSB205CL</b>	23-5/8" x 4-1/8" x 6"	16	15 lbs
<b>QSB206CL</b>	23-5/8" x 6-5/8" x 6"	8	11 lbs
<b>QSB214CL</b>	23-5/8" x 8-3/8" x 6"	6	11 lbs
<b>QSB216CL</b>	23-5/8" x 11-1/8" x 6"	6	12 lbs

68% more storage capacity over standard 4" shelf bins, Quantum's STORE-MORE 6" Shelf Bins were an industry first and now an industry leader.



**Clear-View Complete Bin Center**

Complete bin systems are available with 4 different size bins on a 12"W x 36"L x 39"H unit. This all-purpose bin center is an economical high density storage system that provides easy visibility to stored contents.

Bins available in:  Clear **800 lb. LOAD CAPACITY PER SHELF**

MODEL NO.	NO. OF BINS	BIN DIMENSIONS L" x W" x H"	SHIP WGT
<b>12"W x 36"L x 39"H - 5 Shelf Systems</b>			
<b>WR5-39-1236-201CL</b>	32 QSB201CL	11-5/8" x 4-1/8" x 6"	61 lbs
<b>WR5-39-1236-202CL</b>	20 QSB202CL	11-5/8" x 6-5/8" x 6"	57 lbs
<b>WR5-39-1236-207CL</b>	16 QSB207CL	11-5/8" x 8-3/8" x 6"	56 lbs
<b>WR5-39-1236-209CL</b>	12 QSB209CL	11-5/8" x 11-1/8" x 6"	55 lbs

**Clear-View STORE-MORE 6" Shelf Bin Wire Shelving Systems - Complete Packages**

Bins available in:  Clear **800 lb. LOAD CAPACITY PER SHELF**

MODEL NO.	NO. OF BINS	BIN DIMENSIONS L" x W" x H"	SHIP WGT
<b>12"W x 36"L x 74"H - 9 Shelf Systems</b>			
<b>WR9-201CL</b>	64 QSB201CL	11-5/8" x 4-1/8" x 6"	108 lbs
<b>WR9-202CL</b>	40 QSB202CL	11-5/8" x 6-5/8" x 6"	100 lbs
<b>WR9-207CL</b>	32 QSB207CL	11-5/8" x 8-3/8" x 6"	98 lbs
<b>WR9-209CL</b>	24 QSB209CL	11-5/8" x 11-1/8" x 6"	96 lbs
<b>18"W x 36"L x 74"H - 9 Shelf Systems</b>			
<b>WR9-203CL</b>	64 QSB203CL	17-7/8" x 4-1/8" x 6"	156 lbs
<b>WR9-204CL</b>	40 QSB204CL	17-7/8" x 6-5/8" x 6"	142 lbs
<b>WR9-208CL</b>	32 QSB208CL	17-7/8" x 8-3/8" x 6"	143 lbs
<b>WR9-210CL</b>	24 QSB210CL	17-7/8" x 11-1/8" x 6"	140 lbs
<b>24"W x 36"L x 74"H - 9 Shelf Systems</b>			
<b>WR9-205CL</b>	64 QSB205CL	23-5/8" x 4-1/8" x 6"	182 lbs
<b>WR9-206CL</b>	40 QSB206CL	23-5/8" x 6-5/8" x 6"	171 lbs
<b>WR9-214CL</b>	32 QSB214CL	23-5/8" x 8-3/8" x 6"	165 lbs
<b>WR9-216CL</b>	24 QSB216CL	23-5/8" x 11-1/8" x 6"	154 lbs



## SLOPED SHELVES EASY ACCESS



**QPRHA-201CL**  
**350 lb.**  
LOAD CAPACITY



**QPRS-202CL**  
Single Sided Pick Rack **600 lb.**  
LOAD CAPACITY



**QPRD-209CL**  
Double Sided Pick Rack **1,600 lb.**  
LOAD CAPACITY

## QUANTUM IS CLEARLY YOUR STORAGE SOLUTION



**1239-201CL**



**1275-202CL**

### Clear-View STORE-MORE 6" Shelf Bin Sloped Steel Shelving Systems - Complete Packages

Pick Racks provide a convenient high density, easy access, sloped shelving system, available as bench units, single and double sided free standing and mobile units. Unit comes complete with STORE-MORE 6" Shelf Bins. Sloped shelving unit keeps small and medium sized parts easily accessible. Open hopper front bins with label area, provide fast access to stored items. This all-in-one unit is easy to clean and will not rust or corrode. See chart for configurations. Additional 18" and 36" deep systems available on *pg. 55*. Bins available in Clear.

Bins available in:  Clear

MODEL NO.	NO. OF BINS	BIN DIMENSIONS L" x W" x H"	SHIP WGT
<b>12"L x 36"W x 26-1/2"H - 3 Shelf Bench Rack Systems</b>			
<b>QPRHA-201CL</b>	24 QSB201CL	11-5/8" x 4-1/8" x 6"	40 lbs
<b>QPRHA-202CL</b>	15 QSB202CL	11-5/8" x 6-5/8" x 6"	37 lbs
<b>QPRHA-207CL</b>	12 QSB207CL	11-5/8" x 8-3/8" x 6"	36 lbs
<b>QPRHA-209CL</b>	9 QSB209CL	11-5/8" x 11-1/8" x 6"	35 lbs
<b>12"L x 36"W x 63-1/2"H - Single Sided 8 Shelf Rack Systems</b>			
<b>QPRS-201CL</b>	64 QSB201CL	11-5/8" x 4-1/8" x 6"	89 lbs
<b>QPRS-202CL</b>	40 QSB202CL	11-5/8" x 6-5/8" x 6"	81 lbs
<b>QPRS-207CL</b>	32 QSB207CL	11-5/8" x 8-3/8" x 6"	79 lbs
<b>QPRS-209CL</b>	24 QSB209CL	11-5/8" x 11-1/8" x 6"	77 lbs
<b>24"L x 36"W x 63-1/2"H - Double Sided 16 Shelf Rack Systems</b>			
<b>QPRD-201CL</b>	128 QSB201CL	11-5/8" x 4-1/8" x 6"	178 lbs
<b>QPRD-202CL</b>	80 QSB202CL	11-5/8" x 6-5/8" x 6"	162 lbs
<b>QPRD-207CL</b>	64 QSB207CL	11-5/8" x 8-3/8" x 6"	158 lbs
<b>QPRD-209CL</b>	48 QSB209CL	11-5/8" x 11-1/8" x 6"	154 lbs
<b>QDU-00*</b>	Mobile Kit - Mobilizes All Double Sided Systems		25 lbs

\*1,200 lb. load capacity. 2 rigid, 2 swivel with brake hard rubber casters.

## COMPLETE PACKAGES WITH BINS

### Clear-View STORE-MORE 6" Shelf Bin Steel Shelving Systems - Complete Packages

Bins available in:  Clear **400 lb. LOAD CAPACITY PER SHELF**

MODEL NO.	NO. OF BINS	BIN DIMENSIONS L" x W" x H"	SHIP WGT
<b>12"D x 36"W x 75"H - 10 Shelf Systems</b>			
<b>1275-201CL</b>	72 QSB201CL	11-5/8" x 4-1/8" x 6"	111 lbs
<b>1275-202CL</b>	45 QSB202CL	11-5/8" x 6-5/8" x 6"	103 lbs
<b>1275-207CL</b>	36 QSB207CL	11-5/8" x 8-3/8" x 6"	100 lbs
<b>1275-209CL</b>	27 QSB209CL	11-5/8" x 11-1/8" x 6"	98 lbs
<b>12"D x 36"W x 39"H - 5 Shelf Systems</b>			
<b>1239-201CL</b>	32 QSB201CL	11-5/8" x 4-1/8" x 6"	56 lbs
<b>1239-202CL</b>	20 QSB202CL	11-5/8" x 6-5/8" x 6"	52 lbs
<b>1239-207CL</b>	16 QSB207CL	11-5/8" x 8-3/8" x 6"	51 lbs
<b>1239-209CL</b>	12 QSB209CL	11-5/8" x 11-1/8" x 6"	50 lbs
<b>18"D x 36"W x 75"H - 10 Shelf Systems</b>			
<b>1875-203CL</b>	72 QSB203CL	17-7/8" x 4-1/8" x 6"	156 lbs
<b>1875-204CL</b>	45 QSB204CL	17-7/8" x 6-5/8" x 6"	141 lbs
<b>1875-208CL</b>	36 QSB208CL	17-7/8" x 8-3/8" x 6"	142 lbs
<b>1875-210CL</b>	27 QSB210CL	17-7/8" x 11-1/8" x 6"	139 lbs
<b>18"D x 36"W x 39"H - 5 Shelf Systems</b>			
<b>1839-203CL</b>	32 QSB203CL	17-7/8" x 4-1/8" x 6"	77 lbs
<b>1839-204CL</b>	20 QSB204CL	17-7/8" x 6-5/8" x 6"	70 lbs
<b>1839-208CL</b>	16 QSB208CL	17-7/8" x 8-3/8" x 6"	71 lbs
<b>1839-210CL</b>	12 QSB210CL	17-7/8" x 11-1/8" x 6"	69 lbs

# QUANTUM IS CLEARLY YOUR STORAGE SOLUTION



**LOW COST, LONG LASTING, UNBREAKABLE, REUSABLE, 8" HIGH BINS**

95% more storage capacity when compared to the standard 4" high bins and 65% more than the 6" high bins.



**LTR-1253**  
**Clear Label Holder**  
 Clear label holders and laser label inserts. Clear label holders fit all 8" Shelf Bins. Package of 25.



**DLT-6**

**Divider Label Tab**

Divider Label Tabs attach to existing dividers to improve the visibility of bin labels and scanning of barcodes. Package of 6.

**Clear-View STORE-MAX 8" Shelf Bins**



Our new 8" high bins offer 95% more storage capacity when compared to the standard 4" high bins and 65% more than the 6" high bins. The new STORE-MAX 8" bins will truly maximize and organize your space. Manufactured from high density tri-clear virgin-grade polypropylene, STORE-MAX 8" Shelf Bins are the industry standard for quality. These bins feature a molded-in label holder on a wide hopper front allowing complete access to the contents of the bin. Edges are reinforced for added strength. They are designed for 12", 18" and 24" deep shelf units, racks or standard shelving. Optional dividers are a perfect accessory to subdivide and keep parts separated as needed.

Available in: ● Clear

MODEL NO.	OUTSIDE DIMENSIONS L" x W" x H"	INSIDE DIMENSIONS L" x W" x H"	CTN QTY	CTN WGT	DIVIDER	CTN QTY	NO. OF BIN CUPS PER BIN
							QBC111 QBC112
QSB801CL	11-5/8" x 4-3/8" x 8"	10-1/6" x 3" x 8"	36	19 lbs	DSB801	50	6 2
QSB802CL	11-5/8" x 6-5/8" x 8"	10-1/6" x 5-1/2" x 8"	30	20 lbs	DSB802	50	9 4
QSB807CL	11-5/8" x 8-3/8" x 8"	10-1/6" x 7-1/8" x 8"	20	17 lbs	DSB807	50	12 4
QSB809CL	11-5/8" x 11-1/8" x 8"	10-1/6" x 10" x 8"	8	9 lbs	DSB809	50	18 6
QSB803CL	17-7/8" x 4-3/8" x 8"	16-1/2" x 3" x 8"	20	15 lbs	DSB803	50	9 3
QSB804CL	17-7/8" x 6-5/8" x 8"	16-1/2" x 5-1/2" x 8"	20	18 lbs	DSB804	50	15 6
QSB808CL	17-7/8" x 8-3/8" x 8"	16-1/2" x 7-1/8" x 8"	10	13 lbs	DSB808	50	19 6
QSB810CL	17-7/8" x 11-1/8" x 8"	16-1/2" x 10" x 8"	8	13 lbs	DSB810	50	29 8
QSB805CL	23-5/8" x 4-3/8" x 8"	22-1/8" x 3" x 8"	16	15 lbs	DSB805	50	13 4
QSB806CL	23-5/8" x 6-5/8" x 8"	22-1/8" x 5-1/2" x 8"	8	11 lbs	DSB806	50	21 8
QSB814CL	23-5/8" x 8-3/8" x 8"	22-1/8" x 7-1/8" x 8"	6	11 lbs	DSB814	50	24 8
QSB816CL	23-5/8" x 11-1/8" x 8"	22-1/8" x 10" x 8"	6	12 lbs	DSB816	50	35 16



**Dividers and Bin Cups**

Optional black dividers fit snugly, horizontally across bins to create compartments. Each bin accepts up to 7 dividers.

Bin cups have a raised, slotted label holder for easy parts identification. The entire bin cup may be removed for easy part retrieval. Available in 2 sizes and 2 colors.

Available in: ● Blue ● Yellow

MODEL NO.	OUTSIDE DIMENSIONS L" x W" x H"	CTN QTY	CTN WGT
QBC111	3-1/4" x 1-3/4" x 3"	48	4 lbs
QBC112	5-1/8" x 2-3/4" x 3"	48	7 lbs



## COMPLETE PACKAGES WITH BINS



**CLEAR VIEW**

### MOBILIZE YOUR WIRE SHELVING

#### DB - Donut Bumper

Non-marking donut bumper used to protect walls and help cushion impact.

#### WR-OOH (Mobile Kit)\*

Set of four swivel thermoplastic resin 5" x 1-1/4" casters, two with brakes. 1,200 lb. load capacity.

\*Mobile kits recommended only for shelves 18" and deeper.



WR4-39-1236-802CL

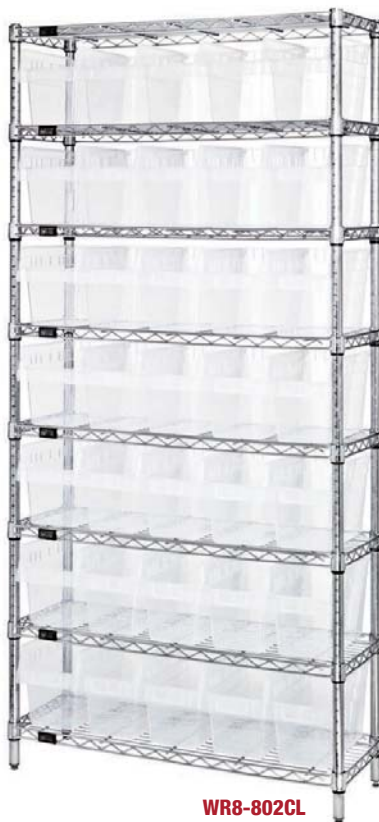

WR8-802CL

## QUANTUM IS CLEARLY YOUR STORAGE SOLUTION



1239-SB807CL

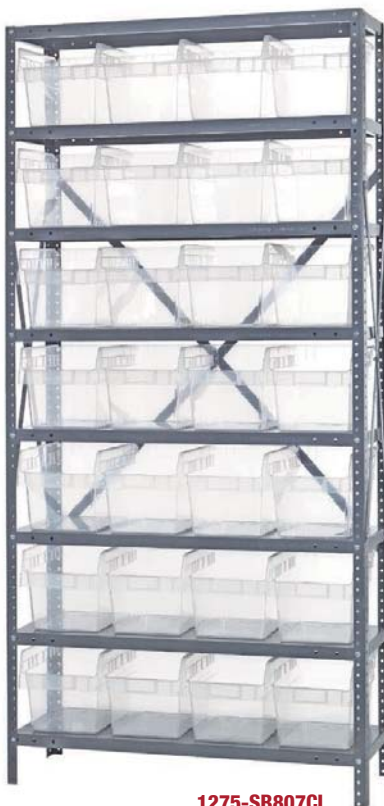

1275-SB807CL

### Clear-View Complete Bin Center

Complete bin systems are available with 4 different size bin options on a 12"W x 36"L x 39"H unit. This all-purpose bin center is an economical high density storage system that provides easy visibility to stored contents. Bins available in Clear.

Bins available in:  Clear **800 lb. LOAD CAPACITY PER SHELF**

MODEL NO.	NO. OF BINS	BIN DIMENSIONS L" x W" x H"	SHIP WGT
<b>12"W x 36"L x 39"H - 4 Shelf Systems</b>			
WR4-39-1236-801CL	24 QSB801CL	11-5/8" x 4-3/8" x 8"	80 lbs
WR4-39-1236-802CL	15 QSB802CL	11-5/8" x 6-5/8" x 8"	78 lbs
WR4-39-1236-807CL	12 QSB807CL	11-5/8" x 8-3/8" x 8"	77 lbs
WR4-39-1236-809CL	9 QSB809CL	11-5/8" x 11-1/8" x 8"	77 lbs

### Clear-View STORE-MAX 8" Shelf Bin Wire Shelving Systems - Complete Packages

Bins available in:  Clear **800 lb. LOAD CAPACITY PER SHELF**

MODEL NO.	NO. OF BINS	BIN DIMENSIONS L" x W" x H"	SHIP WGT
<b>12"W x 36"L x 74"H - 8 Shelf Systems</b>			
WR8-801CL	49 QSB801CL	11-5/8" x 4-3/8" x 8"	100 lbs
WR8-802CL	35 QSB802CL	11-5/8" x 6-5/8" x 8"	103 lbs
WR8-807CL	28 QSB807CL	11-5/8" x 8-3/8" x 8"	102 lbs
WR8-809CL	21 QSB809CL	11-5/8" x 11-1/8" x 8"	101 lbs
<b>18"W x 36"L x 74"H - 8 Shelf Systems</b>			
WR8-803CL	49 QSB803CL	17-7/8" x 4-3/8" x 8"	150 lbs
WR8-804CL	35 QSB804CL	17-7/8" x 6-5/8" x 8"	142 lbs
WR8-808CL	28 QSB808CL	17-7/8" x 8-3/8" x 8"	138 lbs
WR8-810CL	21 QSB810CL	17-7/8" x 11-1/8" x 8"	141 lbs
<b>24"W x 36"L x 74"H - 8 Shelf Systems</b>			
WR8-805CL	49 QSB805CL	23-5/8" x 4-3/8" x 8"	194 lbs
WR8-806CL	35 QSB806CL	23-5/8" x 6-5/8" x 8"	177 lbs
WR8-814CL	28 QSB814CL	23-5/8" x 8-3/8" x 8"	176 lbs
WR8-816CL	21 QSB816CL	23-5/8" x 11-1/8" x 8"	169 lbs

### Clear-View STORE-MAX 8" Shelf Bin Steel Shelving Systems - Complete Packages

Bins available in:  Clear **400 lb. LOAD CAPACITY PER SHELF**

MODEL NO.	NO. OF BINS	BIN DIMENSIONS L" x W" x H"	SHIP WGT
<b>12"D x 36"W x 75"H - 8 Shelf Systems</b>			
1275-SB801CL	56 QSB801CL	11-5/8" x 4-3/8" x 8"	111 lbs
1275-SB802CL	35 QSB802CL	11-5/8" x 6-5/8" x 8"	103 lbs
1275-SB807CL	28 QSB807CL	11-5/8" x 8-3/8" x 8"	100 lbs
1275-SB809CL	21 QSB809CL	11-5/8" x 11-1/8" x 8"	98 lbs
<b>12"D x 36"W x 39"H - 4 Shelf Systems</b>			
1239-SB801CL	24 QSB801CL	11-5/8" x 4-3/8" x 8"	56 lbs
1239-SB802CL	15 QSB802CL	11-5/8" x 6-5/8" x 8"	52 lbs
1239-SB807CL	12 QSB807CL	11-5/8" x 8-3/8" x 8"	51 lbs
1239-SB809CL	9 QSB809CL	11-5/8" x 11-1/8" x 8"	50 lbs
<b>18"D x 36"W x 75"H - 8 Shelf Systems</b>			
1875-SB803CL	56 QSB803CL	17-7/8" x 4-3/8" x 8"	156 lbs
1875-SB804CL	35 QSB804CL	17-7/8" x 6-5/8" x 8"	141 lbs
1875-SB808CL	28 QSB808CL	17-7/8" x 8-3/8" x 8"	142 lbs
1875-SB810CL	21 QSB810CL	17-7/8" x 11-1/8" x 8"	139 lbs
<b>18"D x 36"W x 39"H - 4 Shelf Systems</b>			
1839-SB803CL	24 QSB803CL	17-7/8" x 4-3/8" x 8"	77 lbs
1839-SB804CL	15 QSB804CL	17-7/8" x 6-5/8" x 8"	70 lbs
1839-SB808CL	12 QSB808CL	17-7/8" x 8-3/8" x 8"	71 lbs
1839-SB810CL	9 QSB810CL	17-7/8" x 11-1/8" x 8"	69 lbs



**Genuine stack and nest totes**



**9 SIZES AVAILABLE**



**CLEAR TOTES & LIDS**

These heavy-duty, tough, and dependable stack and nest totes are the ultimate reusable container for storing and transporting your valuable items in any application. These proven containers are available in nine sizes for efficiency and inventory control.

Available in:  Clear

MODEL NO.	OUTSIDE DIMENSIONS L" x W" x H"	A	INSIDE DIMENSIONS				CAPACITY (CU FT)	CTN QTY	CTN WGT	LID	CTN QTY	
		B	C	D	E							
snt180CL	18" x 11" x 6"	10"	16"	15-1/4"	9-3/8"	5-7/8"	0.50	6	12 lbs	LID181CL	6	
snt185CL	18" x 11" x 9"	10"	16"	15-1/8"	9-1/8"	8-7/8"	0.76	6	15 lbs	LID181CL	6	
snt190CL	19-1/2" x 15-1/2" x 10"	14-1/2"	17"	16"	13-1/4"	9-7/8"	1.20	6	23 lbs	LID191CL	6	
snt195CL	19-1/2" x 15-1/2" x 13"	14-1/2"	17"	15-7/8"	13-3/8"	12-7/8"	1.70	6	26 lbs	LID191CL	6	
snt200CL	19-1/2" x 13-1/2" x 8"	12-3/8"	17-7/8"	16-3/8"	11-1/2"	7-7/8"	0.80	6	19 lbs	LID201CL	6	
snt225CL	23-1/2" x 19-1/2" x 10"	18-1/4"	20-7/8"	19-3/8"	16-7/8"	9-7/8"	2.00	3	18 lbs	LID231CL	3	
snt230CL	23-1/2" x 19-1/2" x 13"	18-1/8"	20-7/8"	19-1/2"	16-7/8"	12-7/8"	2.60	3	22 lbs	LID231CL	3	
snt240CL	23-1/2" x 15-1/2" x 12"	14-1/4"	20-7/8"	19-5/8"	13"	11-7/8"	1.70	3	18 lbs	LID241CL	3	
snt300CL	29-1/2" x 19-1/2" x 15"	18-1/4"	26-5/8"	25-1/8"	16-5/8"	14-7/8"	3.70	3	31 lbs	LID301CL	3	
snh010	Clear Label Holder - 3" x 5" (Fits all tote sizes)								6	1 lb	-	-



**COMPLETE PACKAGES WITH BINS**

**PERFORMANCE FEATURES:**

- Available in 9 sizes
- Standard color: Clear
- Totes are injection molded from high-density tri-clear virgin-grade polypropylene material that complies with the USDA and FDA regulations
- stack and nest totes will not corrode, bend out of shape, are unaffected by chemicals and are waterproof
- Reusable container will stack with or without lids for maximum storage and shipping
- snt's have the unique ability to stack or they can be turned 180° to nest when empty saving valuable space
- Optional lids for totes can be secured with nylon ties
- Textured bottoms ensure safe and easy, non-slip grip in transit on conveyors

**QUANTUM IS CLEARLY YOUR STORAGE SOLUTION**

**NEW BIN PACKAGES**

**Genuine stack and nest totes Wire Shelving Systems - Complete Packages**

Offering a generous 600-800 lb. load capacity per shelf, this chrome wire shelving system with totes is a must have for archival storage, heavy-duty parts organization or inventory control applications. With three packages to choose from offering clear-view bins, this system can be used just about anywhere. System may be made mobile with the addition of the WR-00H mobile kit. See pg. 66 for additional information and to order optional accessories.

Bins available in:  Clear

**600-800 lb. LOAD CAPACITY PER SHELF**

MODEL NO.	NO. OF SHELVES	NO. OF BINS	BIN DIMENSIONS L" x W" x H"	SHIP WGT
<b>18"W x 48"L x 74"H - Wire Shelving Systems with stack and nest totes - Totes are available in Clear</b>				
WR9-36180CL	9	36 snt180CL	18" x 11" x 6"	178 lbs
WR6-24185CL	6	24 snt185CL	18" x 11" x 9"	136 lbs
<b>24"W x 66"L x 63"H - Wire Shelving System with stack and nest totes - Totes are available in Clear</b>				
WR4-12225CL	4	12 snt225CL	23-1/2" x 19-1/2" x 10"	170 lbs



WR6-24185CL



**MOBILIZE YOUR WIRE SHELVING**

- DB - Donut Bumper**  
Non-marking donut bumper used to protect walls and help cushion impact.
- WR-00H (Mobile Kit)**  
Set of four swivel thermoplastic resin 5" x 1-1/4" casters, two with brakes. Can be used with all units shown. 1,200 lb. load capacity.



**Clear-View Dividable Grid Containers**



Heavy-duty Dividable Grid Containers can be used for storage, kitting and distribution applications. These containers offer the safest and most efficient method for compartmentalizing and protecting small to medium sized items. Dividers allow you to customize the container's interior to meet your exact needs. Dividers: Gray. Containers and covers are available in Clear.

Available in: ● Clear

MODEL NO.	OUTSIDE DIMENSIONS L" x W" x H"	INSIDE DIMENSIONS L" x W" x H"	CTN QTY	CTN WGT
<b>DG91025CL</b> <small>(NEW)</small>	10-7/8" x 8-1/4" x 2-1/2"	9-3/16" x 6-9/16" x 2"	20	16 lbs
<b>DG91035CL</b>	10-7/8" x 8-1/4" x 3-1/2"	9-3/16" x 6-9/16" x 3"	20	24 lbs
<b>DG91050CL</b>	10-7/8" x 8-1/4" x 5"	9-3/16" x 6-9/16" x 4-1/2"	20	32 lbs
<b>DG92035CL</b>	16-1/2" x 10-7/8" x 3-1/2"	14-7/8" x 9-1/4" x 3"	12	23 lbs
<b>DG92050CL</b> <small>(NEW)</small>	16-1/2" x 10-7/8" x 5"	14-7/8" x 9-1/4" x 4-1/2"	12	25 lbs
<b>DG92060CL</b>	16-1/2" x 10-7/8" x 6"	14-7/8" x 9-1/4" x 5-1/2"	8	20 lbs
<b>DG92080CL</b>	16-1/2" x 10-7/8" x 8"	14-7/8" x 9-1/4" x 7-1/2"	8	27 lbs
<b>DG93030CL</b>	22-1/2" x 17-1/2" x 3"	20-5/8" x 15-5/8" x 2-1/2"	6	20 lbs
<b>DG93060CL</b>	22-1/2" x 17-1/2" x 6"	20-5/8" x 15-5/8" x 5-1/2"	3	16 lbs
<b>DG93080CL</b>	22-1/2" x 17-1/2" x 8"	20-5/8" x 15-5/8" x 7-1/2"	3	19 lbs
<b>DG93120CL</b>	22-1/2" x 17-1/2" x 12"	20-5/8" x 15-5/8" x 11-1/2"	3	23 lbs



**NEW SIZES**



**Clear Dividable Grid Container**  
Shown with optional cover see **pg. 65** (Sold separately)



**Clear Dividable Grid Container**  
Shown with optional dividers see **pg. 65** (Sold separately)



**WR7-92080CL**

**COMPLETE PACKAGES WITH BINS**



**MOBILIZE YOUR WIRE SHELVING**

**DB - Donut Bumper**

Non-marking donut bumper used to protect walls and help cushion impact.

**WR-00H (Mobile Kit)**

Set of four swivel thermoplastic resin 5" x 1-1/4" casters, two with brakes. Can be used with all units shown. 1,200 lb. load capacity.

**Clear-View Dividable Grid Container Wire Shelving Systems - Complete Packages**

Durable chrome wire shelving combined with Quantum's Clear-View Dividable Grid Containers. These containers allow for multiple compartment configurations within each bin. Offering four different packages, these systems are ideal for small, medium and large parts storage. System may be made mobile with the addition of the **WR-00H** mobile kit. See **pg. 65** for additional information and to order optional accessories.

Bins available in: ● Clear

**600-800 lb. LOAD CAPACITY PER SHELF**

MODEL NO.	NO. OF SHELVES	NO. OF BINS	BIN DIMENSIONS L" x W" x H"	SHIP WGT
<b>18"W x 48"L x 74"H - Wire Shelving Systems</b>				
<b>WR9-92060CL</b>	9	36 DG92060CL	16-1/2" x 10-7/8" x 6"	210 lbs
<b>WR7-92080CL</b>	7	24 DG92080CL	16-1/2" x 10-7/8" x 8"	174 lbs
<b>24"W x 60"L x 63"H - Wire Shelving Systems</b>				
<b>WR12-93030CL</b>	12	36 DG93030CL	22-1/2" x 17-1/2" x 3"	274 lbs
<b>24"W x 60"L x 74"H - Wire Shelving Systems</b>				
<b>WR9-93060CL</b>	8	24 DG93060CL	22-1/2" x 17-1/2" x 6"	254 lbs

**Bin Carts**

Modular carts are the ultimate work-in-process and transport cart. Dividable grids slide easily in and out and with their ability to be divided into multiple compartments with long and short dividers, see **pg. 65** for dividers and label holders. Double and Triple Bay Carts are also available, see **pg. 133**. Dividable grids are available in Clear. **Cart Finish:** Chrome

MODEL NO.	NO. OF BINS	BIN DIMENSIONS L" x W" x H"	SHIP WGT
<b>21"W x 24"L x 45"H - Bin Cart with Dividable Grid Containers</b>			
<b>BC212434M1CL</b>	4 DG93060CL	22-1/2" x 17-1/2" x 6"	58 lbs
<b>BC212439M2CL</b>	7 DG93030CL	22-1/2" x 17-1/2" x 3"	79 lbs
<b>21"W x 24"L x 69"H - Bin Cart with Dividable Grid Containers</b>			
<b>BC212469M1CL</b>	7 DG93060CL	22-1/2" x 17-1/2" x 6"	107 lbs
<b>BC212469M2CL</b>	11 DG93030CL	22-1/2" x 17-1/2" x 3"	111 lbs
<b>21"W x 24"L x 45"H - Bin Cart with No Dividable Grid Containers</b>			
<b>BC212439M4</b>	No Containers (Includes slides for 4 bin levels)		46 lbs
<b>BC212439M7</b>	No Containers (Includes slides for 7 bin levels)		55 lbs
<b>21"W x 24"L x 69"H - Bin Cart with No Dividable Grid Containers</b>			
<b>BC212469M</b>	No Containers (Includes slides for 7 bin levels)		63 lbs
<b>BC212469M11</b>	No Containers (Includes slides for 11 bin levels)		75 lbs
<b>One Pair - 24" Wire Bin Slides</b>			
<b>WR-S24W</b>	-	-	3 lbs



**BC212434M1CL**



**Clear Dust Cover Acrylic Inlays**

Clear Acrylic Dust Cover Inlays keep stored items visible while protecting against airborne dust and other contaminants. Cover lays inside on recessed rim of container.

MODEL NO.	FITS BIN MODEL NO.	CTN QTY
<b>DDC91000CL</b>	DG91025CL, DG91035CL, DG91050CL	10
<b>DDC92000CL</b>	DG92035CL, DG92050CL, DG92060CL, DG92080CL	4
<b>DDC93000CL</b>	DG93030CL, DG93060CL, DG93080CL, DG93120CL	3



**10 SIZES AND 5 COLORS AVAILABLE**



**Stackable Shelf Bins**



Quantum's exclusive Stackable Shelf Bins are an industry first and are ideal for medium size and large or heavy item storage. These strong, durable polypropylene bins are available in 4 lengths and 3 widths. 12", 14" and 18" deep bins have a built in rear hanger which allows bin to hang from louvered panels and rails. Bins have a raised front opening when compared to any like product allowing you to truly maximize the complete bin's storage capacity. Optional cross dividers allow flexibility and keep parts organized. Waterproof bins resist rust and corrosion. Large molded in front label slots for ID labels. Autoclavable up to 250°F and resistant to extreme cold.

Available in: ● Blue ● Gray ● Ivory ● Black ● Orange

MODEL NO.	OUTSIDE DIMENSIONS L" x W" x H"	INSIDE DIMENSIONS L" x W" x H"	X"	CTN QTY	CTN WGT	DIVIDER	CTN QTY	CTN WGT	CLEAR LABEL HOLDER & INSERT
SSB423	12" x 8-1/4" x 7"	11-1/2" x 7-3/8" x 6-1/2"	7-1/2"	6	9 lbs	DSS403	6	1 lb	LTR-2400
SSB425	12" x 11" x 7"	11-1/2" x 10-1/8" x 6-1/2"	7-1/2"	6	11 lbs	DSS405	6	2 lbs	LTR-2400
SSB441	14" x 6" x 7"	13-1/2" x 5-3/8" x 6-1/2"	9-3/8"	6	8 lbs	DSS401	6	1 lb	LTR-2400
SSB443	14" x 8-1/4" x 7"	13-1/2" x 7-3/8" x 6-1/2"	9-3/8"	12	18 lbs	DSS403	6	1 lb	LTR-2400
SSB445	14" x 11" x 7"	13-1/2" x 10-1/8" x 6-1/2"	9-3/8"	6	12 lbs	DSS405	6	2 lbs	LTR-2400
SSB461	18" x 6" x 7"	17-1/2" x 5-3/8" x 6-1/2"	13-1/2"	6	11 lbs	DSS401	6	1 lb	LTR-2400
SSB463	18" x 8-1/4" x 7"	17-1/2" x 7-3/8" x 6-1/2"	13-3/8"	6	12 lbs	DSS403	6	1 lb	LTR-2400
SSB465	18" x 11" x 7"	17-1/2" x 10-1/8" x 6-1/2"	13-3/8"	6	15 lbs	DSS405	6	2 lbs	LTR-2400
SSB483*	20-1/2" x 8-1/4" x 7"	20" x 7-3/8" x 6-1/2"	15-7/8"	6	14 lbs	DSS403	6	1 lb	LTR-2400
SSB485*	20-1/2" x 11" x 7"	20" x 10-1/8" x 6-1/2"	15-7/8"	6	17 lbs	DSS405	6	2 lbs	LTR-2400

\*Do not have rear hanger



**STACKABLE SHELF BIN**  
Shown with optional Divider and DLT-6 Divider Label Tabs attach to existing dividers to improve the visibility of bin labels and scanning of barcodes. Package of 6. (Dividers and Label Tabs sold separately)

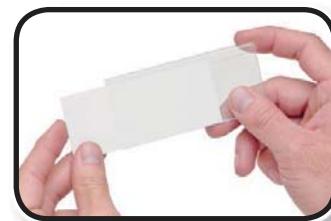

**LTR-2400**  
Clear Label Holder and Insert  
Package of 25.

**PERFORMANCE FEATURES:**

- Available in 10 sizes
- Standard colors: Blue, Gray, Ivory, Black and Orange (additional colors available on request, subject to upcharge and minimum runs)
- Bins are made from heavy-duty, virgin, high density FDA approved polypropylene
- Large label slot provide easy label insertion and parts identification
- Extra wide stacking ledge assures stability for high stacking
- Reinforced design adds strength and prevents spreading
- Will not rust or corrode, unaffected by weak acids and alkalis, and are waterproof
- Autoclavable up to 250°F

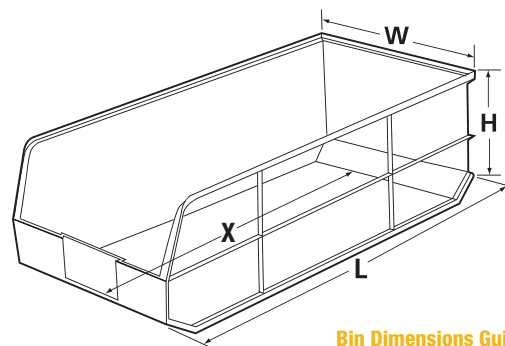

**Bin Dimensions Guide**  
L (length) W (width) H (height)  
X (inside length)





**2475-485**  
24"D x 36"W x 75"H  
8 shelves and 21 SSB485  
20-1/2"L x 11"W x 7"H bins

**Stackable Shelf Bin Steel Shelving Systems**  
- Complete Packages

Bins available in: ● Blue ● Gray ● Ivory ● Black ● Orange

(One color per unit)

MODEL NO.	OUTSIDE DIMENSIONS D" x W" x H"	NO. OF SHELVES	NO. OF BINS	BIN DIMENSIONS L" x W" x H"	SHIP WGT
<b>1275-423</b>	12" x 36" x 75"	8	28 SSB423	12" x 8-1/4" x 7"	129 lbs
<b>1275-425</b>	12" x 36" x 75"	8	21 SSB425	12" x 11" x 7"	126 lbs
<b>1275-441</b>	12" x 36" x 75"	8	35 SSB441	14" x 6" x 7"	134 lbs
<b>1275-443</b>	12" x 36" x 75"	8	28 SSB443	14" x 8-1/4" x 7"	129 lbs
<b>1275-445</b>	12" x 36" x 75"	8	21 SSB445	14" x 11" x 7"	129 lbs
<b>1875-461</b>	18" x 36" x 75"	8	35 SSB461	18" x 6" x 7"	173 lbs
<b>1875-463</b>	18" x 36" x 75"	8	28 SSB463	18" x 8-1/4" x 7"	165 lbs
<b>1875-465</b>	18" x 36" x 75"	8	21 SSB465	18" x 11" x 7"	165 lbs
<b>2475-483</b>	24" x 36" x 75"	8	28 SSB483	20-1/2" x 8-1/4" x 7"	197 lbs
<b>2475-483485</b>	24" x 36" x 75"	8	12 SSB483 12 SSB485	20-1/2" x 8-1/4" x 7" 20-1/2" x 11" x 7"	195 lbs
<b>2475-485</b>	24" x 36" x 75"	8	21 SSB485	20-1/2" x 11" x 7"	194 lbs

**400 lb.**  
LOAD CAPACITY  
PER SHELF

**COMPLETE PACKAGES WITH BINS**



**MOBILIZE YOUR WIRE SHELVING**

**DB - Donut Bumper**  
Non-marking donut bumper used to protect walls and help cushion impact.

**WR-00H (Mobile Kit)\***  
Set of four swivel thermoplastic resin 5" x 1-1/4" casters, two with brakes. 1,200 lb. load capacity.  
\*Mobile kits recommended only for shelves 18" and deeper.



**WR8-463**  
18"W x 36"L x 74"H  
8 shelves and 28 SSB463  
18"L x 8-1/4"W x 7"H bins



**Stackable Shelf Bin Wire Shelving Systems**  
- Complete Packages

Bins available in: ● Blue ● Gray ● Ivory ● Black ● Orange

(One color per unit)

MODEL NO.	OUTSIDE DIMENSIONS W" x L" x H"	NO. OF SHELVES	NO. OF BINS	BIN DIMENSIONS L" x W" x H"	SHIP WGT
<b>WR8-423</b>	12" x 36" x 74"	8	28 SSB423	12" x 8-1/4" x 7"	114 lbs
<b>WR8-425</b>	12" x 36" x 74"	8	21 SSB425	12" x 11" x 7"	107 lbs
<b>WR8-441</b>	14" x 36" x 74"	8	35 SSB441	14" x 6" x 7"	136 lbs
<b>WR8-443</b>	14" x 36" x 74"	8	28 SSB443	14" x 8-1/4" x 7"	129 lbs
<b>WR8-445</b>	14" x 36" x 74"	8	21 SSB445	14" x 11" x 7"	122 lbs
<b>WR8-461</b>	18" x 36" x 74"	8	35 SSB461	18" x 6" x 7"	190 lbs
<b>WR8-463</b>	18" x 36" x 74"	8	28 SSB463	18" x 8-1/4" x 7"	180 lbs
<b>WR8-465</b>	18" x 36" x 74"	8	21 SSB465	18" x 11" x 7"	184 lbs
<b>WR8-483</b>	21" x 36" x 74"	8	28 SSB483	20-1/2" x 8-1/4" x 7"	198 lbs
<b>WR8-483485</b>	21" x 36" x 74"	8	12 SSB483 12 SSB485	20-1/2" x 8-1/4" x 7" 20-1/2" x 11" x 7"	199 lbs
<b>WR8-485</b>	21" x 36" x 74"	8	21 SSB485	20-1/2" x 11" x 7"	198 lbs



# HULK containers

10 SIZES AND 4 COLORS AVAILABLE

**CLEARVIEW**  
BINS

AVAILABLE on pg. 22



QUS952

QUS951

QUS954

QUS955

QUS953

QUS950

**NEW**  
SIZE



QUS957

Shown with optional cross divider

AL-23

2" x 3-1/2"  
Adhesive clear label holder and inserts.  
Package of 24  
(Sold separately)



QUS953

Shown with optional divider, window front, adhesive label holder and insert

**REAR LARGE HANDLE**  
Molded onto back of containers makes them easy to carry!



**POLYMER DOLLY**

DLY-3018 Dolly with padded rubber trim, available in Blue. Dimensions 30"L x 18"W. Set of four 4" x 1-1/4" non-marking swivel poly casters, 1,000 lb. load capacity. (Bin sold separately)

**ATTACHED PULL RING**  
allows dolly to be pulled with ease



**MOBILE HULK CONTAINER**

Ideal for transport of heavy and bulky parts. Bin comes with 4 swivel, 3" polyurethane casters, all with brakes, allowing up to 250 lb. mobile load capacity

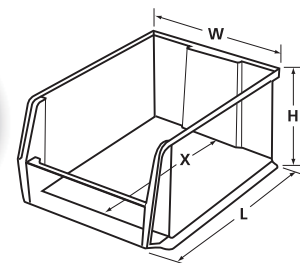

**Bin Dimensions Guide**

L (length) W (width)  
H (height) X (inside length)

HULK 24" Containers



Organize and store your large and bulky items with these strong injection molded polypropylene, stackable containers. These extra large stacking containers offer a generous 2 feet in length to store your larger items. These huge stack bins are ideal for heavy-duty, extra deep shelving and are available in a variety of widths and heights. Heavy-duty front, back and side grips allow for easy handling. Optional clear styrene plastic window increases bin capacity and provides a quick view of the bin contents. Optional dividers maximize flexibility and keep contents organized. Wide stacking ledge and anti-slide lock keep stacked bins steady and prevent forward shifting. Waterproof bins are corrosion free. Bins are autoclavable up to 250°F and are resistant to extreme cold. See **pg. 22** to order Clear bins.

Available in: ● Blue ● Red ● Yellow ● Clear

MODEL NO.	OUTSIDE DIMENSIONS L" x W" x H"	INSIDE DIMENSIONS L" x W" x H"	X"	CTN QTY	CTN WGT	CLEAR WINDOW	CTN QTY	DIVIDER & CROSS DIVIDER	CTN QTY	CLEAR LABEL HOLDER & INSERT	CTN QTY
QUS950	23-7/8" x 8-1/4" x 7"	21-7/8" x 6-1/4" x 6-5/8"	19"	6	18 lbs	WUS950/970	6	DUS950	6	-	-
QUS951	23-7/8" x 8-1/4" x 9"	21-7/8" x 6-1/4" x 8-3/4"	18-3/4"	6	21 lbs	WUS951	6	DUS951	6	-	-
QUS952	23-7/8" x 11" x 7"	21-7/8" x 9" x 6-7/8"	19"	4	14 lbs	WUS952	4	DUS952	4	-	-
QUS953	23-7/8" x 11" x 10"	21-1/2" x 8-7/8" x 9-3/4"	18-3/4"	4	18 lbs	WUS953/973	4	DUS953	4	-	-
QUS954	23-7/8" x 16-1/2" x 11"	21-7/8" x 14-1/4" x 10-3/4"	18-3/4"	1	7 lbs	WUS954/974	1	DUS954	1	AL-23	24
QUS964MOB*	23-7/8" x 16-1/2" x 11"	21-7/8" x 14-1/4" x 10-3/4"	18-3/4"	1	9 lbs	WUS954/974	1	DUS954	1	AL-23	24
QUS955	23-7/8" x 18-1/4" x 12"	21-1/2" x 16" x 11-3/4"	17-3/4"	1	8 lbs	WUS955/975	1	DUS955	1	AL-23	24
QUS965MOB*	23-7/8" x 18-1/4" x 12"	21-1/2" x 16" x 11-3/4"	17-3/4"	1	10 lbs	WUS955/975	1	DUS955	1	AL-23	24
QUS957	<b>NEW</b> 23-7/8" x 22-1/2" x 12"	21-1/8" x 20-1/2" x 11-3/8"	18"	1	8 lbs	WUS957	1	DUS957 CRDUS957	1	AL-23	24
QUS967MOB*	<b>NEW</b> 23-7/8" x 22-1/2" x 12"	21-1/8" x 20-1/2" x 11-3/8"	18"	1	10 lbs	WUS957	1	DUS957 CRDUS957	1	AL-23	24

\*With caster, overall height for mobile container will be increased by 3"



# 350 lb. LOAD CAPACITY PER SHELF

## HULK 24" Container Steel Shelving Systems - Complete Packages



**2475-950**  
24"D x 36"W x 75"H  
8 shelves and 28 QUS950  
23-7/8"L x 8-1/4"W x 7"H bins



**2475-951**  
24"D x 36"W x 75"H  
7 shelves and 24 QUS951  
23-7/8"L x 8-1/4"W x 9"H bins



**2475-952**  
24"D x 36"W x 75"H  
8 shelves and 21 QUS952  
23-7/8"L x 11"W x 7"H bins



**2475-953**  
24"D x 36"W x 75"H  
6 shelves and 15 QUS953  
23-7/8"L x 11"W x 10"H bins



**2475-954**  
24"D x 36"W x 75"H  
6 shelves and 10 QUS954  
23-7/8"L x 16-1/2"W x 11"H bins



**2475-950952**  
24"D x 36"W x 75"H  
8 shelves and 12 QUS950  
23-7/8"L x 8-1/4"W x 7"H bins  
and 12 QUS952  
23-7/8"L x 11"W x 7"H bins



**2475-953954**  
24"D x 36"W x 75"H  
6 shelves and 9 QUS953  
23-7/8"L x 11"W x 10"H bins  
and 4 QUS954  
23-7/8"L x 16-1/2"W x 11"H bins



**2475-20-MIX**  
24"D x 36"W x 75"H  
7 shelves and 8 QUS950  
23-7/8"L x 8-1/4"W x 7"H bins  
and 3 QUS952  
23-7/8"L x 11"W x 7"H bins  
and 4 QUS951  
23-7/8"L x 8-1/4"W x 9"H bins  
and 3 QUS953  
23-7/8"L x 11"W x 10"H bins  
and 2 QUS954  
23-7/8"L x 16-1/2"W x 11"H bins

**CLEAR VIEW**  
AVAILABLE on pg. 22

### COMPLETE PACKAGES WITH BINS

### HULK containers

Bins available in: ● Blue ● Red ● Yellow ● Clear (One color per unit)

**HULK 24" Container Wire Shelving Systems - Complete Packages**

**800 lb. LOAD CAPACITY PER SHELF**



**WR8-950**  
24"W x 36"L x 74"H  
8 shelves and 28 QUS950  
23-7/8"L x 8-1/4"W x 7"H bins



**WR7-951**  
24"W x 36"L x 74"H  
7 shelves and 24 QUS951  
23-7/8"L x 8-1/4"W x 9"H bins



**WR8-952**  
24"W x 36"L x 74"H  
8 shelves and 21 QUS952  
23-7/8"L x 11"W x 7"H bins



**WR6-953**  
24"W x 36"L x 74"H  
6 shelves and 15 QUS953  
23-7/8"L x 11"W x 10"H bins



**WR6-954**  
24"W x 36"L x 74"H  
6 shelves and 10 QUS954  
23-7/8"L x 16-1/2"W x 11"H bins



**WR5-955**  
24"W x 42"L x 74"H  
5 shelves and 8 QUS955  
23-7/8"L x 18-1/4"W x 12"H bins



**NEW**  
**WR6-957**  
24"W x 48"L x 74"H  
6 shelves and 10 QUS957  
23-7/8"L x 22-1/2"W x 12"H bins



**WR7-20-MIX**  
24"W x 36"L x 74"H  
7 shelves and 8 QUS950  
23-7/8"L x 8-1/4"W x 7"H bins  
and 3 QUS952  
23-7/8"L x 11"W x 7"H bins  
and 4 QUS951  
23-7/8"L x 8-1/4"W x 9"H bins  
and 3 QUS953  
23-7/8"L x 11"W x 10"H bins  
and 2 QUS954 bins  
23-7/8"L x 16-1/2"W x 11"H bins



**MOBILIZE YOUR WIRE SHELVING**

**DB - Donut Bumper**  
Non-marking donut bumper used to protect walls and help cushion impact.

**WR-00H (Mobile Kit)**  
Set of four swivel thermoplastic resin 5" x 1-1/4" casters, two with brakes. Can be used with all units shown. 1,200 lb. load capacity.

**CLEARVIEW**  
AVAILABLE on pg. 22

**HULK**  
containers

Bins available in: ● Blue ● Red ● Yellow ● Clear (One color per unit)



# 14 SIZES AND 3 COLORS AVAILABLE

## 150 lb. STACK CAPACITY PER BINS

## HEAVY-DUTY

# HULK containers

QUS970



29-7/8" L

QUS973



QUS974

QUS976

QUS975



**ADHESIVE CLEAR LABEL HOLDER AND INSERTS**

**AL-23**

2" x 3-1/2"

(Fits bins 12"H and shorter)

**AL-35**

3" x 5"

(Fits bins 15"H and taller)

Package of 24

(Sold separately)



LABEL  
3" x 5"

35-7/8" L

**REAR LARGE HANDLE**

Molded onto back of containers makes them easy to carry!



**CLEAR PLASTIC WINDOW FRONT**

Increases bin capacity and provides a quick view of the bin contents. (Sold separately)

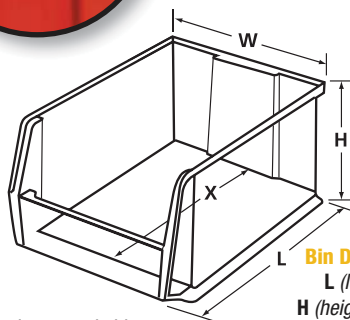

**Bin Dimensions Guide**

L (length) W (width)

H (height) X (inside length)

### HULK 30" & 36" Containers



QUS997

Organize and store your large and bulky items with these strong injection molded high impact polypropylene, stackable containers. These extra large stacking containers offer a generous 2-1/2 - 3 feet in length to store your larger items. These huge stack bins are ideal for heavy-duty, extra deep shelving and are available in a variety of widths and heights. Heavy-duty front, back and side grips allow for easy handling. Wide stacking ledge and anti-slide lock keep stacked bins steady and prevent forward shifting. Waterproof bins are corrosion-free. Bins are autoclavable up to 250°F and are resistant to extreme cold.

Available in: ● Blue ● Red ● Yellow

MODEL NO.	OUTSIDE DIMENSIONS L" x W" x H"	INSIDE DIMENSIONS L" x W" x H"	X"	CTN QTY	CTN WGT	CLEAR WINDOW	CTN QTY DIVIDER	CTN QTY
<b>HULK 30" Containers</b>								
QUS970	29-7/8" x 8-1/4" x 7"	27-7/8" x 6-1/4" x 6-3/4"	25"	6	23 lbs	WUS950/970	6	DUS970 6
QUS973	29-7/8" x 11" x 10"	27-7/8" x 8-7/8" x 9-5/8"	24-3/4"	4	22 lbs	WUS953/973	4	DUS973 4
QUS974	29-7/8" x 16-1/2" x 11"	27-5/8" x 14-1/4" x 10-5/8"	24-3/4"	1	8 lbs	WUS954/974	1	DUS974 1
QUS984MOB	29-7/8" x 16-1/2" x 11"	27-5/8" x 14-1/4" x 10-5/8"	24-3/4"	1	10 lbs	WUS954/974	1	DUS974 1
QUS975	29-7/8" x 18-1/4" x 12"	27-1/2" x 16" x 11-3/4"	23-3/4"	1	9 lbs	WUS955/975	1	DUS975 1
QUS985MOB	29-7/8" x 18-1/4" x 12"	27-1/2" x 16" x 11-3/4"	23-3/4"	1	11 lbs	WUS955/975	1	DUS975 1
QUS976	29-7/8" x 16-1/2" x 15"	27-3/8" x 14" x 14-3/4"	23-1/2"	1	10 lbs	WUS976	1	DUS976 1
QUS986MOB	29-7/8" x 16-1/2" x 15"	27-3/8" x 14" x 14-3/4"	23-1/2"	1	12 lbs	WUS976	1	DUS976 1
<b>HULK 36" Containers</b>								
QUS993	35-7/8" x 16-1/2" x 17-1/2"	33-1/8" x 14" x 17-1/4"	28-1/4"	1	14 lbs	-	-	DUS993 1
QUS994MOB	35-7/8" x 16-1/2" x 17-1/2"	33-1/8" x 14" x 17-1/4"	28-1/4"	1	16 lbs	-	-	DUS993 1
QUS995	35-7/8" x 19-7/8" x 17-1/2"	33-1/8" x 17-3/8" x 17-1/4"	28-1/4"	1	15 lbs	-	-	DUS995 1
QUS996MOB	35-7/8" x 19-7/8" x 17-1/2"	33-1/8" x 17-3/8" x 17-1/4"	28-1/4"	1	17 lbs	-	-	DUS995 1
QUS997	35-7/8" x 23-7/8" x 17-1/2"	33-1/4" x 21-3/8" x 17-1/4"	28-1/4"	1	18 lbs	-	-	DUS997 1
QUS998MOB	35-7/8" x 23-7/8" x 17-1/2"	33-1/4" x 21-3/8" x 17-1/4"	28-1/4"	1	20 lbs	-	-	DUS997 1

\*With caster, overall height for mobile container will be increased by 3"



**HULK 30" Container Wire Shelving Systems - Complete Packages**

**700 lb. LOAD CAPACITY PER SHELF**



**WR8-970**  
 30"W x 36"L x 74"H  
**8 shelves and 28 QUS970**  
 29-7/8"L x 8-1/4"W x 7"H bins



**WR6-973**  
 30"W x 36"L x 74"H  
**6 shelves and 15 QUS973**  
 29-7/8"L x 11"W x 10"H bins



**WR6-974**  
 30"W x 36"L x 74"H  
**6 shelves and 10 QUS974**  
 29-7/8"L x 16-1/2"W x 11"H bins



**WR6-973974**  
 30"W x 36"L x 74"H  
**6 shelves and 9 QUS973**  
 29-7/8"L x 11"W x 10"H bins  
**and 4 QUS974**  
 29-7/8"L x 16-1/2"W x 11"H bins

**HULK**  
 containers

**QUANTUM CHROME  
 WIRE SHELVING  
 SYSTEMS COMPLETE  
 WITH BINS**



**MOBILIZE YOUR WIRE SHELVING**

**DB - Donut Bumper**  
 Non-marking donut bumper used to protect walls and help cushion impact.

**WR-00H (Mobile Kit)**  
 Set of four swivel thermoplastic resin 5" x 1-1/4" casters, two with brakes. Can be used with all units shown. 1,200 lb. load capacity.



**WR5-975**  
 30"W x 42"L x 74"H  
**5 shelves and 8 QUS975**  
 29-7/8"L x 18-1/4"W x 12"H bins

Bins available in: ● Blue ● Red ● Yellow (One color per unit)



HULK 36" Container Wire Shelving Systems - Complete Packages



**WR5-993**  
36"W x 36"L x 86"H  
5 shelves and 8 QUS993  
35-7/8"L x 16-1/2"W x 17-1/2"H bins

**HULK**  
containers

ON  
**SHELVING**

**SIZE**  
DOES MATTER



**WR5-995**  
36"W x 48"L x 86"H  
5 shelves and 8 QUS995  
35-7/8"L x 19-7/8"W x 17-1/2"H bins

**600 lb.**  
LOAD CAPACITY  
PER SHELF



**MOBILIZE YOUR WIRE SHELVING**

**DB - Donut Bumper**

Non-marking donut bumper used to protect walls and help cushion impact.

**WR-00H (Mobile Kit)**

Set of four swivel thermoplastic resin 5" x 1-1/4" casters, two with brakes. Can be used with all units shown. 1,200 lb. load capacity.



**WR5-997**  
36"W x 60"L x 86"H  
5 shelves and 8 QUS997  
35-7/8"L x 23-7/8"W x 17-1/2"H bins

**QUANTUM CHROME**  
WIRE SHELVING  
SYSTEMS COMPLETE  
WITH BINS

Bins available in: ● Blue ● Red ● Yellow (One color per unit)



**RackBin 42" Containers**



- These extra large bins offer a generous 42" (3-1/2 Feet) in length to store your larger items
- 42" length ensures no wasted space on 42" deep pallet rack
- Heavy-duty front, back and side grips allow for easy handling
- Wide stacking ledge and anti-slide lock keep stack bins steady and prevent forward shifting
- Have eight 1/4" drill hole pattern on bottom of bin for easy hole insertion for drainage and air circulation if needed
- Waterproof bins are corrosion free

**180 lb.**  
**STACK CAPACITY PER BIN**

Available in: ● Blue ● Gray

MODEL NO.	OUTSIDE DIMENSIONS L" x W" x H"	INSIDE DIMENSIONS L" x W" x H"	X"	CTN QTY	CTN WGT
QRB166	41-7/8" x 16-1/2" x 17-1/2"	40-1/8" x 14" x 16-1/2"	35"	1	16 lbs
QRB176MOB	41-7/8" x 16-1/2" x 17-1/2"	40-1/8" x 14" x 16-1/2"	35"	1	18 lbs
QRB206	41-7/8" x 19-7/8" x 17-1/2"	40-1/8" x 17-3/8" x 16-1/2"	35"	1	17 lbs
QRB216MOB	41-7/8" x 19-7/8" x 17-1/2"	40-1/8" x 17-3/8" x 16-1/2"	35"	1	19 lbs
QRB246	41-7/8" x 23-7/8" x 17-1/2"	40-1/8" x 21-1/2" x 16-1/2"	35"	1	19 lbs
QRB256MOB	41-7/8" x 23-7/8" x 17-1/2"	40-1/8" x 21-1/2" x 16-1/2"	35"	1	21 lbs

\*With caster, overall height for mobile container will be increased by 3"

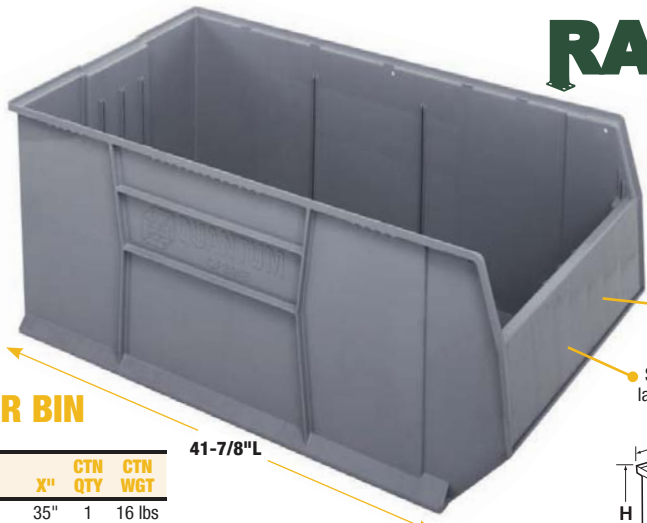

41-7/8"L



**RACKBIN**<sup>42"</sup>



**AL-35**  
3" x 5"  
Adhesive clear label holder and inserts. Package of 24 (Sold separately)  
Smooth label area

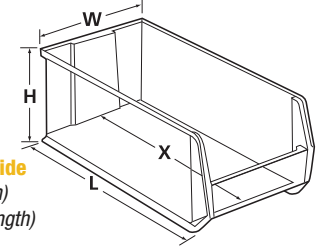

**Bin Dimensions Guide**  
L (length) W (width)  
H (height) X (inside length)

**3 SIZES AND 2 COLORS AVAILABLE**

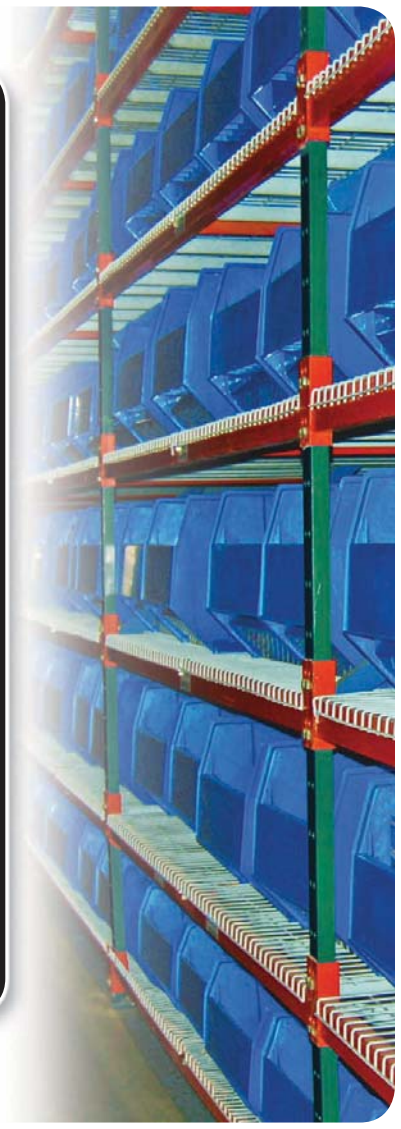

**THE FIRST AND ONLY BIN DESIGNED SPECIFICALLY TO FIT PALLET RACK**





RackBin 42" Container Wire Shelving Systems - Complete Packages



WRA86-2142C-206



WRA86-2136C-166



COMPLETE PACKAGES WITH BINS

Bins available in: ● Blue ● Gray (One color per unit)

MODEL NO.	DIMENSIONS W" x L" x H"	NO. OF CONTAINERS	CONTAINER SIZE L" x W" x H"	SHIP WGT
WRA86-2136C-166	42" x 36" x 86"	8 QRB166	41-7/8" x 16-1/2" x 17-1/2"	272 lbs
WRA86-2142C-206	42" x 42" x 86"	8 QRB206	41-7/8" x 19-7/8" x 17-1/2"	290 lbs
WRA86-2154C-166	42" x 54" x 86"	12 QRB166	41-7/8" x 16-1/2" x 17-1/2"	386 lbs



**5 SIZES AND 6 COLORS AVAILABLE**

**CLEAR VIEW**  
AVAILABLE on pg. 23



**AL-23**  
2" x 3-1/2"  
Adhesive clear label holder and inserts.  
Package of 24 (Sold separately)



Curved lip and corners provide added strength

Large label holder allows for quick part identification  
**LTR-700**  
Clear label holders and laser label inserts slide into front label slot of all bins. (Sold in packages of 25)



Smooth label area

Large and comfortable side grip handles allow for easy carrying and handling

**150 lb. STACK CAPACITY PER BIN**

Ribs on side of bin provide added stability when stacked

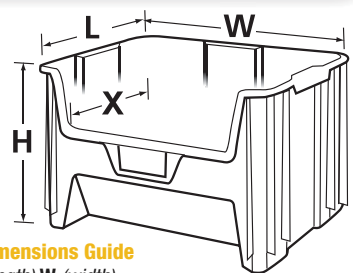

**Bin Dimensions Guide**  
L (length) W (width)  
H (height) X (inside length)

**Giant Stack Containers**



Multipurpose, wide open hopper front provides easy access for large part storage. Ideal for multiple applications in recycling, storing parts and components. This bin will stack up to 6 bins high creating a sturdy, tall storage system. Bins are injection molded from high density polypropylene, easy to clean, resist corrosion and are impervious to most chemicals. Large label holder allows for quick identification. Optional clear window front increases storage capacity and allows for quick identification of parts. Six 1/4" drill hole pattern on bottom of bin allow for easy hole insertion for drainage and air circulation. See **pg. 23** to order Clear Bins.

**QGH700 available in:** ● Blue ● Ivory ● Red ● Black ● Gray ● Clear  
**QGH600 and QGH800 available in:** ● Blue ● Red ● Gray ● Clear

MODEL NO.	OUTSIDE DIMENSIONS L" x W" x H"	INSIDE DIMENSIONS L" x W" x H"	X"	CAP CU FT	CTN QTY	CTN WGT	WINDOW	CTN QTY
<b>QGH600</b>	17-1/2" x 10-7/8" x 12-1/2"	15-5/8" x 8" x 12-1/4"	13-1/2"	0.98	4	12 lbs	<b>WGH600</b>	4
<b>QGH700*</b>	15-1/4" x 19-7/8" x 12-7/16"	13-5/8" x 17-1/2" x 12-1/4"	11-1/2"	1.7	3	13 lbs	<b>WGH700</b>	3
<b>QGH800</b>	17-1/2" x 16-1/2" x 12-1/2"	15-5/8" x 13-3/4" x 12-1/4"	13-1/2"	1.6	2	8 lbs	<b>WGH800</b>	2

\*Optional label for QGH700 is available, LGH700 (3 per package)

**PERFORMANCE FEATURES:**

- Extra thick side walls with reinforced ribs designed for strength, allowing for 150 lb. stack capacity per bin
- Large side grip handles
- Stacks 6 bins high
- Six 1/4" drill hole pattern on bottom of bin allows for easy hole insertion for drainage

**Mobile Giant Stack Containers**



- Ideal for transport of heavy and bulky parts
- Container comes with 4 swivel, 3" polyurethane casters, all with brakes, allowing for up to 250 lb. mobile load capacity
- Containers can stack with casters in place

**QGH705MOB available in:** ● Blue ● Ivory ● Red ● Black ● Gray ● Clear  
**QGH805MOB available in:** ● Blue ● Red ● Gray ● Clear

MODEL NO.	OUTSIDE DIMENSIONS L" x W" x H"	INSIDE DIMENSIONS L" x W" x H"	X"	CAP CU FT	CTN QTY	CTN WGT	WINDOW	CTN QTY
<b>QGH705MOB</b>	15-1/4" x 19-7/8" x 12-7/16"	13-5/8" x 17-1/2" x 12-1/4"	11-1/2"	1.7	3	22 lbs	<b>WGH700</b>	3
<b>QGH805MOB</b>	17-1/2" x 16-1/2" x 12-1/2"	15-5/8" x 13-3/4" x 12-1/4"	13-1/2"	1.6	2	17 lbs	<b>WGH800</b>	2

\*With caster, overall height for mobile container will be increased by 3"



**CLEAR PLASTIC WINDOW FRONT**  
Increases bin capacity and provides a quick view of the bin contents. (Sold separately)



Giant Stack Container Storage Center - Complete Packages

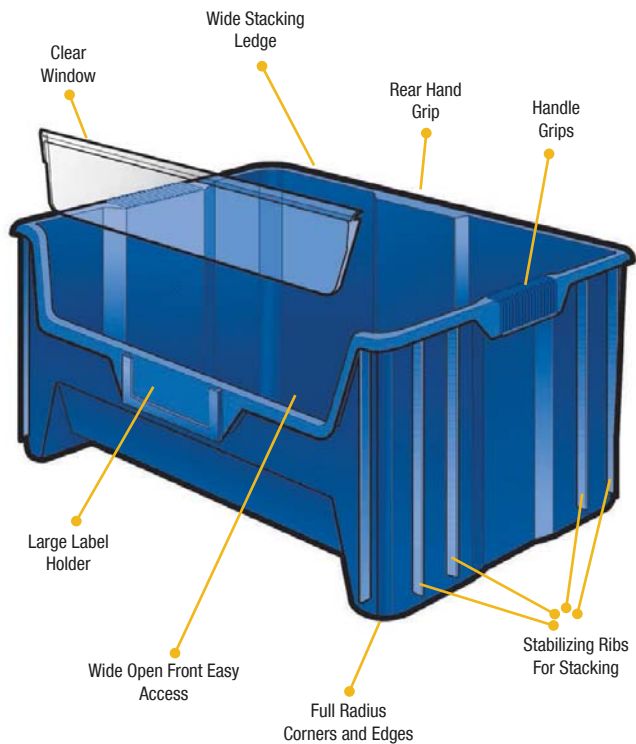

Organize, store, and access your medium or large parts with this high capacity bin center. 400 lb. capacity per shelf and over 21 cubic feet of storage space. Powder coat finish ensures years of dependable use. Easy assembly.



AVAILABLE on pg. 23



QGH700CL



QSBU-700  
18"D x 42"W x 75"H  
6 shelves and 10 QGH700 bins

COMPLETE PACKAGES WITH BINS

400 lb. LOAD CAPACITY PER SHELF



QSBU-600  
18"D x 36"W x 75"H  
6 shelves and 15 QGH600 bins



QSBU-600800  
18"D x 36"W x 75"H  
6 shelves, 6 QGH600 bins and 6 QGH800 bins



QSBU-800  
18"D x 36"W x 75"H  
6 shelves and 10 QGH800 bins

QGH700 available in: Blue Ivory Red Black Gray Clear

QGH600 and QGH800 available in: Blue Red Gray Clear (One color per unit)



**Giant Stack Container Wire Shelving Systems - Complete Packages**



**WR5-600**  
18"W x 36"L x 74"H  
5 shelves and 12 QGH600  
17-1/2"L x 10-7/8"W x 12-1/2"H bins

**COMPLETE PACKAGES WITH BINS**

**CLEAR VIEW**  
AVAILABLE on pg. 23



**WR5-600800**  
18"W x 36"L x 74"H  
5 shelves and 6 QGH600 17-1/2"L x 10-7/8"W x 12-1/2"H bins and 4 QGH800 17-1/2"L x 16-1/2"W x 12-1/2"H bins

**800 lb. LOAD CAPACITY PER SHELF**



**WR5-800**  
18"W x 36"L x 74"H  
5 shelves and 8 QGH800  
17-1/2"L x 16-1/2"W x 12-1/2"H bins



**MOBILIZE YOUR WIRE SHELVING**

**DB - Donut Bumper**  
Non-marking donut bumper used to protect walls and help cushion impact.

**WR-00H (Mobile Kit)**  
Set of four swivel thermoplastic resin 5" x 1-1/4" casters, two with brakes. Can be used with all units shown. 1,200 lb. load capacity.



**WR5-700**  
18"W x 42"L x 74"H  
5 shelves and 8 QGH700  
15-1/4"L x 19-7/8"W x 12-7/16"H bins

QGH700 available in: ● Blue ● Ivory ● Red ● Black ● Gray ● Clear

QGH600 and QGH800 available in: ● Blue ● Red ● Gray ● Clear (One color per unit)



# 6 SIZES AND 5 COLORS AVAILABLE



**PERFORMANCE FEATURES:**

- Available in 6 sizes and 5 colors (Blue, Green, Red, Yellow and Black) for inventory control and color code efficiency
- These heavy-duty containers are injection molded from high density polypropylene and are ideal for storage and transport of large and heavy parts
- Extra heavy, double wall thickness allow containers to stack securely
- 150 lb. stack capacity

**MAGNUM Bins - Super Strong and Durable**



## 150 lb. STACK CAPACITY PER BIN

Heavy-duty, extra strong injection molded, high density polypropylene bins are ideal for transportation and storage of large and heavy parts. Open hopper front allows immediate access and visibility. Ribbed reinforced walls ensure extra strength. Double wall thickness with preformed lip allows bin to interlock and provides up to 150 lb. stack capacity. Transport these bins easily with rear molded handle. Molded in label slot. Impervious to most solvents, corrosion, rust and rot resistant. Resists temperatures from -40°F to 250°F. Optional window front maximizes storage and prevents spillage. Optional dividers maximize flexibility and keeps contents organized.

Available in: ● Blue ● Green ● Red ● Yellow ● Black

MODEL NO.	OUTSIDE DIMENSIONS L" x W" x H"	INSIDE DIMENSIONS L" x W" x H"	X"	CTN QTY	CTN WGT	DIVIDERS	CTN QTY WINDOW	CTN QTY
QMS531	19-3/4" x 12-3/8" x 5-7/8"	17" x 11" x 5"	17"	6	19 lbs	DMS531	6	WMS531 6
QMS532	19-3/4" x 12-3/8" x 7-7/8"	16-3/4" x 11" x 7-1/4"	16-3/4"	6	23 lbs	DMS532	6	WMS532 6
QMS533	19-3/4" x 12-3/8" x 11-7/8"	16-5/8" x 10-1/4" x 11-1/8"	16-5/8"	3	15 lbs	DMS533	3	WMS533 3
QMS543	19-3/4" x 18-3/8" x 11-7/8"	16-5/8" x 16-3/4" x 11"	16-5/8"	1	8 lbs	DMS543	1	WMS543 1
QMS743*	29" x 18-3/8" x 11-7/8"	25-1/2" x 16-3/4" x 11"	23"	1	10 lbs	-	-	-
QMS843MOB*	29" x 18-3/8" x 14-7/8"	25-1/2" x 16-3/4" x 11"	23"	1	12 lbs	-	-	-

\*Includes heavy-duty spread bar for extra strength and support

**COMFORT HANDLE**  
for easy gripping and handling



**QMS743 and QMS843MOB**  
Includes heavy-duty spread bar for extra strength and support



**ATTACHED PULL RING**  
allows dolly to be pulled with ease



**Polymer Dolly**

DLY-3018 is 30"L x 18"W with padded rubber trim, available in Blue. Set of four 4" x 1-1/4" non-marking swivel poly casters. Both dollies have 1,000 lb. load capacity.

MODEL NO.	DESCRIPTION	CTN WGT
DLY-3018	Dolly with Padded Rubber Trim	19 lbs
HANDLE-DLY	32" Dolly Pull Rod with Handle	2 lbs

Bins sold separately



**CLEAR WINDOW FRONT**  
Increases bin capacity and provides a quick view of the bin contents. (Optional)



**MAGNUM BIN**  
Shown with optional divider

**Mobile MAGNUM Bins**

- Bin comes with 4 swivel 3" polyurethane casters, all with brakes, allowing for 250 lb. mobile capacity
- Bins can stack on each other with casters in place
- QMS843MOB includes heavy-duty spread bar

**MAGNUM Bin Steel Shelving Systems - Complete Packages**



These ultra heavy-duty shelving systems incorporate Quantum's Giant MAGNUM Bins. Five combinations allow you a wide selection to choose from. Bins offer optional clear window fronts as well as dividers for maximum storage capacity. Shelving is tough 42" wide with a 350 lb. load capacity per shelf. Smooth powder coat finish is rust and corrosion resistant.

**COMPLETE PACKAGES WITH BINS**

**MAGNUM**

**18" DEEP UNITS**

18"D x 42"W x 75"H Shelving



**MSU-531**  
 10 shelves and 27 QMS531  
 19-3/4"L x 12-3/8"W x 5-7/8"H bins



**MSU-16-MIX**  
 7 shelves and 4 QMS543  
 19-3/4"L x 18-3/8"W x 11-7/8"H bins,  
 3 QMS533  
 19-3/4"L x 12-3/8"W x 11-7/8"H bins,  
 6 QMS532  
 19-3/4"L x 12-3/8"W x 7-7/8"H bins,  
 3 QMS531  
 19-3/4"L x 12-3/8"W x 5-7/8"H bins

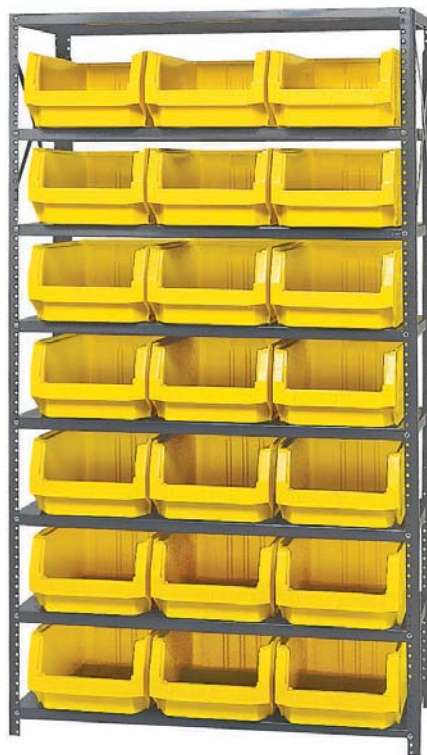

**MSU-532**  
 8 shelves and 21 QMS532  
 19-3/4"L x 12-3/8"W x 7-7/8"H bins



**MSU-533**  
 6 shelves and 15 QMS533  
 19-3/4"L x 12-3/8"W x 11-7/8"H bins



**MSU-543**  
 6 shelves and 10 QMS543  
 19-3/4"L x 18-3/8"W x 11-7/8"H bins

Bins available in: ● Blue ● Green ● Red ● Yellow ● Black (One color per unit)



MAGNUM Bin Wire Shelving Systems - Complete Packages



**WR9-531**  
18"W x 42"L x 74"H  
9 shelves and 24 QMS531  
19-3/4"L x 12-3/8"W x 5-7/8"H bins



**WR7-532**  
18"W x 42"L x 74"H  
7 shelves and 18 QMS532  
19-3/4"L x 12-3/8"W x 7-7/8"H bins



**WR5-533**  
18"W x 42"L x 74"H  
5 shelves and 12 QMS533  
19-3/4"L x 12-3/8"W x 11-7/8"H bins



**WR5-543**  
18"W x 42"L x 74"H  
5 shelves and 8 QMS543  
19-3/4"L x 18-3/8"W x 11-7/8"H bins

**800 lb.**  
LOAD CAPACITY PER SHELF

**MAGNUM**

**COMPLETE  
PACKAGES  
WITH BINS**



**MOBILIZE YOUR WIRE SHELVING**

**DB - Donut Bumper**  
Non-marking donut bumper used to protect walls and help cushion impact.

**WR-00H (Mobile Kit)**  
Set of four swivel thermoplastic resin 5" x 1-1/4" casters, two with brakes. Can be used with all units shown. 1,200 lb. load capacity.



**WR6-13-MIX**  
18"W x 42"L x 74"H  
6 shelves and 4 QMS543 19-3/4"L x 18-3/8"W x 11-7/8"H bins  
3 QMS533 19-3/4"L x 12-3/8"W x 11-7/8"H bins  
3 QMS532 19-3/4"L x 12-3/8"W x 7-7/8"H bins  
3 QMS531 19-3/4"L x 12-3/8"W x 5-7/8"H bins

Bins available in: ● Blue ● Green ● Red ● Yellow ● Black (One color per unit)



# 13 SIZES AND 8 COLORS AVAILABLE

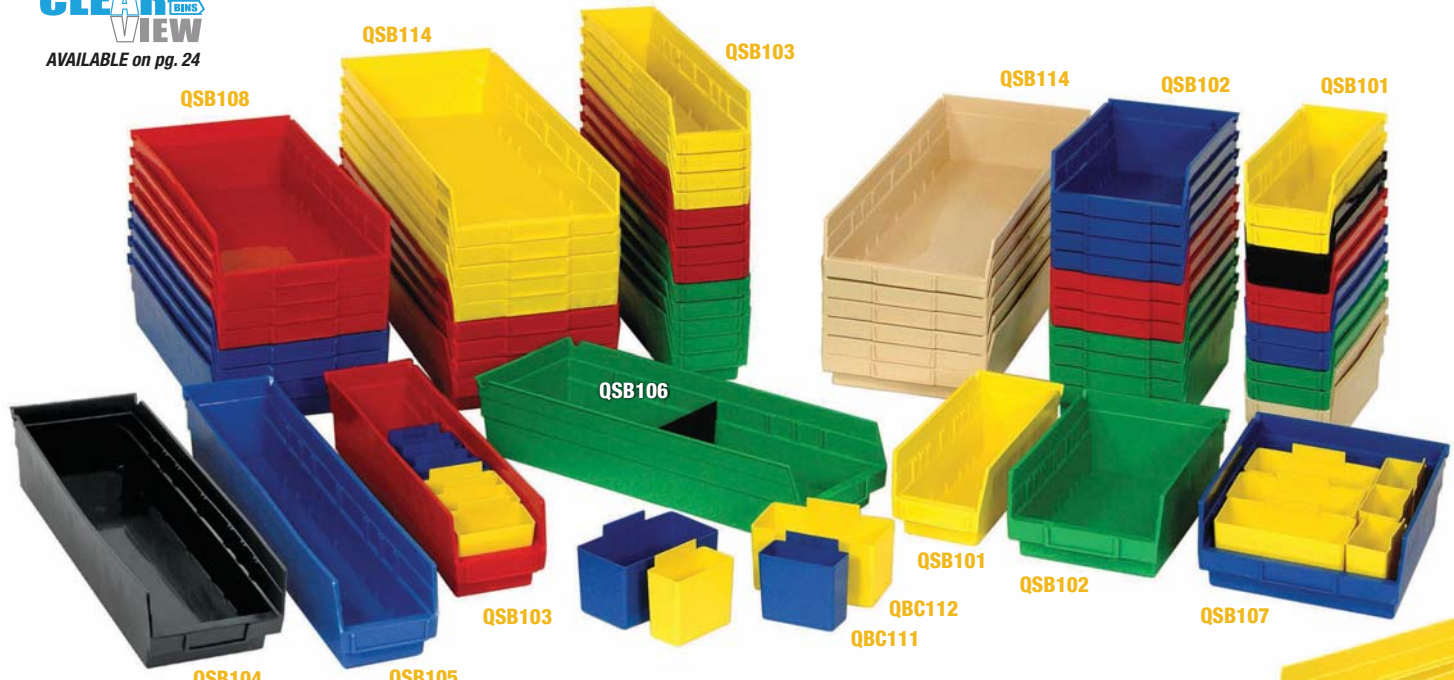

Pink color in select sizes



**LTR-0813**  
Clear Label Holder and Insert  
Clear label holders and laser label inserts. Package of 25. Label holders fit all bins (except QSB100).

### Divider Label Tab

Divider Label Tabs attach to existing dividers enabling sections of bin to be labeled. Tabs improve the visibility of bin labels and scanning of barcodes. Package of 6.



DLT-6

### Economy 4" Shelf Bins



Quantum's tough, durable, high density Economy Shelf Bins are the industry standard for quality. These durable polypropylene bins feature a molded-in label holder, built-in rear hanglock which allows bins to tilt out for complete access when on shelving. A wide hopper front allows complete access to the contents of the bin. Edges are reinforced for added strength. They are designed for 12", 18" and 24" deep shelf units, racks or standard shelving. Bins are impervious to most chemicals. See pg. 24 to order Clear Bins.

Available in: ● Blue ● Green ● Ivory ● Red ● Yellow ● Black ● Clear  
QSB101, QSB102, QSB103, QSB104 also available in: ● Pink

MODEL NO.	OUTSIDE DIMENSIONS L" x W" x H"	INSIDE DIMENSIONS L" x W" x H"	CTN QTY	CTN WGT	DIVIDER	CTN QTY	NO. OF BIN CUPS PER BIN QBC111	QBC112
QSB100	11-5/8" x 2-3/4" x 4"	10-1/4" x 1-5/8" x 4"	36	13 lbs	-	-	3	0
QSB101	11-5/8" x 4-1/8" x 4"	10-1/4" x 3" x 4"	36	17 lbs	DSB101	50	6	2
QSB102	11-5/8" x 6-5/8" x 4"	10-1/4" x 5-1/2" x 4"	30	18 lbs	DSB102	50	9	4
QSB107	11-5/8" x 8-3/8" x 4"	10-1/4" x 7-1/8" x 4"	20	15 lbs	DSB107	50	12	4
QSB109	11-5/8" x 11-1/8" x 4"	10-1/4" x 10" x 4"	8	7 lbs	DSB109	50	18	6
QSB103	17-7/8" x 4-1/8" x 4"	16-1/2" x 3" x 4"	20	13 lbs	DSB103	50	9	3
QSB104	17-7/8" x 6-5/8" x 4"	16-1/2" x 5-1/2" x 4"	20	16 lbs	DSB104	50	15	6
QSB108	17-7/8" x 8-3/8" x 4"	16-1/2" x 7-1/8" x 4"	10	11 lbs	DSB108	50	19	6
QSB110	17-7/8" x 11-1/8" x 4"	16-1/2" x 10" x 4"	8	11 lbs	DSB110	50	29	8
QSB105	23-5/8" x 4-1/8" x 4"	22-1/8" x 3" x 4"	16	13 lbs	DSB105	50	13	4
QSB106	23-5/8" x 6-5/8" x 4"	22-1/8" x 5-1/2" x 4"	8	9 lbs	DSB106	50	21	8
QSB114	23-5/8" x 8-3/8" x 4"	22-1/8" x 7-1/8" x 4"	6	9 lbs	DSB114	50	24	8
QSB116	23-5/8" x 11-1/8" x 4"	22-1/8" x 10" x 4"	6	10 lbs	DSB116	50	35	16

## LOW COST, LONG LASTING, UNBREAKABLE, REUSABLE 4" HIGH BINS

10° Angle

45° Angle

### Extended Label Holders - Simplify Identification



Optional extended label holders are designed for larger bar code scanning or just larger labels. Label holders fit all Shelf Bins (except QSB100).

MODEL NO.	DESCRIPTION	DIMENSIONS W" x H"	CTN QTY
ELH410	10° Angle	4" x 2-1/4"	24
ELH445	45° Angle	4" x 2-1/4"	24



### Dividers and Bin Cups



Optional dividers fit snugly, horizontally across bins and are uniquely designed to allow for easy part labeling via individual label slots. All bins can accommodate up to 7 dividers.

Bin cups have a raised, slotted label holder for easy parts identification. The entire bin cup may be removed for easy part retrieval. Available in 2 sizes and 2 colors.

Available in: ● Blue ● Yellow

MODEL NO.	OUTSIDE DIMENSIONS L" x W" x H"	CTN QTY	CTN WGT
QBC111	3-1/4" x 1-3/4" x 3"	48	4 lbs
QBC112	5-1/8" x 2-3/4" x 3"	48	7 lbs





### Economy 4" Shelf Bin Steel Shelving Systems - Complete Packages

Economical small parts storage steel systems keep parts easily accessible. Open hopper front bins with label area provide fast access to stored items. This all-in-one unit is easy to clean and will not rust or corrode. Heavy-duty, high grade shelving offers a 400 lb. capacity per shelf. 36" wide shelving units have a smooth powder coat finish. Bins are available in 7 colors.

Bins available in: ● Blue ● Green ● Ivory ● Red ● Yellow  
● Black ● Clear (One color per unit)

MODEL NO.	NO. OF BINS	BIN DIMENSIONS L" x W" x H"	SHIP WGT
<b>12"D x 36"W x 75"H - 13 Shelf Systems</b>			
1275-100	144 QSB100	11-5/8" x 2-3/4" x 4"	139 lbs
1275-101	96 QSB101	11-5/8" x 4-1/8" x 4"	117 lbs
1275-102	60 QSB102	11-5/8" x 6-5/8" x 4"	115 lbs
1275-107	48 QSB107	11-5/8" x 8-3/8" x 4"	120 lbs
1275-109	36 QSB109	11-5/8" x 11-1/8" x 4"	119 lbs
1275-000	12" Deep Shelving Unit Only - No Bins		87 lbs
<b>12"D x 36"W x 39"H - 7 Shelf Systems</b>			
1239-100	72 QSB100	11-5/8" x 2-3/4" x 4"	75 lbs
1239-101	48 QSB101	11-5/8" x 4-1/8" x 4"	67 lbs
1239-102	30 QSB102	11-5/8" x 6-5/8" x 4"	63 lbs
1239-107	24 QSB107	11-5/8" x 8-3/8" x 4"	64 lbs
1239-109	18 QSB109	11-5/8" x 11-1/8" x 4"	65 lbs
1239-000	12" Deep Shelving Unit Only - No Bins		49 lbs
<b>18"D x 36"W x 75"H - 13 Shelf Systems</b>			
1875-103	96 QSB103	17-7/8" x 4-1/8" x 4"	161 lbs
1875-104	60 QSB104	17-7/8" x 6-5/8" x 4"	155 lbs
1875-108	48 QSB108	17-7/8" x 8-3/8" x 4"	161 lbs
1875-110	36 QSB110	17-7/8" x 11-1/8" x 4"	158 lbs
1875-000	18" Deep Shelving Unit Only - No Bins		113 lbs
<b>18"D x 36"W x 39"H - 7 Shelf Systems</b>			
1839-103	48 QSB103	17-7/8" x 4-1/8" x 4"	87 lbs
1839-104	30 QSB104	17-7/8" x 6-5/8" x 4"	84 lbs
1839-108	24 QSB108	17-7/8" x 8-3/8" x 4"	87 lbs
1839-110	18 QSB110	17-7/8" x 11-1/8" x 4"	86 lbs
1839-000	18" Deep Shelving Unit Only - No Bins		63 lbs



1275-102

**REAR "V" LOCK**  
enables bins to be hung from shelf above when in use

**ECONOMICAL  
SMALL PARTS  
STORAGE  
SYSTEMS  
KEEP PARTS  
EASILY  
ACCESSIBLE**

### COMPLETE PACKAGES WITH BINS



1839-104



AVAILABLE on pg. 25

**COLOR CODE  
PRODUCTS  
TO SIMPLIFY  
ORDER  
PICKING AND  
INVENTORY  
CONTROL**





**Economy 4" Shelf Bin Sloped Shelving Systems - Complete Packages**



Pick Racks provide a convenient high density, easy access, sloped shelving system, available as bench units, single, and double sided free standing and mobile units. Units come complete with Economical 4" Shelf Bins. Sloped shelving unit keeps small and medium sized parts easily accessible. Open hopper front bins with label area, provide fast access to stored items. This all-in-one unit is easy to clean and will not rust or corrode. See chart for configurations. One bin color per unit.



**QPRHA-102**  
Bench Pick Rack  
250 lb. capacity.

Bins available in: ● Blue ● Green ● Ivory ● Red ● Yellow ● Black ● Clear

MODEL NO.	NO. OF BINS	BIN DIMENSIONS L" x W" x H"	SHIP WGT
<b>12-1/2"L x 36"W x 23"H - 3 Shelf Bench Rack Systems</b>			
QPRHA-100	36 QSB100	11-5/8" x 2-3/4" x 4"	41 lbs
QPRHA-101	24 QSB101	11-5/8" x 4-1/8" x 4"	38 lbs
QPRHA-102	15 QSB102	11-5/8" x 6-5/8" x 4"	36 lbs
QPRHA-107	12 QSB107	11-5/8" x 8-3/8" x 4"	36 lbs
QPRHA-109	9 QSB109	11-5/8" x 11-1/8" x 4"	37 lbs
QPRHA-000	12" Deep Bench Rack Only - No Bins		26 lbs
<b>12"L x 36"W x 60"H - Single Sided 8 Shelf Rack Systems</b>			
QPRS-100	96 QSB100	11-5/8" x 2-3/4" x 4"	99 lbs
QPRS-101	64 QSB101	11-5/8" x 4-1/8" x 4"	85 lbs
QPRS-102	40 QSB102	11-5/8" x 6-5/8" x 4"	80 lbs
QPRS-107	32 QSB107	11-5/8" x 8-3/8" x 4"	81 lbs
QPRS-109	24 QSB109	11-5/8" x 11-1/8" x 4"	83 lbs
QPRS-000	12" Deep Single Sided Rack Only - No Bins		53 lbs
<b>18"L x 36"W x 60"H - Single Sided 8 Shelf Rack Systems</b>			
QPRS-103	64 QSB103	17-7/8" x 4-1/8" x 4"	124 lbs
QPRS-104	40 QSB104	17-7/8" x 6-5/8" x 4"	110 lbs
QPRS-108	32 QSB108	17-7/8" x 8-3/8" x 4"	115 lbs
QPRS-110	24 QSB110	17-7/8" x 11-1/8" x 4"	111 lbs
QPRS18-000	18" Deep Single Sided Rack Only - No Bins		78 lbs
<b>24"L x 36"W x 60"H - Double Sided 16 Shelf Rack Systems</b>			
QPRD-100	192 QSB100	11-5/8" x 2-3/4" x 4"	195 lbs
QPRD-101	128 QSB101	11-5/8" x 4-1/8" x 4"	169 lbs
QPRD-102	80 QSB102	11-5/8" x 6-5/8" x 4"	158 lbs
QPRD-107	64 QSB107	11-5/8" x 8-3/8" x 4"	160 lbs
QPRD-109	48 QSB109	11-5/8" x 11-1/8" x 4"	163 lbs
QPRD-000	24" (12" on each side) Deep Double Sided Rack Only - No Bins		106 lbs
QDU-00*	Mobile Kit - Mobilizes All Double Sided Systems		25 lbs
<b>36"L x 36"W x 60"H - Double Sided 16 Shelf Rack Systems</b>			
QPRD-103	128 QSB103	17-7/8" x 4-1/8" x 4"	241 lbs
QPRD-104	80 QSB104	17-7/8" x 6-5/8" x 4"	220 lbs
QPRD-108	64 QSB108	17-7/8" x 8-3/8" x 4"	226 lbs
QPRD-110	48 QSB110	17-7/8" x 11-1/8" x 4"	222 lbs
QPRD18-000	36" (18" on each side) Deep Double Sided Rack Only - No Bins		156 lbs
QDU-18*	Mobile Kit - Mobilizes All Double Sided Systems		35 lbs

\*1,200 lb. load capacity. 2 rigid, 2 swivel with brake hard rubber casters.

**SLOPED SHELVES, EASY ACCESS, MOST POPULAR AND VERSATILE STORAGE SYSTEMS SOLD**

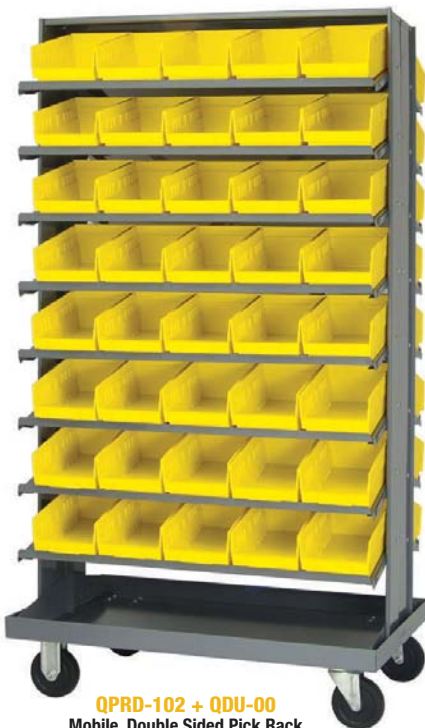

**QPRD-102 + QDU-00**  
Mobile, Double Sided Pick Rack  
1,200 lb. load capacity. 2 rigid, 2 swivel with brake hard rubber casters.



**QPRD-107**  
Double Sided Pick Rack  
800 lb. capacity.



**QPRS-101**  
Single Sided Pick Rack  
400 lb. capacity.



WR12-101

## COMPLETE PACKAGES WITH BINS



AVAILABLE on pg. 24

**800 lb. LOAD CAPACITY PER SHELF**



### MOBILIZE YOUR WIRE SHELVING

#### DB - Donut Bumper

Non-marking donut bumper used to protect walls and help cushion impact.

#### WR-00H (Mobile Kit)\*

Set of four swivel thermoplastic resin 5" x 1-1/4" casters, two with brakes. 1,200 lb. load capacity. \*Mobile kits recommended only for shelves 18" and deeper.



WR12-102



WR12-107

### Economy 4" Shelf Bin Wire Shelving Systems - Complete Packages

Bins available in: ● Blue ● Green ● Ivory ● Red ● Yellow  
● Black ● Clear (One color per unit)

MODEL NO.	NO. OF BINS	BIN DIMENSIONS L" x W" x H"	SHIP WGT
<b>12"W x 36"L x 74"H - 12 Shelf Systems</b>			
WR12-101	88 QSB101	11-5/8" x 4-1/8" x 4"	120 lbs
WR12-102	55 QSB102	11-5/8" x 6-5/8" x 4"	116 lbs
WR12-107	44 QSB107	11-5/8" x 8-3/8" x 4"	117 lbs
WR12-109	33 QSB109	11-5/8" x 11-1/8" x 4"	119 lbs
<b>18"W x 36"L x 74"H - 12 Shelf Systems</b>			
WR12-103	88 QSB103	17-7/8" x 4-1/8" x 4"	176 lbs
WR12-104	55 QSB104	17-7/8" x 6-5/8" x 4"	165 lbs
WR12-108	44 QSB108	17-7/8" x 8-3/8" x 4"	170 lbs
WR12-110	33 QSB110	17-7/8" x 11-1/8" x 4"	168 lbs
<b>24"W x 36"L x 74"H - 12 Shelf Systems</b>			
WR12-105	88 QSB105	23-5/8" x 4-1/8" x 4"	228 lbs
WR12-106	55 QSB106	23-5/8" x 6-5/8" x 4"	218 lbs
WR12-114	44 QSB114	23-5/8" x 8-3/8" x 4"	222 lbs
WR12-116	33 QSB116	23-5/8" x 11-1/8" x 4"	206 lbs

### Economy 4" Complete Bin Center

Complete bin systems are available with 4 different size bin options on a 12"W x 36"L x 36"H unit. This all-purpose bin center is an economical high density storage system that provides easy visibility to stored contents.

- Easy boltless assembly
- Wire allows air to circulate as well as provides ideal product visibility
- Durable chrome finish ensures years of heavy-duty dependability and service

Bins available in: ● Blue ● Green ● Ivory ● Red ● Yellow  
● Black ● Clear (One color per unit)

MODEL NO.	NO. OF BINS	BIN DIMENSIONS L" x W" x H"	SHIP WGT
<b>12"W x 36"L x 36"H - 6 Shelf Systems</b>			
WR6-36-1236-101	40 QSB101	11-5/8" x 4-1/8" x 4"	63 lbs
WR6-36-1236-102	25 QSB102	11-5/8" x 6-5/8" x 4"	50 lbs
WR6-36-1236-107	20 QSB107	11-5/8" x 8-3/8" x 4"	62 lbs
WR6-36-1236-109	15 QSB109	11-5/8" x 11-1/8" x 4"	64 lbs



WR6-36-1236-102



**High Density Wire Shelving Systems**



- Wire Storage Systems with bins available in 48", 60" and 72" lengths
- All units in chart below utilize 74" posts and include 12 shelves
- Non-marring thermoplastic resin caster kit **WR-00H** (sold separately)



**WR74-2448-66106**



**WR74-2448-66106**  
Shown with optional Mobile Kit

**600-800 lb.**  
**LOAD CAPACITY PER SHELF**



**MOBILIZE YOUR WIRE SHELVING**

**DB - Donut Bumper**  
Non-marking donut bumper used to protect walls and help cushion impact.

**WR-00H (Mobile Kit)\***  
Set of four swivel thermoplastic resin 5" x 1-1/4" casters, two with brakes. 1,200 lb. load capacity.  
*\*Mobile kits recommended only for shelves 18" and deeper.*

Bins available in: ● Blue ● Green ● Ivory ● Red ● Yellow ● Black ● Clear (One color per unit)

BIN DIMENSIONS L" x W" x H"	HIGH DENSITY WIRE SYSTEMS								
	48"L SYSTEMS			60"L SYSTEMS			72"L SYSTEMS		
	MODEL NO.	NO. OF BINS	SHIP WGT	MODEL NO.	NO. OF BINS	SHIP WGT	MODEL NO.	NO. OF BINS	SHIP WGT
	<b>12"W x 48"L - Systems</b>			<b>12"W x 60"L - Systems</b>			<b>12"W x 72"L - Systems</b>		
11-5/8" x 4-1/8" x 4"	<b>WR74-1248-110101</b>	110 QSB101	152 lbs	<b>WR74-1260-143101</b>	143 QSB101	208 lbs	<b>WR74-1272-176101</b>	176 QSB101	248 lbs
11-5/8" x 4-1/8" x 4"	<b>WR74-1248-101102</b>	55 QSB101	148 lbs	<b>WR74-1260-101102</b>	78 QSB101	213 lbs	<b>WR74-1272-101102</b>	80 QSB101	240 lbs
11-5/8" x 6-5/8" x 4"		36 QSB102	140 lbs		40 QSB102	193 lbs		60 QSB102	230 lbs
11-5/8" x 6-5/8" x 4"	<b>WR74-1248-66102</b>	66 QSB102	140 lbs	<b>WR74-1260-88102</b>	88 QSB102	193 lbs	<b>WR74-1272-110102</b>	110 QSB102	230 lbs
	<b>18"W x 48"L - Systems</b>			<b>18"W x 60"L - Systems</b>			<b>18"W x 72"L - Systems</b>		
17-7/8" x 4-1/8" x 4"	<b>WR74-1848-110103</b>	110 QSB103	168 lbs	<b>WR74-1860-143103</b>	143 QSB103	224 lbs	<b>WR74-1872-176103</b>	176 QSB103	264 lbs
17-7/8" x 4-1/8" x 4"	<b>WR74-1848-103104</b>	55 QSB103	164 lbs	<b>WR74-1860-103104</b>	78 QSB103	229 lbs	<b>WR74-1872-103104</b>	80 QSB103	256 lbs
17-7/8" x 6-5/8" x 4"		36 QSB104	156 lbs		40 QSB104	209 lbs		60 QSB104	246 lbs
17-7/8" x 6-5/8" x 4"	<b>WR74-1848-66104</b>	66 QSB104	156 lbs	<b>WR74-1860-88104</b>	88 QSB104	209 lbs	<b>WR74-1872-110104</b>	110 QSB104	246 lbs
	<b>24"W x 48"L - Systems</b>			<b>24"W x 60"L - Systems</b>			<b>24"W x 72"L - Systems</b>		
23-5/8" x 4-1/8" x 4"	<b>WR74-2448-110105</b>	110 QSB105	180 lbs	<b>WR74-2460-143105</b>	143 QSB105	256 lbs	<b>WR74-2472-176105</b>	176 QSB105	312 lbs
23-5/8" x 4-1/8" x 4"	<b>WR74-2448-105106</b>	55 QSB105	176 lbs	<b>WR74-2460-105106</b>	78 QSB105	261 lbs	<b>WR74-2472-105106</b>	80 QSB105	304 lbs
23-5/8" x 6-5/8" x 4"		36 QSB106	168 lbs		40 QSB106	241 lbs		60 QSB106	294 lbs
23-5/8" x 6-5/8" x 4"	<b>WR74-2448-66106</b>	66 QSB106	168 lbs	<b>WR74-2460-88106</b>	88 QSB106	241 lbs	<b>WR74-2472-110106</b>	110 QSB106	294 lbs

48"L - 800 lb. Capacity/Shelf

60"L - 600 lb. Capacity/Shelf

72"L - 600 lb. Capacity/Shelf



AVAILABLE on pg. 26

# 12 SIZES AND 4 COLORS AVAILABLE

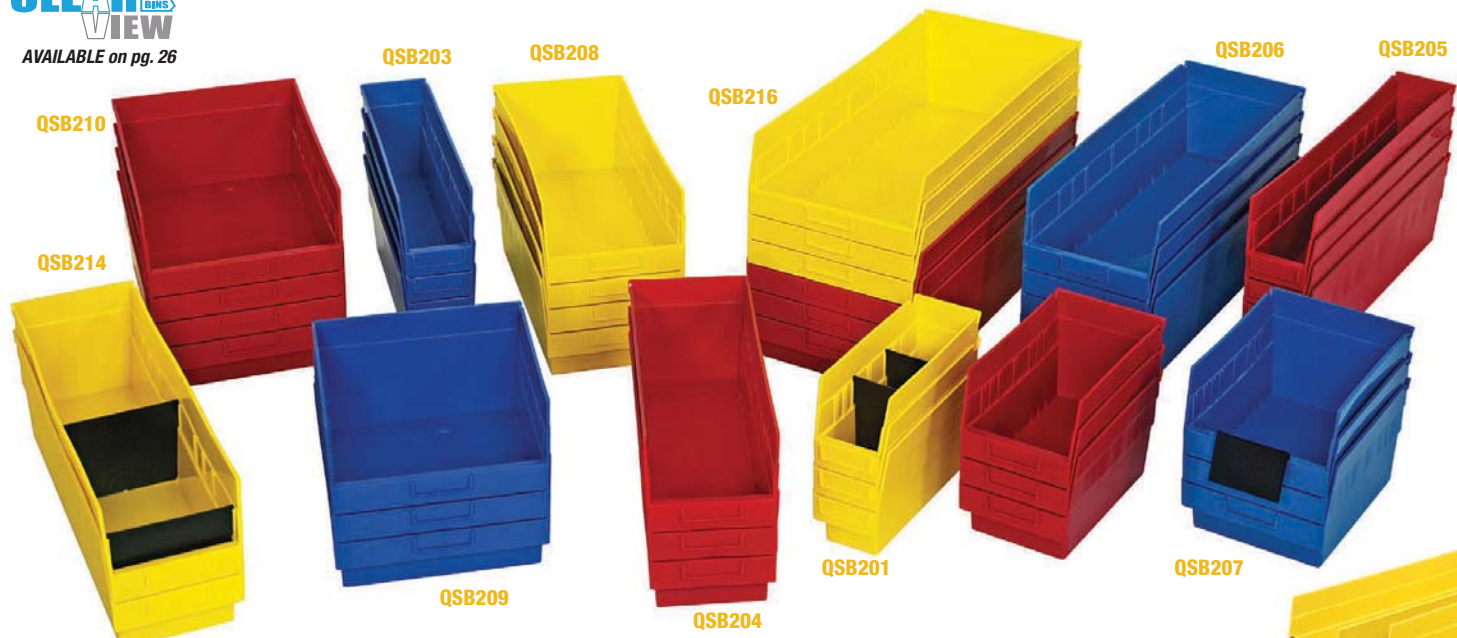

## LOW COST, LONG LASTING, UNBREAKABLE, REUSABLE, 6" HIGH SHELF BINS

10° Angle

45° Angle



with **68%** more storage capacity over standard 4" shelf bins, Quantum's **STORE-MORE 6"** Shelf Bins are an industry first and now an industry standard

### Divider Label Tab

Divider Label Tabs attach to existing dividers enabling sections of bin to be labeled. Tabs improve the visibility of bin labels and scanning of barcodes. Package of 6.



DLT-6

### Extended Label Holders - Simplify Identification

Optional extended label holders are designed for larger bar code scanning or just larger labels. Label holders fit all 6" Shelf Bins.

MODEL NO.	DESCRIPTION	DIMENSIONS W" x H"	CTN QTY
ELH410	10° Angle	4" x 2-1/4"	24
ELH445	45° Angle	4" x 2-1/4"	24

### LTR-0813

**Clear Label Holder and Insert**  
Clear label holders and laser label inserts. Clear label holders fit all 6" Shelf Bins. Package of 25.



### STORE-MORE 6" Shelf Bins



Maximize your storage space with durable, high density polypropylene bins. Quantum's STORE-MORE 6" Shelf Bins are the industry standard for quality. These bins feature a molded-in label holder, built-in rear hang-lock which allows bins to tilt out for complete access when on shelving. A wide hopper front allows complete access to the contents of the bin. Edges are reinforced for added strength. They are designed for 12", 18" and 24" deep shelf units, racks or standard shelving. Optional dividers are a perfect accessory to subdivide and keep parts separated as needed. Bins are waterproof and corrosion-free. See *pg. 26* to order Clear Bins.

Available in: ● Blue ● Red ● Yellow ● Clear

MODEL NO.	OUTSIDE DIMENSIONS L" x W" x H"	INSIDE DIMENSIONS L" x W" x H"	CTN QTY	CTN WGT	DIVIDER	CTN QTY	NO. OF BIN CUPS PER BIN
							QBC111 QBC112
QSB201	11-5/8" x 4-1/8" x 6"	10-1/6" x 3" x 6"	36	19 lbs	DSB201	50	6 2
QSB202	11-5/8" x 6-5/8" x 6"	10-1/6" x 5-1/2" x 6"	30	20 lbs	DSB202	50	9 4
QSB207	11-5/8" x 8-3/8" x 6"	10-1/6" x 7-1/8" x 6"	20	17 lbs	DSB207	50	12 4
QSB209	11-5/8" x 11-1/8" x 6"	10-1/6" x 10" x 6"	8	9 lbs	DSB209	50	18 6
QSB203	17-7/8" x 4-1/8" x 6"	16-1/2" x 3" x 6"	20	15 lbs	DSB203	50	9 3
QSB204	17-7/8" x 6-5/8" x 6"	16-1/2" x 5-1/2" x 6"	20	18 lbs	DSB204	50	15 6
QSB208	17-7/8" x 8-3/8" x 6"	16-1/2" x 7-1/8" x 6"	10	13 lbs	DSB208	50	19 6
QSB210	17-7/8" x 11-1/8" x 6"	16-1/2" x 10" x 6"	8	13 lbs	DSB210	50	29 8
QSB205	23-5/8" x 4-1/8" x 6"	22-1/8" x 3" x 6"	16	15 lbs	DSB205	50	13 4
QSB206	23-5/8" x 6-5/8" x 6"	22-1/8" x 5-1/2" x 6"	8	11 lbs	DSB206	50	21 8
QSB214	23-5/8" x 8-3/8" x 6"	22-1/8" x 7-1/8" x 6"	6	11 lbs	DSB214	50	24 8
QSB216	23-5/8" x 11-1/8" x 6"	22-1/8" x 10" x 6"	6	12 lbs	DSB216	50	35 16



### Dividers and Bin Cups

Optional black dividers fit snugly, horizontally across bins to create compartments. Each bin accepts up to 8 dividers. Bins have a slot at the very front allowing the open hopper to be closed off creating even more storage.

Bin cups have a raised, slotted label holder for easy parts identification. The entire bin cup may be removed for easy part retrieval. Available in 2 sizes and 2 colors.

Available in: ● Blue ● Yellow

MODEL NO.	OUTSIDE DIMENSIONS L" x W" x H"	CTN QTY	CTN WGT
QBC111	3-1/4" x 1-3/4" x 3"	48	4 lbs
QBC112	5-1/8" x 2-3/4" x 3"	48	7 lbs



**CLEAR VIEW**  
AVAILABLE on pg. 27

**STORE-MORE 6" Shelf Bin Steel Shelving Systems - Complete Packages**

- Economical small parts storage systems keep parts easily accessible
- Open hopper front bins with label area, provide fast access to stored items
- This all-in-one unit is easy to clean and is rust and corrosion resistant
- Heavy-duty, high grade shelving offers a 400 lb. capacity per shelf
- 36" wide shelving has a smooth powder coat finish

Bins available in: ● Blue ● Red ● Yellow ● Clear (One color per unit)

MODEL NO.	NO. OF BINS	BIN DIMENSIONS L" x W" x H"	SHIP WGT
<b>12"D x 36"W x 75"H - 10 Shelf Systems</b>			
1275-201	72 QSB201	11-5/8" x 4-1/8" x 6"	111 lbs
1275-202	45 QSB202	11-5/8" x 6-5/8" x 6"	103 lbs
1275-207	36 QSB207	11-5/8" x 8-3/8" x 6"	100 lbs
1275-209	27 QSB209	11-5/8" x 11-1/8" x 6"	98 lbs
<b>12"D x 36"W x 39"H - 5 Shelf Systems</b>			
1239-201	32 QSB201	11-5/8" x 4-1/8" x 6"	56 lbs
1239-202	20 QSB202	11-5/8" x 6-5/8" x 6"	52 lbs
1239-207	16 QSB207	11-5/8" x 8-3/8" x 6"	51 lbs
1239-209	12 QSB209	11-5/8" x 11-1/8" x 6"	50 lbs
<b>18"D x 36"W x 75"H - 10 Shelf Systems</b>			
1875-203	72 QSB203	17-7/8" x 4-1/8" x 6"	156 lbs
1875-204	45 QSB204	17-7/8" x 6-5/8" x 6"	141 lbs
1875-208	36 QSB208	17-7/8" x 8-3/8" x 6"	142 lbs
1875-210	27 QSB210	17-7/8" x 11-1/8" x 6"	139 lbs
<b>18"D x 36"W x 39"H - 5 Shelf Systems</b>			
1839-203	32 QSB203	17-7/8" x 4-1/8" x 6"	77 lbs
1839-204	20 QSB204	17-7/8" x 6-5/8" x 6"	70 lbs
1839-208	16 QSB208	17-7/8" x 8-3/8" x 6"	71 lbs
1839-210	12 QSB210	17-7/8" x 11-1/8" x 6"	69 lbs



**COMPLETE PACKAGES WITH BINS**



1275-201



1275-202



1875-210



AVAILABLE on pg. 27

Bins available in: Blue Red Yellow Clear (One color per unit)

MODEL NO.	NO. OF BINS	BIN DIMENSIONS L" x W" x H"	SHIP WGT
<b>12"L x 36"W x 26-1/2"H - 3 Shelf Bench Rack Systems</b>			
QPRHA-201	24 QSB201	11-5/8" x 4-1/8" x 6"	40 lbs
QPRHA-202	15 QSB202	11-5/8" x 6-5/8" x 6"	37 lbs
QPRHA-207	12 QSB207	11-5/8" x 8-3/8" x 6"	36 lbs
QPRHA-209	9 QSB209	11-5/8" x 11-1/8" x 6"	35 lbs
QPRHA-6	12" Deep Bench Rack Only - No Bins		
<b>12"L x 36"W x 63-1/2"H - Single Sided 8 Shelf Rack Systems</b>			
QPRS-201	64 QSB201	11-5/8" x 4-1/8" x 6"	89 lbs
QPRS-202	40 QSB202	11-5/8" x 6-5/8" x 6"	81 lbs
QPRS-207	32 QSB207	11-5/8" x 8-3/8" x 6"	79 lbs
QPRS-209	24 QSB209	11-5/8" x 11-1/8" x 6"	77 lbs
QPRS-6	12" Deep Single Sided Rack Only - No Bins		
<b>18"L x 36"W x 63-1/2"H - Single Sided 8 Shelf Rack Systems</b>			
QPRS-203	64 QSB203	17-7/8" x 4-1/8" x 6"	126 lbs
QPRS-204	40 QSB204	17-7/8" x 6-5/8" x 6"	114 lbs
QPRS-208	32 QSB208	17-7/8" x 8-3/8" x 6"	120 lbs
QPRS-210	24 QSB210	17-7/8" x 11-1/8" x 6"	117 lbs
QPRS18-6	18" Deep Single Sided Rack Only - No Bins		
<b>24"L x 36"W x 63-1/2"H - Double Sided 16 Shelf Rack Systems</b>			
QPRD-201	128 QSB201	11-5/8" x 4-1/8" x 6"	178 lbs
QPRD-202	80 QSB202	11-5/8" x 6-5/8" x 6"	162 lbs
QPRD-207	64 QSB207	11-5/8" x 8-3/8" x 6"	158 lbs
QPRD-209	48 QSB209	11-5/8" x 11-1/8" x 6"	154 lbs
QPRD-6	24" (12" on each side) Deep Double Sided Rack Only - No Bins		
QDU-00*	Mobile Kit - Mobilizes All 24" Deep Double Sided Units		
<b>36"L x 36"W x 63-1/2"H - Double Sided 16 Shelf Rack Systems</b>			
QPRD-203	128 QSB203	17-7/8" x 4-1/8" x 6"	252 lbs
QPRD-204	80 QSB204	17-7/8" x 6-5/8" x 6"	228 lbs
QPRD-208	64 QSB208	17-7/8" x 8-3/8" x 6"	239 lbs
QPRD-210	48 QSB210	17-7/8" x 11-1/8" x 6"	234 lbs
QPRD18-6	36" (18" on each side) Double Sided Rack Only - No Bins		
QDU-18*	Mobile Kit - Mobilizes All 36" Deep Double Sided Units		

\*1,200 lb. load capacity. 2 rigid, 2 swivel with brake hard rubber casters.

STORE-MORE 6" Shelf Bin Sloped Shelving Systems - Complete Packages

Pick Racks provide a convenient high density, easy access, sloped shelving system, available as bench units, single, and double sided free standing and mobile units. Units come complete with STORE-MORE 6" Shelf Bins. Sloped shelving unit keeps small and medium sized parts easily accessible. Open hopper front bins with label area, provide fast access to stored items. This all-in-one unit is easy to clean and is rust and corrosion resistant. See chart for configurations.



QPRHA-209 Bench Pick Rack 250 lb. capacity.

SLOPED SHELVES, EASY ACCESS, MOST POPULAR AND VERSATILE STORAGE SYSTEMS SOLD



QPRD-202 + QDU-00 Mobile, Double Sided Pick Rack 1,200 lb. load capacity. 2 rigid, 2 swivel with brake hard rubber casters.



QPRD-207 Double Sided Pick Rack 800 lb. capacity.



QPRS-201 Single Sided Pick Rack 400 lb. capacity.



**STORE-MORE 6" Shelf Bin Wire Shelving Systems - Complete Packages**

- Easy boltless assembly
- Wire allows air to circulate as well as provides ideal product visibility
- Durable chrome finish ensures years of heavy-duty dependability and service
- All welded shelf construction is supported with super strong wire trusses to provide 800 lb. capacity per shelf

Bins available in: ● Blue ● Red ● Yellow ● Clear (One color per unit)

MODEL NO.	NO. OF BINS	BIN DIMENSIONS L" x W" x H"	SHIP WGT
<b>12"W x 36"L x 74"H - 9 Shelf Systems</b>			
WR9-201	64 QSB201	11-5/8" x 4-1/8" x 6"	108 lbs
WR9-202	40 QSB202	11-5/8" x 6-5/8" x 6"	100 lbs
WR9-207	32 QSB207	11-5/8" x 8-3/8" x 6"	98 lbs
WR9-209	24 QSB209	11-5/8" x 11-1/8" x 6"	96 lbs
<b>18"W x 36"L x 74"H - 9 Shelf Systems</b>			
WR9-203	64 QSB203	17-7/8" x 4-1/8" x 6"	156 lbs
WR9-204	40 QSB204	17-7/8" x 6-5/8" x 6"	142 lbs
WR9-208	32 QSB208	17-7/8" x 8-3/8" x 6"	143 lbs
WR9-210	24 QSB210	17-7/8" x 11-1/8" x 6"	140 lbs
<b>24"W x 36"L x 74"H - 9 Shelf Systems</b>			
WR9-205	64 QSB205	23-5/8" x 4-1/8" x 6"	182 lbs
WR9-206	40 QSB206	23-5/8" x 6-5/8" x 6"	171 lbs
WR9-214	32 QSB214	23-5/8" x 8-3/8" x 6"	165 lbs
WR9-216	24 QSB216	23-5/8" x 11-1/8" x 6"	154 lbs

**COMPLETE PACKAGES WITH BINS**



AVAILABLE on pg. 26

**800 lb. LOAD CAPACITY PER SHELF**



**MOBILIZE YOUR WIRE SHELVING**

**DB - Donut Bumper**  
Non-marking donut bumper used to protect walls and help cushion impact.

**WR-00H (Mobile Kit)\***  
Set of four swivel thermoplastic resin 5" x 1-1/4" casters, two with brakes. 1,200 lb. load capacity.  
*\*Mobile kits recommended only for shelves 18" and deeper.*



WR9-202

**STORE-MORE 6" Complete Bin Center**

Complete bin systems are available with 4 different size bin options on a 12"W x 36"L x 39"H unit. This all-purpose bin center is an economical high density storage system that provides easy visibility to stored contents.

Bins available in: ● Blue ● Red ● Yellow ● Clear (One color per unit)

MODEL NO.	NO. OF BINS	BIN DIMENSIONS L" x W" x H"	SHIP WGT
<b>12"W x 36"L x 36"H - 5 Shelf Systems</b>			
WR5-39-1236-201	32 QSB201	11-5/8" x 4-3/8" x 6"	61 lbs
WR5-39-1236-202	20 QSB202	11-5/8" x 6-5/8" x 6"	57 lbs
WR5-39-1236-207	16 QSB207	11-5/8" x 8-3/8" x 6"	56 lbs
WR5-39-1236-209	12 QSB209	11-5/8" x 11-1/8" x 6"	55 lbs



WR5-39-1236-201



WR9-207



WR9-209





# 12 SIZES AND 4 COLORS AVAILABLE

**CLEAR VIEW**  
AVAILABLE on pg. 28



QSB809

QSB807

QSB802

QSB801

**LOW COST, LONG LASTING,  
UNBREAKABLE, REUSABLE,  
8" HIGH BINS**



**LTR-1253**  
Clear Label Holder and Insert  
Clear label holders fit all 8" Shelf Bins.  
Package of 25.



DLT-6

### Divider Label Tab

Divider Label Tabs attach to existing dividers enabling sections of bin to be labeled. Tabs improve the visibility of bin labels and scanning of barcodes. Package of 6.

### STORE-MAX 8" Shelf Bins



Our 8" high bins offer 95% more storage capacity when compared to the standard 4" high bins and 65% more than the 6" high bins. The new STORE-MAX 8" Bins will truly maximize and organize your space. Manufactured from high density polypropylene, STORE-MAX 8" Shelf Bins are the industry standard for quality. These bins feature a molded-in label holder, built-in rear hang-lock which allows bins to tilt out for complete access when on shelving. A wide hopper front allows complete access to the contents of the bin. Edges are reinforced for added strength. They are designed for 12", 18" and 24" deep shelf units, racks, or standard shelving. Optional dividers are a perfect accessory to subdivide and keep parts separated as needed. See **pg. 23** to order Clear Bins.



### Dividers and Bin Cups

Optional black dividers fit snugly, horizontally across bins to create compartments. Each bin accepts up to 7 dividers.

Bin cups have a raised, slotted label holder for easy parts identification. The entire bin cup may be removed for easy part retrieval. Available in 2 sizes and 2 colors.

Available in: ● Blue ● Yellow

MODEL NO.	OUTSIDE DIMENSIONS L" x W" x H"	CTN QTY	CTN WGT
QBC111	3-1/4" x 1-3/4" x 3"	48	4 lbs
QBC112	5-1/8" x 2-3/4" x 3"	48	7 lbs

Available in: ● Blue ● Red ● Yellow ● Clear

MODEL NO.	OUTSIDE DIMENSIONS L" x W" x H"	INSIDE DIMENSIONS L" x W" x H"	CTN QTY	CTN WGT	DIVIDER	CTN QTY	NO. OF BIN CUPS PER BIN
QSB801	11-5/8" x 4-1/8" x 8"	10-1/6" x 3" x 8"	36	27 lbs	DSB801	50	6
QSB802	11-5/8" x 6-5/8" x 8"	10-1/6" x 5-1/2" x 8"	30	26 lbs	DSB802	50	9
QSB807	11-5/8" x 8-3/8" x 8"	10-1/6" x 7-1/8" x 8"	20	21 lbs	DSB807	50	12
QSB809	11-5/8" x 11-1/8" x 8"	10-1/6" x 10" x 8"	8	11 lbs	DSB809	50	18
QSB803	17-7/8" x 4-1/8" x 8"	16-1/2" x 3" x 8"	20	22 lbs	DSB803	50	9
QSB804	17-7/8" x 6-5/8" x 8"	16-1/2" x 5-1/2" x 8"	20	26 lbs	DSB804	50	15
QSB808	17-7/8" x 8-3/8" x 8"	16-1/2" x 7-1/8" x 8"	10	15 lbs	DSB808	50	19
QSB810	17-7/8" x 11-1/8" x 8"	16-1/2" x 10" x 8"	8	17 lbs	DSB810	50	29
QSB805	23-5/8" x 4-1/8" x 8"	22-1/8" x 3" x 8"	16	24 lbs	DSB805	50	13
QSB806	23-5/8" x 6-5/8" x 8"	22-1/8" x 5-1/2" x 8"	8	13 lbs	DSB806	50	21
QSB814	23-5/8" x 8-3/8" x 8"	22-1/8" x 7-1/8" x 8"	6	12 lbs	DSB814	50	24
QSB816	23-5/8" x 11-1/8" x 8"	22-1/8" x 10" x 8"	6	14 lbs	DSB816	50	35



**STORE-MAX 8" Shelf Bin Steel Shelving Systems - Complete Packages**

- Economical small parts storage systems keep parts easily accessible
- Open hopper front bins with label area, provide fast access to stored items
- This all-in-one unit is easy to clean and is rust and corrosion resistant
- Heavy-duty, high grade shelving offers a 400 lb. capacity per shelf
- 36" wide shelving has a smooth powder coat finish

**COMPLETE PACKAGES WITH BINS**

Bins available in: ● Blue ● Red ● Yellow ● Clear *(One color per unit)*

MODEL NO.	NO. OF BINS	BIN DIMENSIONS L" x W" x H"	SHIP WGT
<b>12"D x 36"W x 75"H - 8 Shelf Systems</b>			
1275-SB801	56 QSB801	11-5/8" x 4-3/8" x 8"	111 lbs
1275-SB802	35 QSB802	11-5/8" x 6-5/8" x 8"	103 lbs
1275-SB807	28 QSB807	11-5/8" x 8-3/8" x 8"	100 lbs
1275-SB809	21 QSB809	11-5/8" x 11-1/8" x 8"	98 lbs
<b>12"D x 36"W x 39"H - 4 Shelf Systems</b>			
1239-SB801	24 QSB801	11-5/8" x 4-3/8" x 8"	56 lbs
1239-SB802	15 QSB802	11-5/8" x 6-5/8" x 8"	52 lbs
1239-SB807	12 QSB807	11-5/8" x 8-3/8" x 8"	51 lbs
1239-SB809	9 QSB809	11-5/8" x 11-1/8" x 8"	50 lbs
<b>18"D x 36"W x 75"H - 8 Shelf Systems</b>			
1875-SB803	56 QSB803	17-7/8" x 4-3/8" x 8"	156 lbs
1875-SB804	35 QSB804	17-7/8" x 6-5/8" x 8"	141 lbs
1875-SB808	28 QSB808	17-7/8" x 8-3/8" x 8"	142 lbs
1875-SB810	21 QSB810	17-7/8" x 11-1/8" x 8"	139 lbs
<b>18"D x 36"W x 39"H - 4 Shelf Systems</b>			
1839-SB803	24 QSB803	17-7/8" x 4-3/8" x 8"	77 lbs
1839-SB804	15 QSB804	17-7/8" x 6-5/8" x 8"	70 lbs
1839-SB808	12 QSB808	17-7/8" x 8-3/8" x 8"	71 lbs
1839-SB810	9 QSB810	17-7/8" x 11-1/8" x 8"	69 lbs



AVAILABLE on pg. 29



1275-SB801

**400 lb. LOAD CAPACITY PER SHELF**



1239-SB807



1275-SB802



1275-SB809



WR8-801

## COMPLETE PACKAGES WITH BINS



AVAILABLE on pg. 29

## 800 lb. LOAD CAPACITY PER SHELF



### MOBILIZE YOUR WIRE SHELVING

**DB - Donut Bumper**  
Non-marking donut bumper used to protect walls and help cushion impact.

**WR-00H (Mobile Kit)\***  
Set of four swivel thermoplastic resin 5" x 1-1/4" casters, two with brakes. 1,200 lb. load capacity.  
*\*Mobile kits recommended only for shelves 18" and deeper.*

### STORE-MAX 8" Shelf Bin Wire Shelving Systems - Complete Packages

- Easy boltless assembly
- Wire allows air to circulate as well as provides ideal product visibility
- Durable chrome finish ensures years of heavy-duty dependability and service
- All welded shelf construction is supported with super strong wire trusses to provide 800 lb. capacity per shelf

Bins available in: ● Blue ● Red ● Yellow ● Clear (One color per unit)

MODEL NO.	NO. OF BINS	BIN DIMENSIONS L" x W" x H"	SHIP WGT
<b>12"W x 36"L x 74"H - 8 Shelf Systems</b>			
WR8-801	49 QSB801	11-5/8" x 4-3/8" x 8"	100 lbs
WR8-802	35 QSB802	11-5/8" x 6-5/8" x 8"	103 lbs
WR8-807	28 QSB807	11-5/8" x 8-3/8" x 8"	102 lbs
WR8-809	21 QSB809	11-5/8" x 11-1/8" x 8"	101 lbs
<b>18"W x 36"L x 74"H - 8 Shelf Systems</b>			
WR8-803	49 QSB803	17-7/8" x 4-3/8" x 8"	150 lbs
WR8-804	35 QSB804	17-7/8" x 6-5/8" x 8"	142 lbs
WR8-808	28 QSB808	17-7/8" x 8-3/8" x 8"	138 lbs
WR8-810	21 QSB810	17-7/8" x 11-1/8" x 8"	141 lbs
<b>24"W x 36"L x 74"H - 8 Shelf Systems</b>			
WR8-805	49 QSB805	23-5/8" x 4-3/8" x 8"	194 lbs
WR8-806	35 QSB806	23-5/8" x 6-5/8" x 8"	177 lbs
WR8-814	28 QSB814	23-5/8" x 8-3/8" x 8"	176 lbs
WR8-816	21 QSB816	23-5/8" x 11-1/8" x 8"	169 lbs

### STORE-MAX 8" Complete Bin Center

Complete bin systems are available with 4 different size bin options on a 12"W x 36"L x 39"H unit. This all-purpose bin center is an economical high density storage system that provides easy visibility to stored contents.

Bins available in: ● Blue ● Red ● Yellow ● Clear (One color per unit)

MODEL NO.	NO. OF BINS	BIN DIMENSIONS L" x W" x H"	SHIP WGT
<b>12"W x 36"L x 39"H - 4 Shelf Systems</b>			
WR4-39-1236-801	21 QSB801	11-5/8" x 4-3/8" x 8"	80 lbs
WR4-39-1236-802	15 QSB802	11-5/8" x 6-5/8" x 8"	78 lbs
WR4-39-1236-807	12 QSB807	11-5/8" x 8-3/8" x 8"	77 lbs
WR4-39-1236-809	9 QSB809	11-5/8" x 11-1/8" x 8"	77 lbs



WR8-802



WR8-809



WR4-39-1236-807



**Super Tuff Euro Drawers**



Super Tuff Euro Drawers are available in nine sizes and four colors and are designed for efficient organization of heavy parts, supplies, tools or equipment. Super Tuff Euro Drawers are injection molded from virgin grade high impact polystyrene and are virtually unbreakable. These heavy-duty drawers can be used on Quantum's open and closed shelf units and pick racks.

Available in: ● Blue ● Red ● Yellow ● Gray

MODEL NO.	OUTSIDE DIMENSIONS L" x W" x H"*	INSIDE DIMENSIONS L" x W" x H"	CTN QTY	CTN WGT	NUMBER OF DIVIDER SLOTS	DIVIDER	DIV CTN QTY
QED401	11-5/8" x 5-9/16" x 2-1/8"	10-1/4" x 5-1/8" x 2"	24	17 lbs	8	DIV401	4
QED501	11-5/8" x 3-3/4" x 4-5/8"	10-1/4" x 3-1/4" x 4-3/8"	24	19 lbs	8	DIV501/604	4
QED601	11-7/8" x 5-9/16" x 4-5/8"	10-3/4" x 5-1/8" x 4-3/8"	24	24 lbs	8	DIV6123	4
QED701	11-5/8" x 8-3/8" x 4-5/8"	10-1/4" x 7-3/4" x 4-3/8"	24	31 lbs	8	DIV701/606	4
QED801	11-5/8" x 11-1/8" x 4-5/8"	10-1/4" x 10-5/8" x 4-3/8"	12	19 lbs	8	DIV801	4
QED604	17-5/8" x 3-3/4" x 4-5/8"	16-1/2" x 3-1/4" x 4-1/4"	24	29 lbs	15	DIV501/604	4
QED602	17-3/4" x 5-9/16" x 4-5/8"	16-1/2" x 5-1/8" x 4-3/8"	24	32 lbs	13	DIV6123	4
QED606	17-5/8" x 8-3/8" x 4-5/8"	16-1/4" x 7-7/8" x 4-3/8"	24	46 lbs	13	DIV701/606	4
QED603	24" x 5-9/16" x 4-5/8"	22-5/8" x 5-1/8" x 4-3/8"	12	25 lbs	18	DIV6123	4

\*Rear tab adds an additional 3/8" to rear height

**PERFORMANCE FEATURES:**

- Available in 9 sizes
- Bins are injection molded from a virgin grade high impact polystyrene and are virtually unbreakable
- Drawers are completely waterproof
- Drawers are oil and chemical resistant
- Smooth front curved pull handle has ample room for adhesive labels or bar codes
- Front handle has 3/4" opening for convenient easy gripping
- Full width back ledge ensures spill free use
- Optional dividers are full height for subdividing bins and prevents mixing of parts
- Available in four colors ideal for color coding inventory: Blue, Yellow, Red and Gray

**9 SIZES AND 4 COLORS AVAILABLE**

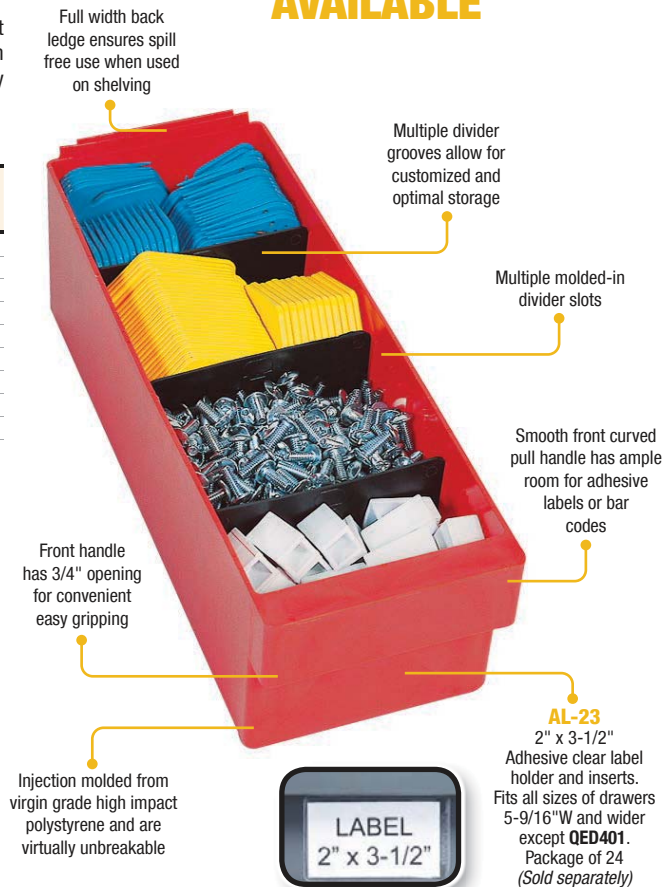

**12" Deep Euro Drawers**



**HEAVY-DUTY DRAWERS VIRTUALLY UNBREAKABLE**

**18" Deep Euro Drawers**

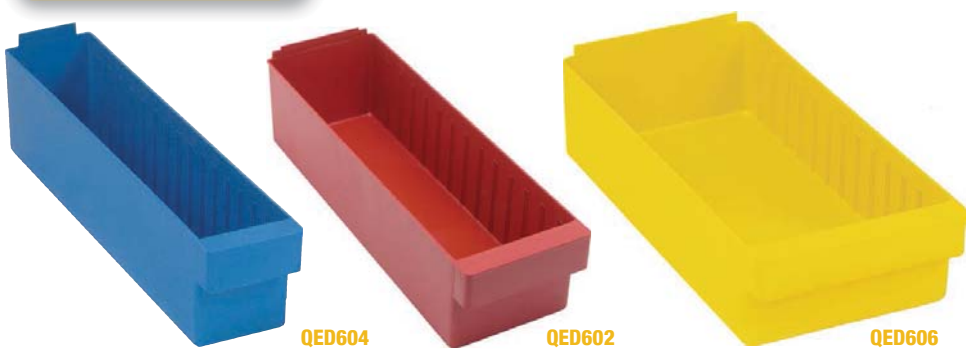

**24" Deep Euro Drawer**





Closed and Open Shelving Systems with Super Tuff Drawers - Complete Packages

Save time locating parts using our tough Euro Drawers with our sturdy open or closed steel shelving. 36" wide x 75" or 39" high units offer heavy-duty, high grade shelving with a 400 lb. capacity per shelf. Closed shelving provides a dust free environment for stored parts.



CL1875-624 Closed Unit (Complete with side and back panels)

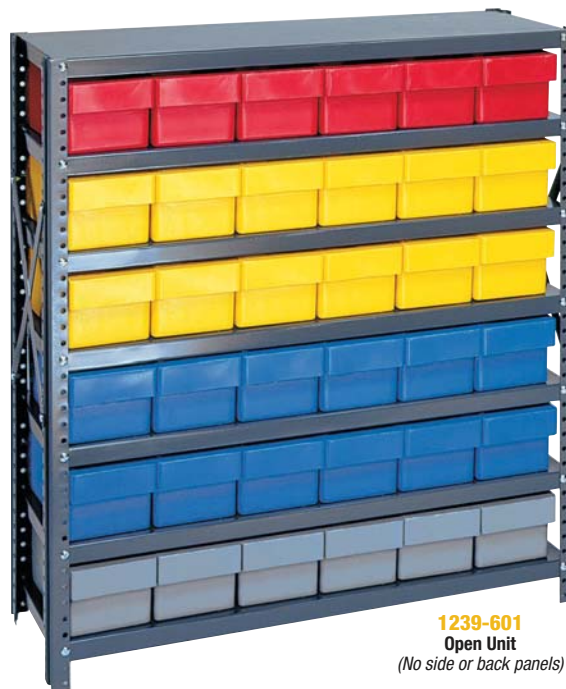

1239-601 Open Unit (No side or back panels)

COMPLETE PACKAGES WITH BINS

400 lb. LOAD CAPACITY PER SHELF

HIGH DENSITY, HEAVY-DUTY, DUST FREE AND SECURE STORAGE

MORE ECONOMICAL SOLUTION COMPARED TO HIGHER COST STEEL DRAWER UNITS

Drawers available in: Blue Yellow Red Gray (One color per unit)

CLOSED UNITS		OPEN UNITS		
MODEL NO.	MODEL NO.	BIN DIMENSIONS L" x W" x H"	NO. OF BINS	SHIP WGT
<b>12"D x 36"W x 75"H - 13 Shelf Systems</b>				
CL1275-401*	1275-401*	11-5/8" x 5-9/16" x 2-1/8"	108 QED401	231 lbs
CL1275-501	1275-501	11-5/8" x 3-3/4" x 4-5/8"	108 QED501	215 lbs
CL1275-601	1275-601	11-5/8" x 5-9/16" x 4-5/8"	72 QED601	192 lbs
CL1275-701	1275-701	11-5/8" x 8-3/8" x 4-5/8"	48 QED701	171 lbs
CL1275-801	1275-801	11-5/8" x 11-1/8" x 4-5/8"	36 QED801	189 lbs
CL1275-000	1275-000	12" Deep Steel Unit Only - No Bins		129 lbs
<b>18"D x 36"W x 75"H - 13 Shelf Systems</b>				
CL1875-602	1875-602	17-7/8" x 5-9/16" x 4-5/8"	72 QED602	266 lbs
CL1875-604	1875-604	17-7/8" x 3-3/4" x 4-5/8"	108 QED604	287 lbs
CL1875-624	1875-624	17-7/8" x 5-9/16" x 4-5/8"	36 QED602	276 lbs
		17-7/8" x 3-3/4" x 4-5/8"	54 QED604	
CL1875-606	1875-606	17-7/8" x 8-3/8" x 4-5/8"	48 QED606	237 lbs
CL1875-000	1875-000	18" Deep Steel Unit Only - No Bins		167 lbs
<b>24"D x 36"W x 75"H - 13 Shelf Systems</b>				
CL2475-603	2475-603	23-7/8" x 5-9/16" x 4-5/8"	72 QED603	360 lbs
<b>12"D x 36"W x 39"H - 7 Shelf Systems</b>				
CL1239-401**	1239-401**	11-5/8" x 5-9/16" x 2-1/8"	54 QED401	121 lbs
CL1239-601	1239-601	11-5/8" x 5-9/16" x 4-5/8"	36 QED601	99 lbs
CL1239-000	1239-000	12" Deep Steel Unit Only - No Bins		70 lbs
<b>18"D x 36"W x 39"H - 7 Shelf Systems</b>				
CL1839-602	1839-602	17-7/8" x 5-9/16" x 4-5/8"	36 QED602	139 lbs
CL1839-604	1839-604	17-7/8" x 3-3/4" x 4-5/8"	54 QED604	155 lbs
CL1839-624	1839-624	17-7/8" x 5-9/16" x 4-5/8"	18 QED602	147 lbs
		3-3/4" x 4-5/8"	27 QED604	
CL1839-000	1839-000	18" Deep Steel Unit Only - No Bins		89 lbs
<b>24"D x 36"W x 39"H - 7 Shelf Systems</b>				
CL2439-603	2439-603	23-7/8" x 5-9/16" x 4-5/8"	176 QSB101	198 lbs

\*Unit includes 19 shelves \*\*Unit includes 10 shelves



**Euro Drawer Sloped Shelving Systems - Complete Packages**

**COMPLETE PACKAGES WITH BINS**

Sturdy steel racks with Super Tuff Euro Drawers create an efficient flow system. Sloped shelving provides easy access to stored items. Drawers can be removed from racks easily. These gray colored baked enamel, free standing racks assemble easily. Mobile unit has a 1,200 lb. capacity and is equipped with 2 swivel, 2 rigid casters. One drawer color per system.



**QPRHA-601**  
Bench Pick Rack  
250 lb. capacity.

**SLOPED SHELVES, EASY ACCESS, MOST POPULAR AND VERSATILE STORAGE SYSTEMS SOLD**



**QPRS-601**  
Single Sided Pick Rack  
400 lb. capacity.

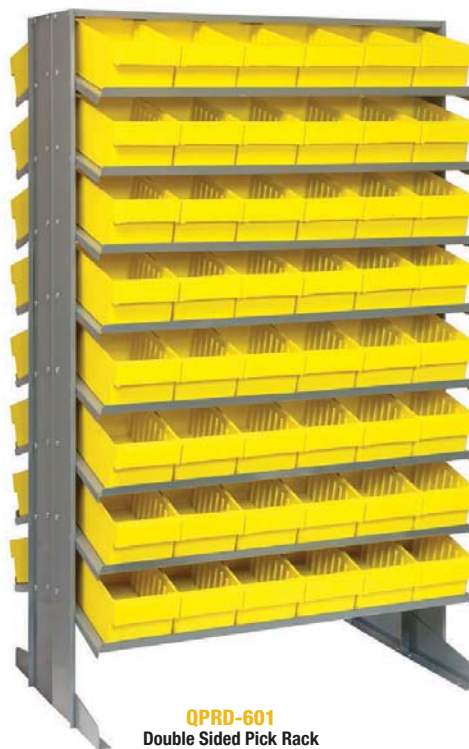

**QPRD-601**  
Double Sided Pick Rack  
800 lb. capacity.



**QPRD-601 + QDU-00**  
Mobile, Double Sided Pick Rack  
1,200 lb. load capacity. 2 rigid, 2 swivel with brake hard rubber casters.

Drawers available in: ● Blue ● Yellow ● Red ● Gray

(One color per unit)

MODEL NO.	NO. OF BINS	BIN DIMENSIONS L" x W" x H"	SHIP WGT
<b>12-1/2" L x 36" W x 23" H - 3 Shelf Bench Rack Systems</b>			
QPRHA-501	27 QED501	11-5/8" x 3-3/4" x 4-5/8"	48 lbs
QPRHA-601	18 QED601	11-5/8" x 5-9/16" x 4-5/8"	42 lbs
QPRHA-701	12 QED701	11-5/8" x 8-3/8" x 4-5/8"	42 lbs
QPRHA-567	9 QED501 6 QED601 4 QED701	11-5/8" x 3-3/4" x 4-5/8" 11-5/8" x 5-9/16" x 4-5/8" 11-5/8" x 8-3/8" x 4-5/8"	44 lbs
QPRHA-000	12-1/2" Deep Bench Rack Only - No Bins		26 lbs
<b>12" L x 36" W x 63-1/2" H - Single Sided 8 Shelf Rack Systems</b>			
QPRS-501	72 QED501	11-5/8" x 3-3/4" x 4-5/8"	110 lbs
QPRS-601	48 QED601	11-5/8" x 5-9/16" x 4-5/8"	91 lbs
QPRS-701	32 QED701	11-5/8" x 8-3/8" x 4-5/8"	95 lbs
QPRS-801	24 QED801	11-5/8" x 11-1/8" x 4-5/8"	93 lbs
QPRS-5678	18 QED501 12 QED601 8 QED701 6 QED801	11-5/8" x 3-3/4" x 4-5/8" 11-5/8" x 5-9/16" x 4-5/8" 11-5/8" x 8-3/8" x 4-5/8" 11-5/8" x 11-1/8" x 4-5/8"	99 lbs
QPRS-000	12" Deep Single Sided Rack Only - No Bins		53 lbs
<b>18" L x 36" W x 63-1/2" H - Single Sided 8 Shelf Rack Systems</b>			
QPRS-604	72 QED604	17-7/8" x 3-3/4" x 4-5/8"	165 lbs
QPRS-602	48 QED602	17-7/8" x 5-9/16" x 4-5/8"	142 lbs
QPRS-606	32 QED606	17-7/8" x 8-3/8" x 4-5/8"	139 lbs
QPRS18-000	18" Deep Single Sided Rack Only - No Bins		78 lbs
<b>24" L x 36" W x 60" H - Double Sided 16 Shelf Rack Systems</b>			
QPRD-501	144 QED501	11-5/8" x 3-3/4" x 4-5/8"	220 lbs
QPRD-601	96 QED601	11-5/8" x 5-9/16" x 4-5/8"	190 lbs
QPRD-701	64 QED701	11-5/8" x 8-3/8" x 4-5/8"	189 lbs
QPRD-801	48 QED801	11-5/8" x 11-1/8" x 4-5/8"	186 lbs
QPRD-5678	36 QED501 24 QED601 16 QED701 12 QED801	11-5/8" x 3-3/4" x 4-5/8" 11-5/8" x 5-9/16" x 4-5/8" 11-5/8" x 8-3/8" x 4-5/8" 11-5/8" x 11-1/8" x 4-5/8"	197 lbs
QPRD-000	24" (12" on each side) Deep Double Sided Rack Only - No Bins		106 lbs
QDU-00*	Mobile Kit - Mobilizes All 24" Deep Double Sided Units		25 lbs
<b>36" L x 36" W x 60" H - Double Sided 16 Shelf Rack Systems</b>			
QPRD-604	144 QED604	17-7/8" x 3-3/4" x 4-5/8"	330 lbs
QPRD-602	96 QED602	17-7/8" x 5-9/16" x 4-5/8"	284 lbs
QPRD-606	64 QED606	17-7/8" x 8-3/8" x 4-5/8"	279 lbs
QPRD18-000	36" (12" on each side) Deep Double Sided Rack Only - No Bins		156 lbs
QDU-18*	Mobile Kit - Mobilizes All 36" Deep Double Sided Units		35 lbs

\*1,200 lb. load capacity. 2 rigid, 2 swivel with brake hard rubber casters.

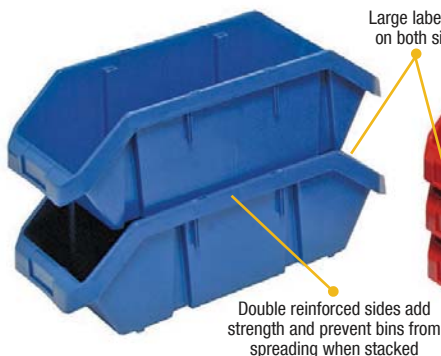

### STACK 'EM

Double reinforced sides add strength and prevent bins from spreading when stacked

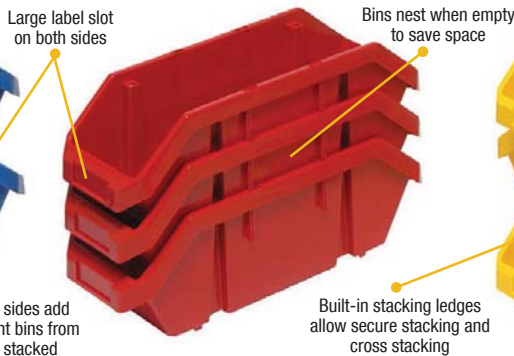

### NEST 'EM

Bins nest when empty to save space



### CROSS STACK 'EM

Built-in stacking ledges allow secure stacking and cross stacking



QP1265  
Shown with optional Dividers CD1265/LD1265

Create up to 4 Compartments

QuickPick Bin



## 6 SIZES AND 3 COLORS AVAILABLE

Dividers

These heavy-duty, polypropylene storage bins provide an open hopper front and back, allowing double sided access to stored parts. Bins stack one on top of the other, both vertically and cross-wise, and nest when empty for space efficiency. Optional dividers may be used front to back, side to side, or both at the same time, dividing the bin into four sections. A molded in label holder on both the front and back of the bin allows for easy parts identification. Bins can be used on standard metal or wire shelving as well as on desks, bench tops or work stations.

Available in: ● Blue ● Red ● Yellow

MODEL NO.	DIMENSIONS L" x W" x H"	X"*	CTN QTY	CTN WGT	CROSS DIVIDER	CTN QTY	LENGTH DIVIDER	CTN QTY	CLEAR LABEL HOLDER & INSERT
QP965	9-1/2" x 6-5/8" x 5"	6"	20	15 lbs	CD965	10	LD965	10	LTR-1253
QP1265	12-1/2" x 6-5/8" x 5"	9"	20	19 lbs	CD1265	10	LD1265	10	LTR-1253
QP1285	12-1/2" x 8-3/8" x 5"	9"	20	22 lbs	CD1285	10	LD1285	10	LTR-1253
QP1496	14" x 9-1/4" x 6-1/2"	8-1/8"	20	26 lbs	CD1496	10	LD1496	10	LTR-1253
QP1867	18-1/2" x 6-5/8" x 7"	13-1/8"	10	16 lbs	CD1867	10	LD1867	10	LTR-1253
QP1887	18-1/2" x 8-3/8" x 7"	13-1/8"	10	18 lbs	CD1887	10	LD1887	10	LTR-1253

\*X" dimensions is inside flat bottom length



**LTR-1253 Clear Label Holder & Insert**  
Clear label holders and laser label inserts. Fits all QuickPick Bins. Package of 25.

Optional dividers may be used front to back, side to side or both at the same time, dividing the bin into four sections.

## THE MOST VERSATILE BIN IN THE INDUSTRY WITH DOUBLE SIDED ACCESS

### Heavy-Duty Wire Shelving with QuickPick Bins - Complete Packages

These unique shelving packages provide double sided access to stored parts. QuickPick Bins allow two users to access stored product at the same time. This ergonomic, space efficient work station is the ultimate space saver. Shelving systems measure 18"W x 36"L x 74"H and may be ordered with or without a mobile kit. These heavy-duty systems offer an 800 lb. capacity per shelf. Optional dividers may be used front to back, side to side or both at the same time, dividing the bin into four sections. A molded in label holder on both the front and back of the bin allows for easy part identification.

Bins available in: ● Blue ● Red ● Yellow (One color per unit)

MODEL NO.	NO. OF BINS	DIMENSIONS L" x W" x H"	SHIP WGT
W7-12-30	30 QP1265	12-1/2" x 6-5/8" x 5"	110 lbs
W7-12-26	10 QP1265	12-1/2" x 6-5/8" x 5"	107 lbs
	16 QP1285	12-1/2" x 8-3/8" x 5"	
W7-12-28	20 QP1265	12-1/2" x 6-5/8" x 5"	109 lbs
	8 QP1285	12-1/2" x 8-3/8" x 5"	
W7-12-24	24 QP1285	12-1/2" x 8-3/8" x 5"	106 lbs
W7-14-18	18 QP1496	14" x 9-1/4" x 6-1/2"	105 lbs
W7-18-30	30 QP1867	18-1/2" x 6-5/8" x 7"	128 lbs
W7-18-26	10 QP1867	18-1/2" x 6-5/8" x 7"	125 lbs
	16 QP1887	18-1/2" x 8-3/8" x 7"	
W7-18-28	20 QP1867	18-1/2" x 6-5/8" x 7"	127 lbs
	8 QP1887	18-1/2" x 8-3/8" x 7"	
W7-18-24	24 QP1887	18-1/2" x 8-3/8" x 7"	124 lbs
<b>Mobile Kit</b>			
WR-00H*	Mobilizes Wire Shelving Unit		14 lbs

\*Set of four swivel thermoplastic resin 5" x 1-1/4" casters, two with brakes. 1,200 lb. load capacity. Mobile Kits recommended only for shelves 18" and deeper.

## 800 lb. LOAD CAPACITY PER SHELF



W7-12-26



WRC3-1836-1867

### QuickPick Bin Mobile Wire Cart

Carts are available in a 2 or 3 shelf configuration complete with four casters (all swivel, two with brakes). Overall dimensions: 18"W x 36"L x 37-1/2"H. Mobile cart is easy to assemble. One color per cart.

Bins available in: ● Blue ● Red ● Yellow (One color per unit)

MODEL NO.	NO. OF BINS	DIMENSIONS L" x W" x H"	CTN WGT
WRC2-1836-1265	10 QP1265	12-1/2" x 6-5/8" x 5"	49 lbs
WRC3-1836-1265	15 QP1265	12-1/2" x 6-5/8" x 5"	64 lbs
WRC2-1836-1285	8 QP1285	12-1/2" x 8-3/8" x 5"	48 lbs
WRC3-1836-1285	12 QP1285	12-1/2" x 8-3/8" x 5"	63 lbs
WRC2-1836-1867	10 QP1867	18-1/2" x 6-5/8" x 7"	55 lbs
WRC3-1836-1867	15 QP1867	18-1/2" x 6-5/8" x 7"	73 lbs
WRC2-1836-1887	8 QP1887	18-1/2" x 8-3/8" x 7"	54 lbs
WRC3-1836-1887	12 QP1887	18-1/2" x 8-3/8" x 7"	72 lbs



**Latch Containers & Wire Shelving System - Complete Packages**



Quantum's new Latch Containers feature heavy-duty latches on each end that snap lock providing a tight and secure fit. Once latch is engaged parts inside are fully protected from dirt or getting wet. These durable and ultra-strong containers can hold up to 75 lbs. Injection molded from durable, high impact polypropylene. Lids feature reinforced ribs that allow totes to safely and securely stack on top of each other.

Available in: ● Black ● Clear

MODEL NO.	OUTSIDE DIMENSIONS L" x W" x H"	INSIDE TOP DIMENSIONS L" x W" x H"	INSIDE BOTTOM DIMENSIONS L" x W"	CAP GAL	CTN QTY	CTN WGT LBS	CTN LID	CTN QTY
<b>LC191507</b> <small>NEW</small>	21" x 15-7/8" x 7-3/4"	18-3/8" x 14-5/8" x 7-1/4"	15-7/8" x 12-7/8"	7.03	6	12 lbs	<b>LID1915</b>	6
<b>LC191507CL</b> <small>NEW</small>	21" x 15-7/8" x 7-3/4"	18-3/8" x 14-5/8" x 7-1/4"	15-7/8" x 12-7/8"	7.03	6	12 lbs	<b>LID1915CL</b>	6



**LC191507CL and LID1915CL**

**NEW**

**CONTAINERS HOLD UP TO 75 lbs.**



**LID1915 and LID1915CL**  
Latch Container Lid



**LC191507 and LID1915**



**LC191507CL**  
Containers Nesting



**LC191507CL and LID1915CL**  
Containers Stacked with Lid



**WR6-191507CL**  
21"W x 36"L x 74"H  
6 shelves with 12 **LC191507CL**  
and 12 **LID1915CL**



**WR6-191507**  
21"W x 36"L x 74"H  
6 shelves with 12 **LC191507**  
and 12 **LID1915**



**MOBILIZE YOUR WIRE SHELVING**

**DB - Donut Bumper**  
Non-marking donut bumper used to protect walls and help cushion impact.

**WR-00H (Mobile Kit)\***  
Set of four swivel thermoplastic resin 5" x 1-1/4" casters, two with brakes. Can be used with all units shown. 1,200 lb. load capacity. \*Mobile kits recommended only for shelves 18" and deeper.





# 11 SIZES AND 4 COLORS AVAILABLE



### DIVIDERS

Containers can be divided by length and/or width allowing a subdivision down to a 1-1/8" square compartment size. Available in Gray.



### SNAP ON COVERS

Snap on covers protect contents from damage or dust during shipping and storage.



### CLEAR LABEL HOLDER

Fits any size container. Three sizes to choose from. Attach via Velcro fastening.

**NEW SIZES**

**NEW**  
DG92050

**NEW**  
DG91025



## Dividable Grid Containers



DG92060  
Shown with optional Clear Label Holder



Heavy-duty Dividable Grid Containers can be used in industrial, commercial, electronic and health care industries for storage, assembly, fabrication and distribution applications. These containers offer the safest and most efficient method for compartmentalizing and protecting small to medium sized parts. Dividers allow you to customize the container's interior to meet your exact needs. Containers and covers are available in 4 colors.

Available in: ● Blue ● Gray ● Red ● Clear

MODEL NO.	OUTSIDE DIMENSIONS L" x W" x H"	INSIDE DIMENSIONS L" x W" x H"	CTN QTY	CTN WGT	LONG DIVIDER	CTN QTY	SHORT DIVIDER	CTN QTY	COVER	CTN QTY
DG91025 <b>NEW</b>	10-7/8" x 8-1/4" x 2-1/2"	9-3/16" x 6-9/16" x 2"	20	16 lbs	DL91025	6	DS91025	6	COV91000	10
DG91035	10-7/8" x 8-1/4" x 3-1/2"	9-3/16" x 6-9/16" x 3"	20	24 lbs	DL91035	6	DS91035	6	COV91000	10
DG91050	10-7/8" x 8-1/4" x 5"	9-3/16" x 6-9/16" x 4-1/2"	20	32 lbs	DL91050	6	DS91050	6	COV91000	10
DG92035	16-1/2" x 10-7/8" x 3-1/2"	14-7/8" x 9-1/4" x 3"	12	23 lbs	DL92035	6	DS92035	6	COV92000	4
DG92050 <b>NEW</b>	16-1/2" x 10-7/8" x 5"	14-7/8" x 9-1/4" x 4-1/2"	12	25 lbs	DL92050	6	DS92050	6	COV92000	4
DG92060	16-1/2" x 10-7/8" x 6"	14-7/8" x 9-1/4" x 5-1/2"	8	20 lbs	DL92060	6	DS92060	6	COV92000	4
DG92080	16-1/2" x 10-7/8" x 8"	14-7/8" x 9-1/4" x 7-1/2"	8	27 lbs	DL92080	6	DS92080	6	COV92000	4
DG93030	22-1/2" x 17-1/2" x 3"	20-5/8" x 15-5/8" x 2-1/2"	6	20 lbs	DL93030	6	DS93030	6	COV93000	3
DG93060	22-1/2" x 17-1/2" x 6"	20-5/8" x 15-5/8" x 5-1/2"	3	16 lbs	DL93060	6	DS93060	6	COV93000	3
DG93080	22-1/2" x 17-1/2" x 8"	20-5/8" x 15-5/8" x 7-1/2"	3	19 lbs	DL93080	6	DS93080	6	COV93000	3
DG93120	22-1/2" x 17-1/2" x 12"	20-5/8" x 15-5/8" x 11-1/2"	3	23 lbs	DL93120	6	DS93120	6	COV93000	3

**CLEAR VIEW**  
AVAILABLE on pg. 31



DG92060  
Shown with optional Clear Dust Cover Acrylic Inlay

## Clear Dust Cover Acrylic Inlays

Clear Acrylic Dust Cover Inlays keep stored items visible while protecting against airborne dust and other contaminants. Cover lays inside on recessed rim of container.

MODEL NO.	FITS BIN MODEL NO.	CTN QTY
DDC91000CL	DG91025, DG91035, DG91050	10
DDC92000CL	DG92035, DG92050, DG92060, DG92080	4
DDC93000CL	DG93030, DG93060, DG93080, DG93120	3



DG92060 and DG93060  
Shown with optional Dividers and Clear Covers

## Clear Label Holders

MODEL NO.	DIMENSIONS H" x W"	FITS BIN MODEL NO.	CTN QTY
LBL2X8	2" x 8"	DG91025, DG91035, DG92035, DG93030	6
LBL3X5	3" x 5"	DG91050, DG92050, DG92060, DG93060	6
LBL5X8	5" x 8"	DG92080, DG93080, DG93120	6

## Clear Covers

MODEL NO.	FITS BIN MODEL NO.	CTN QTY
COV91000CL	DG91025, DG91035, DG91050	10
COV92000CL	DG92035, DG92050, DG92060, DG92080	4
COV93000CL	DG93030, DG93060, DG93080, DG93120	3



AVAILABLE on pg. 30

## 9 SIZES AND 4 COLORS AVAILABLE



### Genuine stack and nest totes



**NEW**  
**CLEAR COLOR**

See pg. 30

These heavy-duty, tough, and dependable stack and nest totes are the ultimate reusable container for storing and transporting your valuable items in any application. These proven containers are available in nine sizes and three colors for efficiency and inventory control.

Available in: ● Blue ● Gray ● Red ● Clear

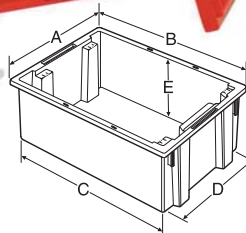

**Bin Inside Dimensions Guide**  
A (top width) B (top length) E (height)  
C (bottom length) D (bottom width)



#### snh010

All nine sizes of totes have ability to use our optional 3" x 5" clear label holder. It securely attaches to tote with or without lid for easy part identification.



#### AL-35

3" x 5" Clear Adhesive Label Holder and Inserts attaches securely to container for easy part identification. Package of 24.



Optional lid snaps on tightly and securely to protect container contents. As pictured, lids can be fastened and locked for added security.

MODEL NO.	OUTSIDE DIMENSIONS L" x W" x H"	A	B	C	D	E	CAPACITY (CU FT)	CTN QTY	CTN WGT	LID	CTN QTY		
snt180	18" x 11" x 6"	10"	16"	15-1/4"	9-3/8"	5-7/8"	0.50	6	12 lbs	LID181	6		
snt185	18" x 11" x 9"	10"	16"	15-1/8"	9-1/8"	8-7/8"	0.76	6	15 lbs	LID181	6		
snt190	19-1/2" x 15-1/2" x 10"	14-1/2"	17"	16"	13-1/4"	9-7/8"	1.20	6	23 lbs	LID191	6		
snt195	19-1/2" x 15-1/2" x 13"	14-1/2"	17"	15-7/8"	13-3/8"	12-7/8"	1.70	6	26 lbs	LID191	6		
snt200	19-1/2" x 13-1/2" x 8"	12-3/8"	17-7/8"	16-3/8"	11-1/2"	7-7/8"	0.80	6	19 lbs	LID201	6		
snt225	23-1/2" x 19-1/2" x 10"	18-1/4"	20-7/8"	19-3/8"	16-7/8"	9-7/8"	2.00	3	18 lbs	LID231	3		
snt230	23-1/2" x 19-1/2" x 13"	18-1/8"	20-7/8"	19-1/2"	16-7/8"	12-7/8"	2.60	3	22 lbs	LID231	3		
snt240	23-1/2" x 15-1/2" x 12"	14-1/4"	20-7/8"	19-5/8"	13"	11-7/8"	1.70	3	18 lbs	LID241	3		
snt300	29-1/2" x 19-1/2" x 15"	18-1/4"	26-5/8"	25-1/8"	16-5/8"	14-7/8"	3.70	3	31 lbs	LID301	3		
snh010	Clear Label Holder - 3" x 5" (Fits all tote sizes)										6	1 lb	-

### stack and nest totes PERFORMANCE FEATURES:

- Available in 9 sizes
- Standard colors: Blue, Gray and Red
- Totes are injection molded from high-density polypropylene material and are manufactured from FDA and USDA approved materials
- stack and nest totes will not corrode, bend out of shape, are unaffected by chemicals and are waterproof
- Reusable container will stack with or without lids for maximum storage and shipping
- snt's have the unique ability to stack or they can be turned 180° to nest when empty saving valuable space
- Optional lids for totes can be secured with nylon ties
- Textured bottoms ensure safe and easy, non-slip grip in transit on conveyors

### LIGHTWEIGHT, HEAVY-DUTY HDPE SIMPLE SNAP-TOGETHER DESIGN

#### Polymer Dunnage Rack

MODEL NO.	DIMENSIONS W" x L" x H"	SHIP WGT
<b>Ventilated Top</b>		
362412DPP	24" x 36" x 12"	13 lbs
363612DPP	36" x 36" x 12"	22 lbs
482412DPP	24" x 48" x 12"	19 lbs
662412DPP	24" x 66" x 12"	23 lbs
663612DPP	36" x 66" x 12"	37 lbs
962412DPP	24" x 96" x 12"	34 lbs
963612DPP	36" x 96" x 12"	53 lbs
<b>Solid Top</b>		
362412DPS	24" x 36" x 12"	17 lbs
363612DPS	36" x 36" x 12"	26 lbs
482412DPS	24" x 48" x 12"	21 lbs
662412DPS	24" x 66" x 12"	28 lbs
663612DPS	36" x 66" x 12"	49 lbs
962412DPS	24" x 96" x 12"	41 lbs
963612DPS	36" x 96" x 12"	64 lbs



Polymer Dunnage Rack

### 500-2,700 lb. LOAD CAPACITY

For more detailed info See pg. 129



Ventilated Top



**Chrome Wire Shelving System with Genuine stack and nest totes**

Offering 600-800 lb. load capacity per shelf, this chrome wire shelving system with totes is a must have for archival storage, heavy-duty parts organization or inventory control applications. With three packages to choose from offering three colors choices for the bins, this system can be used just about anywhere. System may be made mobile with the addition of the **WR-00H** mobile kit. See *pg. 66* for additional information and to order optional accessories.

**600-800 lb. LOAD CAPACITY PER SHELF**

MODEL NO.	NO. OF SHELVES	NO. OF BINS	BIN DIMENSIONS L" x W" x H"	SHIP WGT
<b>18"W x 48"L x 74"H - Wire Shelving Systems with stack and nest totes - Totes are available in Gray, Blue, Red and Clear</b>				
<b>WR9-36180</b>	9	36 snt180	18" x 11" x 6"	178 lbs
<b>WR6-24185</b>	6	24 snt185	18" x 11" x 9"	136 lbs
<b>24"W x 66"L x 63"H - Wire Shelving System with stack and nest totes - Totes are available in Gray, Blue, Red and Clear</b>				
<b>WR4-12225</b>	4	12 snt225	23-1/2" x 19-1/2" x 10"	170 lbs



AVAILABLE on *pg. 30*

**WR9-36180**  
Shown with optional lid and label holders (Sold separately)



**MOBILIZE YOUR WIRE SHELVING**

**DB - Donut Bumper**

Non-marking donut bumper used to protect walls and help cushion impact.

**WR-00H (Mobile Kit)**

Set of four swivel thermoplastic resin 5" x 1-1/4" casters, two with brakes. Can be used with all units shown. 1,200 lb. load capacity.

**Chrome Mobile Wire Shelving Systems with Cross Stack Tubs & Quantub Nesting Tote**

These unique packages provide a storage solution for large, bulky items. These heavy-duty tubs provide easy access to stored parts for assembly areas, picking stations or inventory control. With three packages to choose from, these strong durable totes provide a durable solution for most applications. See *pg. 68* for more information.

MODEL NO.	NO. OF SHELVES	NO. OF BINS	BIN DIMENSIONS L" x W" x H"	SHIP WGT
<b>24"W x 60"L x 69"H - Mobile, Wire Shelving System with QuanTub Totes - Totes are available in Gray and Blue</b>				
<b>MWR4-2419-9</b>	4	12 TUB2419-9	24-1/2" x 19" x 9-1/2"	175 lbs
<b>18"W x 36"L x 69"H - Mobile, Wire Shelving System with Cross Stack Tubs - Tubs are available in Gray, Blue and White</b>				
<b>MWR7-1711-8</b>	7	24 TUB1711-8	17-1/4" x 11" x 8"	151 lbs
<b>MWR5-1711-12</b>	5	15 TUB1711-12	17-1/4" x 11" x 12"	118 lbs

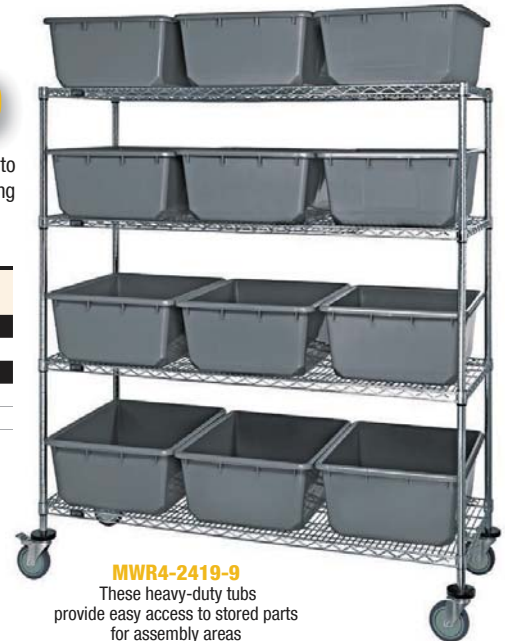

**MWR4-2419-9**

These heavy-duty tubs provide easy access to stored parts for assembly areas

**COMPLETE PACKAGES WITH BINS**

**WR7-92080**  
Allow for multiple compartment configurations within each bin



**Chrome Wire Shelving System with Dividable Grid Containers**

Same durable chrome wire shelving combined with Quantum's Dividable Grid Containers. These containers allow for multiple compartment configurations within each bin. Offering four different packages, these systems are ideal for small and medium parts storage. System may be made mobile with the addition of the **WR-00H** mobile kit. See *pg. 65* for additional container information and to order optional container accessories.

**600-800 lb. LOAD CAPACITY PER SHELF**

MODEL NO.	NO. OF SHELVES	NO. OF BINS	BIN DIMENSIONS L" x W" x H"	SHIP WGT
<b>18"W x 48"L x 74"H - Wire Shelving Systems with Dividable Grid Containers - Containers are available in Gray, Blue, Red and Clear</b>				
<b>WR9-92060</b>	9	36 DG92060	16-1/2" x 10-7/8" x 6"	210 lbs
<b>WR7-92080</b>	7	24 DG92080	16-1/2" x 10-7/8" x 8"	174 lbs
<b>24"W x 60"L x 63"H - Wire Shelving System with Dividable Grid Containers - Containers are available in Gray, Blue, Red and Clear</b>				
<b>WR12-93030</b>	12	36 DG93030	22-1/2" x 17-1/2" x 3"	274 lbs
<b>WR9-93060</b>	9	24 DG93060	22-1/2" x 17-1/2" x 6"	254 lbs



AVAILABLE on *pg. 31*



**Cross Stack Tub**



**5 SIZES AND 5 COLORS AVAILABLE**

Manufactured from approved USDA/FDA materials, totes nest when empty or can be turned 90° to cross stack. Easy access to items when stacked. Injection molded from durable, high impact polypropylene. Easy to clean. Built in handle grips and bottom grooves makes handling easy. Holds up to 100 lbs. per bin 1/4" drill hole pattern on bottom of bin allows for easy hole insertion for optional drainage and air flow.

Available in: ● Blue ● Gray ○ White **TUB2516-8/LID2516-8** also available in: ● Red ● Yellow

MODEL NO.	OUTSIDE DIMENSIONS L" x W" x H"	INSIDE BOTTOM DIMENSIONS L" x W"	CAP GAL	CTN QTY	CTN WGT	LID	CTN QTY
<b>TUB1711-8</b>	17-1/4" x 11" x 8"	13" x 7-1/2"	3.85	6	14 lbs	<b>LID1711</b>	6
<b>TUB1711-12</b>	17-1/4" x 11" x 12"	12-5/8" x 7"	5.51	6	17 lbs	<b>LID1711</b>	6
<b>TUB2417-8</b>	23-3/4" x 17-1/4" x 8"	19-5/8" x 13-3/4"	9.81	6	25 lbs	<b>LID2417</b>	6
<b>TUB2417-12</b>	23-3/4" x 17-1/4" x 12"	18-7/8" x 13-1/4"	14.38	6	30 lbs	<b>LID2417</b>	6
<b>TUB2516-8</b>	25-1/8" x 16" x 8-1/2"	20-1/2" x 13-3/8"	9.75	6	20 lbs	<b>LID2516-8</b>	6
<b>SNH010</b>	Six Clear Label Holders - 3" x 5"		6	1 lb	-	-	-

**NEW COLORS**



**TUB2516-8**  
Nesting and Cross Stack

**NEW COLORS**



**LID2516-8**

Optional lid keeps stored items dust free. Tubs can still stack or cross stack with lids in place.

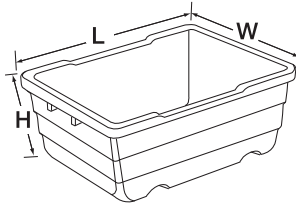

**Bin Dimensions Guide**  
L (length) W (width) H (height)

**QuanTub Nesting Tote**



Manufactured of approved USDA/FDA materials, this tote is ideal in food service and storage and general product handling. Strong and durable tote is injection molded from high-density polypropylene. Each tote can hold up to 100 lbs. Tote is easy to clean. Rolled top rim for comfortable grip. Rounded corners add strength to stress points. Totes nest when empty and prevent jamming with rib top. 1/4" drill hole pattern on bottom of bin allows for easy hole insertion for optional air flow and drainage.

Available in: ● Blue ● Gray

MODEL NO.	OUTSIDE DIMENSIONS L" x W" x H"	INSIDE BOTTOM DIMENSIONS A" x B"	CAP GAL	CTN QTY	CTN WGT
<b>TUB2419-9</b>	24-1/2" x 19" x 9-1/2"	20-1/4" x 15-1/4"	14.6	6	33 lbs



**TUB2419-9**  
Nesting

**Polymer Dolly**

**DLY-3018** is 30"L x 18"W with padded rubber trim, available in Blue. Set of four 4" x 1-1/4" non-marking swivel poly casters. 1,000 lb. load capacity.

MODEL NO.	DESCRIPTION	CTN WGT
<b>DLY-3018</b>	Dolly with Padded Rubber Trim	19 lbs
<b>HANDLE-DLY</b>	32" Dolly Pull Rod with Handle	2 lbs



**ATTACHED PULL RING**  
allows dolly to be pulled with ease



**HANDLE-DLY**  
Dolly Pull Rod



### Tub Racks - Complete Packages

All-welded aluminum Tub Rack transports and stores all types of product. Cart comes with four swivel 5" x 1" Polyolefin casters. Runners allow bins to slide in and out from both sides. Rack comes complete with tubs.

Tubs available in: ● Blue ● Gray ○ White ● Red ● Yellow

MODEL NO.	DIMENSIONS L" x W" x H"	NO. OF BINS	SHIP WGT
<b>Tub Rack with Cross Stack Tubs</b>			
<b>Tub Dimensions 25-1/8"L x 16"W x 8-1/2"H</b>			
TR1-2516-8	27" x 19" x 19"	1	13 lbs
TR2-2516-8	27" x 19" x 31"	2	25 lbs
TR3-2516-8	27" x 19" x 41"	3	33 lbs
TR4-2516-8	27" x 19" x 51"	4	46 lbs
TR5-2516-8	27" x 19" x 61"	5	54 lbs
TR6-2516-8	27" x 19" x 71"	6	58 lbs
TR12-2516-8	27" x 37" x 71"	12	114 lbs



**NEW**  
COLORS &  
12 TUB RACK

**EACH BIN LEVEL WILL SUPPORT UP TO 60 lbs.**  
*(One Tub extended at a time)*

**COMPLETE PACKAGES WITH BINS**



**TR1-2516-8**  
Comes with 1 TUB2516-8

**TR2-2516-8**  
Comes with 2 TUB2516-8

**TR3-2516-8**  
Comes with 3 TUB2516-8

**TR4-2516-8**  
Comes with 4 TUB2516-8

**TR5-2516-8**  
Comes with 5 TUB2516-8

**TR6-2516-8**  
Comes with 6 TUB2516-8



**Stackers - Heavy-Duty Straight Wall Stacking Container**

Heavy-duty, straight wall containers maximize your space when used for shipping, storage or work-in progress. Greater strength and durability provided by reinforced corners allowing this strong container to hold the heaviest of parts. Containers are injection molded from high-density polyethylene. Straight wall design allows for modular stacking of all sizes on standard pallets. Hand grips on two sides make the container easy to handle and carry. Up to 175 lb. stack capacity.

Available in: ● Gray

MODEL NO.	OUTSIDE DIMENSIONS L" x W" x H"	INSIDE DIMENSIONS L" x W" x H"	CTN QTY	VOLUME (CU FT)	SHIP WGT	LID
<b>RS01207-5</b>	12" x 7-1/2" x 5"	9-3/4" x 5-1/2" x 4-7/8"	1	0.1	2 lbs	-
<b>RS01215-5</b>	12" x 15" x 5"	9-1/2" x 13" x 4-7/8"	1	0.3	2 lbs	<b>LID1215</b>
<b>RS01215-7</b>	12" x 15" x 7-1/2"	9-1/2" x 13" x 7"	1	0.5	3 lbs	<b>LID1215</b>
<b>RS02415-5</b>	24" x 15" x 5"	21-1/2" x 13" x 4-7/8"	1	0.7	4 lbs	<b>LID2415</b>
<b>RS02415-7</b>	24" x 15" x 7-1/2"	21-1/2" x 13" x 7"	1	1.1	5 lbs	<b>LID2415</b>
<b>RS02415-9</b>	24" x 15" x 9-1/2"	21-1/2" x 13" x 9"	1	1.4	5 lbs	<b>LID2415</b>
<b>RS02422-11*</b>	24" x 22-1/2" x 11"	21-1/2" x 20-1/2" x 10-1/4"	1	3.5	8 lbs	-

\*Cannot be used on DLY-2415. Use with DLY-3018 Dolly.

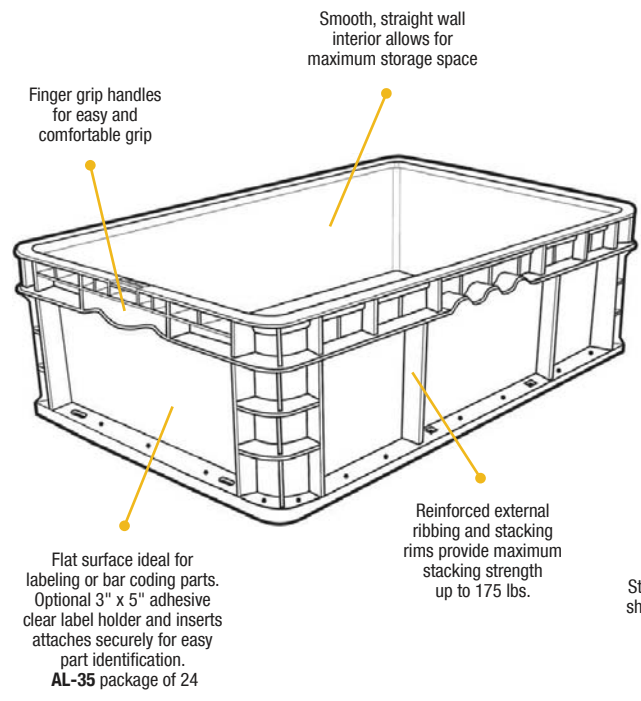

**RS02422-11**

Straight Wall container shown with optional lid **LID2415** (Sold separately)



**DLY-2415**  
Interior Dimensions 24" L x 15" W  
Exterior Dimensions 28" L x 18-1/2" W

**MOBILIZE YOUR BINS**

**Polymer Dollies**

**DLY-2415** is 24"L x 15"W with 1" Ledge, available in Black.  
**DLY-3018** is 30"L x 18"W with padded rubber trim, available in Blue.  
 Set of four 4" x 1-1/4" non-marking swivel poly casters.  
 Both dollies have 1,000 lb. load capacity.

MODEL NO.	DESCRIPTION	CTN WGT
<b>DLY-2415</b>	Dolly with 1" Ledge	14 lbs
<b>DLY-3018</b>	Dolly with Padded Rubber Trim	19 lbs

Bins sold separately



Stronger corner design means increased durability which translates to fewer damaged containers

Secure plastic hinges make containers safer to handle and easier to recycle at end-of-life

### 9 SIZES AVAILABLE



**PLASTIC HINGE**  
**NEW** generation plastic hinge



### Polymer Dolly

**DLY-2415** Dolly with 1" Ledge, available in Black. 1,000 lb. load capacity. Interior Dimensions 24"L x 15"W Exterior Dimensions 28"L x 18-1/2"W

MODEL NO.	DESCRIPTION	CTN WGT
<b>DLY-2415</b>	Dolly with 1" Ledge	14 lbs

Bins sold separately



### QDL-2115

Distribution container has an optional 3" x 5" adhesive clear label holder and insert which attaches securely for easy part identification. Package of 24.



### CUSTOM COLORS AVAILABLE

call for details



### HOT STAMPING AVAILABLE

call for details

### STRONG, RELIABLE, REUSABLE TOTES

Enhanced nesting lug increases strength when stacking nested containers

Redesigned lid features additional ribbing in critical impact areas

### NEW STRONGER DESIGN

### Heavy-Duty Attached Top Containers - Perfect for distribution and supply centers



Strong, reliable and reusable totes are ideal for storage, distribution and order picking. Tops are permanently attached with hinges that interlock for stacking strength and security. Stack for maximized storage and nest when empty. Textured, non-slip bottom ensures smooth conveying. Ergonomically designed handles allow for easy lifting. Recessed lids ensure maximum load stability. Padlock eye provides security option allowing lids to be fastened and/or locked. Molded from high density, FDA approved polyethylene. Lids close securely to protect parts from dust or damage.

MODEL NO.	OUTSIDE DIMENSIONS		INSIDE DIMENSIONS		CONTAINER HEIGHT	VOLUME (CU FT)	CAPACITY GAL	STACK CAP/ QTY STACKED	SHIP WGT
	TOP L" x W"	BOTTOM L" x W"	TOP L" x W"	BOTTOM L" x W"					
<b>QDC2012-7</b>	19-5/8" x 11-9/16"	17" x 9-1/4"	17-9/16" x 9-13/16"	16-1/4" x 8-5/8"	7-1/2"	0.50	8.75	45 lbs/7	4 lbs
<b>QDC2115-9</b>	21-3/4" x 14-7/8"	18-15/16" x 13-1/8"	19-5/8" x 14"	18-3/8" x 12-9/16"	9-5/8"	1.27	9.50	65 lbs/5	6 lbs
<b>QDC2115-12</b>	21-3/4" x 15"	18-9/16" x 12-5/8"	19-3/4" x 14"	18" x 12-1/4"	12-3/4"	1.67	12.50	75 lbs/5	7 lbs
<b>QDC2115-17</b>	21-7/8" x 15-1/8"	18-3/8" x 12-7/8"	20" x 14-1/2"	17-7/8" x 12-1/2"	17-1/4"	2.31	17.25	100 lbs/3	8 lbs
<b>QDC2213-12**</b>	22-1/8" x 12-5/8"	18-7/8" x 10-7/8"	19-7/8" x 12"	18-1/2" x 10-1/8"	11-7/8"	1.42	12.25	75 lbs/5	6 lbs
<b>QDC2420-12*</b>	23-7/8" x 19-3/8"	21-1/4" x 17-5/16"	22-1/4" x 18"	20-5/8" x 16-5/8"	12-1/2"	2.44	18.25	85 lbs/5	8 lbs
<b>QDC2717-12</b>	27-5/16" x 16-9/16"	24-1/4" x 14-1/2"	25-1/8" x 15-3/8"	23-3/8" x 13-3/4"	12-1/2"	2.50	18.75	100 lbs/4	8 lbs
<b>QDC2515-14</b>	25-3/8" x 16-1/4"	22-1/4" x 13-1/4"	23-1/8" x 14-1/4"	21-5/8" x 12-5/8"	14-1/8"	2.20	16.50	100 lbs/4	8 lbs
<b>QDC2820-15*</b>	28-1/8" x 20-5/8"	25-3/8" x 18-3/4"	25-7/8" x 19-3/4"	25-1/8" x 18"	15-5/8"	4.00	29.92	100 lbs/4	13 lbs

\*Cannot be used on DLY-2415, use with DLY-3018 Dolly \*\*Manufactured with metal hinge

**Collapsible Bulk Box**



Quantum's Collapsible Bulk Box provides an efficient approach to large volume or large part material handling, storage and transport. Used for heavy loads, components and even food products, these reusable and returnable containers allow you to ship, handle, pick, store and distribute your products while increasing productivity and profitability. Quantum's Collapsible Bulk Box comes in a standard pallet size footprint measuring 48"L x 45"W. It can be collapsed down to a fraction of its full height in seconds. Bulk containers stack perfectly loaded or when folded down to minimize storage space. They are designed to make the shipping of your products faster, safer and less costly while providing greater protection. Two access drop doors are able to lie flush against the container allowing easy loading and unloading. Manufactured from High Density Polyethylene, this tough container provides superior protection for products while being stored or in transit. Welded base provides greater strength while the reinforced fork openings provide easy lifting. Can withstand temperatures between -20° and 250°F. Optional lid available to cover contents inside (Model No: **LID-4845**).

**HANDLE, SHIP, DISTRIBUTE, REUSE**



Fully expanded Bulk Box measures 48"L x 45"W x 34"H  
 (Lid **LID-4845** Sold separately)



Two access drop doors allows easy loading and unloading



Easy opening and collapsing of Bulk Box's side walls



Collapses to 12-3/4"; a fraction of its full height



**QBB-4845-34**

**PERFORMANCE FEATURES:**

- Plastic, ergonomic latches for opening and collapsing
- Superior strength with low tare weight
- High return ratio: return 3 collapsed boxes for each bulk box distributed
- 1,800 lb. load capacity for standard usage
- Large, flat labeling area on all four sides

Available in: ● Black

MODEL NO.	L (INCH/MM)	W (INCH/MM)	H (INCH/MM)
<b>QBB-4845-34</b>			
External	<b>48.00</b> /1219.2	<b>45.00</b> /1143.0	<b>33.9</b> /861.1
Internal	<b>44.50</b> /1130.3	<b>41.50</b> /1054.1	<b>28.2</b> /716.0
Usable Interior Height (Fill line)	-	-	<b>27.10</b> /688.3
Access Drop Door - Cut Out	-	<b>30.00</b> /762.0	<b>15.95</b> /405.1
Collapsed Height	-	-	<b>12.76</b> /324.0
Nested Height	-	-	<b>11.77</b> /299.0
Stack of 9/Collapsed (Trailer)	-	-	<b>106.93</b> /2716.1
Fork Tunnel - 48" Side	-	<b>11.00</b> /279.4	<b>3.40</b> /86.4
Fork Tunnel - 45" Side	-	<b>11.38</b> /288.9	<b>3.40</b> /86.4
Ship wgt. - 118 lbs			





Mobile Frames

MODEL NO.	DIMENSIONS D" x W" x H"	SHIP WGT
<b>Single Sided Mobile Frame</b>		
TTS-18	18" x 38" x 67"	170 lbs
TTS-24	24" x 38" x 67"	174 lbs
<b>Double Sided Mobile Frame</b>		
TTD-30	30" x 38" x 67"	178 lbs
TTD-40	40" x 38" x 67"	184 lbs



TTS-24 Single Sided Mobile Frame



TTD-40 Double Sided Mobile Frame  
Shown with 10 TT-CT15 closed trays  
(Sold separately)

Single and Double Sided Removable Tray Trucks

All welded construction with 1-1/2" square tubular frame. Slotted 12 gauge channel uprights (slots on 3-1/2" centers). Bolt on casters, 2 swivel and 2 rigid, for ease of replacement and superior cart tracking. Open and closed front trays and tray dividers sold separately.

Removable Trays

MODEL NO.	DIMENSIONS D" x W" x H"	SHIP WGT	TRAY DIVIDER MODEL NO.	QUANTITY OF TRAYS TO FIT MOBILE FRAMES			
				FRAME TTS-18	FRAME TTS-24	FRAME TTD-30	FRAME TTD-40
<b>Open Front Trays</b>							
TT-OT9	9" x 36" x 3"	16 lbs	TT-DIV3	14	14	28	28
TT-OT15	15" x 36" x 6"	28 lbs	TT-DIV6	-	-	-	14
<b>Closed Front Trays</b>							
TT-CT9	9" x 36" x 3"	16 lbs	TT-DIV3	14	14	28	28
TT-CT15	15" x 36" x 6"	28 lbs	TT-DIV6	-	-	-	14



TT-OT15 Open Tray



TT-CT15 Closed Tray

2,000 lb. LOAD CAPACITY



Order this exact unit

TTD-OT15-240

Unit consists of:

1 - double sided frame TTD-40

10 - open front trays TT-OT15

40 - bins QUS240 available in Blue, Green, Ivory, Red, Yellow, Black or Clear

**MAGNUM Bin Transport Trucks**



All welded construction with 1-1/2" x 3/16" thick angle frame construction. Twin 1-1/4" tubular handles with smooth radius bend. Bolt on polyurethane casters, 2 swivel and 2 rigid, for easy push and pull and superior tracking.

Bins available in: ● Blue ● Green ● Red ● Yellow ● Black (One color per unit)

MODEL NO.	DIMENSIONS D" x W" x H"	NO. OF BINS	BIN DIMENSIONS L" x W" x H"	SHIP WGT
<b>5" x 1-1/4" - Polyurethane Casters - 1,200 lb. Load Capacity</b>				
<b>MTT-1842-543</b>	18" x 42" x 47"	6	19-3/4" x 18-3/8" x 11-7/8"	204 lbs
<b>MTT-3042-743</b>	30" x 42" x 47"	6	29" x 18-3/8" x 11-7/8"	238 lbs
<b>5" x 2" - Polyurethane Casters - 3,000 lb. Load Capacity</b>				
<b>MTT-1860-543</b>	18" x 60" x 47"	9	19-3/4" x 18-3/8" x 11-7/8"	256 lbs
<b>MTT-3060-743</b>	30" x 60" x 47"	9	29" x 18-3/8" x 11-7/8"	290 lbs
<b>MTT-1878-543</b>	18" x 78" x 47"	12	19-3/4" x 18-3/8" x 11-7/8"	332 lbs
<b>MTT-3078-743</b>	30" x 78" x 47"	12	29" x 18-3/8" x 11-7/8"	380 lbs

**CART OFFERS  
1,200 lb.  
LOAD CAPACITY**



**MTT-1842-543**  
 18"D x 42"W x 47"H  
 6 bins QMS543  
 19-3/4"L x 18-3/8"W x 11-7/8"H bins



**MTT-3060-743**  
 30"D x 60"W x 47"H  
 9 bins QMS743  
 29"L x 18-3/8"W x 11-7/8"H bins

**MAGNUM**

AVAILABLE on pg. 45

**CARTS OFFER  
3,000 lb.  
LOAD CAPACITY**



**MTT-1878-543**  
 30"D x 78"W x 47"H  
 12 bins QMS543  
 19-3/4"L x 18-3/8"W x 11-7/8"H bins



**PC4026-33**  
40"L x 26"W x 32-1/2"H

**CARTS OFFER  
550 lb.  
LOAD CAPACITY**



**PFTC4026-33-3**  
40"L x 26"W x 32-1/2"H



**PFTC4026-33-2**  
40"L x 26"W x 32-1/2"H

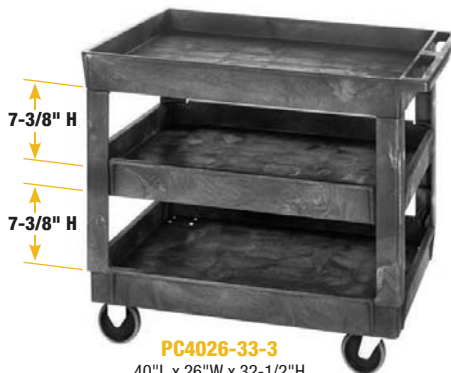

**PC4026-33-3**  
40"L x 26"W x 32-1/2"H



**PC3518-33-3**  
34-1/4"L x 17-1/2"W x 32-1/2"H

**Polymer Utility Carts**

Industrial strength cart is ideal for many industrial and commercial material handling applications. Set of 2 swivel and 2 rigid 5" x 1-1/4" heavy-duty casters allow for 550 lb. load capacity. Available in two sizes with a 2 or 3 shelf combination.

**RUGGED, HEAVY-DUTY, DURABLE**

Available in: ● Gray

MODEL NO.	OUTSIDE DIMENSIONS L" x W" x H"	INSIDE SHELF DIMENSIONS L" x W" x H"	NO. OF SHELVES	SHIP WGT
<b>PC3518-33</b>	34-1/4" x 17-1/2" x 32-1/2"	29-1/4" x 15-1/4" x 2-5/8"	2	38 lbs
<b>PC3518-33-3</b>	34-1/4" x 17-1/2" x 32-1/2"	29-1/4" x 15-1/4" x 2-5/8"	3	51 lbs
<b>PC4026-33</b>	40" x 26" x 32-1/2"	35" x 23" x 2-5/8"	2	54 lbs
<b>PC4026-33-3</b>	40" x 26" x 32-1/2"	35" x 23" x 2-5/8"	3	74 lbs
<b>Polymer Flat Top Shelf Cart</b>				
<b>PFTC4026-33-2</b>	40" x 26" x 32-1/2"	35" x 23"*	2	51 lbs
<b>PFTC4026-33-3</b>	40" x 26" x 32-1/2"	35" x 23"*	3	71 lbs
<b>Additional Shelves</b>				
<b>PC3518SHELF</b>	34-1/4" x 17-1/2" x 4-3/16"	29-1/4" x 15-1/4" x 2-5/8"	1	13 lbs
<b>PC4026SHELF</b>	40" x 26" x 4-3/16"	35" x 23" x 2-5/8"	1	20 lbs
<b>Replacement Casters</b>				
<b>PC-CAS-SW</b>	One Replacement Swivel Caster		2	lbs
<b>PC-CAS-RG</b>	One Replacement Rigid Caster		2	lbs

\*Inside dimension for middle and bottom shelf 35" x 23" x 2-5/8"

**Tool Rack**

Space saving Tool Rack is manufactured from durable polypropylene. Get organized with this tough rack that will not warp or bend even when it is loaded to capacity. Holds up to 96 items. Mounting hardware is not included.

Available in: ● Red

MODEL NO.	OUTSIDE DIMENSIONS L" x W" x H"	CTN QTY	CTN WGT
<b>TR-96</b>	6" x 24-1/8" x 2-3/4"	12	9 lbs

Shown with optional Tool Holder Attachment



**PC3518-33 + PCTH**  
34-1/4"L x 17-1/2"W x 32-1/2"H  
Shown with optional Tool Holder  
(Tools not included)

**Plastic Cart Tool Holder Attachment**

Available in: ● Red and Gray

MODEL NO.	DESCRIPTION	SHIP WGT
<b>PCTH</b>	96 Piece Tool Holder and Cart Attachment	3 lbs

Patent Pending



**TR-96**



**Tool Caddy**



Industrial strength, hand-held caddy ideal for tools and supplies. This portable, high density polypropylene caddy has extra strength ribs for support. Deep compartments make transporting tools, supplies and loose parts super easy.

Available in: ● Blue ● Gray

MODEL NO.	OUTSIDE DIMENSIONS L" x W" x H"	CTN QTY	CTN WGT
TC-500	13-3/8" x 18-1/4" x 5-1/2"*	6	14 lbs

\*Overall height including handle is 9-1/8"



TC-500



Industrial-strength polypropylene

Deep compartments are ideal for automotive parts, hardware or cleaning supplies. Inside pockets measures 16-3/4"L x 4-1/2"W

Comfortable grip handle even when carrying heavy loads 9-1/8"H



Perfect for tools, parts and janitorial supplies

**RUGGED, HEAVY-DUTY, DURABLE**

**Tool Box**



This tough Tool Box will not warp or bend even when it is loaded to capacity. Ideal for carrying hand tools, hardware or small to medium sized items. Handle provides comfortable smooth grip. Flush top surface for convenient stacking and storing. Manufactured from heavy-duty polypropylene.

Available in: ● Red ● Clear

MODEL NO.	OUTSIDE DIMENSIONS L" x W" x H"	CTN QTY	CTN WGT
TB12	5-1/2" x 12" x 4-1/8"	12	9 lbs
TB12CL <b>NEW</b>	5-1/2" x 12" x 4-1/8"	12	9 lbs



TB12CL **NEW CLEAR COLOR**

**IDEAL FOR CARRYING HAND TOOLS**



TB12

**TOUGH, DURABLE, LOW COST**



NPB1076

**NEW**

**Economy All-Purpose Nesting Parts Bin**



Organize your small to medium parts with our tough, durable, high density Nesting Parts Bins. Bins save space and nest when empty. Manufactured from heavy-duty polypropylene.

Available in: ○ White ● Black

MODEL NO.	OUTSIDE DIMENSIONS L" x W" x H"	INSIDE BOTTOM DIMENSIONS L" x W" x H"	CTN QTY	CTN WGT
NPB1076 <b>NEW</b>	10-1/4" x 7-1/2" x 6"	8" x 5-1/2" x 5-3/4"	20	10 lbs

Inside top width: 6-1/2" Inside height to open hopper front: 3-3/4"

**HEAVY-DUTY INDUSTRIAL-STRENGTH PLASTIC**

**Wrench Holder**



Versatile Wrench Holder can be mounted on any wall surface. Manufactured from high impact polystyrene and can hold up to 15 wrenches of different sizes. Mounting hardware is not included.

Available in: ● Black

MODEL NO.	OUTSIDE DIMENSIONS L" x W" x H"	CTN QTY	CTN WGT
WH-15	1" x 7-1/8" x 11-5/8"	12	5 lbs



WH-15 (Wrenches not included)



Bin, Tote and Container Labels



Labels facilitate parts identification and bar coding of the bin contents. Label sizes and availability vary per product. Correct labeling option(s) are specified alongside products details shown throughout the catalog.

INSERTS INCLUDED

Clear Label Holders and Inserts

Clear Label Holders easily slide into molded-in label slot on bin to protect label. Laser and inkjet compatible inserts come in 8-1/2" x 11" perforated sheets. Each package includes 25 clear holders and corresponding printer friendly sheet labels.

6 MODELS AVAILABLE

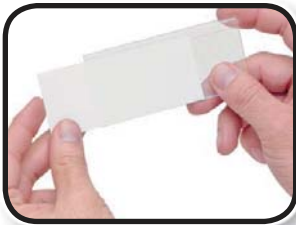

LTR-700, LTR-0813, LTR-1253, LTR-1300, LTR-1754, LTR-2400

Adhesive Label Holders and Inserts

Adhesive Label Holders are designed to work with bins without molded-in label slots. These label holders will attach securely to a flat surface. Laser and inkjet compatible inserts come in 8-1/2" x 11" perforated sheets. Each package includes 24 adhesive holders and corresponding printer friendly sheet labels.



AL-23



AL-35

Bin Rear Label Holder

New Rear Bin Label Holder clips to the back portion of any plastic bin. Creates a vertical extension for a 1" x 3" label or barcode making it easy to identify the contents of that bin. Each package includes 12 clear holders and corresponding printer friendly sheet labels.



RLH1X3C

INSERTS NOT INCLUDED

Label Holders for Dividable Grid Containers

Label Holders are available for standard and conductive dividable grid containers. Three sizes to choose from (2" x 8", 3" x 5" and 5" x 8"). Package of 6.



CLEAR LABEL HOLDER



CONDUCTIVE LABEL HOLDER

Clear Hanging Label Holder

3" x 5" Clear Hanging Label Holder securely attaches to all sizes of stack and nest totes and cross stack tubs. Label holder can be used on totes and tubs with or without lids for easy part identification. Package of 6.



FITS ALL CROSS STACK TUBS



snh010

FITS ALL stack and nest TOTES

Extended Label Holders

Extended Label Holders are designed to slide into the molded label slot of bins to allow for larger bar code scanning or just larger labels. Label holders fit all 4", 6" and 8" Shelf Bins. Provides a 4" x 2-1/4" flat angled surface. Package of 24.

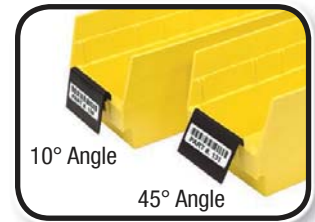

10° Angle

45° Angle

ELH410 and ELH445

Divider Label Tab

Divider Label Tabs attach directly to existing dividers enabling sections of bin to be labeled. Multiple tabs improve the visibility of bin labels and scanning of barcodes. Package of 6.

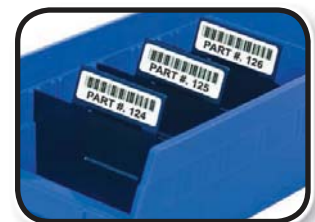

DLT-6

**Plastic Drawer Cabinets**

- Heavy-duty reinforced construction.
- Each see through drawer includes a divider.
- Stable stacking and easy wall mounting with pre-configured holes on rear side.
- Drawer stops on each drawer prevents spills.
- Textured drawer pull surface.
- Durable high impact polypropylene frame with clear polypropylene drawers and bins.

Available in: ● Black and Gray

MODEL NO.	OUTSIDE DIMENSIONS L" x W" x H"	DRAWER QTY	DRAWER DIMENSIONS L" x W" x H"	PKG QTY	PKG WGT
<b>PDC-12BK</b> <small>NEW</small>	6-1/4" x 10-1/2" x 10-1/4"	8 Drawers 4 Drawers	5-1/2" x 2" x 1-1/4" 5-1/2" x 4-1/4" x 2"	1	3 lbs
<b>PDC-18BK</b> <small>NEW</small>	6-1/4" x 15" x 18-3/4"	18 Drawers	5-1/2" x 4-1/4" x 2"	1	5 lbs
<b>PDC-22BK</b> <small>NEW</small>	6-1/4" x 19-1/2" x 10"	14 Drawers 8 Drawers	5-1/2" x 2" x 1-1/4" 5-1/2" x 4-1/4" x 2"	1	5 lbs
<b>PDC-39BK</b> <small>NEW</small>	6-1/4" x 15" x 18-3/4"	30 Drawers 9 Drawers	5-1/2" x 2" x 1-1/4" 5-1/2" x 4-1/4" x 2"	1	6 lbs
<b>PDC-60BK</b> <small>NEW</small>	6-1/4" x 15" x 18-3/4"	60 Drawers	5-1/2" x 2" x 1-1/4"	1	7 lbs
<b>PDC-930BK</b> <small>NEW</small>	6-1/4" x 15" x 18-3/4"	30 Drawers 9 Bins	5-1/2" x 2" x 1-1/4" 5-1/2" x 4-1/4" x 2-3/4"	1	6 lbs



**PDC-12BK**



**PDC-18BK**

**NEW**

**EASY TO IDENTIFY ITEMS INSIDE**



**PDC-22BK**



**PDC-39BK**



**PDC-60BK**



**PDC-930BK**



Organizers

Clear lid design allows quick identification of parts inside. Unique latch design enables lid to close and latch tight and secure. Dividers prevent parts from migrating between various compartments. Organizers manufactured from industrial grade polypropylene.

Available in: Black, Red and Clear

MODEL NO.	OUTSIDE DIMENSIONS L" x W" x H"	CTN QTY	CTN WGT
<b>Single Sided</b>			
ORG80032	12-1/2" x 10" x 2-1/4"	6	7 lbs
ORG81532 <b>NEW</b>	15" x 12-1/4" x 2-3/4"	6	11 lbs
ORG81832 <b>NEW</b>	18" x 14" x 3"	4	10 lbs
<b>Double Sided</b>			
ORG80322	12-1/4" x 10-1/4" x 3"	5	9 lbs



**ORG80032**  
Single Sided Organizer

- Offers up to 17 storage compartments.
- Includes 12 dividers allowing you to customize the size of the desired compartments inside.

**SINGLE SIDED**

**NEW**  
SIZES



**NEW**  
**ORG81532**  
Single Sided Organizer

- Offers up to 23 storage compartments.
- Includes 18 dividers allowing you to customize the size of the desired compartments inside.

**SINGLE SIDED**



**NEW**  
**ORG81832**  
Single Sided Organizer

- Offers up to 26 storage compartments.
- Includes 21 dividers allowing you to customize the size of the desired compartments inside.

**SINGLE SIDED**



**ORG80322**  
Double Sided Organizer

- Offers up to 32 storage compartments.
- Includes 24 dividers allowing you to customize the size of the desired compartments inside.

**DOUBLE SIDED**



**DIVIDERS INCLUDED**

**Clear Compartment Storage Boxes**

Utility boxes offer compartments for small and medium parts storage. Manufactured of clear, see-through polypropylene.

Available in: ● Clear

MODEL NO.	OUTSIDE DIMENSIONS L" x W" x H"	CTN QTY	CTN WGT
<b>Removable Dividers</b>			
QB200 <b>NEW</b>	5-1/2" x 2-3/4" x 1-1/4"	12	2 lbs
QB300 <b>NEW</b>	6-3/4" x 4-3/4" x 2-1/4"	12	4 lbs
QB400 <b>NEW</b>	7-3/4" x 5-1/2" x 1-3/4"	12	5 lbs
QB500 <b>NEW</b>	9-1/4" x 6-1/4" x 2-1/5"	6	4 lbs
QB600 <b>NEW</b>	11-3/4" x 7-3/4" x 2-1/5"	6	5 lbs
<b>Fixed Dividers</b>			
QB900	10-1/4" x 13" x 2-3/8"	6	8 lbs



**QB900**  
 ● Organizer has 10 fixed compartments.

**COMPARTMENTS FOR SMALL AND MEDIUM SIZED PARTS**

**NEW DESIGNS**



**NEW QB200**  
 ● Includes 2 fixed and 6 removable dividers creating 3-8 compartments.



**NEW QB300**  
 ● Includes 5 removable dividers creating 1-6 compartments.



**NEW QB400**  
 ● Includes 1 fixed and 6 removable dividers creating 2-8 compartments.



**NEW QB600**  
 ● Includes removable tray and 3 removable dividers creating 1-8 compartments.



**NEW QB800**  
 ● Includes 6 removable dividers creating 1-10 compartments.





### Environmentally Friendly Recycled Bins



Manufactured from recycled, 100% post consumer, high density polypropylene, these bins come in a complete range of sizes and have all the features of Quantum's standard bins at a more economical price. Available in Black only.

### Recycled Ultra Hang & Stack Bins

See pg. 5 for additional information on Ultra Hang & Stack Bins and to order window fronts, clear lids or dividers.



Available in: ● Black

MODEL NO.	OUTSIDE DIMENSIONS L" x W" x H"	CTN QTY	CTN WGT
QUS200BR	5" x 4-1/8" x 3"	24	5 lbs
QUS210BR	5-3/8" x 4-1/8" x 3"	24	6 lbs
QUS220BR	7-3/8" x 4-1/8" x 3"	24	8 lbs
QUS221BR	9-1/4" x 6" x 5"	24	8 lbs
QUS224BR	10-7/8" x 4-1/8" x 4"	12	8 lbs
QUS230BR	10-7/8" x 5-1/2" x 5"	12	10 lbs
QUS232BR	<b>NEW</b> 5-3/8" x 11" x 3"	8	5 lbs
QUS234BR	14-3/4" x 5-1/2" x 5"	12	14 lbs
QUS235BR	10-7/8" x 11" x 5"	6	10 lbs
QUS236BR	<b>NEW</b> 7-3/8" x 11" x 3"	8	9 lbs
QUS238BR	<b>NEW</b> 18" x 5-1/2" x 5"	12	16 lbs
QUS239BR	10-3/4" x 8-1/4" x 7"	6	10 lbs
QUS240BR	14-3/4" x 8-1/4" x 7"	12	24 lbs
QUS241BR	13-5/8" x 8-1/4" x 6"	12	24 lbs
QUS242BR	13-5/8" x 8-1/4" x 8"	12	24 lbs
QUS245BR	10-7/8" x 16-1/2" x 5"	6	13 lbs
QUS248BR	<b>NEW</b> 18" x 8-1/4" x 7"	6	19 lbs
QUS250BR	14-3/4" x 16-1/2" x 7"	6	21 lbs
QUS255BR	16" x 11" x 8"	4	14 lbs
QUS260BR	18" x 11" x 10"	4	17 lbs
QUS265BR	18" x 8-1/4" x 9"	6	17 lbs
QUS270BR	18" x 16-1/2" x 11"	3	16 lbs
QUS275MOBBER	18" x 16-1/2" x 11"	6	19 lbs
QGH700BR	15-1/4" x 19-7/8" x 12-7/16"	3	13 lbs

### Recycled Shelf Bins

See pg. 48 for additional information on Shelf Bins and to order dividers and bin cups.

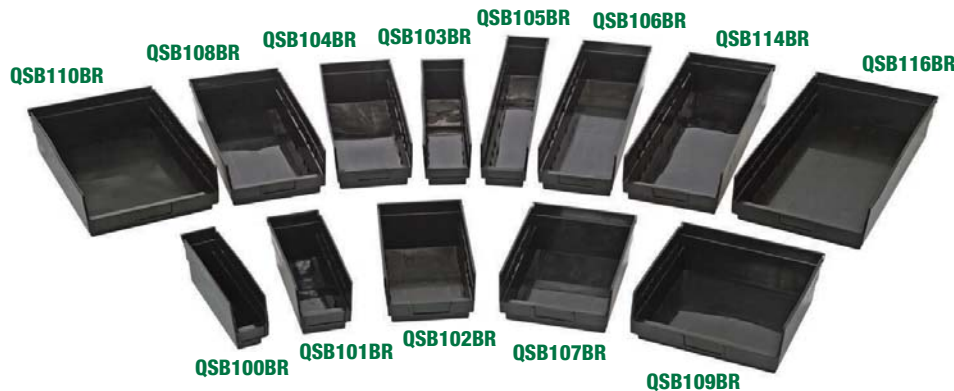

Available in: ● Black

MODEL NO.	OUTSIDE DIMENSIONS L" x W" x H"	CTN QTY	CTN WGT
QSB100BR	11-5/8" x 2-3/4" x 4"	36	13 lbs
QSB101BR	11-5/8" x 4-1/8" x 4"	36	17 lbs
QSB102BR	11-5/8" x 6-5/8" x 4"	30	18 lbs
QSB107BR	11-5/8" x 8-3/8" x 4"	20	15 lbs
QSB109BR	11-5/8" x 11-1/8" x 4"	8	7 lbs
QSB103BR	17-7/8" x 4-1/8" x 4"	20	13 lbs
QSB104BR	17-7/8" x 6-5/8" x 4"	20	16 lbs
QSB108BR	17-7/8" x 8-3/8" x 4"	10	11 lbs
QSB110BR	17-7/8" x 11-1/8" x 4"	8	11 lbs
QSB105BR	23-5/8" x 4-1/8" x 4"	16	13 lbs
QSB106BR	23-5/8" x 6-5/8" x 4"	8	9 lbs
QSB114BR	23-5/8" x 8-3/8" x 4"	6	9 lbs
QSB116BR	23-5/8" x 11-1/8" x 4"	6	10 lbs

### Recycled MAGNUM Bins

See pg. 45 for additional information on MAGNUM Bins and to order windows, dividers or a mobile option.



Available in: ● Black

MODEL NO.	OUTSIDE DIMENSIONS L" x W" x H"	CTN QTY	CTN WGT
QMS531BR	19-3/4" x 12-3/8" x 5-7/8"	6	19 lbs
QMS532BR	19-3/4" x 12-3/8" x 7-7/8"	6	23 lbs
QMS533BR	19-3/4" x 12-3/8" x 11-7/8"	3	15 lbs
QMS543BR	19-3/4" x 18-3/8" x 11-7/8"	1	8 lbs
QMS743BR	29" x 18-3/8" x 11-7/8"	1	10 lbs

**MANUFACTURED FROM RECYCLED, 100% POST CONSUMER, HIGH DENSITY POLYPROPYLENE**



**Conductive Ultra Stack Bins & Dividers**



Protect your electronic components from typical electromagnetic interference (EMI), electrostatic or induced fields with these conductive polypropylene bins. The conductive material provides a barrier which these fields cannot penetrate and prevents the build-up of an electrostatic charge. Bins are permanently conductive and are unaffected by washing with normal cleaners. Molded from a carbon filled copolymer polypropylene material with an electrostatic decay rate at less than 0.1 second that meets conductivity standards as tested with ASTM-D257 methods. Its surface resistivity is less than 10<sup>6</sup> Ohms-per square. Easy access to stored items with hopper front bin and label holder provides fast identification. Reinforced side walls and wide ledge allow high stacking on benches or shelving. Be sure all bins are properly grounded according to your use.

Available in: ● Black

MODEL NO.	OUTSIDE DIMENSIONS L" x W" x H"	CTN QTY	CTN WGT	DIVIDER	CTN QTY
QUS200CO	5" x 4-1/8" x 3"	24	5 lbs	DUS200CO	6
QUS210CO	5-3/8" x 4-1/8" x 3"	24	6 lbs	DUS210CO	6
QUS220CO	7-3/8" x 4-1/8" x 3"	24	8 lbs	DUS220CO	6
QUS230CO	10-7/8" x 5-1/2" x 5"	12	12 lbs	DUS230CO	6
QUS235CO	10-7/8" x 11" x 5"	6	10 lbs	DUS235CO	6
QUS239CO	10-3/4" x 8-1/4" x 7"	6	10 lbs	DUS239CO	6
QUS240CO	14-3/4" x 8-1/4" x 7"	12	24 lbs	DUS240CO	6
QUS250CO	14-3/4" x 16-1/2" x 7"	6	21 lbs	DUS250CO	6
QUS255CO	16" x 11" x 8"	4	14 lbs	DUS255CO	6
QUS260CO	18" x 11" x 10"	4	17 lbs	DUS260CO	6
QUS270CO	18" x 16-1/2" x 11"	3	16 lbs	DUS270CO	6



**LARGEST CONDUCTIVE SELECTION AVAILABLE ANYWHERE**

**CUSTOMIZE YOUR OWN UNIT**

1. Select the hanging unit of your choice.
2. Use the chart above and choose the bin that best fits your need.
3. Go to the chart at the bottom of this page and determine how many bins fit on the unit you selected.
4. Place your order for both unit and bins.

**Wire Louvered Panels**

**WALL MOUNT YOUR CONDUCTIVE BINS**

Quantum's new chrome Wire Louvered Panels offer a perfect mounting solution for all plastic hanging and new wire mesh hanging bins. Quantum's exclusive offering of wire panels, available in three sizes, completely resist any buildup of dust or dirt. Included direct mounting clips enable fastening to any surface (wall, wood, concrete, drywall, etc.) a snap. Manufactured of heavy-duty chrome wire, Quantum's wire panels will offer years of dependable and heavy-duty service.

**GROUND WIRE ALLOWS STATIC CHARGE TO BE DISSIPATED KEEPING BIN CONTENTS SAFE**



GRD-WR Ground Wire (Sold separately)

**SIMPLE TO MOUNT EASY TO CLEAN ALL WELDED**

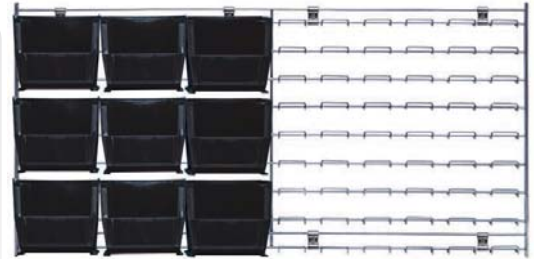

WLP-1836C

36"L x 18"H Includes 8 direct mount clips. 175 lb. load capacity.

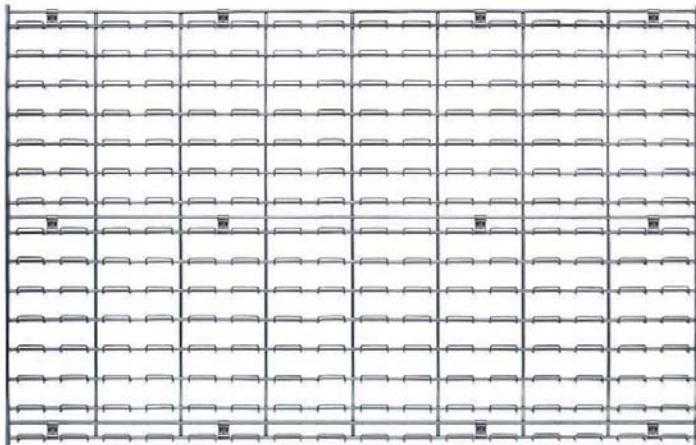

WLP-3048C

48"L x 30"H Includes 12 direct mount clips. 250 lb. load capacity.

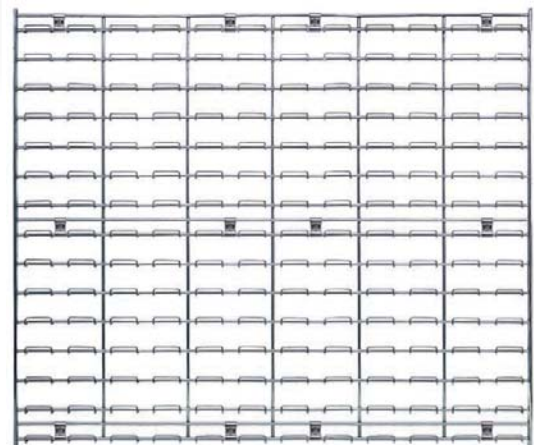

WLP-3036C

36"L x 30"H Includes 12 direct mount clips. 175 lb. load capacity.

**QUANTITY OF ULTRA BINS TO FIT LOUVERED PANELS**

MODEL NO.	QUS 200CO	QUS 210CO	QUS 220CO	QUS 230CO	QUS 235CO	QUS 239CO	QUS 240CO	QUS 250CO	QUS 255CO	QUS 260CO	QUS 270CO
WLP-1836C	32	32	32	18	9	8	8	4	6	3	2
WLP-3036C	56	56	56	30	15	16	16	6	9	6	6
WLP-3048C	77	77	77	40	20	20	20	8	12	12	6

See chart above for bin dimensions



**Conductive Shelf Bins**



Protect your electronic components from typical electro-magnetic interference (EMI), electrostatic or induced fields with these molded, carbon-filled, copolymer polypropylene bins. Surface resistivity is less than 10<sup>5</sup> Ohms-per square. Easy access to stored items with hopper front bin and label holder provides fast identification. The conductive material provides a barrier which these fields cannot penetrate and prevents the build-up of electrostatic charge. Bins are permanently conductive and are unaffected by washing with normal cleaners. Be sure all bins are properly grounded according to your application.

Available in: ● Black

MODEL NO.	OUTSIDE DIMENSIONS L" x W" x H"	CTN QTY	CTN WGT	DIVIDER	CTN QTY
QSB100CO	11-5/8" x 2-3/4" x 4"	36	13 lbs	-	-
QSB101CO	11-5/8" x 4-1/8" x 4"	36	17 lbs	DSB101CO	50
QSB102CO	11-5/8" x 6-5/8" x 4"	30	18 lbs	DSB102CO	50
QSB107CO	11-5/8" x 8-3/8" x 4"	20	15 lbs	DSB107CO	50
QSB109CO	11-5/8" x 11-1/8" x 4"	8	7 lbs	DSB109CO	50
QSB103CO	17-7/8" x 4-1/8" x 4"	20	13 lbs	DSB103CO	50
QSB104CO	17-7/8" x 6-5/8" x 4"	20	16 lbs	DSB104CO	50
QSB108CO	17-7/8" x 8-3/8" x 4"	10	11 lbs	DSB108CO	50
QSB110CO	17-7/8" x 11-1/8" x 4"	8	11 lbs	DSB110CO	50
QSB105CO	23-5/8" x 4-1/8" x 4"	16	13 lbs	DSB105CO	50
QSB106CO	23-5/8" x 6-5/8" x 4"	8	9 lbs	DSB106CO	50
QSB114CO	23-5/8" x 8-3/8" x 4"	6	9 lbs	DSB114CO	50
QSB116CO	23-5/8" x 11-1/8" x 4"	6	10 lbs	DSB116CO	50

**13 SIZES AVAILABLE**



**12", 18" AND 24" DEPTHS**

**Conductive Complete Bin Center**

Complete bin systems are available with 4 different size bins on a 12"W x 36"L x 36"H unit. This all-purpose bin center is an economical high density storage system that provides easy visibility to stored contents.

MODEL NO.	NO. OF BINS	BIN DIMENSIONS L" x W" x H"	SHIP WGT
<b>12"W x 36"L x 36"H - 6 Shelf Systems</b>			
WR6-36-1236-101CO	40 QSB101CO	11-5/8" x 4-1/8" x 4"	63 lbs
WR6-36-1236-102CO	25 QSB102CO	11-5/8" x 6-5/8" x 4"	50 lbs
WR6-36-1236-107CO	20 QSB107CO	11-5/8" x 8-3/8" x 4"	62 lbs
WR6-36-1236-109CO	15 QSB109CO	11-5/8" x 11-1/8" x 4"	64 lbs

**CONVERT STANDARD WIRE SHELVING INTO CONDUCTIVE SHELVING WITH THESE ACCESSORIES THAT ARE INCLUDED WITH THESE PACKAGES**



ESD-DC Drag Chain



WR-SSCO Plastic Conductive Split Sleeve



**800 lb. LOAD CAPACITY PER SHELF**

**MOBILIZE YOUR WIRE SHELVING**

**DB - Donut Bumper**  
Non-marking donut bumper used to protect walls and help cushion impact.

**WR-00CO (Mobile Kit)\***  
Set of four swivel ESD/Conductive 5" x 1-1/4" casters, two with brakes. Can be used with all units shown. 1,200 lb. load capacity. \*Mobile kits recommended only for shelves 18" and deeper.

**Conductive Shelf Bin Wire Shelving Systems - Complete Packages**

MODEL NO.	NO. OF BINS	BIN DIMENSIONS L" x W" x H"	SHIP WGT
<b>12"W x 36"L x 74"H - 12 Shelf Systems</b>			
WR12-101CO	88 QSB101CO	11-5/8" x 4-1/8" x 4"	120 lbs
WR12-102CO	55 QSB102CO	11-5/8" x 6-5/8" x 4"	116 lbs
WR12-107CO	44 QSB107CO	11-5/8" x 8-3/8" x 4"	117 lbs
WR12-109CO	33 QSB109CO	11-5/8" x 11-1/8" x 4"	119 lbs
<b>18"W x 36"L x 74"H - 12 Shelf Systems</b>			
WR12-103CO	88 QSB103CO	17-7/8" x 4-1/8" x 4"	176 lbs
WR12-104CO	55 QSB104CO	17-7/8" x 6-5/8" x 4"	165 lbs
WR12-108CO	44 QSB108CO	17-7/8" x 8-3/8" x 4"	170 lbs
WR12-110CO	33 QSB110CO	17-7/8" x 11-1/8" x 4"	168 lbs
<b>24"W x 36"L x 74"H - 12 Shelf Systems</b>			
WR12-105CO	88 QSB105CO	23-5/8" x 4-1/8" x 4"	228 lbs
WR12-106CO	55 QSB106CO	23-5/8" x 6-5/8" x 4"	218 lbs
WR12-114CO	44 QSB114CO	23-5/8" x 8-3/8" x 4"	222 lbs
WR12-116CO	33 QSB116CO	23-5/8" x 11-1/8" x 4"	206 lbs



WR6-36-1236-102CO



WR12-108CO



# 11 SIZES AVAILABLE



## Conductive Dividable Grid Containers



Protect your electronic components from typical electromagnetic interference (EMI), electrostatic or induced fields with these molded, carbon-filled, copolymer polypropylene dividable grid containers. Surface resistivity is less than 10<sup>5</sup> Ohms-per square. The conductive material provides a barrier which these fields cannot penetrate and prevents the build-up of electrostatic charge. Containers, dividers and covers are permanently conductive and are unaffected by washing with normal cleaners. Containers have a load capacity of 100 lb. Dividers available to customize your box into compartments at 1-1/8" intervals and snap covers protect contents from dust or damage. Be sure all bins are properly grounded according to your use.

**NEW SIZES**

## Conductive Label Holders

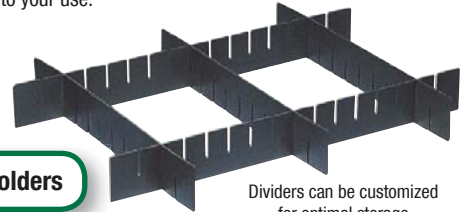

Dividers can be customized for optimal storage (Sold separately)

Available in: ● Black

MODEL NO.	DIMENSIONS H" x W"	FITS BIN MODEL NO.	CTN QTY
<b>LBL2X8CO</b>	2" x 8"	DG91025CO, DG91035CO, DG92035CO, DG93030CO	6
<b>LBL3X5CO</b>	3" x 5"	DG91050CO, DG92050CO, DG92060CO, DG93060CO	6
<b>LBL5X8CO</b>	5" x 8"	DG92080CO, DG93080CO, DG93120CO	6

Available in: ● Black

MODEL NO.	OUTSIDE DIMENSIONS L" x W" x H"	INSIDE DIMENSIONS L" x W" x H"	CTN QTY	CTN WGT	LONG DIVIDER	CTN QTY	SHORT DIVIDER	CTN QTY	COVER	CTN QTY
<b>DG91025CO</b> <b>NEW</b>	10-7/8" x 8-1/4" x 2-1/2"	9-3/16" x 6-9/16" x 2"	20	16 lbs	<b>DL91025CO</b>	6	<b>DS91025CO</b>	6	<b>COV91000CO</b>	10
<b>DG91035CO</b>	10-7/8" x 8-1/4" x 3-1/2"	9-3/16" x 6-9/16" x 3"	20	24 lbs	<b>DL91035CO</b>	6	<b>DS91035CO</b>	6	<b>COV91000CO</b>	10
<b>DG91050CO</b>	10-7/8" x 8-1/4" x 5"	9-3/16" x 6-9/16" x 4-1/2"	20	32 lbs	<b>DL91050CO</b>	6	<b>DS91050CO</b>	6	<b>COV91000CO</b>	10
<b>DG92035CO</b>	16-1/2" x 10-7/8" x 3-1/2"	14-7/8" x 9-1/4" x 3"	12	23 lbs	<b>DL92035CO</b>	6	<b>DS92035CO</b>	6	<b>COV92000CO</b>	4
<b>DG92050CO</b> <b>NEW</b>	16-1/2" x 10-7/8" x 5"	14-7/8" x 9-1/4" x 4-1/2"	12	25 lbs	<b>DL92050CO</b>	6	<b>DS92050CO</b>	6	<b>COV92000CO</b>	4
<b>DG92060CO</b>	16-1/2" x 10-7/8" x 6"	14-7/8" x 9-1/4" x 5-1/2"	8	20 lbs	<b>DL92060CO</b>	6	<b>DS92060CO</b>	6	<b>COV92000CO</b>	4
<b>DG92080CO</b>	16-1/2" x 10-7/8" x 8"	14-7/8" x 9-1/4" x 7-1/2"	8	27 lbs	<b>DL92080CO</b>	6	<b>DS92080CO</b>	6	<b>COV92000CO</b>	4
<b>DG93030CO</b>	22-1/2" x 17-1/2" x 3"	20-5/8" x 15-5/8" x 2-1/2"	6	20 lbs	<b>DL93030CO</b>	6	<b>DS93030CO</b>	6	<b>COV93000CO</b>	3
<b>DG93060CO</b>	22-1/2" x 17-1/2" x 6"	20-5/8" x 15-5/8" x 5-1/2"	3	16 lbs	<b>DL93060CO</b>	6	<b>DS93060CO</b>	6	<b>COV93000CO</b>	3
<b>DG93080CO</b>	22-1/2" x 17-1/2" x 8"	20-5/8" x 15-5/8" x 7-1/2"	3	19 lbs	<b>DL93080CO</b>	6	<b>DS93080CO</b>	6	<b>COV93000CO</b>	3
<b>DG93120CO</b>	22-1/2" x 17-1/2" x 12"	20-5/8" x 15-5/8" x 11-1/2"	3	23 lbs	<b>DL93120CO</b>	6	<b>DS93120CO</b>	6	<b>COV93000CO</b>	3



### DIVIDERS

Containers can be divided by length and/or width allowing a subdivision down to a 1-1/8" square compartment size. Available in Black.



### SNAP ON COVERS

Snap on covers protect contents from damage or dust during shipping and storage.



### LABEL HOLDERS

Fits any size container. Three sizes to choose from. Attach via metal grommets on label holder and bins.



**BC212434M1CO**

# COMPLETE PACKAGES WITH BINS

## Conductive Bin Carts

Offering two heights and four bin quantity designs, these modular carts are the ultimate work-in-process and transport carts. Dividable grids slide easily in and out with their ability to be divided into multiple compartments with long and short dividers, truly any type of storage is possible. Dividable grids are available in Black. **Cart Finish:** Chrome

MODEL NO.	NO. OF BINS	BIN DIMENSIONS L" x W" x H"	SHIP WGT
<b>21"W x 24"L x 45"H - Bin Cart with Dividable Grid Containers</b>			
<b>BC212434M1CO</b>	4 DG93060CO	22-1/2" x 17-1/2" x 6"	58 lbs
<b>BC212439M2CO</b>	7 DG93030CO	22-1/2" x 17-1/2" x 3"	79 lbs
<b>21"W x 24"L x 69"H - Bin Cart with Dividable Grid Containers</b>			
<b>BC212469M1CO</b>	7 DG93060CO	22-1/2" x 17-1/2" x 6"	107 lbs
<b>BC212469M2CO</b>	11 DG93030CO	22-1/2" x 17-1/2" x 3"	111 lbs
<b>21"W x 24"L x 45"H - Bin Cart with No Dividable Grid Containers</b>			
<b>BC212439M4CO</b>	No Containers (Includes Slides for 4 Bin Levels)		46 lbs
<b>BC212439M7CO</b>	No Containers (Includes Slides for 7 Bin Levels)		55 lbs
<b>21"W x 24"L x 69"H - Bin Cart with No Dividable Grid Containers</b>			
<b>BC212469MCO</b>	No Containers (Includes Slides for 7 Bin Levels)		63 lbs
<b>BC212469M11CO</b>	No Containers (Includes Slides for 11 Bin Levels)		75 lbs



**Conductive Wire Utility Carts**

Carts consists of 2 u-handles, 4 donut bumpers, 4 conductive swivel casters (2 with brakes), drag chain and 2 or 3 wire shelves.

MODEL NO.	DIMENSIONS W" x L" x H"	SHIP WGT
<b>2 Wire Shelf Mobile Utility Carts</b>		
<b>WRC-1836-2CO</b>	18" x 36" x 37-1/2"	30 lbs
<b>WRC-1842-2CO</b>	18" x 42" x 37-1/2"	32 lbs
<b>WRC-1848-2CO</b>	18" x 48" x 37-1/2"	37 lbs
<b>WRC-2436-2CO</b>	24" x 36" x 37-1/2"	36 lbs
<b>WRC-2442-2CO</b>	24" x 42" x 37-1/2"	40 lbs
<b>WRC-2448-2CO</b>	24" x 48" x 37-1/2"	44 lbs
<b>3 Wire Shelf Mobile Utility Carts</b>		
<b>WRC-1836-3CO</b>	18" x 36" x 37-1/2"	37 lbs
<b>WRC-1842-3CO</b>	18" x 42" x 37-1/2"	42 lbs
<b>WRC-1848-3CO</b>	18" x 48" x 37-1/2"	48 lbs
<b>WRC-2436-3CO</b>	24" x 36" x 37-1/2"	49 lbs
<b>WRC-2442-3CO</b>	24" x 42" x 37-1/2"	55 lbs
<b>WRC-2448-3CO</b>	24" x 48" x 37-1/2"	60 lbs



**WRC-1836-2CO**

**ESD Modular Trays**



18" x 26" and 20" x 26" trays are ESD and comply with ANSI/ESD standards for the use in PC board assembly and handling. All trays are manufactured of fiberglass reinforced thermostet material, allowing up to 200 lb. weight capacity when evenly distributed. Quantum's modular trays will withstand temperatures of -40°F to +350°F. Trays are resistant to abrasion and chemicals. Trays are permanently conductive, properties are unaffected by washing in steam or water.

Available in: ● Black

MODEL NO.	DIMENSIONS W" x L" x H"	SHIP WGT
<b>1826ESD</b>	18" x 26" x 1-1/8"	4 lbs
<b>2026ESD</b>	20" x 26" x 1-1/2"	5 lbs

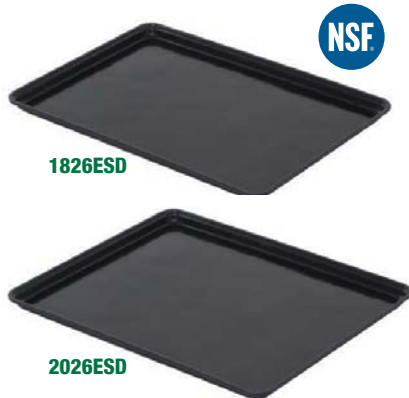

**200 lb. LOAD CAPACITY PER TRAY**



**TC-39CO + 1826ESD**  
Tray Stops TS62C can be used on back as shown here or one in the back and one in the front. (Trays sold separately)

**Conductive Modular Tray Carts**

Tray carts are offered in half size and full size units, designed to handle work in process. ESD trays can be used on tray cart for conductive applications with the addition of aluminum split sleeves (**ESD-SS**) or conductive plastic split sleeves (**WR-SSCO**) and a drag chain (**ESD-DC**). Optional Tray Stop prevents trays from falling out. **Cart finish:** Chrome

MODEL NO.	DIMENSIONS W" x L" x H"	SHIP WGT	TRAY STOP MODEL NO.
<b>39"H - Side Load Tray Cart</b>			
<b>TC-19CO</b>	18" x 30" x 39"	19 Trays 45 lbs	<b>TS32C</b>
<b>69"H - Side Load Tray Carts</b>			
<b>TC-39CO</b>	18" x 30" x 69"	39 Trays 74 lbs	<b>TS62C</b>
<b>TC-31CO</b>	21" x 30" x 69"	31 Trays 68 lbs	<b>TS62C</b>
<b>69"H - End Load Tray Carts</b>			
<b>TC-EL38CO</b>	21-3/4" x 27" x 69"	38 Trays 74 lbs	<b>TS62C</b>

Trays are sold separately

**CONVERT STANDARD WIRE SHELVING INTO CONDUCTIVE SHELVING WITH THESE ACCESSORIES THAT ARE INCLUDED WITH THESE PACKAGES**



**ESD-DC**  
Drag Chain



**WR-SSCO**  
Plastic Conductive Split Sleeve



**Portable Computer/LAN Work Center**

Portable Computer Center and mini LAN (Local Area Network) Work Center offers flexibility in any operation. The modular characteristics allow the unit to be adaptable to all your equipment requirements such as servers, PCs, printers, keyboards, and monitors. This system features adjustable shelves on 1" increments, quick field assembly without the use of tools, excellent strength, durable chrome finish and easy to roll locking 3" polyurethane casters. **Finish:** Chrome

- Unit consists of:*
- 4 - 34" posts
  - 3 - 24" x 30" wire shelves
  - 1 - keyboard tray
  - 1 - document holder basket
  - 4 - 3" poly stem casters



**M2430CLAN**  
(computer, monitor, keyboard, printer, folder not included)

**Conductive Accessories**



**WR-SSCO**  
Conductive Plastic Split Sleeves

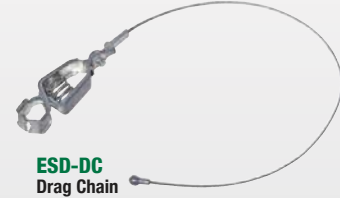

**ESD-DC**  
Drag Chain

**Reel Shelving Units**



Quantum Reel Shelving offers a safe and efficient method of transporting and storing standard size component reels. New reel shelves are chrome plated and can be used in conjunction with same size standard flat wire shelves. Units are available with conductive accessories providing a static safe storage system to address reel handling and providing stationary or mobile complete storage systems for PCB manufacturers. **Finish:** Chrome



**NEW**  
**WRC-R264C**  
(see pg. 111 for additional sizes)

**400 lb.**  
**LOAD CAPACITY**  
**PER SHELF**



**NEW**

**800 lb.**  
**LOAD CAPACITY**  
**PER SHELF**



**MOBILIZE YOUR SHELVING**

**DB - Donut Bumper**  
Non-marking donut bumper used to protect walls and help cushion impact.

**WR-00CO (Mobile Kit)\***  
Set of four swivel ESD/Conductive 5" x 1-1/4" casters, two with brakes. Can be used with all units shown. 1,200 lb. load capacity.  
\*Mobile kits recommended only for shelves 18" and deeper.

**Stencil Unit**



Quantum's new stencil storage racks efficiently and safely store and transport dry stencils. Adjustable shelves and dividers accommodate all frames from 20" to 29" deep. Optional performance cushion ride conductive casters allow built in ESD/conductive protection. Optional side panels available. **Finish:** Chrome

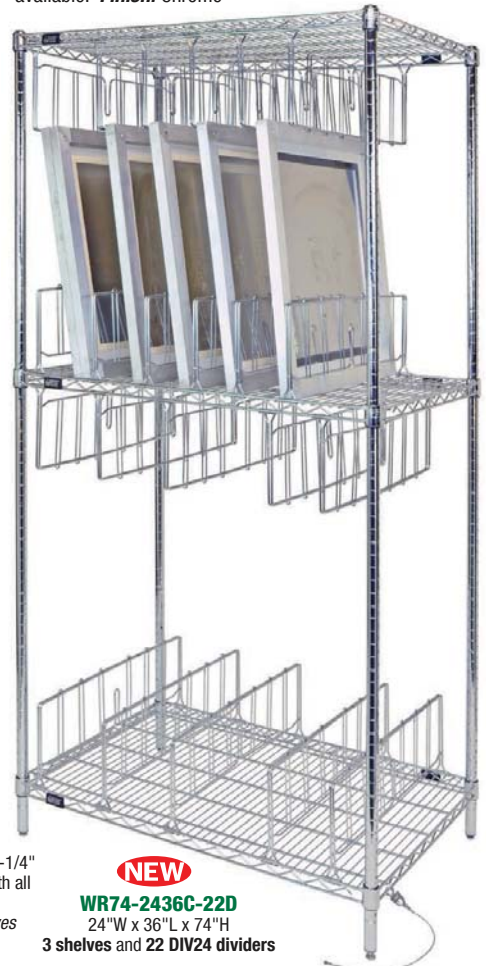

**NEW**  
**WR74-2436C-22D**  
24"W x 36"L x 74"H  
3 shelves and 22 DIV24 dividers



Clear Tip Out Bins



THE ORIGINAL AND INDUSTRY STANDARD

Space saving bin units keep small and medium sized parts organized, sorted and easy to find. These clear, break resistant injection molded plastic containers tip open smoothly to a 45° angle and are completely removable for easy access and refilling. Molded handle with slots for labels provided. Bins are easily cleaned with soap and water. Polystyrene cabinet can be stacked or wall mounted. Exterior available in 3 colors. Cups are clear. Optional dividers, locking rod and louvered panel bracket also available.

Available in: ● Ivory ● Gray ○ White

MODEL NO.	OUTSIDE DIMENSIONS L" x W" x H"	CUP DIMENSIONS L" x W" x H"	CTN QTY	CTN WGT
QTB301	11-3/4" x 11-13/16" x 13-7/8"	8-7/8" x 11-1/16" x 13-5/8"	1	7 lbs
QTB302	11-3/4" x 23-5/8" x 13-7/8"	8-7/8" x 11-1/16" x 13-5/8"	1	14 lbs
QTB303	7-3/4" x 23-5/8" x 9-1/2"	5-7/8" x 7-3/8" x 8-5/8"	1	9 lbs
QTB304	6-5/8" x 23-5/8" x 8-1/8"	5" x 5-5/8" x 7-1/2"	1	7 lbs
QTB305	5-1/4" x 23-5/8" x 6-1/2"	3-3/4" x 4-1/4" x 5-3/4"	1	5 lbs
QTB306	3-5/8" x 23-5/8" x 4-1/2"	2-5/8" x 3-1/2" x 3-3/4"	1	2 lbs
QTB309	2-1/2" x 23-5/8" x 3-1/8"	1-3/4" x 2-3/16" x 2-1/2"	1	2 lbs
DIV303	3 Dividers for QTB303		3	2 lbs
DIV304	4 Dividers for QTB304		4	1 lb
QLR500	Locking Rod for 23-5/8"W Tip Out Bins		1	1 lb
QTB-LP-BKT	Louvered Panel Bracket Pair for Tip Out Bins (Sold as a pair)		2	1 lb

TIP OUT BIN CLEAR COMPARTMENTS KEEP SMALL ITEMS SORTED AND EASY TO FIND

QTB309



QTB306



QTB305



QTB304



QTB303



QTB302



QTB-LP-BKT Louvered Panel Bracket Hang 23-5/8"W bin on louvered panel using bracket. Available in Beige or Gray. Panels available on pg. 8.



DIV303 and DIV304 QTB303 and QTB304 cup can use optional divider, as shown.



QLR500 Locking Rod Keeps bins from tilting open. Can be used with 23-5/8"W bins.



QTB309



QTB306



QTB305



QTB304



QTB303



QTB302



QTB301

TIP OUT BIN



# CLEAR TIP OUT BIN SYSTEMS CAN BE USED IN ANY APPLICATION



## INDUSTRIAL, MECHANICAL AND PLUMBING SUPPLIES

Very handy for the garage, tool shed, service vehicle, factory, hardware and home center facilities.



## MEDICAL

Very efficient when it comes to organizing and keeping an effective inventory in hospitals, pharmacies, labs or clinics.



## PLAYROOM

The smartest organizer after a hard day's play. It will help keep your child's room in order.

## Individual Tip Out Bins



These unique bins have the ability to interlock horizontally or vertically. Available in three popular sizes, these bins allow you to create your own customized Tip Out Bin storage system perfect for color coding.

**QTB405 and QTB406** available in: ● Ivory ● Gray ○ White  
**QTB409** available in: ● Blue ● Red ● Yellow ○ White

MODEL NO.	OUTSIDE DIMENSIONS L" x W" x H"	CTN QTY	CTN WGT
QTB405	5-1/4" x 4-3/4" x 6-1/4"	5	6 lbs
QTB406	3-5/8" x 4-1/16" x 4-1/4"	6	4 lbs
QTB409	2-3/8" x 2-13/16" x 3"	9	3 lbs

## BINS INTERLOCK

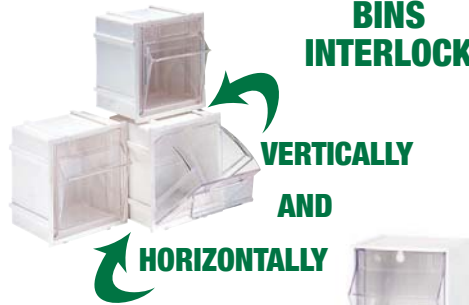

QTB409



QTB406



QTB405

## Dividable Tip Out Bins



These bins feature removable and adjustable dividers so that the clear bin can be partitioned into smaller compartments. Ideal for larger or longer items, these clear Tip Out Bins are molded from the same strong and flexible material as our standard bins. The flexibility of bins allow the user to determine the size and volume of each storage compartment. Exterior available in 3 colors. Cups are clear.

Available in: ● Ivory ● Gray ○ White

MODEL NO.	OUTSIDE DIMENSIONS L" x W" x H"	CTN QTY	CTN WGT
QTB410	5-1/4" x 11-7/8" x 5-15/16"	1	3 lbs
QTB411	5-1/4" x 23-5/8" x 5-15/16"	1	4 lbs
QTB412	5-1/4" x 23-5/8" x 5-15/16"	1	4 lbs
DIV400	Divider for Dividable Tip Out Bins	4	1 lb

## PERFORMANCE FEATURES:

- Dividable Tip Out Bins are available in 3 sizes (2 with the same width)
- Bins can be stacked as modular units or used individually
- Exterior housing is injection molded from high impact Polystyrene
- Clear bin cups are injection molded from a custom blend of Phillips K Resin and Crystal Styrene for clarity and durability
- Compartments tip open smoothly to a 45° angle and provide comfortable and complete access to stored items
- The flexibility of the system allows you to customize your own system to meet your specific needs



**QTB410**  
 QTB410 is a one bin design, 12" wide. Each QTB410 comes with 3 DIV400 clear dividers\*



**QTB411**  
 QTB411 is a two bin design, each bin 12" wide. Each QTB411 comes with 6 DIV400 clear dividers\*



**QTB412**  
 QTB412 is a one bin design, 23-5/8" wide. Each QTB412 comes with 5 DIV400 clear dividers\*

\*Note: Dividers shown in white color for clarity



**NEW**  
 QTB669

## 21 Compartment Tip Out Bin Set



- 21 clear cups inside one unit
- Clear cups with blue handles

**NEW**

TIP OUT BIN

Available in: ● Gray

MODEL NO.	OUTSIDE DIMENSIONS L" x W" x H"	CUP DIMENSIONS L" x W" x H"	CUP QTY	PKG QTY	PKG WGT
QTB669	3-5/8" x 23-5/8" x 11-1/6"	2-5/8" x 3-1/2" x 3-3/4" 1-3/4" x 2-3/16" x 2-1/2"	12 9	4	24 lbs





### Clear Tip Out Bin Rails

Provide an easy and efficient way to build a high density expandable storage system. U-channel shaped rails allow Tip Out Bins to slide easily to any height. Each Tip Out Bin needs 2 disks and 2 screws (QDS300) in order to affix to all rails and frames. (Bins are sold separately). Powder coat finish.



Utilize rails when base of the first bin will sit on the floor

## HOW TIP OUT BINS AFFIX TO RAILS AND FRAMES



1 Having removed transparent clear cups, insert screw corresponding to screw holes in Tip Out Bin housing.



2 Insert screws and screw into disk on back of Tip Out Bin housing.



3 Insert disk into frame rails.



4 Once in place, tighten screws to affix Tip Out Bin to frame rails.

Available in: ● Black

MODEL NO.	DESCRIPTION	CTN QTY	CTN WGT	NO. OF BINS TO FIT EACH FRAME					
				QTB 302	QTB 303	QTB 304	QTB 305	QTB 306	QTB 309
QTR24	Two 24"H Rails	1 Set	2 lbs	1	2	3	3	5	8
QTR48	Two 48"H Rails	1 Set	4 lbs	3	5	6	7	10	16
QTR70	Two 70"H Rails	1 Set	5 lbs	5	7	8	10	15	23

### Clear Tip Out Bin Frames

Frames are manufactured with preset parallel distance allowing Tip Out Bins to be stacked and removed easily and efficiently. All frames have a ledge at the bottom allowing Tip Out Bins to be secured above ground level. Each Tip Out Bin needs 2 disks and 2 screws (QDS300) in order to affix to all rails and frames. (Bins are sold separately). Powder coat finish.



Utilize frame when bins will be mounted above floor level

Available in: ● Black

MODEL NO.	DESCRIPTION	CTN QTY	CTN WGT	NO. OF BINS TO FIT EACH FRAME					
				QTB 302	QTB 303	QTB 304	QTB 305	QTB 306	QTB 309
QTF24	24"H Frame	1	3 lbs	1	2	3	3	5	8
QTF48	48"H Frame	1	5 lbs	3	5	6	7	10	16
QTF70	70"H Frame	1	7 lbs	5	7	8	10	15	23



QTF320-42 Complete Frame System with Bins

TIP OUT ABOUT TIP OUT ABOUT TIP OUT ABOUT TIP OUT



QDS300 Disk and Screw (Sold separately)

QLR500 Locking Rod

Keeps bins from tilting open

Frame and Locking Rod available in: ● Black

MODEL NO.	DESCRIPTION	CTN QTY	CTN WGT
QTF320	24"W x 15"H Portable Frame Only	1	3 lbs
QDS300*	2 Disks and 2 Screws	1 Set	1 lb
QLR500	Locking Rod	1	1 lb
QTF320-42	Complete Frame System with Bins	1	20 lbs

\*In order to attach a Tip Out Bin system to a rail, frame or floor stand, 1 set of disks and screws are required per Tip Out Bin system



QTF320 Portable Frame (Bins sold separately)

**Clear Tip Out Bin Floor Stands - Single, Double and Mobile**  
**Clearly your best storage solution**

Nine pre-configured systems available as pictured allowing you to purchase your Tip Out system exactly as shown here. The flexibility of the system also allows you to customize and create your own configurations (*see chart for all possibilities*). All steel systems are formed from heavy-duty 14 gauge steel and have a powder coat finish ensuring years of use. Three different heights to choose from: 24", 48" or 70". Systems are single sided, double sided or double sided mobile. Tip Out Bins are available in 3 exterior colors. See **pg. 87** for bin dimensions.

**SINGLE SIDED**  
**300 lb.**  
**LOAD CAPACITY**

**QFS124-31**  
1 QTB304  
3 QTB306  
1 QTB309



**QFS148-38**  
1 QTB302  
1 QTB303  
1 QTB304  
1 QTB305  
1 QTB306  
2 QTB309



**QFS170-36**  
4 QTB303  
2 QTB304  
2 QTB305  
1 QTB306



**TIP OUT**  
**OUT**  
**OUT**  
**OUT**  
**OUT**  
**BIN**

**COMPLETE PACKAGES**  
**WITH BINS**

**DOUBLE SIDED**  
**600 lb.**  
**LOAD CAPACITY**

**QFS224-24**  
2 QTB303  
2 QTB304  
2 QTB305



**QFS248-76**  
2 QTB302  
2 QTB303  
2 QTB304  
2 QTB305  
2 QTB306  
4 QTB309



**QFS270-72**  
8 QTB303  
4 QTB304  
4 QTB305  
2 QTB306





# CREATE YOUR OWN CUSTOM CONFIGURATION

Mobile Clear Tip Out Bin Floor Stands

## COMPLETE PACKAGES WITH BINS



wall frames    single sided    double sided    double sided mobile



TIP OUT  
TIP OUT  
TIP OUT  
TIP OUT  
BIN

**QFS224-24 + QFS400**  
2 QTB303  
2 QTB304  
2 QTB305



**QFS270-72 + QFS400**  
8 QTB303  
4 QTB304  
4 QTB305  
2 QTB306



**QFS248-76 + QFS400**  
2 QTB302  
2 QTB303  
2 QTB304  
2 QTB305  
2 QTB306  
4 QTB309

**MOBILE 500 lb. LOAD CAPACITY**

Bins available in: ● Ivory ● Gray ○ White

MODEL NO.	DESCRIPTION	DIMENSIONS D" x W" x H"	CTN WGT	QTY. OF BINS TO FIT SYSTEM								
				QTB 302	QTB 303	QTB 304	QTB 305	QTB 306	QTB 309			
<b>Floor Stands - Single Sided (Disks and Screws Required)</b>												
QFS124	24"H Single Sided (Workstation)	10" x 23-5/8" x 28"	11 lbs	1	2	3	3	5	8			
QFS148	48"H Single Sided	10" x 23-5/8" x 52"	19 lbs	3	5	6	7	11	16			
QFS170	70"H Single Sided	10" x 23-5/8" x 75"	20 lbs	5	7	8	10	15	23			
<b>Floor Stands - Double Sided (Disks and Screws Required)</b>												
QFS224	24"H Double Sided (Workstation)	20-1/4" x 23-5/8" x 28"	21 lbs	2	4	6	6	10	16			
QFS248	48"H Double Sided	20-1/4" x 23-5/8" x 52"	36 lbs	6	10	12	14	22	32			
QFS270	70"H Double Sided	20-1/4" x 23-5/8" x 75"	42 lbs	10	14	16	20	30	46			
<b>Mobile Kit (Includes four casters and one handle)</b>												
QFS400*	Mobile Kit for Double Sided Systems		9 lbs	-	-	-	-	-	-			
<b>Disks and Screws</b>												
QDS300	2 Disks and 2 Screws (1 set)		1 lb	-	-	-	-	-	-			

(Tip Out Bins sold separately) 1 set of disks and screws are required per Tip Out Bin system \*All mobile units come with four 3" polyurethane casters(all with brakes)



**Free Standing Slider Systems**  
- Complete Packages

**CONVERT 8' OF STORAGE SPACE INTO JUST 4'**

Sliders feature four individual panels filled with tip out bins. Two are fixed to the back side of the system and two slide easily from left to right allowing free access to all four panels. Manufactured of tough 14 gauge steel with a baked enamel finish, the overall unit measures 18"D x 48"W x 77"H or 26"D x 51"W x 77"H. Heavy-duty 2,000 lb. capacity. Bins are available in 3 exterior colors.

**TIP OUT BIN**

Bins available in: ● Ivory ● Gray ○ White

MODEL NO.	NO. OF BINS	NO. OF BIN CUPS
QS-304-28	28 QTB304	112
QS-305-36	36 QTB305	180
QS-306-56	56 QTB306	336
QS-309-80	80 QTB309	336
QS-305306-52	9 QTB305, 43 QTB306	720
QS-569-56	8 QTB305, 36 QTB306, 12 QTB309	364
QS-BIG-101	3 QTB302, 8 QTB303, 14 QTB304, 3 QTB305	101
QS-000	Free Standing Slider Only - NO BINS	-

\*All necessary hardware included with all systems

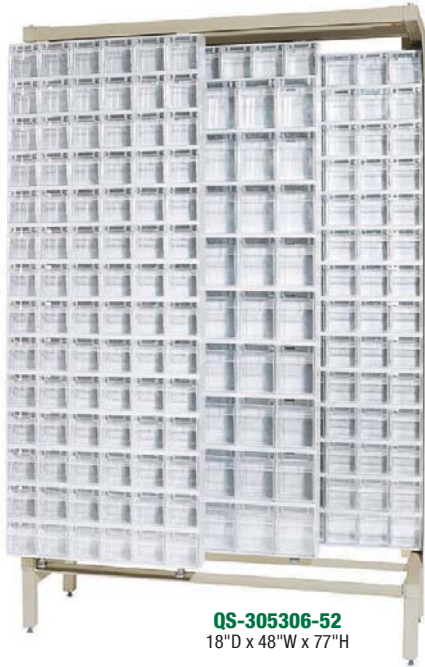

**QS-305306-52**  
18"D x 48"W x 77"H



**QS-569-56**  
18"D x 48"W x 77"H



**QS-BIG-101**  
26"D x 51-1/4"W x 77"H  
To be used with QTB302 and QTB303

**Gondola Slider Systems**  
- Complete Packages

Gondola systems provide the same versatility for orderly and efficient storage solutions in merchandising, inventory control and storing of small to medium sized parts. Metal slider systems affix heavy-duty 2,000 capacity to most standard gondolas.

Units available for purchase in the following three ways:

- Slider Frame Only (designed for fast installation on your existing 72"H Gondola). **QS-725**
- Slider Frame with Gondola (no Tip Out Bins) Overall Dimensions 19"D x 48"W x 75"H. **G-725**
- Slider Frame filled with Tip Out Bins with Gondola - Complete Package (five available combinations, see chart below).

Bins available in: ● Ivory ● Gray ○ White

MODEL NO.	NO. OF BINS	NO. OF BIN CUPS
QS-725	Slider Frame Only	-
G-725	Slider Frame with Gondola	-
G-725304-28	28 QTB304	112
G-725305-36	36 QTB305	180
G-725306-56	56 QTB306	336
G-725309-80	80 QTB309	720
G-725569-56	8 QTB305, 36 QTB306, 12 QTB309	364

\*All necessary hardware included with all systems

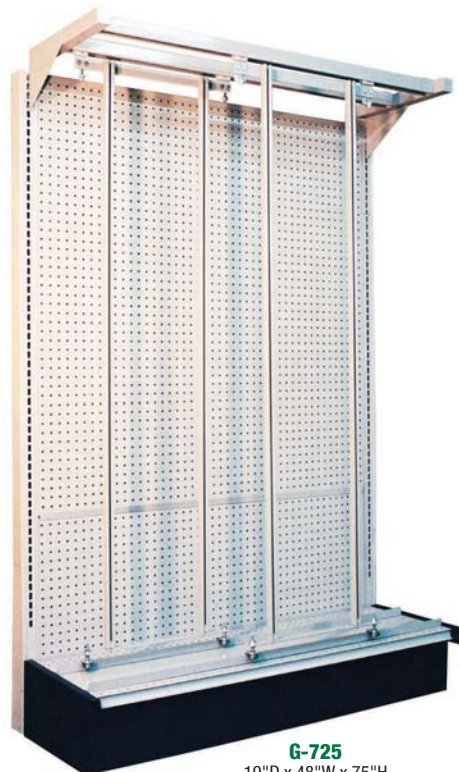

**G-725**  
19"D x 48"W x 75"H

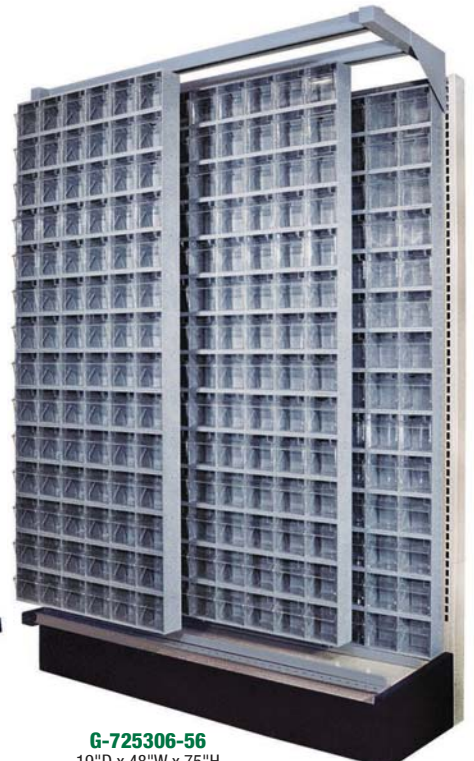

**G-725306-56**  
19"D x 48"W x 75"H



**Clear Tip Out Bin Cabinets**



**NEW** **QSC-QTB36-35**  
Clear Tip Out Bin Small Cabinet  
26-1/4"W x 10"D x 36-1/2"H  
Total of **35** clear cups. **1** QTB304, **2** QTB305,  
**2** QTB306, **1** QTB309. Available in Gray.  
Ship wt. 84 lbs.

**CABINETS AVAILABLE  
IN GRAY COLOR**



**TOP AND BOTTOM  
HEAVY-DUTY DOOR LOCK**

**Clear Tip Out Bin Cart**

**TIP  
OUT  
TIP  
OUT  
TIP  
OUT  
TIP  
OUT  
BIN**

**COMPLETE  
PACKAGES  
WITH BINS**

**ALL ARRIVE  
FULLY ASSEMBLED  
READY TO USE**



**TBC-32WT**  
Clear Tip Out Bin Cart  
19-1/2"L x 25"W x 41"H  
Total of **32** clear cups. **2** QTB305, **4** QTB304,  
**2** QTB303. Comes fully assembled, ready to use.  
Available in White. Ship wt. 75 lbs.



**NEW** **QSC-QTB79-61**  
Clear Tip Out Bin Tall Cabinet  
26-1/4"W x 10"D x 79-1/2"H  
Total of **61** clear cups.  
**3** QTB304, **5** QTB305, **4** QTB306.  
Available in Gray.  
Ship wt. 185 lbs.

- Fully welded strong construction
- Epoxy powder coating
- Metal hinges with 180° opening



**COMBINATION LOCK**  
(Cabinet also comes with master key for combination override)

**4 Color Tip Out Bin Spinner**

**SPINS  
360°**



**PERFECT FOR  
COLOR CODING YOUR  
INVENTORY**

Clear cups handles come in:

- Blue • Red
- Yellow • Green

**NEW** **QTB-SPIN148**  
Clear Tip Out Bin Spinner  
37"W x 48"H  
700 lb. load capacity. Total of **148** clear cups.  
**4** QTB304, **12** QTB305, **12** QTB306.  
Available in Gray with 4 colored sides.  
Ship wt. 134 lbs.



**Interlocking Storage Cabinets**



Organize and store your small parts with these modular storage cabinets. Quantum's interlocking storage cabinets have the unique ability to interlock horizontally and vertically allowing you to customize your storage needs and maximize your storage space. Pre-drilled holes on the rear of cabinet allow for wall mounting. Cabinets are made from high impact polystyrene. Drawers are removable and will not rust or corrode. Drawers have a recessed handle and come with a slotted label holder. Drawers have seven divider slots molded-in so that they may be divided into multiple compartments. Clear window allows easy identification of parts. Nine pre-configured interlocking storage cabinet systems come complete with drawers, clear windows and two dividers per drawer. Additional dividers may be purchased separately. Exterior cabinets are available in Gray only.

Cabinets have the unique ability to interlock horizontally and vertically allowing you to customize your storage needs and maximize your storage space.



Cabinets available in: ● Gray  
 Drawers available in: ● Blue ● Red ● Ivory ● Gray

MODEL NO.	DRAWERS PER CABINET	CTN QTY	CTN WGT
<b>QIC-161</b>	16 IDR201	1	10 lbs
<b>QIC-122</b>	12 IDR202	1	10 lbs
<b>QIC-83</b>	8 IDR203	1	9 lbs
<b>QIC-64</b>	6 IDR204	1	9 lbs
<b>QIC-8143</b>	8 IDR201, 4 IDR203	1	10 lbs
<b>QIC-12123</b>	12 IDR201, 2 IDR203	1	10 lbs
<b>QIC-4163</b>	4 IDR201, 6 IDR203	1	10 lbs
<b>QIC-8224</b>	8 IDR202, 2 IDR204	1	10 lbs
<b>QIC-4244</b>	4 IDR202, 4 IDR204	1	10 lbs



**CABINET SYSTEMS COME COMPLETE WITH DRAWERS, CLEAR WINDOWS AND TWO DIVIDERS PER DRAWER**

**QIC-161**  
 All units measure overall 11-3/8"D x 11-3/4"W x 11"H  
 System comes with **16 IDR201**.  
 Available with Gray Cabinet and your choice of Gray, Blue, Red and Ivory for drawers.



**QIC-122**



**QIC-83**



**QIC-64**



**QIC-8143**



**QIC-12123**



**QIC-4163**



**QIC-8224**



**QIC-4244**

**COLOR CODE YOUR SMALL PARTS**

**Cabinet Drawers**

Additional drawers may be purchased separately. All drawers come complete with a clear window. Optional dividers may be purchased separately.



Available in: ● Blue ● Red ● Ivory ● Gray

MODEL NO.	DIMENSIONS L" x W" x H"	CTN QTY	CTN WGT	DIVIDER	CTN QTY	CTN WGT
<b>IDR201</b>	11" x 2-3/4" x 2-1/2"	24	9 lbs	<b>DIV201</b>	25	1 lb
<b>IDR202</b>	11" x 2-3/4" x 3-5/16"	24	12 lbs	<b>DIV202</b>	25	1 lb
<b>IDR203</b>	11" x 5-5/8" x 2-1/2"	24	14 lbs	<b>DIV203</b>	25	1 lb
<b>IDR204</b>	11" x 5-5/8" x 3-5/16"	24	22 lbs	<b>DIV204</b>	25	2 lbs



# COMPLETE PACKAGES WITH BINS

## Interlocking Storage Cabinet Floor Stands - Single, Double and Mobile

24 pre-configured systems provide an assortment of storage solutions to meet every need. All steel systems are formed from heavy-duty 14 gauge steel and have a smooth powder coat finish ensuring years of use. Three different heights to choose from: 24", 48" or 70". Units are single sided or double sided. Double-sided systems can be made mobile with the addition of the **QFS-400 (mobile kit)** four 3" polyurethane casters all with brakes and 500 lb. capacity. All single sided and double sided systems must be securely fastened to the floor to ensure stability. Interlocking storage cabinet systems come complete with drawers, clear windows and two dividers per drawer. Exterior cabinets are available in Gray only.

**QIC-270-161****384**  
drawers**192**  
drawers

### HIGH DENSITY STORAGE

**32**  
drawers**QIC-124-83****QIC-248-122 + QFS-400**

All mobile units come with four 3" polyurethane casters, all with brakes and 500 lb. capacity

Cabinets available in: ● Gray    Drawers available in: ● Blue ● Red ● Ivory ● Gray

**COMPLETE STORAGE CABINET FLOOR STANDS**

SINGLE SIDED - 300 LB. LOAD CAPACITY				DOUBLE SIDED - 750 LB. LOAD CAPACITY			
MODEL NO.	CABINET PER FLOOR STAND	NO. OF DRAWERS	SHIP WGT	MODEL NO.	CABINET PER FLOOR STAND	NO. OF DRAWERS	SHIP WGT
<b>24"H - Single Sided Floor Stands</b>				<b>24"H - Double Sided Floor Stands</b>			
<b>QIC-124-161</b>	4 QIC-161	64	52 lbs	<b>QIC-224-161</b>	8 QIC-161	128	102 lbs
<b>QIC-124-122</b>	4 QIC-122	48	52 lbs	<b>QIC-224-122</b>	8 QIC-122	96	102 lbs
<b>QIC-124-83</b>	4 QIC-83	32	48 lbs	<b>QIC-224-83</b>	8 QIC-83	64	94 lbs
<b>QIC-124-64</b>	4 QIC-64	24	48 lbs	<b>QIC-224-64</b>	8 QIC-64	48	94 lbs
<b>48"H - Single Sided Floor Stands</b>				<b>48"H - Double Sided Floor Stands</b>			
<b>QIC-148-161</b>	8 QIC-161	128	100 lbs	<b>QIC-248-161</b>	16 QIC-161	256	196 lbs
<b>QIC-148-122</b>	8 QIC-122	96	100 lbs	<b>QIC-248-122</b>	16 QIC-122	192	196 lbs
<b>QIC-148-83</b>	8 QIC-83	64	92 lbs	<b>QIC-248-83</b>	16 QIC-83	128	180 lbs
<b>QIC-148-64</b>	8 QIC-64	48	92 lbs	<b>QIC-248-64</b>	16 QIC-64	96	180 lbs
<b>70"H - Single Sided Floor Stands</b>				<b>70"H - Double Sided Floor Stands</b>			
<b>QIC-170-161</b>	12 QIC-161	192	140 lbs	<b>QIC-270-161</b>	24 QIC-161	384	282 lbs
<b>QIC-170-122</b>	12 QIC-122	144	140 lbs	<b>QIC-270-122</b>	24 QIC-122	288	282 lbs
<b>QIC-170-83</b>	12 QIC-83	96	129 lbs	<b>QIC-270-83</b>	24 QIC-83	192	258 lbs
<b>QIC-170-64</b>	12 QIC-64	72	129 lbs	<b>QIC-270-64</b>	24 QIC-64	144	258 lbs

QFS-400 Kit for mobilizing double sided systems. Includes casters and handle. 500 lb. mobile load capacity.



**IRONMAN - Steel Shelving**

**PERFORMANCE FEATURES:**

- Heavy-duty, high grade shelving units are easy to clean and will not rust or corrode
- Shelving Units are 39"H or 75"H and are available in three different shelf sizes
- Shelving has a smooth powder coat finish
- 400 lb. shelf capacity
- Shelves assemble with 4 nuts and bolts per shelf



39-1836-4



75-1836-6

**CLOSED SHELVING  
DUST FREE AND SECURE  
STORAGE**



CL39-1836-4



CL75-1836-6

MODEL NO.	SHELF D" x W"	SHIP WGT
<b>4 Shelf - 39"H - Open Shelving Unit</b>		
39-1236-4	12" x 36"	45 lbs
39-1836-4	18" x 36"	63 lbs
<b>5 Shelf - 39"H - Open Shelving Unit</b>		
39-1236-5	12" x 36"	53 lbs
39-1836-5	18" x 36"	75 lbs
<b>6 Shelf - 39"H - Open Shelving Unit</b>		
39-1236-6	12" x 36"	61 lbs
39-1836-6	18" x 36"	87 lbs
<b>4 Shelf - 75"H - Open Shelving Unit</b>		
75-1236-4	12" x 36"	55 lbs
75-1836-4	18" x 36"	69 lbs
75-1842-4	18" x 42"	85 lbs
<b>5 Shelf - 75"H - Open Shelving Unit</b>		
75-1236-5	12" x 36"	66 lbs
75-1836-5	18" x 36"	79 lbs
75-1842-5	18" x 42"	91 lbs
<b>6 Shelf - 75"H - Open Shelving Unit</b>		
75-1236-6	12" x 36"	73 lbs
75-1836-6	18" x 36"	89 lbs
75-1842-6	18" x 42"	101 lbs
<b>7 Shelf - 75"H - Open Shelving Unit</b>		
75-1236-7	12" x 36"	80 lbs
75-1836-7	18" x 36"	99 lbs
75-1842-7	18" x 42"	113 lbs
<b>8 Shelf - 75"H - Open Shelving Unit</b>		
75-1236-8	12" x 36"	87 lbs
75-1836-8	18" x 36"	109 lbs
75-1842-8	18" x 42"	125 lbs



MODEL NO.	SHELF D" x W"	SHIP WGT
<b>4 Shelf - 39"H - Closed Shelving Unit</b>		
CL39-1236-4	12" x 36"	71 lbs
CL39-1836-4	18" x 36"	94 lbs
<b>5 Shelf - 39"H - Closed Shelving Unit</b>		
CL39-1236-5	12" x 36"	79 lbs
CL39-1836-5	18" x 36"	106 lbs
<b>6 Shelf - 39"H - Closed Shelving Unit</b>		
CL39-1236-6	12" x 36"	87 lbs
CL39-1836-6	18" x 36"	118 lbs
<b>4 Shelf - 75"H - Closed Shelving Unit</b>		
CL75-1236-4	12" x 36"	90 lbs
CL75-1836-4	18" x 36"	115 lbs
<b>5 Shelf - 75"H - Closed Shelving Unit</b>		
CL75-1236-5	12" x 36"	103 lbs
CL75-1836-5	18" x 36"	126 lbs
<b>6 Shelf - 75"H - Closed Shelving Unit</b>		
CL75-1236-6	12" x 36"	110 lbs
CL75-1836-6	18" x 36"	136 lbs
<b>7 Shelf - 75"H - Closed Shelving Unit</b>		
CL75-1236-7	12" x 36"	117 lbs
CL75-1836-7	18" x 36"	146 lbs
<b>8 Shelf - 75"H - Closed Shelving Unit</b>		
CL75-1236-8	12" x 36"	124 lbs
CL75-1836-8	18" x 36"	156 lbs





Wire Shelving Systems Finishes



6 WIRE FINISHES AVAILABLE

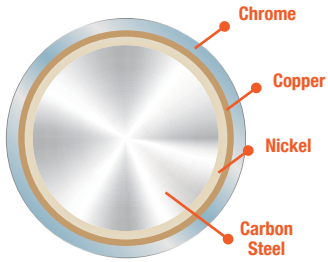

**Chrome** - is a plating process which deposits hard chrome over a copper, nickel surface. This process is very durable and allows product to be used in any application in a dry storage environment. **1 year limited warranty to not rust or corrode when used in dry and non-humid environments.**

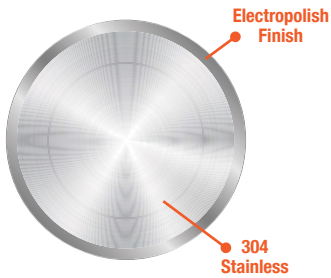
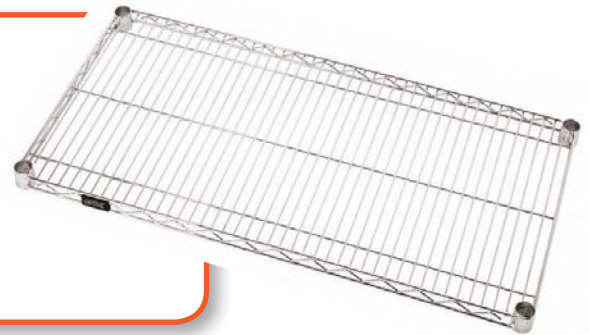

**Stainless Steel** - 304 Stainless with an electro-polish finish represents the highest industry standard in the prevention of corrosion. This finish is highly effective for corrosive, high humidity or clean room environments. **Lifetime warranty for 304 stainless steel electro-polish finish.**

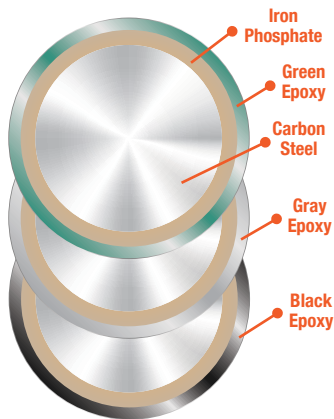
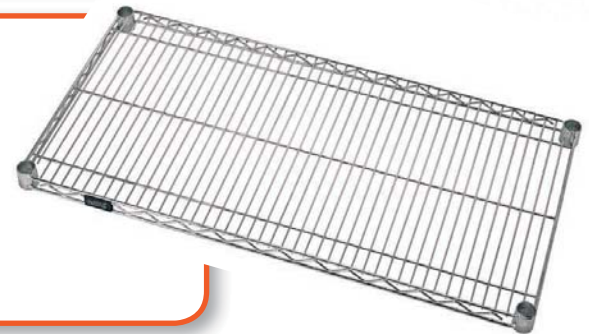

**NEW FINISH**

**Proform Green, Gray and Black Epoxy** - are an ideal solution for high humidity, wet, or walk-in-cooler applications. The carbon steel is treated with an iron phosphate and the powder coated epoxy is electrostatically applied, baked and cured to a hard surface. All three colors are antimicrobial. **15 year limited warranty for antimicrobial finish to not rust or corrode.**

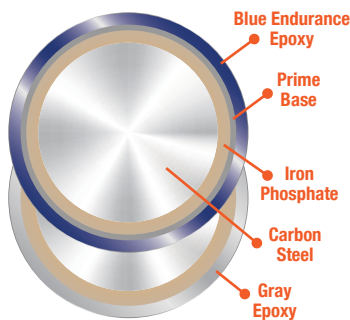
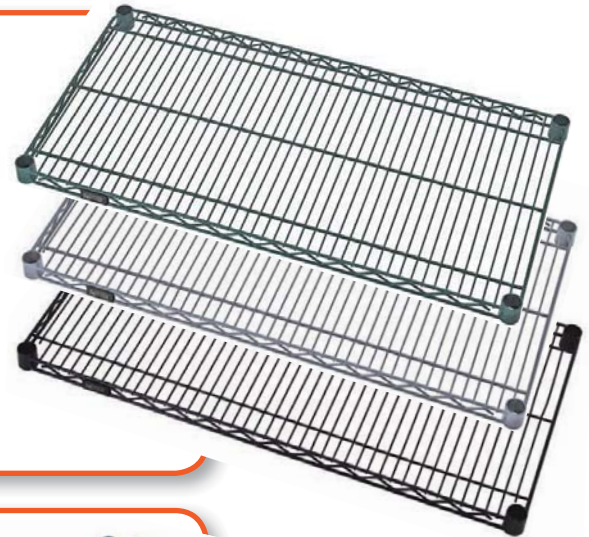

**NEW FINISH**

**Blue Endurance and Gray Epoxy** - is a developed process which exceeds conventional finishes. Finish is excellent for high humidity or corrosive applications and is fortified with an antimicrobial agent. **15 year limited warranty for antimicrobial finish to not rust or corrode.**

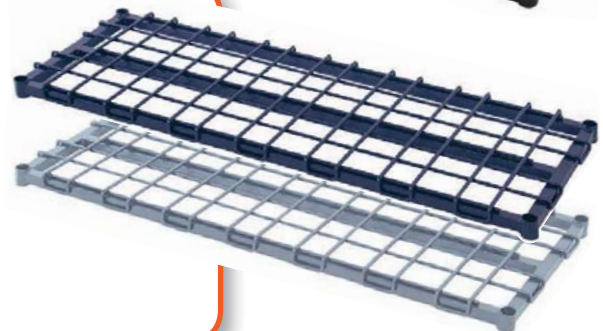

APPLICATION	CHROME FINISH	STAINLESS STEEL FINISH	PROFORM GREEN, GRAY & BLACK EPOXY FINISH	BLUE ENDURANCE FINISH
DRY STORAGE	YES	YES	YES	YES
WET STORAGE	NO	YES	YES	YES
COOLER STORAGE	NO	YES	YES	YES
FREEZER STORAGE	NO	YES	YES	YES
WARRANTY*	1 YEAR DRY	LIFETIME	15 YEAR	15 YEAR

\*Limited against rust and corrosion

Wire Shelves



Genuine Quantum modular wire systems offer a unique combination of shelf and post sizes in a variety of finishes to work in any application. The all welded shelf construction is supported with architectural wire trusses to provide between 600 lb. and 1,000 lb. capacity per shelf.



- CHROME
- 304 STAINLESS STEEL
- PROFORM GREEN EPOXY
- **NEW** GRAY EPOXY
- BLACK EPOXY
- GALVANIZED STEEL
- STAINLESS STEEL

PERFORMANCE FEATURES:

- All welded construction with additional wire trussing for high strength characteristics
- Top mat wires run front to back (except on 12" x 36" size) for ease of loading and unloading and superior strength
- Wire allows air to circulate and light to penetrate for increased product visibility
- Minimal dirt accumulation
- Split sleeve connectors secure shelf corners to posts
- Numbered grooved posts on 1 inch increments for quick assembly
- No tools required for assembly
- Adjustable foot levelers allow for perfect stability
- Durable finishes
- Aesthetically pleasing
- Optional accessories (see pgs. 146-148)
- National Sanitation Foundation (NSF) Approved
- Shipped KD Class 70
- 600 to 1,000 lb. capacity per shelf

600-800 lb.  
LOAD CAPACITY PER SHELF

1,000 lb.  
LOAD CAPACITY PER HEAVY-DUTY SHELF

SHELF W" x L"	SHIP WGT	CHROME	STAINLESS STEEL	EPOXY		
		MODEL NO.	MODEL NO.	PROFORM GREEN	GRAY <b>NEW</b>	BLACK
<b>12" Deep - Wire Shelves</b>						
12" x 24"	6 lbs	1224C	-	1224P	1224GY	1224BK
12" x 30"	6 lbs	1230C	-	1230P	1230GY	1230BK
12" x 36"	7 lbs	1236C	1236S	1236P	1236GY	1236BK
12" x 42"	8 lbs	1242C	-	1242P	1242GY	1242BK
12" x 48"	9 lbs	1248C	1248S	1248P	1248GY	1248BK
12" x 60"	14 lbs	1260C	1260S	1260P	1260GY	1260BK
12" x 72"	17 lbs	1272C	1272S	1272P	1272GY	1272BK
<b>14" Deep - Wire Shelves</b>						
14" x 24"	6 lbs	1424C	-	1424P	1424GY	1424BK
14" x 30"	7 lbs	1430C	1430S	1430P	1430GY	1430BK
14" x 36"	8 lbs	1436C	1436S	1436P	1436GY	1436BK
14" x 42"	10 lbs	1442C	1442S	1442P	1442GY	1442BK
14" x 48"	11 lbs	1448C	1448S	1448P	1448GY	1448BK
14" x 54"	12 lbs	1454C	1454S	1454P	1454GY	1454BK
14" x 60"	14 lbs	1460C	1460S	1460P	1460GY	1460BK
14" x 72"	17 lbs	1472C	1472S	1472P	1472GY	1472BK
<b>18" Deep - Wire Shelves</b>						
18" x 24"	7 lbs	1824C	1824S	1824P	1824GY	1824BK
18" x 30"	8 lbs	1830C	1830S	1830P	1830GY	1830BK
18" x 36"	10 lbs	1836C	1836S	1836P	1836GY	1836BK
18" x 42"	11 lbs	1842C	1842S	1842P	1842GY	1842BK
18" x 48"	14 lbs	1848C	1848S	1848P	1848GY	1848BK
18" x 54"	15 lbs	1854C	1854S	1854P	1854GY	1854BK
18" x 60"	17 lbs	1860C	1860S	1860P	1860GY	1860BK
18" x 72"	20 lbs	1872C	1872S	1872P	1872GY	1872BK
<b>21" Deep - Wire Shelves</b>						
21" x 24"	8 lbs	2124C	2124S	2124P	2124GY	2124BK
21" x 30"	9 lbs	2130C	2130S	2130P	2130GY	2130BK
21" x 36"	11 lbs	2136C	2136S	2136P	2136GY	2136BK
21" x 42"	12 lbs	2142C	2142S	2142P	2142GY	2142BK
21" x 48"	14 lbs	2148C	2148S	2148P	2148GY	2148BK
21" x 54"	16 lbs	2154C	2154S	2154P	2154GY	2154BK
21" x 60"	18 lbs	2160C	2160S	2160P	2160GY	2160BK
21" x 72"	24 lbs	2172C	2172S	2172P	2172GY	2172BK
<b>24" Deep - Wire Shelves</b>						
24" x 24"	9 lbs	2424C	2424S	2424P	2424GY	2424BK
24" x 30"	11 lbs	2430C	2430S	2430P	2430GY	2430BK
24" x 36"	13 lbs	2436C	2436S	2436P	2436GY	2436BK
24" x 42"	15 lbs	2442C	2442S	2442P	2442GY	2442BK
24" x 48"	16 lbs	2448C	2448S	2448P	2448GY	2448BK
24" x 54"	18 lbs	2454C	2454S	2454P	2454GY	2454BK
24" x 60"	21 lbs	2460C	2460S	2460P	2460GY	2460BK
24" x 66"	23 lbs	2466C	-	2466P	2466GY	-
24" x 72"	26 lbs	2472C	2472S	2472P	2472GY	2472BK
<b>24" Deep Heavy-Duty - Wire Shelves (1,000 lb. capacity)</b>						
24" x 60"	25 lbs	2460CHD	-	-	-	-
24" x 72"	30 lbs	2472CHD	-	-	-	-
<b>30" Deep - Wire Shelves</b>						
30" x 36"	15 lbs	3036C	3036S	3036P	3036GY	3036BK
30" x 42"	18 lbs	3042C	3042S	3042P	3042GY	3042BK
30" x 48"	21 lbs	3048C	3048S	3048P	3048GY	3048BK
30" x 60"	27 lbs	3060C	3060S	3060P	3060GY	3060BK
30" x 72"	31 lbs	3072C	3072S	3072P	3072GY	3072BK
<b>36" Deep - Wire Shelves</b>						
36" x 36"	18 lbs	3636C	3636S	3636P	3636GY	3636BK
36" x 48"	23 lbs	3648C	3648S	3648P	3648GY	3648BK
36" x 60"	29 lbs	3660C	3660S	3660P	3660GY	3660BK
36" x 72"	35 lbs	3672C	3672S	3672P	3672GY	3672BK



**W-PC**

**Replacement Post Cap**  
Additional pieces available  
(Sold as 4-pack)

**W-PC-STUD**

Threaded **Stud Connector** can be utilized to connect two posts enabling any post height to be achieved. Must be used with **WR-WMB** to secure to wall. See **pg. 148**

**LASER PRINTED NUMBERS**

For quick shelf positioning

**W-PLI**

**Post Insert**  
Additional pieces available  
(Sold as 4-pack)

**W-PLB**

**Post Leveler** adjusts up or down allowing height flexibility  
(Sold as 4-pack)



**Posts**



All posts are manufactured from 16 gauge carbon steel with numbered grooves on one inch increments and allow for shelf installation. Numbers are printed between grooves for quick assembly. Posts are double grooved in consistent intervals for additional quick identification. Post levelers and post inserts are enclosed with all posts. Inserts and levelers cannot be used in conjunction with stem casters. See **pg. 149** to order caster sets. Custom post heights are available, call for details.

**NEW GRAY FINISH**

DESCRIPTION	SHIP WGT	CHROME	STAINLESS STEEL	EPOXY		BLACK
		MODEL NO.	MODEL NO.	PROFORM GREEN	GRAY <b>NEW</b>	
6"H Post	1 lb	<b>P6C</b>	<b>P6S</b>	<b>P6P</b>	<b>P6GY</b>	<b>P6BK</b>
14"H Post	1 lb	<b>P14C</b>	<b>P14S</b>	<b>P14P</b>	<b>P14GY</b>	<b>P14BK</b>
34"H Post	2 lbs	<b>P34C</b>	<b>P34S</b>	<b>P34P</b>	<b>P34GY</b>	<b>P34BK</b>
36"H Post	2 lbs	<b>P36C</b>	-	-	-	-
39"H Post	2 lbs	<b>P39C</b>	-	-	-	<b>P39BK</b>
42"H Post	2 lbs	-	<b>P42S</b>	-	-	-
54"H Post	3 lbs	<b>P54C</b>	<b>P54S</b>	<b>P54P</b>	<b>P54GY</b>	<b>P54BK</b>
63"H Post	4 lbs	<b>P63C*</b>	<b>P63S</b>	<b>P63P*</b>	<b>P63GY*</b>	<b>P63BK*</b>
74"H Post	4 lbs	<b>P74C*</b>	<b>P74S</b>	<b>P74P*</b>	<b>P74GY*</b>	<b>P74BK*</b>
86"H Post	5 lbs	<b>P86C*</b>	<b>P86S</b>	<b>P86P*</b>	<b>P86GY*</b>	<b>P86BK*</b>
96"H Post	6 lbs	<b>P96C</b>	<b>P96S</b>	<b>P96P</b>	<b>P96GY</b>	<b>P96BK</b>

\*For easy installation, 63", 74" and 86" posts are available with pre-inserted leveler and bolt by adding an X to the Model No. **P74CX**

**Posts Label Holders**



New post label holders come in two sizes and allow for easy identification of aisles/rows as well as of wire cart contents. Attach to standard 1" diameter posts. Each package includes 12 clear holders and corresponding printer friendly sheet labels.

MODEL NO.	DIMENSIONS W" x L"	SHIP WGT
<b>PLH1X6C</b>	1" x 6"	1 lb
<b>PLH2X4C</b>	2" x 4"	1 lb



**400-600 lb. LOAD CAPACITY PER SHELF**

**Solid Shelves**



- Designed for storage of small parts that might normally fall through wire shelves
- Dual layer construction with double hemmed perimeter with marine edge ensures maximum strength while retaining spillage and excellent corrosion resistance

**18 GAUGE GALVANIZED 304 STAINLESS STEEL**



**ASSEMBLING WIRE SHELVING UNITS IS AS EASY AS 1 - 2 - 3...**



**1** Snap plastic sleeve around post.



**2** Slide shelf over sleeve for secure locking.



**3** Two "S-Hooks" are used to connect add-on wire shelf to starter units.

DIMENSIONS W" x L"	SHIP WGT	GALVANIZED STEEL	STAINLESS STEEL
		MODEL NO.	MODEL NO.
<b>14" Deep - Solid Shelves</b>			
14" x 36"	14 lbs	<b>1436SG</b>	<b>1436SS</b>
14" x 42"	15 lbs	<b>1442SG</b>	<b>1442SS</b>
14" x 48"	17 lbs	<b>1448SG</b>	<b>1448SS</b>
14" x 54"	20 lbs	<b>1454SG</b>	<b>1454SS</b>
14" x 60"	22 lbs	<b>1460SG</b>	<b>1460SS</b>
14" x 72"	26 lbs	<b>1472SG</b>	<b>1472SS</b>
<b>18" Deep - Solid Shelves</b>			
18" x 24"	11 lbs	<b>1824SG</b>	<b>1824SS</b>
18" x 30"	14 lbs	<b>1830SG</b>	<b>1830SS</b>
18" x 36"	16 lbs	<b>1836SG</b>	<b>1836SS</b>
18" x 42"	18 lbs	<b>1842SG</b>	<b>1842SS</b>
18" x 48"	20 lbs	<b>1848SG</b>	<b>1848SS</b>
18" x 54"	22 lbs	<b>1854SG</b>	<b>1854SS</b>
18" x 60"	24 lbs	<b>1860SG</b>	<b>1860SS</b>
18" x 72"	27 lbs	<b>1872SG</b>	<b>1872SS</b>
<b>21" Deep - Solid Shelves</b>			
21" x 24"	13 lbs	<b>2124SG</b>	<b>2124SS</b>
21" x 30"	15 lbs	<b>2130SG</b>	<b>2130SS</b>
21" x 36"	18 lbs	<b>2136SG</b>	<b>2136SS</b>
21" x 42"	21 lbs	<b>2142SG</b>	<b>2142SS</b>
21" x 48"	23 lbs	<b>2148SG</b>	<b>2148SS</b>
21" x 54"	25 lbs	<b>2154SG</b>	<b>2154SS</b>
21" x 60"	28 lbs	<b>2160SG</b>	<b>2160SS</b>
21" x 72"	30 lbs	<b>2172SG</b>	<b>2172SS</b>
<b>24" Deep - Solid Shelves</b>			
24" x 24"	15 lbs	<b>2424SG</b>	<b>2424SS</b>
24" x 30"	17 lbs	<b>2430SG</b>	<b>2430SS</b>
24" x 36"	19 lbs	<b>2436SG</b>	<b>2436SS</b>
24" x 42"	22 lbs	<b>2442SG</b>	<b>2442SS</b>
24" x 48"	24 lbs	<b>2448SG</b>	<b>2448SS</b>
24" x 54"	26 lbs	<b>2454SG</b>	<b>2454SS</b>
24" x 60"	31 lbs	<b>2460SG</b>	<b>2460SS</b>
24" x 72"	34 lbs	<b>2472SG</b>	<b>2472SS</b>



**Starter Kits**



Heavy-duty shelving units allow up to 800 lb. shelf capacity. Starter kits come complete with 4 posts and 4 or 5 shelves. Additional shelves may be purchased separately. See chart on *pg. 98*. Mobilize starter kit shelving unit using optional mobile kit, **WR-00H**, see *pg. 149*. **Finishes:** Chrome, Stainless Steel, Proform Green, Gray and Black Epoxy

**600-800 lb.  
LOAD CAPACITY PER SHELF**

**TO CHOOSE FINISH ADD FINISH SUFFIX TO MODEL NO.**

Ex: **Chrome** WR54-1236C  
**Stainless** WR54-1236S  
**Proform Green** WR54-1236P  
**Gray** WR54-1236GY  
**Black** WR54-1236BK

Ex: **Chrome** WR54-1236C-5  
**Stainless** WR54-1236S-5  
**Proform Green** WR54-1236P-5  
**Gray** WR54-1236GY-5  
**Black** WR54-1236BK-5

**Chrome**  
**Stainless**  
**Proform Green**  
**GY Gray**  
**BK Black**



**MOBILIZE YOUR WIRE SHELVING**

**DB - Donut Bumper**

Non-marking donut bumper used to protect walls and help cushion impact.

**WR-00H (Mobile Kit)\***

Set of four swivel thermoplastic resin 5" x 1-1/4" casters, two with brakes. Can be used with all units shown. 1,200 lb. load capacity. \*Mobile kits recommended only for shelves 18" and deeper.



**4 SHELF STARTER KIT**  
 Stainless Steel Finish



**5 SHELF STARTER KIT**  
 Chrome Finish

54"H - WIRE SHELVING 4 SHELVES				54"H - WIRE SHELVING 5 SHELVES				AVAILABLE	
STARTER KIT		ADD-ON KIT		STARTER KIT		ADD-ON KIT		FINISHES	
SHELF W" x L"	MODEL NO.	SHIP WGT	MODEL NO.	SHIP WGT	MODEL NO.	SHIP WGT	MODEL NO.	SHIP WGT	C S P G Y BK
12" x 36"	WR54-1236	40 lbs	AD54-1236	36 lbs	WR54-1236-5	47 lbs	AD54-1236-5	45 lbs	Y Y Y Y Y
12" x 42"	WR54-1242	44 lbs	AD54-1242	40 lbs	WR54-1242-5	52 lbs	AD54-1242-5	50 lbs	Y N Y Y Y
12" x 48"	WR54-1248	48 lbs	AD54-1248	44 lbs	WR54-1248-5	57 lbs	AD54-1248-5	55 lbs	Y Y Y Y Y
12" x 60"	WR54-1260	56 lbs	AD54-1260	52 lbs	WR54-1260-5	70 lbs	AD54-1260-5	68 lbs	Y Y Y Y Y
12" x 72"	WR54-1272	64 lbs	AD54-1272	60 lbs	WR54-1272-5	81 lbs	AD54-1272-5	79 lbs	Y Y Y Y Y
14" x 24"	WR54-1424	36 lbs	AD54-1424	32 lbs	WR54-1424-5	42 lbs	AD54-1424-5	40 lbs	Y N Y Y Y
14" x 30"	WR54-1430	40 lbs	AD54-1430	36 lbs	WR54-1430-5	47 lbs	AD54-1430-5	45 lbs	Y Y Y Y Y
14" x 36"	WR54-1436	44 lbs	AD54-1436	40 lbs	WR54-1436-5	52 lbs	AD54-1436-5	50 lbs	Y Y Y Y Y
14" x 42"	WR54-1442	52 lbs	AD54-1442	48 lbs	WR54-1442-5	62 lbs	AD54-1442-5	60 lbs	Y Y Y Y Y
14" x 48"	WR54-1448	56 lbs	AD54-1448	52 lbs	WR54-1448-5	67 lbs	AD54-1448-5	65 lbs	Y Y Y Y Y
14" x 54"	WR54-1454	60 lbs	AD54-1454	56 lbs	WR54-1454-5	72 lbs	AD54-1454-5	70 lbs	Y Y Y Y Y
14" x 60"	WR54-1460	68 lbs	AD54-1460	64 lbs	WR54-1460-5	82 lbs	AD54-1460-5	80 lbs	Y Y Y Y Y
14" x 72"	WR54-1472	80 lbs	AD54-1472	76 lbs	WR54-1472-5	97 lbs	AD54-1472-5	95 lbs	Y Y Y Y Y
18" x 24"	WR54-1824	40 lbs	AD54-1824	36 lbs	WR54-1824-5	47 lbs	AD54-1824-5	45 lbs	Y Y Y Y Y
18" x 30"	WR54-1830	44 lbs	AD54-1830	40 lbs	WR54-1830-5	52 lbs	AD54-1830-5	50 lbs	Y Y Y Y Y
18" x 36"	WR54-1836	52 lbs	AD54-1836	48 lbs	WR54-1836-5	62 lbs	AD54-1836-5	60 lbs	Y Y Y Y Y
18" x 42"	WR54-1842	56 lbs	AD54-1842	52 lbs	WR54-1842-5	67 lbs	AD54-1842-5	65 lbs	Y Y Y Y Y
18" x 48"	WR54-1848	60 lbs	AD54-1848	56 lbs	WR54-1848-5	74 lbs	AD54-1848-5	72 lbs	Y Y Y Y Y
18" x 54"	WR54-1854	72 lbs	AD54-1854	68 lbs	WR54-1854-5	87 lbs	AD54-1854-5	81 lbs	Y Y Y Y Y
18" x 60"	WR54-1860	80 lbs	AD54-1860	76 lbs	WR54-1860-5	97 lbs	AD54-1860-5	95 lbs	Y Y Y Y Y
18" x 72"	WR54-1872	92 lbs	AD54-1872	88 lbs	WR54-1872-5	112 lbs	AD54-1872-5	58 lbs	Y Y Y Y Y
21" x 24"	WR54-2124	44 lbs	AD54-2124	40 lbs	WR54-2124-5	52 lbs	AD54-2124-5	50 lbs	Y Y Y Y Y
21" x 30"	WR54-2130	48 lbs	AD54-2130	44 lbs	WR54-2130-5	57 lbs	AD54-2130-5	59 lbs	Y Y Y Y Y
21" x 36"	WR54-2136	56 lbs	AD54-2136	52 lbs	WR54-2136-5	67 lbs	AD54-2136-5	65 lbs	Y Y Y Y Y
21" x 42"	WR54-2142	60 lbs	AD54-2142	56 lbs	WR54-2142-5	72 lbs	AD54-2142-5	70 lbs	Y Y Y Y Y
21" x 48"	WR54-2148	68 lbs	AD54-2148	64 lbs	WR54-2148-5	82 lbs	AD54-2148-5	84 lbs	Y Y Y Y Y
21" x 54"	WR54-2154	76 lbs	AD54-2154	72 lbs	WR54-2154-5	92 lbs	AD54-2154-5	94 lbs	Y Y Y Y Y
21" x 60"	WR54-2160	84 lbs	AD54-2160	80 lbs	WR54-2160-5	102 lbs	AD54-2160-5	108 lbs	Y Y Y Y Y
21" x 72"	WR54-2172	108 lbs	AD54-2172	104 lbs	WR54-2172-5	132 lbs	AD54-2172-5	130 lbs	Y Y Y Y Y
24" x 24"	WR54-2424	48 lbs	AD54-2424	44 lbs	WR54-2424-5	57 lbs	AD54-2424-5	55 lbs	Y Y Y Y Y
24" x 30"	WR54-2430	56 lbs	AD54-2430	52 lbs	WR54-2430-5	67 lbs	AD54-2430-5	65 lbs	Y Y Y Y Y
24" x 36"	WR54-2436	64 lbs	AD54-2436	60 lbs	WR54-2436-5	77 lbs	AD54-2436-5	75 lbs	Y Y Y Y Y
24" x 42"	WR54-2442	72 lbs	AD54-2442	68 lbs	WR54-2442-5	87 lbs	AD54-2442-5	85 lbs	Y Y Y Y Y
24" x 48"	WR54-2448	76 lbs	AD54-2448	72 lbs	WR54-2448-5	92 lbs	AD54-2448-5	90 lbs	Y Y Y Y Y
24" x 54"	WR54-2454	84 lbs	AD54-2454	80 lbs	WR54-2454-5	102 lbs	AD54-2454-5	100 lbs	Y Y Y Y Y
24" x 60"	WR54-2460	96 lbs	AD54-2460	92 lbs	WR54-2460-5	117 lbs	AD54-2460-5	115 lbs	Y Y Y Y Y
24" x 72"	WR54-2472	116 lbs	AD54-2472	112 lbs	WR54-2472-5	142 lbs	AD54-2472-5	142 lbs	Y Y Y Y Y
30" x 36"	WR54-3036	72 lbs	AD54-3036	68 lbs	WR54-3036-5	87 lbs	AD54-3036-5	85 lbs	Y Y Y Y Y
30" x 42"	WR54-3042	84 lbs	AD54-3042	80 lbs	WR54-3042-5	102 lbs	AD54-3042-5	100 lbs	Y Y Y Y Y
30" x 48"	WR54-3048	96 lbs	AD54-3048	92 lbs	WR54-3048-5	117 lbs	AD54-3048-5	115 lbs	Y Y Y Y Y
30" x 60"	WR54-3060	120 lbs	AD54-3060	116 lbs	WR54-3060-5	147 lbs	AD54-3060-5	145 lbs	Y Y Y Y Y
30" x 72"	WR54-3072	136 lbs	AD54-3072	132 lbs	WR54-3072-5	167 lbs	AD54-3072-5	165 lbs	Y Y Y Y Y
36" x 36"	WR54-3636	84 lbs	AD54-3636	80 lbs	WR54-3636-5	102 lbs	AD54-3636-5	100 lbs	Y Y Y Y Y
36" x 48"	WR54-3648	104 lbs	AD54-3648	100 lbs	WR54-3648-5	127 lbs	AD54-3648-5	125 lbs	Y Y Y Y Y
36" x 60"	WR54-3660	128 lbs	AD54-3660	124 lbs	WR54-3660-5	157 lbs	AD54-3660-5	155 lbs	Y Y Y Y Y
36" x 72"	WR54-3672	136 lbs	AD54-3672	132 lbs	WR54-3672-5	171 lbs	AD54-3672-5	169 lbs	Y Y Y Y Y

Shelving units include 4 posts and 4 or 5 shelves. Add-On units include 2 posts, 4 or 5 shelves and 8 or 10 S-Hooks. Y (Yes) N (No)



Add-On Kits

Additional Add-On kits allow you to expand your Starter kit by sharing a middle set of posts. Configuration options include side to side, back to back and right angles (L-Shape). Add-On kits come complete with 2 posts, 4 or 5 shelves and 8 or 10 S-Hooks. Additional shelves and posts may be purchased separately. See chart on pg. 98. Units with Add-On kits cannot be made mobile. Finishes: Chrome, Stainless Steel, Proform Green, Gray and Black Epoxy

600-800 lb. LOAD CAPACITY PER SHELF

TO CHOOSE FINISH ADD FINISH SUFFIX TO MODEL NO.

Ex: Chrome WR63-1236C
Stainless WR63-1236S
Proform Green WR63-1236P
Gray WR63-1236GY
Black WR63-1236BK

Ex: Chrome WR63-1236C-5
Stainless WR63-1236S-5
Proform Green WR63-1236P-5
Gray WR63-1236GY-5
Black WR63-1236BK-5

Chrome
Stainless
Proform Green
GY Gray
BK Black

Table with columns: SHELF W" x L", MODEL NO., SHIP WGT, ADD-ON KIT MODEL NO., SHIP WGT, STARTER KIT MODEL NO., SHIP WGT, AVAILABLE FINISHES (C, S, P, GY, BK). Rows list various shelving unit configurations and their weights.

Shelving units include 4 posts and 4 or 5 shelves. Add-On units include 2 posts, 4 or 5 shelves and 8 or 10 S-Hooks. Y (Yes) N (No)

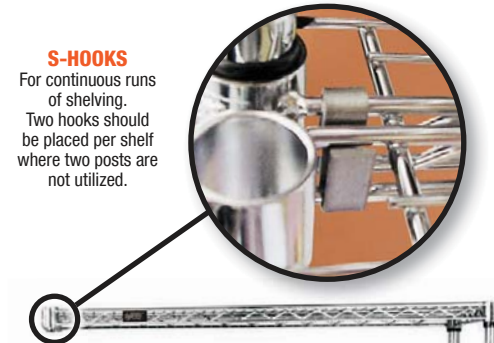
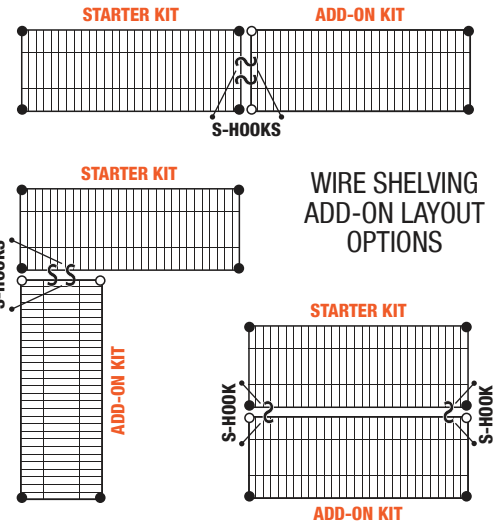

S-HOOKS
For continuous runs of shelving. Two hooks should be placed per shelf where two posts are not utilized.



4 SHELF ADD-ON KIT Chrome Finish



Starter Kits



Heavy-duty shelving units allow up to 800 lb. shelf capacity. Starter kits come complete with 4 posts and 4 or 5 shelves. Additional shelves may be purchased separately. See chart on pg. 98. Mobilize starter kit shelving unit using optional mobile kit, WR-00H, see pg. 149. **Finishes:** Chrome, Stainless Steel, Proform Green, Gray and Black Epoxy

**600-800 lb.**  
LOAD CAPACITY PER SHELF

TO CHOOSE FINISH ADD FINISH SUFFIX TO MODEL NO.

Ex: **Chrome** WR74-1236C  
**Stainless** WR74-1236S  
**Proform Green** WR74-1236P  
**Gray** WR74-1236GY  
**Black** WR74-1236BK

Ex: **Chrome** WR74-1236C-5  
**Stainless** WR74-1236S-5  
**Proform Green** WR74-1236P-5  
**Gray** WR74-1236GY-5  
**Black** WR74-1236BK-5

**Chrome**  
**Stainless**  
**Proform Green**  
**GY** Gray  
**BK** Black



**MOBILIZE YOUR WIRE SHELVING**

**DB - Donut Bumper**

Non-marking donut bumper used to protect walls and help cushion impact.

**WR-00H (Mobile Kit)\***

Set of four swivel thermoplastic resin 5" x 1-1/4" casters, two with brakes. Can be used with all units shown. 1,200 lb. load capacity. \*Mobile kits recommended only for shelves 18" and deeper.



**4 SHELF STARTER KIT**  
Proform Green Epoxy Finish



**5 SHELF STARTER KIT**  
Black Epoxy Finish

74" H - WIRE SHELVING 4 SHELVES				74" H - WIRE SHELVING 5 SHELVES				AVAILABLE	
STARTER KIT		ADD-ON KIT		STARTER KIT		ADD-ON KIT		FINISHES	
SHELF W" x L"	MODEL NO.	SHIP WGT	MODEL NO.	SHIP WGT	MODEL NO.	SHIP WGT	MODEL NO.	SHIP WGT	C S P G Y BK
12" x 36"	WR74-1236	44 lbs	AD74-1236	38 lbs	WR74-1236-5	51 lbs	AD74-1236-5	47 lbs	Y Y Y Y Y
12" x 42"	WR74-1242	48 lbs	AD74-1242	42 lbs	WR74-1242-5	56 lbs	AD74-1242-5	52 lbs	Y N Y Y Y
12" x 48"	WR74-1248	52 lbs	AD74-1248	46 lbs	WR74-1248-5	61 lbs	AD74-1248-5	57 lbs	Y Y Y Y Y
12" x 60"	WR74-1260	60 lbs	AD74-1260	54 lbs	WR74-1260-5	74 lbs	AD74-1260-5	70 lbs	Y Y Y Y Y
12" x 72"	WR74-1272	68 lbs	AD74-1272	62 lbs	WR74-1272-5	85 lbs	AD74-1272-5	81 lbs	Y Y Y Y Y
14" x 24"	WR74-1424	40 lbs	AD74-1424	34 lbs	WR74-1424-5	46 lbs	AD74-1424-5	42 lbs	Y N Y Y Y
14" x 30"	WR74-1430	44 lbs	AD74-1430	38 lbs	WR74-1430-5	51 lbs	AD74-1430-5	47 lbs	Y Y Y Y Y
14" x 36"	WR74-1436	48 lbs	AD74-1436	42 lbs	WR74-1436-5	56 lbs	AD74-1436-5	52 lbs	Y Y Y Y Y
14" x 42"	WR74-1442	56 lbs	AD74-1442	50 lbs	WR74-1442-5	66 lbs	AD74-1442-5	62 lbs	Y Y Y Y Y
14" x 48"	WR74-1448	60 lbs	AD74-1448	54 lbs	WR74-1448-5	71 lbs	AD74-1448-5	67 lbs	Y Y Y Y Y
14" x 54"	WR74-1454	64 lbs	AD74-1454	58 lbs	WR74-1454-5	76 lbs	AD74-1454-5	72 lbs	Y Y Y Y Y
14" x 60"	WR74-1460	72 lbs	AD74-1460	66 lbs	WR74-1460-5	86 lbs	AD74-1460-5	82 lbs	Y Y Y Y Y
14" x 72"	WR74-1472	84 lbs	AD74-1472	78 lbs	WR74-1472-5	101 lbs	AD74-1472-5	97 lbs	Y Y Y Y Y
18" x 24"	WR74-1824	44 lbs	AD74-1824	38 lbs	WR74-1824-5	51 lbs	AD74-1824-5	47 lbs	Y Y Y Y Y
18" x 30"	WR74-1830	48 lbs	AD74-1830	42 lbs	WR74-1830-5	56 lbs	AD74-1830-5	52 lbs	Y Y Y Y Y
18" x 36"	WR74-1836	56 lbs	AD74-1836	50 lbs	WR74-1836-5	66 lbs	AD74-1836-5	62 lbs	Y Y Y Y Y
18" x 42"	WR74-1842	60 lbs	AD74-1842	54 lbs	WR74-1842-5	71 lbs	AD74-1842-5	67 lbs	Y Y Y Y Y
18" x 48"	WR74-1848	64 lbs	AD74-1848	58 lbs	WR74-1848-5	78 lbs	AD74-1848-5	74 lbs	Y Y Y Y Y
18" x 54"	WR74-1854	76 lbs	AD74-1854	70 lbs	WR74-1854-5	91 lbs	AD74-1854-5	87 lbs	Y Y Y Y Y
18" x 60"	WR74-1860	84 lbs	AD74-1860	78 lbs	WR74-1860-5	101 lbs	AD74-1860-5	97 lbs	Y Y Y Y Y
18" x 72"	WR74-1872	96 lbs	AD74-1872	90 lbs	WR74-1872-5	116 lbs	AD74-1872-5	112 lbs	Y Y Y Y Y
21" x 24"	WR74-2124	48 lbs	AD74-2124	42 lbs	WR74-2124-5	56 lbs	AD74-2124-5	52 lbs	Y Y Y Y Y
21" x 30"	WR74-2130	52 lbs	AD74-2130	46 lbs	WR74-2130-5	61 lbs	AD74-2130-5	57 lbs	Y Y Y Y Y
21" x 36"	WR74-2136	60 lbs	AD74-2136	54 lbs	WR74-2136-5	71 lbs	AD74-2136-5	67 lbs	Y Y Y Y Y
21" x 42"	WR74-2142	64 lbs	AD74-2142	58 lbs	WR74-2142-5	76 lbs	AD74-2142-5	72 lbs	Y Y Y Y Y
21" x 48"	WR74-2148	72 lbs	AD74-2148	66 lbs	WR74-2148-5	86 lbs	AD74-2148-5	82 lbs	Y Y Y Y Y
21" x 54"	WR74-2154	80 lbs	AD74-2154	74 lbs	WR74-2154-5	96 lbs	AD74-2154-5	92 lbs	Y Y Y Y Y
21" x 60"	WR74-2160	88 lbs	AD74-2160	82 lbs	WR74-2160-5	106 lbs	AD74-2160-5	102 lbs	Y Y Y Y Y
21" x 72"	WR74-2172	112 lbs	AD74-2172	106 lbs	WR74-2172-5	136 lbs	AD74-2172-5	132 lbs	Y Y Y Y Y
24" x 24"	WR74-2424	52 lbs	AD74-2424	46 lbs	WR74-2424-5	61 lbs	AD74-2424-5	57 lbs	Y Y Y Y Y
24" x 30"	WR74-2430	60 lbs	AD74-2430	54 lbs	WR74-2430-5	71 lbs	AD74-2430-5	67 lbs	Y Y Y Y Y
24" x 36"	WR74-2436	68 lbs	AD74-2436	62 lbs	WR74-2436-5	81 lbs	AD74-2436-5	77 lbs	Y Y Y Y Y
24" x 42"	WR74-2442	76 lbs	AD74-2442	70 lbs	WR74-2442-5	91 lbs	AD74-2442-5	87 lbs	Y Y Y Y Y
24" x 48"	WR74-2448	80 lbs	AD74-2448	74 lbs	WR74-2448-5	96 lbs	AD74-2448-5	92 lbs	Y Y Y Y Y
24" x 54"	WR74-2454	88 lbs	AD74-2454	82 lbs	WR74-2454-5	106 lbs	AD74-2454-5	102 lbs	Y Y Y Y Y
24" x 60"	WR74-2460	100 lbs	AD74-2460	94 lbs	WR74-2460-5	121 lbs	AD74-2460-5	117 lbs	Y Y Y Y Y
24" x 72"	WR74-2472	120 lbs	AD74-2472	114 lbs	WR74-2472-5	146 lbs	AD74-2472-5	142 lbs	Y Y Y Y Y
30" x 36"	WR74-3036	76 lbs	AD74-3036	70 lbs	WR74-3036-5	91 lbs	AD74-3036-5	87 lbs	Y Y Y Y Y
30" x 42"	WR74-3042	88 lbs	AD74-3042	82 lbs	WR74-3042-5	106 lbs	AD74-3042-5	102 lbs	Y Y Y Y Y
30" x 48"	WR74-3048	100 lbs	AD74-3048	94 lbs	WR74-3048-5	121 lbs	AD74-3048-5	117 lbs	Y Y Y Y Y
30" x 60"	WR74-3060	124 lbs	AD74-3060	118 lbs	WR74-3060-5	151 lbs	AD74-3060-5	147 lbs	Y Y Y Y Y
30" x 72"	WR74-3072	140 lbs	AD74-3072	134 lbs	WR74-3072-5	171 lbs	AD74-3072-5	167 lbs	Y Y Y Y Y
36" x 36"	WR74-3636	88 lbs	AD74-3636	82 lbs	WR74-3636-5	106 lbs	AD74-3636-5	102 lbs	Y Y Y Y Y
36" x 48"	WR74-3648	108 lbs	AD74-3648	102 lbs	WR74-3648-5	131 lbs	AD74-3648-5	127 lbs	Y Y Y Y Y
36" x 60"	WR74-3660	132 lbs	AD74-3660	126 lbs	WR74-3660-5	161 lbs	AD74-3660-5	157 lbs	Y Y Y Y Y
36" x 72"	WR74-3672	140 lbs	AD74-3672	134 lbs	WR74-3672-5	175 lbs	AD74-3672-5	171 lbs	Y Y Y Y Y

Shelving units include 4 posts and 4 or 5 shelves. Add-On units include 2 posts, 4 or 5 shelves and 8 or 10 S-Hooks.

Y (Yes) N (No)



Add-On Kits

Additional Add-On kits allow you to expand your Starter kit by sharing a set of posts. Configuration options include side to side, back to back and right angles (L-Shape). Add-On kits come complete with 2 posts, 4 or 5 shelves and 8 or 10 S-Hooks. Additional shelves and posts may be purchased separately. See chart on pg. 98. Units with Add-On kit cannot be made mobile. Finishes: Chrome, Stainless Steel, Proform Green, Gray and Black Epoxy

600-800 lb. LOAD CAPACITY PER SHELF

TO CHOOSE FINISH ADD FINISH SUFFIX TO MODEL NO.

Ex: Chrome WR86-1236C
Stainless WR86-1236S
Proform Green WR86-1236P
Gray WR86-1236GY
Black WR86-1236BK

Ex: Chrome WR86-1236C-5
Stainless WR86-1236S-5
Proform Green WR86-1236P-5
Gray WR86-1236GY-5
Black WR86-1236BK-5

Chrome WR86-1236C-5
Stainless WR86-1236S-5
Proform Green WR86-1236P-5
Gray WR86-1236GY-5
Black WR86-1236BK-5

Table with columns: SHELF W" x L", MODEL NO., SHIP WGT, ADD-ON KIT, STARTER KIT, MODEL NO., SHIP WGT, AVAILABLE FINISHES (C, S, P, GY, BK). Rows list various shelving models and their specifications.

Shelving units include 4 posts and 4 or 5 shelves. Add-On units include 2 posts, 4 or 5 shelves and 8 or 10 S-Hooks. Y (Yes) N (No)

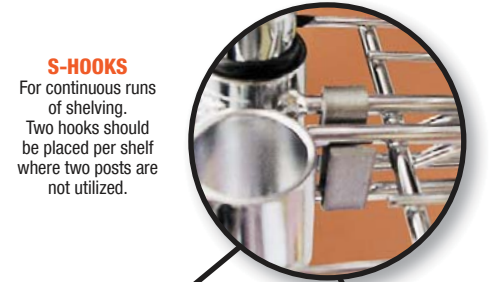
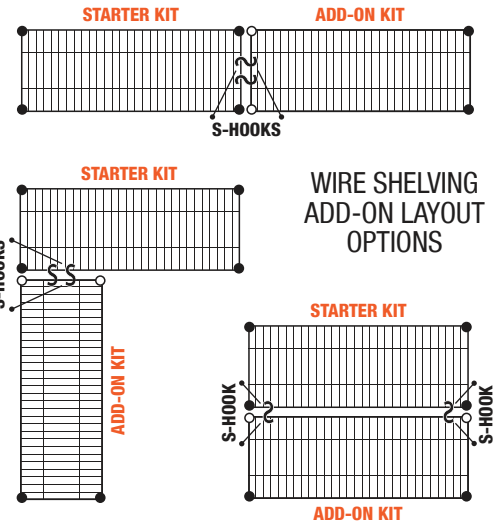

4 SHELF BACK TO BACK SYSTEM Chrome Finish



**4 Shelf Starter Kits**

Solid flat shelves allows for storage from small to large items, and the marine edge perimeter prevents spillage. The double hemmed 18 gauge galvanized steel provides the solid shelf excellent strength characteristics. All solid shelf units consist of 4 shelves and 4 posts. Mobilize starter kit shelving unit using optional mobile kit WR-00H, see pg. 149. *Finish:* Galvanized Steel



**MOBILIZE YOUR SHELVING**

**DB - Donut Bumper**

Non-marking donut bumper used to protect walls and help cushion impact.

**WR-00H (Mobile Kit)\***

Set of four swivel thermoplastic resin 5" x 1-1/4" casters, two with brakes. Can be used with all units shown. 1,200 lb. load capacity. \*Mobile kits recommended only for shelves 18" and deeper.



**QSMC Shelf Clamp**  
Shelf Clamp eliminates 2 posts per shelving section. Two QSMC clamps are required per shelf. *Finish:* Aluminum (Sold individually)

54" H - GALVANIZED SOLID SHELVING 4 SHELVES					63" H - GALVANIZED SOLID SHELVING 4 SHELVES				
STARTER KIT			ADD-ON KIT		STARTER KIT			ADD-ON KIT	
SHELF W" x L"	MODEL NO.	SHIP WGT	MODEL NO.	SHIP WGT	MODEL NO.	SHIP WGT	MODEL NO.	SHIP WGT	
14" x 36"	WR54-1436SG	68 lbs	AD54-1436SG	65 lbs	WR63-1436SG	72 lbs	AD63-1436SG	67 lbs	
14" x 42"	WR54-1442SG	72 lbs	AD54-1442SG	69 lbs	WR63-1442SG	76 lbs	AD63-1442SG	71 lbs	
14" x 48"	WR54-1448SG	80 lbs	AD54-1448SG	77 lbs	WR63-1448SG	84 lbs	AD63-1448SG	79 lbs	
14" x 54"	WR54-1454SG	92 lbs	AD54-1454SG	89 lbs	WR63-1454SG	96 lbs	AD63-1454SG	91 lbs	
14" x 60"	WR54-1460SG	100 lbs	AD54-1460SG	97 lbs	WR63-1460SG	104 lbs	AD63-1460SG	99 lbs	
14" x 72"	WR54-1472SG	116 lbs	AD54-1472SG	113 lbs	WR63-1472SG	120 lbs	AD63-1472SG	115 lbs	
18" x 24"	WR54-1824SG	56 lbs	AD54-1824SG	53 lbs	WR63-1824SG	60 lbs	AD63-1824SG	55 lbs	
18" x 30"	WR54-1830SG	68 lbs	AD54-1830SG	65 lbs	WR63-1830SG	72 lbs	AD63-1830SG	67 lbs	
18" x 36"	WR54-1836SG	76 lbs	AD54-1836SG	73 lbs	WR63-1836SG	80 lbs	AD63-1836SG	75 lbs	
18" x 42"	WR54-1842SG	84 lbs	AD54-1842SG	81 lbs	WR63-1842SG	88 lbs	AD63-1842SG	83 lbs	
18" x 48"	WR54-1848SG	92 lbs	AD54-1848SG	89 lbs	WR63-1848SG	96 lbs	AD63-1848SG	91 lbs	
18" x 54"	WR54-1854SG	100 lbs	AD54-1854SG	97 lbs	WR63-1854SG	104 lbs	AD63-1854SG	99 lbs	
18" x 60"	WR54-1860SG	108 lbs	AD54-1860SG	105 lbs	WR63-1860SG	112 lbs	AD63-1860SG	107 lbs	
18" x 72"	WR54-1872SG	120 lbs	AD54-1872SG	117 lbs	WR63-1872SG	124 lbs	AD63-1872SG	119 lbs	
21" x 24"	WR54-2124SG	64 lbs	AD54-2124SG	61 lbs	WR63-2124SG	68 lbs	AD63-2124SG	63 lbs	
21" x 30"	WR54-2130SG	72 lbs	AD54-2130SG	69 lbs	WR63-2130SG	76 lbs	AD63-2130SG	71 lbs	
21" x 36"	WR54-2136SG	84 lbs	AD54-2136SG	81 lbs	WR63-2136SG	88 lbs	AD63-2136SG	83 lbs	
21" x 42"	WR54-2142SG	96 lbs	AD54-2142SG	93 lbs	WR63-2142SG	100 lbs	AD63-2142SG	95 lbs	
21" x 48"	WR54-2148SG	104 lbs	AD54-2148SG	101 lbs	WR63-2148SG	108 lbs	AD63-2148SG	103 lbs	
21" x 54"	WR54-2154SG	112 lbs	AD54-2154SG	109 lbs	WR63-2154SG	116 lbs	AD63-2154SG	111 lbs	
21" x 60"	WR54-2160SG	124 lbs	AD54-2160SG	121 lbs	WR63-2160SG	128 lbs	AD63-2160SG	123 lbs	
21" x 72"	WR54-2172SG	132 lbs	AD54-2172SG	129 lbs	WR63-2172SG	136 lbs	AD63-2172SG	131 lbs	
24" x 24"	WR54-2424SG	72 lbs	AD54-2424SG	69 lbs	WR63-2424SG	76 lbs	AD63-2424SG	71 lbs	
24" x 30"	WR54-2430SG	80 lbs	AD54-2430SG	77 lbs	WR63-2430SG	84 lbs	AD63-2430SG	79 lbs	
24" x 36"	WR54-2436SG	88 lbs	AD54-2436SG	85 lbs	WR63-2436SG	92 lbs	AD63-2436SG	87 lbs	
24" x 42"	WR54-2442SG	100 lbs	AD54-2442SG	97 lbs	WR63-2442SG	104 lbs	AD63-2442SG	99 lbs	
24" x 48"	WR54-2448SG	108 lbs	AD54-2448SG	105 lbs	WR63-2448SG	112 lbs	AD63-2448SG	107 lbs	
24" x 54"	WR54-2454SG	124 lbs	AD54-2454SG	121 lbs	WR63-2454SG	128 lbs	AD63-2454SG	123 lbs	
24" x 60"	WR54-2460SG	136 lbs	AD54-2460SG	133 lbs	WR63-2460SG	140 lbs	AD63-2460SG	135 lbs	
24" x 72"	WR54-2472SG	148 lbs	AD54-2472SG	145 lbs	WR63-2472SG	152 lbs	AD63-2472SG	147 lbs	

Shelving units include 4 posts and 4 shelves. Add-On units include 2 posts, 4 shelves and 8 shelf clamps.

**18 GAUGE GALVANIZED STEEL**

**400-600 lb. LOAD CAPACITY PER SHELF**

**4 Shelf Add-On Kits**

Additional Add-On kits allow you to expand your Starter kit by sharing a set of posts. Configuration options include side to side, back to back and right angles (L-Shape). Add-on units consist of 4 shelves, 2 posts and 8 shelf clamps. Additional shelves and posts may be purchased separately, see chart on pg. 99. Units with Add-On kit cannot be made mobile. *Finish:* Galvanized Steel

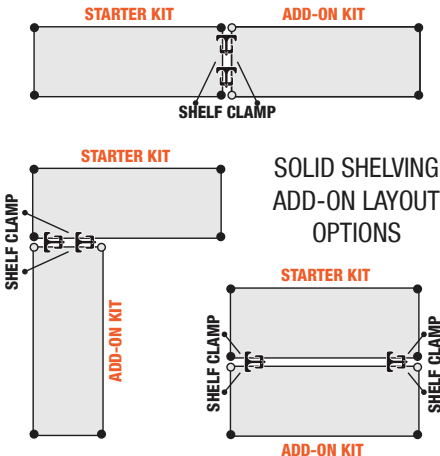

74" H - GALVANIZED SOLID SHELVING 4 SHELVES					86" H - GALVANIZED SOLID SHELVING 4 SHELVES				
STARTER KIT			ADD-ON KIT		STARTER KIT			ADD-ON KIT	
SHELF W" x L"	MODEL NO.	SHIP WGT	MODEL NO.	SHIP WGT	MODEL NO.	SHIP WGT	MODEL NO.	SHIP WGT	
14" x 36"	WR74-1436SG	72 lbs	AD74-1436SG	67 lbs	WR86-1436SG	76 lbs	AD86-1436SG	69 lbs	
14" x 42"	WR74-1442SG	76 lbs	AD74-1442SG	71 lbs	WR86-1442SG	80 lbs	AD86-1442SG	73 lbs	
14" x 48"	WR74-1448SG	84 lbs	AD74-1448SG	79 lbs	WR86-1448SG	88 lbs	AD86-1448SG	81 lbs	
14" x 54"	WR74-1454SG	96 lbs	AD74-1454SG	91 lbs	WR86-1454SG	100 lbs	AD86-1454SG	93 lbs	
14" x 60"	WR74-1460SG	104 lbs	AD74-1460SG	99 lbs	WR86-1460SG	108 lbs	AD86-1460SG	101 lbs	
14" x 72"	WR74-1472SG	120 lbs	AD74-1472SG	115 lbs	WR86-1472SG	124 lbs	AD86-1472SG	117 lbs	
18" x 24"	WR74-1824SG	60 lbs	AD74-1824SG	55 lbs	WR86-1824SG	64 lbs	AD86-1824SG	57 lbs	
18" x 30"	WR74-1830SG	72 lbs	AD74-1830SG	67 lbs	WR86-1830SG	76 lbs	AD86-1830SG	69 lbs	
18" x 36"	WR74-1836SG	80 lbs	AD74-1836SG	75 lbs	WR86-1836SG	84 lbs	AD86-1836SG	77 lbs	
18" x 42"	WR74-1842SG	88 lbs	AD74-1842SG	83 lbs	WR86-1842SG	92 lbs	AD86-1842SG	85 lbs	
18" x 48"	WR74-1848SG	96 lbs	AD74-1848SG	91 lbs	WR86-1848SG	100 lbs	AD86-1848SG	93 lbs	
18" x 54"	WR74-1854SG	104 lbs	AD74-1854SG	99 lbs	WR86-1854SG	108 lbs	AD86-1854SG	101 lbs	
18" x 60"	WR74-1860SG	112 lbs	AD74-1860SG	107 lbs	WR86-1860SG	116 lbs	AD86-1860SG	109 lbs	
18" x 72"	WR74-1872SG	124 lbs	AD74-1872SG	119 lbs	WR86-1872SG	128 lbs	AD86-1872SG	121 lbs	
21" x 24"	WR74-2124SG	68 lbs	AD74-2124SG	63 lbs	WR86-2124SG	72 lbs	AD86-2124SG	65 lbs	
21" x 30"	WR74-2130SG	76 lbs	AD74-2130SG	71 lbs	WR86-2130SG	80 lbs	AD86-2130SG	73 lbs	
21" x 36"	WR74-2136SG	88 lbs	AD74-2136SG	83 lbs	WR86-2136SG	92 lbs	AD86-2136SG	85 lbs	
21" x 42"	WR74-2142SG	100 lbs	AD74-2142SG	95 lbs	WR86-2142SG	104 lbs	AD86-2142SG	97 lbs	
21" x 48"	WR74-2148SG	108 lbs	AD74-2148SG	103 lbs	WR86-2148SG	112 lbs	AD86-2148SG	105 lbs	
21" x 54"	WR74-2154SG	116 lbs	AD74-2154SG	111 lbs	WR86-2154SG	120 lbs	AD86-2154SG	113 lbs	
21" x 60"	WR74-2160SG	128 lbs	AD74-2160SG	123 lbs	WR86-2160SG	132 lbs	AD86-2160SG	125 lbs	
21" x 72"	WR74-2172SG	136 lbs	AD74-2172SG	131 lbs	WR86-2172SG	140 lbs	AD86-2172SG	133 lbs	
24" x 24"	WR74-2424SG	76 lbs	AD74-2424SG	71 lbs	WR86-2424SG	80 lbs	AD86-2424SG	73 lbs	
24" x 30"	WR74-2430SG	84 lbs	AD74-2430SG	79 lbs	WR86-2430SG	88 lbs	AD86-2430SG	81 lbs	
24" x 36"	WR74-2436SG	92 lbs	AD74-2436SG	87 lbs	WR86-2436SG	96 lbs	AD86-2436SG	89 lbs	
24" x 42"	WR74-2442SG	104 lbs	AD74-2442SG	99 lbs	WR86-2442SG	108 lbs	AD86-2442SG	101 lbs	
24" x 48"	WR74-2448SG	112 lbs	AD74-2448SG	107 lbs	WR86-2448SG	116 lbs	AD86-2448SG	109 lbs	
24" x 54"	WR74-2454SG	128 lbs	AD74-2454SG	123 lbs	WR86-2454SG	132 lbs	AD86-2454SG	125 lbs	
24" x 60"	WR74-2460SG	140 lbs	AD74-2460SG	135 lbs	WR86-2460SG	144 lbs	AD86-2460SG	137 lbs	
24" x 72"	WR74-2472SG	152 lbs	AD74-2472SG	147 lbs	WR86-2472SG	156 lbs	AD86-2472SG	149 lbs	

Shelving units include 4 posts and 4 shelves. Add-On units include 2 posts, 4 shelves and 8 shelf clamps.





Table with 4 columns: 54" H - GALVANIZED SOLID SHELVING 5 SHELVES (STARTER KIT, ADD-ON KIT), 63" H - GALVANIZED SOLID SHELVING 5 SHELVES (STARTER KIT, ADD-ON KIT). Rows list shelf dimensions and model numbers.

Shelving units include 4 posts and 5 shelves. Add-On units include 2 posts, 5 shelves and 10 shelf clamps.

18 GAUGE GALVANIZED STEEL 400-600 lb. LOAD CAPACITY PER SHELF

Table with 4 columns: 74" H - GALVANIZED SOLID SHELVING 5 SHELVES (STARTER KIT, ADD-ON KIT), 86" H - GALVANIZED SOLID SHELVING 5 SHELVES (STARTER KIT, ADD-ON KIT). Rows list shelf dimensions and model numbers.

Shelving units include 4 posts and 5 shelves. Add-On units include 2 posts, 5 shelves and 10 shelf clamps.

5 Shelf Starter Kits

Solid flat shelves allows for storage from small to large items, and the marine edge perimeter prevents spillage. The double hemmed 18 gauge galvanized steel gives the solid shelf excellent strength characteristics.



MOBILIZE YOUR SHELVING

DB - Donut Bumper Non-marking donut bumper used to protect walls and help cushion impact.

WR-00H (Mobile Kit)\* Set of four swivel thermoplastic resin 5" x 1-1/4" casters, two with brakes. Can be used with all units shown. 1,200 lb. load capacity.



QSMC Shelf Clamp Shelf Clamp eliminates 2 posts per shelving section. Two QSMC clamps are required per shelf. Finish: Aluminum (Sold individually)



5 SHELF ADD-ON KIT

5 Shelf Add-On Kits

Additional Add-On kit allows you to expand your Starter kit by sharing a set of posts. Configuration options include side to side, back to back and right angles (L-Shape).

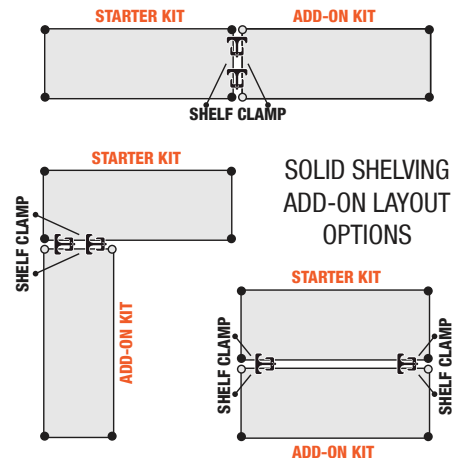

SOLID SHELVING ADD-ON LAYOUT OPTIONS



4 Shelf Starter Kits

Solid flat shelves allows for storage from small to large items, and the marine edge perimeter prevents spillage. The double hemmed 18 gauge 304 stainless steel gives the solid shelf excellent strength characteristics. All solid shelf units consist of 4 shelves and 4 posts. Mobilize starter kit shelving unit using optional mobile kit WR-00HS, see pg. 149. *Finish:* Stainless Steel



MOBILIZE YOUR SHELVING

DB - Donut Bumper

Non-marking donut bumper used to protect walls and help cushion impact.

WR-00HS (Mobile Kit)\*

Set of four swivel 5" x 1-1/4" thermo-plastic resin stainless steel casters with zerk grease fittings, 2 with brake. Can be used with all units shown. 1,200 lb. load capacity. \*Mobile kits recommended only for shelves 18" and deeper.



**QSMC Shelf Clamp**  
Shelf Clamp eliminates 2 post per shelving section. Two QSMC clamps are required per shelf. *Finish:* Aluminum (Sold individually)

4 Shelf Add-On Kits

Additional Add-On kits allow you to expand your Starter kit by sharing a set of posts. Configuration options include side to side, back to back and right angles (L-Shape). Add-on units consist of 4 shelves, 2 posts and 8 shelf clamps. Additional shelves and posts may be purchased separately, see chart on pg. 99. Units with Add-On kit cannot be made mobile. *Finish:* Stainless Steel

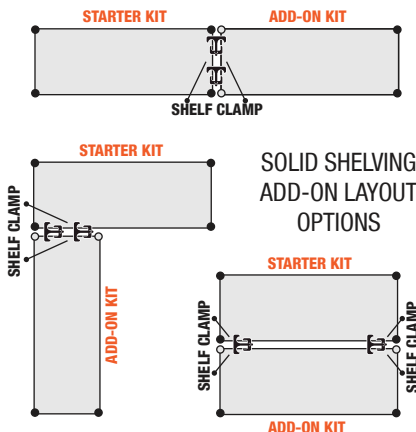

54" H - STAINLESS SOLID SHELVING 4 SHELVES				63" H - STAINLESS SOLID SHELVING 4 SHELVES				
STARTER KIT		ADD-ON KIT		STARTER KIT		ADD-ON KIT		
SHELF W" x L"	MODEL NO.	SHIP WGT	MODEL NO.	SHIP WGT	MODEL NO.	SHIP WGT	MODEL NO.	SHIP WGT
14" x 36"	WRS4-54-1436SS	68 lbs	WRSAD4-54-1436SS	65 lbs	WRS4-63-1436SS	72 lbs	WRSAD4-63-1436SS	67 lbs
14" x 42"	WRS4-54-1442SS	72 lbs	WRSAD4-54-1442SS	69 lbs	WRS4-63-1442SS	76 lbs	WRSAD4-63-1442SS	71 lbs
14" x 48"	WRS4-54-1448SS	80 lbs	WRSAD4-54-1448SS	77 lbs	WRS4-63-1448SS	84 lbs	WRSAD4-63-1448SS	79 lbs
14" x 54"	WRS4-54-1454SS	92 lbs	WRSAD4-54-1454SS	89 lbs	WRS4-63-1454SS	96 lbs	WRSAD4-63-1454SS	91 lbs
14" x 60"	WRS4-54-1460SS	100 lbs	WRSAD4-54-1460SS	97 lbs	WRS4-63-1460SS	104 lbs	WRSAD4-63-1460SS	99 lbs
14" x 72"	WRS4-54-1472SS	116 lbs	WRSAD4-54-1472SS	113 lbs	WRS4-63-1472SS	120 lbs	WRSAD4-63-1472SS	115 lbs
18" x 24"	WRS4-54-1824SS	56 lbs	WRSAD4-54-1824SS	53 lbs	WRS4-63-1824SS	60 lbs	WRSAD4-63-1824SS	55 lbs
18" x 30"	WRS4-54-1830SS	68 lbs	WRSAD4-54-1830SS	65 lbs	WRS4-63-1830SS	72 lbs	WRSAD4-63-1830SS	67 lbs
18" x 36"	WRS4-54-1836SS	76 lbs	WRSAD4-54-1836SS	73 lbs	WRS4-63-1836SS	80 lbs	WRSAD4-63-1836SS	75 lbs
18" x 42"	WRS4-54-1842SS	84 lbs	WRSAD4-54-1842SS	81 lbs	WRS4-63-1842SS	88 lbs	WRSAD4-63-1842SS	83 lbs
18" x 48"	WRS4-54-1848SS	92 lbs	WRSAD4-54-1848SS	89 lbs	WRS4-63-1848SS	96 lbs	WRSAD4-63-1848SS	91 lbs
18" x 54"	WRS4-54-1854SS	100 lbs	WRSAD4-54-1854SS	97 lbs	WRS4-63-1854SS	104 lbs	WRSAD4-63-1854SS	99 lbs
18" x 60"	WRS4-54-1860SS	108 lbs	WRSAD4-54-1860SS	105 lbs	WRS4-63-1860SS	112 lbs	WRSAD4-63-1860SS	107 lbs
18" x 72"	WRS4-54-1872SS	120 lbs	WRSAD4-54-1872SS	117 lbs	WRS4-63-1872SS	124 lbs	WRSAD4-63-1872SS	119 lbs
21" x 24"	WRS4-54-2124SS	64 lbs	WRSAD4-54-2124SS	61 lbs	WRS4-63-2124SS	68 lbs	WRSAD4-63-2124SS	63 lbs
21" x 30"	WRS4-54-2130SS	72 lbs	WRSAD4-54-2130SS	69 lbs	WRS4-63-2130SS	76 lbs	WRSAD4-63-2130SS	71 lbs
21" x 36"	WRS4-54-2136SS	84 lbs	WRSAD4-54-2136SS	81 lbs	WRS4-63-2136SS	88 lbs	WRSAD4-63-2136SS	83 lbs
21" x 42"	WRS4-54-2142SS	96 lbs	WRSAD4-54-2142SS	93 lbs	WRS4-63-2142SS	100 lbs	WRSAD4-63-2142SS	95 lbs
21" x 48"	WRS4-54-2148SS	104 lbs	WRSAD4-54-2148SS	101 lbs	WRS4-63-2148SS	108 lbs	WRSAD4-63-2148SS	103 lbs
21" x 54"	WRS4-54-2154SS	112 lbs	WRSAD4-54-2154SS	109 lbs	WRS4-63-2154SS	116 lbs	WRSAD4-63-2154SS	111 lbs
21" x 60"	WRS4-54-2160SS	124 lbs	WRSAD4-54-2160SS	121 lbs	WRS4-63-2160SS	128 lbs	WRSAD4-63-2160SS	123 lbs
21" x 72"	WRS4-54-2172SS	132 lbs	WRSAD4-54-2172SS	129 lbs	WRS4-63-2172SS	136 lbs	WRSAD4-63-2172SS	131 lbs
24" x 24"	WRS4-54-2424SS	72 lbs	WRSAD4-54-2424SS	69 lbs	WRS4-63-2424SS	76 lbs	WRSAD4-63-2424SS	71 lbs
24" x 30"	WRS4-54-2430SS	80 lbs	WRSAD4-54-2430SS	77 lbs	WRS4-63-2430SS	84 lbs	WRSAD4-63-2430SS	79 lbs
24" x 36"	WRS4-54-2436SS	88 lbs	WRSAD4-54-2436SS	85 lbs	WRS4-63-2436SS	92 lbs	WRSAD4-63-2436SS	87 lbs
24" x 42"	WRS4-54-2442SS	100 lbs	WRSAD4-54-2442SS	97 lbs	WRS4-63-2442SS	104 lbs	WRSAD4-63-2442SS	99 lbs
24" x 48"	WRS4-54-2448SS	108 lbs	WRSAD4-54-2448SS	105 lbs	WRS4-63-2448SS	112 lbs	WRSAD4-63-2448SS	107 lbs
24" x 54"	WRS4-54-2454SS	124 lbs	WRSAD4-54-2454SS	121 lbs	WRS4-63-2454SS	128 lbs	WRSAD4-63-2454SS	123 lbs
24" x 60"	WRS4-54-2460SS	136 lbs	WRSAD4-54-2460SS	133 lbs	WRS4-63-2460SS	140 lbs	WRSAD4-63-2460SS	135 lbs
24" x 72"	WRS4-54-2472SS	148 lbs	WRSAD4-54-2472SS	145 lbs	WRS4-63-2472SS	152 lbs	WRSAD4-63-2472SS	147 lbs

Shelving units include 4 posts and 4 shelves. Add-On units include 2 posts, 4 shelves and 8 shelf clamps.

304 STAINLESS STEEL

400-600 lb. LOAD CAPACITY PER SHELF

74" H - STAINLESS SOLID SHELVING 4 SHELVES				86" H - STAINLESS SOLID SHELVING 4 SHELVES				
STARTER KIT		ADD-ON KIT		STARTER KIT		ADD-ON KIT		
SHELF W" x L"	MODEL NO.	SHIP WGT	MODEL NO.	SHIP WGT	MODEL NO.	SHIP WGT	MODEL NO.	SHIP WGT
14" x 36"	WRS4-74-1436SS	72 lbs	WRSAD4-74-1436SS	67 lbs	WRS4-86-1436SS	76 lbs	WRSAD4-86-1436SS	69 lbs
14" x 42"	WRS4-74-1442SS	76 lbs	WRSAD4-74-1442SS	71 lbs	WRS4-86-1442SS	80 lbs	WRSAD4-86-1442SS	73 lbs
14" x 48"	WRS4-74-1448SS	84 lbs	WRSAD4-74-1448SS	79 lbs	WRS4-86-1448SS	88 lbs	WRSAD4-86-1448SS	81 lbs
14" x 54"	WRS4-74-1454SS	96 lbs	WRSAD4-74-1454SS	91 lbs	WRS4-86-1454SS	100 lbs	WRSAD4-86-1454SS	93 lbs
14" x 60"	WRS4-74-1460SS	104 lbs	WRSAD4-74-1460SS	99 lbs	WRS4-86-1460SS	108 lbs	WRSAD4-86-1460SS	101 lbs
14" x 72"	WRS4-74-1472SS	120 lbs	WRSAD4-74-1472SS	115 lbs	WRS4-86-1472SS	124 lbs	WRSAD4-86-1472SS	117 lbs
18" x 24"	WRS4-74-1824SS	60 lbs	WRSAD4-74-1824SS	55 lbs	WRS4-86-1824SS	64 lbs	WRSAD4-86-1824SS	57 lbs
18" x 30"	WRS4-74-1830SS	72 lbs	WRSAD4-74-1830SS	67 lbs	WRS4-86-1830SS	76 lbs	WRSAD4-86-1830SS	69 lbs
18" x 36"	WRS4-74-1836SS	80 lbs	WRSAD4-74-1836SS	75 lbs	WRS4-86-1836SS	84 lbs	WRSAD4-86-1836SS	77 lbs
18" x 42"	WRS4-74-1842SS	88 lbs	WRSAD4-74-1842SS	83 lbs	WRS4-86-1842SS	92 lbs	WRSAD4-86-1842SS	85 lbs
18" x 48"	WRS4-74-1848SS	96 lbs	WRSAD4-74-1848SS	91 lbs	WRS4-86-1848SS	100 lbs	WRSAD4-86-1848SS	93 lbs
18" x 54"	WRS4-74-1854SS	104 lbs	WRSAD4-74-1854SS	99 lbs	WRS4-86-1854SS	108 lbs	WRSAD4-86-1854SS	101 lbs
18" x 60"	WRS4-74-1860SS	112 lbs	WRSAD4-74-1860SS	107 lbs	WRS4-86-1860SS	116 lbs	WRSAD4-86-1860SS	109 lbs
18" x 72"	WRS4-74-1872SS	124 lbs	WRSAD4-74-1872SS	119 lbs	WRS4-86-1872SS	128 lbs	WRSAD4-86-1872SS	121 lbs
21" x 24"	WRS4-74-2124SS	68 lbs	WRSAD4-74-2124SS	63 lbs	WRS4-86-2124SS	72 lbs	WRSAD4-86-2124SS	65 lbs
21" x 30"	WRS4-74-2130SS	76 lbs	WRSAD4-74-2130SS	71 lbs	WRS4-86-2130SS	80 lbs	WRSAD4-86-2130SS	73 lbs
21" x 36"	WRS4-74-2136SS	88 lbs	WRSAD4-74-2136SS	83 lbs	WRS4-86-2136SS	92 lbs	WRSAD4-86-2136SS	85 lbs
21" x 42"	WRS4-74-2142SS	100 lbs	WRSAD4-74-2142SS	95 lbs	WRS4-86-2142SS	104 lbs	WRSAD4-86-2142SS	97 lbs
21" x 48"	WRS4-74-2148SS	108 lbs	WRSAD4-74-2148SS	103 lbs	WRS4-86-2148SS	112 lbs	WRSAD4-86-2148SS	105 lbs
21" x 54"	WRS4-74-2154SS	116 lbs	WRSAD4-74-2154SS	111 lbs	WRS4-86-2154SS	120 lbs	WRSAD4-86-2154SS	113 lbs
21" x 60"	WRS4-74-2160SS	128 lbs	WRSAD4-74-2160SS	123 lbs	WRS4-86-2160SS	132 lbs	WRSAD4-86-2160SS	125 lbs
21" x 72"	WRS4-74-2172SS	136 lbs	WRSAD4-74-2172SS	131 lbs	WRS4-86-2172SS	140 lbs	WRSAD4-86-2172SS	133 lbs
24" x 24"	WRS4-74-2424SS	76 lbs	WRSAD4-74-2424SS	71 lbs	WRS4-86-2424SS	80 lbs	WRSAD4-86-2424SS	73 lbs
24" x 30"	WRS4-74-2430SS	84 lbs	WRSAD4-74-2430SS	79 lbs	WRS4-86-2430SS	88 lbs	WRSAD4-86-2430SS	81 lbs
24" x 36"	WRS4-74-2436SS	92 lbs	WRSAD4-74-2436SS	87 lbs	WRS4-86-2436SS	96 lbs	WRSAD4-86-2436SS	89 lbs
24" x 42"	WRS4-74-2442SS	104 lbs	WRSAD4-74-2442SS	99 lbs	WRS4-86-2442SS	108 lbs	WRSAD4-86-2442SS	101 lbs
24" x 48"	WRS4-74-2448SS	112 lbs	WRSAD4-74-2448SS	107 lbs	WRS4-86-2448SS	116 lbs	WRSAD4-86-2448SS	109 lbs
24" x 54"	WRS4-74-2454SS	128 lbs	WRSAD4-74-2454SS	123 lbs	WRS4-86-2454SS	132 lbs	WRSAD4-86-2454SS	125 lbs
24" x 60"	WRS4-74-2460SS	140 lbs	WRSAD4-74-2460SS	135 lbs	WRS4-86-2460SS	144 lbs	WRSAD4-86-2460SS	137 lbs
24" x 72"	WRS4-74-2472SS	152 lbs	WRSAD4-74-2472SS	147 lbs	WRS4-86-2472SS	156 lbs	WRSAD4-86-2472SS	149 lbs

Shelving units include 4 posts and 4 shelves. Add-On units include 2 posts, 4 shelves and 8 shelf clamps.



Table with 8 columns: SHELF W" x L", MODEL NO., SHIP WGT, MODEL NO., SHIP WGT, MODEL NO., SHIP WGT, MODEL NO., SHIP WGT. Rows include 54" and 63" stainless solid shelving units with 5 shelves, listing starter and add-on kits.

Shelving units include 4 posts and 5 shelves. Add-On units include 2 posts, 5 shelves and 10 shelf clamps.

304 STAINLESS STEEL

400-600 lb. LOAD CAPACITY PER SHELF

Table with 8 columns: SHELF W" x L", MODEL NO., SHIP WGT, MODEL NO., SHIP WGT, MODEL NO., SHIP WGT, MODEL NO., SHIP WGT. Rows include 74" and 86" stainless solid shelving units with 5 shelves, listing starter and add-on kits.

Shelving units include 4 posts and 5 shelves. Add-On units include 2 posts, 5 shelves and 10 shelf clamps.

5 Shelf Starter Kits

Solid flat shelves allows for storage from small to large items, and the marine edge perimeter prevents spillage. The double hemmed 18 gauge 304 stainless steel gives the solid shelf excellent strength characteristics.



MOBILIZE YOUR SHELVING

DB - Donut Bumper Non-marking donut bumper used to protect walls and help cushion impact.

WR-00HS (Mobile Kit)\* Set of four swivel 5" x 1-1/4" thermo-plastic resin stainless steel casters with zerk grease fittings, 2 with brake. Can be used with all units shown. 1,200 lb. load capacity.



QSMC Shelf Clamp Shelf Clamp eliminates 2 posts per shelving section. Two QSMC clamps are required per shelf. Finish: Aluminum (Sold individually)



5 SHELF ADD-ON KIT

5 Shelf Add-On Kits

Additional Add-On kits allow you to expand your Starter kit by sharing a set of posts. Configuration options include side to side, back to back and right angles (L-Shape). Add-on units consist of 5 shelves, 2 posts and 10 shelf clamps.

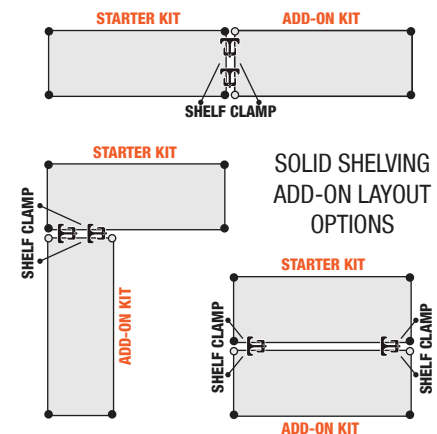

**Convenient 1 Box Wire Shelving Units**



4 shelf configuration, consumer grade wire shelving unit. Super competitive cost. All packed in 1 box for super easy inventory control, shipping, and receiving.

Finishes available in:  Chrome

MODEL NO.	DIMENSIONS W" x L" x H"	SHIP WGT
RWR72-1830LD	18" x 30" x 72"	35 lbs
RWR72-1836LD	18" x 36" x 72"	38 lbs
RWR72-1842LD	18" x 42" x 72"	42 lbs
RWR72-1848LD	18" x 48" x 72"	46 lbs
RWR72-2430LD	24" x 30" x 72"	40 lbs
RWR72-2436LD	24" x 36" x 72"	46 lbs
RWR72-2442LD	24" x 42" x 72"	51 lbs
RWR72-2448LD	24" x 48" x 72"	56 lbs



**MOBILIZE YOUR SHELVING**

**W-PLI - Post Insert**

Each unit will require one 4-pack.

**WR-3 (Mobile Kit)**

Set of four 3" polyurethane casters, all with brakes. Can be used with all units shown. 800 lb. load capacity.



**4 SHELF UNIT**  
Chrome Finish

**PERFORMANCE FEATURES:**

- 300 lb. load capacity per shelf
- Assembles in minutes
- Wire design allows for air circulation and minimal dust buildup
- Shelves easily adjust on 1" centers to your exact needs
- Ideal storage solution for any commercial, office, warehouse or home application
- Bright chrome finish
- Includes posts, shelves, and all needed hardware - all in one box
- No tools required



**SUPER LOW PRICE**

**SUPER LOW TRANSIT COST**

**SINGLE BOX SHIPMENT**

**300 lb. LOAD CAPACITY PER SHELF**

**Inside the Single Box Unit**

- 4 posts
- 4 wire shelves
- 4 packs of split sleeves

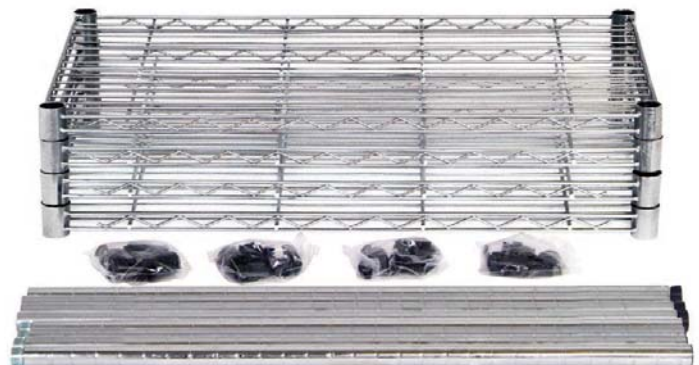



Smooth, vented, open grid surface allows for air circulation and minimal dust buildup



**NEW**  
PLASTIC MAT  
SHELVING UNITS

6 SIZES AVAILABLE  
AS SINGLE BOX  
SHIPMENT

4 SHELF UNIT  
Blue Finish



**Inside the Single Box Unit**

- 4 posts
- 2 or 3 pieces each
- 4 wire frames
- 4 plastic wire mats
- 2 or 3 pieces each
- 4 packs of split sleeves

**PERFORMANCE FEATURES:**

- 600 lb. load capacity per shelf
- Assembles in minutes
- Smooth, vented, open grid surface allows for air circulation and minimal dust buildup
- Plastic mats can be easily removed for cleaning and are dish washer safe
- Plastic material will never dent, chip, rust or corrode
- Shelves easily adjust to your exact height needs
- Ideal storage solution for any commercial or home application
- Posts and frames are steel with epoxy, antimicrobial blue finish

**SUPER  
LOW PRICE**

**SUPER LOW  
TRANSIT COST**

**Wire Plastic Mat Shelving Units**

4 shelf configuration, consumer grade wire/plastic mat hybrid shelving unit. Super competitive cost. Six size options ship in 1 box for super easy inventory control, shipping, and receiving.

Metal finish: ● Antimicrobial Blue

MODEL NO.	DIMENSIONS W" x L" x H"	SHIP WGT
<b>18" Deep Units</b>		
RPWR72-1830E*	18" x 30" x 72"	44 lbs
RPWR72-1836E*	18" x 36" x 72"	52 lbs
RPWR72-1842E	18" x 42" x 72"	56 lbs
RPWR72-1848E*	18" x 48" x 72"	60 lbs
RPWR72-1860E	18" x 60" x 72"	68 lbs
RPWR72-1872E	18" x 72" x 72"	80 lbs
<b>24" Deep Units</b>		
RPWR72-2430E*	24" x 30" x 72"	60 lbs
RPWR72-2436E*	24" x 36" x 72"	68 lbs
RPWR72-2442E	24" x 42" x 72"	72 lbs
RPWR72-2448E*	24" x 48" x 72"	76 lbs
RPWR72-2460E	24" x 60" x 72"	92 lbs
RPWR72-2472E	24" x 72" x 72"	108 lbs

**\*PACKAGED AS SINGLE BOX  
SHELVING UNITS**

**600 lb.  
LOAD CAPACITY  
PER SHELF**

**Additional Wire Plastic  
Mat Shelves**

Metal finish: ● Antimicrobial Blue

MODEL NO.	SHELF W" x L"	SHIP WGT
<b>18" Deep - Shelves</b>		
RP1830E	18" x 30"	7 lbs
RP1836E	18" x 36"	9 lbs
RP1842E	18" x 42"	10 lbs
RP1848E	18" x 48"	11 lbs
RP1860E	18" x 60"	13 lbs
RP1872E	18" x 72"	16 lbs
<b>24" Deep - Shelves</b>		
RP2430E	24" x 30"	11 lbs
RP2436E	24" x 36"	13 lbs
RP2442E	24" x 42"	14 lbs
RP2448E	24" x 48"	15 lbs
RP2460E	24" x 60"	19 lbs
RP2472E	24" x 72"	23 lbs

**Additional Wire Plastic  
Mat Posts**

- One piece post

Metal finish: ● Antimicrobial Blue

MODEL NO.	DESCRIPTION	SHIP WGT
RP63E	63"H Post	3 lb
RP72E	72"H Post	4 lb

**Corner Wire Shelving**



When in need of more storage space, Quantum Corner Wire Shelving is the answer. It's great for any corner area. It is versatile and durable, it is easy to assemble. Each shelf holds up to 700 lbs., evenly distributed. This versatile storage option will help your rooms stay neat, organized and maximized.

Finishes available in: ● Chrome

MODEL NO.	SHELF DIMENSIONS A" x B" x C" x D" x E"	SHIP WGT
<b>Corner Wire Shelves</b>		
1836CRNC	37-7/8" x 50-1/4" x 36" x 18" x 27"	16 lbs
2442CRNC	46" x 58-1/2" x 41-3/4" x 24" x 26-1/2"	21 lbs
<b>74"H - Corner Wire Shelving 4 Shelf System</b>		
WR74-1836CRNC	37-7/8" x 50-1/4" x 36" x 18" x 27"	80 lbs
WR74-2442CRNC	46" x 58-1/2" x 41-3/4" x 24" x 26-1/2"	100 lbs
<b>74"H - Corner Wire Shelving 5 Shelf System</b>		
WR74-1836CRNC-5	37-7/8" x 50-1/4" x 36" x 18" x 27"	96 lbs
WR74-2442CRNC-5	46" x 58-1/2" x 41-3/4" x 24" x 26-1/2"	121 lbs

**MOBILIZE YOUR SHELVING**



**DB - Donut Bumper**  
 Non-marking donut bumper used to protect walls and help cushion impact.

**WR-00H-5 (Mobile Kit)\***  
 Set of five swivel thermoplastic resin 5" x 1-1/4" casters, two with brakes. Can be used with all units shown. 1,500 lb. load capacity.

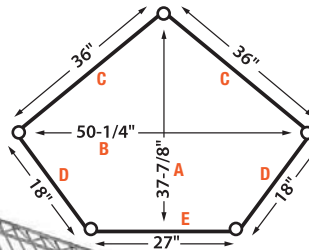

**1836CRNC**  
 Corner Wire Shelf  
 (Use with 18" deep wire shelving)

**700 lb.**  
**LOAD CAPACITY**  
**PER SHELF**

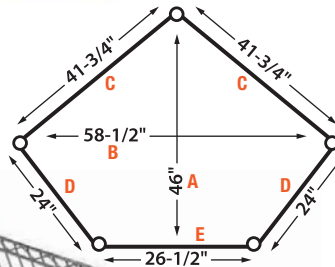

**2442CRNC**  
 Corner Wire Shelf  
 (Use with 24" deep wire shelving)



**4 SHELF UNIT**  
 Chrome Finish

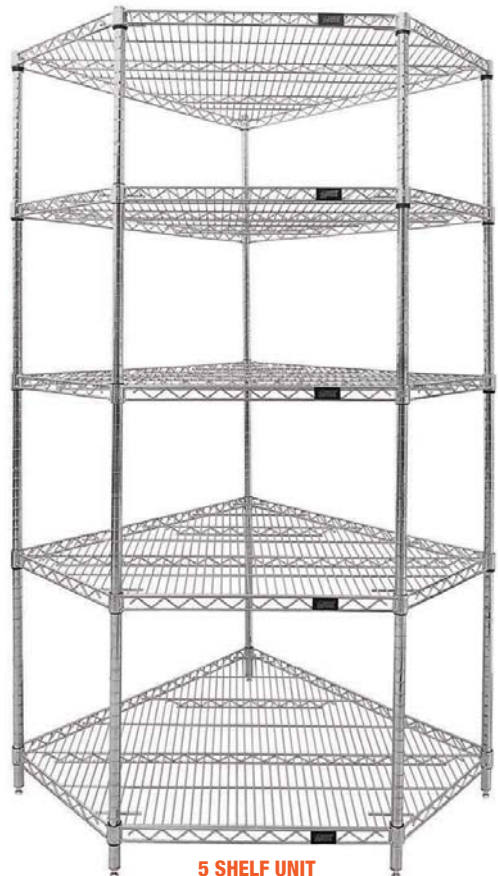

**5 SHELF UNIT**  
 Chrome Finish

**PERFORMANCE FEATURES:**

- 700 lb. load capacity per shelf
- Easy assembly with no tools needed
- Compatible with 18" and 24" deep Wire Shelving Add-On Units
- Shelves easily adjust on 1" centers to your exact needs
- Ideal storage solution for any commercial, office, warehouse or home application
- Bright chrome finish

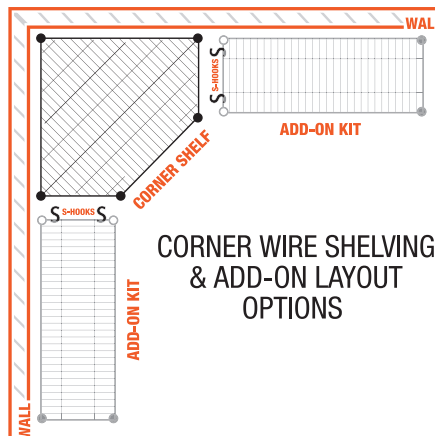

**CORNER WIRE SHELVING & ADD-ON LAYOUT OPTIONS**



Reel Shelving Units



NEW

Quantum Reel Shelving offers a safe and efficient method of transporting and storing standard size component reels. New reel shelves are chrome plated and can be used in conjunction with same size standard flat wire shelves. Units are available with conductive accessories providing a static safe storage system to address reel handling and providing stationary or mobile complete storage systems for PCB manufacturers. **Finish:** Chrome

MODEL NO.	DIMENSIONS W" x L"	HANDLES REEL SIZE	REEL CAPACITY	SHIP WGT
1836R16C	18" x 36"	13"-15"	15	10 lbs
1836R40C	18" x 36"	7"	78	12 lbs

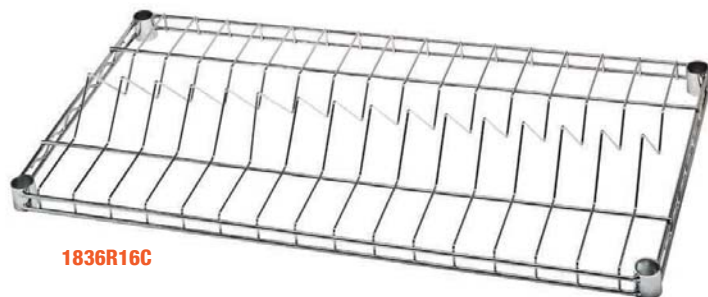

1836R16C

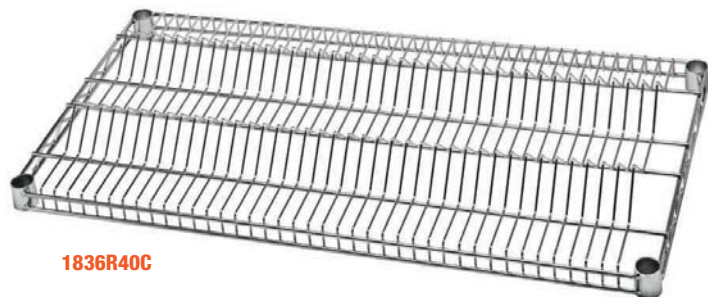

1836R40C

400 lb.  
LOAD CAPACITY PER SHELF



WRC-R264C  
Chrome Finish



MODEL NO.	DIMENSIONS W" x L" x H"	NO. OF SHELVES	SHIP WGT
WRC-R60C	18" x 36" x 69"	(4) 15-Reel Wire Shelves	75 lbs
WRC-R264C	18" x 36" x 69"	(2) 15-Reel Wire Shelves - (3) 78-Reel Wire Shelves	81 lbs
WRC-R468C	18" x 36" x 69"	(6) 78-Reel Wire Shelves	87 lbs

CARTS ARE CONDUCTIVE/ESD SAFE AND INCLUDES CONDUCTIVE CASTERS, CONDUCTIVE PLASTIC SPLIT SLEEVES, AND DRAG CHAIN

Conductive Accessories

WR-00CO  
Conductive Casters

- 4 swivel
- 2 brakes
- 2 non-brakes



WR-SSCO  
Conductive Plastic Split Sleeves



ESD-DC  
Drag Chain





**PARTition Wall Systems**

**1017HBC**  
Basket  
11-7/8"W x 18"L x 7-1/2"H

**HBL165C**  
16-1/2" Clear Label Holder  
also available in 3" and 34-1/2"

Stackable Shelf Bins  
available on *pg. 32*

**QLP-3661HC**  
Louvered Panel  
36"L x 61"H  
used with mounting frame  
**WS-PM36HC**

**1035HBC**  
Basket  
11-7/8"W x 36"L x 7-1/2"H

**1606DHB**  
Divider  
74" H

**1617HBC**  
Basket  
17-7/8"W x 18"L x 7-1/2"H

**WS-1818DSHC**  
Dust Shelf  
18"W x 18"L

26" D

**WS70-SS18ADHC**  
18" PARTition  
Wall System  
shown with Mobile Kit  
and optional accessories

54" W

**QTBLP-BKT**  
Tip Out Bin Hanging Bracket  
available on *pg. 87*

Tip Out Bins  
available on *pg. 87*

Mesh Stack & Hang Bins  
available on *pg. 6*

**1006DHB**  
Divider

**HBL345C**  
34-1/2" Clear Label Holder  
also available in 3" and 16-1/2"

Ultra Stack & Hang Bins  
available on *pg. 5*  
Clear Stack & Hang Bins  
available on *pg. 20*

**1635HBC**  
Basket  
17-7/8"W x 36"L x 7-1/2"H

**WS-1836DSHC**  
Dust Shelf  
18"W x 36"L

**WS70-SS36HC**  
36" PARTition  
Wall System  
shown with Mobile Kit  
and optional accessories

**INSTANT VISIBILITY, EASY TO CLEAN, ALL WELDED**



**QTBLP-BKT**  
Hanging Bracket for Tip Out Bins  
(Available in Beige or Gray)



All Starter and Add-On Units  
come standard with Leg Levelers



All Starter and Add-On Units  
can be made mobile

**Mobilize your units by ordering the following:**

- |                                 |                                 |
|---------------------------------|---------------------------------|
| <b>Single Sided Starter Kit</b> | <b>Double Sided Starter Kit</b> |
| 2 - <b>WS-SSMOB</b> Bar         | 2 - <b>WS-DSMOB</b> Bar         |
| 2 - <b>WS-MOB</b> Caster Kit    | 2 - <b>WS-MOB</b> Caster Kit    |
| <b>Single Sided Add-On Kit</b>  | <b>Double Sided Add-On Kit</b>  |
| 1 - <b>WS-SSMOB</b> Bar         | 1 - <b>WS-DSMOB</b> Bar         |
| 1 - <b>WS-MOB</b> Caster Kit    | 1 - <b>WS-MOB</b> Caster Kit    |

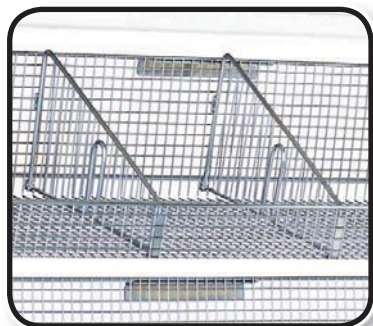

**NEW**  
**BASKET**  
**SIZES****FIRST POSITION**  
Flat**SECOND POSITION**  
10° slope**THIRD POSITION**  
30° slope**ADJUSTABLE BRACKETS**  
**ALLOW YOU TO CHOOSE**  
**YOUR IDEAL POSITION**  
**AND EASIEST ACCESS**  
**TO STORED PRODUCT****COMPLETE**  
**PACKAGES**  
**WITH BASKETS****DIVIDERS**  
Basket divider allows you to quickly and easily organize the contents of your basket unit by creating separate compartments within each basket  
*(Sold separately)***WS70-SS36-4S3L**  
Shown with dividers  
*(Sold separately)***Partition Wall Systems - Complete Packages**PARTition Wall Hanging Baskets are uniquely designed for instant visibility and easy access while maximizing your storage area. The wire construction minimizes dirt accumulation and allows air circulation. Baskets have a 1/2" x 1/2" grid pattern to partition product while letting you know when to reorder product and restock items. Available in 11-7/8" and 17-7/8" widths, and in 18", 36", and 48" lengths. **Finish:** Chrome

STARTER UNITS		ADD-ON		BASKET		ACCESSORIES		
MODEL NO.	SHIP WGT	MODEL NO.	SHIP WGT	MODEL NO.	NO. OF BASKET	DIVIDER	LABEL HOLDERS	DUST SHELF
MODEL NO.	SHIP WGT	MODEL NO.	SHIP WGT	MODEL NO.	NO. OF BASKET	MODEL NO.	MODEL NO.	MODEL NO.
<b>18" - Single Sided Systems - Complete with Baskets</b>								
WS70-SS18-7S	83 lbs	WS70-SS18AD-7S	71 lbs	1017HBC	7	1006DHB/1006DHB-SQ	HBL165C	WS-1218DSHC
WS70-SS18-4S3L	86 lbs	WS70-SS18AD-4S3L	86 lbs	1017HBC 1617HBC	4 3	1006DHB/1006DHB-SQ 1606DHB/1606DHB-SQ	HBL165C HBL165C	WS-1818DSHC
<b>36" - Single Sided Systems - Complete with Baskets</b>								
WS70-SS36-7S	117 lbs	WS70-SS36AD-7S	105 lbs	1035HBC	7	1006DHB/1006DHB-SQ	HBL345C	WS-1236DSHC
WS70-SS36-4S3L	123 lbs	WS70-SS36AD-4S3L	111 lbs	1035HBC 1635HBC	4 3	1006DHB/1006DHB-SQ 1606DHB/1606DHB-SQ	HBL345C HBL345C	WS-1836DSHC
<b>48" - Single Sided Systems - Complete with Baskets</b>								
WS70-SS48-7S	131 lbs	WS70-SS48AD-7S	119 lbs	1047HBC	7	1006DHB/1006DHB-SQ	HBL465C	WS-1248DSHC
WS70-SS48-4S3L	140 lbs	WS70-SS48AD-4S3L	128 lbs	1047HBC 1647HBC	4 3	1006DHB/1006DHB-SQ 1606DHB/1606DHB-SQ	HBL465C HBL465C	WS-1848DSHC



**Starter Units**

Starter units come complete with two uprights and three tie-bars.



WS70-SS18HC      WS70-SS36HC      WS70-SS48HC

**Add-On Units**

Add-On units allow you to expand your Starter unit by sharing an upright. Add-On unit includes one common upright and three tie-bars.



WS70-SS18ADHC      WS70-SS36ADHC      WS70-SS48ADHC

L"	STARTER UNITS		ADD-ON UNITS		ACCESSORIES				
	MODEL NO.	SHIP WGT	MODEL NO.	SHIP WGT	HANG BAR	12" DUST SHELF	18" DUST SHELF	LOUVERED PANEL	PANEL FRAME*
	MODEL NO.		MODEL NO.		MODEL NO.	MODEL NO.	MODEL NO.	MODEL NO.	MODEL NO.
<b>Single Sided Units</b>									
18"	WS70-SS18HC	31 lbs	WS70-SS18ADHC	31 lbs	-	WS-1218DSHC	WS-1818DSHC	QLP-1861HC	WS-PM18HC
36"	WS70-SS36HC	37 lbs	WS70-SS36ADHC	25 lbs	WS-HB36HC	WS-1236DSHC	WS-1836DSHC	QLP-3661HC	WS-PM36HC
48"	WS70-SS48HC	42 lbs	WS70-SS48ADHC	30 lbs	WS-HB48HC	WS-1248DSHC	WS-1848DSHC	QLP-4861HC	WS-PM48HC
<b>Double Sided Units</b>									
18"	WS70-DS18HC	34 lbs	WS70-DS18ADHC	21 lbs	-	WS-1218DSHC	WS-1818DSHC	QLP-1861HC	WS-PM18HC
36"	WS70-DS36HC	40 lbs	WS70-DS36ADHC	27 lbs	WS-HB36HC	WS-1236DSHC	WS-1836DSHC	QLP-3661HC	WS-PM36HC
48"	WS70-DS48HC	45 lbs	WS70-DS48ADHC	32 lbs	WS-HB48HC	WS-1248DSHC	WS-1848DSHC	QLP-4861HC	WS-PM48HC

\*Required to mount louvered panels

**CUSTOMIZE YOUR OWN UNIT**

*For Units using Hanging Brackets:*

1. Determine total space you want to fill from left to right
2. Select a Starter Unit (either 18", 36" or 48" wide)
3. Fill remaining space by utilizing Add-On Units
4. Determine how many basket levels you want to have per unit, which will correspond to the total number of brackets needed
5. Dividers and label holders are available for all basket sizes

*For Units using Louvered Panels:*

1. Determine total space you want to fill from left to right
2. Select a Starter Unit (either 18", 36" or 48" wide)
3. Fill remaining space by utilizing Add-On Units
4. Each unit (both Starter or Add-On) will fit a corresponding 18", 36" or 48" louvered panel (**note:** Louvered panel requires one panel frame)
5. Louvered panel will accommodate:
  - **Hanging Baskets** - available on pg. 114
  - **Clear Tip Out Bins** - available on pg. 87 (**note:** one hanging bracket pair QTBLP-BKT is needed per Tip Out Bin)
  - **Mesh Bins** - available on pg. 6
  - **Plastic Bins** - available on pgs. 5, 20 and 32 (see chart on the bottom of pg. 9 to determine quantity of bins that fit on panel)

**Hanging Baskets**

**NEW SIZES**

- 125 lb. load capacity per basket (up to twice as strong as plastic bins)
- Mesh design ensures no accumulation of dirt or dust and instant visibility
- Brilliant chrome finish ensures professional appearance and years of heavy-duty service
- Baskets can be divided allowing maximization of all space

**UNIQUELY DESIGNED FOR HIGH VISIBILITY AND EASY ACCESS**

MODEL NO.	OUTSIDE DIMENSIONS W" x L" x H"	INSIDE DIMENSIONS W" x L" x H"	SHIP WGT
<b>Hanging Baskets</b>			
1017HBC	11-7/8" x 18" x 7-1/2"	11" x 17-3/8" x 7"	5 lbs
1035HBC	11-7/8" x 36" x 7-1/2"	11" x 35" x 7"	9 lbs
1047HBC <b>NEW</b>	11-7/8" x 48" x 7-1/2"	11" x 47" x 7"	11 lbs
1617HBC	17-7/8" x 18" x 7-1/2"	17" x 17-3/8" x 7"	6 lbs
1635HBC	17-7/8" x 36" x 7-1/2"	17" x 35" x 7"	11 lbs
1647HBC <b>NEW</b>	17-7/8" x 48" x 7-1/2"	17" x 47" x 7"	14 lbs



WS-DS36HC  
Shown with Baskets  
(Sold separately)

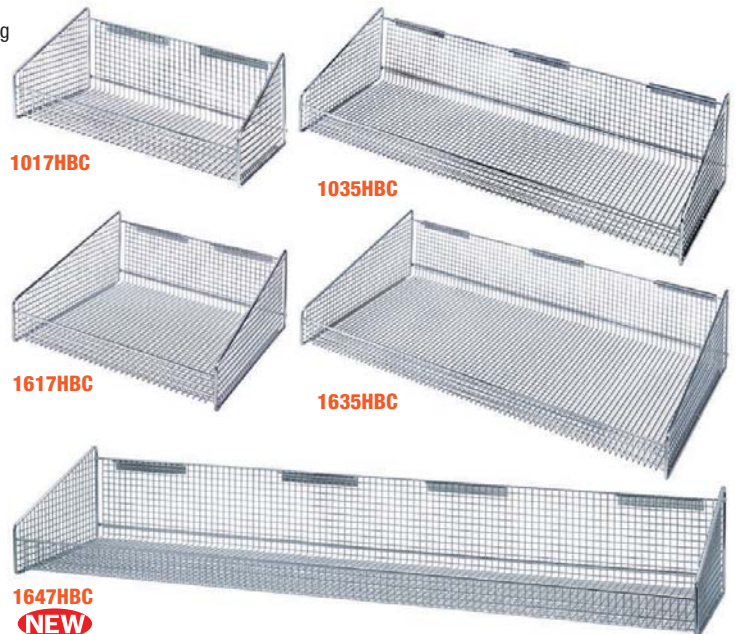



## Dividers

## 6 SIZES AVAILABLE

MODEL NO.	DIMENSIONS W" x H"	SHIP WGT
<b>Hanging Basket Dividers</b>		
4X3HBD <b>NEW</b>	3" x 4-1/2"	1 lb
4X6HBD <b>NEW</b>	6" x 4-1/2"	1 lb
4X9HBD <b>NEW</b>	9" x 4-1/2"	1 lb
4X15HBD <b>NEW</b>	15" x 4-1/2"	2 lbs
1006DHB	10" x 6"	1 lb
1606DHB	16" x 6"	2 lbs
1006DHB-SQ <b>NEW</b>	10" x 6"	1 lb
1606DHB-SQ <b>NEW</b>	16" x 6"	2 lbs

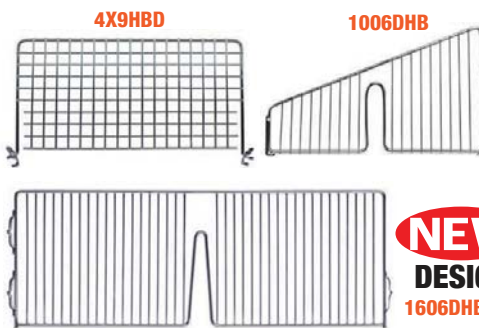
**NEW DESIGN**

1606DHB-SQ



Separate product in basket with use of optional dividers. Dividers are used front to back to create individual compartments.

## Clear Label Holders

Super easy method for identifying product. Affixes directly to the front on any basket. Four lengths available. (Label inserts sold separately).

MODEL NO.	DESCRIPTION	SHIP WGT
<b>Clear Label Holders</b>		
HBL3C	3" Clear Label Holder	1 lb
HBL165C	16-1/2" Clear Label Holder Fits 18" Basket	1 lb
HBL345C	34-1/2" Clear Label Holder Fits 36" Basket	1 lb
HBL465C	46-1/2" Clear Label Holder Fits 48" Basket	1 lb

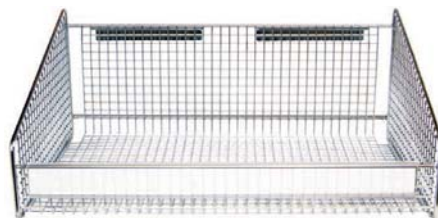

HBL165C



## Dust Shelves

WS-1218DSHC

MODEL NO.	DIMENSIONS W" x L"	SHIP WGT
<b>Dust Shelves*</b>		
WS-1218DSHC	12" x 18"	5 lbs
WS-1236DSHC	12" x 36"	10 lbs
WS-1248DSHC	12" x 48"	15 lbs
WS-1818DSHC	18" x 18"	7 lbs
WS-1836DSHC	18" x 36"	15 lbs
WS-1848DSHC	18" x 48"	20 lbs

\*Dust Shelves not designed for load bearing

## Spikes &amp; Holders

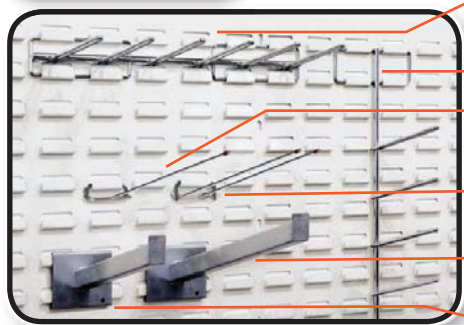

**WS-HTH**  
Horizontal Tape/Reel Holder  
25 lb. load capacity

**WS-VTH**  
Vertical Tape/Reel Holder  
25 lb. load capacity

**WS-SR9C**  
9" Single Rod  
15 lb. load capacity

**WS-DR10C**  
10" Double Rod  
15 lb. load capacity

**WS-HDS12**  
Heavy-Duty 12" Spike  
50 lb. load capacity

**WS-HDS6**  
Heavy-Duty 6" Spike  
65 lb. load capacity



WS-HBB

WS-HBBA



WS-HBB-D

WS-HBBA-D

## Hanging Brackets

MODEL NO.	DESCRIPTION	SHIP WGT
<b>Hanging Brackets</b>		
WS-HBB	90° Bracket Pair (2 pcs)	1 lb
WS-HBBA	Adjustable Bracket Pair (2 pcs)	1 lb
WS-HBB-D	90° Bracket for Add-On Kit	1 lb
WS-HBBA-D	Adjustable Bracket for Add-On Kit	1 lb

## Louvered Panels

MODEL NO.	DIMENSIONS L" x H"	SHIP WGT
<b>Oyster White Louvered Panels</b>		
QLP-1861HC	18" x 61"	21 lbs
QLP-3661HC	36" x 61"	40 lbs
QLP-4861HC	48" x 61"	60 lbs

\*Louvered Panels require panel frame in order to affix to PARTition Wall Systems



WS-HB36HC

## Hang Bars

Used to mount wire louvered panels on PARTition Wall Systems. Wire Panels available on [pg. 7](#)

MODEL NO.	DESCRIPTION	SHIP WGT
<b>Hang Bars</b>		
WS-HB36HC	36" Hang Bar	4 lbs
WS-HB48HC	48" Hang Bar	5 lbs



QLP-4861HC



QLP-3661HC



QLP-1861HC



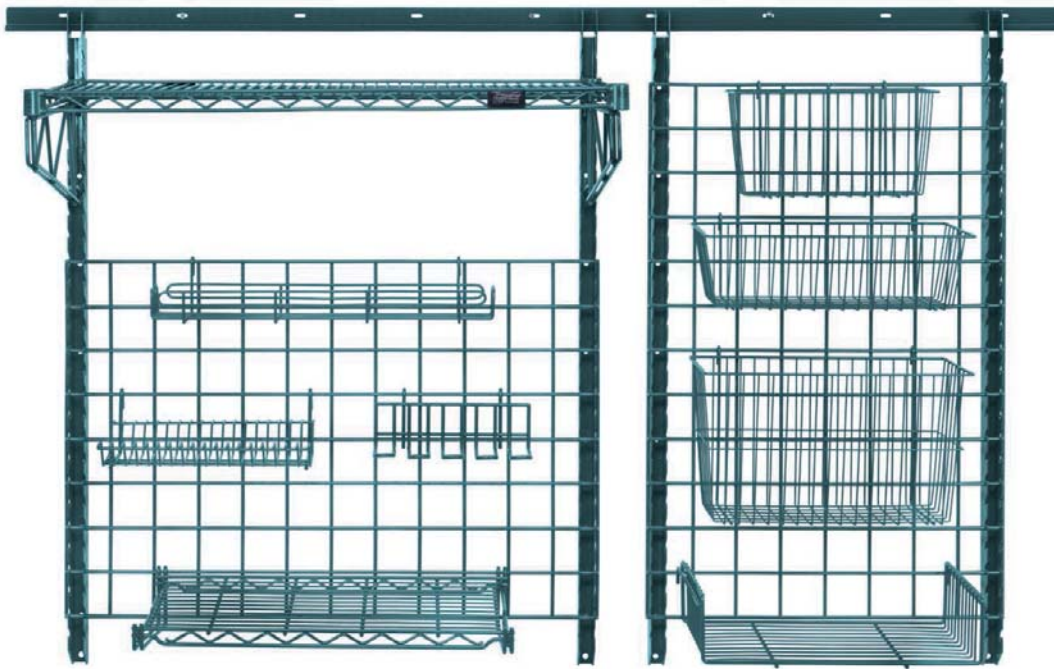

**IDEAL FOR MAXIMIZING EFFICIENCY IN ANY PREPARATION, STORAGE OR WORK SPACE**

- TO ORDER:**
1. Select size of smart grid wall tracks
  2. Select size and quantity of uprights
  3. Select number of shelves and shelf supports (two per shelf)
  4. Select grid and accessories

**Note:** Max capacity varies based on system configuration. Wall track only has a maximum capacity of 250 lbs. when mounted to a wall with wood studs or plywood. Wall track and upright configuration has a maximum configuration of 400 lbs. Capacity is calculated based on system mounted to wood studs or plywood.

**Smart Grid Mount System**

**NEW**

A versatile storage, utility and display system suited to maximize efficiencies of underutilized spaces and empty walls. Smart Grid has a sophisticated system that integrates wall tracks, grids, wall shelving and accessories in custom configurations and lengths. The use of the system around and above sinks, prep-stations, work tables, staging areas and equipment will keep these areas cleaner and more organized. Smart Grid enables the flexibility to add wall shelving and wall mounted task stations to any space for ease of accessibility and functionality. The durability of the 15 year warranty antimicrobial epoxy and robust design of the system protects against product degradation and ensures easy installation and maintenance. **Finish:** Proform Green Epoxy

- Keep small wares, utilities, inventory, tools, containers, utensils, and supplies off of the work surface and organized for fast, easy access. The work area remains clean and free from clutter to increase efficiencies.
- Grids attach to the uprights and enable the customizable configurations of accessories - bulk storage shelves, small supply shelves, baskets, hooks, drying rack accessories, utensil holders, bins, small utility racks, and a variety of holders.
- Easy installation and assembly. Mount the wall track and configure a customized work space using uprights, grids, shelves, and accessories.

**FLEXIBLE - WALL TRACKS AND UPRIGHTS ARE DESIGNED TO INTERFACE WITH WOOD STUDS, PLYWOOD, CONCRETE, AND OTHER SUITABLE WALL STRUCTURES**

**Uprights**

**SG-U16P**  
Upright  
16"

12 gauge cold rolled steel; slotted every 1-1/2"; 1-1/8" diameter mounting holes are spaced every 6" along the upright, sold as eaches. These slots attach to grids and shelf supports in a clip-in function.

MODEL NO.	DESCRIPTION	CTN QTY	CTN WGT
<b>Smart Grid Wall Mount Uprights</b>			
SG-U16P	16" Upright	1	2 lbs
SG-U31P	31" Upright	1	4 lbs
SG-U44P	44-1/2" Upright	1	5 lbs



**Wall Tracks**

**SG-WT56P**  
Wall Track  
56"

12 gauge cold rolled steel; obround mounting holes located at 8" increments; first and last holes are located 4" from the ends of the track; obround hole dimensions (1/8" x 3/4"). Wall tracks include stop fasteners for the ends of the tracks and joiner plates for connecting adjacent tracks. Hardware not included.

MODEL NO.	DESCRIPTION	CTN QTY	CTN WGT
<b>Smart Grid Wall Mount Tracks</b>			
SG-WT40P	40" Wall Track	1	5 lbs
SG-WT56P	56" Wall Track	1	6 lbs
SG-WT72P	72" Wall Track	1	7 lbs

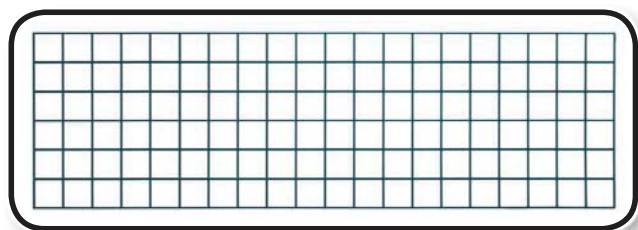

**Wire Grids**

**SG-1860P**  
Wire Grid  
18" x 60"

1/4" diameter cold rolled steel wire create with 3" x 3" openings that are easily attached to the uprights.

MODEL NO.	DESCRIPTION	CTN QTY	CTN WGT
<b>Smart Grid Wall Mount Grids</b>			
SG-1830P	18" x 30" Grid	1	8 lbs
SG-1836P	18" x 36" Grid	1	9 lbs
SG-1848P	18" x 48" Grid	1	12 lbs
SG-1860P	18" x 60" Grid	1	14 lbs
SG-2436P	24" x 36" Grid	1	12 lbs
SG-2448P	24" x 48" Grid	1	15 lbs
SG-3036P	30" x 36" Grid	1	13 lbs
SG-3048P	30" x 48" Grid	1	17 lbs
SG-3354P	33" x 54" Grid	1	21 lbs

Smart Grid Accessories

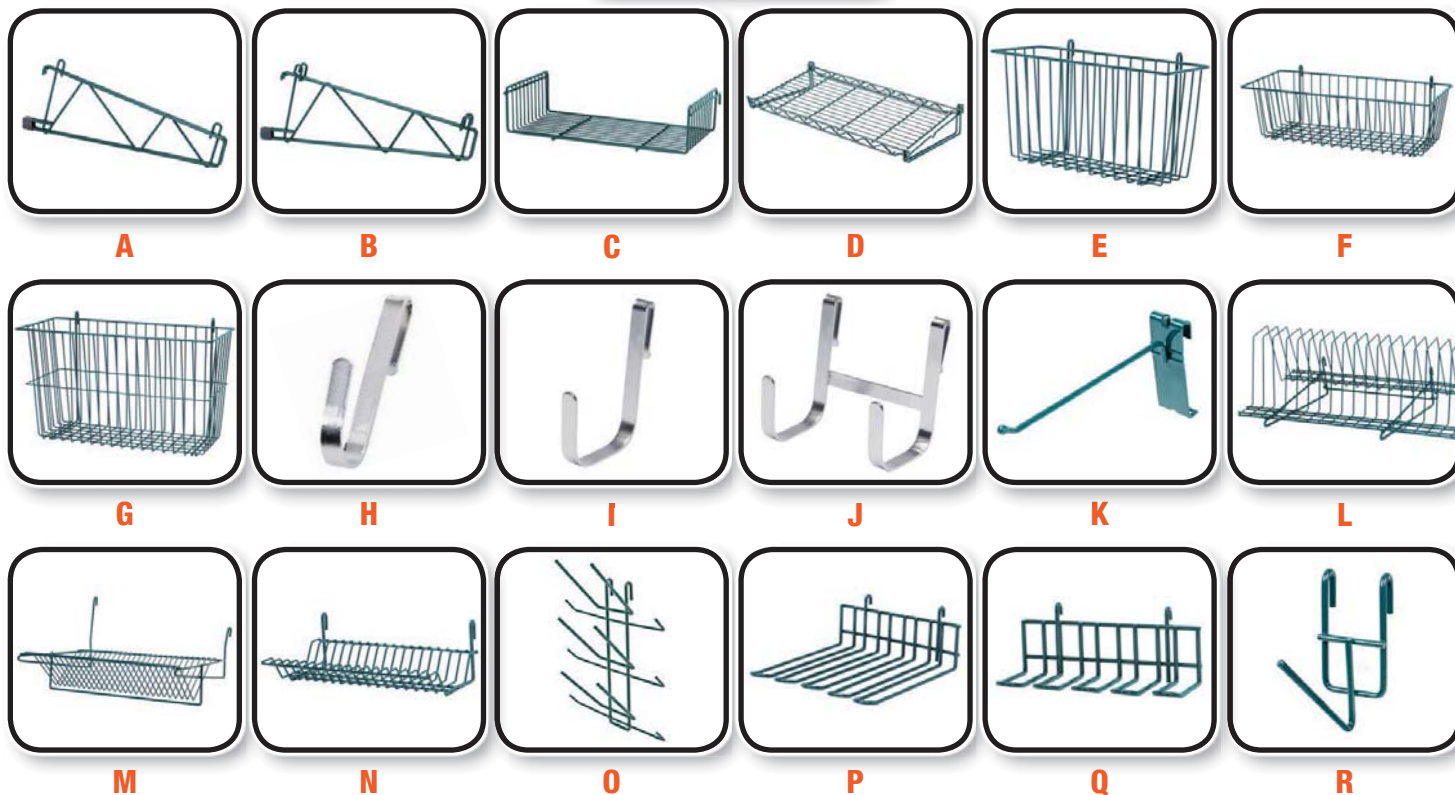

MODEL NO.	DESCRIPTION	CTN QTY	CTN WGT
<b>Accessories</b>			
A*	SG-CS14P 14" Shelf Single Cantilever	1	3 lbs
	SG-CS18P 18" Shelf Single Cantilever	1	3 lbs
	SG-CS21P 21" Shelf Single Cantilever	1	4 lbs
	SG-CS24P 24" Shelf Single Cantilever	1	4 lbs
B*	SG-CD14P 14" Shelf Double Cantilever	1	3 lbs
	SG-CD18P 18" Shelf Double Cantilever	1	3 lbs
	SG-CD21P 21" Shelf Double Cantilever	1	4 lbs
	SG-CD24P 24" Shelf Double Cantilever	1	4 lbs
C	SG-S918P 9" x 18" Shelf with Side Ledge	1	1 lb
D	SG-S1224P 12" x 24" Small Grid Shelf	1	1 lb
E	SG-B1357P 13-3/8" x 5" x 7" Basket	1	9 lbs
F	SG-B1775P 17-3/8" x 7-1/2" x 5" Basket	1	7 lbs
G	SG-B17710P 17-3/8" x 7-1/2" x 10" Basket	1	11 lbs
H	SG-HOOKSM Small Hook	1	1 lb
I	SG-HOOKLG Large Hook	1	1 lb
J	SG-HOOKDB Double Large Hook	1	1 lb
K	SG-HOOK6P 6" Hook	1	1 lb
L	SG-TDR461410P Tray Drying Rack	1	12 lbs
M	SG-SLH201412P Slanted Lid Holder/Drying Shelf	1	5 lbs
N	SG-LH1384P Lid Holder/Drying Shelf	1	2 lbs
O	SG-BR6P 6-Prong Bottle Rack	1	2 lbs
P	SG-UH10P Large Utensil Holder	1	4 lbs
Q	SG-UH4P Small Utensil Holder	1	4 lbs
R	SG-CMBP Cylinder Holder Mounting Bracket	1	1 lb
S	SG-CH Flatware Cylinder	1	1 lb
T	SG-SBH Single Bin Holder	1	1 lb
	SG-SMBH Small Bin Holder	1	1 lb
	SG-LGBH Large Bin Holder	1	2 lbs
U	SG-SR2254P Spice Rack Utility Rack	1	4 lbs
V	SG-IPH Insert Pan Holder Plated	1	2 lbs
W	SG-HFF Hanging File Folder Plated	1	3 lbs
X	SG-GBHP Glove Box Holder	1	2 lbs
Y	SG-BH29P Book Holder 2" x 9"	1	3 lbs
Z	SG-DWB Mounting Bracket Kit For Wall (Pack of 6)	1	2 lbs
AB	SG-PWM Plastic Grid Mounting Bracket Kit For Wall (Pack of 6)	1	2 lbs

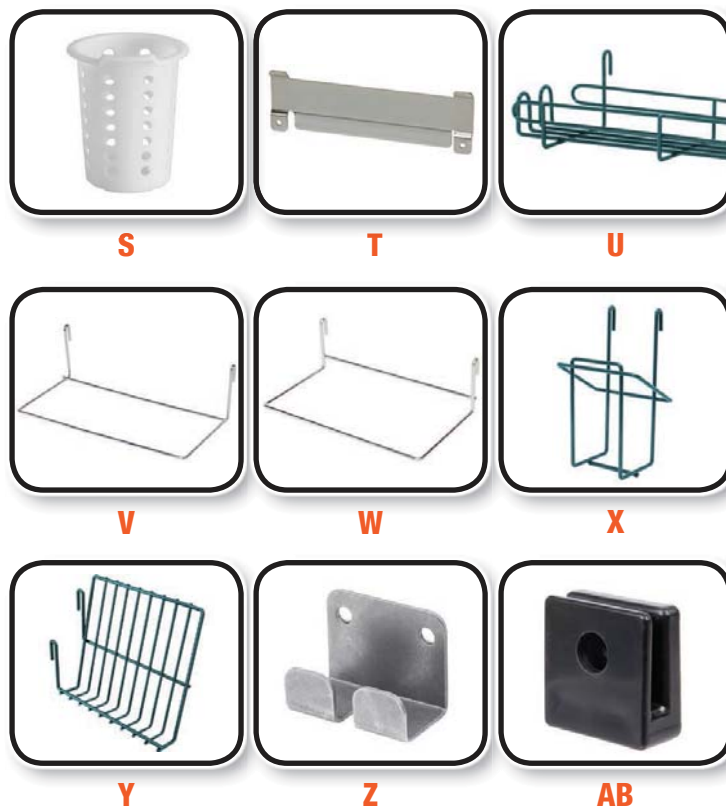

**CUSTOMIZABLE CONFIGURATIONS OF A VARIETY OF ACCESSORIES**

\*Shelf Cantilevers provide support for Quantum 14", 18", 21" and 24" epoxy shelves. Double Cantilevers are used for a side-by-side configuration.



**Cantilever Single Shelf Wall Mount**

Cantilever shelving is an excellent way to create storage space when floor space isn't available. Simple in design, our cantilever shelving systems are easy to assemble and install. Select from three different depths: 14", 18" or 24". Two cantilever arms and 2 mounting brackets are included per order. Wire shelves are sold separately and are available on **pg. 98**. **Finish:** Chrome, Proform Green and Gray Epoxy

MODEL NO.	DESCRIPTION	SHIP WGT
<b>Chrome Cantilever Arms and Mounting Brackets</b>		
DWB14	2 - 14" Cantilever Arms & 2 Mounting Brackets	3 lbs
DWB18	2 - 18" Cantilever Arms & 2 Mounting Brackets	4 lbs
DWB24	2 - 24" Cantilever Arms & 2 Mounting Brackets	5 lbs
<b>Proform Green Epoxy Cantilever Arms and Mounting Brackets</b>		
DWB14P <b>NEW</b>	2 - 14" Cantilever Arms & 2 Mounting Brackets	3 lbs
DWB18P <b>NEW</b>	2 - 18" Cantilever Arms & 2 Mounting Brackets	4 lbs
DWB24P <b>NEW</b>	2 - 24" Cantilever Arms & 2 Mounting Brackets	5 lbs
<b>Gray Epoxy Cantilever Arms and Mounting Brackets</b>		
DWB14GY <b>NEW</b>	2 - 14" Cantilever Arms & 2 Mounting Brackets	3 lbs
DWB18GY <b>NEW</b>	2 - 18" Cantilever Arms & 2 Mounting Brackets	4 lbs
DWB24GY <b>NEW</b>	2 - 24" Cantilever Arms & 2 Mounting Brackets	5 lbs

**Cantilever Multiple Shelf Post Wall Mount Adjustable on 1" increments**

Adjustable post wall mount systems use a post cantilever single arm of 14", 18" or 24" with appropriate shelf size and post height. Two post cantilever single arms and 4 post mount brackets are included per order.

Post Cantilever Double Arm is available in 14", 18" and 24" and uses the center post for continuous or add-on shelf sections. One post cantilever double arm and 2 post mount brackets are included per order. Wire shelves and post are sold separately and available on **pgs. 98 & 99**. **Finish:** Chrome, Stainless Steel, Proform Green and Gray Epoxy

MODEL NO.	DESCRIPTION	SHIP WGT
<b>Chrome Single Post Cantilever Arms</b>		
CB14	2 - 14" Single Post Cantilever Arms & 4 Post Mount Brackets	5 lbs
CB18	2 - 18" Single Post Cantilever Arms & 4 Post Mount Brackets	6 lbs
CB24	2 - 24" Single Post Cantilever Arms & 4 Post Mount Brackets	7 lbs
<b>Proform Green Epoxy Single Post Cantilever Arms</b>		
CB14P <b>NEW</b>	2 - 14" Single Post Cantilever Arms & 4 Post Mount Brackets	5 lbs
CB18P <b>NEW</b>	2 - 18" Single Post Cantilever Arms & 4 Post Mount Brackets	6 lbs
CB24P <b>NEW</b>	2 - 24" Single Post Cantilever Arms & 4 Post Mount Brackets	7 lbs
<b>Gray Epoxy Single Post Cantilever Arms</b>		
CB14GY <b>NEW</b>	2 - 14" Single Post Cantilever Arms & 4 Post Mount Brackets	5 lbs
CB18GY <b>NEW</b>	2 - 18" Single Post Cantilever Arms & 4 Post Mount Brackets	6 lbs
CB24GY <b>NEW</b>	2 - 24" Single Post Cantilever Arms & 4 Post Mount Brackets	7 lbs
<b>Stainless Steel Single Post Cantilever Arms</b>		
CB14S <b>NEW</b>	2 - 14" Single Post Cantilever Arms & 4 Post Mount Brackets	5 lbs
CB18S <b>NEW</b>	2 - 18" Single Post Cantilever Arms & 4 Post Mount Brackets	6 lbs
<b>Chrome Double Post Cantilever Arms</b>		
DCB14	1 - 14" Double Post Cantilever Arm & 2 Post Mount Brackets	10 lbs
DCB18	1 - 18" Double Post Cantilever Arm & 2 Post Mount Brackets	12 lbs
DCB24	1 - 24" Double Post Cantilever Arm & 2 Post Mount Brackets	14 lbs
<b>Proform Green Epoxy Double Post Cantilever Arms</b>		
DCB14P <b>NEW</b>	1 - 14" Double Post Cantilever Arm & 2 Post Mount Brackets	10 lbs
DCB18P <b>NEW</b>	1 - 18" Double Post Cantilever Arm & 2 Post Mount Brackets	12 lbs
DCB24P <b>NEW</b>	1 - 24" Double Post Cantilever Arm & 2 Post Mount Brackets	14 lbs
<b>Gray Epoxy Double Post Cantilever Arms</b>		
DCB14GY <b>NEW</b>	1 - 14" Double Post Cantilever Arm & 2 Post Mount Brackets	10 lbs
DCB18GY <b>NEW</b>	1 - 18" Double Post Cantilever Arm & 2 Post Mount Brackets	12 lbs
DCB24GY <b>NEW</b>	1 - 24" Double Post Cantilever Arm & 2 Post Mount Brackets	14 lbs

**TURN EMPTY WALLS INTO STORAGE SPACE**

**AVAILABLE IN CHROME, PROFORM GREEN AND GRAY EPOXY**



**NEW FINISHES**

**AVAILABLE IN CHROME, PROFORM GREEN OR GRAY EPOXY AND STAINLESS STEEL**

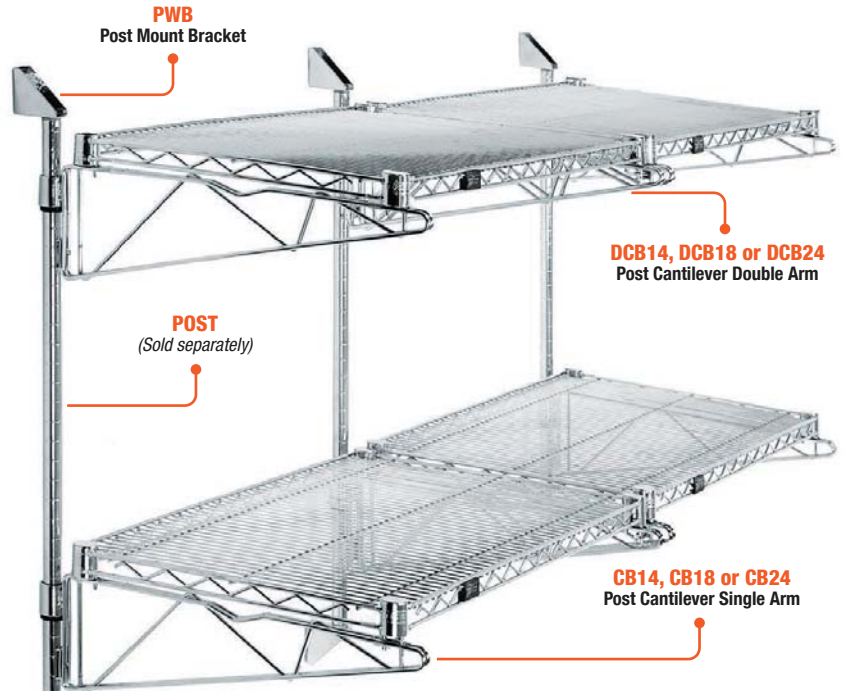

CB14, CB18 or CB24 Post Cantilever Single Arm



**PWB Post Mount Bracket**  
Used to secure cantilever post mount units and free standing shelving units to wall. Available in Chrome, Stainless Steel, Proform Green, Gray and Black Epoxy. Sold in a pack of 4. (Mounting Screws are not included)

**TO ORDER THIS EXACT CONFIGURATION, YOU WOULD ORDER THE FOLLOWING:**

- 2 - CB18
- 2 - DCB18
- 4 - 1836C
- 3 - P34C

To further extend the configuration shown by an additional section to the left or right, simply order:

- 2 - DCB18
- 2 - 1836C
- 1 - P34C

To further extend the configuration shown by an additional shelf level, simply order:

- 1 - CB18
- 1 - DCB18
- 2 - 1836C

Your options are unlimited.



### Post Wall Mount Cantilever with Bin Rail Holder - Complete Packages

Easy access, adjustable wall mounted bin systems. Available in 36", 48" and 60" widths. Optional bin dividers, windows fronts and clear label holders are available on pg. 5.

MODEL NO.	NO. OF BIN RAILS	DIMENSIONS L" x H"	NO. OF BINS	BIN DIMENSIONS L" x W" x H"	SHIP WGT
<b>Wire Cantilever Bin Holder - Complete with Bins</b> Available in Blue, Green, Ivory, Red, Yellow, Black and Clear					
CAN-34-36BH-230	3	36" x 34"	18 QUS230	10-7/8" x 5-1/2" x 5"	26 lbs
CAN-34-48BH-230	3	48" x 34"	24 QUS230	10-7/8" x 5-1/2" x 5"	34 lbs
CAN-34-60BH-230	3	60" x 34"	30 QUS230	10-7/8" x 5-1/2" x 5"	42 lbs

## COMPLETE PACKAGES WITH BINS



CAN-34-36BH-230



CAN-34-60BH-230

### Post Wall Mount Cantilever with Baskets - Complete Packages

Modular Wire Baskets mount to standard post to utilize wall space efficiently. Baskets allow for high visibility and quick accessibility. Baskets are adjustable and removable. *Finish:* Chrome

MODEL NO.	NO. OF BASKETS	BASKET MODEL NO.	BASKET DIMENSIONS W" x L" x H"	SHIP WGT
<b>34"H - Wire Cantilever with Baskets - Complete Packages</b>				
CAN-34-1436BC-PWB	2	1436BC	14" x 36" x 9"	26 lbs
CAN-34-1448BC-PWB	2	1448BC	14" x 48" x 9"	32 lbs
CAN-34-2036BC-PWB	2	2036BC	20" x 36" x 9"	30 lbs
CAN-34-2048BC-PWB	2	2048BC	20" x 48" x 9"	36 lbs
CAN-34-203612BC-PWB	2	203612BC	20" x 36" x 12"	34 lbs
CAN-34-204812BC-PWB	2	204812BC	20" x 48" x 12"	38 lbs

## COMPLETE PACKAGES WITH BASKETS



**COLLAR HOOKS**  
Baskets connect via collar hooks to post



CAN-34-1436BC-PWB

### DIVIDERS AVAILABLE FOR ALL BASKETS

#### Basket Dividers

Optional dividers can be used to separate product. *Finish:* Chrome

DIVIDER MODEL NO.	DIMENSIONS L" x H"	SHIP WGT
149DC	14" x 9"	1 lb
209DC	20" x 9"	2 lbs
2012DC	20" x 12"	2 lbs



149DC  
Shown on Basket

**Modular Wire Stacking Baskets**

Offer a variety of storage, display, and mobile supply applications. Dividers can be used to separate product. Accessible front and a wide selection of sizes allow for all types of product to be used from storage to display. (Dividers sold separately) **Finish:** Chrome



**1436BC**  
 Shown with Dividers and Clear Label Holder (Sold separately)

**CLEAR LABEL HOLDERS**  
 Super easy method for identifying product. Affix directly to the front on any basket. Available in three lengths. (Sold separately)

MODEL NO.	DESCRIPTION	SHIP WGT
<b>Clear Label Holders</b>		
<b>BLH3C</b>	3" Clear Label Holder	1 lb
<b>BLH14C</b>	14" Clear Label Holder	1 lb
<b>BLH32C</b>	32" Clear Label Holder	1 lb

MODEL NO.	BASKET DIMENSIONS W" x L" x H"	SHIP WGT	DIVIDER MODEL NO.	SHIP WGT
<b>1436BC</b>	14" x 36" x 9"	10 lbs	<b>149DC</b>	1 lb
<b>1448BC</b>	14" x 48" x 9"	13 lbs	<b>149DC</b>	1 lb
<b>2036BC</b>	20" x 36" x 9"	12 lbs	<b>209DC</b>	2 lbs
<b>2048BC</b>	20" x 48" x 9"	15 lbs	<b>209DC</b>	2 lbs
<b>203612BC</b>	20" x 36" x 12"	14 lbs	<b>2012DC</b>	2 lbs
<b>204812BC</b>	20" x 48" x 12"	16 lbs	<b>2012DC</b>	2 lbs



**WR5-36MSBA**

**FOR ALL TYPES OF PRODUCTS**



**DOLLY BASE**

**WR5-36MSBA-MOB**

**80 lb. STACK CAPACITY PER BASKET**

Build and stack any combination of baskets for your requirements. Larger baskets must be positioned on the lowest point.

**800 lb. MOBILE LOAD CAPACITY**

**Stationary Stacking Baskets**

Order this exact unit  
**WR5-36MSBA**  
 Unit consists of:  
 2 - baskets **1436BC**  
 2 - dividers **149DC**  
 3 - baskets **203612BC**  
 3 - dividers **2012DC**

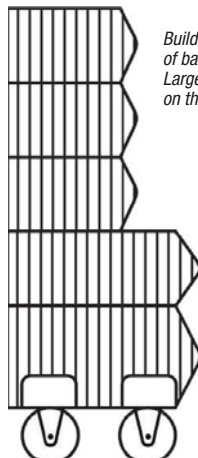

**Dolly Base**

Includes 4 - 5" x 1-1/4" swivel casters which offer easy transport.

MODEL NO.	DIMENSIONS W" x L"	SHIP WGT
<b>M2036BD</b>	20" x 36"	32 lbs
<b>M2048BD</b>	20" x 48"	34 lbs

**Mobile Stacking Baskets**

Order this exact unit  
**WR5-36MSBA-MOB**  
 Unit consists of:  
 2 - baskets **1436BC**  
 2 - dividers **149DC**  
 3 - baskets **203612BC**  
 3 - dividers **2012DC**  
 1 - dolly **M2036BD**





### 3 BASKET POSITIONS FOR FLEXIBLE STORAGE



**ANGLE DOWN**  
Flows parts to front provides maximum accessibility



**FLAT**  
Provides maximum space efficiency



**ANGLED UP**  
Provides maximum bin capacity

### Wire Basket Units

Basket units allow high visibility and air circulation. Baskets act as perfect pick bins which can be added to 18", 21" and 24" deep shelving units. The collar hook allows the basket to be removed or adjusted to accommodate various product mix and sizes. Baskets are adjustable on 1" increments. 150 lb. load capacity per basket. Adjustable baskets used in combination with shelves are an excellent method to store all types of products. Units can be stationary or mobile. Casters add flexibility and convert stationary units into transport systems. Ideal for exchange charts and par level storage. (Dividers sold separately) **Finish:** Chrome



**M1836BC6C**  
(Dividers sold separately)



**COLLAR HOOKS**  
Hooks onto basket corner allowing basket to securely hang.



**1836BC6C**  
(Dividers sold separately)

### Mobile Wire Basket Units

Each mobile unit consists of:

- 4 - 63"H posts
- 3 - 9"H adjustable baskets including collar hooks
- 2 - wire shelves
- 4 - donut bumpers
- 4 - swivel 5" x 1-1/4" thermoplastic resin casters, 2 with brakes

MOBILE MODEL NO.	DIMENSIONS W" x L" x H"	NO. OF SHELVES	NO. OF BASKETS	SHIP WGT
<b>M1836BC6C</b>	18" x 36" x 69"	2	3	78 lbs
<b>M1848BC6C</b>	18" x 48" x 69"	2	3	90 lbs
<b>M2436BC6C</b>	24" x 36" x 69"	2	3	93 lbs
<b>M2448BC6C</b>	24" x 48" x 69"	2	3	108 lbs

### Stationary Wire Basket Units

Each stationary unit consists of:

- 4 - 63"H posts
- 3 - 9"H adjustable baskets including collar hooks
- 2 - wire shelves

STATIONARY MODEL NO.	DIMENSIONS W" x L" x H"	NO. OF SHELVES	NO. OF BASKETS	SHIP WGT
<b>1836BC6C</b>	18" x 36" x 63"	2	3	70 lbs
<b>1848BC6C</b>	18" x 48" x 63"	2	3	82 lbs
<b>2436BC6C</b>	24" x 36" x 63"	2	3	85 lbs
<b>2448BC6C</b>	24" x 48" x 63"	2	3	100 lbs

## COMPLETE PACKAGES WITH BASKETS

Post Baskets

HIGH VISIBILITY, EASY TO CLEAN, ALL-WELDED

Quantum's post baskets are manufactured of industrial grade chrome wire offering a 5/8" x 5/8" mesh design on the bottom/flat surface. Super heavy-duty design affords a generous 600-800 lb. load capacity\* evenly distributed. Unique design allows baskets to be used without needing any flat shelves to stabilize overall unit. Drop front and sloped sides provide super easy access while providing a captive space for stored items. Baskets are all adjustable on 1" increments utilizing standard 1" diameter posts. **Finish:** Chrome

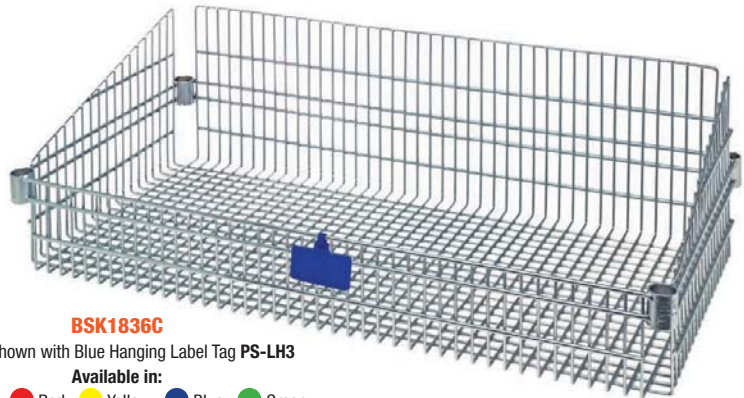

MODEL NO.	DIMENSIONS W" x L" x H"	SHIP WGT	DIVIDER MODEL NO.	SHIP WGT
BSK1824C	18" x 24" x 10"	11 lbs	DSK18	2 lbs
BSK1836C	18" x 36" x 10"	13 lbs	DSK18	2 lbs
BSK1848C	18" x 48" x 10"	17 lbs	DSK18	2 lbs
BSK1860C	18" x 60" x 10"	27 lbs	DSK18	2 lbs
BSK2424C	24" x 24" x 10"	12 lbs	DSK24	3 lbs
BSK2436C	24" x 36" x 10"	15 lbs	DSK24	3 lbs
BSK2448C	24" x 48" x 10"	20 lbs	DSK24	3 lbs
BSK2460C	24" x 60" x 10"	34 lbs	DSK24	3 lbs

**BSK1836C**  
Basket shown with Blue Hanging Label Tag PS-LH3  
Available in:  
● Clear ● Red ● Yellow ● Blue ● Green  
● Orange ● Pink ● Purple  
(Sold separately)

\*24" - 48" wide offer 800 lb. capacity evenly distributed 60" wide offers 600 lb. capacity evenly distributed

Clear Label Holders

A super easy method for identifying product. Affixes directly to the front on any post basket. Available in six lengths. (Label inserts sold separately)

MODEL NO.	DESCRIPTION	SHIP WGT
<b>Clear Label Holders</b>		
BLH3C	3" Clear Label Holder	1 lb
BLH14C	14" Clear Label Holder	1 lb
BLH20C	20" Clear Label Holder	1 lb
BLH32C	32" Clear Label Holder	1 lb
BLH44C	44" Clear Label Holder	1 lb
BLH56C	56" Clear Label Holder	1 lb

COMPLETE CARTS INCLUDE CASTER KIT FOR MOBILITY

1,200 lb. MOBILE LOAD CAPACITY

Mobile 5 Post Basket Units

Each mobile unit consists of:

- 4 - 74" H posts
- 5 - post basket
- 4 - donut bumpers
- 4 - 5" x 1-1/4" swivel thermoplastic resin casters, 2 with brake

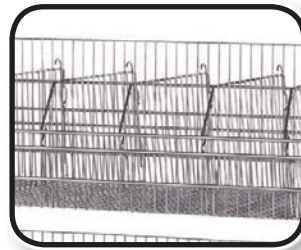

DIVIDERS

Post basket divider allows you to quickly and easily organize the contents of your post basket unit by creating separate compartments within each basket (Sold separately)

MODEL NO.	DIMENSIONS W" x L" x H"	SHIP WGT
WRC74-BSK1824C-5	18" x 24" x 80"	94 lbs
WRC74-BSK1836C-5	18" x 36" x 80"	127 lbs
WRC74-BSK1848C-5	18" x 48" x 80"	160 lbs
WRC74-BSK1860C-5	18" x 60" x 80"	197 lbs
WRC74-BSK2424C-5	24" x 24" x 80"	125 lbs
WRC74-BSK2436C-5	24" x 36" x 80"	158 lbs
WRC74-BSK2448C-5	24" x 48" x 80"	191 lbs
WRC74-BSK2460C-5	24" x 60" x 80"	228 lbs



WRC74-BSK1836C-5



### Hanging Label Tags

8 COLORS AVAILABLE

NEW COLORS

New design Hanging Label tab has flat surface on one side to allow for self-adhesive label. Opposite side has a slot for label to be inserted and easily removed or changed as needed. Paper labels are not included. Label tags work with all wire shelves, mesh bins, hanging, stacking and post baskets. Available in 8 colors. Package of 25.

PS-LH3  
Hanging Label Tag  
Fits 1-3/8" x 3"  
Adhesive Label

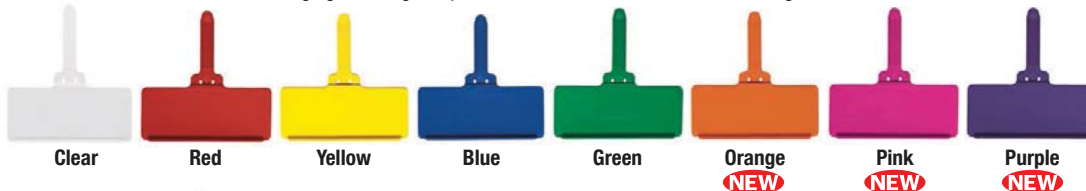

### Shelf Label Holders

LHA3C



Are an excellent method for identifying product. Holders affix directly to truss on any size shelf. (Label inserts sold separately)

### EASILY IDENTIFY PRODUCT ON ANY SIZE SHELF



LH3C and LH3B Front Shelf View

### Stacking & Post Basket Clear Label Holders

A super easy method for identifying product. Affixes directly to the front on any stacking and post basket. Available in six lengths. (Label inserts sold separately)

MODEL NO.	DESCRIPTION	SHIP WGT
<b>Clear Label Holders</b>		
BLH3C	3" Clear Label Holder	1 lb
BLH14C	14" Clear Label Holder	1 lb
BLH20C	20" Clear Label Holder	1 lb
BLH32C	32" Clear Label Holder	1 lb
BLH44C	44" Clear Label Holder	1 lb
BLH56C	56" Clear Label Holder	1 lb

MODEL NO.	DESCRIPTION	SHIP WGT
LH3B	3" Gray Label Holder	1 lb
LH3C	3" Clear Label Holder	1 lb
LH12C	12" Clear Label Holder	1 lb
LH24C	24" Clear Label Holder	1 lb

#### Full Length Label Holders

LH33C	33" Clear Label Holder Fits 36" Shelf	1 lb
LH39C	39" Clear Label Holder Fits 42" Shelf	1 lb
LH45C	45" Clear Label Holder Fits 48" Shelf	1 lb
LH51C	51" Clear Label Holder Fits 54" Shelf	2 lbs
LH57C	57" Clear Label Holder Fits 60" Shelf	2 lbs
LH69C	69" Clear Label Holder Fits 72" Shelf	2 lbs

#### Angled Label Holders - 30°, 60° and 90°

LHA3C	3" Angled Clear Label Holder	1 lb
LHA5C	5" Angled Clear Label Holder	1 lb
LHA24C	24" Angled Clear Label Holder	1 lb



LHA3C 3 Different Angles

### ANGLED LABEL HOLDER ADVANTAGE

ANGLED LABEL HOLDERS ALLOW YOU TO POSITION AND PIVOT ANGLE TO BEST SUIT YOUR NEEDS



BLH20C

Shown on Basket with Dividers  
(Sold separately)

### Laser and Inkjet Label Inserts

Laser and inkjet compatible inserts come in 8-1/2" x 11" perforated sheets. Available in 3" and 6" lengths. Multiple inserts can be used on longer label holders. Package of 48 labels.

MODEL NO.	DESCRIPTION	SHIP WGT
<b>Laser and Inkjet Label Inserts - 48 Labels</b>		
LHI-3	1-1/4" x 3" Inserts (3 Sheets)	1 lb
LHI-6	1-1/4" x 6" Inserts (6 Sheets)	1 lb

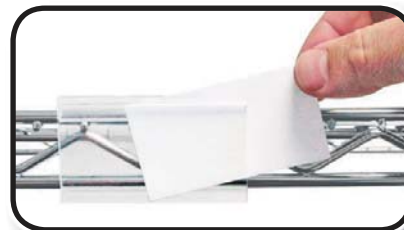

Inserts slide into label holders easily

### Hanging Basket Clear Label Holders

A super easy method for identifying product. Affixes directly to the front on any hanging basket. Available in four lengths. (Label inserts sold separately)

MODEL NO.	DESCRIPTION	SHIP WGT
<b>Clear Label Holders</b>		
HBL3C	3" Clear Label Holder	1 lb
HBL165C	16-1/2" Clear Label Holder	1 lb
HBL345C	34-1/2" Clear Label Holder	1 lb
HBL465C	46-1/2" Clear Label Holder	1 lb

### NEED A LARGER SURFACE AREA FOR IDENTIFICATION?

New generation extended clear label holder clips onto the front snake frame of any wire shelf and offers a 3"H x 5"W label slot with paper insert. Labels can be changed or easily relocated. Laser and inkjet compatible inserts come in 8-1/2" x 11" perforated sheets. Package of 12.



LHE3X5C



Clear Label Holder

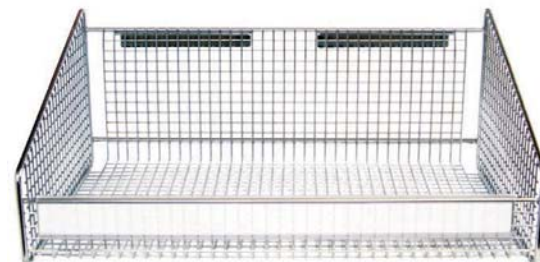

HBL165C



**PARTition Store Pull Out Basket Carts**

Pull out basket storage organize and transport your storage tools and needed parts.

**800 lb.  
MOBILE LOAD CAPACITY**

**PARTition Store Starter Unit**

Starter units come complete with 2 frames, 4 cross bars, top wire shelf, full extension slides, bottom dust cover and four 4"H poly casters, 2 with brakes. Load capacity of 800 lb.



**PS-TS22184**  
Top Shelf

**PS-SSE**  
Slanted Slide Extension - Pair

**PS-WB22143**  
3" Wire Basket on 4" Slant

**PS-WB22145**  
5" Wire Basket

**EACH BASKET AND SHELF CAN SUPPORT 60 lbs.**  
*(One tray extended at a time)*

**PS-LH3**  
Hanging Label Tag

**PS-FR68**  
Frame

**PS-SE**  
Slide Extension - Pair

**PS-WB22148**  
8" Wire Basket

**PS-DC2214**  
Bottom Dust Cover

**PS-M0B**  
4" Caster with Brake  
800 lb. load capacity

**PS-S2475-8WB**

24" D

19-1/2" W

75" H



**PS-S2475-8WB**  
Starter Unit with Wire Baskets

- 24"D x 19-1/2"W x 75"H
- 1 - 3" wire basket with 2 long and 2 short-dividers
- 6 - 5" wire baskets with 2 long and 2 short-dividers
- 1 - 8" wire basket with 2 long and 2 short-dividers
- 1 - safety stop
- 1 - bottom dust cover
- 25 - PS-LH3 clear hanging label tags

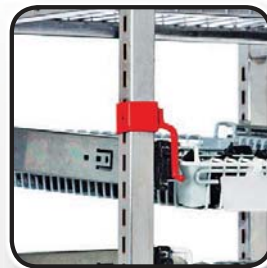

**PS-RSS**  
Red Safety Stop  
Used to secure wire baskets from sliding out when used on slanted slide.



**PS-LH3**  
Hanging Label Tag  
Fits 1-3/8"H x 3"W adhesive label. Package of 25. (Sold separately)

- Available in:
- Clear
  - Red
  - Yellow
  - Blue
  - Green
  - Orange
  - Pink
  - Purple



### PARTition Store Starter Unit

Starter units come complete with 2 frames, 4 cross bars, top wire shelf, full extension slides, bottom dust cover and four 4"H poly casters, 2 with brakes. Load capacity of 800 lb.



**PS-S2475-7S**  
Starter Unit with Wire Shelves  
24"D x 19-1/2"W x 75"H  
7 - wire shelves on slides  
1 - bottom dust cover  
25 - PS-LH3 clear hanging label tags

### PARTition Store Single Bay Carts

- Ideal for transport of your needed parts or tools
- All-welded 1" square tubular epoxy-coated steel frame
- Sturdy base with solid shelf
- Heavy-duty 1,200 lb. capacity



**PS-SBC58-6WB**  
Single Bay Cart with Wire Baskets  
29-1/2"D x 25"W x 58-1/2"H  
1 - 3" wire basket with 2 long and 2 short dividers  
4 - 5" wire baskets with 2 long and 2 short dividers  
1 - 8" wire basket with 2 long and 2 short dividers  
25 - PS-LH3 clear hanging label tags

### HEAVY-DUTY PULL OUT BASKET AND SHELF TRANSPORT CARTS



**PS-SBC58-6S**  
Single Bay Cart with Wire Shelves  
29-1/2"D x 25"W x 58-1/2"H  
6 - wire shelves  
25 - PS-LH3 clear hanging label tags

**EACH BASKET AND SHELF CAN SUPPORT 60 lbs.**

*(One tray extended at a time)*

**1,200 lb. MOBILE LOAD CAPACITY FOR BAY CARTS**

### PARTition Store Add-On Unit

Add-on units come complete with 1 frame, 4 cross bars, top wire shelf, full extension slides, bottom dust cover and two 4"H casters, 1 with brake.

#### EXPAND YOUR STARTER UNIT



**PS-A2475-8WB**  
Add-on with Wire Baskets



**PS-A2475-7S**  
Add-on with Wire Shelves

#### FULL CAPACITY COMPARTMENTS



**PS-WB22148**  
Wire Basket  
See pg. 126 for additional sizes



**PS-WS2414**  
Wire Shelves  
Available in White or Chrome Finish



**PARTITION Store Double Bay Carts**

**1,200 lb.  
MOBILE LOAD CAPACITY  
FOR BAY CARTS**

- Ideal for transport of your needed parts or tools
- All-welded 1-1/2" square tubular epoxy-coated steel frame
- Sturdy base with solid shelf insert
- 5" quiet poly swivel casters
- Standard donut bumpers on corners which protect walls and provide cushion impact
- Accessories include dividers and label holders
- Custom configurations are available, call for details



**PS-DBC-7WB7S**  
Double Bay Cart with Wire Baskets and Shelves  
29-1/2"D x 44"W x 74-1/2"H  
7 - 5" wire baskets with 2 long and 2 short dividers  
7 - wire shelves on slides  
50 - PS-LH3 clear hanging label tags

Also available:  
**PS-DBC-14WB**  
Double Bay Cart with Wire Baskets  
29-1/2"D x 44"W x 74-1/2"H  
14 - 5" wire baskets with 2 long and 2 short dividers  
50 - PS-LH3 clear hanging label tags

**PS-DBC-14S**  
Double Bay Cart with Wire Shelves  
29-1/2"D x 44"W x 74-1/2"H  
14 - wire shelves on slides  
50 - PS-LH3 clear hanging label tags

**EACH BASKET AND  
SHELF CAN SUPPORT  
60 lbs.**  
*(One tray extended at a time)*

**DOUBLE BAY  
HEAVY-DUTY  
PULL OUT BASKET  
TRANSPORT CARTS**

**Accessories**

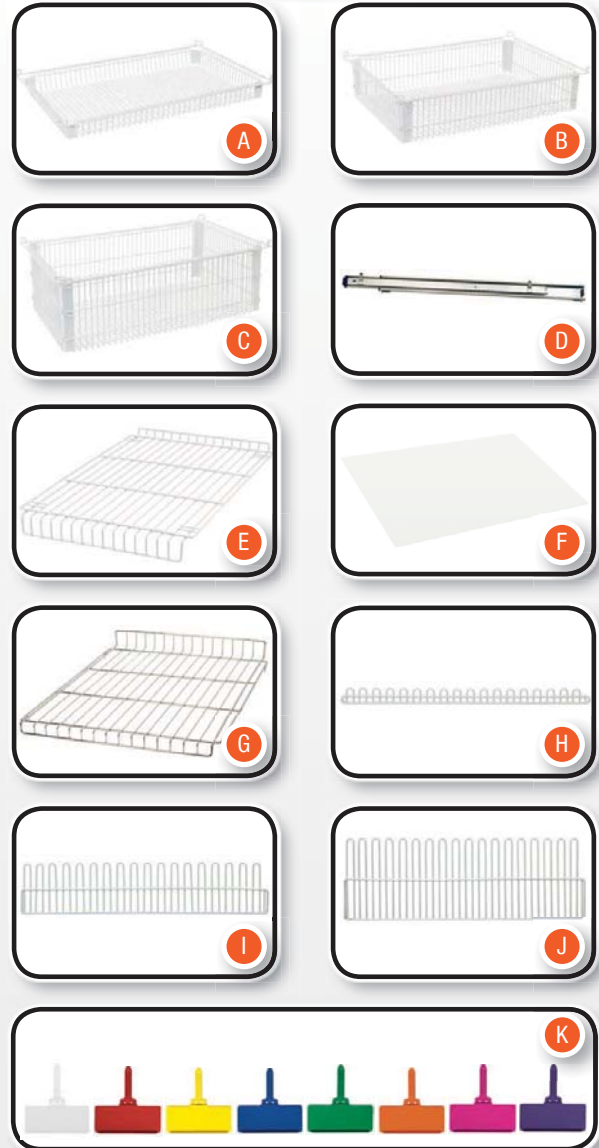

- (A) PS-WB22143**  
3" Wire Basket  
22" x 14" x 3"
- (B) PS-WB22145**  
5" Wire Basket  
22" x 14" x 5"
- (C) PS-WB22148**  
8" Wire Basket  
22" x 14" x 8"
- (D) PS-SE**  
Slide Extension - Pair  
**PS-SSE**  
Slant Slide Extension - Pair
- (E) PS-WS2414**  
Flat Shelf available in:  
- White  
- Chrome
- (F) PS-DC2214**  
Bottom Dust Cover  
22" x 14"
- (G) PS-TS22184C**  
Chrome Top Shelf
- (H) PS-WBLD-3**  
3" Basket Long Divider  
**PS-WBSD-3**  
3" Basket Short Divider
- (I) PS-WBLD-5**  
5" Basket Long Divider  
**PS-WBSD-5**  
5" Basket Short Divider
- (J) PS-WBLD-8**  
8" Basket Long Divider  
**PS-WBSD-8**  
8" Basket Short Divider
- (K) PS-LH3**  
Hanging Label Tag  
1-3/8" x 3" Available in:  
- Clear - Red - Yellow  
- Blue - Green - Orange  
- Pink - Purple



1836DS

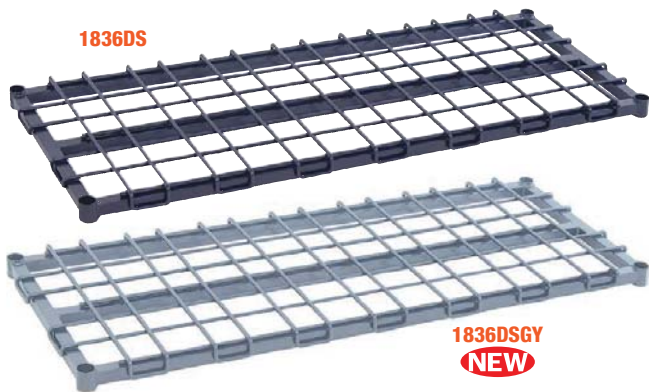

1836DSGY  
NEW

NEW  
FINISH

ENDURANCE MODEL NO.	GRAY NEW MODEL NO.	DIMENSIONS W" x L"	SHIP WGT
1836DS	1836DSGY	18" x 36"	21 lbs
1848DS	1848DSGY	18" x 48"	28 lbs
1860DS	1860DSGY	18" x 60"	34 lbs
2436DS	2436DSGY	24" x 36"	24 lbs
2448DS	2448DSGY	24" x 48"	30 lbs
2460DS	2460DSGY	24" x 60"	37 lbs

1,300-1,600 lb.  
LOAD CAPACITY PER SHELF

Dunnage Shelves

NSF

Dunnage shelves are constructed of 1" square tubular steel with removable wire decking. Utilized in extreme load applications. 1,300-1,600 lb. load capacity depending of shelf length. **Finishes:** Blue Endurance or Gray Epoxy - Excellent for high humidity or corrosive applications and is fortified with an antimicrobial agent.

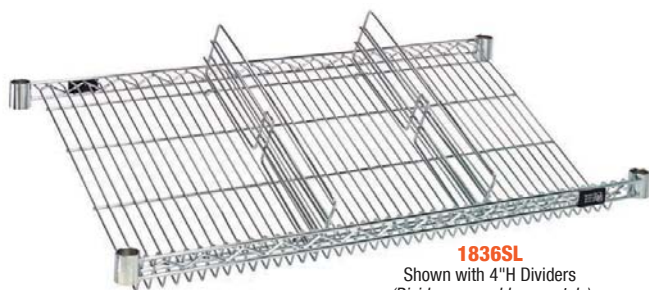

1836SL  
Shown with 4"H Dividers  
(Dividers are sold separately)

Slanted Shelves

NSF

Designed with a 25° slant to add structure to various applications and retain products. Perfect angle for gravity flow as well as bin storage. **Finish:** Chrome

TUBULAR FRAME



1836FGY  
NEW

NEW  
FINISH

GRAY NEW MODEL NO.	DIMENSIONS W" x L"	SHIP WGT
1836FGY	18" x 36"	7 lbs
1848FGY	18" x 48"	8 lbs
1860FGY	18" x 60"	9 lbs
2436FGY	24" x 36"	8 lbs
2448FGY	24" x 48"	9 lbs
2460FGY	24" x 60"	10 lbs

Tubular 3 Sided Frames

NSF

Constructed of 1" square tubing, frame is designed for added structure to the perimeter of a dunnage or shelving unit. **Finish:** Gray Epoxy

SNAKE FRAMES



1836FC  
NEW

1836FS

1836FP  
NEW

NEW  
FINISHES

CHROME MODEL NO. NEW	STAINLESS MODEL NO.	PROFORM MODEL NO. NEW	DIMENSIONS W" x L"	SHIP WGT
1836FC	1836FS	1836FP	18" x 36"	6 lbs
1848FC	1848FS	1848FP	18" x 48"	7 lbs
1860FC	1860FS	1860FP	18" x 60"	8 lbs
2436FC	2436FS	2436FP	24" x 36"	8 lbs
2448FC	2448FS	2448FP	24" x 48"	9 lbs
2460FC	2460FS	2460FP	24" x 60"	10 lbs

Wire 3 Sided Snake Frames

NSF

Designed to add structure to various applications and retain products. **Finishes:** Chrome, 304 Stainless Steel and Proform Green Epoxy

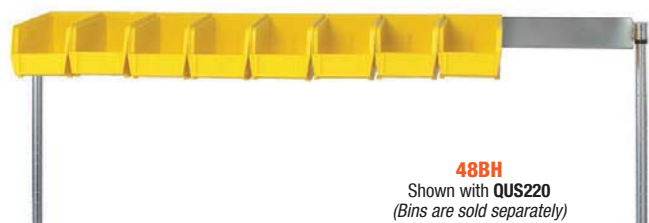

48BH  
Shown with QUS220  
(Bins are sold separately)

Bin Rail Holders

NSF

Creates a more functional work area with the bin rail which allows you to adapt bins to your shelving unit. Bin rail holder adjusts on 1" increments.

**Finish:** Chrome

MODEL NO.	DESCRIPTION	SHIP WGT
36BH	One 36" Bin Holder	5 lbs
48BH	One 48" Bin Holder	7 lbs
60BH	One 60" Bin Holder	9 lbs

MODEL NO.	QUS 210	QUS 220	QUS 221	QUS 224	QUS 230
<b>Quantity of Ultra Bins to Fit Bin Rail Holders</b>					
36BH	8	8	5	8	6
48BH	11	11	7	11	8
60BH	14	14	9	14	10

See pg. 5 for bin dimensions



Mobile Dunnage Platform Racks



Units can be used for moving case goods and other heavy items for cleaning, warehouse and stock room applications. Non-marking casters add flexibility. **Finish:** Gray Epoxy

Each unit consists of:

- 4 - 6" posts
- 1 - 3 sided frame
- 1 - dunnage shelf
- 4 - 5" swivel thermoplastic resin casters, 2 with brakes
- 4 - donut bumpers

**1,200 lb.**  
MOBILE LOAD CAPACITY



GRAY <b>NEW</b> MODEL NO.	DIMENSIONS W" x L" x H"	SHIP WGT
M18366DGY	18" x 36" x 12"	36 lbs
M18486DGY	18" x 48" x 12"	44 lbs
M18606DGY	18" x 60" x 12"	51 lbs
M24366DGY	24" x 36" x 12"	40 lbs
M24486DGY	24" x 48" x 12"	47 lbs
M24606DGY	24" x 60" x 12"	55 lbs

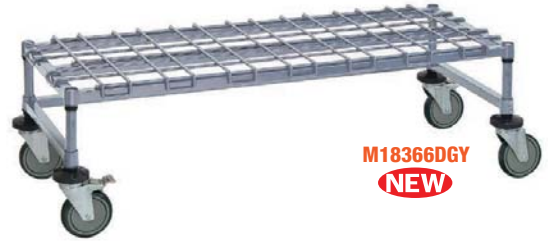

M18366DGY  
**NEW**

Modular Dunnage Racks



Ideal for extreme load capacities (1,300-1,600 lb.). Includes tubular 1" square frame super structure and removable wire top mat. **Finish:** Gray Epoxy

Each unit consists of:

- 4 - 14" posts
- 1 - 3 sided frame
- 1 - dunnage shelf

**1,300-1,600 lb.**  
LOAD CAPACITY



GRAY <b>NEW</b> MODEL NO.	DIMENSIONS W" x L" x H"	SHIP WGT
183614DGY	18" x 36" x 14"	28 lbs
184814DGY	18" x 48" x 14"	36 lbs
186014DGY	18" x 60" x 14"	43 lbs
243614DGY	24" x 36" x 14"	32 lbs
244814DGY	24" x 48" x 14"	39 lbs
246014DGY	24" x 60" x 14"	47 lbs



183614DGY  
**NEW**

Tank & Beverage Container Racks



Represents a cost effective way to keep containers off the floor for cleanliness. This unit is an effective way to tidy up and increase available storage capacity. Used frequently in cafeterias and warehouse applications. **Finish:** Gray Epoxy

Each 1 Tier unit consists of:

- 4 - 34" posts
- 1 - 3 sided frame
- 1 - dunnage shelf

**1,300-1,600 lb.**  
LOAD CAPACITY

Each 2 Tier unit consists of:

- 4 - 54" posts
- 2 - 3 sided frames
- 2 - dunnage shelves

**2,600-3,200 lb.**  
LOAD CAPACITY



GRAY <b>NEW</b> MODEL NO.	DIMENSIONS W" x L" x H"	SHIP WGT
<b>1 Tier</b>		
183634DGY	18" x 36" x 34"	40 lbs
184834DGY	18" x 48" x 34"	48 lbs
186034DGY	18" x 60" x 34"	55 lbs
243634DGY	24" x 36" x 34"	44 lbs
244834DGY	24" x 48" x 34"	51 lbs
246034DGY	24" x 60" x 34"	59 lbs
<b>2 Tier</b>		
183654DGY	18" x 36" x 54"	68 lbs
184854DGY	18" x 48" x 54"	84 lbs
186054DGY	18" x 60" x 54"	98 lbs
243654DGY	24" x 36" x 54"	76 lbs
244854DGY	24" x 48" x 54"	90 lbs
246054DGY	24" x 60" x 54"	106 lbs



183654DGY  
**NEW**

Shelf Platform Racks



Represents an ergonomic solution for keeping case goods off the floor. Platforms are often used at workstations and prep storage areas. **Finish:** Chrome

Each unit consists of:

- 4 - 14" posts
- 1 - shelf

**600-800 lb.**  
LOAD CAPACITY PER SHELF

CHROME MODEL NO.	DIMENSIONS W" x L" x H"	SHIP WGT
183614PC	18" x 36" x 14"	14 lbs
184814PC	18" x 48" x 14"	18 lbs
186014PC	18" x 60" x 14"	21 lbs
243614PC	24" x 36" x 14"	17 lbs
244814PC	24" x 48" x 14"	20 lbs
246014PC	24" x 60" x 14"	25 lbs

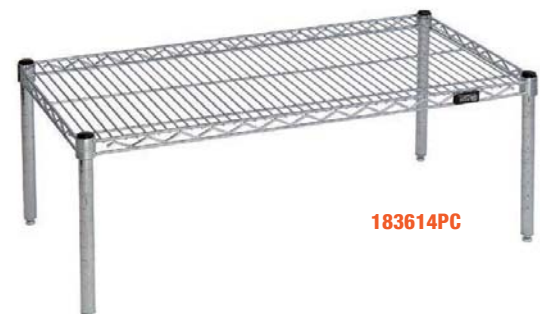

183614PC





662412DPP



662412DPS

MODEL NO.	DIMENSIONS W" x L" x H"	LOAD CAPACITY	SHIP WGT
<b>Ventilated Top</b>			
362412DPP	24" x 36" x 12"	500 lbs	13 lbs
363612DPP	36" x 36" x 12"	750 lbs	22 lbs
482412DPP	24" x 48" x 12"	700 lbs	19 lbs
662412DPP	24" x 66" x 12"	1,000 lbs	23 lbs
663612DPP	36" x 66" x 12"	1,500 lbs	37 lbs
962412DPP	24" x 96" x 12"	1,400 lbs	34 lbs
963612DPP	36" x 96" x 12"	2,000 lbs	53 lbs
<b>Solid Top</b>			
362412DPS	24" x 36" x 12"	700 lbs	17 lbs
363612DPS	36" x 36" x 12"	1,000 lbs	26 lbs
482412DPS	24" x 48" x 12"	900 lbs	21 lbs
662412DPS	24" x 66" x 12"	1,400 lbs	28 lbs
663612DPS	36" x 66" x 12"	1,900 lbs	49 lbs
962412DPS	24" x 96" x 12"	1,800 lbs	41 lbs
963612DPS	36" x 96" x 12"	2,700 lbs	64 lbs

Polymer Dunnage Racks



Our Dunnage Racks are as portable as they are versatile. Made from lightweight, heavy-duty high density polyethylene, these are the perfect match for wet or chemically intense manufacturing environments. A simple snap together design makes it a breeze to raise finished goods and raw materials off the ground and away from moisture, dirt and traffic. When it comes to cleanup time, just sweep underneath! We offer the largest commercially available sizes in a high-capacity, low-cost dunnage solution that lets you reset and move workstations as often as you see fit. Plus, the grid-top design simplifies working with fluids and bagged goods because any spilled items will flow through the surface to the floor below.



Expandable EZ Lock Platform Rack & Pallet



Quantum's EZ Lock platform and pallet allows you to customize your storage space in seconds. Its patented interlocking design allows true flexibility in building the exact size pallet or platform you need. Using 12" x 40" footprints, each unit locks together making this an all-purpose storage, moving, and shipping solution. Manufactured of recycled high density polyethylene, the vented deck is freezer safe and chemical resistant. Its one piece body design and structure allows for a 4 way forklift and hand truck entry, and it meets GMA industry standards. Enhances any 5S Lean initiative. Withstands temperatures from -30°F – 200°F and offers a 2,500 lb. load capacity when connected. Once built, the structure will maintain its dimensions with no sagging or stretching. Plastic will not absorb any liquids or chemicals and is resistant to insect infestation. Perfect for use in hospitals, pharmacies, clean rooms, food and beverage areas, manufacturing environments, and supermarket and grocery store back rooms.

EASILY STORE SUPPLIES AND MATERIALS OFF THE GROUND

Available in: ●Black

MODEL NO.	DIMENSIONS W" x L" x H"	CTN QTY	SHIP WGT
EL-12406	12" x 40" x 6"	1 Pair (2 Pieces)	14 lbs



LOCKING SYSTEMS

Simple locking system allows for quick and trouble-free assembly



QUICK AND TROUBLE-FREE ASSEMBLY  
2,500 LB. LOAD CAPACITY

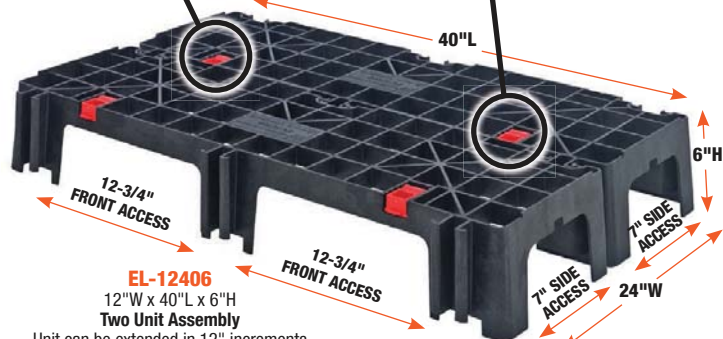

EL-12406

12" W x 40" L x 6" H

Two Unit Assembly

Unit can be extended in 12" increments to organize, ship, move or store items (Sold in pairs, 2 pieces)



STACKABLE FOR EASY STORAGE

**Work Station Carts - The ideal work-in-process cart**

The sloped shelves allow for high visibility, productive rotations and gravity feed. **Cart Finish:** Chrome

Each unit consists of:

- 2 - 34" longer back posts
- 2 - 29" shorter front posts
- 1 - flat wire shelf
- 1 - slanted wire shelf
- 4 - 5" swivel thermoplastic resin casters, 2 with brakes
- 4 - donut bumpers



**M1836SL34C**  
Shown with Bins  
(Bins are sold separately)

MOBILE MODEL NO.	SHELF DIMENSIONS W" x L"	NO. OF SHELVES	SHIP WGT
<b>40"H - Work Station Carts</b>			
M1836SL34C	18" x 36"	2	38 lbs
M1848SL34C	18" x 48"	2	48 lbs
M2436SL34C	24" x 36"	2	44 lbs
M2448SL34C	24" x 48"	2	50 lbs



**MWRS-5-92060**



**WRSL6-74-1848-260**

NO. OF BINS	BIN DIMENSIONS L" x W" x H"	NO. OF SHELVES	STATIONARY		MOBILE	
			MODEL NO.	SHIP WGT	MODEL NO.	SHIP WGT
<b>18"W x 36"L x 63"H - Wire Shelving System with 2 Flat Shelves and 3 Slanted Shelves</b> Includes Dividable Grid Containers Available in Blue, Gray, Red and Clear						
12	DG92035 16-1/2" x 10-7/8" x 3-1/2"	5	WRS-5-92035	89 lbs	MWRS-5-92035	100 lbs
12	DG92060 16-1/2" x 10-7/8" x 6"	5	WRS-5-92060	96 lbs	MWRS-5-92060	107 lbs
12	DG92080 16-1/2" x 10-7/8" x 8"	5	WRS-5-92080	107 lbs	MWRS-5-92080	118 lbs
<b>18"W x 36"L x 74"H - Wire Shelving System with 2 Flat Shelves and 5 Slanted Shelves</b> Includes Economy Shelf Bins Available in Blue, Green, Ivory, Red, Yellow, Black and Clear						
48	QSB103 17-7/8" x 4-1/8" x 4"	7	WRS-7-103	118 lbs	MWRS-7-103	129 lbs
30	QSB104 17-7/8" x 6-5/8" x 4"	7	WRS-7-104	110 lbs	MWRS-7-104	121 lbs
24	QSB108 17-7/8" x 8-3/8" x 4"	7	WRS-7-108	113 lbs	MWRS-7-108	124 lbs
18	QSB110 17-7/8" x 11-1/8" x 4"	7	WRS-7-110	111 lbs	MWRS-7-110	122 lbs
<b>18"W x 36"L x 74"H - Wire Shelving System with 2 Flat Shelves and 5 Slanted Shelves</b> Includes Euro Drawers Available in Blue, Red, Yellow and Gray						
48	QED604 17-5/8" x 3-3/4" x 4-5/8"	7	WRS-7-604	144 lbs	MWRS-7-604	155 lbs
30	QED602 17-5/8" x 5-9/16" x 4-5/8"	7	WRS-7-602	126 lbs	MWRS-7-602	137 lbs
18	QED606 17-5/8" x 8-3/8" x 4-5/8"	7	WRS-7-606	132 lbs	MWRS-7-606	143 lbs
<b>18"W x 48"L x 74"H - Wire Shelving System with 2 Flat Shelves and 4 Slanted Shelves</b> Includes Ultra Bins Available in Blue, Green, Ivory, Red, Yellow, Black and Clear						
16	QUS260 18" x 11" x 10"	6	WRSL6-74-1848-260	168 lbs	WRCSL6-74-1848-260	179 lbs
<b>24"W x 48"L x 74"H - Wire Shelving System with 2 Flat Shelves and 4 Slanted Shelves</b> Includes Hulk 24" Containers Available in Blue, Red, Yellow and Clear						
16	QUS953 23-7/8" x 11" x 10"	6	WRSL6-74-2448-953	184 lbs	WRCSL6-74-2448-953	195 lbs

**Slanted Shelf Carts - Stationary and Mobile**

Stationary and Mobile Slanted Shelf units create a unique combination of modular components to enhance supply distribution applications. The sloped shelves allow for high visibility, productive rotations and gravity feed. **(Note: Build a system with your bin requirements or consult a product specialist for appropriate components)**

Each unit consists of:

- 4 - 63" posts
- 2 - flat wire shelves
- 3 - slanted wire shelves

Each mobile unit consists of:

- 4 - 63" posts
- 2 - flat wire shelves
- 3 - slanted wire shelves
- 4 - 5" swivel thermoplastic resin casters, 2 with brakes
- 4 - donut bumpers

**63"H - SLANTED SHELF CARTS**

SHELF DIMENSIONS W" x L"	NO. OF SHELVES	STATIONARY		MOBILE	
		MODEL NO.	SHIP WGT	MODEL NO.	SHIP WGT
18" x 36"	5	1836SL6C	66 lbs	M1836SL6C	76 lbs
18" x 48"	5	1848SL6C	86 lbs	M1848SL6C	96 lbs
24" x 36"	5	2436SL6C	81 lbs	M2436SL6C	91 lbs
24" x 48"	5	2448SL6C	96 lbs	M2448SL6C	106 lbs

**COMPLETE PACKAGES WITH BINS**



**MWRS-7-104**

**1,200 lb. MOBILE LOAD CAPACITY**



### Slanted Shelf with Bin Holders Combo Carts

A systems cart that offers hanging bins, slanted bins and bins on a flat surface all in one unit. Carts offer the ability to store pre-packed items or sloped storage for dispensing small parts. This combination creates a highly customized exchange and storage system. **Cart Finish:** Chrome

Bins available in: ● Blue ● Green ● Ivory ● Red ● Yellow   
 ● Black ● Clear (One color per unit)

MODEL NO.	NO. OF SHELVES	NO. OF BINS	BIN DIMENSIONS L" x W" x H"	SHIP WGT
<b>18"W x 36"L x 80"H - Slanted Wire Shelf Cart with Bin Holders and Bins</b>				
WRCSL5-74-1836-104220	5	20 QSB104	17-7/8" x 6-5/8" x 4"	105 lbs
		24 QUS220	7-3/8" x 4-1/8" x 3"	
WRCSL5-74-1836-104230	5	20 QSB104	17-7/8" x 6-5/8" x 4"	112 lbs
		18 QUS230	10-7/8" x 5-1/2" x 5"	
<b>18"W x 48"L x 80"H - Slanted Wire Shelf Cart with Bin Holders and Bins</b>				
WRCSL5-74-1848-104220	5	24 QSB104	17-7/8" x 6-5/8" x 4"	128 lbs
		30 QUS220	7-3/8" x 4-1/8" x 3"	

### Slanted Shelf Carts - Open or Enclosed

Units are designed for quick and easy accessibility for pre-packed items. The wire end panel maintains product while the slanted shelf allows for gravity feed. Available with or without side enclosures. **Cart Finish:** Chrome

OPEN		ENCLOSED	
MODEL NO.	SHIP WGT	MODEL NO.	SHIP WGT
<b>5 Shelf - Slanted Cart 2 Flat Shelves and 3 Slanted Shelves</b>			
WRCSL5-63-1836	76 lbs	WRCSL5-63-1836EP	88 lbs
WRCSL5-63-1848	96 lbs	WRCSL5-63-1848EP	108 lbs
WRCSL5-63-2436	91 lbs	WRCSL5-63-2436EP	105 lbs
WRCSL5-63-2448	106 lbs	WRCSL5-63-2448EP	120 lbs

## COMPLETE PACKAGES WITH BINS



WRCSL5-74-1836-104230



WRCSL5-63-1836EP

## QUANTUM HAS A NEW ANGLE FOR STORAGE



WRCSL5-63-1836-104

## 1,200 lb. MOBILE LOAD CAPACITY

Dividers, Bin Cups and Clear Label Holders  
See pg. 48

Bins available in: ● Blue ● Green ● Ivory ● Red ● Yellow ● Black ● Clear (One color per unit)

		OPEN		ENCLOSED	
NO. OF BINS	BIN DIMENSIONS L" x W" x H"	MODEL NO.	SHIP WGT	MODEL NO.	SHIP WGT
<b>5 Shelf - Slanted Shelf Cart with Bins 2 Flat Shelves and 3 Slanted Shelves</b>					
20 QSB104	17-7/8" x 6-5/8" x 4"	WRCSL5-63-1836-104	94 lbs	WRCSL5-63-1836EP-104	103 lbs
28 QSB104	17-7/8" x 6-5/8" x 4"	WRCSL5-63-1848-104	114 lbs	WRCSL5-63-1848EP-104	123 lbs
20 QSB106	23-5/8" x 6-5/8" x 4"	WRCSL5-63-2436-106	115 lbs	WRCSL5-63-2436EP-106	131 lbs
28 QSB106	23-5/8" x 6-5/8" x 4"	WRCSL5-63-2448-106	136 lbs	WRCSL5-63-2448EP-106	152 lbs

Bin Cart Systems

Bin carts can be used for transporting and holding product. A modular drawer system allows for storage of smaller specialty components while the open shelf design maximizes the storage area. The option of cart covers *pg. 136*, enclosure panels *pg. 146*, ledges and dividers *pg. 147* add to the flexibility of the unit. **Cart Finish:** Chrome

Bins available in: ● Blue ● Red ● Gray ● Clear (One color per unit)

MODEL NO.	NO. OF BINS	BIN DIMENSIONS L" x W" x H"	SHIP WGT
<b>24"W x 36"L x 69"H - Bin Cart with Dividable Grids</b>			
WRC5-63-2436-93060	4 DG93060	22-1/2" x 17-1/2" x 6"	113 lbs
<b>24"W x 48"L x 69"H - Bin Cart with Dividable Grids</b>			
WRC5-63-2448-93060	4 DG93060	22-1/2" x 17-1/2" x 6"	128 lbs
<b>24"W x 60"L x 69"H - Bin Cart with Dividable Grids</b>			
WRC5-63-2460-93060	4 DG93060	22-1/2" x 17-1/2" x 6"	153 lbs

COMPLETE PACKAGES WITH BINS



WRC5-63-2436-93060

- Each unit consists of:
- 4 - 63" posts
  - 5 - wire shelves
  - 4 - DS18-24 bin slides
  - 4 - 5" swivel thermoplastic resin casters, 2 with brake
  - 4 - donut bumpers
  - 4 - DG93060 bins (Blue, Red, Gray or Clear)



1,200 lb. MOBILE LOAD CAPACITY

ALL MOBILE UNITS INCLUDE FOUR 5" x 1-1/4" SWIVEL CASTERS, 2 WITH BRAKES



DIVIDERS

Containers can be divided by length and/or width allowing a subdivision down to a 1-1/8" square compartment size. See *pg. 65*



CLEAR ACRYLIC INLAYS

Keep stored items visible while protecting against airborne dust and other contaminants. Cover lays inside on rim of container. See *pg. 65*

Bin Carts

Offering two heights and four bin quantity designs, these modular carts are the ultimate work-in-process and transport carts. Dividable grids slide easily in and out and with their ability to be divided into multiple compartments with long and short dividers, truly any type of storage is possible, see *pg. 65* for dividers and label holders. **Cart Finish:** Chrome

Bins available in: ● Blue ● Red ● Gray ● Clear (One color per unit)

MODEL NO.	NO. OF BINS	BIN DIMENSIONS L" x W" x H"	SHIP WGT
<b>21"W x 24"L x 45"H - Bin Cart with Dividable Grid Containers</b>			
BC212434M1	4 DG93060	22-1/2" x 17-1/2" x 6"	58 lbs
BC212439M2	7 DG93030	22-1/2" x 17-1/2" x 3"	79 lbs
<b>21"W x 24"L x 69"H - Bin Cart with Dividable Grid Containers</b>			
BC212469M1	7 DG93060	22-1/2" x 17-1/2" x 6"	107 lbs
BC212469M2	11 DG93030	22-1/2" x 17-1/2" x 3"	111 lbs
<b>21"W x 24"L x 45"H - Bin Cart with No Dividable Grid Containers</b>			
BC212439M4	No Containers (includes slides for 4 bin levels)		46 lbs
BC212439M7	No Containers (includes slides for 7 bin levels)		55 lbs
<b>21"W x 24"L x 69"H - Bin Cart with No Dividable Grid Containers</b>			
BC212469M	No Containers (includes slides for 7 bin levels)		63 lbs
BC212469M11	No Containers (includes slides for 11 bin levels)		75 lbs
WR-S24W	-	One Pair - 24" Wire Bin Slides	3 lbs



BC212434M1



BC212469M1

CLEAR BINS  
AVAILABLE VIEW

BC214069M1D

## Double &amp; Triple Bay Bin Carts

Offering double or triple bays and four bin quantity designs, these modular carts are the ultimate work-in-process and transport carts. Dividable grids slide easily in and out and with their ability to be divided into multiple compartments with long and short dividers, truly any type of storage is possible, see **pg. 65** for dividers and label holders. Bins can be covered by using our clear acrylic inlays, see below. **Cart Finish:** Chrome

1,200 lb.  
MOBILE LOAD  
CAPACITY

## Double Bay Bin Carts

Bins available in: ● Blue ● Red ● Gray ● Clear (One color per unit)

MODEL NO.	NO. OF BINS	BIN DIMENSIONS L" x W" x H"	SHIP WGT
<b>24"W x 40"L x 69"H - Bin Cart with Dividable Grid Containers</b>			
BC214069M1D	14 DG93060	22-1/2" x 17-1/2" x 6"	163 lbs
BC214069M2D	22 DG93030	22-1/2" x 17-1/2" x 3"	164 lbs
<b>24"W x 40"L x 69"H - Bin Cart with No Dividable Grid Containers</b>			
BC214069M14D	No Containers (includes slides for 14 bin levels)		75 lbs
BC214069M22D	No Containers (includes slides for 22 bin levels)		91 lbs
<b>One Pair - 24" Wire Single Bin Slides</b>			
WR-S24W	-	-	3 lbs
<b>One - 24" Wire Double Bin Slide</b>			
WR-D24W	-	-	2 lbs

COMPLETE PACKAGES  
WITH BINS

## DIVIDERS

Containers can be divided by length and/or width allowing a subdivision down to a 1-1/8" square compartment size.  
See **pg. 65**



## CLEAR ACRYLIC INLAYS

Keep stored items visible while protecting against airborne dust and other contaminants. Cover lays inside on rim of container.  
See **pg. 65**

1,200 lb.  
MOBILE LOAD  
CAPACITY

## Triple Bay Bin Carts

Bins available in: ● Blue ● Red ● Gray ● Clear (One color per unit)

MODEL NO.	NO. OF BINS	BIN DIMENSIONS L" x W" x H"	SHIP WGT
<b>24"W x 60"L x 69"H - Bin Cart with Dividable Grid Containers</b>			
BC216069M1T	21 DG93060	22-1/2" x 17-1/2" x 6"	233 lbs
BC216069M2T	33 DG93030	22-1/2" x 17-1/2" x 3"	234 lbs
<b>24"W x 60"L x 69"H - Bin Cart with No Dividable Grid Containers</b>			
BC216069M21T	No Containers (includes slides for 21 bin levels)		100 lbs
BC216069M33T	No Containers (includes slides for 33 bin levels)		124 lbs
<b>One Pair - 24" Wire Single Bin Slides</b>			
WR-S24W	-	-	3 lbs
<b>One - 24" Wire Double Bin Slide</b>			
WR-D24W	-	-	2 lbs



BC216069M2T

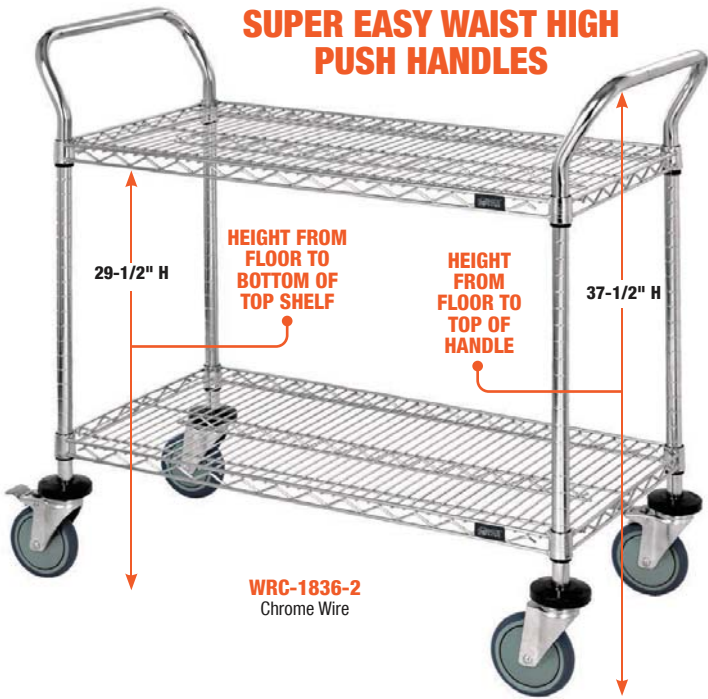

**Cylinder Transport/  
Inhalation Therapy Cart**

Mobile unit can transport up to 12 of the D and/or E cylinders. Protective vinyl coated wires separate and protect cylinders. Unit consists of two u-handles, 4 donut bumpers, 4 conductive swivel casters (2 with brakes), 1 wire shelf and 2 frames with coated wire grid shelf.

**Wire Finish:** Chrome



MODEL NO.	SHIP WGT
Mobile Cylinder Cart 18"W x 24"L x 37-1/2"H WRC-IT1824	45 lbs

**1,200 lb.**  
**MOBILE LOAD CAPACITY**



**UTILITY CARTS**  
**IN ANY STYLE, FINISH, OR CONFIGURATION**

**Wire Utility Carts**

Give versatility to any operation: food service, hospitals and maintenance. Carts consists of 2 u-handles, 4 donut bumpers, 4 swivel casters (2 with brakes) and wire or solid shelf combinations.

DIMENSIONS W" x L" x H"	WIRE SHELF					SHIP WGT	WIRE & SOLID SHELF			SOLID SHELF		
	CHROME MODEL NO.	STAINLESS MODEL NO.	PROFORM GREEN EPOXY MODEL NO.	GRAY EPOXY MODEL NO.	BLACK EPOXY MODEL NO.		CHROME MODEL NO.	STAINLESS MODEL NO.	SHIP WGT	GALVANIZED MODEL NO.	STAINLESS MODEL NO.	SHIP WGT
	<b>2 Wire Shelf Mobile Utility Cart</b>						<b>1 Wire and 1 Solid Shelf Mobile Utility Cart</b>			<b>2 Solid Shelf Mobile Utility Cart</b>		
18" x 36" x 37-1/2"	WRC-1836-2	WRSC-1836-2	WRC-1836P-2	WRC-1836GY-2	WRC-1836BK-2	30 lbs	WRC-1836-2CG	WRSC-1836SS-2S	37 lbs	WRC-1836-2G	WRSC-1836-2SS	44 lbs
18" x 42" x 37-1/2"	WRC-1842-2	WRSC-1842-2	WRC-1842P-2	WRC-1842GY-2	WRC-1842BK-2	32 lbs	WRC-1842-2CG	WRSC-1842SS-2S	41 lbs	WRC-1842-2G	WRSC-1842-2SS	50 lbs
18" x 48" x 37-1/2"	WRC-1848-2	WRSC-1848-2	WRC-1848P-2	WRC-1848GY-2	WRC-1848BK-2	37 lbs	WRC-1848-2CG	WRSC-1848SS-2S	45 lbs	WRC-1848-2G	WRSC-1848-2SS	56 lbs
24" x 36" x 37-1/2"	WRC-2436-2	WRSC-2436-2	WRC-2436P-2	WRC-2436GY-2	WRC-2436BK-2	36 lbs	WRC-2436-2CG	WRSC-2436SS-2S	42 lbs	WRC-2436-2G	WRSC-2436-2SS	48 lbs
24" x 42" x 37-1/2"	WRC-2442-2	WRSC-2442-2	WRC-2442P-2	WRC-2442GY-2	WRC-2442BK-2	40 lbs	WRC-2442-2CG	WRSC-2442SS-2S	47 lbs	WRC-2442-2G	WRSC-2442-2SS	54 lbs
24" x 48" x 37-1/2"	WRC-2448-2	WRSC-2448-2	WRC-2448P-2	WRC-2448GY-2	WRC-2448BK-2	44 lbs	WRC-2448-2CG	WRSC-2448SS-2S	52 lbs	WRC-2448-2G	WRSC-2448-2SS	60 lbs
	<b>3 Wire Shelf Mobile Utility Cart</b>						<b>2 Wire and 1 Solid Shelf Mobile Utility Cart</b>			<b>3 Solid Shelf Mobile Utility Cart</b>		
18" x 36" x 37-1/2"	WRC-1836-3	WRSC-1836-3	WRC-1836P-3	WRC-1836GY-3	WRC-1836BK-3	37 lbs	WRC-1836-3CG	WRSC-1836SS-3S	46 lbs	WRC-1836-3G	WRSC-1836-3SS	60 lbs
18" x 42" x 37-1/2"	WRC-1842-3	WRSC-1842-3	WRC-1842P-3	WRC-1842GY-3	WRC-1842BK-3	42 lbs	WRC-1842-3CG	WRSC-1842SS-3S	49 lbs	WRC-1842-3G	WRSC-1842-3SS	68 lbs
18" x 48" x 37-1/2"	WRC-1848-3	WRSC-1848-3	WRC-1848P-3	WRC-1848GY-3	WRC-1848BK-3	48 lbs	WRC-1848-3CG	WRSC-1848SS-3S	52 lbs	WRC-1848-3G	WRSC-1848-3SS	76 lbs
24" x 36" x 37-1/2"	WRC-2436-3	WRSC-2436-3	WRC-2436P-3	WRC-2436GY-3	WRC-2436BK-3	49 lbs	WRC-2436-3CG	WRSC-2436SS-3S	55 lbs	WRC-2436-3G	WRSC-2436-3SS	67 lbs
24" x 42" x 37-1/2"	WRC-2442-3	WRSC-2442-3	WRC-2442P-3	WRC-2442GY-3	WRC-2442BK-3	55 lbs	WRC-2442-3CG	WRSC-2442SS-3S	62 lbs	WRC-2442-3G	WRSC-2442-3SS	76 lbs
24" x 48" x 37-1/2"	WRC-2448-3	WRSC-2448-3	WRC-2448P-3	WRC-2448GY-3	WRC-2448BK-3	60 lbs	WRC-2448-3CG	WRSC-2448SS-3S	68 lbs	WRC-2448-3G	WRSC-2448-3SS	84 lbs



Modular Trays



Heavy-duty 18" x 26" white trays are NSF approved and can be used in any application. Perimeter ends are reinforced for additional strength. 20" x 26" size offers a deep stacking tray. Both tray sizes are available in ESD material complying to ANSI/ESD standards for the use in PC board assembly and handling. All trays are manufactured from fiberglass reinforced thermoset material, allowing up to 200 lb. weight capacity when evenly distributed. Quantum's modular trays will withstand temperatures of -40°F to +350°F. 18" x 26" Trays available in White and ESD, 20" x 26" Trays are available in Gray, White and ESD.

Available in: ● Gray ○ White ● Black (ESD)

MODEL NO.	DIMENSIONS W" x L" x H"	SHIP WGT
<b>18" x 26" - Trays</b>		
1826TR	18" x 26" x 1-1/8" White Tray	4 lbs
1826ESD	18" x 26" x 1-1/8" Black ESD Tray	4 lbs
<b>20" x 26" - Stackable Trays</b>		
2026TRGY	20" x 26" x 1-1/2" Gray Tray	5 lbs
2026TRWT	20" x 26" x 1-1/2" White Tray	5 lbs
2026ESD	20" x 26" x 1-1/2" Black ESD Tray	5 lbs



Tray Slides



Efficiently utilize space between shelves using standard trays and/or bins.

- Available in 18" and 24" depths, overall height 23"
- Accommodates up to 10 trays

MODEL NO.	DESCRIPTION	SHIP WGT
<b>Tray Slide</b>		
TS18C	18" Tray Slide Set	10 lbs
TS24C	24" Tray Slide Set	11 lbs



Modular Tray Carts

200 lb. LOAD CAPACITY PER TRAY

Tray Carts are offered in half size and full size units, designed to handle work in process. ESD trays can be used on tray cart for conductive applications with the addition of conductive plastic split sleeves (WR-SSCO) and a drag chain (ESD-DC). Optional Tray Stop prevents trays from falling out. **Cart Finish:** Chrome

MODEL NO.	DIMENSIONS W" x L" x H"	SHIP NO. OF TRAY WGT TRAYS	TRAY STOP MODEL NO.
<b>39"H - Side Load Tray Cart</b>			
TC-19	18" x 30" x 39"	45 lbs 19	1826ESD 1826TR TS32C
<b>69"H - Side Load Tray Carts</b>			
TC-39	18" x 30" x 69"	74 lbs 39	1826ESD 1826TR TS62C
TC-31	21" x 30" x 69"	68 lbs 31	2026ESD 2026TR TS62C
<b>69"H - End Load Tray Cart</b>			
TC-EL38	21-3/4" x 27" x 69"	74 lbs 38	1826ESD 1826TR TS62C

Trays are sold separately



TC-19 + 1826TR (Trays sold separately)



TC-EL38 + 1826TR End Load Cart (Trays sold separately)



TC-39 + 1826ESD Side Load Cart

Tray Stops can be used on back as shown here or one in the back and one in the front. (Trays sold separately)



WR-00CO Conductive Casters 4 swivel - 2 brakes - 2 non-brakes



ESD-DC Drag Chain



WR-SSCO Plastic Conductive Split Sleeve

Conductive Options

Cart Covers

Protect against pilferage, airborne dust, water, and other contaminants. Velcro and zipper flap are available in clear-vinyl and blue and white denier nylon fabric. Clear vinyl is 10 gauge. Blue and white nylon fabric is 400 Denier. Specify zipper or velcro for closure.

CART COVERS OPTIONS AVAILABLE

- Custom sizes
- Hand openings
- Handle holes/slots
- Bottom tie tapes (attach to posts)
- Extra velcro strips
- Double flap
- Clear front flap
- Metal grommets
- 9" x 12" pocket/document holder
- Custom logos

TO ORDER:

1. Choose size
2. Select color:  
 Clear Vinyl add suffix CV  
 Blue Nylon add suffix BN  
 White Nylon add suffix WN
3. Choose Zipper or Velcro



CLEAR VINYL

COVERS PROTECT AGAINST PILFERAGE, AIRBORNE DUST, MOISTURE AND OTHER CONTAMINANTS

CUSTOM SIZES AND ADDITIONAL COLORS ALONG WITH ESD/CONDUCTIVE MATERIAL AVAILABLE

call for details



BLUE NYLON



WHITE NYLON

63"H - CART COVER				74"H - CART COVER			
DIMENSIONS W" x L" x H"	SHIP WGT	400 DENIER MODEL NO.	CLEAR VINYL MODEL NO.	DIMENSIONS W" x L" x H"	SHIP WGT	400 DENIER MODEL NO.	CLEAR VINYL MODEL NO.
18" x 36" x 63"	3 lbs	CC183663	CC183663CV	18" x 36" x 74"	4 lbs	CC183674	CC183674CV
18" x 48" x 63"	4 lbs	CC184863	CC184863CV	18" x 48" x 74"	5 lbs	CC184874	CC184874CV
18" x 60" x 63"	5 lbs	CC186063	CC186063CV	18" x 60" x 74"	6 lbs	CC186074	CC186074CV
18" x 72" x 63"	6 lbs	CC187263	CC187263CV	18" x 72" x 74"	7 lbs	CC187274	CC187274CV
24" x 36" x 63"	3 lbs	CC243663	CC243663CV	24" x 36" x 74"	4 lbs	CC243674	CC243674CV
24" x 48" x 63"	4 lbs	CC244863	CC244863CV	24" x 48" x 74"	5 lbs	CC244874	CC244874CV
24" x 60" x 63"	5 lbs	CC246063	CC246063CV	24" x 60" x 74"	6 lbs	CC246074	CC246074CV
24" x 72" x 63"	6 lbs	CC247263	CC247263CV	24" x 72" x 74"	7 lbs	CC247274	CC247274CV





## Stem Caster Carts

## 4 or 5 Wire Shelf Mobile Carts

Mobile wire stem caster carts add versatility and flexibility to any operation, creating a transport system.

- Supply and distribution
- Stock rotation
- Laundry
- Staging

Each unit consists of:

- 4 - posts
- 4 or 5 - wire shelves
- 4 - donut bumpers
- 4 - 5" thermoplastic resin casters, 2 with brakes

## 3 or 4 Wire/1 Solid Shelf Mobile Carts

Stem caster cart with solid bottom shelf. The unique combination of wire and solid shelves allows for air circulation and high visibility. The solid shelf in the bottom position prevents dust and dirt to rise and contains spillage.

Each unit consists of:

- 4 - posts
- 3 or 4 - wire shelves
- 1 - solid shelf
- 4 - donut bumpers
- 4 - 5" thermoplastic resin casters, 2 with brakes

## 1,200 lb. MOBILE LOAD CAPACITY

## 4 or 5 Solid Shelf Mobile Carts

Stem caster solid shelf cart is an easy way to transport tools and inventories.

Each unit consists of:

- 4 - posts
- 4 or 5 - solid shelves
- 4 - donut bumpers
- 4 - 5" thermoplastic resin casters, 2 with brakes



M1836C46

## CHROME WIRE SHELVES

DIMENSIONS W" x L" x H"	4 SHELF CARTS		5 SHELF CARTS	
	MODEL NO.	SHIP WGT	MODEL NO.	SHIP WGT
<b>63"H - Post, 5" Stem Caster Carts</b>				
18" x 36" x 69"	M1836C46	68 lbs	M1836C46-5	72 lbs
18" x 48" x 69"	M1848C46	76 lbs	M1848C46-5	84 lbs
18" x 60" x 69"	M1860C46	97 lbs	M1860C46-5	107 lbs
24" x 36" x 69"	M2436C46	80 lbs	M2436C46-5	87 lbs
24" x 48" x 69"	M2448C46	94 lbs	M2448C46-5	102 lbs
24" x 60" x 69"	M2460C46	116 lbs	M2460C46-5	127 lbs
<b>74"H - Post, 5" Stem Caster Carts</b>				
18" x 36" x 80"	M1836C47	70 lbs	M1836C47-5	74 lbs
18" x 48" x 80"	M1848C47	78 lbs	M1848C47-5	86 lbs
18" x 60" x 80"	M1860C47	99 lbs	M1860C47-5	109 lbs
24" x 36" x 80"	M2436C47	82 lbs	M2436C47-5	89 lbs
24" x 48" x 80"	M2448C47	96 lbs	M2448C47-5	104 lbs
24" x 60" x 80"	M2460C47	118 lbs	M2460C47-5	129 lbs



M1836CG46-5

## CHROME WIRE AND 18 GAUGE SOLID GALVANIZED STEEL SHELVES

DIMENSIONS W" x L" x H"	4 SHELF CARTS		5 SHELF CARTS	
	MODEL NO.	SHIP WGT	MODEL NO.	SHIP WGT
<b>63"H - Post, 5" Stem Caster Carts</b>				
18" x 36" x 69"	M1836CG46	68 lbs	M1836CG46-5	78 lbs
18" x 48" x 69"	M1848CG46	76 lbs	M1848CG46-5	90 lbs
18" x 60" x 69"	M1860CG46	97 lbs	M1860CG46-5	114 lbs
24" x 36" x 69"	M2436CG46	80 lbs	M2436CG46-5	93 lbs
24" x 48" x 69"	M2448CG46	94 lbs	M2448CG46-5	110 lbs
24" x 60" x 69"	M2460CG46	116 lbs	M2460CG46-5	137 lbs
<b>74"H - Post, 5" Stem Caster Carts</b>				
18" x 36" x 80"	M1836CG47	70 lbs	M1836CG47-5	80 lbs
18" x 48" x 80"	M1848CG47	78 lbs	M1848CG47-5	92 lbs
18" x 60" x 80"	M1860CG47	99 lbs	M1860CG47-5	116 lbs
24" x 36" x 80"	M2436CG47	82 lbs	M2436CG47-5	95 lbs
24" x 48" x 80"	M2448CG47	96 lbs	M2448CG47-5	112 lbs
24" x 60" x 80"	M2460CG47	118 lbs	M2460CG47-5	139 lbs



M1836SG46

## 18 GAUGE SOLID GALVANIZED STEEL

DIMENSIONS W" x L" x H"	4 SHELF CARTS		5 SHELF CARTS	
	MODEL NO.	SHIP WGT	MODEL NO.	SHIP WGT
<b>63"H - Post, 5" Stem Caster Carts</b>				
18" x 36" x 69"	M1836SG46	86 lbs	M1836SG46-5	102 lbs
18" x 48" x 69"	M1848SG46	102 lbs	M1848SG46-5	122 lbs
18" x 60" x 69"	M1860SG46	118 lbs	M1860SG46-5	142 lbs
24" x 36" x 69"	M2436SG46	98 lbs	M2436SG46-5	117 lbs
24" x 48" x 69"	M2448SG46	102 lbs	M2448SG46-5	126 lbs
24" x 60" x 69"	M2460SG46	146 lbs	M2460SG46-5	177 lbs
<b>74"H - Post, 5" Stem Caster Carts</b>				
18" x 36" x 80"	M1836SG47	88 lbs	M1836SG47-5	104 lbs
18" x 48" x 80"	M1848SG47	104 lbs	M1848SG47-5	124 lbs
18" x 60" x 80"	M1860SG47	120 lbs	M1860SG47-5	144 lbs
24" x 36" x 80"	M2436SG47	100 lbs	M2436SG47-5	119 lbs
24" x 48" x 80"	M2448SG47	104 lbs	M2448SG47-5	128 lbs
24" x 60" x 80"	M2460SG47	148 lbs	M2460SG47-5	179 lbs

**Enclosure Carts**

Enclosure carts are an effective way to keep contents from moving or falling off during transportation.

Enclosure carts using rods and tabs are adaptable to any shelf position.

Enclosure dolly base truck using rods and tabs allows for heavier load transport. The rods and tabs act as a perimeter to retain product.

For additional shelves, refer to **pg. 98**.

All units consist of:

- 4 - posts
- 4 or 5 - wire shelves
- 4, 5 or 6 - rods and tabs kits

Mobile unit also includes:

- 4 - 5" swivel thermoplastic resin casters, 2 with brakes
- 4 - donut bumpers

Dolly Base unit also includes:

- 1 - dolly base
- 4 - plate thermoplastic resin casters (2 rigid and 2 swivel with brake)

**COMPLETE CARTS INCLUDE CASTER KIT FOR MOBILITY**

**1,200 lb. MOBILE LOAD CAPACITY**



**M1836C46RE**



**MD1836C46RE-5**

**3 SIDED, 4 OR 5 WIRE SHELF CART WITH RODS AND TABS**

DIMENSIONS W" x L" x H"	4 SHELF CARTS		5 SHELF CARTS	
	MODEL NO.	SHIP WGT	MODEL NO.	SHIP WGT
<b>63"H - Post, Cart with Rods and Tabs</b>				
18" x 36" x 69"	M1836C46RE	74 lbs	M1836C46RE-5	84 lbs
18" x 48" x 69"	M1848C46RE	84 lbs	M1848C46RE-5	98 lbs
18" x 60" x 69"	M1860C46RE	100 lbs	M1860C46RE-5	117 lbs
24" x 36" x 69"	M2436C46RE	88 lbs	M2436C46RE-5	101 lbs
24" x 48" x 69"	M2448C46RE	104 lbs	M2448C46RE-5	120 lbs
24" x 60" x 69"	M2460C46RE	124 lbs	M2460C46RE-5	145 lbs
<b>74"H - Post, Cart with Rods and Tabs</b>				
18" x 36" x 80"	M1836C47RE	80 lbs	M1836C47RE-5	90 lbs
18" x 48" x 80"	M1848C47RE	92 lbs	M1848C47RE-5	106 lbs
18" x 60" x 80"	M1860C47RE	104 lbs	M1860C47RE-5	121 lbs
24" x 36" x 80"	M2436C47RE	94 lbs	M2436C47RE-5	107 lbs
24" x 48" x 80"	M2448C47RE	112 lbs	M2448C47RE-5	128 lbs
24" x 60" x 80"	M2460C47RE	132 lbs	M2460C47RE-5	153 lbs

**CHROME WIRE SHELVES**

**DOLLY BASE 3 SIDED, 4 OR 5 WIRE SHELF CART WITH RODS AND TABS**

DIMENSIONS W" x L" x H"	4 SHELF CARTS		5 SHELF CARTS	
	MODEL NO.	SHIP WGT	MODEL NO.	SHIP WGT
<b>63"H - Post, Dolly Base Carts with Rods and Tabs</b>				
18" x 36" x 70"	MD1836C46RE	86 lbs	MD1836C46RE-5	96 lbs
18" x 48" x 70"	MD1848C46RE	96 lbs	MD1848C46RE-5	110 lbs
18" x 60" x 70"	MD1860C46RE	124 lbs	MD1860C46RE-5	141 lbs
24" x 36" x 70"	MD2436C46RE	113 lbs	MD2436C46RE-5	126 lbs
24" x 48" x 70"	MD2448C46RE	121 lbs	MD2448C46RE-5	137 lbs
24" x 60" x 70"	MD2460C46RE	144 lbs	MD2460C46RE-5	165 lbs
<b>74"H - Post, Dolly Base Carts with Rods and Tabs</b>				
18" x 36" x 81"	MD1836C47RE	92 lbs	MD1836C47RE-5	102 lbs
18" x 48" x 81"	MD1848C47RE	106 lbs	MD1848C47RE-5	120 lbs
18" x 60" x 81"	MD1860C47RE	120 lbs	MD1860C47RE-5	137 lbs
24" x 36" x 81"	MD2436C47RE	108 lbs	MD2436C47RE-5	121 lbs
24" x 48" x 81"	MD2448C47RE	129 lbs	MD2448C47RE-5	145 lbs
24" x 60" x 81"	MD2460C47RE	152 lbs	MD2460C47RE-5	173 lbs

**Rods & Tabs**

Rods and tabs represent an economical, alternate solution for enclosure on backs and sides of mobile and stationary units.

Each kit includes:

- 3 - rods
- 9 - front/back tabs
- 9 - side/solid shelf tabs.

MODEL NO.	DESCRIPTION	SHIP WGT
<b>Rods &amp; Tabs</b>		
52RT	3 - 52" Rods with Tabs	1 lb
61RT	3 - 61" Rods with Tabs	1 lb
72RT	3 - 72" Rods with Tabs	2 lbs
84RT	3 - 84" Rods with Tabs	2 lbs



**QSRT**  
Side or Solid Shelf Tab



**QAT**  
Front or Back Tab

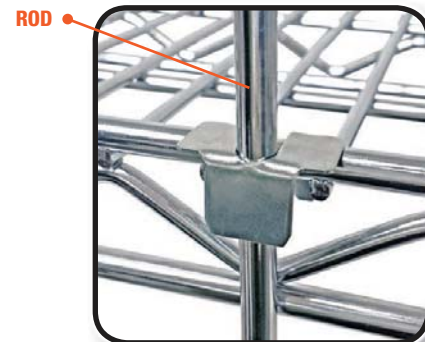



### 3 SIDED STEM CASTER WIRE SHELF CART WITH 3 OR 4 WIRE SHELVES AND 1 SOLID SHELF WITH RODS AND TABS

DIMENSIONS W" x L" x H"	4 SHELF CARTS		5 SHELF CARTS	
	MODEL NO.	SHIP WGT	MODEL NO.	SHIP WGT
<b>63"H - Post, Cart with Rods and Tabs</b>				
18" x 36" x 69"	M1836CG46RE	83 lbs	M1836CG46RE-5	93 lbs
18" x 48" x 69"	M1848CG46RE	94 lbs	M1848CG46RE-5	108 lbs
18" x 60" x 69"	M1860CG46RE	114 lbs	M1860CG46RE-5	131 lbs
24" x 36" x 69"	M2436CG46RE	96 lbs	M2436CG46RE-5	109 lbs
24" x 48" x 69"	M2448CG46RE	112 lbs	M2448CG46RE-5	128 lbs
24" x 60" x 69"	M2460CG46RE	136 lbs	M2460CG46RE-5	157 lbs
<b>74"H - Post, Cart with Rods and Tabs</b>				
18" x 36" x 80"	M1836CG47RE	89 lbs	M1836CG47RE-5	99 lbs
18" x 48" x 80"	M1848CG47RE	101 lbs	M1848CG47RE-5	115 lbs
18" x 60" x 80"	M1860CG47RE	123 lbs	M1860CG47RE-5	140 lbs
24" x 36" x 80"	M2436CG47RE	102 lbs	M2436CG47RE-5	115 lbs
24" x 48" x 80"	M2448CG47RE	119 lbs	M2448CG47RE-5	135 lbs
24" x 60" x 80"	M2460CG47RE	144 lbs	M2460CG47RE-5	166 lbs

## CHROME WIRE AND 18 GAUGE SOLID GALVANIZED STEEL SHELVES

### DOLLY BASE 3 SIDED WIRE SHELF CART WITH 3 OR 4 WIRE SHELVES AND 1 SOLID SHELF WITH RODS AND TABS

DIMENSIONS W" x L" x H"	4 SHELF CARTS		5 SHELF CARTS	
	MODEL NO.	SHIP WGT	MODEL NO.	SHIP WGT
<b>63"H - Post, Dolly Base Carts with Rods and Tabs</b>				
18" x 36" x 70"	MD1836CG46RE	93 lbs	MD1836CG46RE-5	102 lbs
18" x 48" x 70"	MD1848CG46RE	106 lbs	MD1848CG46RE-5	116 lbs
18" x 60" x 70"	MD1860CG46RE	128 lbs	MD1860CG46RE-5	147 lbs
24" x 36" x 70"	MD2436CG46RE	109 lbs	MD2436CG46RE-5	132 lbs
24" x 48" x 70"	MD2448CG46RE	127 lbs	MD2448CG46RE-5	145 lbs
24" x 60" x 70"	MD2460CG46RE	154 lbs	MD2460CG46RE-5	175 lbs
<b>74"H - Post, Dolly Base Carts with Rods and Tabs</b>				
18" x 36" x 81"	MD1836CG47RE	99 lbs	MD1836CG47RE-5	108 lbs
18" x 48" x 81"	MD1848CG47RE	113 lbs	MD1848CG47RE-5	126 lbs
18" x 60" x 81"	MD1860CG47RE	137 lbs	MD1860CG47RE-5	143 lbs
24" x 36" x 81"	MD2436CG47RE	115 lbs	MD2436CG47RE-5	127 lbs
24" x 48" x 81"	MD2448CG47RE	134 lbs	MD2448CG47RE-5	153 lbs
24" x 60" x 81"	MD2460CG47RE	163 lbs	MD2460CG47RE-5	183 lbs



M1836CG46RE



MD1836CG46RE-5

#### Enclosure Carts

Enclosure carts are an effective way to keep contents from moving or falling off during transportation.

Enclosure carts using rods and tabs are adaptable to any shelf position.

Enclosure dolly base truck using rods and tabs allows for heavier load transport. The rods and tabs act as a perimeter to retain product.

For additional shelves, refer to **pg. 98**.

All units consist of:

- 4 - posts
- 3 or 4 - wire shelves
- 1 - solid shelf
- 4, 5 or 6 - rods and tabs kits

Mobile unit also includes:

- 4 - 5" swivel thermoplastic resin casters, 2 with brakes
- 4 - donut bumpers

Dolly Base unit also includes:

- 1 - dolly base
- 4 - plate thermoplastic resin casters (2 rigid and 2 swivel with brake)

### COMPLETE CARTS INCLUDE CASTER KIT FOR MOBILITY

# 1,200 lb. MOBILE LOAD CAPACITY

### NYLON FABRIC OR CLEAR VINYL CART COVERS AVAILABLE

See **pg. 136**



WHITE NYLON



BLUE NYLON



CLEAR VINYL

#### CART COVERS

Protect against pilferage, airborne dust, moisture, and other contaminants

Enclosure Carts

Finish: Chrome

Each unit consists of:

- 4 - posts
- 4 or 5 - wire shelves
- 4 - enclosure panels
- 4 - 5" swivel thermoplastic resin casters, 2 with brakes
- 4 - donut bumpers

**NYLON FABRIC OR CLEAR VINYL CART COVERS AVAILABLE**

See pg. 136



**BLUE NYLON CART COVER**

Protect against pilferage, airborne dust, moisture and other contaminants

All units consist of:

- 4 - posts
- 3 or 4 - wire shelves
- 1 - solid shelf
- 4 or 5 - enclosure panels

Mobile unit also includes:

- 4 - 5" swivel thermoplastic resin casters, 2 with brakes
- 4 - donut bumpers

Dolly Base unit also includes:

- 1 - dolly base
- 4 - plate thermoplastic resin casters (2 rigid and 2 swivel with brake)



M2436C46E



WRCS4-63-2460EP-5



WRDBS4-63-2460EP

**CHROME WIRE SHELVES**

3 SIDED, 4 OR 5 WIRE SHELF CART WITH ENCLOSURE PANELS

DIMENSIONS W" x L" x H"	4 SHELF CARTS		5 SHELF CARTS	
	MODEL NO.	SHIP WGT	MODEL NO.	SHIP WGT
<b>63"H - Post, Cart with Enclosure Panels</b>				
24" x 36" x 69"	M2436C46E	145 lbs	M2436C46E-5	158 lbs
24" x 48" x 69"	M2448C46E	179 lbs	M2448C46E-5	195 lbs
24" x 60" x 69"	M2460C46E	197 lbs	M2460C46E-5	218 lbs

**COMPLETE CARTS INCLUDE CASTER KIT FOR MOBILITY**

**1,200 lb. MOBILE LOAD CAPACITY**

3 SIDED STEM CASTER ENCLOSURE CART WITH 3 OR 4 WIRE SHELVES AND 1 SOLID SHELF WITH ENCLOSURE PANELS

DIMENSIONS W" x L" x H"	4 SHELF CARTS		5 SHELF CARTS	
	MODEL NO.	SHIP WGT	MODEL NO.	SHIP WGT
<b>63"H - Post, Cart with Solid Bottom Shelf and Enclosure Panels</b>				
24" x 36" x 69"	WRCS4-63-2436EP	113 lbs	WRCS4-63-2436EP-5	126 lbs
24" x 48" x 69"	WRCS4-63-2448EP	131 lbs	WRCS4-63-2448EP-5	147 lbs
24" x 60" x 69"	WRCS4-63-2460EP	158 lbs	WRCS4-63-2460EP-5	179 lbs
<b>74"H - Post, Cart with Solid Bottom Shelf and Enclosure Panels</b>				
24" x 36" x 80"	WRCS4-74-2436EP	113 lbs	WRCS4-74-2436EP-5	126 lbs
24" x 48" x 80"	WRCS4-74-2448EP	131 lbs	WRCS4-74-2448EP-5	147 lbs
24" x 60" x 80"	WRCS4-74-2460EP	158 lbs	WRCS4-74-2460EP-5	179 lbs

**CHROME WIRE AND 18 GAUGE SOLID GALVANIZED STEEL SHELVES**

3 SIDED DOLLY BASE ENCLOSURE CART WITH 3 OR 4 WIRE SHELVES AND 1 SOLID SHELF WITH ENCLOSURE PANELS

DIMENSIONS W" x L" x H"	4 SHELF CARTS		5 SHELF CARTS	
	MODEL NO.	SHIP WGT	MODEL NO.	SHIP WGT
<b>63"H - Post, Dolly Base Cart with Solid Bottom Shelf and Enclosure Panels</b>				
24" x 36" x 70"	WRDBS4-63-2436EP	124 lbs	WRDBS4-63-2436EP-5	137 lbs
24" x 48" x 70"	WRDBS4-63-2448EP	142 lbs	WRDBS4-63-2448EP-5	158 lbs
24" x 60" x 70"	WRDBS4-63-2460EP	169 lbs	WRDBS4-63-2460EP-5	190 lbs
<b>74"H - Post, Dolly Base Cart with Solid Bottom Shelf and Enclosure Panels</b>				
24" x 36" x 81"	WRDBS4-74-2436EP	124 lbs	WRDBS4-74-2436EP-5	137 lbs
24" x 48" x 81"	WRDBS4-74-2448EP	142 lbs	WRDBS4-74-2448EP-5	158 lbs
24" x 60" x 81"	WRDBS4-74-2460EP	169 lbs	WRDBS4-74-2460EP-5	190 lbs



## Security Units

Stationary and Mobile Units prevent pilferage while allowing high visibility of contents at all times. All side and back panels are heavy gauge wire construction and are manufactured of all-welded heavy-duty 1/4" diameter wire on 2" x 2" centers. Assembly is quick and easy. **Finish:** Chrome and Proform Green Epoxy

### WANT TO SECURE YOUR EXISTING SHELVING UNITS?



Thick wire gauge ensures strong and dependable security yet easy visibility



2436-63SEC

## Security Panel Doors

Each door set has left and right panel with 4 hinge bars. Assembly is quick and easy and adapts to the appropriate shelf size, with standard post of 63" high.

CHROME	GREEN EPOXY	NEW FINISH	
MODEL NO.	MODEL NO. (NEW)	DIMENSIONS L" x H"	SHIP WGT
<b>Security Panel Door Set with Hinges</b>			
SD36C	SD36P	36" x 60"	54 lbs
SD48C	SD48P	48" x 60"	66 lbs
SD60C	SD60P	60" x 60"	78 lbs



**DOOR TOP SECURITY**  
Channel reinforced door frame with heavy-duty top hinge pin



**DOOR MIDDLE SECURITY**  
Channel reinforced door frame with middle clasp for lock (*Sold separately*)



**DOOR BOTTOM SECURITY**  
Channel reinforced door frame with heavy-duty bottom hinge pin



M2436-69SEC



MD2436-70SEC

**NYLON FABRIC OR CLEAR VINYL UNIT COVERS AVAILABLE FOR ALL SECURITY UNITS** See pg. 140

**1,200 lb.**  
**MOBILE LOAD CAPACITY**

## Stationary Security Units

Intermediate shelves can be purchased separately, see [pg. 98](#). **Finish:** Chrome and Proform Green Epoxy

Each unit consists of:

- 4 - posts
- 2 - wire shelves (for top and bottom)
- 1 - security panel set (includes back and sides)
- 1 - pair security panel doors

MODEL NO.	DIMENSIONS W" x L" x H"	SHIP WGT
<b>Stationary Security Units</b>		
2436-63SEC	24" x 36" x 63"	165 lbs
2448-63SEC	24" x 48" x 63"	192 lbs
2460-63SEC	24" x 60" x 63"	224 lbs

**ADD SUFFIX "P" TO MODEL NO. TO ORDER GREEN EPOXY FINISH**

Ex. 2436-63SECP

## Stem Caster Security Carts

Mobility adds flexibility to a unit and is beneficial in all types of operations. Intermediate shelves can be purchased separately, see [pg. 98](#). **Finish:** Chrome and Proform Green Epoxy

Each unit consists of:

- 4 - posts
- 2 - wire shelves (for top and bottom)
- 1 - security panel set (includes back and sides)
- 1 - pair security panel doors
- 4 - 5" thermoplastic resin casters, 2 with brake
- 4 - donut bumpers

MODEL NO.	DIMENSIONS W" x L" x H"	SHIP WGT
<b>Stem Caster Security Carts</b>		
M2436-69SEC	24" x 36" x 69"	173 lbs
M2448-69SEC	24" x 48" x 69"	200 lbs
M2460-69SEC	24" x 60" x 69"	232 lbs

## Dolly Base Security Carts

Dollies can add stability and support in heavy-duty load applications. Intermediate shelves can be purchased separately, see [pg. 98](#). **Finish:** Chrome and Proform Green Epoxy

Each unit consists of:

- 4 - posts
- 2 - wire shelves (for top and bottom)
- 1 - security panel set (includes back and sides)
- 1 - pair security panel doors
- 1 - dolly base
- 4 - plate thermoplastic resin casters (2 rigid and 2 swivel with brake)

MODEL NO.	DIMENSIONS W" x L" x H"	SHIP WGT
<b>Dolly Base Security Carts</b>		
MD2436-70SEC	24" x 36" x 70"	186 lbs
MD2448-70SEC	24" x 48" x 70"	215 lbs
MD2460-70SEC	24" x 60" x 70"	250 lbs



**High Density Sliding Floor Track System**



High Density Sliding Track System offers a unique way to maximize and efficiently move wire shelving systems. The patented design allows for quick and easy installation. Bearings in the skate are located under each post for a load capacity of 1,500 lb. per shelving unit. The v-groove floor track allows the shelving unit to slide back and forth with ease. Layout assistance is available.

**PERFORMANCE FEATURES AND BENEFITS**

- Low shipping cost
- NSF approved
- Uses industrial bearings
- Corrosion free construction
- Easy to roll construction
- Fast installation
- Utilizes the structure of existing shelving
- Complies with ADA regulations
- 1,500 lb. load capacity per unit
- Can increase storage areas up to 150%



**SYSTEMS SLIDE BACK AND FORTH WITH EASE**

**QESTP**

**End Stop Kit**

Includes 2 ends and 1 drill bit. Serves the dual purpose of stopping a skate and is the anchor for the track. Manufactured from shock absorbing polymer. One kit is required per track.

**QVTRK**

**V-Groove Track**

Aluminum design with 304 stainless steel inserts with a gradual taper, non-tripping hazard, 7/16" max height. (Sold by the inch)

**HD18 - HD36**

**One Skate**

Aluminum with engineered plastic wheel housing and industrial 2,000 lb. bearings on each end.

**WK**

**Wing Kit**

Includes four 1/4" thick aluminum plates and hardware and allows for the joining of 2 units side by side, sharing one track.

**SK**

**Shim Kit**

48"L thick aluminum strips which can be placed underneath track to help create a level surface. (6 per kit)

MODEL NO.	DESCRIPTION	SHIP WGT
<b>Stationary Security Units</b>		
HD18	One 18" Skate	4 lbs
HD21	One 21" Skate	5 lbs
HD24	One 24" Skate	6 lbs
HD30	One 30" Skate	7 lbs
HD36	One 36" Skate	8 lbs
<b>Additional Components</b>		
QESTP	End Stop Kit	1 lb
QVTRK	V-Track (Sold per inch)	1 lb
WK	Wing Kit	2 lbs
SK*	Shim Kit	3 lbs

\*Shim kit comes with (6) 2" x 48" x 1/16" thick aluminum strips which can be placed underneath track to help create a level surface

**STEP BY STEP ORDERING INSTRUCTIONS:**

(Note: Shelves and posts to be purchased separately on pgs. 98-99)

- Step 1.** Select desired length (in inches) of track. Use QVTRK to order track. (Note: single units require two tracks and double units will require three tracks)
- Step 2.** Select corresponding skate size from the chart, which will be the same as the depth of shelving unit to be utilized. Two skates required per single unit and three skates required per double unit. (Note: post height should not exceed a 4 to 1 ratio of skate size)
- Step 3.** Purchase one End Stop Kit QESTP per track length. For each double unit being used, a Wing Kit WK is required.



SINGLE UNIT TRACK SYSTEM

(Top View)

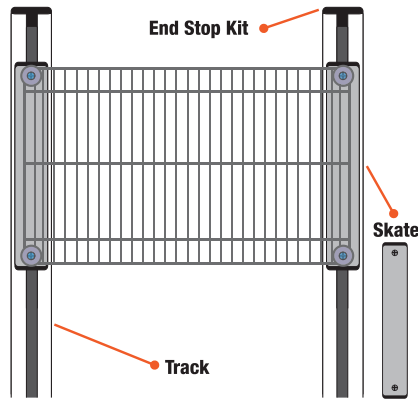

DOUBLE UNIT TRACK SYSTEM

(Top View)

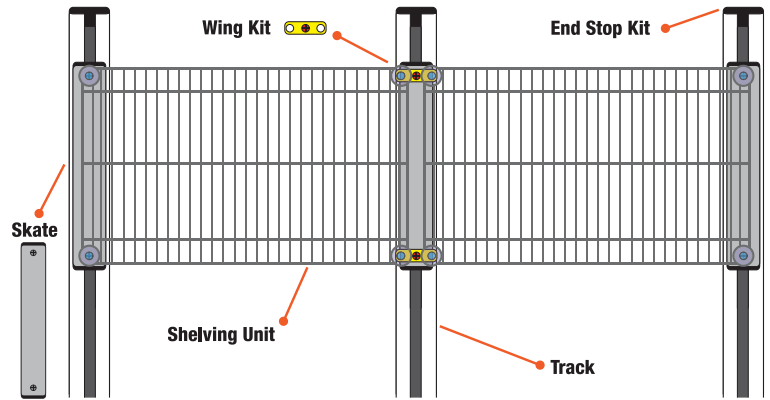

Single Unit Floor Track Assemblies



Assembly kit consists of a pair of aluminum tracks with end stop kits. Hardware and assembly instructions included. (Note: custom lengths may be purchased, see pg. 142)

Table with 4 columns: MODEL NO., TRACK L' (FT), TRACK L' (IN), SHIP WGT. Lists various single unit floor track assembly kits with their specifications.

1,500 lb. SLIDE LOAD CAPACITY PER SHELVING UNIT

STEP BY STEP ORDERING INSTRUCTIONS:

- 1. Select desired length of track and if you require: • Single Unit track (use charts on left) • Double Unit track (use charts on right)
2. Select corresponding skate size from single or double unit charts below. Skate size should match the depth of shelving unit being utilized.
3. Using the chart on the bottom of this page, determine how many shelving units will fit on your track.
4. Pre-configured 4 and 5 shelf wire units are available on pgs. 100-103. Additional intermediate shelves are available on pg. 98.

Double Unit Floor Track Assemblies



Each assembly kit consists of three aluminum tracks with end stop kits. Hardware and assembly instructions included. (Note: custom lengths may be purchased, see pg. 142)

Table with 4 columns: MODEL NO., TRACK L' (FT), TRACK L' (IN), SHIP WGT. Lists various double unit floor track assembly kits with their specifications.

Single Unit Skate Assembly Kits



Each kit includes two skates and all appropriate hardware. One kit is required for each single mobile unit. (Shelves and posts sold separately on pgs. 98 & 99)

Table with 3 columns: MODEL NO., DESCRIPTION, SHIP WGT. Lists single unit skate assembly kits.

Double Unit Skate Assembly Kits



Each kit includes three skates and all appropriate hardware. One kit is required for each double mobile unit. (Shelves and posts sold separately on pgs. 98 & 99)

Table with 3 columns: MODEL NO., DESCRIPTION, SHIP WGT. Lists double unit skate assembly kits.

QUANTITY OF SHELVING UNITS BY WIDTH TO FIT ON LENGTH OF TRACK\*

Grid table showing the quantity of shelving units that can fit on tracks of various lengths (6' to 20') and widths (18" to 36").

\*Using a minimum 36" aisle space Note: Post height should not exceed the skate length by a 4 to 1 ration (example 18" skate should not exceed a 74" post)

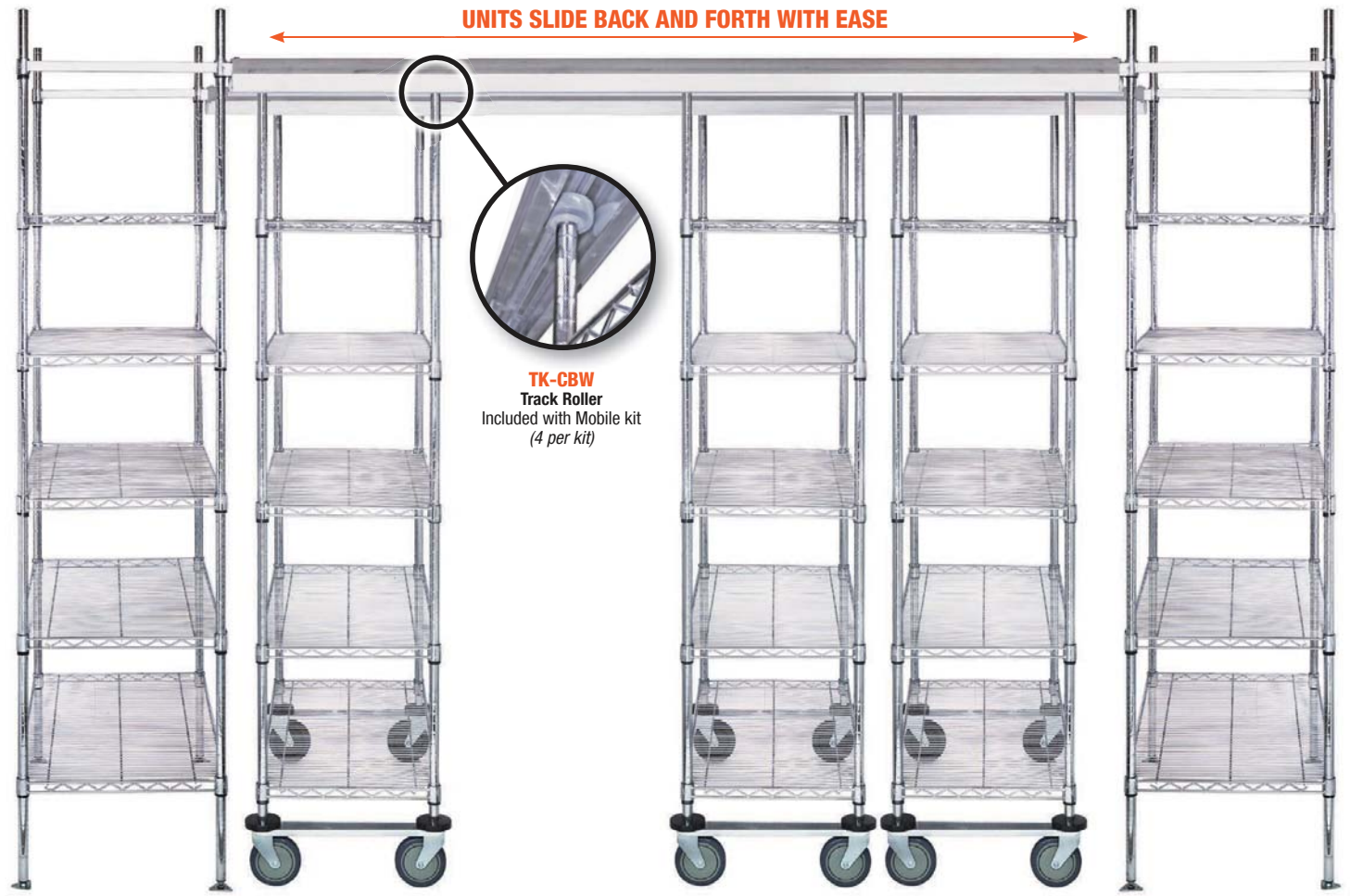

**TK-CBW**  
**Track Roller**  
 Included with Mobile kit  
 (4 per kit)

**Sliding Overhead Track System**



Quantum's Overhead Track wire shelving system provides maximum storage using a minimum of space. All kits include all necessary sections of track for assembling lengths that range from 8' to 24' (**note: shelves and posts sold separately**). Assembly is quick and easy and the whole system requires only single-aisle access. Casters are 5" x 1-1/4" rigid thermoplastic resin. Overhead Track design provides a clear walkway and clear aisles underneath eliminating any tripping hazard. Overhead Track extrusion manufactured of heavy-duty aluminum ensuring years of heavy-duty and reliable service.

MODEL NO.	DESCRIPTION	SHIP WGT
<b>Overhead Track</b>		
TK-2	One Track - 2 Feet	7 lbs
TK-26	One Track - 2-1/2 Feet	9 lbs
TK-5	One Track - 5 Feet	17 lbs
TK-6	One Track - 6 Feet	21 lbs
TK-7	One Track - 7 Feet	24 lbs
TK-EP	Track End Plates with Hardware (Set of 4)	1 lb
TK-CA	Track Connector with Hardware (Set of 4)	6 lbs
<b>End Unit Single Sided Track Bracket Pair</b>		
TK-STB18	18" Single Overhead Track Bracket Pair	4 lbs
TK-STB21	21" Single Overhead Track Bracket Pair	5 lbs
TK-STB24	24" Single Overhead Track Bracket Pair	6 lbs
<b>Intermediate Unit Double Sided Track Bracket Pair</b>		
TK-DTB18	18" Double Overhead Track Bracket Pair	4 lbs
TK-DTB21	21" Double Overhead Track Bracket Pair	5 lbs
TK-DTB24	24" Double Overhead Track Bracket Pair	6 lbs
<b>Mobile Unit Track Rollers</b>		
TK-CBW	Set of 4 Track Rollers	2 lbs

**PERFORMANCE FEATURES AND BENEFITS**

- NSF approved
- Uses industrial bearings
- Corrosion free construction
- Easy to roll construction
- Fast installation
- Utilizes the structure of existing shelving
- 1,200 lb. load capacity per unit
- Can increase storage areas up to 150%



**TK-EP**  
**Track End Plate**  
 (4 per kit)



**TRACK WITHOUT END PLATE**



**TRACK WITH END PLATE**



**INCREASE STORAGE AREAS UP TO 150%**

**SLIDING OVERHEAD TRACK SYSTEM**





**STATIONARY END KIT**  
(Shelves sold separately)



**INTERMEDIATE KIT**  
(Shelves sold separately)



**MOBILE KIT**  
(Shelves sold separately)

**STEP BY STEP ORDERING INSTRUCTIONS:**

- Step 1.** Select desired length of track.
- Step 2.** Select corresponding stationary end kit and intermediate kits from charts. Size should match the depth of shelving unit being utilized.
- Step 3.** Using the chart on the bottom of this page, determine how many Mobile Kits will fit on your track.
- Step 4.** Wire shelves are available on pg. 98.



**OVERHEAD TRACK KIT WITH END PLATES**

**Overhead Track Kits**

Each kit includes two track of the same length and end plates.

MODEL NO.	TRACK L' (FT)	TRACK L' (IN)	SHIP WGT
<b>Overhead Track Kit</b>			
TTK-8	8'	96"	53 lbs
TTK-9	9'	108"	60 lbs
TTK-10	10'	120"	67 lbs
TTK-11	11'	132"	73 lbs
TTK-12	12'	144"	80 lbs
TTK-13	13'	156"	87 lbs
TTK-14	14'	168"	93 lbs
TTK-15	15'	180"	100 lbs
TTK-16	16'	192"	107 lbs
TTK-17	17'	204"	113 lbs
TTK-18	18'	216"	120 lbs
TTK-19	19'	228"	127 lbs
TTK-20	20'	240"	133 lbs
TTK-21	21'	252"	140 lbs

**Stationary End Kits**

- Unit consists of:
- 8 - 86" Posts
- 8 - Foot plates
- 4 - Single sided overhead track support brackets



**SINGLE SUPPORT BRACKET**

MODEL NO.	DESCRIPTION	SHIP WGT
TTK-E18	18" Stationary End Kits	64 lbs
TTK-E21	21" Stationary End Kits	72 lbs
TTK-E24	24" Stationary End Kits	80 lbs

**Intermediate Kits**

- Unit consists of:
- 4 - 86" Posts
- 4 - Foot plates
- 2 - Double sided overhead track support brackets



**DOUBLE SUPPORT BRACKET**

MODEL NO.	DESCRIPTION	SHIP WGT
TTK-C18	18" Intermediate Kits	32 lbs
TTK-C21	21" Intermediate Kits	36 lbs
TTK-C24	24" Intermediate Kits	40 lbs

**Mobile Kits**

- Unit consists of:
- 4 - 74" Posts
- 4 - Rigid casters
- 2 - Track rollers
- 4 - Donut bumpers
- 2 - Tie bars



**MOBILE KITS**

MODEL NO.	DESCRIPTION	SHIP WGT
TTK-M18	18" Mobile Kit	34 lbs
TTK-M21	21" Mobile Kit	36 lbs
TTK-M24	24" Mobile Kit	38 lbs

**QUANTITY OF SHELVING UNITS BY WIDTH TO FIT ON LENGTH OF TRACK\***

	8'	9'	10'	11'	12'	13'	14'	15'	16'	17'	18'	19'	20'	21'
18"	3	3	4	4	5	6	6	7	7	8	9	9	10	10
21"	2	3	3	4	4	5	5	6	6	7	7	8	8	9
24"	2	2	3	3	4	4	5	5	6	6	6	7	7	8

\*Using a minimum 36" aisle space

**Modular Enclosure Panels**

**NEW FINISH**

Are easily adaptable to standard shelving units to create a secured storage area.

- Panels are fabricated from 6 gauge wire on 3" x 3" squares
- Modular enclosure panels work with four shelf depths: 14", 18", 21" and 24" and three heights: 63", 74" and 86"
- One modular enclosure panel is needed for each side and two or three panels are needed for the back
- New EP-CLIP hardware package allows enclosure panels to be fastened tight to the shelves to help eliminate any rattling noise while in transit. One package needed per enclosure panel.

CHROME	STAINLESS STEEL	PROFORM <b>NEW</b> GREEN EPOXY		
MODEL NO.	MODEL NO.	MODEL NO.	DESCRIPTION	SHIP WGT
EP126	EP126S	EP126P	One 12" x 62" Panel	5 lbs
EP166	EP166S	EP166P	One 16" x 62" Panel	6 lbs
EP196	EP196S	EP196P	One 19" x 62" Panel	7 lbs
EP226	EP226S	EP226P	One 22" x 62" Panel	8 lbs
EP127	EP127S	EP127P	One 12" x 73" Panel	6 lbs
EP167	EP167S	EP167P	One 16" x 73" Panel	7 lbs
EP197	EP197S	EP197P	One 19" x 73" Panel	8 lbs
EP227	EP227S	EP227P	One 22" x 73" Panel	9 lbs
EP128	EP128S	EP128P	One 12" x 84" Panel	7 lbs
EP168	EP168S	EP168P	One 16" x 84" Panel	8 lbs
EP198	EP198S	EP198P	One 19" x 84" Panel	9 lbs
EP228	EP228S	EP228P	One 22" x 84" Panel	10 lbs



**MOBILE CART SHOWN WITH 4 ENCLOSURE PANELS. MOBILE ENCLOSURE CARTS AVAILABLE**

See pgs. 138-140



HB18C

**Hang Rails**

CHROME	STAINLESS STEEL		
MODEL NO.	MODEL NO.	DESCRIPTION	SHIP WGT
HB18C	HB18S	One 18" Hang Rail	3 lbs
HB24C	HB24S	One 24" Hang Rail	4 lbs
HB36C	HB36S	One 36" Hang Rail	5 lbs
HB48C	HB48S	One 48" Hang Rail	6 lbs
HB60C	HB60S	One 60" Hang Rail	7 lbs



**Collar Hooks**

Used to secure baskets to posts or as a hook for longer items. Sold in packs of four.

MODEL NO.	DESCRIPTION	SHIP WGT
SCH1-5	1-1/2" Hook (4 Packs)	1 lb
SCH1	1/2" Hook (4 Packs)	1 lb



DB1836S

**Modular Dolly Frames**

Dolly Frames allow standard shelving units to be converted to heavy-duty transport trucks. Frames are fabricated from heavy gauge steel. Bumpers are attached to each corner to protect walls and help cushion impact. **Finishes:** Chrome and Stainless Steel (Plate casters sold separately)

CHROME	STAINLESS STEEL		
MODEL NO.	MODEL NO.	DIMENSIONS W" x L"	SHIP WGT
DB1836C	DB1836S	18" x 36"	10 lbs
DB1848C	DB1848S	18" x 48"	12 lbs
DB1860C	DB1860S	18" x 60"	14 lbs
DB2436C	DB2436S	24" x 36"	13 lbs
DB2448C	DB2448S	24" x 48"	15 lbs
DB2460C	DB2460S	24" x 60"	18 lbs



DS18-24

**CHOOSE FROM ONE BIN/TRAY DESIGN OR TWO BIN/TRAY DESIGN**

**Single and Double Drawer Slides**

Compliment any system with specialized areas for storage which allow bins and trays to be suspended between shelves. Single bin slide mounts 18", 21" and 24" shelves. Double bin slide adapts to 24" shelves only. (Bins sold separately) **Finish:** Chrome

MODEL NO.	DESCRIPTION	SHIP WGT
DS18-24	Single Bin Design	2 lbs
DDS-24	Double Bin Design	4 lbs



WCSD-1820

**Wire Carton Dividers**

**NEW**

Quantum's new wire carton dividers are the ideal storage tool to maintain and organize your boxes. Available for 18" and 24" shelf depths, the dividers fix in place and provide firm and convenient storage to your warehouse and workplace. Two convenient heights to choose from: 14" or 20-1/2". **Finish:** Chrome

MODEL NO.	DESCRIPTION	SHIP WGT
WCSD-1814	18" x 14" Divider	1 lb
WCSD-1820	18" x 20-1/2" Divider	1 lb
WCSD-2414	24" x 14" Divider	1 lb
WCSD-2420	24" x 20-1/2" Divider	1 lb



### Push Handles

Comfortable grip design. Five widths available enabling easy movement of any mobile unit. To order a Proform Green, Gray or Black Epoxy finish, add **P, GY** or **BK** right after chrome model no. prefix (i.e. **PH18P, PH18GY** or **PH18BK**). **Finishes:** Chrome, Stainless Steel, Proform Green, Gray and Black Epoxy

**NEW FINISHES**



CHROME	STAINLESS STEEL	AVAILABLE EPOXY			DESCRIPTION	SHIP WGT
MODEL NO.	MODEL NO.	NEW P	NEW GY	BK		
PH18	PH18S	Y	Y	Y	One 18" Push Handle	2 lbs
PH21	PH21S	Y	Y	N	One 21" Push Handle	3 lbs
PH24	PH24S	Y	Y	Y	One 24" Push Handle	3 lbs
PH30	-	N	N	N	One 30" Push Handle	3 lbs
PH36	PH36S	N	N	N	One 36" Push Handle	3 lbs

### U-Handles

Build your own special size utility cart with three different width choices: 18", 21" or 24". Overall height 32", not including casters. To order a Proform Green, Gray or Black Epoxy finish, add **P, GY** or **BK** right after chrome model no. prefix (i.e. **UH18P, UH18GY** or **UH18BK**). **Finishes:** Chrome, Stainless Steel, Proform Green, Gray and Black Epoxy

**NEW FINISHES**



CHROME	STAINLESS STEEL	AVAILABLE EPOXY			DESCRIPTION	SHIP WGT
MODEL NO.	MODEL NO.	NEW P	NEW GY	BK		
UH18	UH18S	Y	Y	Y	18" U-Handle	2 lbs
UH21	UH21S	Y	Y	N	21" U-Handle	3 lbs
UH24	UH24S	Y	Y	Y	24" U-Handle	3 lbs

### Shelf Inlay Mats

An economical solution to convert a wire shelf to a solid surface preventing items from falling through. White shelf inlay mat is easily removable for cleaning. Manufactured of polyethylene, .5 mm thickness.

MODEL NO.	DESCRIPTION	SHIP WGT
1836SM	One 18" x 36" Inlay Mat	1 lb
1848SM	One 18" x 48" Inlay Mat	2 lbs
1860SM	One 18" x 60" Inlay Mat	2 lbs
1872SM	One 18" x 72" Inlay Mat	2 lbs
2436SM	One 24" x 36" Inlay Mat	2 lbs
2448SM	One 24" x 48" Inlay Mat	2 lbs
2460SM	One 24" x 60" Inlay Mat	2 lbs
2472SM	One 24" x 72" Inlay Mat	3 lbs



### Tie Bars

Required with rigid casters to ensure rigid alignment. Tie bar length should match up to shelf depth. Rigid casters sold separately. **Finish:** Chrome

MODEL NO.	DESCRIPTION	SHIP WGT
18TB	One 18" Tie Bar which Fits 2 Casters	2 lbs
21TB	One 21" Tie Bar which Fits 2 Casters	2 lbs
24TB	One 24" Tie Bar which Fits 2 Casters	2 lbs
30TB	One 30" Tie Bar which Fits 2 Casters	2 lbs
36TB	One 36" Tie Bar which Fits 2 Casters	3 lbs



### Side and Back Ledges

Ledges are 4"H and act as a perimeter to retain shelf items and prevent anything from falling off. To order a Proform Green, Gray or Black Epoxy finish, add **P, GY** or **BK** right after chrome model no. prefix (i.e. **SL12P, SL12GY** or **SL12BK**). **Finishes:** Chrome, Stainless Steel, Proform Green, Gray and Black Epoxy

CHROME	STAINLESS STEEL	AVAILABLE EPOXY			DESCRIPTION	SHIP WGT
MODEL NO.	MODEL NO.	NEW P	NEW GY	BK		
<b>4"H - Side Ledges</b>						
SL12	SL12S	Y	Y	Y	12" Side Ledge	1 lb
SL14	SL14S	Y	Y	Y	14" Side Ledge	1 lb
SL18	SL18S	Y	Y	Y	18" Side Ledge	1 lb
SL21	SL21S	Y	Y	Y	21" Side Ledge	2 lbs
SL24	SL24S	Y	Y	Y	24" Side Ledge	2 lbs
SL30	SL30S	Y	Y	Y	30" Side/Back Ledge	2 lbs
<b>4"H - Back Ledges</b>						
BL36	BL36S	Y	Y	Y	36" Back/Side Ledge	3 lbs
BL42	BL42S	Y	Y	Y	42" Back Ledge	3 lbs
BL48	BL48S	Y	Y	Y	48" Back Ledge	3 lbs
BL54	BL54S	Y	Y	Y	54" Back Ledge	4 lbs
BL60	BL60S	Y	Y	Y	60" Back Ledge	5 lbs
BL72	BL72S	Y	Y	Y	72" Back Ledge	6 lbs

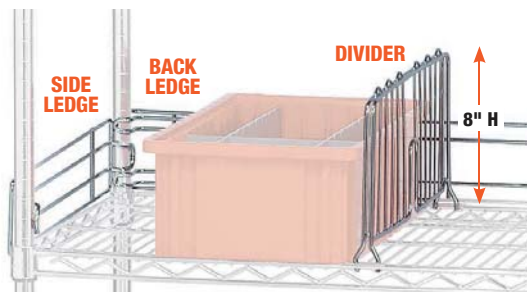

**NEW FINISHES**

### Dividers

Dividers are 8"H and are available in 7 depths to be used with all shelves. To order a Proform Green, Gray or Black Epoxy finish, add **P, GY** or **BK** right after chrome model no. prefix (i.e. **DIV12P, DIV12GY** or **DIV12BK**). **Finishes:** Chrome, Stainless Steel, Proform Green, Gray and Black Epoxy

CHROME	STAINLESS STEEL	AVAILABLE EPOXY			DESCRIPTION	SHIP WGT
MODEL NO.	MODEL NO.	NEW P	NEW GY	BK		
<b>Dividers</b>						
DIV12	DIV12S	Y	Y	Y	One 12" Divider	2 lbs
DIV14	DIV14S	Y	Y	Y	One 14" Divider	2 lbs
DIV18	DIV18S	Y	Y	Y	One 18" Divider	2 lbs
DIV21	DIV21S	Y	Y	Y	One 21" Divider	3 lbs
DIV24	DIV24S	Y	Y	Y	One 24" Divider	3 lbs
DIV30	DIV30S	Y	Y	Y	One 30" Divider	4 lbs
DIV36	DIV36S	Y	Y	Y	One 36" Divider	4 lbs

### Post Clamps

Joins multiple units of shelving. **Finish:** Chrome

MODEL NO.	DESCRIPTION	SHIP WGT
PCL1	1/2" Post Clamp	4 lbs
PCL2	3-1/3" Post Clamp	5 lbs





**Hang Bars**

- Holds 75 lb. weight capacity evenly distributed

Finish: Chrome

MODEL NO.	DESCRIPTION	SHIP WGT
<b>Intermediate</b>		
GR24	One 24" Hang Bar	2 lbs
<b>Full Length</b>		
GR36	One 36" Hang Bar	3 lbs
GR48	One 48" Hang Bar	4 lbs
GR60	One 60" Hang Bar	5 lbs



GR24



GR36, GR48, GR60

**Conductive Accessories**



**ESD-SS**  
**Aluminum Split Sleeve**  
 Aluminum Split Sleeves required when grounding standard wire shelving in conductive applications. Sold as a pack of 4 pairs.



**WR-SSCO**  
**Plastic Conductive Split Sleeve**  
 Sold as a pack of 4 pairs.



**ESD-DC**  
**Drag Chain**  
 Drag chain is mounted to bottom of shelf and is used to ground standard wire shelving units. Recommended to be used in conjunction with aluminum or plastic conductive split sleeves and conductive casters.



**S-Hooks**

**NEW FINISH**

For continuous runs of shelving. Two hooks should be used per shelf where two posts are not utilized. Sold as an 8 pack. **Finishes:** Chrome, Stainless Steel, Proform Green, Gray and Black Epoxy



- S-HOOK**  
Chrome
- S-HOOKSS**  
Stainless Steel
- S-HOOKP**  
Proform Green Epoxy
- NEW S-HOOKGY**  
Gray Epoxy
- S-HOOKBK**  
Black Epoxy



**UB10**  
**Utility Basket**  
 An additional storage or display area outside the perimeter of the shelf. Measures 18-7/8"W x 11-1/4"D x 7-5/8"H  
 Finish: Chrome



**DH8**  
**Document Holder**  
 Provides an effective way to secure documents or folders. Measures 12-3/8"W x 2"D x 8-5/8"H  
 Finish: Chrome

**Seismic Foot Plates**

**NEW**

Quantum's seismic foot plates are used to anchor stationary shelving units to the floor.

MODEL NO.	DESCRIPTION	SHIP WGT
WR-SFP <b>NEW</b>	Single Seismic Foot Plate	3 lbs
WR-DFP <b>NEW</b>	Double Seismic Foot Plate	4 lbs



**OSHPD**  
**Certification**

Single and Double Foot Plates  
 Shown with Posts and 2 Cotter Pins per plate upright



**KEYBD**  
**Keyboard Shelf**  
 Mounts under any size wire shelf and accepts keyboards up to 21"W x 11"D. Has a 6" height adjustment. Measures 25-1/4"W x 15"D x 4-1/4"H  
 Finish: Chrome



**WR-WMB**  
**Post Wall Mount Bracket**  
 Mounts post to wall securely. 2" clearance required.  
 Finish: Chrome



**FG**  
**Non-Marring Floor Glides**  
 Affixes to bottom of bolt. Serves as protection to prevent marring of floors. Sold as a 4 pack.



**WR-SS**  
**Split Sleeve**  
 Sold as a pack of 4 pairs.



**WR-SP**  
**Shelf Collar Plug**  
 Sold as a pack of 4 pieces.  
 Finish: Chrome



**FP**  
**Foot Plate**  
 Triangular plate allows additional surface to disperse weight.  
 Finish: Chrome



ADD YOUR CASTER KIT TO YOUR UNIT FOR MOBILITY

1,200-3,200 lb. MOBILE LOAD CAPACITY

Donut Bumper



Non-marking, 3" diameter plastic bumper used to protect walls and help cushion impact.

MODEL NO.	DESCRIPTION	SHIP WGT
DB	One 3" Diameter Donut Bumper	1 lb

Casters

MODEL NO.	DESCRIPTION	LOAD CAPACITY PER CASTER	SHIP WGT
<b>Stem Casters</b>			
WR-00H	Four Swivel 5" x 1-1/4" Thermoplastic Resin Casters, 2 with brake	300 lbs	10 lbs
WR-00HS	Four Swivel 5" x 1-1/4" Thermoplastic Resin Stainless Steel Casters with Zerk Grease Fittings, 2 with brake	300 lbs	12 lbs
WR-00CO	Four Swivel ESD/Conductive 5" x 1-1/4" Casters, 2 with brake	300 lbs	12 lbs
WR-SB2R2*	Two Swivel 5" x 1-1/4" Thermoplastic Resin Caster with brake, 2 Rigid	300 lbs	12 lbs
WR-3	Four Swivel 3" Polyurethane Casters, all with brake	200 lbs	8 lbs
WR-RG*	One Rigid 5" x 1-1/4" Thermoplastic Resin Caster	300 lbs	3 lbs
WR-PS	One Swivel 8" x 2-1/2" Pneumatic Caster	325 lbs	4 lbs
<b>Plate Casters</b>			
PT-PS	One Swivel 5" x 1-1/4" Thermoplastic Resin Caster	300 lbs	3 lbs
PT-PR	One Rigid 5" x 1-1/4" Thermoplastic Resin Caster	300 lbs	3 lbs
PT-PSB	One Swivel 5" x 1-1/4" Thermoplastic Resin Caster with brake	300 lbs	3 lbs
PT-PS-S	One Swivel 5" x 1-1/4" Polyurethane Stainless Steel Caster with Zerk Grease Fittings	300 lbs	3 lbs
PT-PR-S	One Rigid 5" x 1-1/4" Polyurethane Stainless Steel Caster with Zerk Grease Fittings	300 lbs	3 lbs
PT-PSB-S	One Swivel 5" x 1-1/4" Polyurethane Stainless Steel Caster with brake with Zerk Grease Fittings	300 lbs	3 lbs
PT-PS6	One Swivel 6" x 2" Polyurethane Caster	800 lbs	5 lbs
PT-PR6	One Rigid 6" x 2" Polyurethane Caster	800 lbs	5 lbs
PT-PSB6	One Swivel 6" x 2" Polyurethane Caster with brake	800 lbs	5 lbs
PT-NS	One Swivel 8" x 2-1/2" Pneumatic Caster	325 lbs	4 lbs
PT-NR	One Rigid 8" x 2-1/2" Pneumatic Caster	325 lbs	4 lbs

\*Requires Tie Bars for rigid alignment (See pg. 147)



WR-00H  
Shown with and without brake  
Sold as a set of 4 casters, 2 with brake



WR-00CO  
Shown with and without brake  
Sold as a set of 4 casters, 2 with brake



WR-00HS  
Shown with and without brake  
Sold as a set of 4 casters, 2 with brake



PT-PR



PT-PS



PT-PSB



PT-PR6



PT-PS6



PT-PSB6



WR-3  
Sold as a set of 4 casters, all with brake



WR-PS



PT-NR



PT-NS



WR-RG  
Requires Tie Bar  
(See chart pg. 147)



**Hamper**

Single bag hamper offers foot activated metal heavy-duty lid for quick accessibility. Double ring bag holder allows for quick bag insertion and bag lock. Supports 36-42 gallon multi-purpose bags with a ring to keep bag in place. Four 3" casters (2 with brake) allows for easy mobility. **Finish:** Chrome

MODEL NO.	DIMENSIONS W" x L" x H"	SHIP WGT
<b>18-M-HAMP</b>	20" x 18" x 38"	21 lbs



**36-42 GAL. CAPACITY**

HEAVY-DUTY METAL LID

DOUBLE RING BAG HOLDER

STORAGE POUCH FOR ADDITIONAL BAGS

FOUR 3" CASTERS (2 with brake)

FOOT LEVER

**CARTS INCLUDE CASTER KIT FOR MOBILITY**

**1,200 lb. MOBILE LOAD CAPACITY**

**TWO DESIGNS AVAILABLE**

**Sterile Wrap Carts**

Hang bars keep sterile wraps separated and accessible for special preps. Bars are easy to adjust. Neoprene gaskets hold wraps in position. Two designs to choose from: cascading or low profile. **Finish:** Chrome

MODEL NO.	DIMENSIONS W" x L" x H"	SHIP WGT
<b>Cascading, Sterile Wrap Cart</b>		
<b>WRC-SW2448</b>	24" x 48" x 69"	103 lbs
<b>WRC-SW2460</b>	24" x 60" x 69"	110 lbs
<b>Low Profile, Sterile Wrap Cart</b>		
<b>WRC-LPSW1863</b>	18" x 63" x 39-1/2"	46 lbs



**LOW PROFILE**

WRC-LPSW1863

**CASCADING**

WRC-SW2448



**WRSC3-42-2436FS**  
24"W x 36"L x 48"H

**Open Surgical Case Carts**

Corrosion-free surgical case cart transports and delivers surgical instrumentation packs from the OR supply center to the operating room. **Finish:** 304 Stainless Steel

Each unit consists of:

- 4 - 42" stainless steel posts
- 2 - stainless steel wire shelves
- 1 - stainless steel solid shelf
- 1 - stainless steel 3-sided frame
- 1 - stainless steel push handle
- 4 - 5" swivel, stainless steel thermoplastic resin casters, 2 with brakes (casters come with Zerk grease fittings)

**3 Sided Frames**

**Finish:** 304 Stainless Steel

STAINLESS MODEL NO.	DIMENSIONS W" x L"	SHIP WGT
<b>2436FS</b>	24" x 36"	8 lbs
<b>2448FS</b>	24" x 48"	9 lbs
<b>2460FS</b>	24" x 60"	10 lbs

MODEL NO.	DIMENSIONS W" x L" x H"	NO. OF SHELVES	SHIP WGT
<b>WRSC3-42-2436FS</b>	24" x 36" x 48"	3	77 lbs
<b>WRSC3-42-2448FS</b>	24" x 48" x 48"	3	88 lbs
<b>WRSC3-42-2460FS</b>	24" x 60" x 48"	3	106 lbs



**WRSC4-54-2436FS**  
24"W x 36"L x 60"H

**CARTS INCLUDE CASTER KIT FOR MOBILITY**

**1,200 lb. MOBILE LOAD CAPACITY**

Each unit consists of:

- 4 - 54" stainless steel posts
- 3 - stainless steel wire shelves
- 1 - stainless steel solid shelf
- 1 - stainless steel 3-sided frame
- 1 - stainless steel push handle
- 4 - 5" swivel, stainless steel thermoplastic resin casters, 2 with brakes (casters come with Zerk grease fittings)

MODEL NO.	DIMENSIONS W" x L" x H"	NO. OF SHELVES	SHIP WGT
<b>WRSC4-54-2436FS</b>	24" x 36" x 60"	4	94 lbs
<b>WRSC4-54-2448FS</b>	24" x 48" x 60"	4	108 lbs
<b>WRSC4-54-2460FS</b>	24" x 60" x 60"	4	131 lbs

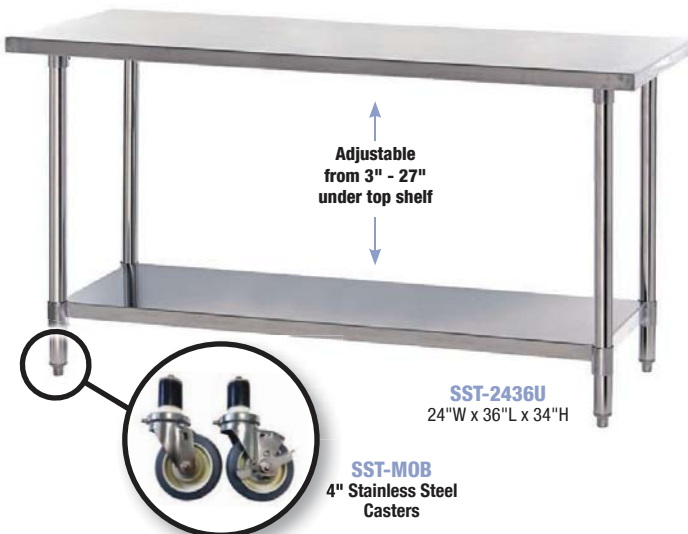

Adjustable from 3" - 27" under top shelf

**SST-2436U**  
24"W x 36"L x 34"H

**SST-MOB**  
4" Stainless Steel Casters

**Stainless Steel Work Tables with Adjustable Undershelf**



Heavy-duty 304 stainless steel processing tables are ideal for pack and prep in sterile environments. Units consist of a flat top work surface with hemmed edges and the lower flat bottom shelf is adjustable from 3" to 27" high. Tables are NSF approved. The support legs are 1-5/8" diameter with a leveling foot which can be converted to a mobile unit with a 4" stainless steel caster kit, all swivel and 2 with brake. (Sold separately) **Finish:** 304 Stainless Steel

MODEL NO.	DIMENSIONS W" x L" x H"	NO. OF SHELVES	SHIP WGT
<b>Stationary Instrument Table with Shelf</b>			
<b>SST-2436U</b>	24" x 36" x 34"	1	50 lbs
<b>SST-2448U</b>	24" x 48" x 34"	1	60 lbs
<b>SST-2460U</b>	24" x 60" x 34"	1	70 lbs
<b>SST-2472U</b>	24" x 72" x 34"	1	80 lbs
<b>Mobile Kit</b>			
<b>SST-MOB</b>	4 Swivel Casters, 2 with Brake		4 lbs



**Catheter Cart - Complete with Bins**

Uniquely designed, the catheter bin cart replaces the wire basket concept with color coded bins allowing for quicker identification. The combination of modular wire and plastic bins minimizes shrinkage and reduces unit cost. Bins are molded from high density polypropylene and are available in 7 colors. **Cart Finish:** Chrome

Bins available in: ● Blue ● Green ● Ivory ● Red ● Yellow ● Black  
● Clear (One color per unit)

MODEL NO.	BIN DIMENSIONS L" x W" x H"	SHIP WGT
<b>24"W x 48"L x 69"H - Wire Catheter Cart with 9 Wire Shelves Complete with 80 QSB105 Bins</b>		
<b>WRC9-63-2448-105</b>	23-5/8" x 4-1/8" x 4"	246 lbs



WRC9-63-2448-105

**CARTS INCLUDE  
CASTER KIT FOR  
MOBILITY**

**1,200 lb.  
MOBILE LOAD CAPACITY**



**Catheter Hooks**

Package includes 6 catheter hooks.  
**Finish:** Chrome

MODEL NO.	DESCRIPTION	CTN WGT
<b>Catheter Hooks - 6 Pack</b>		
<b>WR-CH</b>	6 Catheter Hooks	2 lbs

**Catheter Hold & Store Cart**

The catheter hold and store cart allows separation and easy accessibility to pre-packed catheters. Ideal for central or OR supply centers, this style cart is modular in design. Includes 36 or 42 catheter hooks. **Finish:** Chrome

MODEL NO.	DIMENSIONS W" x L" x H"	SHIP WGT
<b>Catheter Hold and Store Cart Includes 36 Catheter Hooks</b>		
<b>WRC-BC2448</b>	24" x 48" x 69"	105 lbs
<b>Catheter Hold and Store Cart Includes 42 Catheter Hooks</b>		
<b>WRC-BC2460</b>	24" x 60" x 69"	125 lbs



**WRC-BC2448**  
Shown with Dividable Grid Containers  
Sold separately on pg. 67





Stationary and Mobile Wire Garment Racks

Ideal storage rack for hanging any type of coat or garment. Includes handy bottom shelf for additional storage.

Finish: Chrome

Each unit consists of:

- 4 - 63" posts
- 2 - wire shelves
- 1 - hang bar (75 lb. hang capacity evenly distributed)

Mobile unit also includes:

- 4 - 5" swivel thermoplastic resin casters, 2 with brakes
- 4 - donut bumpers



WRCGR-63-2436



RACK AND CART COVERS

Protect against pilferage, airborne dust, moisture and other contaminants.

MODEL NO.	DIMENSIONS W" x L" x H"	NO. OF SHELVES	SHIP WGT
<b>Stationary Wire Garment Racks</b>			
WRGR-63-2436	24" x 36" x 63"	2	45 lbs
WRGR-63-2448	24" x 48" x 63"	2	52 lbs
WRGR-63-2460	24" x 60" x 63"	2	63 lbs
<b>Mobile Wire Garment Racks</b>			
WRCGR-63-2436	24" x 36" x 69"	2	59 lbs
WRCGR-63-2448	24" x 48" x 69"	2	66 lbs
WRCGR-63-2460	24" x 60" x 69"	2	77 lbs

NYLON FABRIC OR CLEAR VINYL RACK AND CART COVERS AVAILABLE

See pg. 136

CARTS INCLUDE CASTER KIT FOR MOBILITY

1,200 lb. MOBILE LOAD CAPACITY

Patient Apparel Cart

Ideal for patient care situations where the distribution and holding of apparel is required. The horizontal bar accommodates hangers and the shelves are divided into separate visible compartments.

Finish: Chrome

Each unit consists of:

- 4 - 63" posts
- 2 - 54" posts
- 2 - 24"W x 60"L wire shelves
- 3 - 24"W x 36"L wire shelves
- 8 - 24" dividers
- 2 - 61" rods and tabs kits
- 1 - 24" hang bar (75 lb. hang capacity evenly distributed)
- 4 - 5" swivel thermoplastic resin casters, 2 with brakes
- 4 - donut bumpers

MODEL NO.	DIMENSIONS W" x L" x H"	NO. OF SHELVES	SHIP WGT
WRCPL-63-2460	24" x 60" x 69"	5	146 lbs



WRCPL-63-2460



**Bin Transport Cart**

The combination of bins and modular shelving creates a highly efficient method of visually identifying and transporting multiple items. The large capacity bins allow for color coding and the rotation of inventories. This multi-tasked unit is excellent for a wide variety of applications and transport solutions. **Cart Finish:** Chrome

Each unit consists of:

- 4 - 63" posts
- 2 - 54" posts
- 2 - 24"W x 60"L wire shelves
- 3 - 24"W x 36"L wire shelves
- 4 - 5" swivel thermoplastic resin casters, 2 with brakes
- 4 - donut bumpers
- 4 - QUS955 (23-7/8"L x 18-1/4"W x 12"H)

Bins available in: ● Blue ● Red ● Yellow ● Clear (One color per unit)

MODEL NO.	DIMENSIONS W" x L" x H"	NO. OF BINS	SHIP WGT
WRCPL-63-2460-955	24" x 60" x 69"	4 QUS955	165 lbs

**COMPLETE PACKAGES WITH BINS**



WRCPL-63-2460-955

**CARTS INCLUDE CASTER KIT FOR MOBILITY**

**1,200 lb. MOBILE LOAD CAPACITY**

**Bin Transport Carts**

Modular in design, the Bin Transport Cart provides an integrated system to transfer items. Carts enable you to color code, hold, or transport inventories and supplies. Ideal for use in central supply and laundry. Bins are autoclavable up to 250°F. **Cart Finish:** Chrome

Bins available in: ● Blue ● Red ● Yellow (One color per unit)

MODEL NO.	NO. OF SHELVES	NO. OF BINS	BIN DIMENSIONS L" x W" x H"	SHIP WGT
<b>30"W x 36"L x 69"H - Wire Shelving Unit with HULK Containers</b>				
WRC2-63-3036-974976	2	2 6	29-7/8" x 16-1/2" x 11" 29-7/8" x 16-1/2" x 15"	150 lbs
<b>30"W x 36"L x 42"H - Wire Shelving Unit with HULK Containers</b>				
WRC2-36-3036-976	2	2 4	29-7/8" x 16-1/2" x 15"	88 lbs



WRC2-36-3036-976



WRC2-63-3036-974976

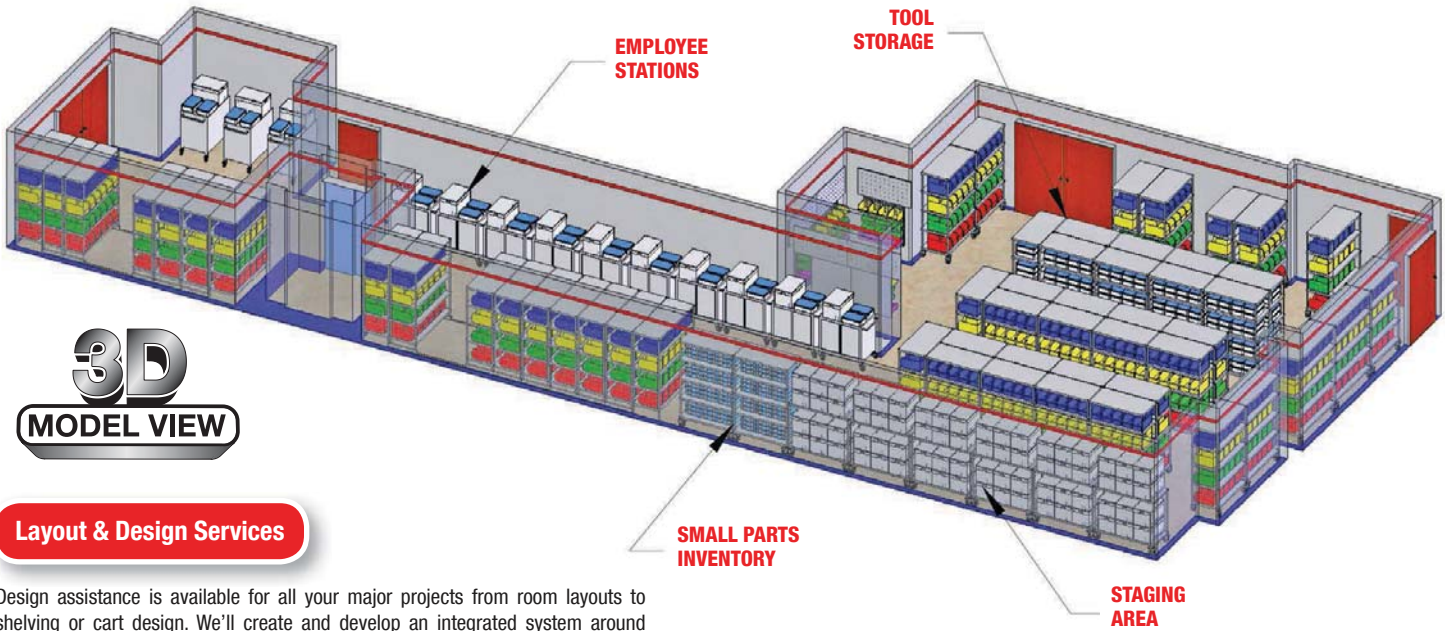

**3D MODEL VIEW**

**Layout & Design Services**

Design assistance is available for all your major projects from room layouts to shelving or cart design. We'll create and develop an integrated system around your requirements. Layouts can be created to accommodate your space with the appropriate product mix consisting of:

- Wire Shelving
- Stationary Shelving
- Bins
- Wall Systems
- Baskets
- Containers
- Hi-Density Mobile Track Systems
- Overhead Track Systems

**TO ACHIEVE THE BEST RESULTS, PLEASE PROVIDE THE FOLLOWING INFORMATION:**

- Room dimensions with door locations and door clearances, column locations (L x W) and ceiling height
- For shelving units, provide the number of shelf tiers, post height and indicate stationary or mobile
- If bins are required, indicate the appropriate size and whether they are to be used on shelving or wall mounted louvered panels

Quantum Storage offers the most complete package of storage products to satisfy all your requirements. Let us review your next project to maximize your storage space.

**DESIGN ASSISTANCE AVAILABLE**

- Industry Exclusive 3D Modeling
- Revit Blueprint and AutoCAD Compatible
- Space Utilization and Maximization
- Plan-o-grams

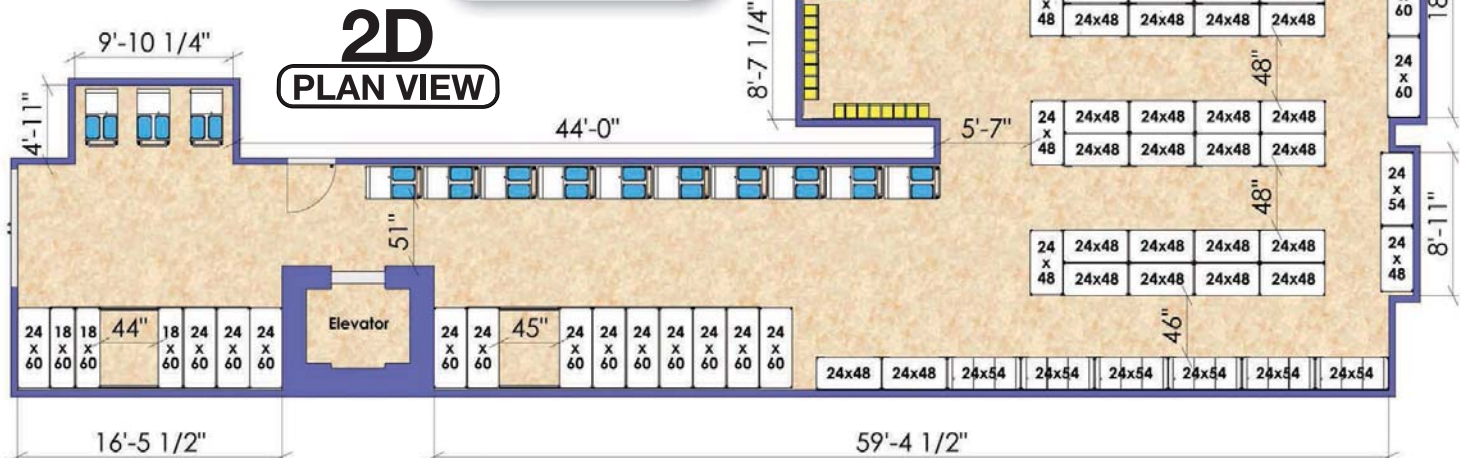



M1836CG47 - M2460CG47-5..... 137
M1836CG47RE - M2460CG47RE-5..... 139
M1836SG46 - M2460SG46-5..... 137
M1836SG47 - M2460SG47-5..... 137
M1836SL34C - M2448SL34C..... 130
M1836SL6C - M2448SL6C..... 130
M2036BD - M2048BD..... 120
M2430CLAN..... 86
M2436-69SEC - M2460-69SEC..... 141
M2436-69SECP - M2460-69SECP..... 141
M2436C46E - M2460C46E-5..... 140
MD1836C46RE - MD2460C46RE-5..... 138
MD1836C47RE - MD2460C47RE-5..... 138
MD1836CG46RE..... 139
MD2460CG46RE-5..... 139
MD1836CG47RE..... 139
MD2460CG47RE-5..... 139
MD2436-70SEC - MD2460-70SEC..... 141
MD2436-70SECP - MD2460-70SECP..... 141
MESH-240..... 16
MESH-240250..... 16
MESH-250..... 16
MSU-16-MIX..... 46
MSU-531..... 46
MSU-532..... 46
MSU-533..... 46
MSU-543..... 46
MTT-1842-543..... 74
MTT-1860-543..... 74
MTT-1878-543..... 74
MTT-3042-743..... 74
MTT-3060-743..... 74
MTT-3078-743..... 74
MWR4-2419-9..... 67
MWR5-1711-12..... 67
MWR7-1711-8..... 67
MWR5-5-92035..... 130
MWR5-5-92060..... 130
MWR5-5-92080..... 130
MWR5-7-103..... 130
MWR5-7-104..... 130
MWR5-7-108..... 130
MWR5-7-110..... 130
MWR5-7-602..... 130
MWR5-7-604..... 130
MWR5-7-606..... 130
N
NPB1076..... 76
O
ORG80032..... 79
ORG80322..... 79
ORG81532..... 79
ORG81832..... 79
P
P6BK - P96BK..... 99
P6C - P96C..... 99
P6GY - P96GY..... 99
P6P - P96P..... 99
P6S - P96S..... 99
PC3518-33..... 75
PC3518-33-3..... 75
PC3518SHELF..... 75
PC4026-33..... 75
PC4026-33-3..... 75
PC4026SHELF..... 75
PC-CAS-RG - PC-CAS-SW..... 75
PCL1 - PCL2..... 147
PCTH..... 75
PDC-12BK..... 78
PDC-18BK..... 78
PDC-22BK..... 78
PDC-39BK..... 78
PDC-60BK..... 78
PDC-930BK..... 78
PFTC4026-33-2..... 75
PFTC4026-33-3..... 75
PH18 - PH36..... 147
PH18BK - PH24BK..... 147
PH18GY - PH36GY..... 147
PH18P - PH36P..... 147
PH18S - PH36S..... 147
PLH1X6C - PLH2X4C..... 99
PS-A2475-7S..... 125
PS-A2475-8WB..... 125
PS-DBC-14S..... 126
PS-DBC-14WB..... 126
PS-DBC-7WB7S..... 126
PS-LH3..... 123,124
PS-S2475-7S..... 125
PS-S2475-8WB..... 124
PS-SBC58-6S..... 125
PS-SBC58-GWB..... 125
PS-SE - PS-SSE..... 126
PS-WB22143 - PS-WB22148..... 126
PS-WBLD-3 - PS-WBLD-8..... 126
PS-WBLS-3 - PS-WBLS-8..... 126
PS-WS2414..... 126
PT-NR..... 149
PT-NS..... 149
PT-PR - PT-PR6..... 149
PT-PS - PT-PS6..... 149
PT-PSB - PT-PSB6..... 149
PWB..... 118
Q
QB200 - QB900..... 80
QBB-4845-34..... 72
QBC111..... 48,53,57
QBC112..... 48,53,57
QBR-1819..... 9
QBR-2721..... 9
QBR-2721-210-24..... 12
QBR-2721-210-24CL..... 21
QBR-2721-220-24..... 12
QBR-2721-220-24CL..... 21
QBR-2721-230-12..... 12
QBR-2721-230-12CL..... 21
QBR-3612..... 9
QBR-3619..... 9
QBR-3619-210-32..... 12
QBR-3619-210-32CL..... 21
QBR-3619-220-32..... 12
QBR-3619-220-32CL..... 21
QBR-3619-230-18..... 12
QBR-3619-230-18CL..... 21
QDC2012-7..... 71
QDC2115-9..... 71
QDC2115-12..... 71
QDC2115-17..... 71
QDC2213-12..... 71
QDC2420-12..... 71
QDC2515-14..... 71
QDC2717-12..... 71
QDC2820-15..... 71
QDL-2115..... 71
QDS300..... 89,91
QDS-3666H..... 10
QDU-00..... 50,55,62
QDU-18..... 50,55,62
QED401..... 60
QED501..... 60
QED601..... 60
QED602..... 60
QED603..... 60
QED604..... 60
QED606..... 60
QED701..... 60
QED801..... 60
QESTP..... 142
QFS124 - QFS270..... 91
QFS124-31..... 90
QFS148-38..... 90
QFS170-36..... 90
QFS224-24+QFS400..... 91
QFS224-24..... 90
QFS248-76+QFS400..... 91
QFS248-76..... 90
QFS270-72+QFS400..... 91
QFS270-72..... 90
QFS400..... 91,95
QGH600..... 42
QGH600CL..... 23
QGH700..... 42
QGH700BR..... 81
QGH700CL..... 23
QGH705MOB..... 42
QGH705MOBCL..... 23
QGH800..... 42
QGH800CL..... 23
QGH805MOB..... 42
QGH805MOBCL..... 23
QIC-12123..... 94
QIC-122..... 94
QIC-124-122..... 95
QIC-124-161..... 95
QIC-124-64..... 95
QIC-124-83..... 95
QIC-148-122..... 95
QIC-148-161..... 95
QIC-148-64..... 95
QIC-148-83..... 95
QIC-161..... 94
QIC-170-122..... 95
QIC-170-161..... 95
QIC-170-64..... 95
QIC-170-83..... 95
QIC-224-122..... 95
QIC-224-161..... 95
QIC-224-64..... 95
QIC-224-83..... 95
QIC-248-122..... 95
QIC-248-161..... 95
QIC-248-64..... 95
QIC-248-83..... 95
QIC-270-122..... 95
QIC-270-161..... 95
QIC-270-64..... 95
QIC-270-83..... 95
QIC-4163..... 94
QIC-4244..... 94
QIC-64..... 94
QIC-8143..... 94
QIC-8224..... 94
QIC-83..... 94
QLP-1819 - QLP-1819HC..... 8
QLP-1819-210-16..... 12
QLP-1819-210-16CL..... 21
QLP-1819-220-16..... 12
QLP-1819-220-16CL..... 21
QLP-1819-230-9..... 12
QLP-1819-230-9CL..... 21
QLP-1861 - QLP-1861HC..... 8
QLP-2721..... 8
QLP-3612..... 8
QLP-3619 - QLP3619HC..... 8
QLP-3619-210-32..... 12
QLP-3619-210-32CL..... 21
QLP-3619-220-32..... 12
QLP-3619-220-32CL..... 21
QLP-3619-230-18..... 12
QLP-3619-230-18CL..... 21
QLP-3661 - QLP-3661HC..... 8
QLP-3661-220-120..... 12
QLP-3661-220-120CL..... 21
QLP-3661-230-60..... 12
QLP-3661-230-60CL..... 21
QLP-3661-240-28..... 12
QLP-3661-240-28CL..... 21
QLP-4819..... 8
QLP-4861 - QLP-4861HC..... 8
QLP-4861-220-165..... 12
QLP-4861-220-165CL..... 21
QLP-4861-230-80..... 12
QLP-4861-230-80CL..... 21
QLP-4861-240-35..... 12
QLP-4861-240-35CL..... 21
QLR500..... 87,89
QMB510C..... 6
QMB520C..... 6
QMB524C..... 6
QMB530C..... 6
QMB534C..... 6
QMB535C..... 6
QMB539C..... 6
QMB540C..... 6
QMB550C..... 6
QMB560C..... 6
QMB565C..... 6
QMB570C..... 6
QMD-36H..... 10
QMD-36H-220..... 12
QMD-36H-220CL..... 21
QMD-36H-230..... 12
QMD-36H-230CL..... 21
QMD-36H-230240..... 12
QMD-36H-230240CL..... 21
QMD-36H-240..... 12
QMD-36H-240CL..... 21
QMS531..... 45
QMS531BR..... 81
QMS532..... 45
QMS532BR..... 81
QMS533..... 45
QMS533BR..... 81
QMS543..... 45
QMS543BR..... 81
QMS743..... 45
QMS743BR..... 81
QMS843MOB..... 45
QP965..... 63
QP1265..... 63
QP1285..... 63
QP1496..... 63
QP1867..... 63
QP1887..... 63
QPR-101..... 16
QPR-102..... 16
QPR-107..... 16
QPRD-000..... 50,62
QPRD-100..... 50
QPRD-100CL..... 25
QPRD-101..... 50
QPRD-101CL..... 25
QPRD-102..... 50
QPRD-102CL..... 25
QPRD-103..... 50
QPRD-104..... 50
QPRD-107..... 50
QPRD-107CL..... 25
QPRD-108..... 50
QPRD-109..... 50
QPRD-109CL..... 25
QPRD-110..... 50
QPRD18-000..... 50,62
QPRD18-6..... 55
QPRD-201..... 55
QPRD-201CL..... 27
QPRD-202..... 55
QPRD-202CL..... 27
QPRD-203..... 55
QPRD-204..... 55
QPRD-207..... 55
QPRD-207CL..... 27
QPRD-208..... 55
QPRD-209..... 55
QPRD-209CL..... 27
QPRD-210..... 55
QPRD-501..... 62
QPRD-5678..... 62
QPRD-6..... 55
QPRD-601..... 62
QPRD-602..... 62
QPRD-604..... 62
QPRD-606..... 62
QPRD-701..... 62
QPRD-801..... 62
QPRHA-000..... 50,62
QPRHA-100..... 50
QPRHA-100CL..... 25
QPRHA-101..... 50
QPRHA-101CL..... 25
QPRHA-102..... 50
QPRHA-102CL..... 25
QPRHA-107..... 50
QPRHA-107CL..... 25
QPRHA-109..... 50
QPRHA-109CL..... 25
QPRHA-201..... 55
QPRHA-201CL..... 27
QPRHA-202..... 55
QPRHA-202CL..... 27
QPRHA-207..... 55
QPRHA-207CL..... 27
QPRHA-209..... 55
QPRHA-209CL..... 6
QPRHA-501..... 62
QPRHA-567..... 62
QPRHA-6..... 55
QPRHA-601..... 62
QPRHA-701..... 62
QPRS-000..... 50
QPRS-100..... 50,62
QPRS-100CL..... 25
QPRS-101..... 50
QPRS-101CL..... 25
QPRS-102..... 50
QPRS-102CL..... 25
QPRS-103..... 50
QPRS-104..... 50
QPRS-107..... 50
QPRS-107CL..... 25
QPRS-108..... 50
QPRS-109..... 50
QPRS-109CL..... 25
QPRS-110..... 50
QPRS18-000..... 50,62
QPRS18-6..... 55
QPRS-201..... 55
QPRS-201CL..... 27
QPRS-202..... 55
QPRS-202CL..... 27
QPRS-203..... 55
QPRS-204..... 55
QPRS-207..... 55
QPRS-207CL..... 27
QPRS-208..... 55
QPRS-209..... 55
QPRS-209CL..... 27
QPRS-210..... 55
QPRS-501..... 62
QPRS-5678..... 62
QPRS-6..... 55
QPRS-601..... 62
QPRS-602..... 62
QPRS-604..... 62
QPRS-606..... 62
QPRS-701..... 62
QRB166..... 60
QRB176MOB..... 40
QRB206..... 40
QRB216MOB..... 40
QRB246..... 40
QRB256MOB..... 40
QRC-4D..... 18
QRU-12D..... 11
QRU-12D-220-192..... 12
QRU-12D-220-192CL..... 21
QRU-12D-240-48..... 12
QRU-12D-240-48CL..... 21
QRU-1W - QRU-1WHC..... 11
QRU-12S..... 11
QRU-12S-220-96..... 12
QRU-12S-220-96CL..... 21
QRU-12S-240-24..... 12
QRU-12S-240-24CL..... 21
QRU-16D..... 11
QRU-16D-230-96..... 12
QRU-16D-230-96CL..... 21
QRU-16S..... 11
QRU-16S-220230240..... 12
QRU-16S-220230240CL..... 21
QRU-16S-230-48..... 12
QRU-16S-230-48CL..... 21
QRU-MOB..... 11,12,21
QS-000..... 92
QS-304-28..... 92
QS-305306-52..... 92
QS-305-36..... 92
QS-306-56..... 92
QS-309-80..... 92
QS-569-56..... 92
QS-725..... 92
QS-BIG-101..... 92
QSB100..... 48
QSB100BR..... 81
QSB100CL..... 84
QSB100CO..... 83
QSB101..... 48
QSB101BR..... 81
QSB101CL..... 24
QSB101CO..... 83
QSB102..... 48
QSB102BR..... 81
QSB102CL..... 24
QSB102CO..... 83
QSB103..... 48
QSB103BR..... 81
QSB103CL..... 24
QSB103CO..... 83
QSB104..... 48
QSB104BR..... 81
QSB104CL..... 24
QSB104CO..... 83
QSB105..... 48
QSB105BR..... 81
QSB105CL..... 24
QSB105CO..... 83
QSB106..... 48
QSB106BR..... 81
QSB106CL..... 24
QSB106CO..... 83
QSB107..... 48
QSB107BR..... 81
QSB107CL..... 24
QSB107CO..... 83
QSB108..... 48
QSB108BR..... 81
QSB108CL..... 24
QSB108CO..... 83
QSB109..... 48
QSB109BR..... 81
QSB109CL..... 24
QSB109CO..... 83
QSB110..... 48
QSB110BR..... 81
QSB110CL..... 24
QSB110CO..... 83
QSB114..... 48
QSB114BR..... 81
QSB114CL..... 24
QSB114CO..... 83
QSB116..... 48
QSB116BR..... 81
QSB116CL..... 24
QSB116CO..... 83
QSB201..... 26
QSB202..... 53
QSB202CL..... 26
QSB203..... 53
QSB203CL..... 26
QSB204..... 53
QSB204CL..... 26
QSB205..... 53
QSB205CL..... 26
QSB206..... 53
QSB206CL..... 26
QSB207..... 53
QSB207CL..... 26
QSB208..... 53
QSB208CL..... 26
QSB209..... 53
QSB209CL..... 26
QSB210..... 53



WR74-1236GY - WR74-3672GY-5	102	WR8-801	59	WRC-1836-3G - WRC-1848-3G	134	WR-RG	149	WS-HBBA-D	115
WR74-1236P - WR74-3672P-5	102	WR8-801CL	29	WRC-1836BK-2 - WRC-1848BK-2	134	WR-S24W	132,133	WS-HBB-D	115
WR74-1236S - WR74-3672S-5	102	WR8-802	59	WRC-1836BK-3 - WRC-1848BK-3	134	WRS4-54-1436SS -		WS-HDS12	9,115
WR74-1248-101102	52	WR8-802CL	29	WRC-1836GY-2 - WRC-1848GY-2	134	WRS4-86-2472SS	106	WS-HDS6	9,115
WR74-1248-110101	52	WR8-803	59	WRC-1836GY-3 - WRC-1848GY-3	134	WRS5-54-1436SS -		WS-HTH	9,115
WR74-1248-66102	52	WR8-803CL	29	WRC-1836P-2 - WRC-1848P-2	134	WRS5-86-2472SS	107	WS-MOB	112
WR74-1260-101102	52	WR8-804	59	WRC-1836P-3 - WRC-1848P-3	134	WRS-5-92035	130	WS-PM18HC	114
WR74-1260-143101	52	WR8-804CL	29	WRC-1836-1265	63	WRS-5-92060	130	WS-PM36HC	114
WR74-1260-88102	52	WR8-805	59	WRC2-1836-1285	63	WRS-5-92080	130	WS-PM48HC	114
WR74-1272-110102	52	WR8-805CL	29	WRC2-1836-1867	63	WRS-7-103	130	WS-SR9C	9,115
WR74-1272-110102	52	WR8-806	59	WRC2-1836-1887	63	WRS-7-104	130	WS-SSMOB	112
WR74-1272-176101	52	WR8-806CL	29	WRC2-36-3036-976	154	WRS-7-108	130	WS-VTH	9,115
WR74-1436SG - WR74-2472SG	104	WR8-807	59	WRC-2436-2 - WRC-2448-2	134	WRS-7-110	130	WUS221 - WUS270	5
WR74-1436SG-5 -		WR8-807CL	29	WRC-2436-2CG - WRC-2448-2CG	134	WRS-7-602	130	WUS950 - WUS957	34
WR74-2472SG-5 -	105	WR8-808	59	WRC-2436-2CG - WRC-2448-2CG	85	WRS-7-604	130	WUS970 - WUS976	37
WR74-1836CRNC -		WR8-808CL	29	WRC-2436-2G - WRC-2448-2G	134	WRS4-54-1436SS -			
WR74-1836CRNC-5 -	110	WR8-809	59	WRC-2436-3 - WRC-2448-3	134	WRSAD4-86-2472SS	106		
WR74-1848-103104	52	WR8-809CL	29	WRC-2436-3CG - WRC-2448-3CG	134	WRSAD5-54-1436SS -			
WR74-1848-110103	52	WR8-810	59	WRC-2436-3CG - WRC-2448-3CG	85	WRSAD5-86-2472SS	107		
WR74-1848-66104	52	WR8-810CL	29	WRC-2436-3G - WRC-2448-3G	134	WR-SB2R2	149		
WR74-1860-103104	52	WR8-814	59	WRC-2436BK-2 - WRC-2448BK-2	134	WRSC-1836-2 - WRSC-1848-2	134		
WR74-1860-143103	52	WR8-814CL	29	WRC-2436BK-3 - WRC-2448BK-3	134	WRSC-1836-2SS -			
WR74-1860-88104	52	WR8-816	59	WRC-2436GY-2 - WRC-2448GY-2	134	WRSC-1848-2SS	134		
WR74-1872-103104	52	WR8-816CL	29	WRC-2436GY-3 - WRC-2448GY-3	134	WRSC-1836-3 - WRSC-1848-3	134		
WR74-1872-110104	52	WR8-950	36	WRC-2436P-2 - WRC-2448P-2	134	WRSC-1836-3SS -			
WR74-1872-176103	52	WR8-95052CL	22	WRC-2436P-3 - WRC-2448P-3	134	WRSC-1848-3SS	134		
WR74-2436C-22D	86	WR8-950CL	22	WRC-2436-3G-974976	154	WRSC-1836SS-2S -			
WR74-2442CRNC -		WR8-952	36	WRC3-1836-1265	63	WRSC-1848SS-2S	134		
WR74-2442CRNC-5 -	110	WR8-952CL	22	WRC3-1836-1285	63	WRSC-1836SS-3S -			
WR74-2448-105106	52	WR8-970	38	WRC3-1836-1867	63	WRSC-1848SS-3S	134		
WR74-2448-110105	52	WR9-201	56	WRC3-1836-1887	63	WRSC-2436-2 - WRSC-2448-2	134		
WR74-2448-66106	52	WR9-201CL	26	WRC5-63-2436-93060 -		WRSC-2436-2SS -			
WR74-2460-105106	52	WR9-202	56	WRC5-63-2460-93060	132	WRSC-2448-2SS	134		
WR74-2460-143105	52	WR9-202CL	26	WRC74-BSK1824C-5 -		WRSC-2436-3 - WRSC-2448-3	134		
WR74-2460-88106	52	WR9-203	56	WRC74-BSK2460C-5	122	WRSC-2436-3SS -			
WR74-2472-105106	52	WR9-203CL	26	WRC9-63-2448-105	152	WRSC-2448-3SS	134		
WR74-2472-110106	52	WR9-204	56	WRC-BC2448 - WRC-BC2460	152	WRSC-2436SS-2S -			
WR74-2472-176105	52	WR9-204CL	26	WRCGR-63-2436 -		WRSC-2448SS-2S	134		
WR7-532	47	WR9-205	56	WRCGR-63-2460	153	WRSC-2436SS-3S -			
WR7-92080	67	WR9-205CL	26	WR-CH	152	WRSC-2448SS-3S	134		
WR7-92080CL	31	WR9-206	56	WRC-IT-1824	134	WRSC3-42-2436FS -			
WR7-951	36	WR9-206CL	26	WRC-PSW1863	150	WRSC3-42-2460FS	151		
WR7-951CL	22	WR9-207	56	WRCPL-63-2460	153	WRS4-54-2436FS -			
WR8-239	14	WR9-207CL	26	WRCPL-63-2460-955	154	WRS4-54-2460FS	151		
WR8-239CL	20	WR9-208	56	WRC-R60C	111	WR-DFP	148		
WR8-240	14	WR9-208CL	26	WRC-R264C	86,111	WR-SFP	148		
WR8-240CL	20	WR9-209	56	WRC-R468C	111	WRSL6-74-1848-260	130		
WR8-245CL	20	WR9-209CL	26	WRCS4-63-2436EP -		WRSL6-74-2448-953	130		
WR8-250	14	WR9-210	56	WRCS4-63-2460EP-5	140	WR-SP	148		
WR8-250CL	20	WR9-210CL	26	WRCS4-74-2436EP -		WR-SS - WR-SSCO	148		
WR8-255	14	WR9-214	56	WRCS4-74-2460EP-5	140	WR-WMB	148		
WR8-255CL	20	WR9-214CL	26	WRCSL5-63-1836 -		WS-1218DSHC - WS-1848DSHC	115		
WR8-423	33	WR9-216	56	WRCSL5-63-2448	131	WS70-DS18ADHC -			
WR8-425	33	WR9-216CL	26	WRCSL5-63-1836-104 -		WS70-DS48ADHC	114		
WR8-441	33	WR9-36180	67	WRCSL5-63-2448-106	131	WS70-DS18HC - WS70-DS48HC	114		
WR8-443	33	WR9-36180CL	30	WRCSL5-63-1836EP -		WS70-SS18-4S3L -			
WR8-445	33	WR9-531	47	WRCSL5-63-2448EP	131	WS70-SS18AD-7S	113		
WR8-461	33	WR9-92060	67	WRCSL5-63-1836EP-104 -		WS70-SS18ADHC -			
WR8-463	33	WR9-92060CL	31	WRCSL5-63-2448EP-106	131	WS70-SS48ADHC	114		
WR8-465	33	WR9-93060	67	WRCSL5-74-1836-104220 -		WS70-SS18HC - WS70-SS48HC	114		
WR8-463	33	WR9-93060CL	31	WRCSL6-74-1848-104220	131	WS70-SS36-4S3L -			
WR8-483485	33	WRA86-2136C-166	41	WRCSL6-74-1848-260	130	WS70-SS36AD-7S	113		
WR8-485	33	WRA86-2142C-206	41	WRC-5W2448 - WRC-5W2460	150	WS70-SS48-4S3L -			
WR86-1236BK - WR86-3672BK-5	103	WRA86-2154C-166	41	WR-D24W	133	WS70-SS48AD-7S	113		
WR86-1236G - WR86-3672G-5	103	WRC-1836-2 - WRC-1848-2	134	WRDBS4-63-2436EP -		WS-DR10C	9,115		
WR86-1236GY - WR86-3672GY-5	103	WRC-1836-2CG - WRC-1848-2CG	134	WRDBS4-63-2460EP-5	140	WS-DSMOB	112		
WR86-1236P - WR86-3672P-5	103	WRC-1836-2CG - WRC-1848-2CG	85	WRDBS4-74-2436EP -		WS-HB36HC	115		
WR86-1236S - WR86-3672S-5	103	WRC-1836-2G - WRC-1848-2G	134	WRDBS4-74-2460EP-5	140	WS-HB48HC	115		
WR86-1236SG - WR86-3672SG	104	WRC-1836-3 - WRC-1848-3	134	WRGR-63-2436 - WRGR-63-2460	153	WS-HBB	115		
WR86-1436SG-5 -		WRC-1836-3CG - WRC-1848-3CG	134	WR-PS	149	WS-HBBA	115		
WR86-2472SG-5	105	WRC-1836-3CG - WRC-1848-3CG	85						

**COLOR OPTION ORDERING INSTRUCTIONS**

In order to properly process your order, please include a color code suffix to any model number available with color options. Use the two letter abbreviation listed below and add them to the end of the model number without any spaces or dashes.

(i.e. **QSB101** in Blue would be submitted as **QSB101BL**)

- **BK** BLACK
- **BL** BLUE
- **BR** RECYCLED
- **CL** CLEAR
- **CO** CONDUCTIVE
- **GN** GREEN
- **GY** GRAY
- **IV** IVORY
- **OR** ORANGE
- **PK** PINK
- **PU** PURPLE
- **RD** RED
- **SN** STONE
- **WT** WHITE
- **YL** YELLOW

**VISIT US ONLINE**

*to view our full product line*

**WWW.QUANTUMSTORAGE.COM**

**Great storage products, delivered quickly at the guaranteed lowest prices. Contact Quantum Storage Systems today and revolutionize the way you organize!**



CATALOG NO. 030120

**CORPORATE HEADQUARTERS**

15800 NW 15th Avenue  
Miami, FL 33169  
Phone (305) 687-0405  
Fax (305) 688-2790

Toll Free **1-800-685-4665**  
[sales@quantumstorage.com](mailto:sales@quantumstorage.com)

**MIDWEST DISTRIBUTION CENTER**

2600 United Lane  
Elk Grove Village, IL 60007  
Phone (305) 687-0405  
Fax (305) 688-2790

Toll Free **1-800-685-4665**  
[sales@quantumstorage.com](mailto:sales@quantumstorage.com)

**WEST COAST DISTRIBUTION CENTER**

4603 N Brawley Avenue Suite 103  
Fresno, CA 93722  
Phone (559) 275-2467  
Fax (559) 275-3249

[sales@quantumwestcoast.com](mailto:sales@quantumwestcoast.com)

**CANADA DISTRIBUTION CENTER**

1624 Concession Road  
Cambridge, Ontario N3H 4L9  
Phone (519) 653-8848  
Fax (519) 653-7989

Toll Free **1-888-653-8848**  
[quantumstorage@bellnet.ca](mailto:quantumstorage@bellnet.ca)