



IN STOCK



Save Your Assets

- People
- Products
- Equipment
- More

"Save"ty[®] Stand Guard Rails & Systems



Protecting The Supply Chain.

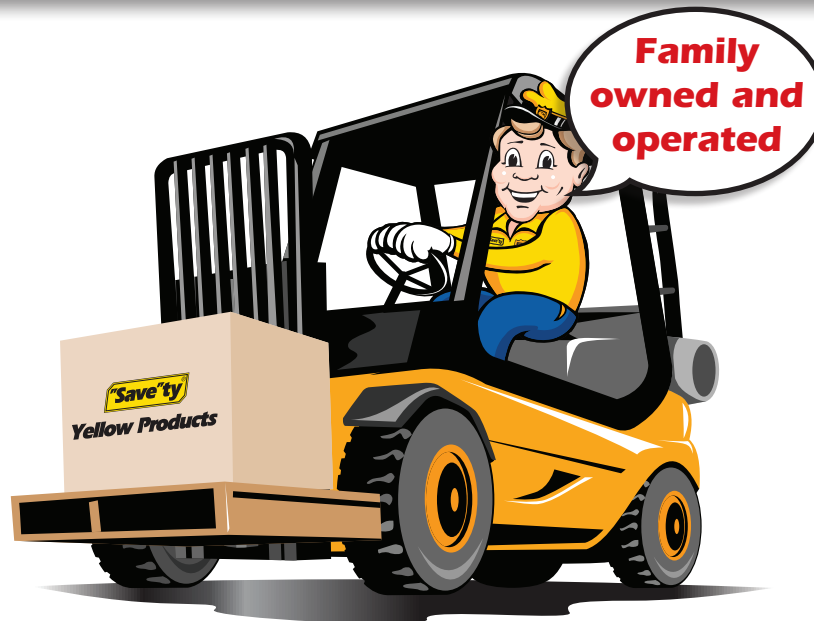

We Deliver MORE Than Just Our Products!

We Deliver PEACE OF MIND!

Without "Save"ty Yellow Products, you may be worrying more about safety issues than you should be.

You have invested in your business – equipment, inventory, and especially employees – to meet the needs of your customers. You don't want unexpected safety issues to cause you downtime, added expense, or personal injury. Let "Save"ty Yellow Products help protect your business and **SAVE YOUR ASSETS!**

Our products have been shown to protect employees, facilities, products, and equipment from impact with fork trucks, and do it better and at a lower cost! We have supplied products to facilities used by some of America's finest companies, including Sears, U.S. Foods, Adidas, Home Depot, and General Electric.

Built on the foundation of "The Original **LIFT-OUT Sleeve Design**" guard rail system, "Save"ty Yellow Products has branched out to include facility protection, hand rails,

safety gates and more. We continue to develop new products to meet safety needs and also customize products for specific applications.

The products we manufacture are made in America, powder coated with certified lead-free paint, and stocked in Illinois.

We invite you to enjoy the peace of mind that comes from knowing that your business is protected 24/7. "Save"ty Yellow Products can help you do that!

– The Gentile Family

The little things matter...



In Stock



Quality



Packaging

Guard Rails



Double corner post



Inline post



Optional offset end post

Ribbed Rail "Stand Guard"

Our most popular item: the **Stand Guard** ribbed rail. "The Original **LIFT-OUT Sleeve Design**" reduces installation cost by half!

- Sleeves are welded to posts, **no costly brackets as an afterthought.**
- Posts: 4" (10,000 lbs.) with 10" x 10" x 1/2" base or 5" (12,000 lbs.) with 10" x 10" x 5/8" base, both rated at 5 mph, and with painted steel caps.
- Post heights: 18", 26" & 42".
- 10-gage, high-tensile steel rails fit either post.
- Rails are 2' through 10' in 1' increments.



FULLY WELDED SLEEVES!

Offset posts are in stock.





Lite ribbed guard rail



Create a pedestrian walkway with Stand Guard Lite



Twin Rail with LIFT-OUT design



Quick release hardware for rails is included

Lite Duty Guard Rail

"Stand Guard" Lite is designed for powered and manual stackers, electric pallet trucks, steel carts & hoppers, etc.

- A great alternative to high strength guard rail, with *The Original LIFT-OUT Sleeve Design*.
- Designed for heavy impacts up to 5,000 lbs. at 5 mph.
- 4" posts, 18" & 42" high, with 8" x 8" base.
- 14-gage, high-tensile steel rails are 2' through 10' in 1' increments.



FAST DELIVERY →



Twin Rail

Durable steel protection

- Our original Twin Rail design from 2003 re-styled with stronger rails. It comes standard with **LIFT-OUT** rails that offer holes for bolting together if desired.
- Great for mezzanine fall protection, or light duty applications where standard guard rail isn't required.
- 44" tall posts with a powder coated steel cap.
- 3" x 3" posts, with a 6" x 6" x 1/2" base plate is rated for 5000 lbs. impact at 4 mph.
- 4" tall x 2" wide rail is 11-gage high-tensile steel.
- Top rail is 42" high and meets OSHA fall protection.
- Available in 4', 6', 8' and 10' length.

Steel Bollards



Stand Guard square bollards



Yellow & red bollards



Direct bury bollards

Steel Bollards

Steel bollards protect a variety of facility assets.

- Surface mount to concrete or Direct Bury.
- **Economy** 4.5" O.D., Yellow or Red, 5.5" O.D., Yellow only, 24," 36" or 42" tall.
- **Standard** 4.5" O.D. 42" tall, Yellow with black plastic cap; or 6.5" O.D. 24", 36" or 42" tall, Yellow with welded top, available with welded eyelet.
- **Direct Bury** 5.5", 6.5" & 8.5" O.D. 84" tall, Yellow.
- **Square Bollard** 4" square tube. 42" tall with painted steel cap.



**We Have
Your Bollards!
Ready To
Ship!**



SURFACE MOUNT				
OD	HEIGHT	BASE	COLOR	TOP
4.5"	24", 36", 42"	8x8x1/4	Yellow or Red	Plastic cap
5.5"	24", 36", 42"	8x8x1/4	Yellow	Plastic cap
6.5"	24", 36", 42"	9x9x1/2	Yellow	Welded
IN GROUND BOLLARDS				
OD	HEIGHT	BASE	COLOR	TOP
5.5"	84"	NONE	Yellow	OPEN
6.5"	84"	NONE	Yellow	OPEN
8.5"	84"	NONE	Yellow	OPEN



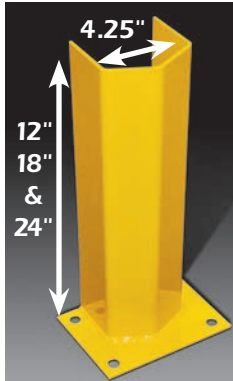

"V" face

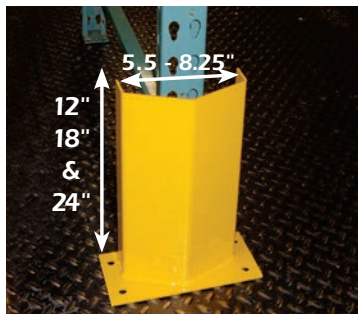

Seismic

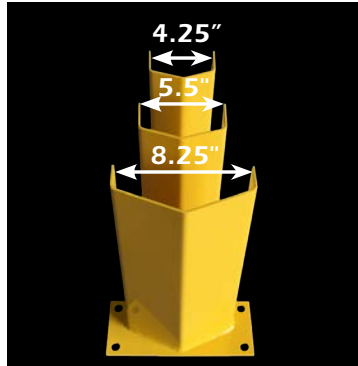

3 different heights & widths



Poly post protector

Traditional Post Protectors

Traditional style post protection available in a "V" shape or formed face.

- Traditional style with four mounting holes.
- Choose from 12", 18", & 24" tall.
- Clear opening: 4¼.
- Anchors available upon request.

**7,000
In Stock!**

Seismic Post Protectors

Seismic post protectors in "V" face style designed to fit around seismic footplates.

- Clear opening of 5.5" or 8.25".
- Choose from 12", 18" or 24" tall.
- Base plate is 5" deep with four mounting holes.
- Anchors available upon request.

Poly Post Protectors

Easy snap on installation.

- Fits 3" x 1-5/8" or 3" x 3" rack.
- 8" tall x 5 ½" O.D. wide.
- Stackable.



Post Protectors



Bolt On

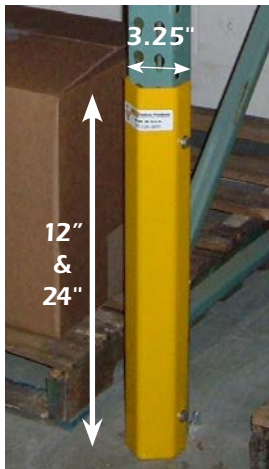

Side mount

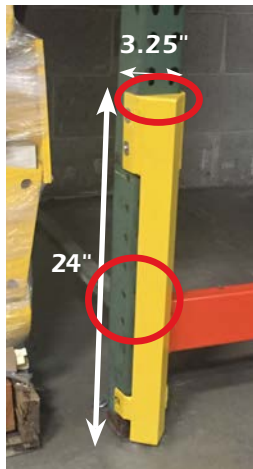

Closed top for food industry



Flush hardware



Bolt On Post Protectors

Bolt-on post protectors add strength to frame column to prevent costly rack damage.

- Available in 18" tall with a clear opening 3".
- $\frac{3}{16}$ " thick wall.
- Includes hardware to attach to rack frame.
- Add strength to your upright.
- Mounting hole inside bull nose.
- Accepts $\frac{5}{8}$ " anchor.



Side Mount Frame / Column Protectors

Stop damage at every level.

- Increase frame strength.
- No base plate to interfere when storing pallets.
- 3.25" clear opening.
- 12" and 24" tall with 2" hole spacing.
- Mounting hardware included.

Food Industry Closed Top Post Protectors

New food industry closed Top Post/Column Protector

- 24" tall with closed top.
- Side mount with open/notched back for first beam level.
- 3.25" clear opening.
- 24" tall with 2" hole spacing.
- Mounting hardware included.





Outrigger post protector



1/4" or 3/8" in stock



Patented

Outrigger Post Protectors

Designed specifically for Outriggers.

- Choose from 1/4" or 3/8" thickness.
- 4" tall x 3.25" clear, or 5.5" available.
- One mounting hole behind face.
- Accepts 5/8" anchors.



FAST DELIVERY →

Hidden Anchor Post Protectors

Rack column post protectors eliminate base plates.

- Bolt down model with bracket hardware.
- Energy absorbing design anchors securely in front & behind frame.
- 12" tall by 9" deep.
- Inside dimensions are 5" x 5".
- TAPCON anchors available upon request.



Column Protectors



Slim & short models



Eagle™ – Velcro™ strap



The Original **LIFT-OUT** Sleeve Design is available in single-rail height



Building and Mezzanine Column Protectors

Prevent damage to building support columns or mezzanine columns. From Eagle™ Mfg.

- **SHORT** Model is 24" tall x 24" wide for 6", 8", 10" & 12" columns, Yellow or Red.
- **SLIM** Model is 42" tall x 12" wide for 4", 5", & 6" columns, Yellow.
- **STANDARD** Model is 42" tall x 24" wide for 6", 8", 9" Round, 10", & 12" columns. Yellow standard, Lime Green or Orange with reflective tape also available.
- **FASTENERS** Velcro straps.
- **SHIPPING POINTS**
Four shipping warehouses.



Style	Eagle™	Colors
SHORT	6", 8", 10", 12"	Yellow, Red
SLIM	4" - 6"	Yellow
STANDARD	6", 8", 9" Round, 10", 12"	Yellow, Orange, Lime Green
FASTENER	Velcro Strap	Black

Protect Your Building Columns & Downspouts with Stand Guard Rail

Our most popular item: the **Stand Guard ribbed rail**. All welded **DROP-IN, LIFT-OUT** design standard.

- Sleeves are welded to posts, **no costly brackets as an afterthought.**
- Post heights: 18", 26" & 42"
- Rails are 2' through 10' in 1' increments.



Seismic option



Half curved end
(right hand pictured)



Double E.O.A.

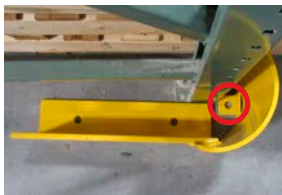

Three
mounting holes



Strong
corner protection



Rack Guard Round
Protects your warehouse



Pallet stop

End of Aisle Rack Protection Curved End

Rack protection creates a visible guide through aisles and saves thousands in damage.

- Available in 36", 42" & 48", single or double ends.
- Custom sizes available.
- Curved end has an 8" I.D. x 12" tall.
- Choose floor angle thicknesses of 1/2", 3/8", and 1/4".

Super Duty Rack Guard

Three mounting holes.

- Our strongest rack guard yet with an extra mounting hole behind the curved face.
- 18" long with 6" x 4" x 1/2" steel angle.
- Has two mounting holes on the angle and one behind the nose.

Rack Guard Round

Solid welded construction.



- Fits snug to frame.
- 1/2" thick feet fit under rack for tight installation, resulting in a 5" height.
- Accommodates seismic foot plates up to 8" deep.
- 36", 42" or 48" O.A.L., with closed ends.
- Custom sizes available.

Pallet Stop

Prevent wall and product damage.

- 18" long x 5" tall, centered between rack frame, protects two skids at the same time.
- Anchors to the floor with two legs on either side of frame.
- Mounting feet may be mounted against the wall / Plastic end caps optional.



Dock Equipment



With and without safety bevel



Economy Door Track

Door Track Protectors

Door Track protects overhead door track from damage while placing or retrieving pallets.

- Available with or without safety bevel.
- Eliminates expensive service calls for door repair.
- Available without baseplate.
- Standard duty for Fork Truck & commercial applications.
- Full 7" depth, up to 14" available.
- 36" & 48" tall in stock.
- 3/16" thick material, 1/4" available.

Economy Door Track Protectors

- 42" tall with a "U" shape post to cover the track.
- Base is 1/4" x 4" x 4" for a tight fit near door.
- Accepts 1/2" hardware.
- I.D. is 2-3/8" clear.



POWDER
COATED
TOUGH™



Indoor



Outdoor

Hand Rails

Modular hand rail protects employees from entering areas that are unsafe.

- Rails are powder coated yellow for long lasting durability.
- Easy installation, simply assemble and anchor down.
- Easy replacement of damaged sections or relocation.
- Stocked sizes: 4', 6', and 8' sections; can be cut down in the field.
- Available in any layout, including corners.
- 1.66" O.D., OSHA & IBC compliant.
- 42" tall standard, ADA available.
- Fittings for mezzanine installation available.
- Anchors available upon request.

Galvanized cast iron fittings



#SYP-12



#SYP-02



#SYP-20



#SYP-03



#SYP-21



#SYP-22



#SYP-04



Indoor or outdoor

All Welded Hand Rails

All Welded hand rails provide an alternative to the Modular hand rail.

- Rails are powder coated steel for long lasting durability.
- 4', 6,' and 8' sections are IN STOCK.
- 2" O.D. Round tube with 6" x 6" x 1/4" base plates offset to the edge.
- Fast, easy installation, just place and anchor down.
- Anchors available upon request.
- Coped midrail, not crushed.



Safety Swing Gates



Great for stair openings



Double gate has built-in stop

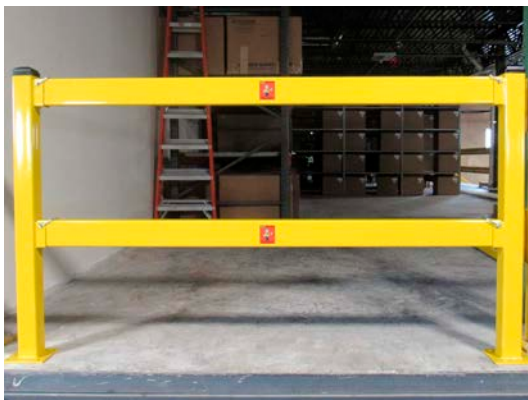

Ideal mezzanine protection



Quick release hardware for rails included

Safety Swing Gates

Ideal for stair openings, ladders and platforms. The "Save"ty Swing Gate bolts to existing rail opening to provide a one-way, self-closing gate. It is a simple and economical solution to comply with OSHA.

- Designed to fit hand railings.
- Carbon steel construction (1½" tubing).

Single & Double Gate

- Each gate has 2.5" adjustability.
- Double Gate has built in stop.
- Single Gate requires a post for strike plate.
- Opens 180 degrees.
- Available in Stainless Steel or Galvanized.

Swing Gate No.	Fits Clear Opening	Wing Gate Part #	Fits Clear Opening
SINGLE GATE		DOUBLE GATE	
SYP-PS-15	14" - 17.5"	SYP-PS-9D	16" - 22.5"
SYP-PS-18	17" - 20.5"	SYP-PS-12D	22" - 28.5"
SYP-PS-21	20" - 23.5"	SYP-PS-15D	28" - 34.5"
SYP-PS-24	23" - 26.5"	SYP-PS-18D	34" - 40.5"
SYP-PS-27	26" - 29.5"	SYP-PS-21D	40" - 46.5"
SYP-PS-30	29" - 32.5"	SYP-PS-24D	46" - 52.5"
SYP-PS-33	32" - 35.5"		
SYP-PS-36	35" - 38.5"		
SYP-PS-40	39" - 42.5"		
SYP-PS-44	43" - 46.5"		
SYP-PS-48	47" - 50.5"		

Twin Rail

Durable steel protection

- Great for mezzanine fall protection.
- 44" tall posts with a powder coated steel cap.
- 3" x 3" posts, with a 6" x 6" x 1/2" base plate.
- 4" tall x 2" wide rail is 1 1-gage high-tensile steel.
- Top rail is 42" high and meets OSHA fall protection.



PickerPal gate (optional 2nd bar shown)



Great 360 degree mezzanine protection



Bumper style

Mezzanine Safety Gates

We have four different styles of Mezzanine gates available to meet your needs - all are designed with fall protection per OSHA guidelines!

PickerPal Mezzanine Gates

- 6 self closing arms, operate independently.
- 6' or 8' width.
- Includes 8' tall rack frames and height limiter.
- MEETS OSHA & IBC REQUIREMENTS.

SavetyMezz360

For mezzanines or pick modules.

- Comes with 60" or 100" clear opening.
- Includes 4" safety toeboard.
- Complies with OSHA and ANSI standards.
- Utilizes a counter-balanced gate system and includes a slam-proof design.
- Easy to install and allows for one-handed operation.

Bumper Style Gates

- Standard Sizes: 60" or 72" clear opening width and clear opening height up to 84", includes gate columns, three (3) springs per gate, housed within hinge pivot.
- Teardrop Impact Bumpers: High-impact, ABS bumpers with 3" projection. Black.
- Specifications: High-impact, ABS adjustable 4" toe boards.
- MEETS OSHA & IBC REQUIREMENTS.



Mezzanine Gates

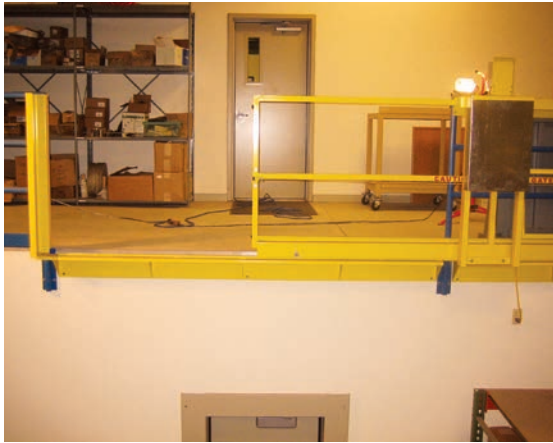

Horizontal sliding gate



Vertical lift gate



Pivot gate

Mezzanine Gates

The Horizontal Sliding Gate and the Vertical Lift Gate are designed to be durable, productive, provide the same protection as your railing systems, and meet federal OSHA requirements for standard railings.

- Easily slides open and closed.
- Manufactured to specific width requirements.
- Factory welded steel framework.
- Gates are 42" high, with one mid-rail and 4" toeboard.
- Electric or pneumatic operation available with remote control. Call for details.
- Easy Installation.



Pivot Gate

Single or Double width gates.



- All welded tubular steel frame.
- Easily pivots to up or down position.
- Requires only 10-20 lbs. of lift force depending on gate size.
- Made to order to fit your specific opening at no additional charge.
- Can ship completely assembled — simply anchors to mezzanine floor.
- MEETS OSHA & IBC REQUIREMENTS.



Lift Gates: 8', 10' & 12' clear opening

Dock Door Gates

Ideal for overhead doors. Great visibility to prevent accidents.

The "Save"ty Yellow Dock Gate is fabricated and bolts to post creating visibility. It is an economical and simple solution to comply with OSHA fall protection.

- Available in an 8', 10' and 12' clear opening.
- All sizes in stock.
- 42" tall at top of rail.
- New locking-pin design.
- Air actuation cylinder holds gate open during deliveries or shipments.

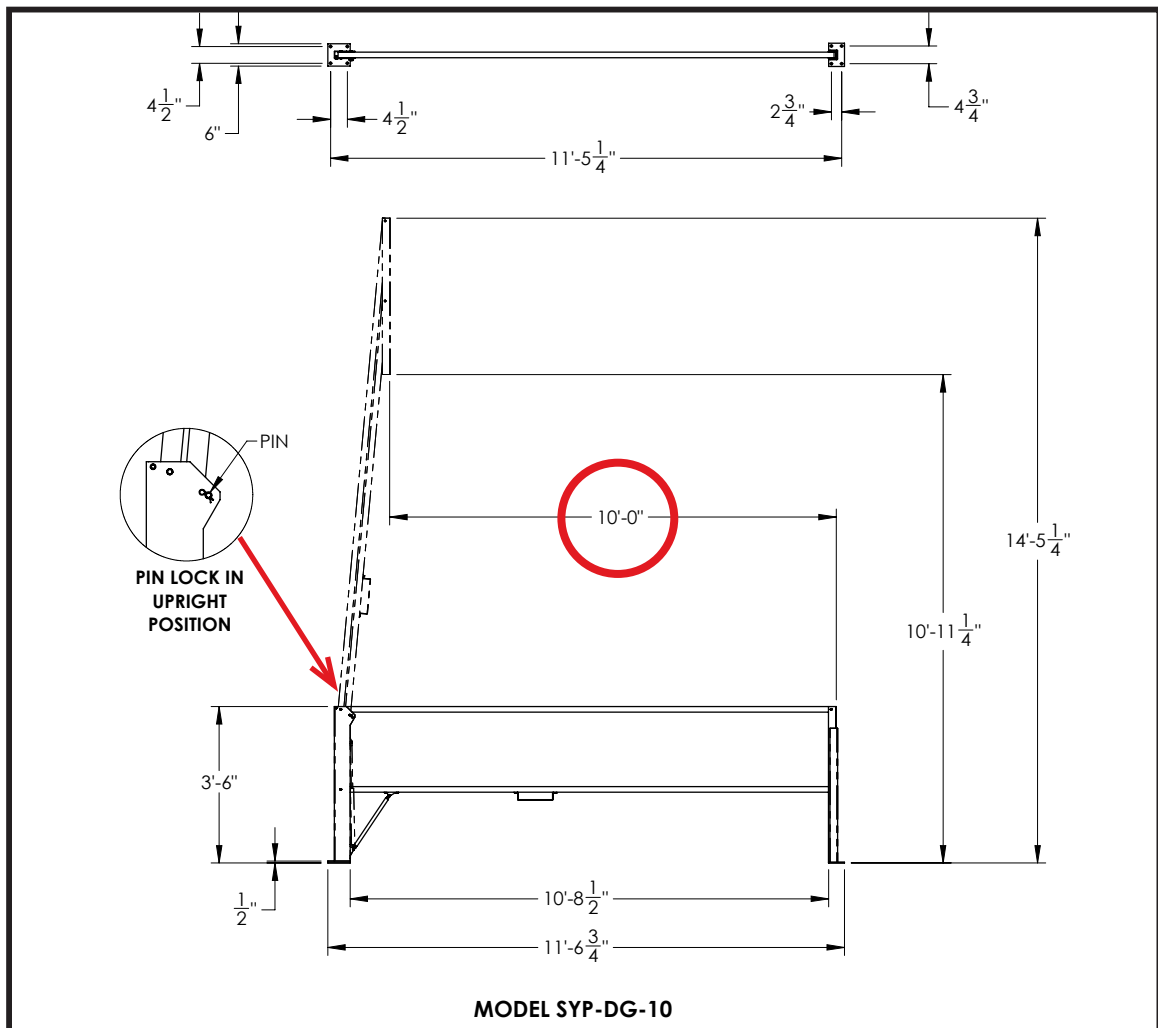

Dock Gates



Rotating gates: widths from 4' to 14'



Open dock



Driveway rotating gates: widths from 4' to 28'



NOTE: Gate sleeve is bollard supported

Rotating Dock Gate

Provides security, creates awareness and fall protection.

- Mounts over a 42" tall bollard which is required.
- Choose widths from 4' to 14'.
- Install two gates to meet in the center to accommodate space restrictions if needed.
- Add an optional bollard with eyelet at the opposite end for security.

Rotating Driveway Gate

Provides security, creates awareness.

- Mounts over a 42" tall bollard which is required.
- Choose widths from 4' to 28'.
- Install two gates to meet in the center to accommodate space restrictions if needed.
- Add an optional bollard with eyelet at the opposite end for security.

Gate Sleeves Are Bollard Supported!



POWDER
COATED
TOUGH™



CREATE A REAL BARRIER

- Stop fork trucks from driving or backing off the dock.
- Dock Stop includes two rotating arms.
- Includes two 42" bollards with 30" bollard available.
- Locking slide bars with locking pin.
- Impact rated for 4000 lbs at 4 mph.
- 8', 9', 10', 11' and 12' door sizes in stock.
- Built in height-levelers, so arms meet in the middle every time.



Dock Stop Gate



Use very little space around your dock



Impact rated for 4,000 lbs at 4 mph



Slide Bar Handle & Locking Pin



Perimeter Protection

A Complete Line of Perimeter Protection Products



Perimeter protection products can save you thousands from lift trucks bumping into walls, door tracks, water and electrical pipes. Protect your facility today for much less than the cost of damage.

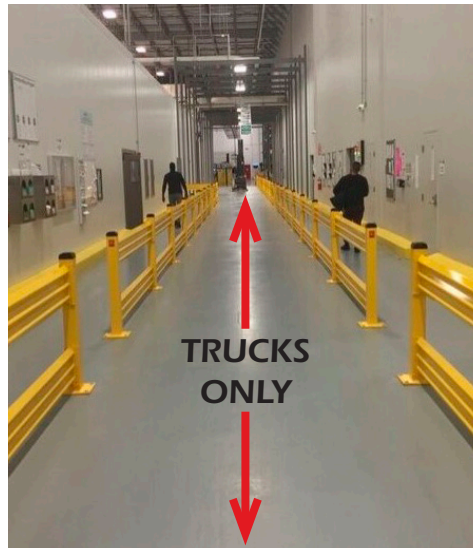

Our Products at Work



Guarding equipment



Door track guards



Guarding overhead conveyor



Dock gates

Application Photo Gallery

Applications are endless when you consider the amount of valuable assets that need protection.

Our products are securing many areas and are standing guard to protect the facilities and employees of small, medium and large corporations.

If you have an application that you would like to discuss, we will help you find the best solution to fit your needs. We have the experience and resources to assure that you and your facility will remain protected.

At "Save"ty Yellow Products it's our mission to help SAVE YOUR ASSETS!



Guarding electrical panels



Protecting rail dock



See page 6



See page 5



See page 12



See page 9

"Save"ty[®] Yellow Products



Protecting traffic lane

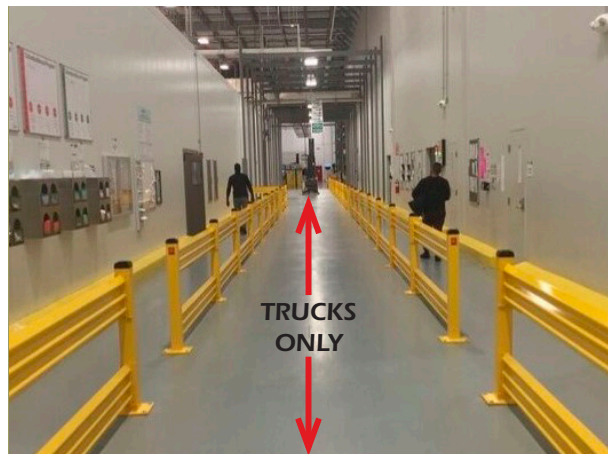

Safe Passage



Guarding battery racks



Rack guard round

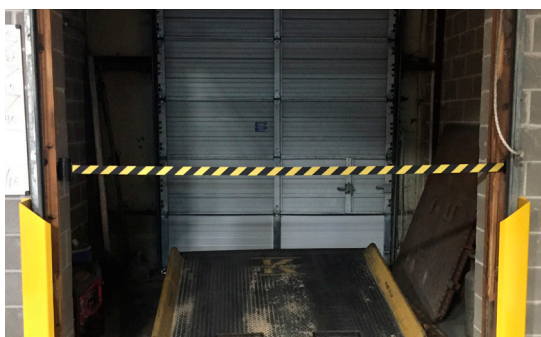

Safety Belting now available



See page 4

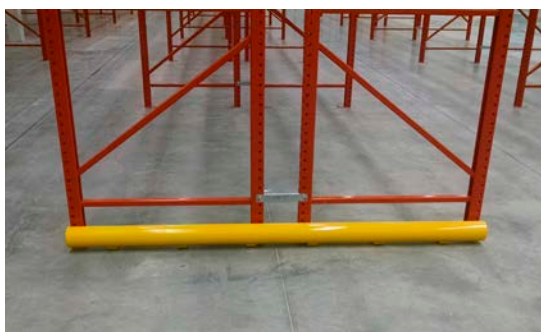

See page 10



See page 17

New Products

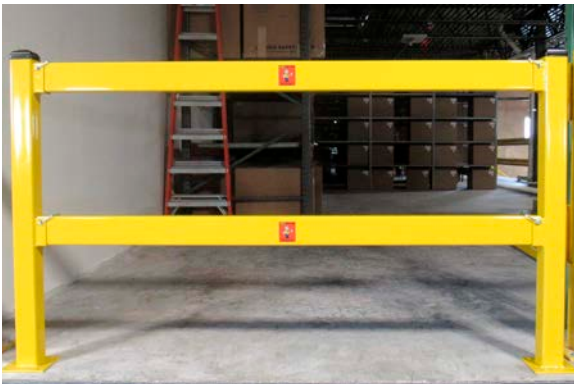

Twin Rail, See page 4



Dock Stop, See page 18



Great 360 degree mezzanine protection
See page 14



Building Column & Downspout Guard Rail
See page 9



Super Duty Rack Guard
See page 10



Super Duty - Three Mounting Holes
See page 10



Food Industry Closed Top
See page 7



Side Mount Protectors
See page 7



Economy Door Track
See page 11

"Save"ty[®]

Yellow Products

TOLL FREE: 877-728-3891 ▪ Local: 630-293-8013 ▪ Fax: 630-876-1993

3550 Legacy Blvd. ▪ St. Charles, IL 60174 ▪ sales@save-ty.com

www.save-ty.com



New Dealers Welcome!

While we have many dealers around the country, there's room for more! As a "Save"ty Yellow Products dealer you can expect sales support in a number of ways.

- ✓ "Save"ty Yellow Products has manufacturer's reps who can provide sales training as well as help with specific applications.
- ✓ Literature is available, both in print and pdf files.

- ✓ A Power Point presentation is available for dealer use.
- ✓ Website includes price guides and live chat for assistance (during business hours)
- ✓ Our products are advertised nationally.

Call for more information or for a quote. We are always open to discuss special applications.



Authorized Dealer:



printed in USA: MP57008