

Patton Aluminum Products, Inc.

Engineering Specifications
for
3", 4", and 6" Insulated
Patio Cover System

Prepared by:
Brad Doudican, P.E.
Doudican Engineering and Design, LLC
February 2013

All original documents on file at
Patton Aluminum Products, Inc.
65 Quick Road
New Carlisle, OH 45344

Patton Aluminum Products
65 Quick Road, New Carlisle, OH 45344
Ph. 937.845.9404, Fax 937.845.9424

Title: Cover Sheet
Scale: n/a
Date: 2-10-13

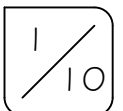

1. GENERAL NOTES

- a. THESE NOTES SHALL APPLY TO THE ARCHITECTURAL AND STRUCTURAL DRAWINGS UNLESS OTHERWISE SHOWN OR NOTED.
- b. THE CONTRACTOR SHALL CONDUCT ALL OPERATIONS IN STRICT ACCORDANCE WITH THE SAFETY REQUIREMENTS IMPOSED BY THE OWNER AND OSHA. IT IS SOLELY THE CONTRACTOR'S RESPONSIBILITY TO FOLLOW ALL APPLICABLE SAFETY CODES AND REGULATIONS GOVERNING THIS WORK.
- c. THIS STRUCTURE IS DESIGNED TO BE SELF-SUPPORTING AND STABLE AFTER IT IS FULLY COMPLETED. IT IS SOLELY THE CONTRACTOR'S RESPONSIBILITY TO DETERMINE ERECTION PROCEDURES AND SEQUENCES, AND TO ENSURE THE STABILITY OF THE STRUCTURE AND ITS COMPONENT PARTS, AND THE ADEQUACY OF TEMPORARY BRACING, GUYS, OR TIE-DOWNS THAT MIGHT BE NECESSARY. SUCH MATERIAL IS NOT SHOWN AND SHALL REMAIN THE CONTRACTOR'S PROPERTY.
- d. ALL DEVIATIONS FROM THE ENGINEERING DRAWINGS SHALL BE SUBMITTED IN WRITTEN FORM TO THE OWNER AND THEIR REPRESENTATIVE FOR APPROVAL.
- e. DIMENSIONS PERTAINING TO EXISTING CONDITIONS SHALL BE FIELD VERIFIED BY THE CONTRACTOR PRIOR TO ANY FABRICATIONS, CONSTRUCTION, OR ERECTION.

2. DESIGN DATA

- a. UNLESS OTHERWISE INDICATED, ALL DETAILS OF DESIGN, WORKMANSHIP, AND MATERIAL SHALL CONFORM TO THE RESIDENTIAL CODE OF OHIO FOR ONE-, TWO-, AND THREE-FAMILY DWELLINGS, LATEST EDITION. WHERE OTHERWISE NOT CONFORMING TO THIS CODE, DESIGN HAS BEEN PERFORMED IN ACCORDANCE WITH SECTION 301.1.3 "ENGINEERED DESIGN".
- b. DEAD LOAD = 10 PSF
- c. ROOF LIVE LOAD = 12 PSF
- d. GROUND SNOW LOAD - 20 PSF
- e. BUILDING CATEGORY - II
- f. BASIC DESIGN WIND SPEED - 115 M.P.H., EXPOSURE C
- g. IMPORTANCE FACTOR - 1.0
- h. ALLOWABLE SOIL BEARING - 1500 PSF
- i. SEISMIC DESIGN CATEGORY - B (DOES NOT GOVERN)

3. FOOTINGS AND FOUNDATIONS

- a. ALL FOOTINGS SHALL BEAR ON UNDISTURBED SOIL OR ENGINEERED FILL. EXCAVATIONS SHALL BE FREE OF LOOSE MATERIAL AND WATER. BEARING ELEVATION SHALL BE A MINIMUM OF 36-INCHES BELOW GRADE, UNLESS NOTED OTHERWISE (UNO).
- b. ALL CONCRETE FOUNDATIONS SHALL BE 3,000 PSI (28-DAY COMPRESSIVE STRENGTH CONCRETE) UNO.

4. ALUMINUM

- a. ALUMINUM MATERIALS SHALL BE 3003-H16 OR 6063-T6 OR OTHER ALUMINUM ALLOW APPROVED BY THE ENGINEER.
- b. ALUMINUM CONSTRUCTION AND DESIGN SHALL ADHERE TO "ALUMINUM DESIGN MANUAL" BY THE ALUMINUM ASSOCIATION (2010).
- c. ALL WELDING SHALL CONFORM WITH AWS D1.2 "STRUCTURAL WELDING CODE - ALUMINUM" (LATEST EDITION).

5. STRUCTURAL STEEL

- a. STRUCTURAL STEEL SHALL BE NEW.
- b. STRUCTURAL STEEL FOR BEAMS AND PLATES SHALL COMPLY WITH ASTM SPECIFICATION A-36. STRUCTURAL STEEL FOR STEEL COLUMNS SHALL COMPLY WITH ASTM SPECIFICATION A-53 GRADE B OR A-501. STRUCTURAL STEEL TUBING SHALL CONFORM TO ASTM A500 GRADE B.
- c. ALL DETAILING SHALL CONFORM TO CURRENT AISC SPECIFICATIONS.
- d. ALL WELDING SHALL CONFORM TO CURRENT AMERICAN WELDING SOCIETY SPECIFICATIONS FOR MATERIAL BEING WELDED AND BE PERFORMED BY CERTIFIED WELDERS.
- e. ALL BOLTS SHALL BE UNFINISHED ASTM A307, UNO.
- f. ALL STRUCTURAL STEEL AND MISCELLANEOUS IRON NOT ENCASED IN CONCRETE SHALL RECEIVE ONE SHOP COAT OF APPROVED PRIMER PAINT.

6. ENGINEERED LUMBER

- a. ENGINEERED LUMBER DOCUMENTS SHALL BE PREPARED BY A REGISTERED DESIGN PROFESSIONAL AND SHALL BE PROVIDED TO THE RESIDENCE DESIGNER AND THE BUILDING OFFICIAL, AND APPROVED BY BOTH PRIOR TO INSTALLATION.
- b. CONSTRUCTION DOCUMENTS SHALL INCLUDE, AT A MINIMUM, THE INFORMATION SPECIFIED BELOW.
 - b.a. LOCATION PLAN FOR EACH OF THE ENGINEERED LUMBER STRUCTURAL COMPONENTS.
 - b.b. DESIGN LOADS, SPAN, AND REACTION FORCE AND DIRECTION.
 - b.c. REQUIRED BEARING WIDTH.
 - b.d. DETAILS AND SPECIFICATIONS FOR ALL CONNECTORS AND ACCESSORIES.
 - b.e. REQUIRED PERMANENT MEMBER BRACING LOCATION, BRACE SIZES, AND REACTIONS.
 - b.c. REQUIRED CONSTRUCTION OR TEMPORARY BRACING AND SHORING AS NECESSARY.
 - b.d. IF SPECIFIED, PROVIDE MASONRY VENEER SUPPORT DETAILS INCLUDING CONNECTION TO ENGINEERED LUMBER AND REACTION FORCE AND DIRECTION.

7. MISCELLANEOUS

- a. ALL MATERIALS, SUPPLIES, AND EQUIPMENT TO BE INSTALLED AS PER MANUFACTURER'S SPECIFICATIONS AND AS PER LOCAL CODES AND REQUIREMENTS.

Patton Aluminum Products
65 Quick Road, New Carlisle, OH 45344
Ph. 937.845.9404, Fax 937.845.9424

Title: General Notes
Scale: n/a
Date: 2-10-13

NOTES

Job Information

Name: _____

Address: _____

Type of patio cover:

3" Insulated Panel 4" Insulated Panel 6" Insulated Panel

Type of column (wall thickness):

Extruded flat S-scroll (0.050)	<input type="checkbox"/> 8'	<input type="checkbox"/> 9'	<input type="checkbox"/> 10'
3x3 fluted (0.078)	<input type="checkbox"/> 8'	<input type="checkbox"/> 9'	<input type="checkbox"/> 10'
3x3 square (0.125)	<input type="checkbox"/> 8'	<input type="checkbox"/> 9'	<input type="checkbox"/> 10'

Number of columns: _____

Size of patio cover (ft.): _____ projection x _____ width

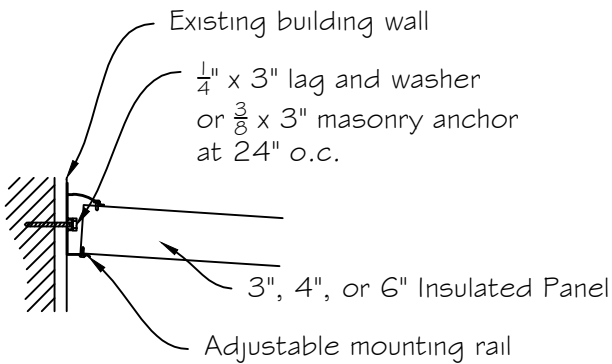

① Adjustable mounting rail to wall

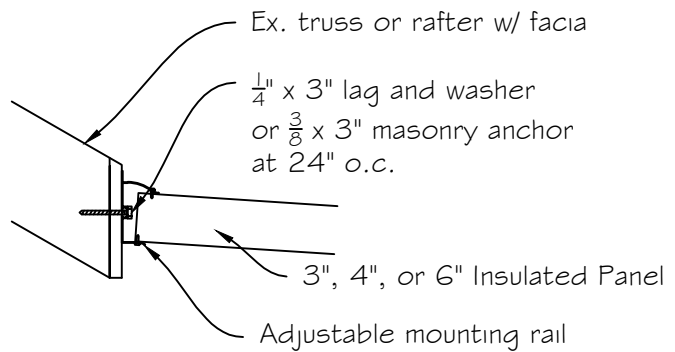

② Adjustable mounting rail to truss/rafter

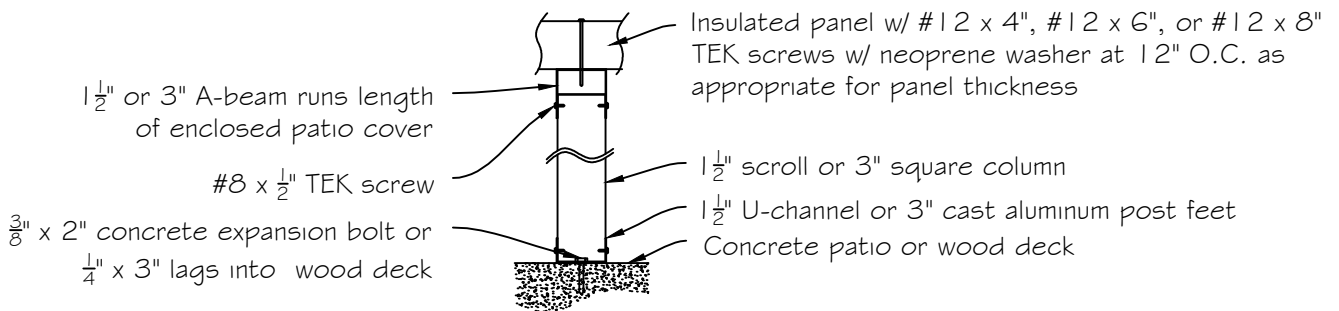

③ Column

Notes:

1. Fascia is attached to building wall with $\frac{1}{4}$ " (min.) diameter steel lag screws. Minimum penetration into supporting structure of $2\frac{1}{2}$ ". Washers are to be used between head of screws and fascia.
2. Footer to frost depth not required if columns are anchored securely to 4" concrete slab in good condition.

Patton Aluminum Products
65 Quick Road, New Carlisle, OH 45344
Ph. 937.845.9404, Fax 937.845.9424

Title: Job Description and Details
Scale: n/a
Date: 2-10-13

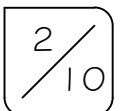

How to use this package:

1. Choose insulated panel type by roof load and deflection, Sheets 8/10 and 9/10.
2. Choose desired column and beam configuration, Sheet 3/10.
3. Determine panel dead load and roof live load.
4. Enter appropriate Beam and Column Load Table, Sheets 4/10 through 7/10, with roof loading and configuration. Determine allowable column spacing and resulting column load.
5. Check column capacity relative to column allowable load provided on Sheet 3/10.

Column Allowable Loads (lbs)			
Type	Height (ft)		
	8	9	10
Extruded aluminum scroll	1134	896	726
Extruded aluminum 3x3 fluted	4041	3725	3017
Extruded aluminum 3x3 square	11055	8735	7075

Column and Beam Configurations

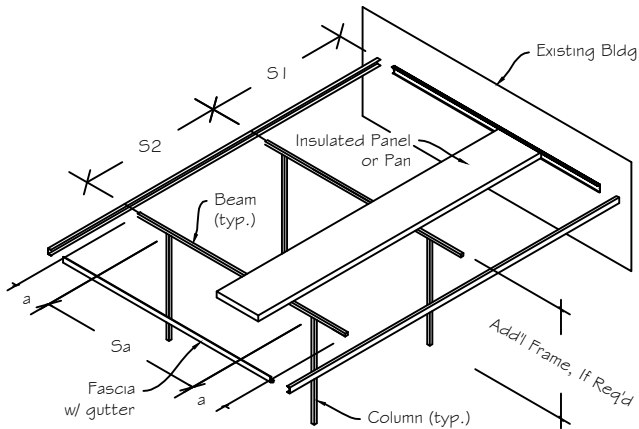

Configuration 1

Description: Two columns with center beam span "Sa", with cantilevered span of length "a" supported by beam/fascia system on each side. Maximum distance between A-beam and fascia w/ gutter to be 12".

Configuration 2

Description: Three columns with beam spans "Sb". Maximum distance between A-beam and fascia w/ gutter to be 12".

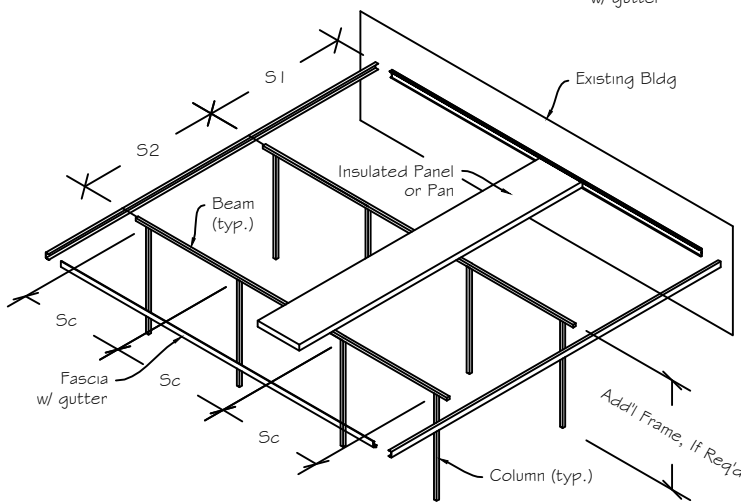
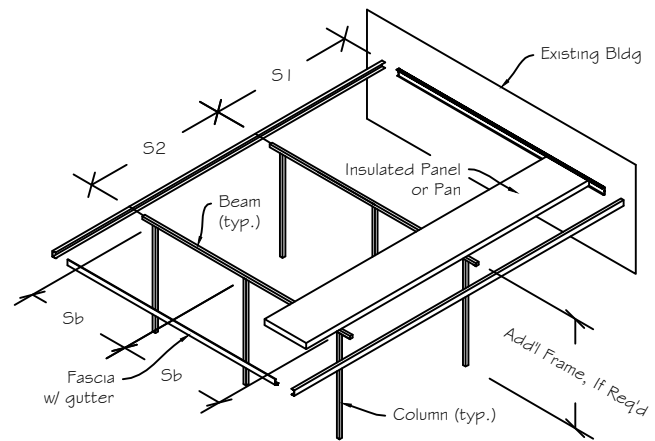

Configuration 3

Description: Four columns with beam spans "Sc". Maximum distance between A-beam and fascia w/ gutter to be 12".

Note: Use Configuration 3 for any scenario with 3 or more beam spans.

Note: For all Configurations, installer shall be permitted to provide 18" cantilever of beam and pan at each side of patio cover.

Patton Aluminum Products
65 Quick Road, New Carlisle, OH 45344
Ph. 937.845.9404, Fax 937.845.9424

Title: Design and Configurations
Scale: n/a
Date: 2-10-13

3/10

Load Tables for A-beam and Gutter Fascia Combination

Supplemental Data: 6063-T6 Aluminum, E = 10,100 ksi, Moment of Inertia = 4.54 I in⁴

Projection (ft)	DL + LL (psf) = 20				DL + LL (psf) = 25				Configuration 1		Configuration 2		Configuration 3		
	Beam Load, Wb (lb/ft)	a (ft)	Sa (ft)	Column Load (lb)	Sb (ft)	Column Load (lb)	Sc (ft)	Column Load (lb)	Projection (ft)	Beam Load, Wb (lb/ft)	a (ft)	Sa (ft)	Column Load (lb)	Sb (ft)	Column Load (lb)
4	53.3	5.9	16.7	323.3	11.8	629.9	13.2	704.3	4	66.7	5.3	14.9	359.6	10.6	704.3
5	62.5	5.5	15.4	348.7	10.9	681.9	12.2	762.4	5	78.1	4.9	13.8	388.1	9.8	762.4
6	72.0	5.1	14.4	373.1	10.2	731.9	11.4	818.3	6	90.0	4.5	12.9	415.6	9.1	818.3
7	81.7	4.8	13.5	396.5	9.5	779.5	10.7	871.5	7	102.1	4.3	12.1	441.8	8.5	871.5
8	91.4	4.5	12.8	418.8	9.0	824.8	10.1	922.1	8	114.3	4.0	11.4	466.8	8.1	922.1
9	101.3	4.3	12.1	440.0	8.6	867.9	9.6	970.4	9	126.6	3.8	10.8	490.6	7.7	970.4
10	111.1	4.1	11.6	460.4	8.2	909.2	9.1	1016.5	10	138.9	3.7	10.4	513.4	7.3	1016.5
11	121.0	3.9	11.1	479.9	7.8	948.8	8.8	1060.8	11	151.3	3.5	9.9	535.4	7.0	1060.8
12	130.9	3.8	10.7	498.8	7.5	986.9	8.4	1103.4	12	163.6	3.4	9.5	556.5	6.7	1103.4
13	140.8	3.6	10.3	516.9	7.3	1023.6	8.1	1144.4	13	176.0	3.3	9.2	576.8	6.5	1144.4
14	150.8	3.5	9.9	534.5	7.0	1059.1	7.9	1184.1	14	188.5	3.1	8.9	596.5	6.3	1184.1
15	160.7	3.4	9.6	551.6	6.8	1093.5	7.6	1222.6	15	200.9	3.0	8.6	615.6	6.1	1222.6
16	170.7	3.3	9.3	568.1	6.6	1126.8	7.4	1259.8	16	213.3	3.0	8.4	634.1	5.9	1259.8
17	180.6	3.2	9.1	584.2	6.4	1159.2	7.2	1296.1	17	225.8	2.9	8.1	652.1	5.7	1296.1
18	190.6	3.1	8.8	599.8	6.2	1190.8	7.0	1331.3	18	238.2	2.8	7.9	669.6	5.6	1331.3
19	200.6	3.0	8.6	615.1	6.1	1221.5	6.8	1365.7	19	250.7	2.7	7.7	686.7	5.4	1365.7
20	210.5	3.0	8.4	630.0	5.9	1251.5	6.6	1399.2	20	263.2	2.7	7.5	703.4	5.3	1399.2

Note: Deflection should be checked against relevant Building Code.

Load Tables for A-beam and Gutter Fascia Combination

Supplemental Data: 6063-T6 Aluminum, E = 10,100 ksi, Moment of Inertia = 4.54 in⁴

Projection (ft)	DL + LL (psf) = 30				DL + LL (psf) = 35				Configuration 2		Configuration 3						
	Configuration 1		Configuration 2		Configuration 3		Configuration 1		Configuration 2		Configuration 3						
	Beam Load, Wb (lb/ft)	a (ft)	Sa (ft)	Column Load (lb)	Sb (ft)	Column Load (lb)	Sc (ft)	Column Load (lb)	Projection (ft)	Beam Load, Wb (lb/ft)	a (ft)	Sa (ft)	Column Load (lb)	Sb (ft)	Column Load (lb)	Sc (ft)	Column Load (lb)
4	80.0	4.8	13.6	392.6	9.6	771.5	10.8	862.6	4	93.3	4.5	12.6	423.0	8.9	833.3	10.0	931.7
5	93.8	4.5	12.6	423.9	8.9	835.2	10.0	933.7	5	109.4	4.1	11.7	456.9	8.2	902.1	9.2	1008.6
6	108.0	4.1	11.7	454.1	8.3	896.4	9.3	1002.2	6	126.0	3.8	10.9	489.5	7.7	968.2	8.6	1082.5
7	122.5	3.9	11.0	482.8	7.8	954.7	8.7	1067.4	7	142.9	3.6	10.2	520.7	7.2	1031.2	8.1	1152.9
8	137.1	3.7	10.4	510.3	7.4	1010.1	8.2	1129.3	8	160.0	3.4	9.6	550.3	6.8	1091.1	7.6	1219.8
9	151.9	3.5	9.9	536.4	7.0	1063.0	7.8	1188.5	9	177.2	3.2	9.2	578.7	6.5	1148.2	7.2	1283.7
10	166.7	3.3	9.4	561.5	6.7	1113.6	7.5	1245.0	10	194.4	3.1	8.7	605.8	6.2	1202.8	6.9	1344.7
11	181.5	3.2	9.1	585.6	6.4	1162.0	7.2	1299.2	11	211.8	3.0	8.4	631.8	5.9	1255.2	6.6	1403.3
12	196.4	3.1	8.7	608.7	6.2	1208.7	6.9	1351.4	12	229.1	2.8	8.1	656.8	5.7	1305.5	6.4	1459.6
13	211.3	3.0	8.4	631.0	5.9	1253.7	6.6	1401.7	13	246.5	2.7	7.8	680.9	5.5	1354.1	6.1	1514.0
14	226.2	2.9	8.1	652.6	5.7	1297.1	6.4	1450.3	14	263.8	2.7	7.5	704.3	5.3	1401.1	5.9	1566.5
15	241.1	2.8	7.9	673.5	5.6	1339.2	6.2	1497.3	15	281.3	2.6	7.3	726.9	5.1	1446.5	5.8	1617.3
16	256.0	2.7	7.6	693.9	5.4	1380.1	6.0	1543.0	16	298.7	2.5	7.1	748.9	5.0	1490.7	5.6	1666.6
17	270.9	2.6	7.4	713.6	5.2	1419.8	5.9	1587.4	17	316.1	2.4	6.9	770.2	4.9	1533.5	5.4	1714.5
18	285.9	2.6	7.2	732.8	5.1	1458.4	5.7	1630.6	18	333.5	2.4	6.7	791.0	4.7	1575.3	5.3	1761.2
19	300.8	2.5	7.0	751.5	5.0	1496.1	5.6	1672.6	19	351.0	2.3	6.5	811.2	4.6	1615.9	5.1	1806.7
20	315.8	2.4	6.9	769.8	4.9	1532.8	5.4	1713.7	20	368.4	2.2	6.4	831.0	4.5	1655.6	5.0	1851.0

Note: Deflection should be checked against relevant Building Code.

Load Tables for 2x8 Extruded Built-Up Beam

Supplemental Data: 6063-T6 Aluminum, E = 10,100 ksi, Moment of Inertia = 9.137 in⁴

Projection n (ft)	DL + LL (psf) = 20		DL + LL (psf) = 25		Projection (ft)	Beam Load, Wb (lb/ft)	Configuration 1			Configuration 2			Configuration 3				
	Configuration 1		Configuration 2				Configuration 1		Configuration 2		Configuration 3						
	a (ft)	Sa (ft)	Column Load (lb)	Sb (ft)			Column Load (lb)	Sc (ft)	Column Load (lb)	Sb (ft)	Column Load (lb)	Sc (ft)	Column Load (lb)				
4	53.3	10.3	30.2	564.0	20.6	1097.8	23.0	1227.3	4	66.7	9.2	27.0	627.2	18.4	1227.3	20.6	1372.2
6	72.0	8.9	26.0	650.7	17.7	1275.5	19.8	1426.0	6	90.0	7.9	23.3	724.7	15.8	1426.0	17.7	1594.4
8	91.4	7.9	23.1	730.2	15.7	1437.3	17.6	1607.0	8	114.3	7.0	20.6	813.8	14.1	1607.0	15.7	1796.6
10	111.1	7.1	20.9	802.7	14.3	1584.5	15.9	1771.5	10	138.9	6.4	18.7	895.1	12.8	1771.5	14.3	1980.6
12	130.9	6.6	19.3	869.6	13.1	1719.9	14.7	1922.9	12	163.6	5.9	17.3	970.1	11.8	1922.9	13.1	2149.8
14	150.8	6.1	18.0	931.8	12.2	1845.7	13.7	2063.6	14	188.5	5.5	16.1	1039.8	10.9	2063.6	12.2	2307.2
16	170.7	5.8	16.9	990.3	11.5	1963.7	12.9	2195.5	16	213.3	5.1	15.1	1105.3	10.3	2195.5	11.5	2454.7
18	190.6	5.4	16.0	1045.6	10.9	2075.2	12.2	2320.1	18	238.2	4.9	14.3	1167.2	9.7	2320.1	10.9	2594.0
20	210.5	5.2	15.2	1098.1	10.4	2181.0	11.6	2438.5	20	263.2	4.6	13.6	1226.0	9.3	2438.5	10.4	2726.3
	DL + LL (psf) = 30		DL + LL (psf) = 35														
Projection n (ft)	DL + LL (psf) = 30		DL + LL (psf) = 35		Projection (ft)	Beam Load, Wb (lb/ft)	Configuration 1			Configuration 2			Configuration 3				
	Configuration 1		Configuration 2				Configuration 1		Configuration 2		Configuration 3						
	a (ft)	Sa (ft)	Column Load (lb)	Sb (ft)			Column Load (lb)	Sc (ft)	Column Load (lb)	Sb (ft)	Column Load (lb)	Sc (ft)	Column Load (lb)				
4	80.0	8.4	24.7	684.6	16.8	1344.5	18.8	1503.2	4	93.3	7.8	22.8	737.5	15.6	1452.2	17.4	1623.6
6	108.0	7.2	21.2	791.7	14.5	1562.1	16.2	1746.5	6	126.0	6.7	19.7	853.5	13.4	1687.3	15.0	1886.5
8	137.1	6.4	18.8	889.6	12.8	1760.3	14.4	1968.1	8	160.0	5.9	17.4	959.4	11.9	1901.4	13.3	2125.8
10	166.7	5.8	17.1	978.8	11.6	1940.6	13.0	2169.7	10	194.4	5.4	15.8	1056.0	10.8	2096.1	12.1	2343.5
12	196.4	5.4	15.7	1061.1	10.7	2106.4	12.0	2355.0	12	229.1	5.0	14.6	1144.9	9.9	2275.2	11.1	2543.7
14	226.2	5.0	14.7	1137.6	10.0	2260.5	11.2	2527.4	14	263.8	4.6	13.6	1227.6	9.3	2441.7	10.3	2729.9
16	256.0	4.7	13.8	1209.4	9.4	2405.1	10.5	2689.0	16	298.7	4.3	12.8	1305.3	8.7	2597.8	9.7	2904.4
18	285.9	4.4	13.1	1277.3	8.9	2541.6	9.9	2841.6	18	333.5	4.1	12.1	1378.7	8.2	2745.2	9.2	3069.3
20	315.8	4.2	12.4	1341.8	8.5	2671.2	9.5	2986.5	20	368.4	3.9	11.5	1448.4	7.8	2885.2	8.8	3225.8

Note: Deflection should be checked against relevant Building Code.

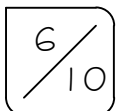

Load Tables for 2x8 Extruded Built-Up Beam w/ Multiple Frames

Supplemental Data: 6063-T6 Aluminum, E = 10,100 ksi, Moment of Inertia = 9.137 in^4 , $W1 = \frac{S1}{2} + \frac{S2}{2}$, $W2 = \frac{S2}{2} + 1$

		DL + LL (psf) = 20		DL + LL (psf) = 25											
Max of W1 or W2 (ft)	Beam Load, Wb (lb/ft)	Configuration 1		Configuration 2		Configuration 3		Configuration 1		Configuration 2		Configuration 3			
		a (ft)	Sa (ft)	Column Load (lb)	Sb (ft)	Column Load (lb)	Sc (ft)	Column Load (lb)	a (ft)	Sa (ft)	Column Load (lb)	Sb (ft)	Column Load (lb)	Sc (ft)	
4	80.0	8.4	24.7	684.6	16.8	1344.5	18.8	1503.2	7.5	22.1	762.6	15.0	1503.2	16.8	1680.6
6	120.0	6.9	20.1	833.4	13.7	1646.6	15.3	1841.0	6.1	18.0	929.5	12.3	1841.0	13.7	2058.3
8	160.0	5.9	17.4	959.4	11.9	1901.4	13.3	2125.8	5.3	15.6	1070.7	10.6	2125.8	11.9	2376.7
10	200.0	5.3	15.6	1070.7	10.6	2125.8	11.9	2376.7	4.8	14.0	1195.3	9.5	2376.7	10.6	2657.3
12	240.0	4.9	14.2	1171.5	9.7	2328.7	10.8	2603.6	4.3	12.7	1308.2	8.7	2603.6	9.7	2910.9
14	280.0	4.5	13.2	1264.2	9.0	2515.3	10.0	2812.2	4.0	11.8	1412.0	8.0	2812.2	9.0	3144.1
16	320.0	4.2	12.3	1350.7	8.4	2689.0	9.4	3006.4	3.8	11.0	1508.7	7.5	3006.4	8.4	3361.2
18	360.0	4.0	11.6	1431.9	7.9	2852.1	8.9	3188.7	3.5	10.4	1599.6	7.1	3188.7	7.9	3565.1
20	400.0	3.8	11.0	1508.7	7.5	3006.4	8.4	3361.2	3.4	9.9	1685.5	6.7	3361.2	7.5	3757.9
DL + LL (psf) = 30															
DL + LL (psf) = 35															
Max of W1 or W2 (ft)	Beam Load, Wb (lb/ft)	Configuration 1		Configuration 2		Configuration 3		Configuration 1		Configuration 2		Configuration 3			
		a (ft)	Sa (ft)	Column Load (lb)	Sb (ft)	Column Load (lb)	Sc (ft)	Column Load (lb)	a (ft)	Sa (ft)	Column Load (lb)	Sb (ft)	Column Load (lb)		
4	120.0	6.9	20.1	833.4	13.7	1646.6	15.3	1841.0	6.4	18.7	898.6	12.7	1778.6	14.2	1988.5
6	180.0	5.6	16.4	1016.6	11.2	2016.7	12.5	2254.8	5.2	15.2	1096.8	10.4	2178.3	11.6	2435.4
8	240.0	4.9	14.2	1171.5	9.7	2328.7	10.8	2603.6	4.5	13.2	1264.2	9.0	2515.3	10.0	2812.2
10	300.0	4.3	12.7	1308.2	8.7	2603.6	9.7	2910.9	4.0	11.8	1412.0	8.0	2812.2	9.0	3144.1
12	360.0	4.0	11.6	1431.9	7.9	2852.1	8.9	3188.7	3.7	10.8	1545.7	7.3	3080.6	8.2	3444.2
14	420.0	3.7	10.8	1545.7	7.3	3080.6	8.2	3444.2	3.4	10.0	1668.7	6.8	3327.4	7.6	3720.2
16	480.0	3.4	10.1	1651.7	6.9	3293.3	7.7	3682.0	3.2	9.3	1783.2	6.4	3557.2	7.1	3977.0
18	540.0	3.2	9.5	1751.3	6.5	3493.1	7.2	3905.4	3.0	8.8	1890.9	6.0	3772.9	6.7	4218.3
20	600.0	3.1	9.0	1845.5	6.1	3682.0	6.9	4116.6	2.8	8.3	1992.7	5.7	3977.0	6.4	4446.5

Note: Deflection should be checked against relevant Building Code.

Patton Aluminum Products
65 Quick Road, New Carlisle, OH 45344
Ph. 937.845.9404, Fax 937.845.9424

Title: Column and Beam Tables
Scale: n/a
Date: 2-10-13



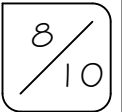

Insulated Panel Load and Deflection Data												
Projection (ft)	3" Polycore Snaplock Panel			4" Polycore Snaplock Panels			6" Polycore Snaplock Panels			3" Polycore Panels with H-bars		
	Ultimate Load (psf)	L/180 (psf)	L/240 (psf)	Ultimate Load (psf)	L/180 (psf)	L/240 (psf)	Ultimate Load (psf)	L/180 (psf)	L/240 (psf)	Ultimate Load (psf)	L/180 (psf)	L/240 (psf)
10	70.0	20.0	15.0	85.0	27.0	15.0	127.8	40.0	30.0	--	45.0	37.0
11	60.0	17.0	13.0	75.0	23.5	13.0	122.5	38.0	28.5	--	38.0	32.0
12	50.0	14.0	10.6	65.0	20.0	10.6	112.0	35.0	26.0	--	31.0	27.0
13	44.5	12.2	9.0	59.0	18.0	9.0	99.8	31.0	23.0	--	26.0	23.0
14	40.0	11.0	8.0	53.0	17.0	8.0	91.0	28.0	21.0	--	22.0	20.0
15	33.0	9.5	7.0	43.0	13.4	7.0	78.8	24.0	18.0	--	18.0	16.0
16	25.0	7.5	5.8	33.5	10.0	5.8	65.5	20.0	15.0	--	15.0	13.0
17	20.5	--	--	26.8	--	--	52.0	--	--	--	--	--
18	16.0	--	--	21.0	--	--	41.6	--	--	--	--	--
19	13.0	--	--	17.0	--	--	30.0	--	--	--	--	--
20	10.7	--	--	13.7	--	--	18.0	--	--	--	--	--

Mechanical properties of materials for this chart:

Aluminum skin
 Alloy = 3003 H14
 t = 0.024 in
 D = 165 psf
 E = 10×10^6 psi
 F1 = 20.3 ksi

ultimate = 16.7 ksi yield
 Fy = 13.8 ksi

Core expanded styrene
 D = 1.5 pct
 E = 320 - 360 psi
 G = 460 - 500 psi
 F1 = 40 - 50 psi
 Fy = 18 - 22 psi

Aluminum extrusions
 Alloy = 6061-T6
 T = 42 ksi

Oriented strand board (OSB)

MR = 644 psi
 E = 7.24×10^3

Where:

E = Modulus of elasticity
 G = Modulus of

rigidity
 F = Allowable stress
 T = Tension
 MR = Modulus of rupture

Insulated Panel Load and Deflection Data

Projection (ft)	3" Polycore/OSB Snaplock Panel			4" Polycore/OSB Snaplock Panels			6" Polycore/OSB Snaplock Panels			3" 5 Ply OSB Panels with H-bars		
	Ultimate Load (psf)	L/180 (psf)	L/240 (psf)	Ultimate Load (psf)	L/180 (psf)	L/240 (psf)	Ultimate Load (psf)	L/180 (psf)	L/240 (psf)	Ultimate Load (psf)	L/180 (psf)	L/240 (psf)
10	150.0	26.3	19.7	165.0	43.4	33.0	187.5	68.7	58.0	--	49.0	42.0
11	135.0	23.0	17.6	147.5	39.0	30.5	170.0	62.5	52.0	--	42.0	36.0
12	120.0	19.7	14.9	132.5	36.0	28.0	152.5	58.3	46.8	--	35.0	30.0
13	107.5	17.8	14.0	121.3	32.0	25.6	140.0	50.0	41.6	--	28.6	23.7
14	95.0	16.5	12.0	112.5	27.9	21.8	132.5	45.8	36.4	--	24.3	20.2
15	77.5	13.0	10.0	100.0	23.9	18.0	125.0	38.5	30.2	--	20.7	17.2
16	60.0	8.4	6.5	87.5	19.8	14.4	116.0	34.0	27.0	--	17.0	14.0
17	48.0	--	--	72.0	--	--	95.0	--	--	--	--	--
18	38.4	--	--	59.0	--	--	78.0	--	--	--	--	--
19	30.7	--	--	48.0	--	--	64.0	--	--	--	--	--
20	25.0	--	--	39.7	--	--	52.5	--	--	--	--	--

Mechanical properties of materials for this chart:

Aluminum skin

Alloy = 3003 H14
 t = 0.024 in
 D = 165 psf
 $E = 10 \times 10^6$ psi
 F1 = 20.3 ksi ultimate
 = 16.7 ksi yield
 Fy = 13.8 ksi

Core expanded styrene

D = 1.5 pcf
 E = 320 - 360 psi
 G = 460 - 500 psi
 F1 = 40 - 50 psi
 Fy = 18 - 22 psi

Aluminum extrusions

Alloy = 6061-T6
 T = 42 ksi

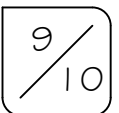

Panel Sections

3" Snaplock Panel
Panel DL: 4.3 plf

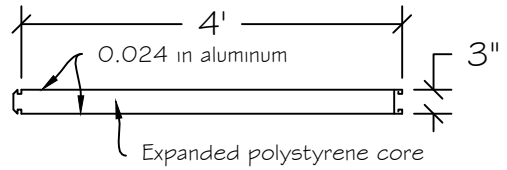

4" Snaplock Panel
Panel DL: 4.8 plf

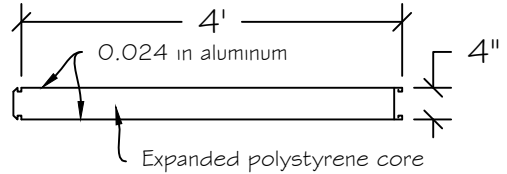

6" Snaplock Panel
Panel DL: 5.8 plf

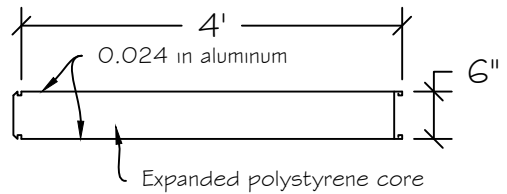

3" OSB Overlap with Snaplock Bottom
Panel DL: 10.0 plf

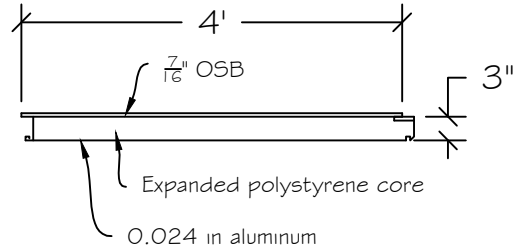

3" 4 Ply OSB Snaplock Panel
Panel DL: 11.8 plf

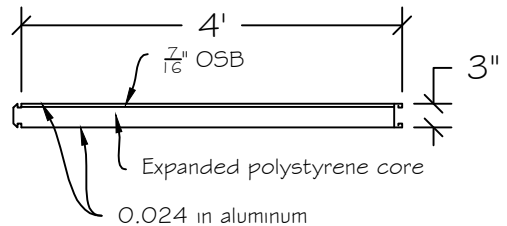

4" 4 Ply OSB Snaplock Panel
Panel DL: 12.0 plf

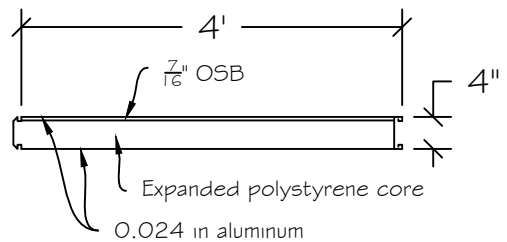

6" 4 Ply OSB Snaplock Panel
Panel DL: 12.0 plf

