



2019 HARDSCAPE TECHNICAL GUIDE



ROSETTA™
by Brown's

NORTHFACE
by Brown's

Signature
by Brown's

www.brownsconcrete.com

MADE STRONG WITH THE FINEST GRANITE AGGREGATE

DRY CAST PAVER COLLECTION

Page #

AMBERLEY	1
APPIAN	2
AZTEC	3
ATHENIAN	4
AVENNIO	5
NORDIC	6
AQUAPAVE	7
COLONIAL	8
VENETIAN/VENETIAN CLASSIC	9
VENETIAN/VENETIAN CLASSIC CIRCLE	10
BELGIUM	11,12
CUSTOM PAVERS & SIGNATURE CURBS	13
PAVER INSTALLATION 1	14
PAVER INSTALLATION 2	15
PARKWALL	16
PARKWALL CLASSIC	17
WEDGESTONE/WEDGESTONE CLASSIC	18
DIMENSIONAL CLASSIC	19
PISA LIGHT	20
BUILDING CURVES WITH PISA LIGHT	21
SIGNATURE FIRE PIT KITS	22

WET CAST PAVER COLLECTION

ROCKTON	23
NORTHFACE	24
BELVEDERE "BLOCK DETAILS"	25
BELVEDERE "COPING DETAILS"	26
DIMENSIONAL WALL	27
OUTCROPPING "BLOCK DETAILS"	28

WET CAST PAVER COLLECTION

Page #

OUTCROPPING "CORNER BLOCK DETAILS"	29
FREESTANDING PALLETS	29
RANDOM STEPS	30
DIMENSIONAL STEPS	31
STONE EDGE CURB	31
SUPERIOR STEPPERS	32
GRAND FLAGSTONE	33
DIMENSIONAL FLAGSTONE	34
AMARO	35
FIRE PITS (BELVEDERE, DIMENSIONAL WALL, ROCKTON)	36
FIREPLACES	37
DIMENSIONAL COPING AND CAPS	38

INSTALLATION INSTRUCTIONS

RETAINING WALL INSTALLATION	40-45
OUTCROPPING RETAINING & FREESTANDING WALLS	46-47
OUTCROPPING CURVES	48
OUTCROPPING PATTERNS	49
BELVEDERE RETAINING WALL INSTALLATION	50
BELVEDERE CURVES INSTALLATION	51
BELVEDERE PILLARS INSTALLATION	52
BELVEDERE PATTERNS INSTALLATION	53
FLAGSTONE & PAVER INSTALLATION	54
GRAND FLAGSTONE INSTALLATION	55,56
DIMENSIONAL FLAGSTONE INSTALLATION	57
ROCKTON FREESTANDING WALL INSTALLATION	58
STEP INSTALLATION	59
AREA CALCULATIONS CHART	60

AMBERLEY PAVER

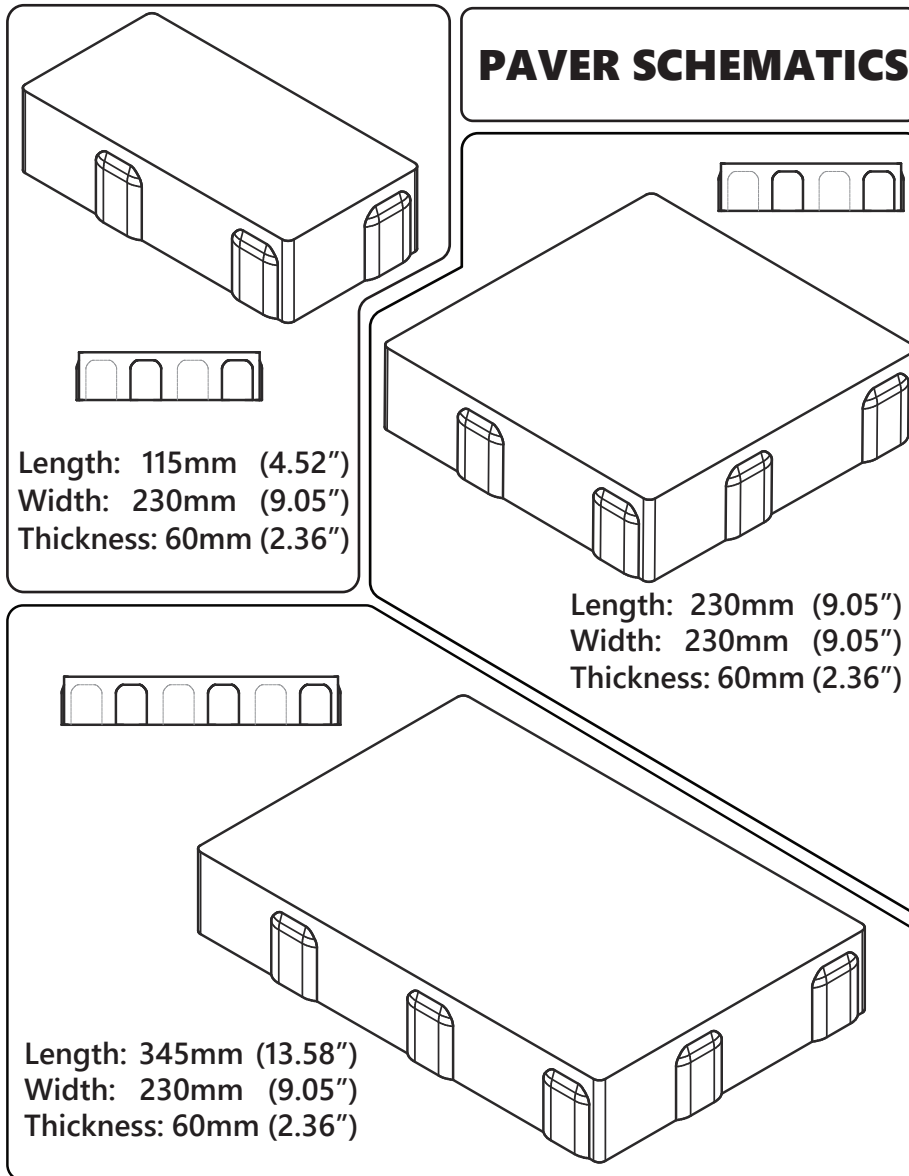

RANDOM PATTERN 1

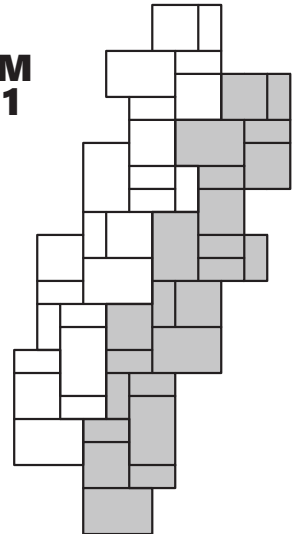

RANDOM PATTERN 2

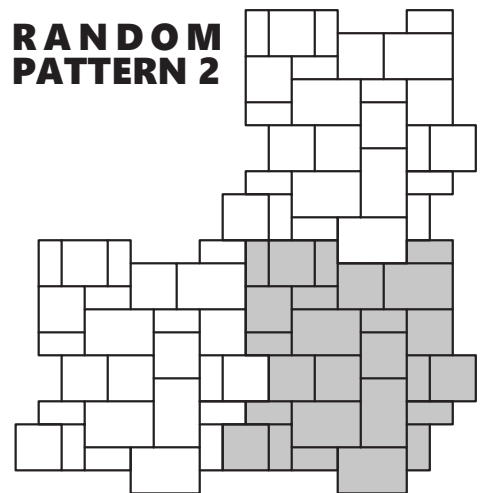

*Linear Patterns Available

Application: Patios, Walkways, Residential Driveways, Commercial Pedestrian.

Caution: A rubber pad must be used with a compactor. Snow removal equipment without a poly (rubber) edge will scar /damage the product surface due to the textured finish.

Amberley 60mm	
Sq. ft. per Bundle	127.8
Sq. Ft. per Layer	12.8
Layers per Bundle	10
Weight per Bundle	3,514 lbs / 1,594 kg

AMBERLEY PALLET LAYER

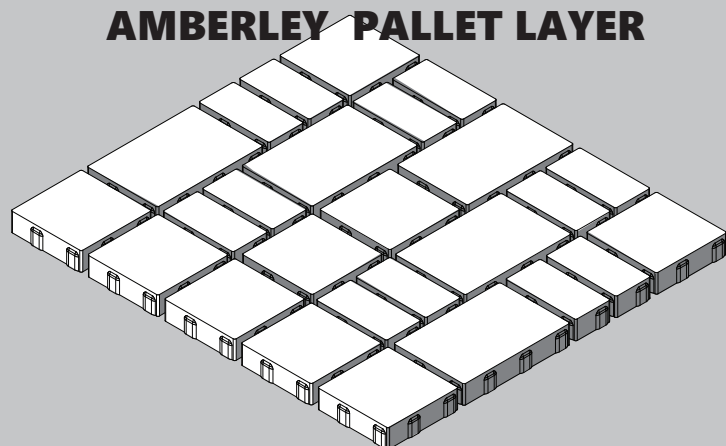

APPIAN 70 & APPIAN 50

Appian Stone is a large scale paver with a gently rolling texture reflective of natural cut flag.



Small Rectangle

Length: 330mm (13")
Width: 165mm (6.5")



Square

Length: 330mm (13")
Width: 330mm (13")



Large Rectangle

Length: 495mm (19.5")
Width: 330mm (13")

Appian Stone Pavers 70mm *Bundle contains 9 Layers. Sold in full bundles only.*

70 mm Thickness	Full Cube	Small Rectangle	Square	Large Rectangle
Sq. Ft./Bundle	95.6	21	42.1	32.5
Stones per Sq. Ft	-	1.7	0.85	0.56
Stones per Bundle	90	36	36	18
Weight per Bundle	3,250 lbs / 1,477 kg	-	-	-
Stones per Layer	-	4	4	2

Appian Stone Pavers 50mm *Bundle contains 9 Layers. Sold in full bundles only.*

50 mm Thickness	Full Cube	Small Rectangle	Square	Large Rectangle
Sq. Ft./Bundle	127.4	28.2	56.5	42.7
Stones per Sq. Ft	-	1.7	-	0.56
Stones per Bundle	120	48	48	24
Weight per Bundle	3,075 lbs / 1,395 kg	-	-	-
Stones per Layer	-	4	4	2

Appian Soldier Pavers 70mm

70 mm Thickness	Sq. ft. per Bundle	Sq. Ft. per Layer	Soldier per Bundle(LF)	Sailor per Bundle(LF)	Weight per Bundle	Stones per Layer
	89	9.9	87.75	175.5	3,026 lb / 1,372.5 kg	18

LAYING PATTERNS FOR APPIAN STONE

These are a few of the possible laying patterns for Appian Stone. Other patterns are possible depending on quantities of product being used.

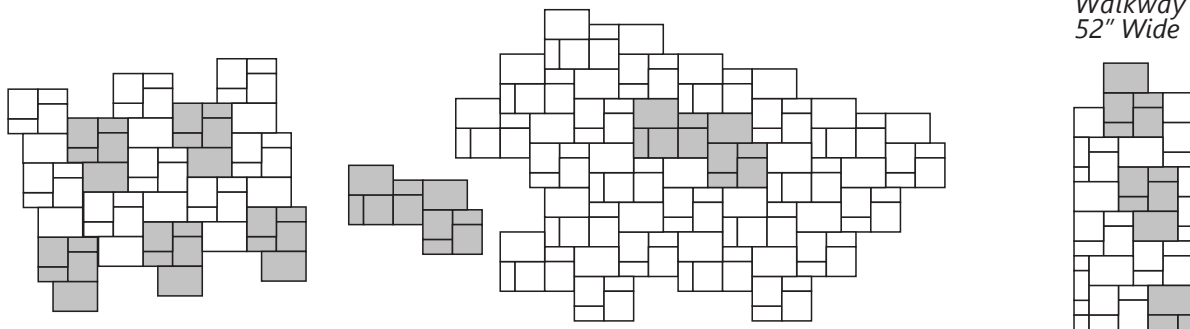

AZTEC 70MM / AZTEC 50MM

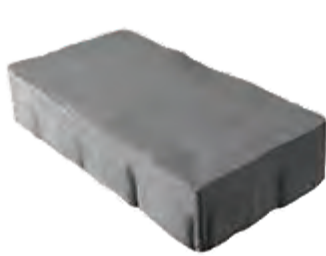

Small Rectangle

Length: 330mm (13")
Width: 165mm (6.5")

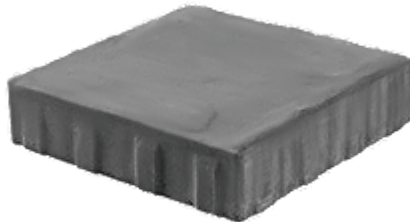

Square

Length: 330mm (13")
Width: 330mm (13")

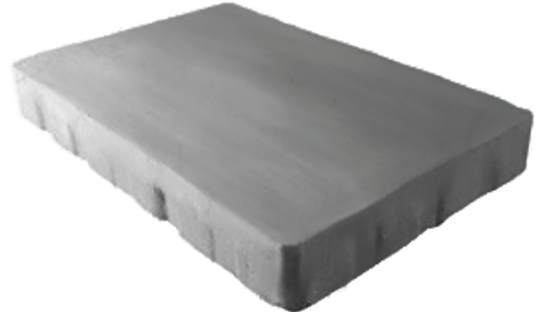

Large Rectangle

Length: 495mm (19.5")
Width: 330mm (13")

Aztec Pavers 70mm

***Bundle contains 9 Layers. Sold in full bundles only.*

70 mm Thickness	Full Cube	Small Rectangle	Square	Large Rectangle
Sq. Ft./Bundle	95.6	21	42.1	32.5
Stones per Sq. Ft.	-	1.7	0.85	0.56
Stones per Bundle	90	36	36	18
Weight per Bundle	3,250 lbs / 1,477 kg	-	-	-
Stones per Layer	-	4	4	2

Aztec Paver Slabs 50mm

***Bundle contains 12 Layers. Sold in full bundles only.*

50 mm Thickness	Full Cube	Small Rectangle	Square	Large Rectangle
Sq. Ft./Bundle	127.4	28.2	56.5	42.7
Stones per Sq. Ft.	-	1.7	0.85	0.56
Stones per Bundle	120	48	48	24
Weight per Bundle	3,075 lbs / 1,395 kg	-	-	-
Stones per Layer	-	4	4	2

LAYING PATTERNS FOR AZTEC 70MM/AZTEC 50MM

These are a few of the possible laying patterns for Aztec Stone. Other patterns are available depending on quantities of product being used.

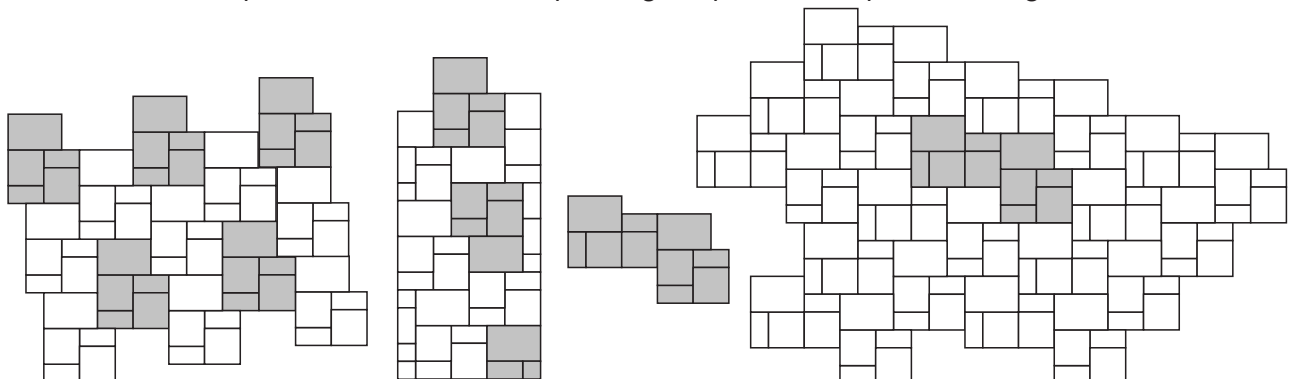

ATHENIAN

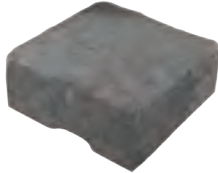

Length: 163mm (6.42")
Width: 163mm (6.42")
Thickness: 70mm (2.76")

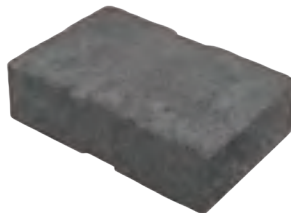

Length: 245mm (9.65")
Width: 163mm (6.42")
Thickness: 70mm (2.76")



Length: 327mm (12.87")
Width: 163mm (6.42")
Thickness: 70mm (2.76")



Length: 409mm (16.1")
Width: 163mm (6.42")
Thickness: 70mm (2.76")

Sold in full bundles only.

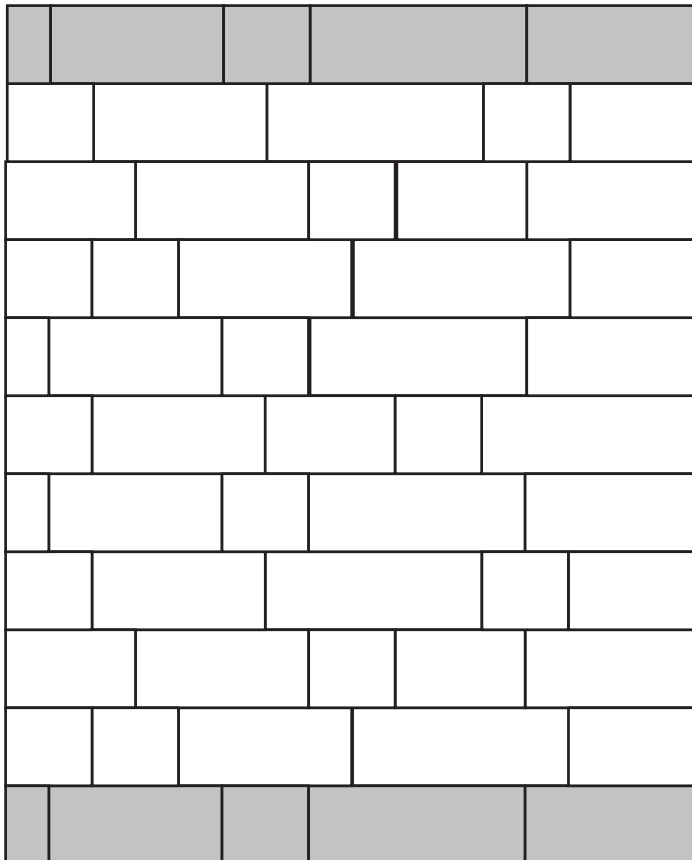

ATHENIAN PAVERS 70MM

70 mm Thickness	
Sq. Ft. per Bundle	96
Sq. Ft. per Layer	12
Layers per Bundle	8
Weight per Bundle	1,677lb/ 1,391.6kg



AVENNIO



Length: 355mm (14")
Width: 115mm (4.53")
Thickness: 80mm (3.15")



Length: 315mm (12.4")
Width: 115mm (4.53")
Thickness: 80mm (3.15")



Length: 275mm (10.83")
Width: 115mm (4.53")
Thickness: 80mm (3.15")



Length: 235mm (9.25")
Width: 115mm (4.53")
Thickness: 80mm (3.15")



Length: 355mm (14")
Width: 85mm (3.35")
Thickness: 80mm (3.15")



Length: 315mm (12.4")
Width: 85mm (3.35")
Thickness: 80mm (3.15")



Length: 275mm (10.83")
Width: 85mm (3.35")
Thickness: 80mm (3.15")



Length: 235mm (9.25")
Width: 85mm (3.35")
Thickness: 80mm (3.15")

AVENNIO LAYING SCHEMATIC

Avennio 80mm	
Sq. ft. per Bundle	95.2
Sq. Ft. per Layer	13.6
Layers per Bundle	7
Weight per Bundle	3,497 lbs / 1,586 kg

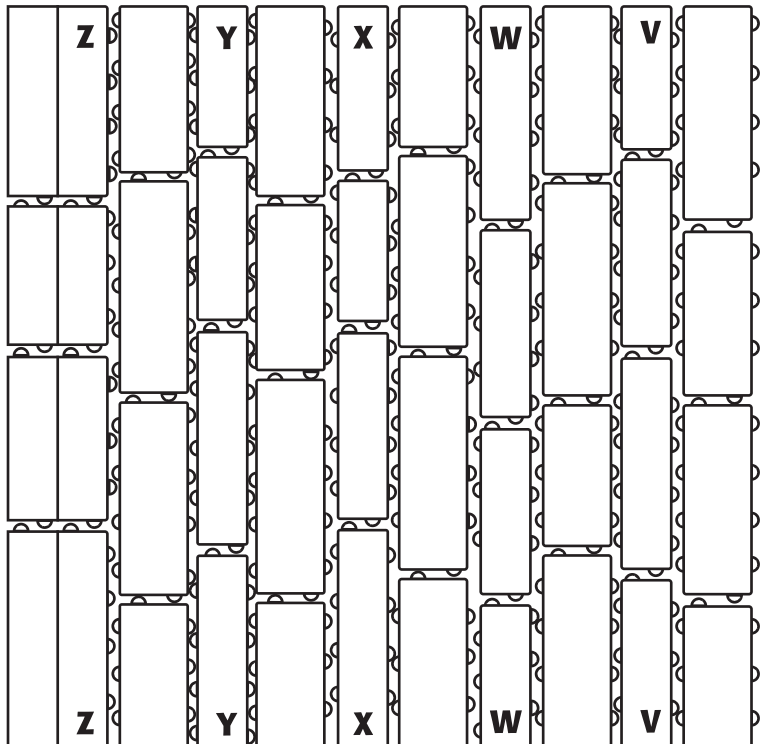

NORDIC

**** Nordic Classic and Nordic 80mm are Special Orders ****



Nordic

Length: 200mm (7.9")
Width: 100mm (3.9")
Thickness: 60mm (2.36")



Nordic 80mm

Length: 200mm (7.9")
Width: 100mm (3.9")
Thickness: 80mm (3.15")

	Nordic/Nordic Classic	Nordic 80mm
Sq. Ft. per Bundle	106	93
Full Stones per Sq. Ft.	4.57	4.57
Total Stones per Bundle	495	432
Half Stones per Bundle	18	16
Full Stones per Section	477	416
Sections per Bundle	6	-
Stones per Bundle	81 (90 with half stones)	-
Sq.Ft. per Section	17.67	-
Ln.Ft. per Bdl (Soldier Course)	156 (full stones only)	139 (full stones only)
Weight per Bundle	2,915 lb / 1,322 kg	3,460 lb / 1,566 kg

All pavers are shipped in full bundles only. Individual Nordic Stones available when picked up at the plant. For Nordic Classic and Nordic 80mm, minimum quantity required for production. Call office for availability.

Available in a Herringbone configuration for easy machine installation.

LAYING PATTERNS FOR NORDIC STONE

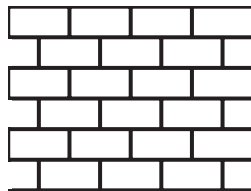

Runner Bond

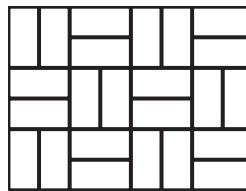

Parquet

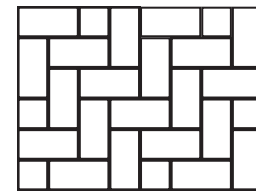

90° Herringbone

NORDIC SQUARE

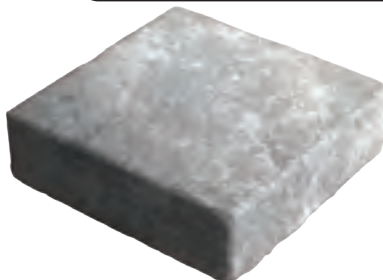

Nordic Square

Length: 200mm (7.9")
Width: 200mm (7.9")
Thickness: 60mm (2.36")

	Nordic Square
Sq. Ft. per Bundle	106
Stones per Sq. Ft.	29
Stones per Bundle	250
Ln.Ft. per Bdl (Soldier Course)	164
Weight per Bundle	3,052 lb / 1,384 kg

LAYING PATTERNS FOR NORDIC SQUARE

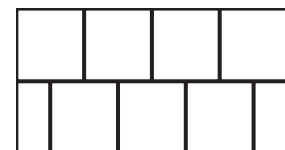

Runner Bond

Other patterns available when combining Nordic Stone and Nordic Square.

** Nordic Square is Special Order **

Minimum quantity required for production. Call office for possible availability. Product sold in full bundles only.

AQUAPAVE®

PERMEABLE PAVER SYSTEM

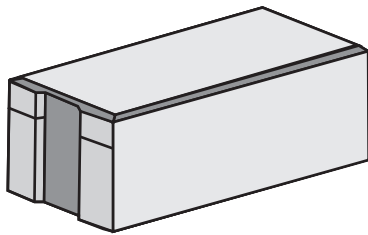

AquaPave®
Length: 200mm (7.9")
Width: 100mm (3.9")
Thickness: 80mm (3.15")

80 mm Thickness	Full Cube
Sq. Ft. per Bundle	73.5
Stones per Sq. Ft.	4.57
Stones per Bundle	336 (8 rows)
Weight per Bundle	2,735 lbs/ 1,085 kg

AquaPave® On-Site Stormwater Source Control System Schematic View

Refer to AquaPave Technical Manual for additional details.

Note: Be sure to determine design requirements, if any, by appropriate government agencies.

- Optional Membrane**
- HDPE (high density polyethylene)
 - EPDM (ethylene propylene dienemonomer)
 - ACP-SC1000 or 2000 woven geotextile
 - ACP-SC Inbitex® Geotextile

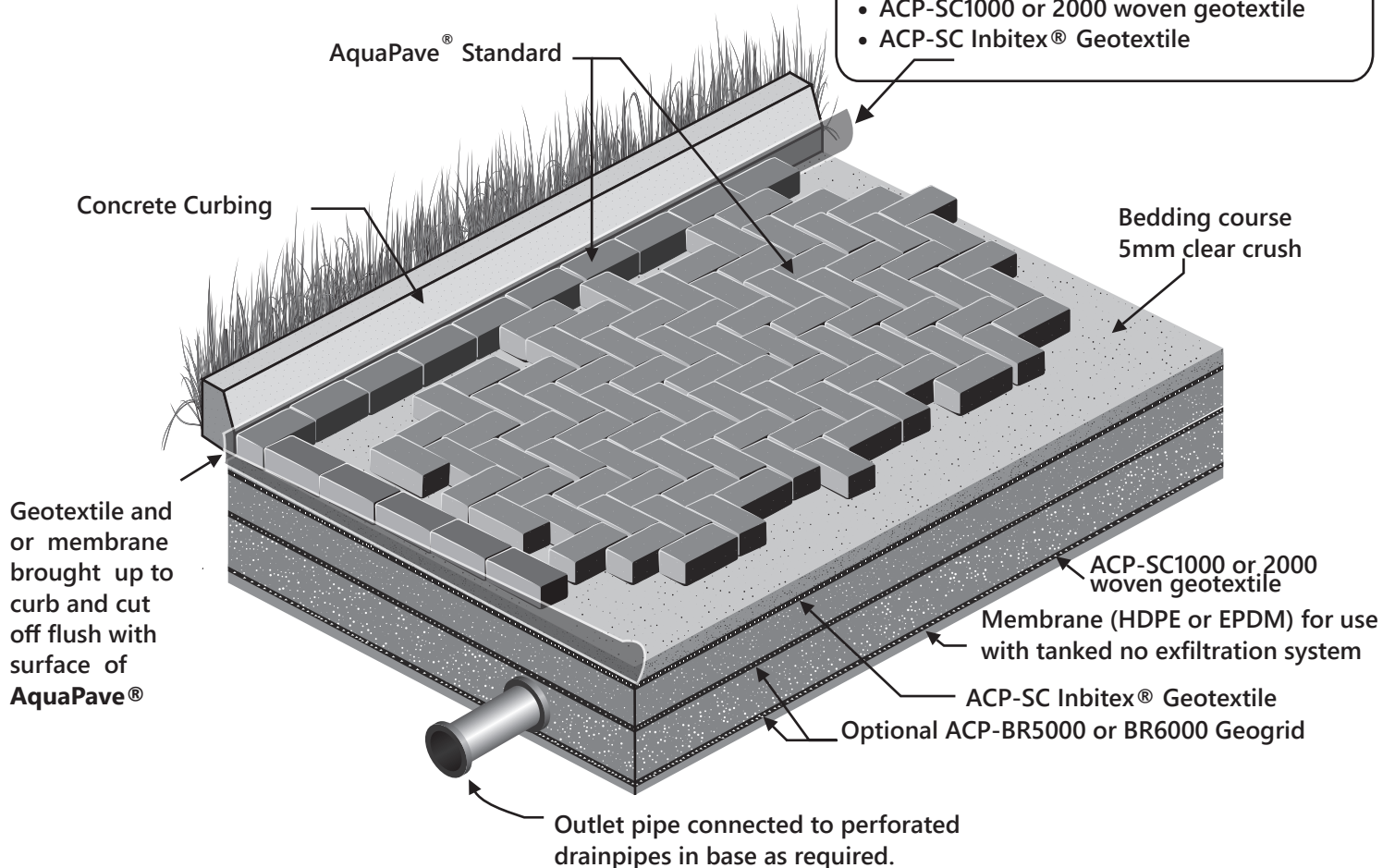

COLONIAL

All pavers are shipped in full bundles only.



6 x 6

Length: 153mm (6")
Width: 153mm (6")
Thickness: 60mm (2.36")



6 x 9

Length: 229mm (9")
Width: 153mm (6")
Thickness: 60mm (2.36")

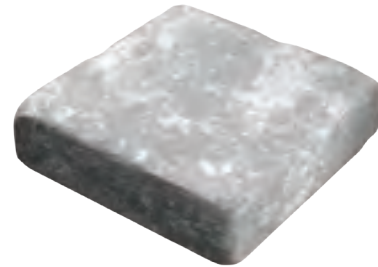

9 x 9

Length: 229mm (9")
Width: 229mm (9")
Thickness: 60mm (2.36")

	6x6 Full Bundle	6x9 Full Bundle	9x9 Full Bundle
Sq. Ft. per Bundle	114.8	105	113
Stones per Sq. Ft.	4.18	2.67	1.78
Stones per Bundle	480(20 pcs of 3 x 6 per skid)	280	200
Sections per Bundle	-	7	5
Stones per Section	70 (60 in one section)	40	40
Sq. Ft. per Section Ln.	14.2	15	22.5
Ft. per Bdl (Soldier)	236	165.2	148
Ln. Ft. per Sec (Soldier)	33.7 (29.5 in one section)	23.6	29.6
Weight per Bundle	3,371 lb/ 1,529 kg	2,889 lb/ 1,310 kg	3,108 lb /1,410 kg

LAYING PATTERNS FOR COLONIAL STONE

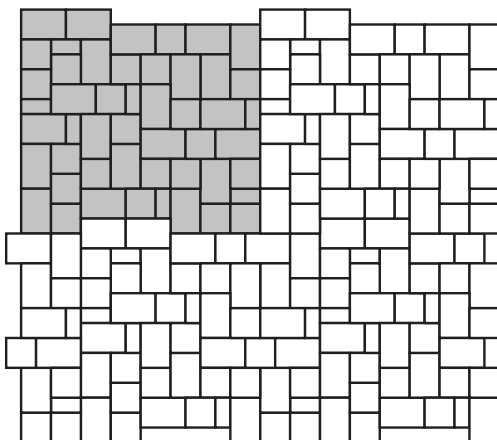

#13-6%3x6, 38%6x6,56%6x9**

** 3" x 6" stones must be cut on site to achieve this pattern design. Other patterns available.

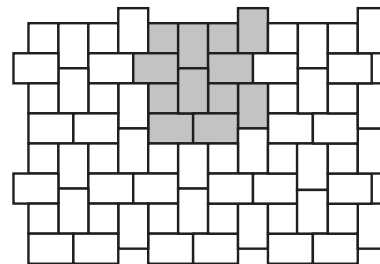

#17-25%6x6, 75%6x9

VENETIAN

Small Rectangle

Length: 60mm (2.36")
 Width: 120mm (4.8")
 Thickness: 60mm (2.36")

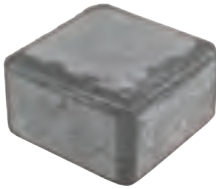

Square

Length: 120mm (4.8")
 Width: 120mm (4.8")
 Thickness: 60mm (2.36")



Large Rectangle

Length: 180mm (7.1")
 Width: 120mm (4.8")
 Thickness: 60mm (2.36")

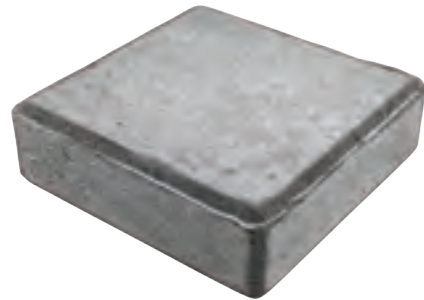

Venetian Square

Length: 240mm (9.5")
 Width: 240mm (9.5")
 Thickness: 60mm (2.36")

Venetian Random Bundle contains these three sizes: Small Rectangle, Square, and Large Rectangle.

	Venetian Random Bundle				
Venetian 60mm	Full Cube	Sm Rectangle	Lg Rectangle	Square	Venetian Square
Sq. Ft. per Bundle	112	7	62.8	42.2	99
Stones per Sq. Ft.	-	12.9	4.3	6.4	1.62
Stones per Bundle	630	90	270	270	160
Sections per Bundle	9	-	-	-	4
Stones per Section	70	10	30	30	40
Sq.Ft. per Section	12.45	0.8	6.97	4.68	24.8
Ln.Ft. per Bundle	-	-	-	-	126
Ln. Ft. per Section	-	-	-	-	31.5
Weight per Bundle	3,136 lb/1,422 kg	-	-	-	2,772lb/1,257kg

LAYING PATTERNS FOR VENETIAN STONE

Venetian Random

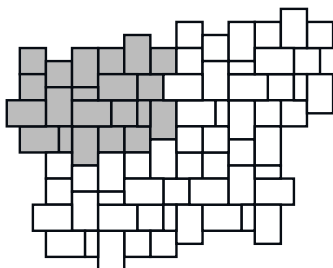

Venetian Random and Square

Random - 75%
 Square - 25%

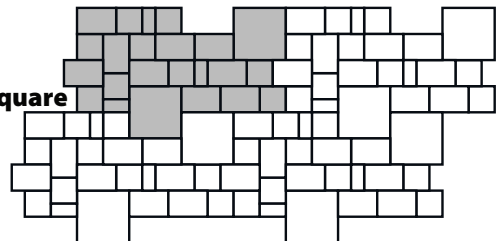

VENETIAN CIRCLE

Bundle Contains All **5** Sizes

Square Stone

Length: 120mm (4.8")
Width: 120mm (4.8")
Thickness: 60mm (2.36")

Small Wedge

Length: 90mm (3.6")
Width: 120mm (4.8")
Thickness: 60mm (2.36")

Rectangular Stone

Length: 90mm (3.6")
Width: 120mm (4.8")

Centre Stone

Diameter: 120mm (4.8")
Thickness: 60mm (2.36")

Large Wedge

Length: 130mm (5.1")
Width: 120mm (4.8")
Thickness: 60mm (2.36")

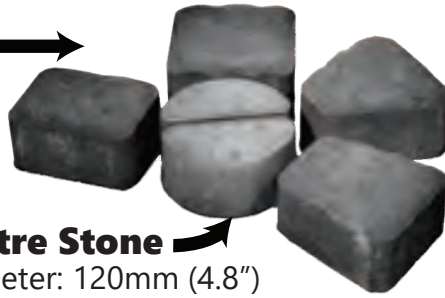

Venetian Circle	Full Cube	Centre Stone	Large Wedge	Small Wedge	Rectangular	Square
Chart Name	-	CS	LW	SW	R	SQ
Sq. Ft. per Bundle	61	-	-	-	-	-
Stones per Bundle	480	8(16 1/2's)	32	192	144	104
Weight per Bundle	1,677lb/ 760kg	-	-	-	-	-

HELPFUL HINTS — The following hints are to be used with the Paver Installation Instructions provided on pages 14-15.

1. Circle packs should always be installed starting from the inside (centre stone) and working outwards.
2. When spreading bedding sand for the centre of the circle, only spread sand over large enough area to allow placement of stones without disturbing material. Spread additional bedding sand as circle progresses outward.
3. When circle is completed, the remaining area of projects as per normal, taking extra care around circle to ensure lines are maintained. Leave cutting of final filler pieces directly around the perimeter of the circle to the end.
4. To prevent stones from spreading, do not compact circle into bedding sand until previous step is complete.

Note: there will be some gaps between stones because the circumference of each ring is different.

All Venetian materials shipped in full bundles only. Individual straps available only when picked up at the plant.

CIRCLE DESIGN CHART

The Venetian Circle bundle can make up to one 2.51m (8 feet 3 inches) diameter circle or up to two 1.55m (5 feet 1 inch) diameter circles.

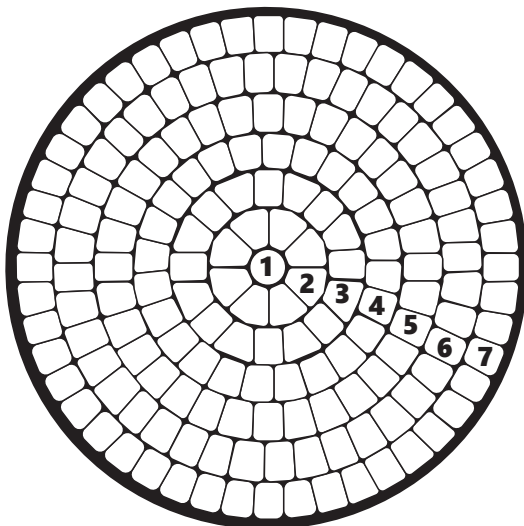

For each 1.55m (5 feet 1 inch) diameter circle, follow this laying pattern.

Ring	Number of Pieces in Ring					Details
	CS	LW	SW	R	SQ	
1	2					
2		8				
3		8		7	1	Alternate LW and R, finish with SQ
4			20		3	Place SQ after every 7 SW
5			20	7	4	SW, SW, SW, R, SW, SW, SW, R, SQ - repeat
6			24	17		SW, SW, R, SW, SW, R -repeat
7			24	24	1	Alternate SW and R, finish with SQ
Total	2	16	88	55	9	

For a 2.51m (8 feet 3 inches) circle, add rings 8 through 11 as follows.

Ring	Number of Pieces in Ring					Details
	CS	LW	SW	R	SQ	
8			24	31	2	SW, R, SW, R, SW, R, R -repeat
						Place SQ at top & bottom of circle (180° apart)
9			24	40		R, R, SW, R, R, SW, R, SW - repeat
10			32		31	Alternate SW and SQ stones
11			22		45	SQ, SQ, SW, SQ, SQ, SW - repeat
Total	2	16	190	126	87	

BELGIUM



Belgium 6 x 6
 Length: 150mm (5.9")
 Width: 150mm (5.9")
 Thickness: 60mm (2.36")



Belgium 3 x 6
 Length: 75mm (2.95")
 Width: 150mm (5.9")
 Thickness: 60mm (2.36")

Belgium 6x6 shipped in full bundles only.
 Individual sections available at plant only. 6x6 Classic Sold in full bundles only.

BREAK UP OF BUNDLE

	Full Bundle	6 x6 pcs.	3 x 6 pcs.
Sq. Ft. per Bundle	122	114.8	2.5
Stones per Sq. Ft.	4.26 (bundle average)	4.18	8.3
Stones per Bundle	500	480	20
Sections per Bundle	7	-	-
Stones per Section	70 (80 in one section)	70(80 in one section)	All 20 in one section
Sq.Ft. per Section	16.7	14.2	2.5 in one section
Ln.Ft. per Bdl	236 (full stones only)	236	NA
Ln. Ft. per Section	33.7 (29.5 in one section)	33.7(29.5 in one section)	NA
Weight per Bundle	3,371 lb/ 1,529 kg	-	-

LAYING PATTERNS FOR BELGIUM STONE

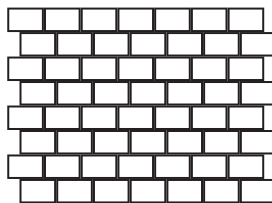

Runner Bond

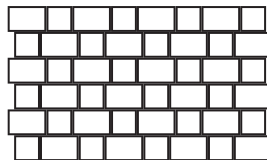

Combined Runner Bond
 40% 6x6 , 60% 6x9

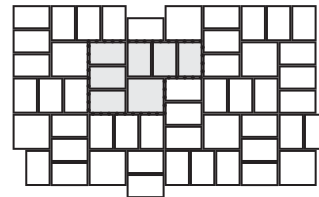

80% 6x9, 20% 9x9

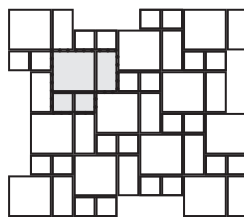

25% 6x6, 25% 6x12,
 50% 12x12

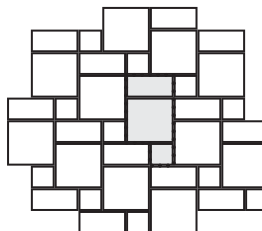

14% 6x6, 29% 6x12,
 57% 12x12

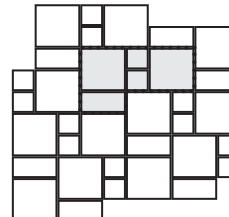

17% 6x6, 17% 6x12,
 66% 12x12

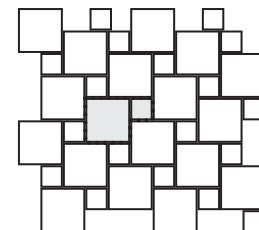

20% 6x6,
 80% 12x12

BELGIUM

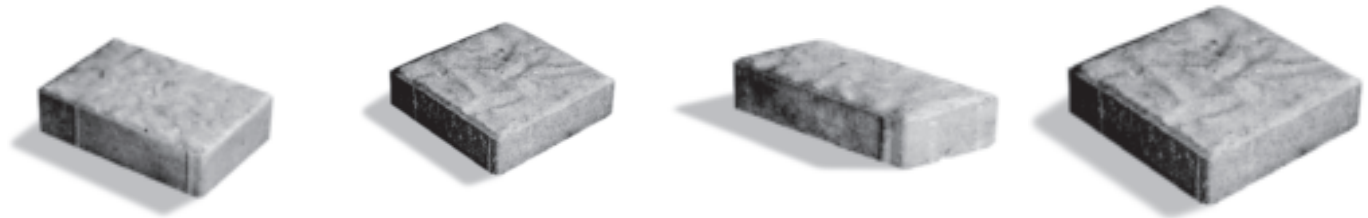

Belgium 6 x 9

Length: 225mm (8.9")
Width: 150mm (5.9")
Thickness: 60mm (2.36")

Belgium 9 x 9

Length: 225mm (8.9")
Width: 225mm (8.9")
Thickness: 60mm (2.36")

Belgium 6 x 12

Length: 300mm (11.8")
Width: 150mm (5.9")
Thickness: 60mm (2.36")

Belgium 12 x 12

Length: 300mm (11.8")
Width: 300mm (11.8")
Thickness: 60mm (2.36")

Belgium is shipped in full bundles only. Individual sections available at plant only.

Belgium 6 x 12 and 12 x 12 not recommended for heavy vehicle applications.

Belgium Classic sold in full bundles only.

**Photos above show Belgium. Belgium Classic is not shown here.
6 x 6, 6 x 9, and 9 x 9 available as Belgium Classic.**

	6 x 9 Full Bundle	9 x 9 Full Bundle	6 x 12 Full Bundle	12 x 12 Full Bundle
Sq. Ft. per Bundle	105	113	124	117
Stones per Sq. Ft.	2.67	1.78	2.04	1.03
Stones per Bundle	280	200	252	120
Sections per Bundle	7	5	4	4
Stones per Section	40	40	63	30
Sq.Ft. per Section	15	22.5	31	29.3
Ln.Ft. per Bdl(Soldier)	165.2	148	123.9	118.5
Ln. Ft. per Section(Soldier)	23.6	29.6	31	29.6
Weight per Bundle	2,889 lb/ 1,310 kg	3,108 lb/ 1,410 kg	3,410 lb/ 1,546 kg	3,218 lb/ 1,459 kg

LAYING PATTERNS FOR BELGIUM STONE

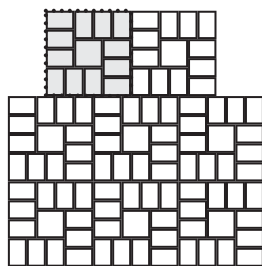

89% 6x9, 11% 9x9

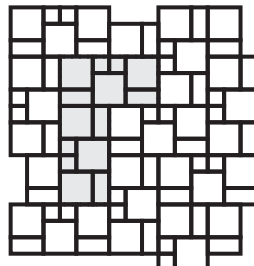

11% 6x6, 22% 6x12,
67% 12x12

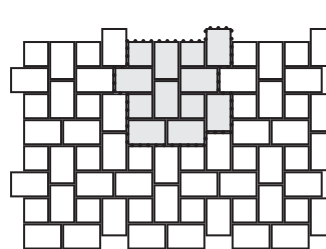

25% 6x6, 75% 6x9

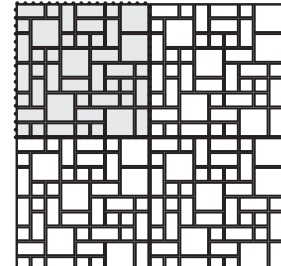

23% 6x6, 47% 6x12,
30% 12x12

CUSTOM PAVERS



Pave Lok

Special Order
 Length: 226 mm (8.9")
 Width: 112 mm (4.4")
 Thickness: 60 mm (2.36")



Duo Stone

Special Order
 Length: 226 mm (8.9")
 Width: 137 mm (5.4")
 Thickness: 60 mm (2.36")



Tango

Special Order
 Length: 178 mm (7")
 Width: 229 mm (9")
 Thickness: 60 mm (2.36")



Vintage Lite

Special Order
 Length: 215 mm (8.5")
 Width: 108 mm (4.3")
 Thickness: 45 mm (1.77")

Laying patterns available.

	Paver Lok	Duo Stone	Tango	Vintage
Sq. Ft.per Bundle	95	100	100	145
Stones per Sq. Ft.	3.5	3.64	3.67	4
Stones per Bundle	350	350	360	130
Ln. Ft. /Bdl(as edging)	130	-	-	187
Weight per Bundle	2,660 lb/ 1,207 kg	2,800 lb/ 1,270 kg	2,750 lb/ 1,247 kg	2,929 lb/ 1,328 kg

Minimum quantity required for production. Call office for possible availability.
 Product sold in full bundles only.

SIGNATURE CURB COLLECTION



3 Foot Curb

Length: 900 mm (35.5")
 Width: 83 mm (3.25")
 Height: 150 mm (6")



Driveway Curb

Length: 1000 mm (39")
 Width: 150 mm (6")
 Height: 150 mm (6")



Bullnose Curb

Length: 570 mm (22.5")
 Width: 115 mm (4.5")
 Height: 90 mm (3.5")

	3 ft Curb	Driveway Curb	Bullnose Curb
Pieces per Bundle	36	20	80
Linear Feet/Bundle	108	110	150
Weight per Bundle	2,016 lb/ 914 kg	2,193 lb/ 995 kg	2,400 lb/ 1,088 kg

PAVER INSTALLATION 1

STEP 1 — DESIGN & LAYOUT

The starting point of any project is the preliminary design drawing. The drawing should be done on graph paper to a convenient scale so that it is easy to read and estimate quantities from.

POINTER: Before finalizing the design, it is recommended that you stick out the proposed area of construction and then park vehicles (for driveways)/place furniture (for patios) in the staked out area to ensure the final product is adequately sized.

STEP 2 — ESTIMATE QUANTITIES

Include in Estimate:

1. Volume of excavated material.
2. Volume of aggregate base material.
3. Volume of bedding sand.
4. Square footage of pavers.
5. Linear length of edging.
6. Volume of jointing sand.

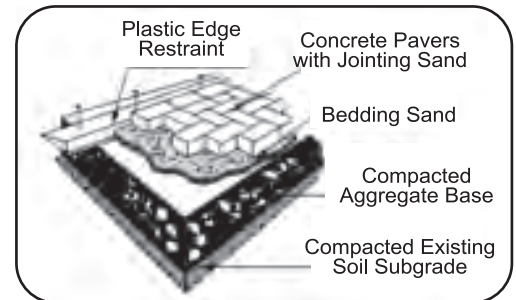

PAVERS — The required square footage for the pavers is measured from within the staked-out area. It is important to remember that some products are sold for bundle quantities only, so careful planning will minimize wastage. However, it is also recommended that an additional amount of pavers be ordered to account for some degree of wastage, especially if there are a lot of cuts required.

JOINTING SAND — Jointing sand is used to fill the spaces between the pavers after being installed to ensure the proper interlock. It typically comes in a 30 kg (66 lb.) bag, which is sufficient for approximately 10 m² (100 ft.²).

EDGING — Some form of edge restraint is required on all outside edges. Measure the perimeter of the staked-out area, with the exception of areas against existing buildings, walks or pavement. If plastic edging is used, remember to include sufficient spikes to secure the edging in place.

BEDDING SAND — Bedding sand is used as a bedding material into which the pavers are installed. Provide for 25 mm (1") of loosely spread bedding sand over the total area of pavers. When the pavers are compacted into place, some of the sand fills spaces (joints) between the stones, and the total thickness reduces to approximately 17 mm (5/8").

The Volume Chart on the inside front cover of this technical guide can be used to assist you with volume calculation (using the surface area and total depth).

AGGREGATE BASE — To provide a secure base in which to install the edge restraints, the area of excavation needs to be larger than the area being paved. The rule of thumb is to extend the excavation outwards in all directions equal to the total depth of the excavation. For example, if the total excavation is 300 mm (12") deep, the excavated area should extend to an additional 300 mm (12") on all sides beyond edging.

The minimum recommended depths for the aggregate base are listed in the side table. Please note that these steps can increase significantly based on the type of native soil, the local climate, and heavy traffic loads. It is highly recommended that a civil engineer be consulted to verify local conditions.

POINTER: All soils take up approximately 20-30% more space in a dump truck than after it is compacted into place. In other words, if you need to fill 100 m³ with base material, you will need to haul up to 130 m³ of loose material to the site. Remember to account for this in your estimate.

EXCAVATED MATERIAL — The following table provides examples of how the total depth of the necessary excavation is calculated based on the aggregate depth.

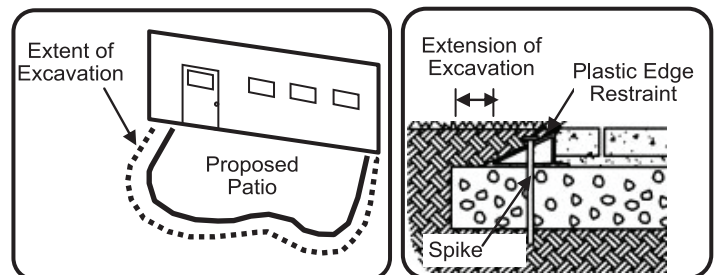

POINTER: As with the aggregate base, remember to allow for the bulking-up of the excavated material in the dump Truck.

	Walkways & Patios	Driveways
Pavers	60mm(2 ³ / ₈ ")	60mm(2 ³ / ₈ ")
Bedding Sand(compact)	17mm(5/8")	17mm(5/8")
Aggregate Base	200-250mm(8-10")	300-500mm(12-20")
TOTAL DEPTH	277-327mm(11-13")	377-577mm(15-23")

PAVER INSTALLATION 2

STEP 3 — EXCAVATION

POINTER: Remember to complete your locates prior to starting the work. When completed, the base of the excavation should be graded to provide proper drainage to a suitable water discharge point (e.g. Storm drain or ditch). Ensure the surface is free of debris such as large stones, roots, etc. Run a compactor over the base to evaluate the stability of the native material.

POINTER: If the stability of the soil is questionable (e.g. soft, wet, loose), it is advisable to utilize a geotextile to act as a separation barrier to prevent the base material from sinking into the existing soil.

STEP 4 — BASE BACKFILL

The recommended materials for base backfill is the same as that used for local road construction. When selecting the compactor, tell the supplier you want to reach 98% Proctor density for that type of material—a 7,000 lbf vibratory plate tamper is the recommended minimum compacting 4" lifts. A reversible compactor allows for 6" lifts.

Spread the material in loose layers of no greater than 150 mm (6"). Spray the necessary amount of water over the soil to lubricate it — but avoid making mud — and compact material in place. As a rule of thumb, if the dump truck leaves a depression in the complete area (when it backs up to dump the next load), additional compaction is required.

To check the final surface grades, place stakes around the perimeter of the project and at any crests or valleys, run string lines between the stakes, and check the depth of the lines using a measuring tape. Note that the final grades should maintain at a 2% slope (drop of 1/4" every foot).

Once the general grades are verified, use a 3 m long straight edge and to ensure the subbase is level — acceptable tolerances are ± 10 mm ($\pm 3/8$ "). As a guide, a pencil should not be able to slide under the straight edge at any point.

STEP 5 — CURB INSTALLATION

For concrete curbs (adjacent), a trench needs to be excavated into the aggregate base — the depth of the trench is based on the desired stickup of the curb.

For plastic curbing, the sections are placed directly on top of the aggregate base and staked down using to 250 mm (10") spikes.

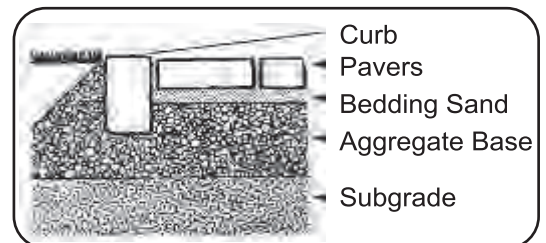

STEP 6 — BEDDING SAND

The key to this step is to ensure a consistent thickness for the loose sand. The easiest way to do this is to use 19 mm (3/4") diameter Schedule 80 PVC pipe for guide rails (the outside diameter is 25 mm). Spread the sand loosely between a pair of pipes, then pull a straight edge along the top to level the sand out (photo). Avoid disturbing the sand once in place.



STEP 7 — LAYING THE PAVERS

The laying pattern used is subject to personal preference. However, herringbone patterns are recommended for traffic areas. Place chalk lines on sand at 2 m (6') intervals to provide straight-line guides during installation. Always start laying at the lowest point so that stones cannot separate; place hand-tight. Use a rubber mallet as required to adjust stones.



POINTER: Mix pavers from at least 4 different cubes at a time so that any colour variation between cubes are blended in. Cut pavers to fill gaps along edges and around obstacles as required using cantilever splitters or masonry saws. For curves, place pavers beyond the final edge, mark off the desired curve, and then, using a masonry saw, cut the pavers in place (photo). Wash down the area after cutting as the residue can create stains.



STEP 8 — COMPACTION & FINISH

After all pavers are in position, or at the end of each day, sweep off the surface completely and then compact the pavers into the bedding sand using 5,000 lbf plate tamper.

Spread dry jointing sand and sweep into joints until full. Clean off surface and vibrate jointing sand into spaces using tamper. Repeat until joints are completely full.

PARKWALL®



Standard Unit
 Length: 200 mm (7.87")
 Height: 150 mm (5.9")
 Depth: 295 mm (11.61")



Corner Units
(sold in pairs)
 Length: 295 mm (11.61")
 Height: 150 mm (5.9")
 Depth: 193 mm (7.59")



12" Copping
 Length: 600 mm (23.6")
 Height: 75 mm (2.95")
 Depth: 300 mm (11.81")

INSTALLATION DETAILS

The maximum exposed (above grade) height for a gravity wall with a standard 9.5° batter is 975 mm (38.4"). This includes a 75 mm (2.95") cap and 6 exposed courses, and requires one additional buried course. With geogrid, the maximum wall height is 3.375 m (11.1 ft).

The maximum exposed (above grade) height for a gravity wall with no batter is 675 mm (26.6"). This includes a 75 mm (2.95") cap and 4 exposed courses, and requires one additional buried course. With geogrid, the maximum vertical wall height is 2.175 m (7.1 ft). The minimum radius for curves is 2.4 m (8 ft).

Pillar Cap

— see catalogue
 Length: 610 mm (24")
 Width: 610 mm (24")
 Height: 75 mm (3")

RETAINING WALL FACING OPTIONS

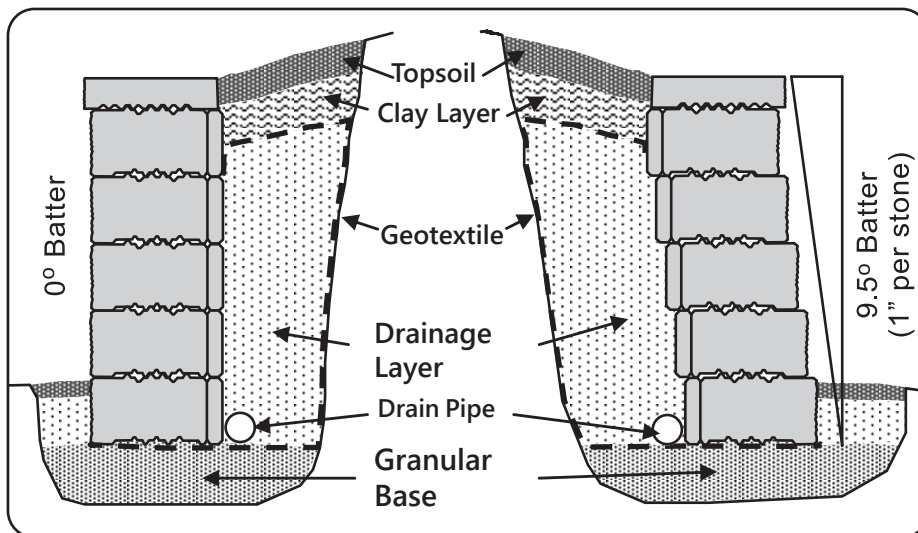

ORDERING INFORMATION

Standard and 12" Cap units sold individually. Corners sold in pairs. For delivery, part cubes will be shrink-wrapped.

Note: With the Parkwall system, both the split face and/or the smooth face can be used on the exposed side.

	Standard Unit	Corner Unit	12" Copping
Sq.Ft. per Bundle	19.3	22	13.5
Pieces per Bundle	60	28	28
Pieces per Sq.Ft.	3.1	1.27	2.07
Pieces per Ln.Ft.	1.52	0.625	0.51
Ln.Ft. per Bundle	39.35	44.8	55.1
Weight per Bundle	2,580 lb/ 1,173 kg	1,204 lb/548 kg	1,932 lb/878 kg

PARKWALL®

BUILDING STEPS WITH PARKWALL/PARKWALL CLASSIC

When constructing steps, Parkwall Standard units used for the risers and side walls, while 12" Cap Stone are used for the treads. Standard Units are recommended in lieu of backfill below risers.

Using Pisa Light® for steps is not recommended.

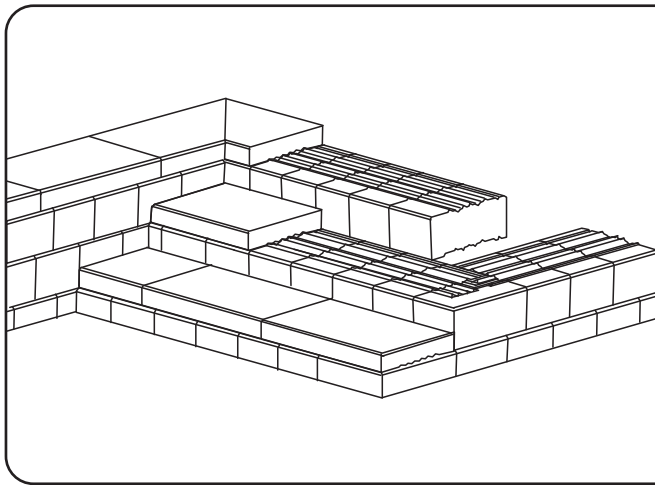

PERPENDICULAR STEPS

This is simply a series of inside and outside covers, with the cross wall (riser) being stepped back 300 m (12") per course.

For each course, construct the inside and outside corners and then place the necessary units in between. Position the coping units and secure with adhesive.

The next course is placed with the front face of the riser units touching the back of the coping stone on the lower step. Some trimming of the interlock ridges on the outside corner will be necessary.

OUTSIDE STEPS

First, assemble two (2) outside corners and two (2) inside covers for the bottom course. At the outside corners, chop part of the interlock ridges off the corner units and position/secure the coping. Fill in with aggregate or additional standard units.

Place the next riser in contact with the back of the coping unit for the previous riser. Some chopping will again be necessary on the corner units. When constructing vertical sidewall steps against a setback retaining wall, remember to adjust the layout of the inside (back) corners to account for the difference in wall slopes.

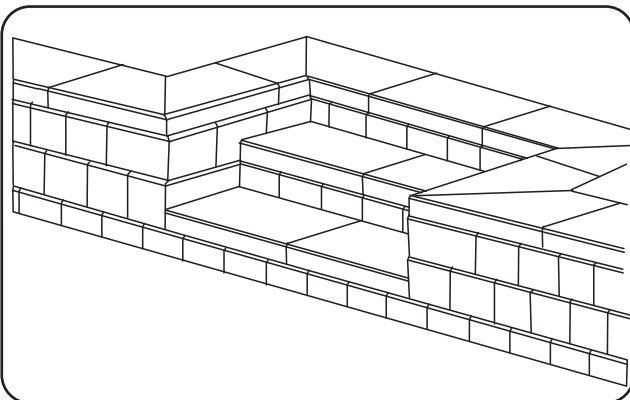
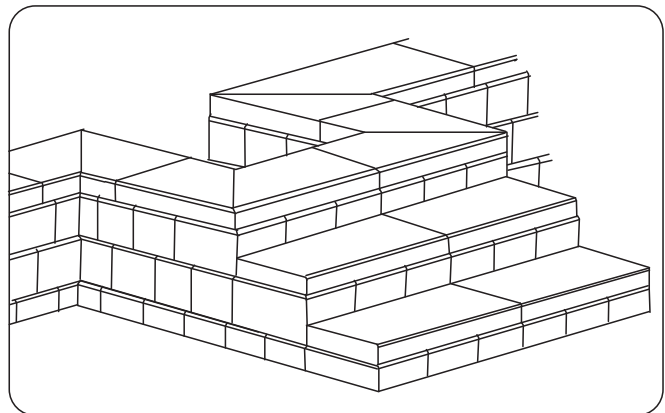

INSET STEPS

First, assembled into outside corners and sidewalls, with a distance of one riser length in between. For setback retaining walls, see previous instructions. Place the first riser and associated filler units on the same foundation elevation as the side walls. Position and secure coping. The next course is placed with the front face of the riser units touching the back of the coping stone on the lower step.

WEDGESTONE™



Length: 225 mm tapered to 150 mm (8.9" tapered to 5.9")
 Height: 100 mm (3.93")
 Depth: 200 mm (7.87")

Note: all pieces have texture on both sides.

	Resulting Batter	Maximum Exposed Wall Height	Maximum Total Course
Vertical Wall	0°	400mm(15.75")	4 exposed, 1 buried
One Groove Set Back	14°	600mm(23.6")	6 exposed, 1 buried

FACE VIEW OPTIONS — There are two options, depending on how the stones are placed.

METHOD A - UNIFORM

1.35 pcs per linear foot

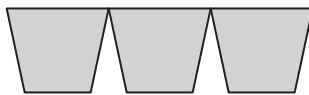

Top View

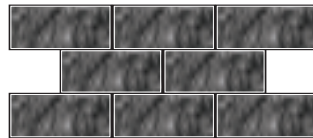

Front Face

METHOD B - RANDOM

1.6 pcs per linear foot

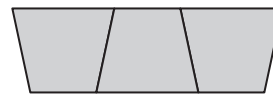

Top View

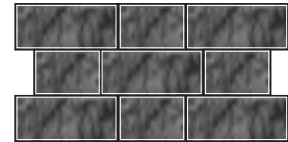

Front Face

CURVED WALL INSTALLATION DETAILS

4 pieces construct a 90° curved corner with an inside radius of 400 mm (16"). Only 16 pieces are required to construct a full circle with an inside radius of 400 mm (16").

Solid straight wall sections are achieved by simply reversing alternate pieces.

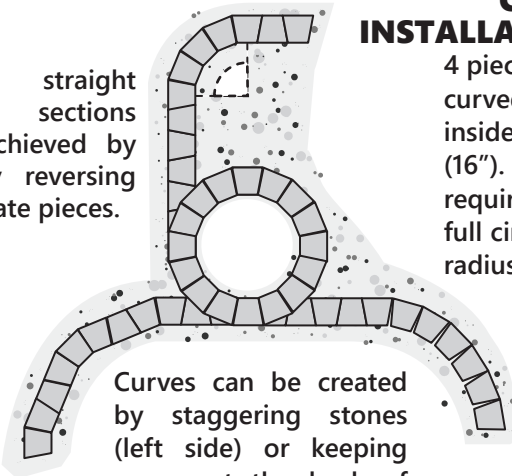

Curves can be created by staggering stones (left side) or keeping a gap at the back of the pieces (right side). Alternately, pieces can be cut as required.

ORDER INFORMATION

Sq.Ft. per Bundle	30 - 36.5
Pieces per Bundle	150
Pieces per Sq.Ft.	4.1 - 5
Ln. Ft. per Bundle	94
Weight per Bundle	2,850 lb / 1,293 kg

All units sold individually. For delivery, part cubes will be shrink-wrapped.

Note: Ranges based on face view options.

STEP INSTALLATION DETAILS

Curved or half-round steps can be created using Wedgestone™. However, it is recommended that these stones be glued together, that 1.5 courses be buried, and that geogrid be incorporated, to prevent any movement.



DIMENSIONAL CLASSIC

RETAINING WALLS with DIMENSIONAL CLASSIC



Length 270 mm (10.63")
 Height: 90 mm (3.54")
 Depth: 180 mm (7.09")

GENERAL DETAILS

The maximum exposed (above grade) height for a Dimensional Classic wall is 360 mm (14.2"). This consists of 4 exposed courses, and requires one additional fully buried course.

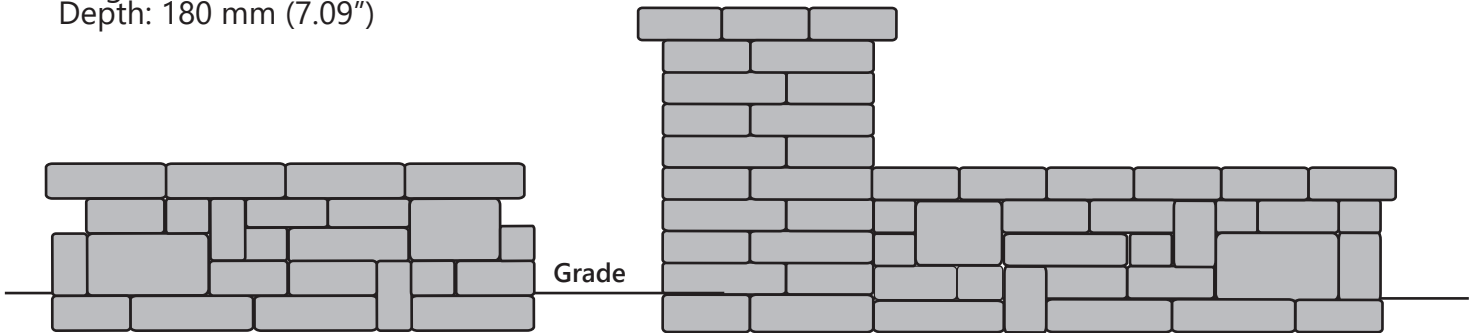

Offset vertical joints for added strength. Adhere top course with adhesive.
 To achieve a random pattern, cut some pieces and lay randomly.
 Pieces that are stood up vertically must be backed with another piece of equal dimensions.

ORDER INFORMATION

Dimensional Classic units are sold individually.
 For delivery, part cubes will be shrink wrapped.
 Details are provided in the following table.

Sq.Ft. per Bundle	37
Stones per Sq.Ft.	3.8
Stones per Bundle	140
Ln.Ft. per Bundle	124
Weight per Bundle	3,080 lb / 1,400 kg

BLOCKS ARE GLUED USING ADHESIVE

4 pieces per layer

Grade
 200-250mm
 (8-10")
 granular base

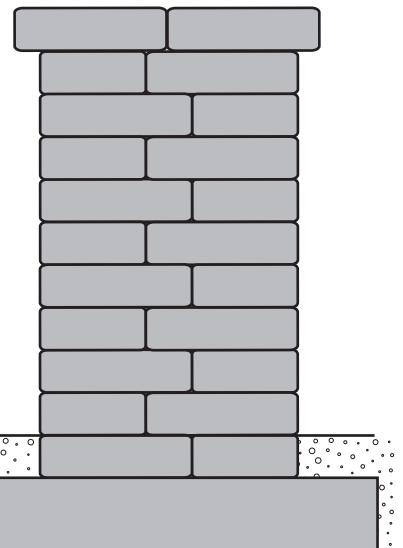

PISA LIGHT®



Pisa Light® Corner Units

(sold in pairs)
 Length: 290 mm (11.4")
 Height: 150 mm (5.9")
 Depth: 200 mm (7.9")



Standard Unit

Length: 200 mm (7.9")
 Height: 150 mm (5.9")
 Depth: 216 mm (8.5")



9" Coping

Length: 600 mm (23.6")
 Height: 75 mm (2.95")
 Depth: 225 mm (8.9")
***best suited for straight walls, 9" Cap stones can accommodate curves with some cutting.*

INSTALLATION DETAILS The maximum exposed (above grade) height for a gravity wall is 675 mm (26.6"). This includes a 75 mm (3") cap, 4 exposed courses and requires one additional full buried course.

ORDERING INFORMATION

All system units sold individually. For delivery, part cubes will be shrink-wrapped.

	Standard Unit	Corner Unit	9" Cap Stone
Sq.Ft. per Bundle	42.6	22.1	16.9
Pieces per Bundle	132	28	35
Pieces per Sq.Ft.	3.1	1.27	2.07
Pieces per Ln.Ft.	1.52	0.62	0.51
Ln.Ft. per Bundle	86.6	45	68.8
Weight per Bundle	3,168 lb / 1,440 kg	1,288 lb / 586 kg	1,890 lb / 859 kg

BUILDING 90° CORNERS WITH PISA LIGHT®

(Note: Same methods applied to Parkwall and Parkwall Classic)

OUTSIDE CORNERS

- 1st Course** — Position corner unit so both rough faces will be exposed in the final construction.
- 2nd Course** — Place the corner unit that faces the other direction on the next course to interlock the corner.
- 3rd Course** — Repeat 1st course. Continue pattern until desired height is achieved.

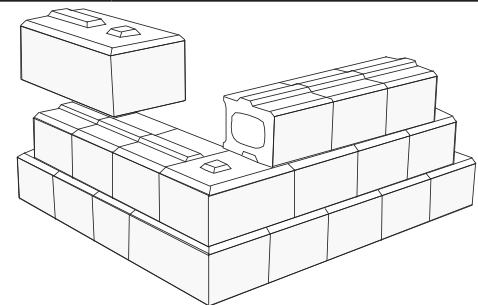

INSIDE CORNERS

Corner Unit Method

Place 1st corner unit so that the small face will be hidden behind the final construction. Place a corner unit from the other direction on the next course to interlock the corners. Repeat the first course. Continue pattern until desired height is achieved.

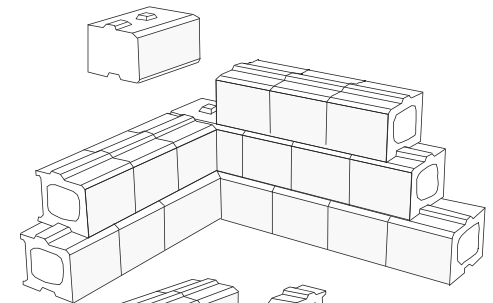

Half Unit Method

Complete three (3) or four (4) courses on the one side of the corner. End the wall using half units on every other course. For Pisa Light, each course should extend 19 mm (¾") beyond the first course to match the batter of the adjacent wall. For Parkwall, each course should extend 25 mm (1") beyond the first course. Place units along the second wall using half units on alternate courses.

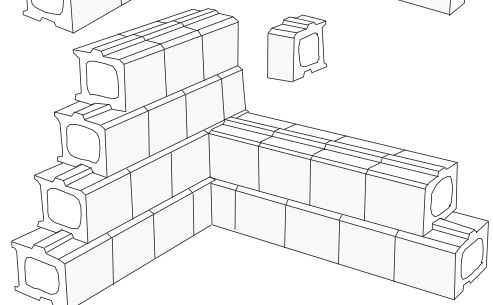

BUILDING CURVES WITH PISA LIGHT® (Note: Same methods applied to Parkwall)

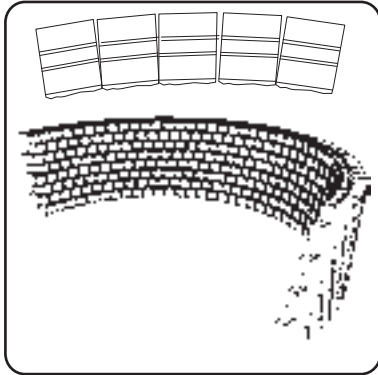

INSIDE (Concave) CURVES

Standard units are typically used to construct inside curves. The front faces of the units are placed tightly together while small spaces are left between the back of the units. The mini-mum inside radius is 2.4 m (8'). Smaller inside radii would require cutting.

The minimum radii would occur at the bottom row. For Pisa Light, the radius will increase 19 mm (¾") for each course added due to the wall's natural batter. For Parkwall, the increase is 25 mm (1") per course.

With curves, the joints begin to line up because of the natural batter: a cut (half) unit can be used to reestablish the running bond.

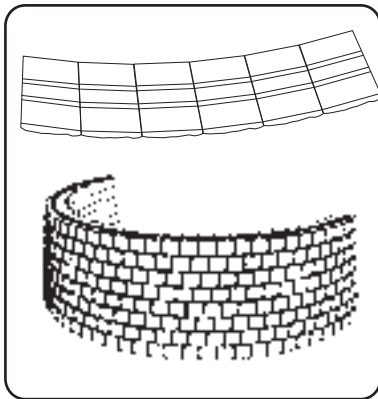

OUTSIDE (Convex) CURVES

Cut units are used to construct outside curves. For smooth flowing curves, place all units tapered on the left side on one course, and all units tapered on the right side on the next course. The minimum outside radius is 2.4 m (8'). Smaller outside radii would require cutting.

Because the radius decreases with each course, the minimum radius would occur at the top row. The radius of the bottom row needs to be adjusted 19 mm (¾") for each additional row with Pisa Light, or 25 mm (1") for each additional row with Parkwall.

When laying all but the top row (if at the minimum radii), the front faces are placed tightly together while small spaces are left between the backs of the units. The top row should then be placed flush from front to back of the unit.

COPING INSTALLATION WITH PISA LIGHT® 9" CAP STONE

Note: Same methods applied to Parkwall 12"

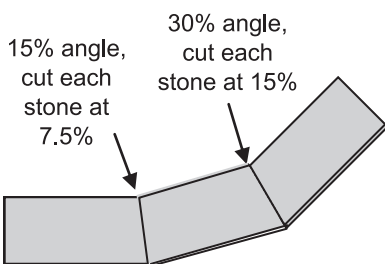
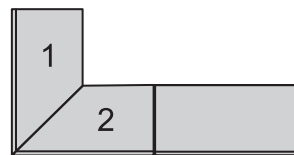

Place units against one another for straight walls.

For 90° corners, it is recommended that both units 1 and 2 be mitered at 4° so that the split front face is continuous, and that the tongue and groove is hidden.

For gradual curves, units can be cut as required. Again, it is recommended that both units be mitered at ½ the total angle so that the units sit flush together.

PILLARS USING PISA LIGHT® 9" CORNERS

Note: Same methods applied to Parkwall Corner Units

For smaller pillars, start by placing 4 corner units together (all same type) to create a square. For larger pillars, place Pisa Light Straight (Parkwall Straight) units between the corners.

For the second row, alternate the corner units (i.e. if the base course was composed of right corner units, left corner units are used for the second row).

Continue this method of alternating corner units per course until the desired pillar height is achieved. For added stability, sheets of biaxial Geogrid can be placed between layers.

The pillar cap can either be made using 9" Cap Stones (Parkwall 12" Caps) cut to fit, or a pre-manufactured capstone.



SIGNATURE FIRE PIT KITS

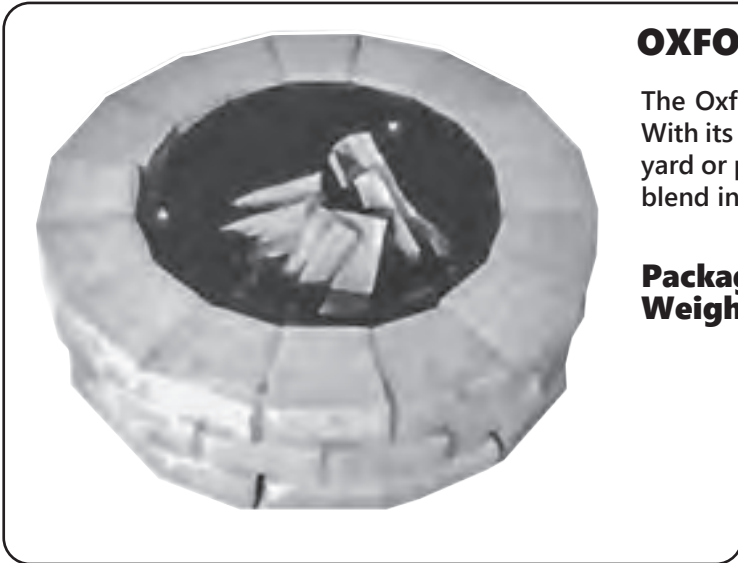

OXFORD FIRE PIT KIT

The Oxford Fire Pit Kits is a great fire pit for a smaller space. With its smaller design, and low-profile, it is perfect for a small yard or patio. The gentle features of a round fire pit allow it to blend in with a wide variety of architectural styles.

Packaging Details: Stone and Ring Included on one pallet.
Weight: 1,037 lbs / 470 kg



KENT FIRE PIT KIT

The Kent Fire Pit Kit is a larger unit with grand proportions. This square fire pit kit comes complete with the stone and steel insert. The refined dimensional look of this unit is well-suited to that yard with modern, clean-cut lines where angles and depth are important.

Packaging Details: Stone and Ring included on one pallet.
Weight: 922 lbs / 418 kg

FIRE PIT INSTALLATION INSTRUCTIONS:



STEP 1

Set the ring on a flat even surface.

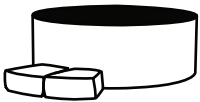

STEP 2

Lay out the first course of 16 blocks around the ring insert.

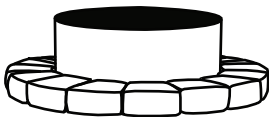

STEP 3

Make sure the gap between the ring and blocks are even all around, and that the ring can be removed with ease.

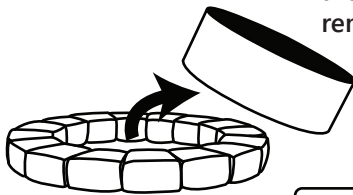

STEP 4

Remove the ring insert and set it aside.

Staggered Joints

Step 5

Lay out the next 3 courses keeping the joints staggered.

Important: Fire Resistant Masonry adhesive should be applied between layers, securing them in place permanently.

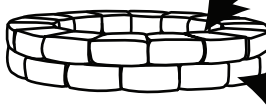

Sand

STEP 6



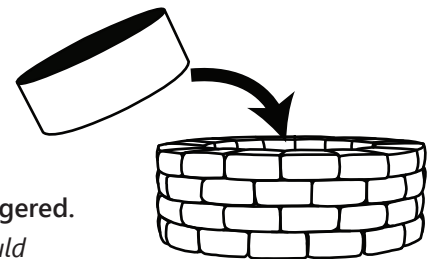
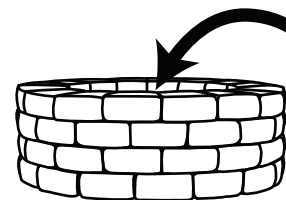

Fill the inside with the 3 bags of sand are required, and spread it out evenly.



STEP 7

Set the ring back inside the firepit and press it down to set it in the sand. It should sit just below the rim of the firepit blocks.

ROCKTON BLOCK DETAILS

Freestanding Wall Pallet Stone & Bundling		Unit Dimensions			Units per Bundle	Weight ±/ Stone	
		L (inches)	W (inches)	H (inches)		lbs	kg
	Block 1	42	10 1/2	6	6	200	90.5
	Block 2	30	10 1/2	6	3	150	68
	Block 3	21	10 1/2	6	6	140	63.5
	Block 4	12	10 1/2	6	3	50	22.5

Rockton Freestanding Wall Blocks are provided in four basic sizes. The blocks are finished on both the front and back faces of the wall blocks and they are tapered on each side approximately 1.5" from the front to the back of the block. There are multi-ple texture patterns for each basic block size to provide a more random look for your finished project. Average block weights of the different texture patterns are shown. Weights of individual blocks may vary.



Weights of individual blocks may vary.



ROCKTON FREESTANDING WALL PALLET

Pallet weight = ± 2,500 lbs. / 1,125 kg (incl. pallet weight); Coverage = ± 20 ft.²/pallet retaining or freestanding wall
Section = 7 ft.² per layer

ROCKTON CORNER PALLET

Pallet weight = ± 2,500 lbs./ 1,125 kg (incl. pallet weight); Coverage = 31.5 ft.²/pallet Section = 1.3 ft.² per piece

***Preliminary Cross Sections Available. ***

Corner Pallet Stone & Bundling		Unit Dimensions			Units per Bundle	Weight ±/ Stone	
		L (inches)	W (inches)	H (inches)		lbs	kg
	Block 1	21	10 1/2	6	24	100	45

The Rockton Collection contains two corner blocks. These blocks are finished on three sides, and the fourth side is tapered to fit with the other retaining wall and freestanding wall blocks. The corner blocks can be used to construct columns, provide a finished end on a freestanding wall, and make 90° corners. There are multiple texture patterns for the faces of both corner blocks, thus providing a more random look for your finished project. Average block weights of the different texture patterns are shown.

NORTHFACE



These units come with two integral and inset lifting hooks for ease of installation.



Half Size Unit	
4.5 SQ FT/Unit Weight: 1,300 lbs (589.5 kg) solid	Length: 114 mm (36") Height: 457 mm (18") Depth: 610 mm (24")









****Preliminary Cross-Sections Available****

Full Size Unit	
9 SQ FT/Unit Weight: 2,600 lbs (1,179 kg) solid	Length: 1829 mm (72") Height: 457 mm (18") Depth: 610 mm (24")

		Northface Coping Units
3' Long		<p>Note:</p> <p>The 6' Dimensional Step is used for the coping on this wall system along with a 3' coping unit. Engineered three courses high.</p>
6' Long		

BELVEDERE BLOCK DETAILS

WALL PALLET Stone & Bundling	Unit Dimensions			Units per Bundle	Weight ±/ Stone	
	L (inches)	W (inches)	H (inches)		lbs	kg
 Block 1	6	9	3	12	10	4.5
 Block 2	12	9	3	12	20	9
 Block 3	18	9	3	12	36	16
 Block 4	6	9	6	12	21	9.5
 Block 5	12	9	6	12	42	19
 Block 6	18	9	6	12	67	30

Belvedere Collection wall blocks are provided in six basic sizes. The blocks are finished on both the front and back faces of the wall blocks and they are tapered on each side approximately 1" from the front to the back of the block. There are multiple texture patterns for each basic block size to provide a more random

Average block weights of the different texture patterns are shown. Weight on individual blocks may vary.



look for your finished project. Average block weights of the different texture patterns are shown. Weights of individual blocks may vary.



WALL PALLET

Pallet weight = ± 2,475 lbs. (incl. pallet weight)
Coverage = 27 ft.² /Pallet when used in a Retaining Wall ; and 25 ft.²/Pallet when used in a Freestanding Wall Section = 9 ft.² per 2 layers (1 Layer of 6" and 1 Layer of 3")



CORNER PALLET







Pallet weight = ± 1,520 lbs. (incl. pallet weight); Coverage = 24 ft.² /Pallet Section= 1.5 ft.² (One 6" piece and one 3" piece)

CORNER PALLET Stone & Bundling	Unit Dimensions			Units per Bundle	Weight± / Stone	
	L (inches)	W (inches)	H (inches)		lbs	kg
Block 7	15	9	3	16	30	13.5
Block 8	15	9	6	16	58	26

The Belvedere Collection contains 2 corner blocks: these blocks are finished on 3 sides and the 4th side is tapered to fit with the other retaining wall blocks. The corner blocks can be used to construct columns, provide a finished end on a freestanding wall, and make 90° corners. There are multiple texture patterns for the faces of both column block sizes, thus providing a more random look for your finished project.

BELVEDERE COPING DETAILS (CAPS)

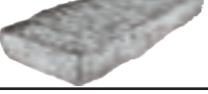
Coping blocks are provided in five basic sizes. There are three standard coping blocks which are finished on the front, back, and top faces. The standard coping blocks are tapered approximately 1" on each side from the front to the back of the block. There are also two end units which are finished on the front, back, top, and one of the sides. The other side is tapered approximately 1" from the front to the back of the block. The end units are useful for constructing corners and ends. There are multiple face/texture patterns for each basic block size, providing a more random look for your finished project. Dimensional Coping is also an option for capping the Belvedere Wall. Average block weights of the different face/texture patterns are shown. Weights of individual blocks may vary.



Stone & Bundling	Unit Dimensions			Units per Bundle	Weight ±/ Stone	
	L (inches)	W (inches)	H (inches)		lbs	kg
 Block 9	6	10 1/4	2 1/4	24	10	4.5
 Block 10	12	10 1/4	2 1/4	24	20	9
 Block 11	18	10 1/4	2 1/4	12	30	13.5
	left end					
 Block 12	18	10 1/4	2 1/4	6	30	13.5
	right end					
 Block 13	18	10 1/4	2 1/4	6	30	13.5
 Belvedere Column Cap	27	27	2 1/4	10	150	68



COPING PALLET

Pallet weight = ± 1,550 lbs. / 697.5 kg (incl. pallet weight)
 Coverage = 66 linear feet/
 Pallet Section = 11 linear feet per 1 Layer

DIMENSIONAL WALL BLOCK DETAILS

Stone & Bundling	Unit Dimensions			Units per Bundle	Weight± / Stone	
	L (inches)	W (inches)	H (inches)		lbs	kg
 Straight	12	8	4	75	28	12.5
 Wedge Front	12	8	4	100	20	9
Wedge Back	7 1/2	8	4	100	20	9



DIMENSIONAL STRAIGHT PALLET
Pallet weight = ± 2,100 lbs. (incl. pallet weight)
Coverage = 25 ft.² /Pallet (Retaining)
25 ft.² /Pallet (Freestanding) Section = Sold by the piece



DIMENSIONAL WEDGE PALLET
Pallet weight = ± 2,000 lbs. (incl. pallet weight)
Coverage = 33.3 ft.² /Pallet (Retaining)
26.4 ft.² /Pallet (Freestanding) Section = Sold by the piece

*Hand-hewn stone texture — Consistent dimensions — Natural stone texture on five sides
Actual weight and volumes may vary. Weight shown is based on concrete.*



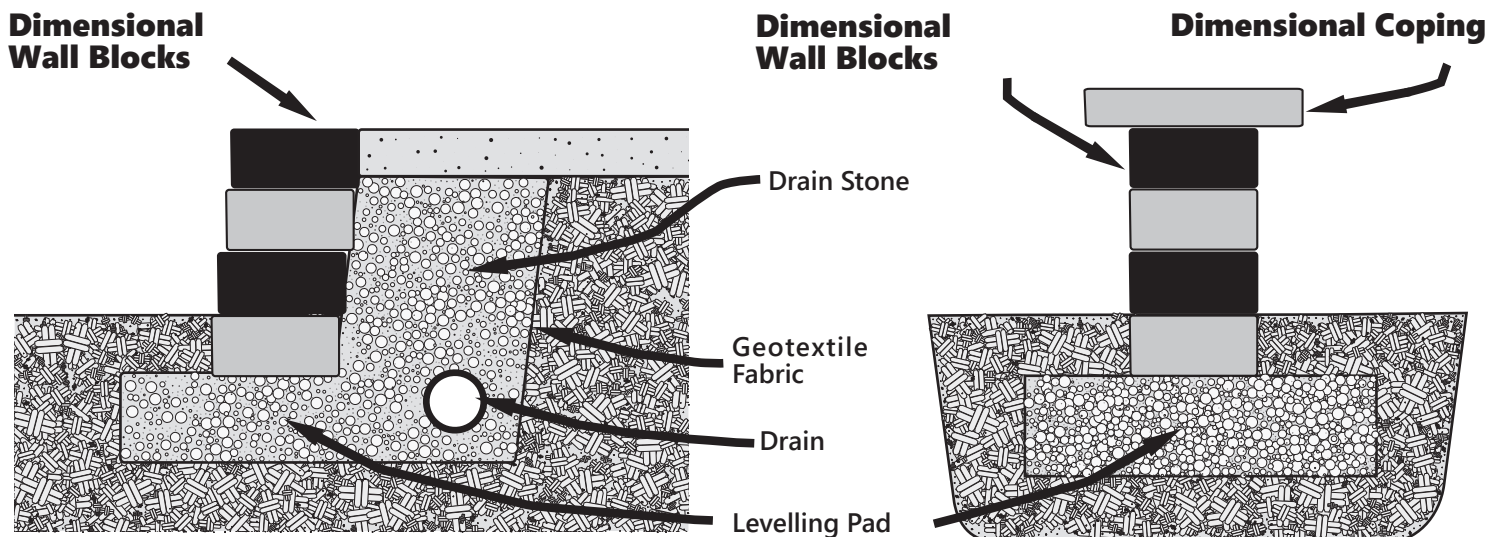

RETAINING / FREESTANDING WALL



RETAINING WALL

FREESTANDING WALL







OUTCROPPING BLOCK DETAILS

Stone & Bundling	Unit Dimensions		Units Per Bundle	Weight±/ Stone	
	Length (inches)	Width (inches)		lbs	kg
	42	12	1	750	340
	48	12	1	900	408
	69	12	1	1,100	499
	66	12	1	1,150	521.5



OUTCROPPING PALLET A





Pallet weight = ± 4000 lbs.
(±1,814 kg)
Coverage = 18 ft.²

	24	6	1	250	113
	36	6	1	320	145
	36	12	1	620	281
	48	6	1	450	204
	54	12	1	950	431
	72	12	1	1,300	589.5



OUTCROPPING PALLET B

Pallet weight = ± 4000 lbs.
(±1,814 kg)
Coverage = 18 ft.²

	24	6	1	250	113
	36	6	1	320	145
	60	18	1	1,600	725.5
	48	24	1	1,800	816







OUTCROPPING PALLET C

Pallet weight = ± 4000 lbs.
(±1,814 kg)
Coverage = 18 ft.²

Galvanized Steel hooks are available and required for reinforced walls. Actual weight and colour may vary.

OUTCROPPING CORNER BLOCK DETAILS



Stone & Bundling	Unit Dimensions		Units Per Bundle	Weight±/ Stone	
	Length (inches)	Width (inches)		lbs	kg
	42	12	1	750	340
	48	12	1	900	408
	60	12	1	1,100	499
	66	12	1	1,150	521.5



A CORNER PALLET

Pallet weight = ± 4,000 lbs.
(± 1,800 kg)
Coverage = 18 ft.²



FREESTANDING PALLETS

Stone & Bundling	Unit Dimensions			Units per Bundle	Weight± / Stone	
	L (inches)	W (inches)	H (inches)		lbs	kg
 Pallet G	72	30	12	1	2,080	943
 Pallet G	36	30	12	1	880	399
 Pallet G	36	30	6	1	440	199.5



OUTCROPPING PALLET G

Pallet weight solid = ± 3,450 lbs.
(± 1,552.5 kg)
Coverage = 10.5 ft.²





Stone & Bundling	Unit Dimensions			Units per Bundle	Weight± / Stone	
	L (inches)	W (inches)	H (inches)		lbs	kg
 Pallet H	60	30	12	1	1,540	698
 Pallet H	48	30	12	1	1,080	490
 Pallet H	48	30	6	1	460	208.5



OUTCROPPING PALLET H

Pallet weight solid = ± 3,150 lbs.
(± 1,417.5 kg)
Coverage = 11 ft.²



RANDOM STEPS

STONE & BUNDLING	Unit Dimensions		Rise	Weight± / Stone	
	L (inches)	W (inches)		lbs	kg
STEP A 	54	34	7"	458	208
STEP B 	60	24	7"	600	272
STEP D 	48	28	7"	567	257
STEP F 	48	24	7"	512	232

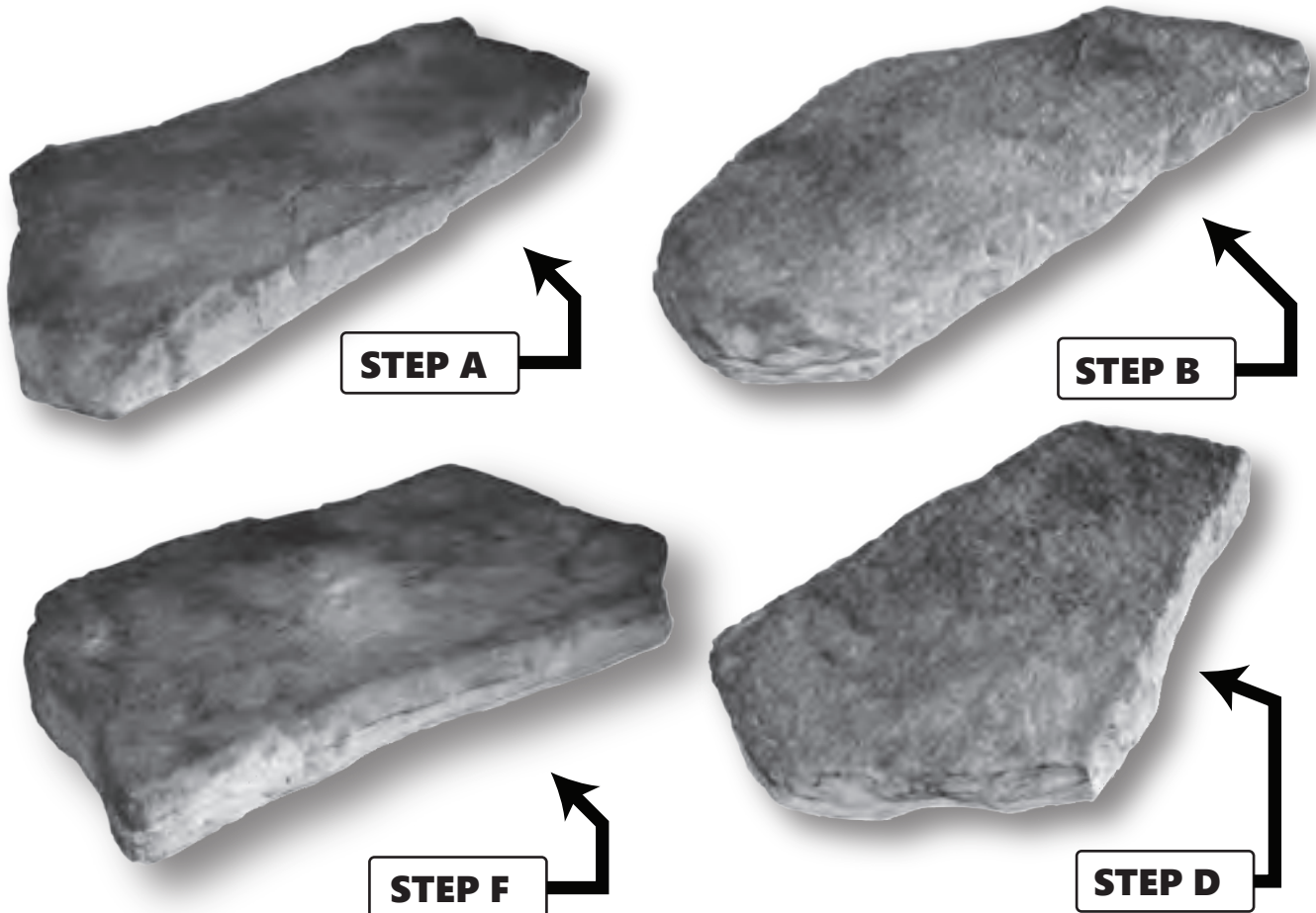
A CLOSER LOOK AT RANDOM STEPS (A, B, D, AND F)



DIMENSIONAL STEPS

STONE & BUNDLING	Unit Dimensions			Units per Bundle	Weight ±/ Stone		Weight ±/ Pallet	
	L (inches)	W (inches)	H (inches)		lbs	kg	lbs	kg
4' Long 	48	18	7	6	500	227	3000	1,360.5
6' Long 	72	30	7	3	1250	567	3750	1,701

FEATURES

- Stone-like shapes and textures create inviting walkways
- Consistent rise = fast installation and safe end result
- Quality materials = long term durability
- Multiple natural color blends available
- Complimentary products = creative possibilities
- All dimensional steps have 7" rise
- Steps palletized one size/pallet

STONE EDGE CURB

STONE & BUNDLING	Unit Dimensions			Units per Bundle	Weight ±/ Stone		Weight ±/ Pallet	
	L (inches)	W (inches)	H (inches)		lbs	kg	lbs	kg
	36	7	6	20	145	66	2,900	1,315

SUPERIOR STEPPERS

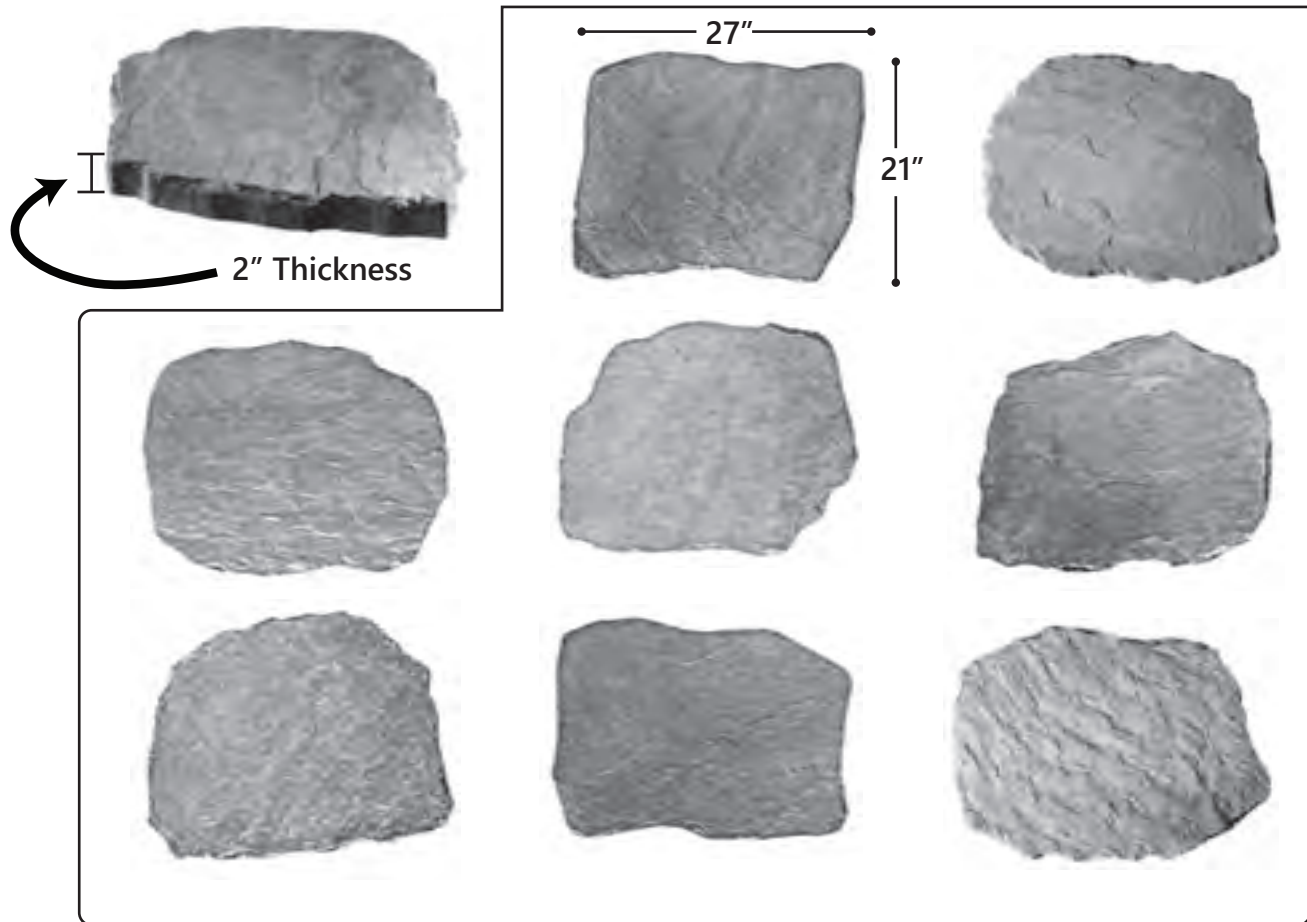

SUPERIOR STEPPERS FEATURES

- 8 different shapes for a rustic, authentic stone appearance.
- Superior Steppers are $\pm 27'' \times 21''$ wide, with a consistent 2'' thickness.

Bundle info.	
Sq. ft. per Bundle	~52'
Sq. Ft. per Piece	~3.25'
Pieces per Bundle	16
Weight per Bundle	1,300 lbs / 589 kg



GRAND FLAGSTONE BLOCK DETAILS

Outside dimensions of each layer are identical to all other layers, allowing any layer to be used anywhere in the pattern. Two (2) of each layer shown below are included in each pallet (8 layers total per pallet).

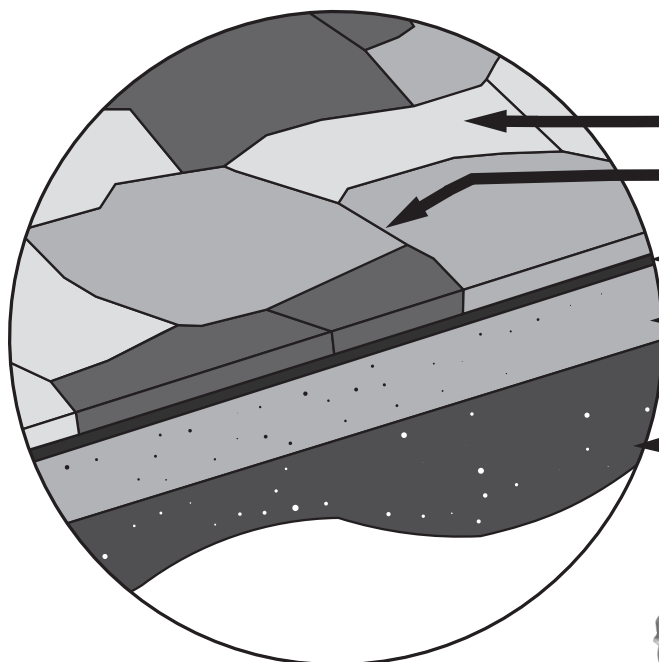
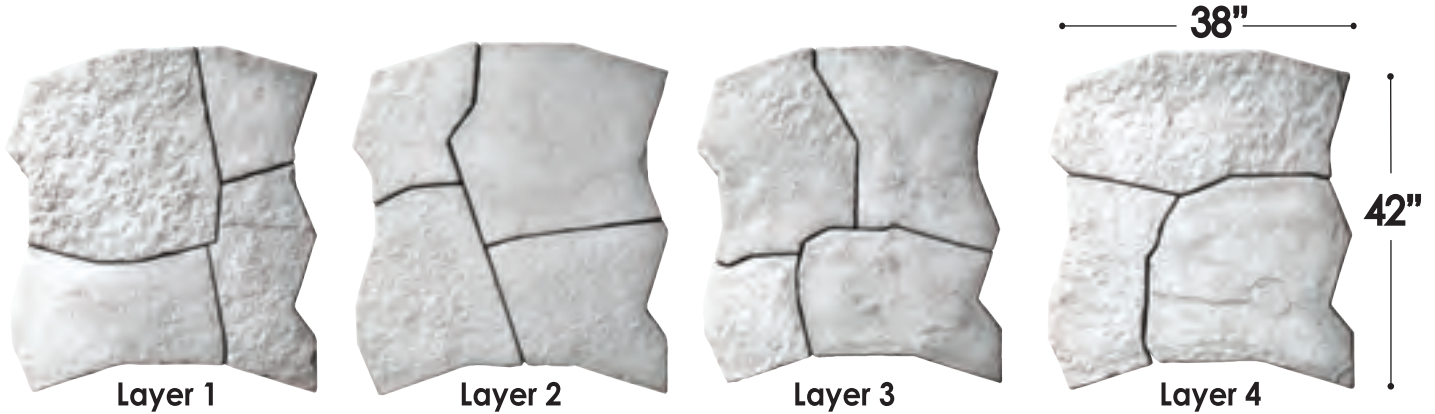

**GRAND FLAGSTONE
(1 3/4" THICKNESS)**

**JOINT
SAND**

**COARSE
BEDDING SAND**

**COMPACTED
GRAVEL BASE**

**COMPACTED
SUBBASE MATERIALS**

PACKAGING

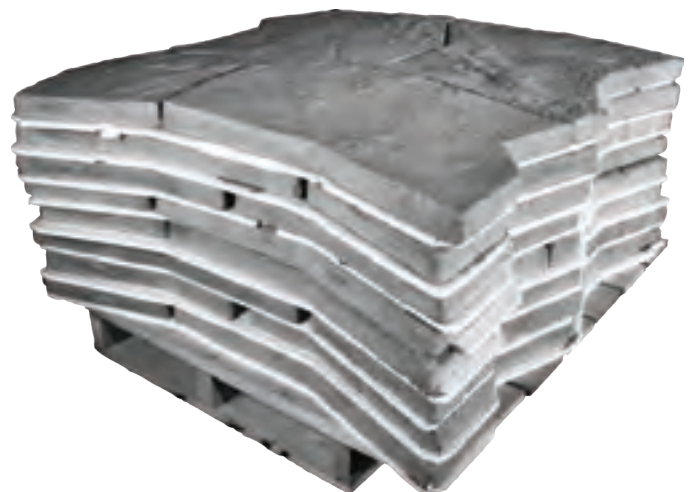
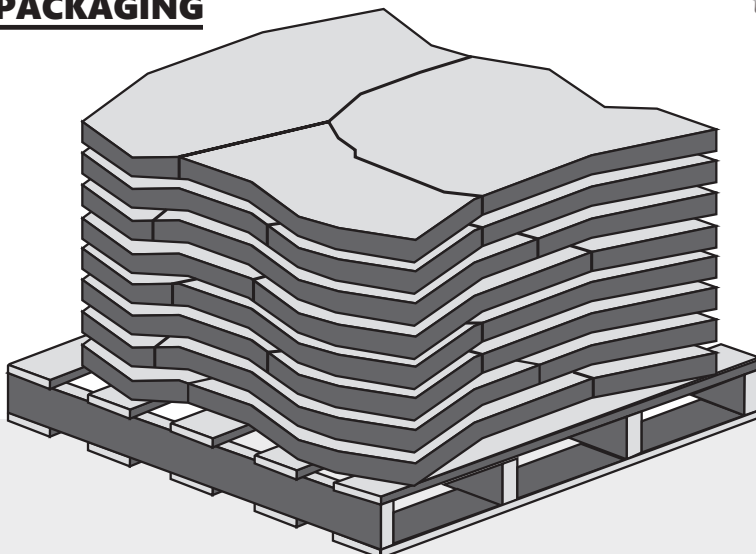

GRAND FLAGSTONE PALLET

- 8 Layers per pallet
- Pallet weight = ± 2,000 lbs / 907 kg (incl. pallet)
- Coverage = 90 sqft/pallet
- Section = 11 1/4 sqft per 1 layer

DIMENSIONAL FLAGSTONE BLOCK DETAILS

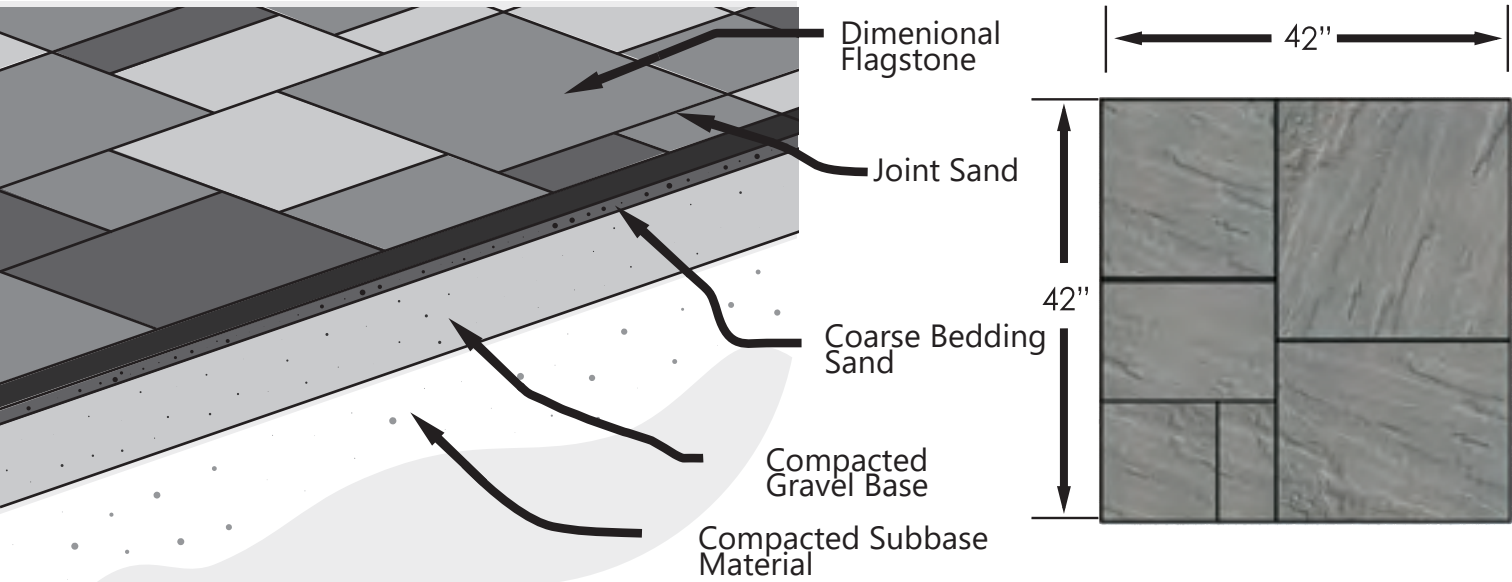

DIMENSIONAL FLAGSTONE PALLET

- All sizes on every pallet
- Consistent 2" thickness
- One Layer = One Pattern
- 8 layers per pallet
- Pallet Weight = 2,350 lbs / 1,057.5 kg (incl. pallet weight)
- Coverage = 98 sqft/Pallet

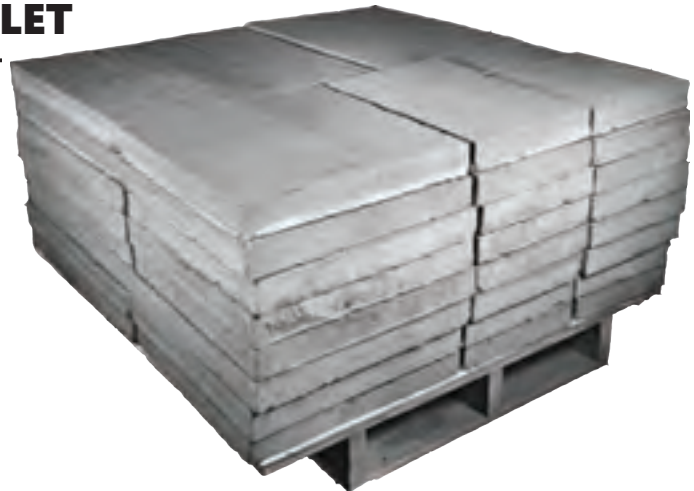

DIMENSIONAL FLAGSTONE CROSS-SECTION

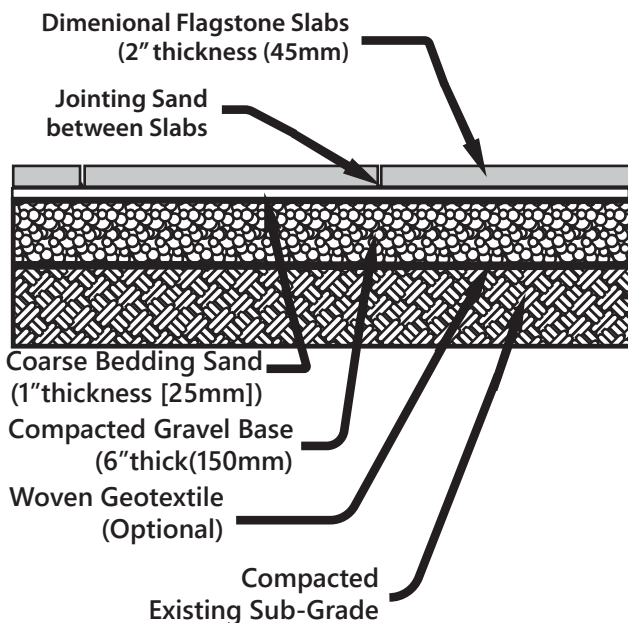

WALKWAY LAYOUT

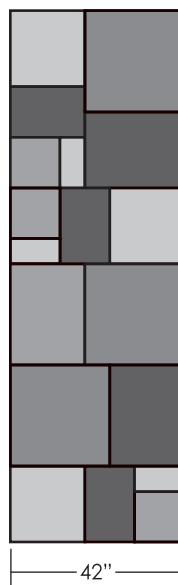

PATIO LAYOUT

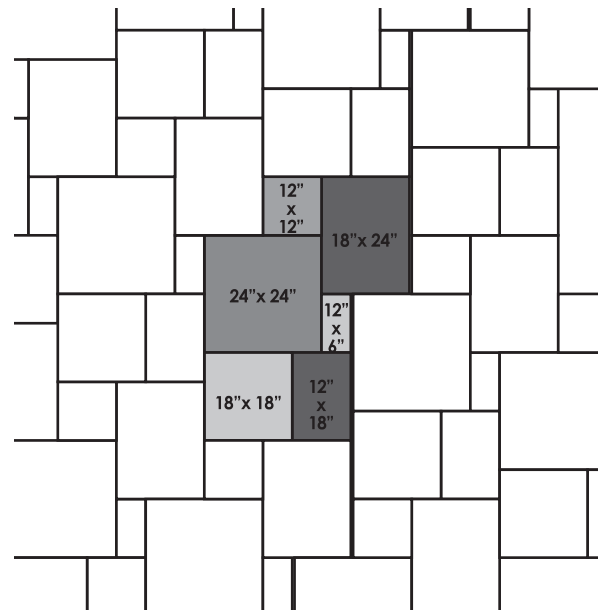

AMARO PAVER



Amaro Pavers 69.85mm

69.85mm Thickness	
Sq. Ft. per Bundle	±72
Sq.Ft. per Layer	9
Soldier per Bundle(LF)	96
Sailor per Bundle(LF)	288
Weight per Bundle	2,300 lbs / 1,043.5 kg
Stones per Layer	48
Stoners per Bundle	384

Amaro Paver

Length: 228.6mm (9")

Width: 76.2mm (3")

Thickness: 69.85mm (2.75")

AMARO FEATURES

- 12 textures provide a reclaimed brick aesthetic with consistent quality
- Rich, bold colors create perfect accents to make every project pop
- The paver can be placed with one hand to speed up installation

PATIO LAYOUTS

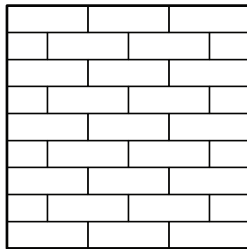

RUNNING BOND

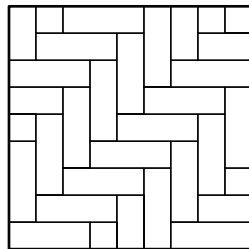

HERRINGBONE

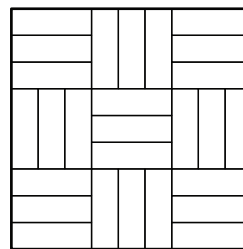

BASKET WEAVE

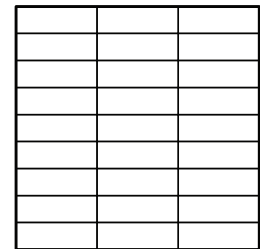

STACK BOND

These are some of examples of possible laying patterns for Amaro Pavers. Other patterns are possible depending on quantities of product being sold.

AMARO PAVER CROSS-SECTION (on-grade installation)

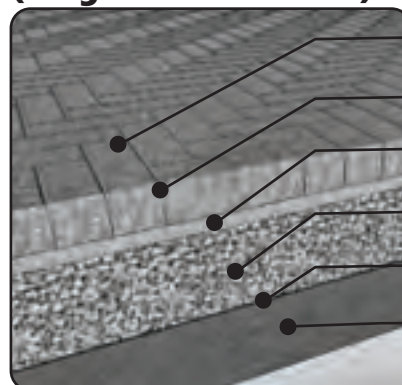
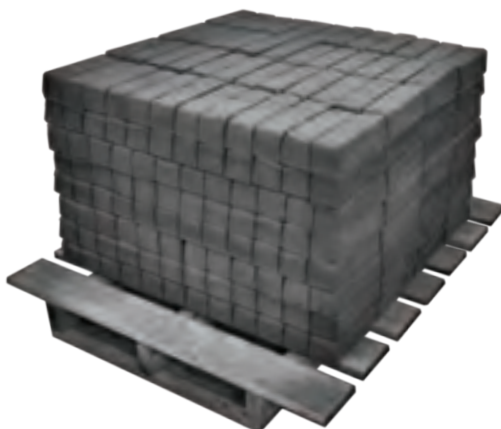

- AMAROPAVERS
- JOINTING SAND (ASTM C144)
- BEDDING SAND (ASTM C33)
- DENSE GRADED BASE
- GEOTEXTILE (OPTIONAL)
- COMPACTED SUBGRADE SOIL

BELVEDERE, DIMENSIONAL, ROCKTON FIRE PIT KITS

BELVEDERE PIT
Pallet Weight: ± 1320 lbs. / 598 kg

± 1" Gap
37" diameter Steel Ring
Blocks
Cap Layer Blocks shown for reference
Caps do not Contact Lip of Steel Ring
Steel Ring : 37" diameter
± 1" Gap
14 1/2"
Drainstone

PATTERN BLOCK LAYOUT

BLOCK KEY

17"x 6" 11 1/2"x 6" 6"x 6" 17 1/2" x 3" 11 1/2"x 3" 6"x 3" CAP

ROCKTON PIT
Pallet Weight: ± 1130 lbs. / 512 kg

51"
28" OPENING
12"
6" MIN. BASE
TYPICAL CONSTRUCTION
± 51"
± 30"
ABUT MATCHING BLOCK TAPERS

FOR BOTH ROUND & SQUARE FIRE PIT KITS

1. Familiarize yourself with the construction details shown on this page.
2. Mark out the location for your fire pit. *Note the dimensions shown are nominal so mark in area slightly larger than shown.*
3. Excavate for drainstone base (approx. 6").
4. Fill excavate for drainstone, level, and compact.
5. Place and center steel ring on prepared base.
6. Place blocks per the pattern. (For Round Kit, keep Blocks 1.5" off steel ring).
7. **WARNING:** DO NOT place Rosetta Fire Pits directly on Rosetta Flagstone product or any comparable concrete product or slab as high heat can adversely affect the integrity of the product.

... FOR ROUND FIRE PIT

8. After placing blocks around the ring, adjust the blocks in or out to make the circle close and fit tight. If the blocks do not close the circle, move all blocks slightly in. If the blocks seem too long, move the blocks slightly out.
9. Place caps in circle around fire pit. Adjust the caps in or out to make them fit tightly together.

DIMENSIONAL PIT
Pallet Weight: ± 1130 lbs.

512 kg
Wall Blocks Dimensional
28"x 28"x 12" Tall Steel Liner (Hangs directly on Blocks)
Overlap Blocks at Corners as shown.
44" x 44" SQUARE

NOTE: Not suitable for large fires. Fire size should not allow flame to contact Caps on Round Fire Pit.

Fire Pit metal insert may vary from that pictured above. Gas Conversion Kits Available.





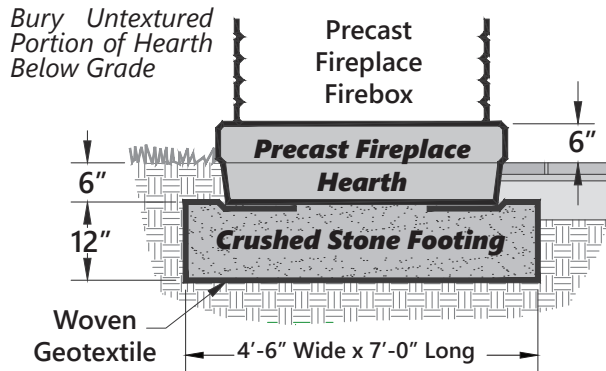

FIREPLACES

FOUNDATION INSTALLATION DETAIL

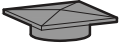

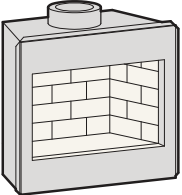
* Claremont Shown, Belvedere also available.

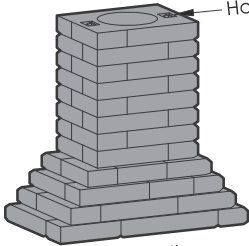
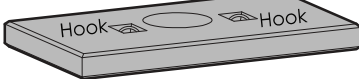
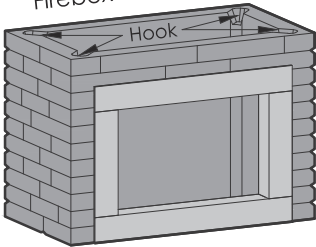
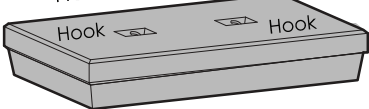
KIT INCLUDES ALL OF THE FOLLOWING COMPONENTS

METAL COMPONENTS	MASONRY COMPONENTS
 Chimney Cap with Spark Arrestor  Double Wall Stainless Steel Chimney Liner  Stainless Steel Fireplace Insert	<p>Cap = 200 lbs</p>  Chimney = 2,300 lbs  Hook Mantle = 1,400 lbs  Hook Firebox = 3,000 lbs  Hook Hearth = 3,000 lbs  Hook
<h3>OTHER INCLUDED COMPONENTS</h3> <p>Bag of Mortar</p>  <p>Mortar</p> <ul style="list-style-type: none"> • Required Fasteners • Detailed Instructions 	

- Beautiful natural stone appearance, unlike any other outdoor fireplace kit available.
- Complete kit, includes everything you need to construct the fireplace. (Components shown below).
- No concrete footing required in most cases, saves time and money.
- Very easy to install with convenient lift hooks cast into all large components.

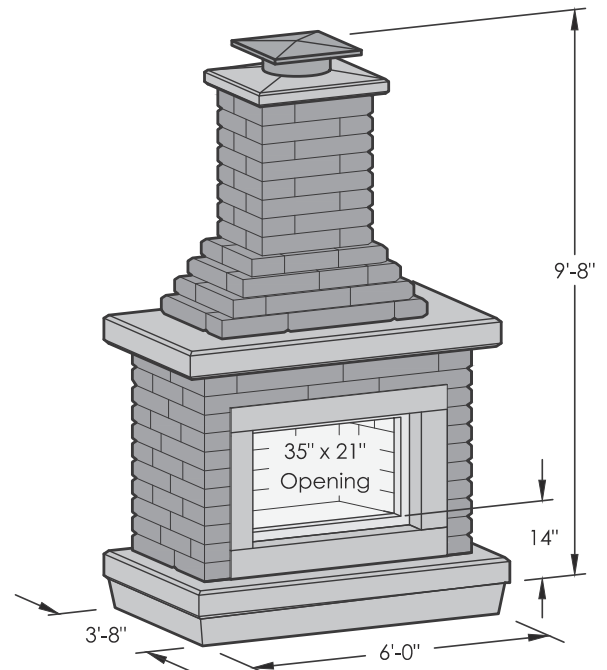

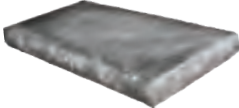
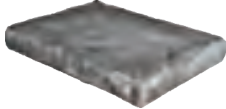
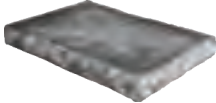

DIMENSIONAL COPING & CAPS BLOCK DETAILS

Stone & Bundling	Unit Dimensions			Units per Bundle	Weight± / Stone	
	L (inches)	W (inches)	H (inches)		lbs	kg
 24" Dimensional Coping	24	12 1/2	2 1/2	18	63	28.5
 18" Dimensional Coping	18	12 1/2	2 1/2	12	47	21
 Dimensional Coping End	19	12 1/2	2 1/2	6	49	22

DIMENSIONAL COPING PALLET OVERVIEW

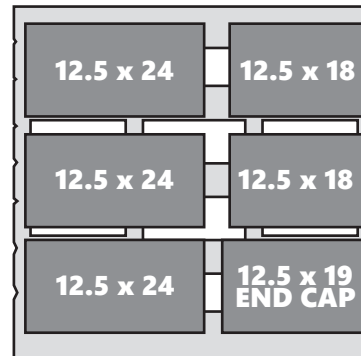
- 6 Layers per pallet
- 63 Linear Feet/pallet
- Section = 10.5 Linear Feet per 1 Layer



Stone & Bundling	Unit Dimensions			Units per Bundle	Weight± / Stone	
	L (inches)	W (inches)	H (inches)		lbs	kg
 Belvedere Column Cap	27	27	2 1/2	10	150	68

INSTALLATION INSTRUCTIONS

****ASK FOR OUR
PRE-PLANNED
PATIO DESIGN GUIDE
FOR FURTHER INSTALLATION
INSTRUCTIONS****



ROSETTA BY BROWN'S RETAINING WALL INSTALLATION

Thank you for your interest in installing a Rosetta by Brown's quality retaining wall system. The following guide describes proper installation techniques for the Rosetta by Brown's Outcropping, Belvedere, Dimensional, and Rockton Wall systems. This installation guide will help cover the basic steps required to construct a beautiful, structurally-sound retaining wall. For optimal color blending, you must mix and install products from several different pallets simultaneously.

PRE-CONSTRUCTION CHECKLIST:

Before you start construction, take the time to complete the necessary planning and preparation. This process will keep your project running efficiently and will aid in completing a quality installation.

Make sure to address the following:

SAFETY

Your safety program should address items such as personal protective equipment, maintaining safe slopes and excavations, fall protection, rigging and lifting, as well as any other relevant safety precautions.

ENGINEERING AND PERMITS

Obtain the necessary engineering designs and permits for your project. The soils for foundation and wall backfill should be properly evaluated by a trained professional. Unsuitable soils should be removed and replaced as recommended.

Note: This installation guide is intended to supplement a detailed, site-specific wall design prepared by a Professional Engineer. The construction documents for your project supersede any recommendations presented here.

REVIEW THE PROJECT PLANS

Take the time to review and understand the project plans and specifications. Make sure you understand the detailed design for the project before starting construction. A pre-construction meeting with the wall designer, construction inspector, wall contractor, and owner or representative is recommended. Do not be afraid to ask questions.

CONSTRUCTION PLANNING

Develop a plan to coordinate construction activities such as material delivery/storage, equipment access, etc., on your site. Make sure your plan specifically addresses how to control surface water during construction.

UTILITY LOCATION

Make sure to have underground utilities located and marked on the ground before starting any construction.

Note: Call your utility provider to schedule utility marking for your project site.

MATERIAL STAGING

Store retaining wall blocks in a location close to the proposed wall. Blocks should be kept clean and mud free. Blocks should also be stored in a location which will minimize the amount of handling on the project site. Store geogrid in a clean, dry location close to the proposed wall site. Keep the geogrid covered or in the shade until installation to avoid exposure to direct sunlight.

EQUIPMENT

Make sure you have the proper equipment to handle retaining wall blocks and pallets on the construction site.

Note: A specially-designed Lifting Device is required for the installation of Rosetta by Brown's Outcropping blocks.

Hand-operated equipment used in wall construction should include shovels, a 2' (600 mm) level, a 4' (1.2 m) level, brooms, hammers, chisels, tape measures, string, spray paint, a laser level, pry bars, concrete saws, and a walk-behind vibratory plate compactor capable of delivering a minimum of 2000 lbs. (9 kN) centrifugal force.

Personal protective equipment should include appropriate clothing, steel toe boots, eye protection, hardhats, gloves, hearing protection, fall protection, rigging, and other items as necessary to ensure a safe working environment.

STEP 1 — DESIGN & LAYOUT

The starting point of any project is the preliminary design drawing. The drawing should include an overview of the project (site plan) and one or more cross-sections through the wall (profiles), and should be done on graph paper to a convenient scale so that it is easy to read and estimate quantities from.

POINTER: Remember to incorporate the layout of the drainage system, specifically the outlet(s), in the design.

NOTE: The Ontario Building Code requires that a building permit be obtained for walls in excess of 1 m that are adjacent to: (A) public property; (B) access to a building; or (C) private property to which the public is admitted. To assist with building permit applications, typical cross-sections are available for most walls (and at various heights) for reference, or arrangements can be made for a complete engineered design to be conducted.

It is recommended that an engineered design be prepared for walls that either: (1) include geogrid; (2) are being installed on questionable soil; (3) have steep slopes at the top or bottom; (4) are waterfront applications; (5) or include railings/barriers.

STEP 2** — ESTIMATE QUANTITIES

Include in Estimate:

1. Volume of the excavated material.
2. Area of geotextile.
3. Length of drainpipe.
4. Volume of granular.
5. Number of wall units.
6. Number of coping units.

Optional items to estimate: (a) area of geogrid; (b) amount of adhesive.

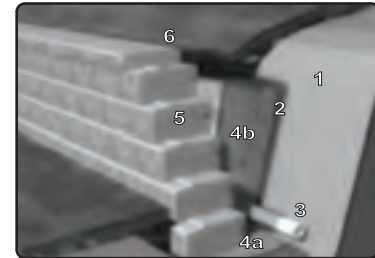

VOLUME OF EXCAVATION — To calculate the total excavation volume, you need to know the depth and width of the base trench, and the angle of repose of the native soils. These items are discussed in greater detail below.

AREA OF GEOTEXTILE — Geotextile should line the entire drainage layer behind the wall from top to bottom. Ensure there is adequate extra material at the top of the slope to be able to fold the geotextile back towards the wall once all the drainage material is in place. Also remember to provide extra material for overlap of lengths.

LENGTH OF DRAIN PIPE — A drain pipe is required behind all retaining walls to provide a route for water to escape. The drain pipe should run the full length of the wall.

VOLUME OF GRANULAR — Granular fill is required for the granular base (4a) and the drainage layer behind the retaining wall (4b). The granular base material should be well graded, free drainage material suitable for the given application. (e.g. Granular A). The drainage material should be clear stone (no sharps) or pea gravel. To calculate the respective volumes, measure the cross sectional area of each of the materials from each of the cross-sectional drawings and multiply these by the length of the applicable wall sections.

POINTER: If the native soil is a compactable material, it may be possible to use it for part of the backfill behind the retaining wall (clear stone or gravel would still be required for at a minimum of 300 mm (12") friction drainage layer directly behind the wall). The geotextile would be placed between the replaced native material and the drainage layer.

NUMBER OF WALL UNITS — Remember to provide enough wall units for the exposed and buried portions of the wall. The rule of thumb is to — at a minimum — fully bury one course (row) or 10% of the total wall height, whichever is greater. The Easy Wall Estimator on page 11 has been developed to assist with this calculation.

NUMBER OF COPING (WALL CAP UNITS) — The Easy Wall Estimator on page 11 also includes a table to assist with this calculation. Provide some extras if there are corners or curves in the wall where coping units may need to be cut.

STEP 3 — EXCAVATION

POINTER: Complete your locates prior to starting the work. The excavation depth is the sum of the depth of the buried course(s) plus a minimum of 150 mm (6") for the granular base. The offset between the front of the excavation and the front of the wall is typically 100-150 mm (4-6"), which is the minimum width that can be properly compacted using standard tools of the trade. The offset between the back of the wall in the back of the excavation is at a minimum 150 mm (6") for low walls (<27") and 300 mm (12") for higher walls. The total width of the excavation is the sum of the front offset, the depth of the unit and the back offset.

The angle of repose for the native soils is the angle at which the soil can be left without collapsing. This can range from near vertical (90°) from the horizontal — for dense clay — to 27° from the horizontal — for loose sand. The higher the angle, the smaller the excavator. When completed, the bottom of the excavation should be slightly sloped towards the drain pipe discharge point(s), and should be free of debris such as large stones, roots, etc. run a compactor over the bottom to level it out and to evaluate the stability of the native material.

**Step 2 — The offset between the front and back of the wall of the excavation equals the specified length of the geogrid.

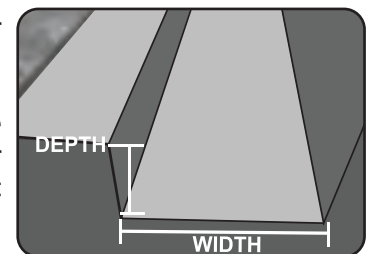

STEP 4 — PREPARE FOUNDATION

POINTER: A solid and flat granular base will simplify the remainder of the installation process. Take the time to make sure this step is done correctly.

Backfill the base of the trench in 75 mm (3") lifts to desired grade, compacting the material to a minimum 98% Standard Proctor density. Leave a v-notch at the back of the excavation for the drain pipe. Set a string level to verify final grade. Ensure the base is level front to back and side to side. This will minimize the leveling of individual blocks and will ensure straight lines and smooth arcs. As an option, a skim coat (2") thick layer of unreinforced concrete can be used to create a durable leveling surface.

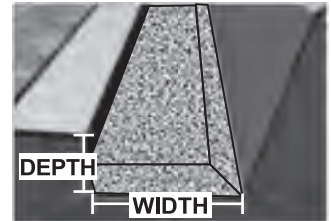

Lay the geotextile starting just under the back of the wall and up the back slope of the trench. Remember to leave adequate material at the top of the slope for the fold back, and to overlap the separate pieces at a minimum of 150 mm (6"). Use sandbags or similar items to keep the geotextile and place as required. Place the drain pipe in the v-notch at the back of the foundation, surrounding it with drain rock.

STEP 5 — LAYING FIRST COURSE

Select the starting point for the wall. If the base of the wall is stepped-up, start at the lowest point and work your way up. Remember to adjust for the natural batter in the wall between steps. If there is an outside corner, start with the corner unit. This will potentially avoid having to cut stones to fit later on. Set a string level to mark the back of the first course. Use a level to ensure blocks are level front to back and side to side.



POINTER: For a non-battered wall, level the blocks, side to side, but tilt the back down slightly (approx. 2%) so that the entire wall, when constructed, leans slightly toward the soil being retained. Backfill on both sides of the wall simultaneously to prevent the blocks from moving. Place material in 3" lifts and compact to 95% Standard Proctor density. Compacted backfill should be level with the back of the course.

STEP 6** — REMAINING COURSES

Sweep the top of each course prior to proceeding. Place the next course of units in a running bond pattern so that the middle of the unit is approximately above the joint between the underlying blocks. NEVER ALIGN BLOCKS VERTICALLY. After laying a course, backfill behind the wall to ensure the same elevation as the top of the just-placed units.

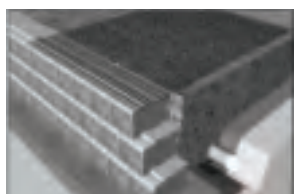

Ensure compaction equipment is adequately-sized to provide proper compaction

POINTER: but not so large as to push the wall out. Check levelness of wall after each layer of backfill. Realign the wall if required.

STEP 7 — COPING AND GRADING

Where coping is required, sweep the top of the underlying course prior to proceeding. Place a line of butyl tape or Bond Loc adhesive near the front and back of the underlying course. Place the coping unit on top and apply some pressure to secure it. Prior to backfilling behind the coping and last wall unit, pull the filter cloth towards the back of the wall and tuck in place. Filled to final grade using a layer of clay and then topsoil to suit desired conditions, and ensure final slopes allow for proper drainage away from, or over the top of the wall.

ADDITIONAL TIPS — GEOGRID REINFORCED WALLS

In simple terms, a retaining wall uses its total weight to hold back the soil that is located behind it. With a gravity wall, the total weight is the sum of the blocks and the backfill within which the geogrid is located. For geogrid walls, the following changes are made to the Installation Instructions.

Step 6** — Pre-cut the geogrid from the roll to the specified length and perpendicular to the direction of primary strength. Continue wall and backfill placement as outlined above up to elevation of the first layer of geogrid. The compacted back-fill material should be level with the back of the wall unit to allow the geogrid to be laid out flat. Lay the geogrid starting within 25 mm (1") of the face. Lay the next row of wall units to secure the geogrid in place. Pull the geogrid taught to its full length and stake in place at the back to maintain tension. Backfill and compact next lift.

RETAINING WALL (GENERAL)

BASE PREPARATION

Proper base preparation is a critical element in the construction of your retaining wall. Not only is it important to provide a stable foundation for the wall, but a properly-prepared base will greatly increase the speed and efficiency of your wall installation.

Proper base preparation starts with the subgrade soils (soils below the leveling pad). Existing soils must be removed to the bottom of the leveling pad elevation for the retaining wall. A typical wall requires excavation of at least 12" (300 mm). This will provide 6" (150 mm) for the leveling pad and 6" (150 mm) of minimum bury of the blocks.

Note: *the excavation and bury depth will vary by product type and design. Please see project plans or product-specific information for further information.*

At a minimum, all topsoil, organic, unsuitable soils should be removed from below the wall. The minimum width of the leveling pad should be 18" (465 mm) wider than the width of the block. This will provide 6" (150 mm) in front of and 12" (300 mm) behind the bottom block.

Once excavated, the subgrade soil should be compacted to a minimum of 95% maximum density as determined by a Standard Proctor test (ASTM D698). At this point the soil should be firm, dry, and free of topsoil debris, stones, roots, etc. Consult a soils engineer if in doubt. Any unsuitable material must be excavated and replaced as directed by the engineer.

LEVELING PAD

Base preparation continues with proper leveling pad construction. An open-graded (free-draining) crushed stone leveling pad is typically used for retaining walls. Walls can also be designed with a dense-graded crushed stone or concrete leveling pad. The choice of which type of leveling pad to use is made by the wall designer and depends on several factors including the bearing capacity of the native soil, location of the drain outlet, conditions at the base of the wall, and any other special considerations for the wall.

The leveling pad material should be placed and compacted to provide a uniform, level foundation on which to construct the retaining wall. Proper elevation can be established with a laser level or transit. Check for level both parallel and perpendicular to the wall.

Place and compact leveling pad material as specified in the wall design. If crushed stone is used, place the stone in uniform loose lifts at a maximum of 6" (150 mm) thick. Lift sizes are relative to the size of the compactor being used. Compact the stone with a minimum of 3 passes with a 24" (600 mm) wide, walk-behind vibrating plate compactor.

Note: DO NOT place a thin layer of sand between the leveling pad and bottom block. This layer will reduce the sliding resistance between the leveling pad and the bottom block, as well as reduce the drainage capacity of the foundation stone.

DRAIN

A drain is installed in the lowest part of the open-graded (free-draining) stone behind the retaining wall. If an open-graded crushed stone leveling pad is used, the drain is installed on the bottom of the crushed stone leveling pad. If a dense graded crushed stone leveling pad is used, the drain is installed immediately on top of the dense graded stone.

Typically, a 4" (100 mm) diameter perforated "sock" pipe is used. Daylight the drain pipe at the ends and/or through the face of the wall every 50' to allow for drainage. The pipe can also outlet into a nearby drainage ditch or catch basin. Because water can flow both ways through the drain pipe, connection to a catch basin or active storm sewer should only be made under the direction of a Professional Engineer.



RETAINING WALL (GENERAL)

SETTING THE BOTTOM COURSE OF BLOCKS

Proper placement of the bottom course of wall stones is critical in determining the overall appearance and integrity of the finished project. Take extra time on this step and the rest of the project will go smoothly. At this point, you need to determine the best point of origin for the wall. If you have a fixed point, such as a building corner or a 90° corner, you will want to start the wall from that point and work your way out. This will minimize cutting of blocks. If there are no fixed points, start the wall at the lowest design elevation, as it is easier to step the base up than it is to step the base down.



- Properly mark the location of the retaining wall. A string line or offset stakes are typically used to establish horizontal and vertical alignment. Where applicable, remove the bottom lip from the back edge of the blocks with a hammer and chisel (bottom course of blocks only) so the blocks will lie flat on the leveling pad. Place a complete row of blocks on the prepared leveling pad. Blocks should be placed tight together.
- Check all blocks for level from front to back and side to side as they are placed. Place and compact backfill in front of the bottom row of blocks to help hold them in place. Compaction should be to 95% maximum density as determined by a Standard Proctor test (AST D698).
- Place open-graded crushed stone in the cores of the blocks, between the blocks, and at least 12" (300 mm) behind the wall. A stone meeting the gradation requirements of ASTM No. 57 with no material passing the No. 200 sieve is preferred. Place the stone in uniform loose lifts a maximum of 8" (200 mm) thick. Fully consolidate the stone. Carefully hand tamp the stone within 12" (300 mm) of the blocks. Place non-woven geotextile fabric between the drainstone and the remaining backfill material if specified.
- Backfill behind the drainstone with material as specified in the project design. Place the material in loose lifts as specified, but not to exceed 8" (200 mm) maximum. Granular backfill must be compacted to a minimum of 95% maximum density as determined by a Standard Proctor test (ASTM D698). Do not use any organic, topsoil, frozen, soft, wet, or loose soils when backfilling the wall.
- Re-check all units for level and alignment and sweep the top of each course of blocks clean before starting construction of the next course.

SETTING THE UPPER COURSES OF BLOCKS

Placing the next course of blocks is similar to placing the first course. Blocks should be placed to establish a running bond pattern (Rosetta or Dimensional Collections) or to follow an irregular pattern (Rosetta BY Brown's Outcropping and Belvedere Collections).

Blocks should be installed with their sides pushed tight. Push blocks from Rosetta By Brown's Outcropping Collection forward until the lip on the back of the block comes in full contact with the blocks below. Make sure that no stones get caught or wedged between the lip and the back of the blocks below. Walls without the lip on the bottom (Rosetta, Belvedere, and Dimensional Collections) should not be stacked exactly vertical. Instead, they should be set back approximately 1/2" for every 6" of wall height to provide for a wall batter.

ROSETTA BY BROWN'S OUTCROPPING: Place a layer of non-woven geotextile fabric directly behind the blocks. This will keep materials from eroding through the small voids between the blocks.

- Place geogrid reinforcing behind the wall as specified in the project documents. See Geogrid Installation information in the next section for further details.
- Place and compact open-graded crushed stone in the cores of the blocks, between the blocks, and at least 12" (300 mm) behind the wall following the procedure used for the bottom course of blocks.
- Place non-woven geotextile fabric between the drainstone and the remaining backfill material if specified.
- Place and compact backfill behind the drainstone following the procedure used for the bottom course of blocks.
- Re-check all units for level and alignment and sweep the top of each course of blocks clean before starting construction of the next course.

REPEAT THESE STEPS WITH EACH COURSE OF BLOCKS TO THE TOP OF THE WALL.

RETAINING WALL (GENERAL)

GEOGRID INSTALLATION

The stability of reinforced soil walls relies on the interaction between geogrid reinforcement, soil in the reinforced zone, and the retaining blocks. It is very important that the reinforced soil walls be constructed as per the detailed design prepared by a Professional Engineer. Make sure you are using the proper type and strength of geogrid listed in the design. The geogrid layers need be placed at the proper elevations and to the proper distances into the reinforced soil zone detailed in the design. It is also critical to use the appropriate backfill soil material in the reinforced soil zone.

- Construct the wall up to the elevation of the geogrid layer shown in the design.
- Place geogrid layers as shown in the project details extending into the reinforced soil zone to the design length.
- Geogrid must be installed with the strong direction (roll direction) into the reinforced soil zone and not parallel to the wall.
- Geogrid must be placed in a continuous sheet throughout its length from the connection at the blocks to the back of the reinforced zone.
- Do not splice or overlap the geogrid.
- For all retaining wall products — except the Rosetta By Brown's Outcropping Collection — use the next layer of blocks to secure the front end of the geogrid. Make sure the geogrid is as close as possible to the front face of the wall without being visible.
- Pull the geogrid taut to eliminate any folds and pretension the geogrid.
- Pin or secure the back edge of the geogrid before placing the reinforced fill.

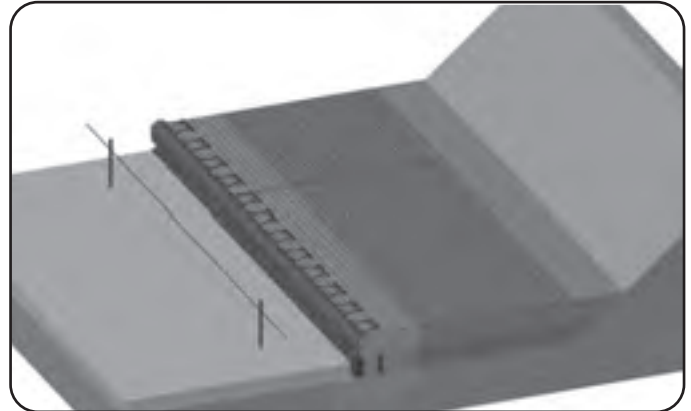

FINISHING THE TOP OF THE WALL

Completing a few simple tasks near the end of the project will ensure that the wall will function properly and look good for years to come.

- Grade the top of the wall in such a way that surface water runs off away from the wall. Never leave the top of the wall graded where surface water will pond behind the wall, or saturate the backfill soils.
- Place a layer of non-woven geotextile fabric over the top of the drainstone at the back of the wall. This will keep topsoil from migrating into the drainstone and causing problems.
- If required, place the coping layer on the top of the wall. The coping blocks should be placed towards the front edge of the wall blocks and should sit securely on top without tipping forward under their own weight. The coping layer should be carefully adhered with a concrete adhesive specifically formulated for segmental concrete block wall construction.

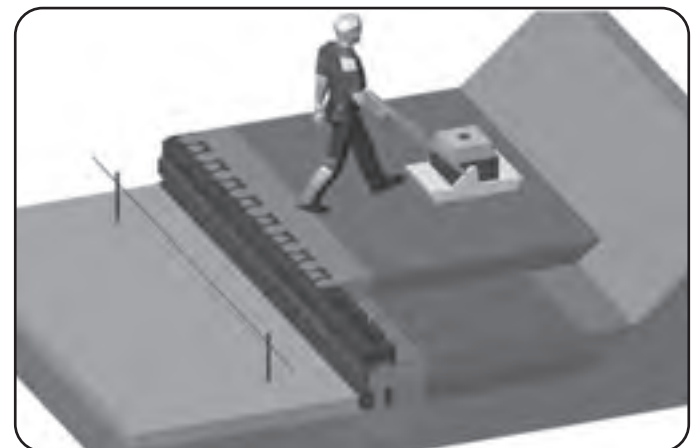

MORE INFORMATION

Refer to product-specific Typical Construction Details for specific applications and construction practices such as chimney drain construction, fence installation, corner construction, drain placement, curve construction, and other details.

Typical allowable construction tolerance at the wall face is 1" in 10' (1:120) in the vertical and horizontal directions, and a rotation tolerance of 2° from wall batter. Once you commence working, continue without interruption or delays. This will help expedite construction and minimize the time the excavation is open. If at any time groundwater seepage is observed along the exposed excavation behind the retaining wall, contact the wall designer immediately to determine the corrective action needed. The construction site should be graded and maintained to direct surface water runoff away from the retaining wall throughout the entire construction process. If there is a rain event with surface water runoff producing erosion or scour near the retaining wall, contact the wall designer immediately to determine the corrective action needed.

TYPICAL GRAVITY WALL SECTION

This page shows typical construction details for Gravity walls. These drawings are representative of the major components required in wall construction. Specific details, including geotextile reinforcement layers, drainage details, soil requirements, etc., shall be per professionally-engineered design for wall.

For more cross-section and design options, please visit www.rosettahardscapes.com and click on "engineering."

OUTCROPPING RETAINING WALL

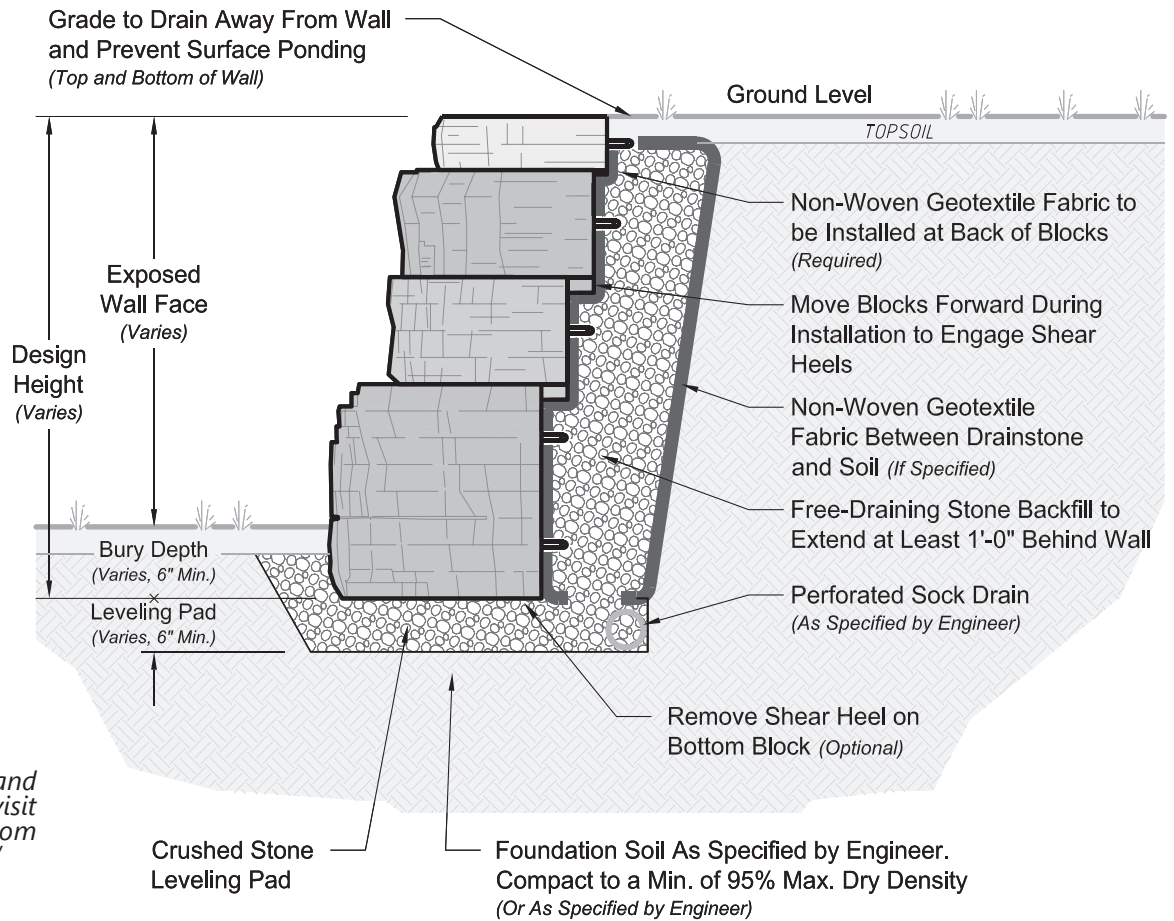

NOTE: Block size and placement shown are for reference only. Individual Rosetta by Brown's blocks will vary with installation pattern. Actual design must be performed by a licensed engineer.

TYPICAL FREESTANDING WALL

This page shows typical construction details for Outcropping Freestanding walls. These drawings are representative of major components required in wall construction. Specific details including drainage details, soil requirements, etc. must be based upon professionally-engineered per-project.

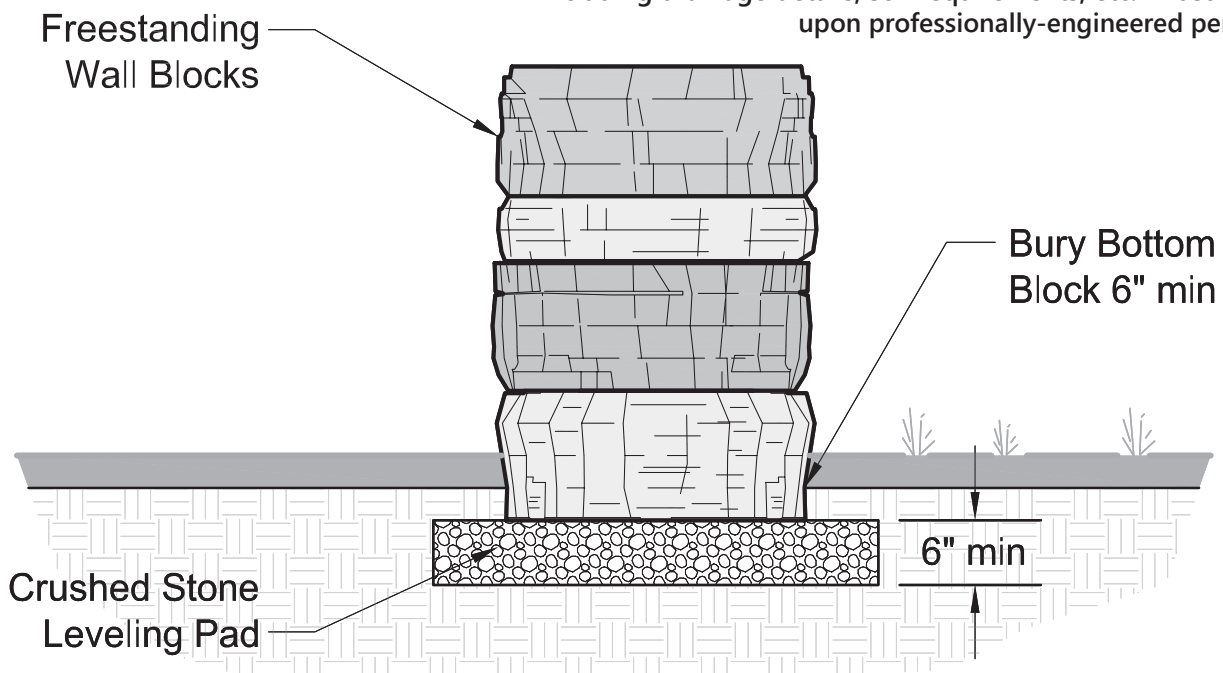

OUTCROPPING NOTES FOR INSTALLATIONS REQUIRING GEOGRID

OUTCROPPING RETAINING & FREESTANDING WALLS

Please visit www.rosettahardscapes.com for detailed cross-sections of geogrid reinforced Outcropping walls. For Rosetta By Brown's Outcropping installations, do not overlap geogrid over top of blocks. Instead: un the geogrid directly up to the back of the blocks.

In addition to this reinforcement, a Paraweb strap must be installed through each lifting hook in the back of the Outcropping blocks. Please see standard details for Reinforced Outcropping Walls for further information.

Place and compact drainstone and reinforced fill following the procedure used to set the bottom and upper courses of blocks. It is important to place and compact stone and reinforced fill starting at the back of the retaining blocks and extending into the reinforced soil zone. This will help eliminate "bunching" of the geogrid reinforcement.

Reinforced zone fill material is typically a sand or gravel with less than 5% "fines" (material passing the No. 200 sieve). This material is usually classified as a GW, GP, SW, or SP. It is very important that you only use the fill material specified in your project design drawings and specifications.

Place retained soil immediately between the reinforced soil zone and the back of the excavation. Material should be placed in loose lifts of 8" (200 mm) maximum and compacted to 95% maximum density as determined by a Standard Proctor test (ASTM D698). Bring the reinforced and retained soil up to grade at the same time. At no time should the elevation of the reinforced soil be more than 1 block higher than the retained soil. Tracked construction equipment should not be used directly on the geogrid. A minimum of 6" (150 mm) of fill is required between tracked equipment and geogrid to prevent damage to the grid. Rubber-tired equipment may pass over the geogrid when traveling at low speeds of 5 mph (8 km/h) or less. Avoid any sudden stopping or turning of construction equipment in the reinforced fill zone to prevent moving or damaging the geogrid layers. Follow geogrid manufacturer's requirements, including requirements for vertical separation and overlap of geogrid.

For All Installations Never stack blocks more than one course above grade of backfill.



OUTCROPPING LAYOUT NOTES

One of the unique features of the Rosetta by Brown's Outcropping system is multiple block heights. To provide a uniform wall batter with multiple height blocks, the setback of the blocks varies proportionally with the block height. This setback in blocks is achieved with shear heels which are cast into the Rosetta by Brown's blocks. For a 6" high block, the shear heels are 3" deep (1x3"). For a 24" high block, the shear heels are 6" deep (2x3").

To ensure proper wall alignment and to account for the multiple height blocks and varying setbacks, the bottom row of blocks must be adjusted based on their height.

Set up a traditional string line for the back of the wall, then offset the blocks as per the following figure.

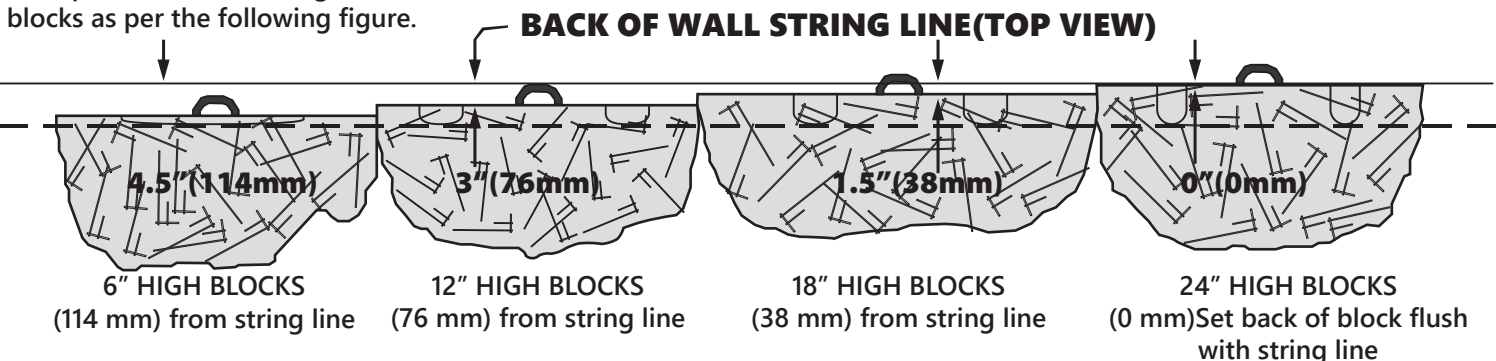

OUTCROPPING LIFTING DEVICE

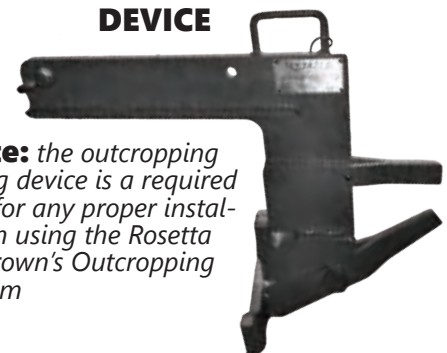

Note: the outcropping lifting device is a required tool for any proper installation using the Rosetta by Brown's Outcropping System

OUTCROPPING CURVES

Rosetta by Brown's Blocks have shear heels to help with wall integrity and provide a setback from lower blocks in the wall. This causes the wall to batter back. The batter is important to the engineering design of the wall, and it must be accounted for during construction of a curved wall section.

OUTSIDE (CONVEX) CURVE

If you are constructing an outside (convex) curve, the wall batter will cause the blocks higher in the wall to have a shorter radius around the curve than lower blocks. This will cause the higher blocks to "grow" in the wall layout pattern. (This is similar in concept to the inside lane of a race track that is shorter than the outside lane). The result is a potential overlap between some of the blocks in the wall. The best way to deal with this overlap is to saw cut the end of the smaller block, which allows the other blocks to fit tightly together. This will properly engage all of the shear heels. Saw cutting here is typically made on an angle to match the taper on the block you are abutting.

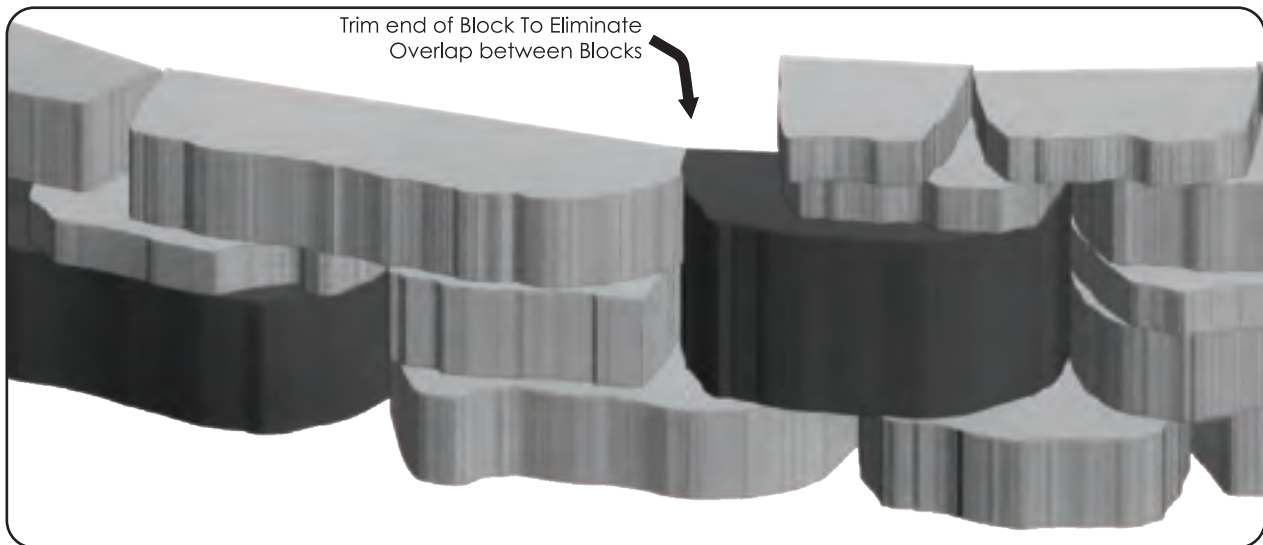

INSIDE (CONCAVE) CURVE

If you are constructing an inside (concave) curve, the wall batter will cause the block higher in the wall to have a longer radius around the curve than the lower blocks. The important step when constructing an inside curve is to keep all blocks fitted tightly together. In most cases, the blocks will touch somewhere along the sides of the blocks, not at the back of the blocks. If needed, you can trim the ends off of some blocks to prevent gaps from opening up between blocks. When constructing a curve with a short radius, voids may form at the back of the wall where blocks meet. If this happens, simply fill the void areas with filter fabric and drainstone.

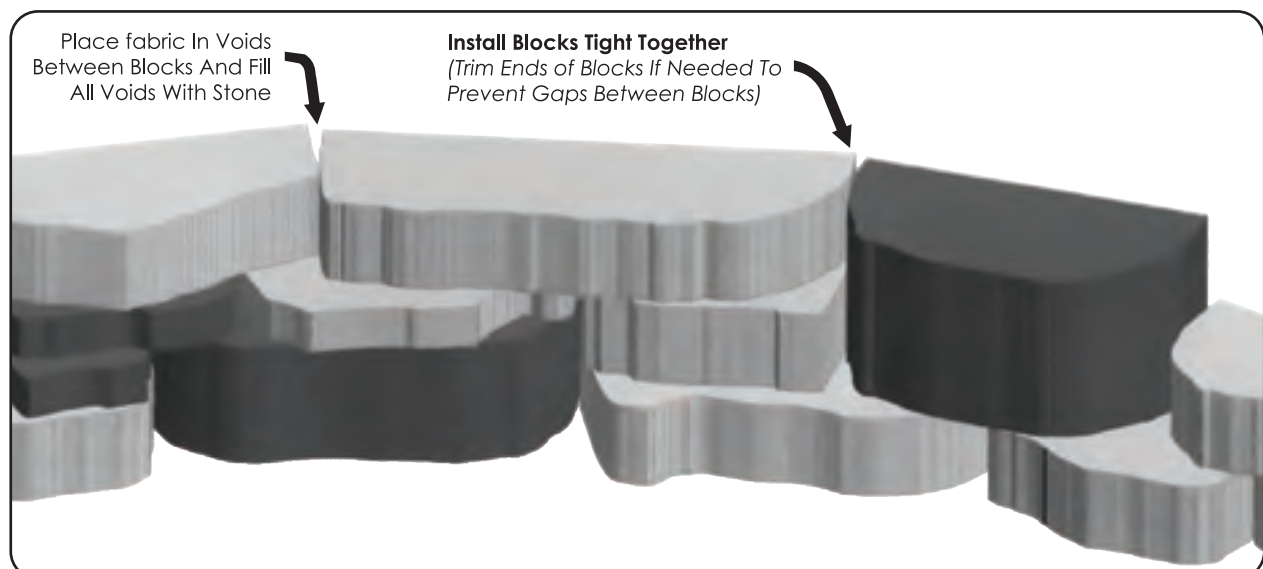

OUTCROPPING PATTERNS

Please note that the length dimensions shown for Rosetta by Brown's blocks are rounded for reference. The actual length of the constructed wall will vary slightly from the pattern dimensions shown.

Each pattern is made up of (2) A Pallets, (2) B Pallets, and (1) C Pallet.

2' X 45' WALL SECTION SHOWN:

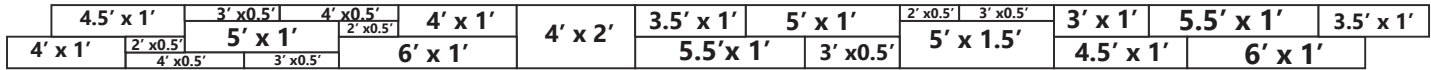

3' X 30' WALL SECTION SHOWN:

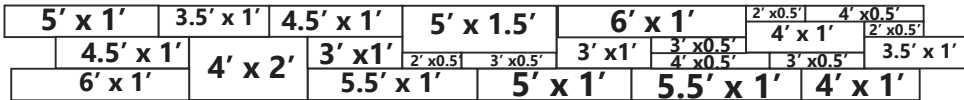

4' X 22.5' WALL SECTION SHOWN:

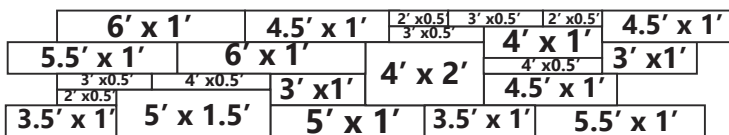

5' X 18' WALL SECTION SHOWN:

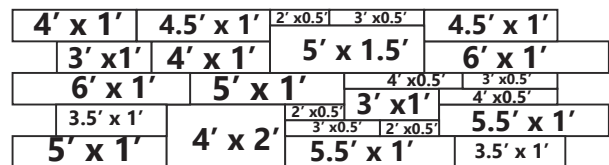

Outcropping Corners (shown below in schematic) can be constructed using the A-Corner Pallet for both inside and outside corners as shown. Where inside corners are not visible, regular blocks (A, B, C) can be used. Where a 6" corner block is required, the use of freestanding blocks is possible. Refer to Freestanding Outcropping for block specifications. The set back as shown is 6" every other row. For further installation details and to discuss specific applications, please speak to one of our sales associates.

OUTCROPPING OUTSIDE CORNER ASSEMBLY DETAIL

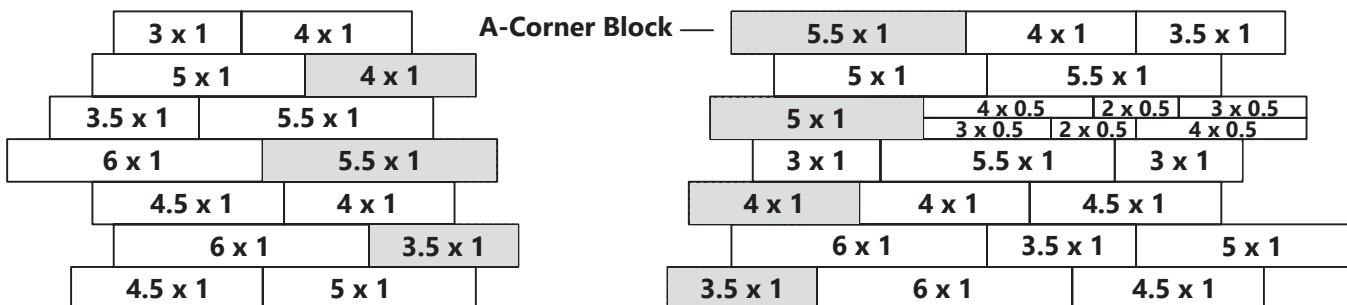

OUTCROPPING INSIDE CORNER ASSEMBLY DETAIL

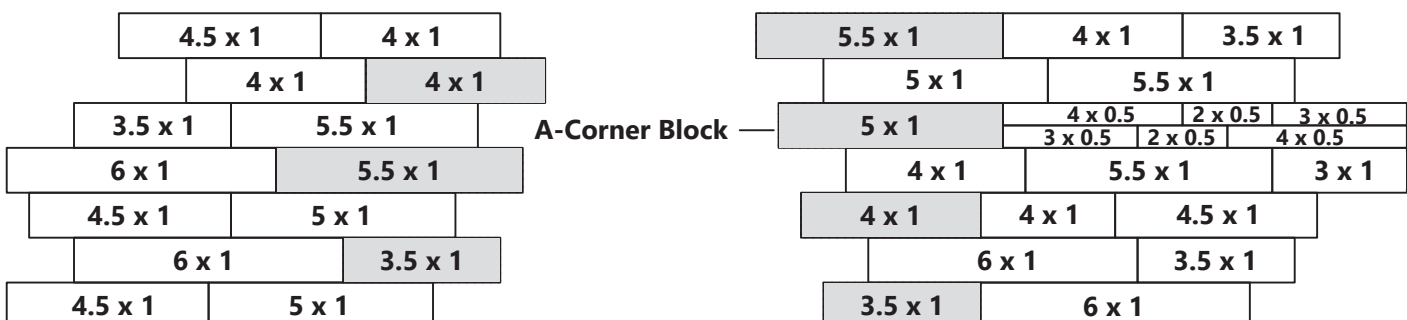

BELVEDERE RETAINING WALL

TYPICAL RETAINING WALL CONSTRUCTION DETAILS

This page shows typical construction details for Belvedere retaining walls. These drawings are representative of major components required in wall construction. Specific details including geotextile reinforcement layers, drainage details, soil requirements, etc., shall be per engineered design for wall.

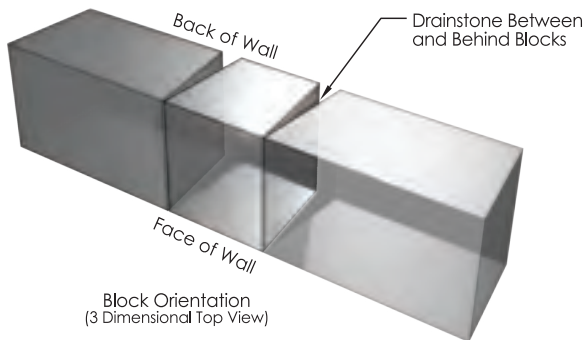

Note: This drawing is for reference only. Final design for construction must be prepared by a registered Professional Engineer using the actual conditions of the proposed site. Final wall design must address both internal and external drainage and shall be evaluated by the Professional Engineer who is responsible for the wall design. Block size and placement shown are for reference only. Individual Belvedere blocks will vary with installation pattern.

TYPICAL FREESTANDING WALL CONSTRUCTION DETAILS

Belvedere freestanding walls are intended to be low walls (24" or lower) used in a garden or patio setting. Taller walls – i.e. walls intended to act as railing or barriers, walls constructed in other settings, or walls subject to applied loads — will require project-specific engineering.

Block Orientation (top view)

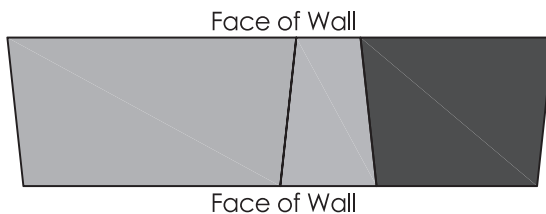

Note: This drawing is for reference only. Final design for construction for walls subject to any loading must be prepared by a registered Professional Engineer. Block size and placement shown for reference only. Individual Belvedere blocks will vary with installation pattern.

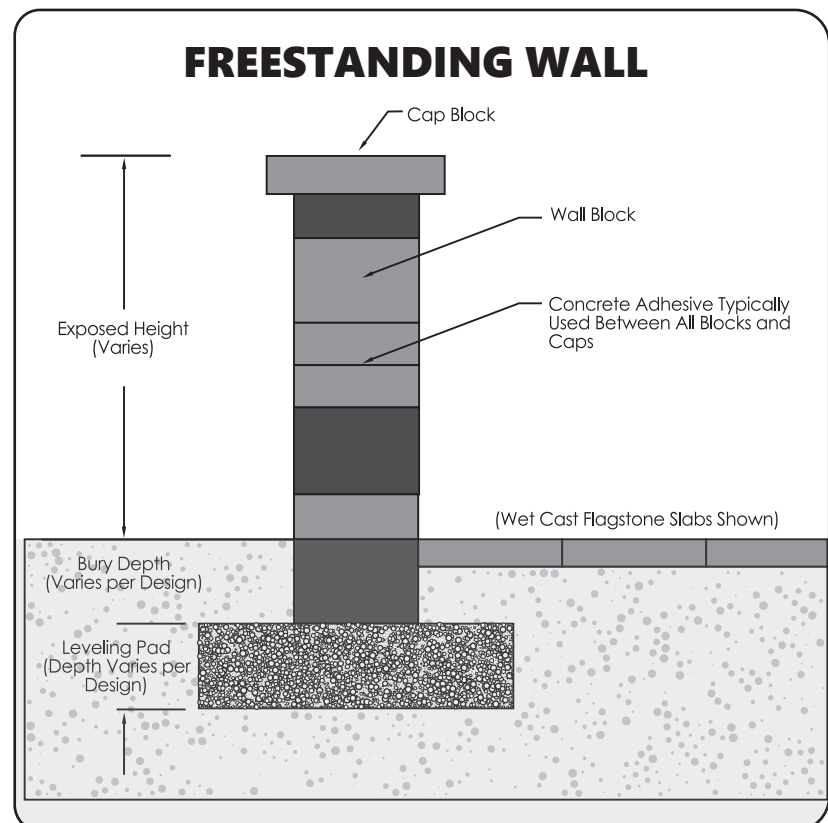
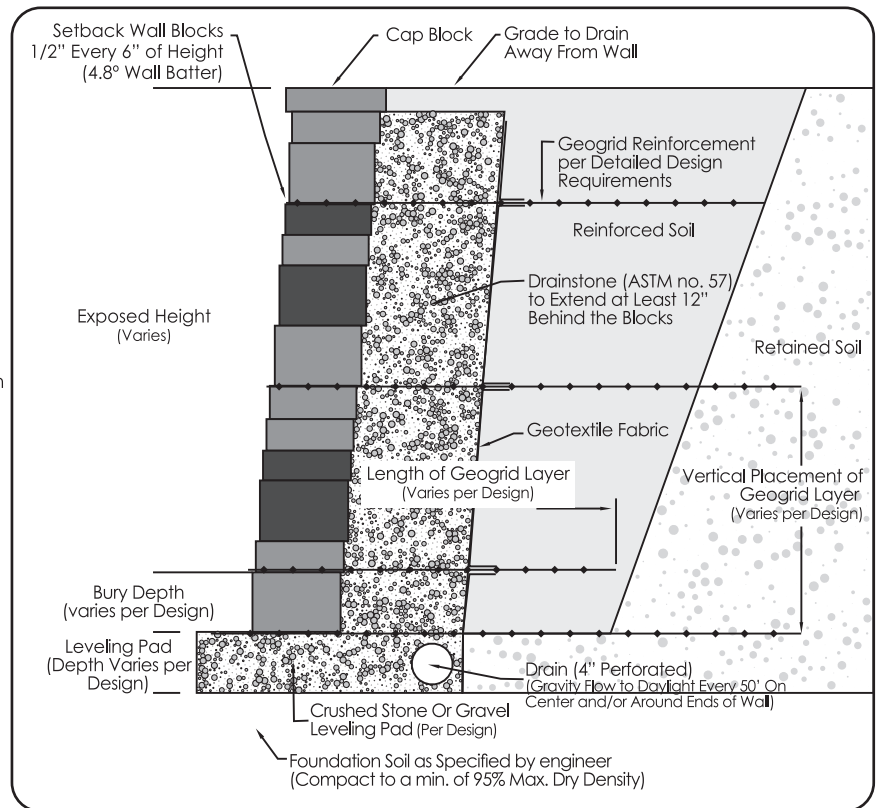

BELVEDERE CURVES

This page shows typical construction details for making curved retaining walls with Belvedere blocks. The taper on the side of the blocks allow for construction of a wide range of curves in both retaining and freestanding walls.

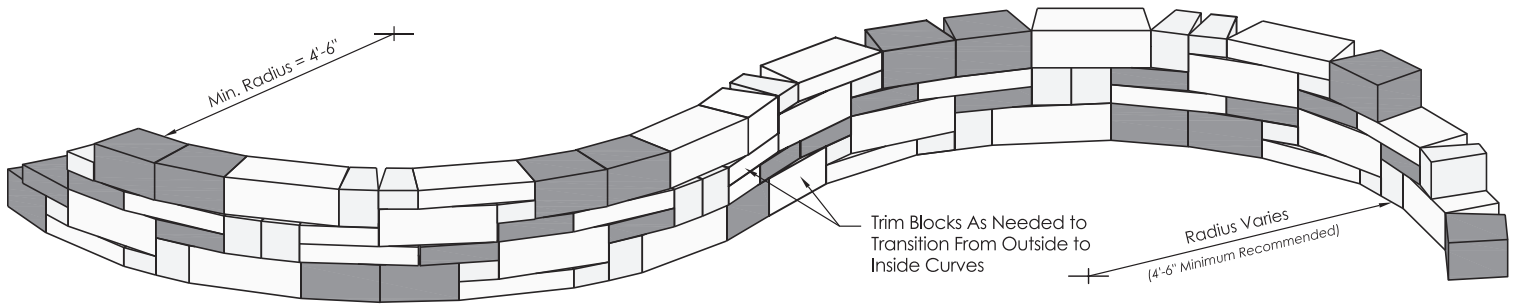

OUTSIDE CURVE

INSIDE CURVE

Note:

1. These details show curved retaining walls.
2. Minimum radius curves are shown which can be constructed without saw cutting a significant number of blocks. Larger radius curves can be created by leaving a larger gap between blocks on the backside of the wall. The gaps must be filled with drainstone.
3. When retaining walls are constructed with batter, the radius on the outside curves becomes smaller with each course due to the block setback. For proper construction, the radius of the bottom course must be larger than the minimum radius so that upper courses will have sufficient room for construction.
4. When retaining walls are constructed with a batter, the radius on the inside curves becomes larger with each course due to the block setback.

CURVED FREESTANDING WALLS

Curved freestanding walls can also be built. Typically, the blocks have to be field-adjusted to make the desired curve. Front and back faces will alternate and blocks trimmed as needed to provide a tight fit between blocks with no gaps on either side of the freestanding wall.

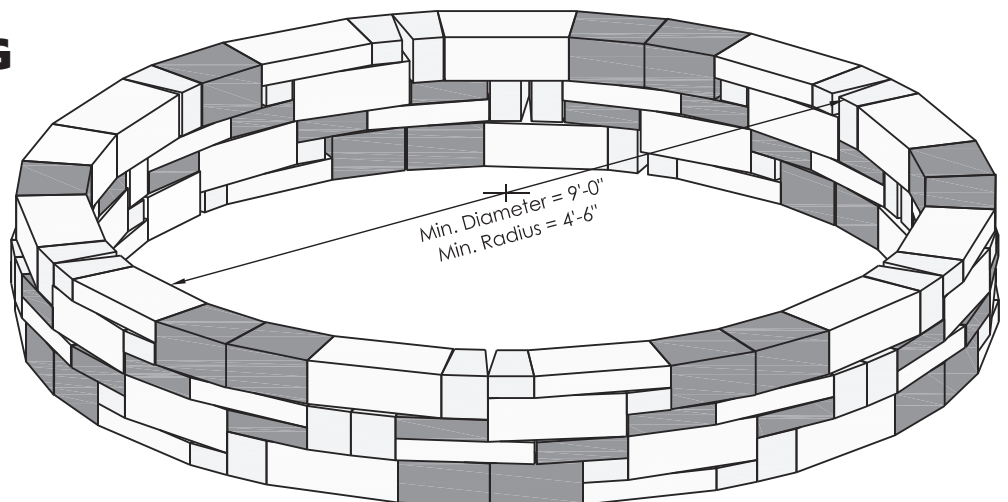

PLANTER/ TREE RING

Note: Walls are shown without batter for clarity. Blocks in a retaining wall should be adjusted slightly in place and trimmed as needed to allow wall construction with proper batter.

BELVEDERE PILLARS

PILLAR CONSTRUCTION DETAILS

This page shows typical construction details for Belvedere pillars. Pillars make nice ends to Freestanding walls, formal stair openings, stand-alone monuments, and other areas to enhance your Belvedere project. The basic steps of pillar construction are shown here. Feel free to expand on these ideas and bring your own creativity into creating a custom project.

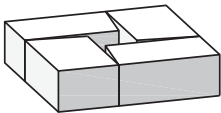

STEP ONE

Place (4) 3" or 6" high corner blocks with the taper facing into the center of the pillar.

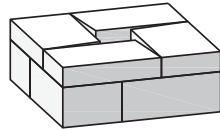

STEP TWO

Place the second row of (4) of the corner blocks with the taper facing into the center of the pillar. Typically, if the first row is built with 6" corner blocks, the second row is built with 3" corner blocks.

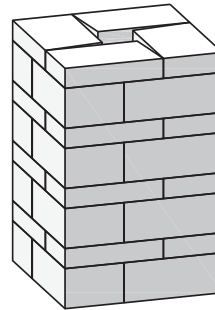

STEP THREE

Continuous with subsequent rows to the desired pillar height. One pallet of corner blocks will make a 24" x 24" x 36" high column.

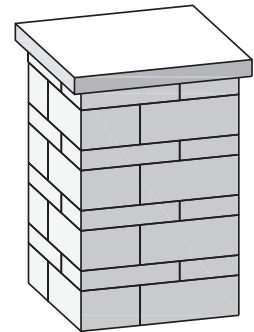

STEP 4

Place a column cap to finish the pillar. The column cap can be cored as needed for installation of a light.

This example shows a freestanding wall with pillars on each end. The wall can either be constructed flush with the pillars, or blocks trimmed to interlock the end of the wall with the pillar.

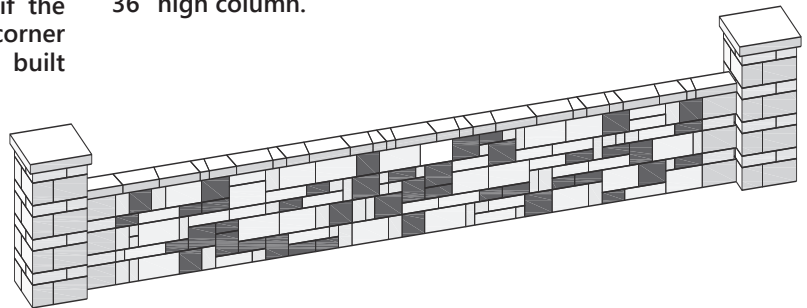

OUTSIDE CORNER

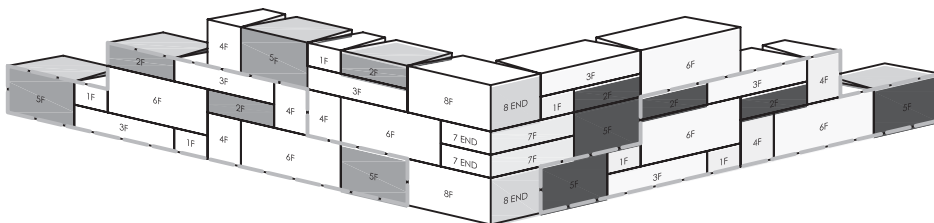

INSIDE CORNER

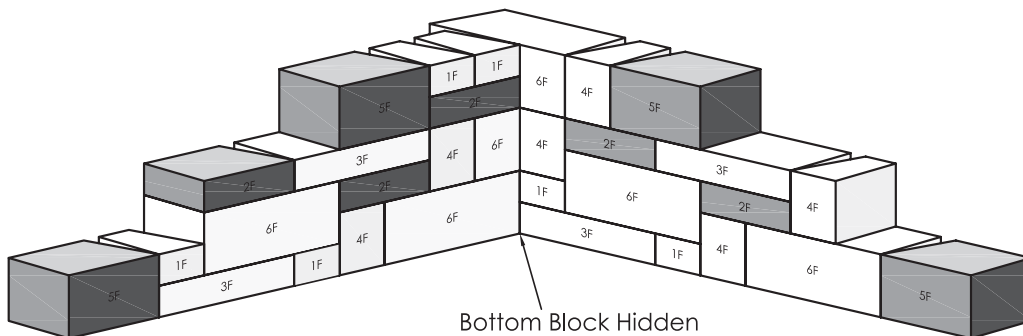

Bottom Block Hidden
(see Interlocking
Corner Detail)

CORNER CONSTRUCTION DETAILS

This page shows typical construction details for making 90° corners Belvedere blocks. Some basic concepts are shown here. Plan to take some time to properly work corners into the larger retaining and free-standing wall patterns.

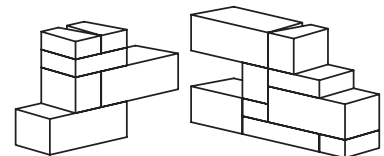

INTERLOCKING CORNER

Place block in an overlapping, interlocking pattern at corner for added wall stability.

Note: Walls are shown without batter for clarity. Blocks in a retaining wall should be adjusted slightly in place and trimmed as needed to allow wall construction with proper batter.

BELVEDERE PATTERNS

Note: The blocks shown below are labeled, for example, 4F would indicate the front (or longer) face of block 4, and 2B would indicate the back (or shorter) face of block 2.

Note: These patterns are NOT required and are present for reference only. They are most useful for long, straight retaining walls.

12" HIGH WALL 12" High x 13'-6" Wall Section Shown = 13.5 sqft (1/2 Wall Pallet)

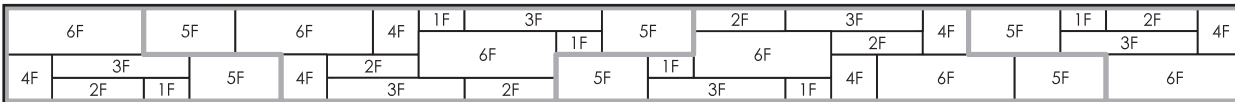

18" HIGH WALL 18" High x 18'-0" Wall Section Shown = 27.0 sqft (1 Wall Pallet)

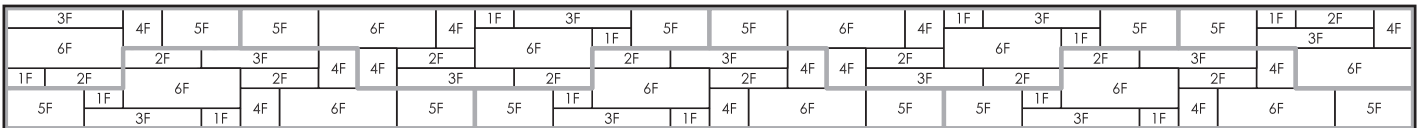

24" HIGH WALL 24" High x 16'-0" Wall Section Shown = 32 sqft (Approx. 1.2 Wall Pallet)

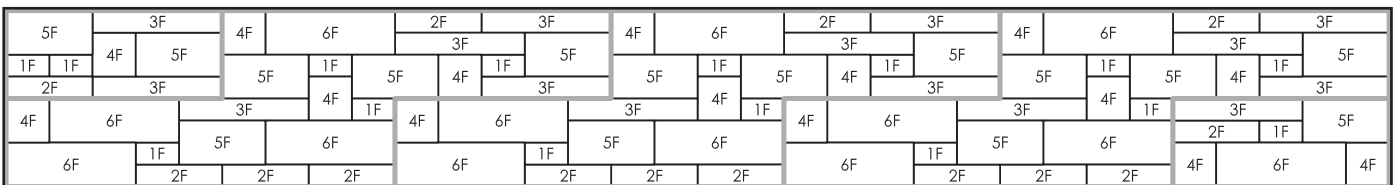

Note: RETAINING WALLS are typically constructed with the front face of the block exposed. The v-shaped notches which appear on the back of wall between adjacent blocks must be filled with drainstone.

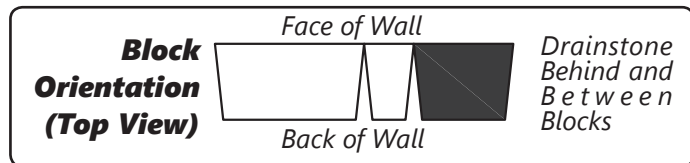

FREESTANDING WALL PATTERNS

24" PATTERN A Wall Section Shown = 24.67 sqft (Approx. 1 Wall Pallet)

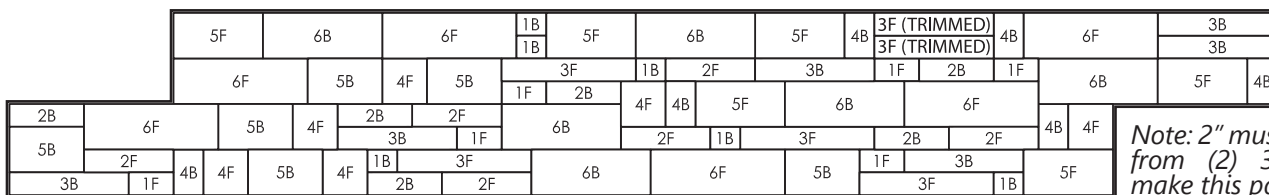

Note: 2" must be trimmed from (2) 3" blocks to make this pattern.

24" PATTERN B Wall Section Shown = 24.67 sqft (Approx. 1 Wall Pallet)

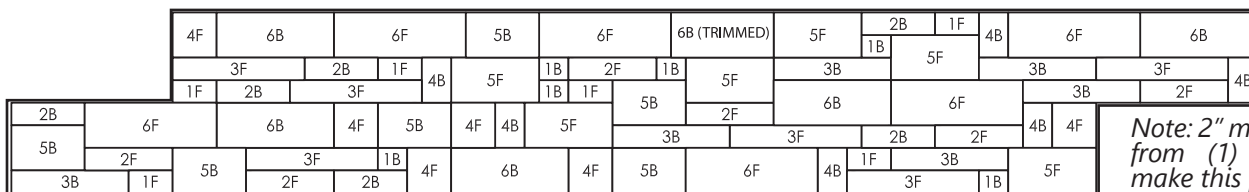

Note: 2" must be trimmed from (1) 6" blocks to make this pattern

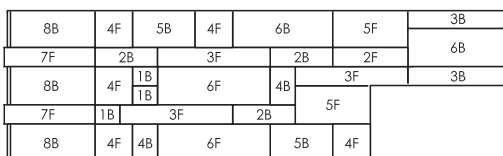

24" HIGH VERTICAL END - LEFT
Wall section Shown = 11.67 sqft (1/2 Wall Pallet)

Note: Vertical End Jogs in and out approximately 1" between blocks

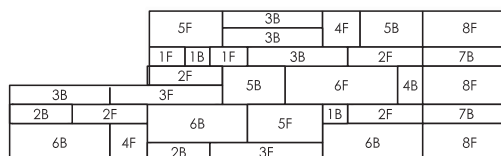

24" HIGH VERTICAL END - RIGHT
Wall section Shown = 11.67 sqft (1/2 Wall Pallet)

Note: Vertical End Jogs in and out approximately 1" between blocks

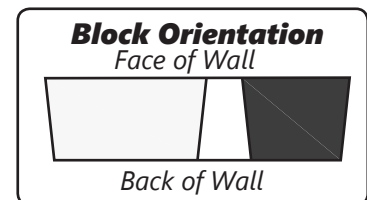

ROCKTON FREESTANDING WALL

TYPICAL RETAINING WALL CONSTRUCTION DETAILS

This page shows typical construction details for Rockton retaining walls. These drawings are representative of major components required in wall construction. Specific details including geotextile reinforcement layers, drainage details, soil requirements, etc. shall be per engineered design for wall.

- This drawing is for reference only
- Final design for construction must be prepared by a registered Professional Engineer using the actual conditions of the proposed site.
- Final wall design must address both internal and external drainage and shall be evaluated by the Professional Engineer who is responsible for the wall design.

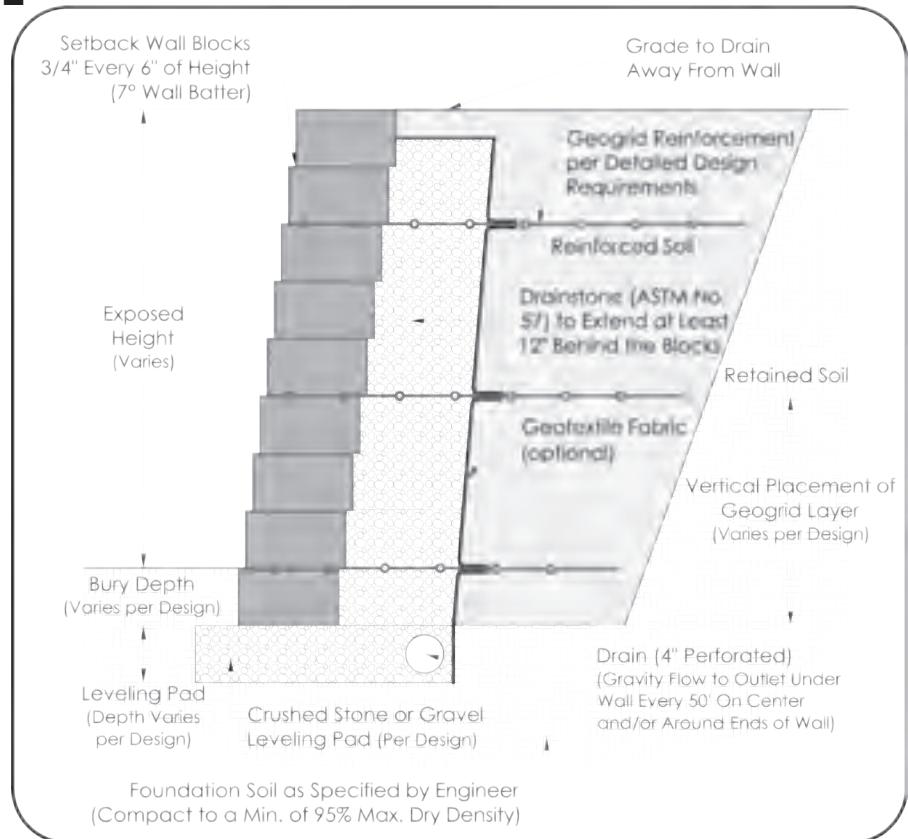

ROCKTON CURVED WALLS

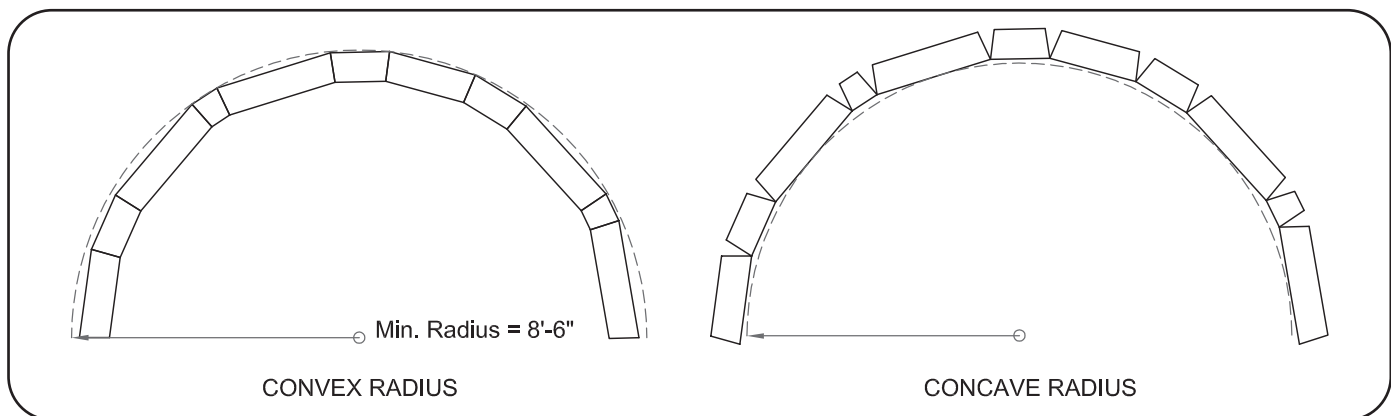

The taper side of Rockton blocks allow for construction of a wide range of curves in both retaining and freestanding walls.

1. Minimum radius curves—shown above—can be constructed without saw-cutting a significant number of blocks. Larger radius curves can be created by leaving a larger gap between blocks on the back side of the wall. The gaps must be filled with Drainstone.
2. When retaining walls are constructed with batter, the radius on outside curves become smaller with each course due to the block setback. For proper construction, the radius of the bottom course must be larger than the minimum radius so upper Courses will have sufficient room for construction.
3. When retaining walls are constructed with batter, the radius on inside curves becomes larger with each course due to the block setback.

GRAND FLAGSTONE INSTALLATION

BEDDING SAND INSTALLATION:

Using screed rails on the compacted granular base, apply bedding sand at a maximum thickness of 1" (25 mm). By using a screed board along the top of the screed rails, the bedding sand will level evenly. Bedding sand should be compacted since Grand Flagstone slabs should not be compacted after installation.

FLAGSTONE INSTALLATION:

1. Begin by laying the individual pieces of Grand Flagstone on the screeded bedding material according to your detailed project plan.
2. Separate individual pieces approximately 3/8" (10 mm) from each other. When units are set with a 3/8" gap, a full pallet will produce 90 ft.² (8.36 m²) coverage.
3. Cut units as needed to finish edges.

NOTE: To ensure proper colour distribution, mix layers from several bundles at one time.

JOINT SAND INSTALLATION:

Once the flagstone pieces are installed, fill all joints with jointing sand suitable for large joints. Sweep the sand into the joints between flagstones until the joints are completely filled. Follow the jointing sand manufacturer's recommendations for wetting the sand. You may need to repeat this process with more dry sand in a few days to completely fill the joints between individual slabs.

CAUTION: Grand Flagstone slabs should not be compacted after installation.

OTHER CONSIDERATIONS

SEALING: You may want to apply a sealer to protect the flagstone slabs from spills and stains. Always use a high quality sealer specifically formulated for wet-cast concrete.

**** NOT SUITABLE FOR VEHICULAR TRAFFIC ****

TYPICAL CROSS-SECTION

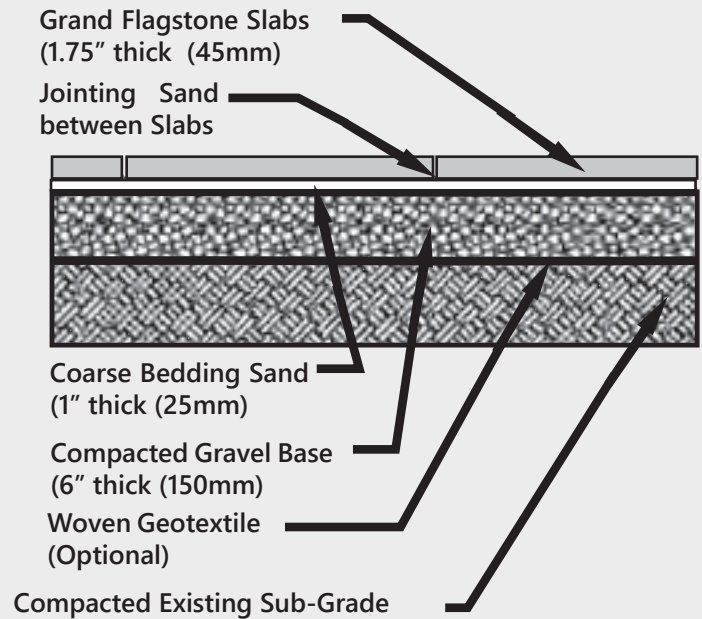

STRAIGHT WALKWAY INSTALLATION

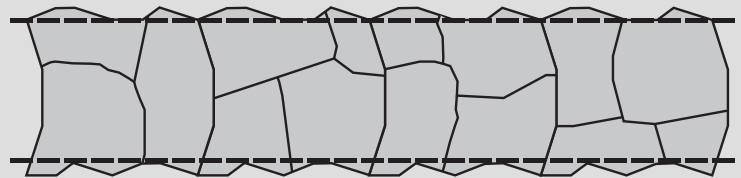

Leave Jagged Edge or Trim to Provide Smooth Edge (Optional)

PLACING GRAND FLAGSTONE

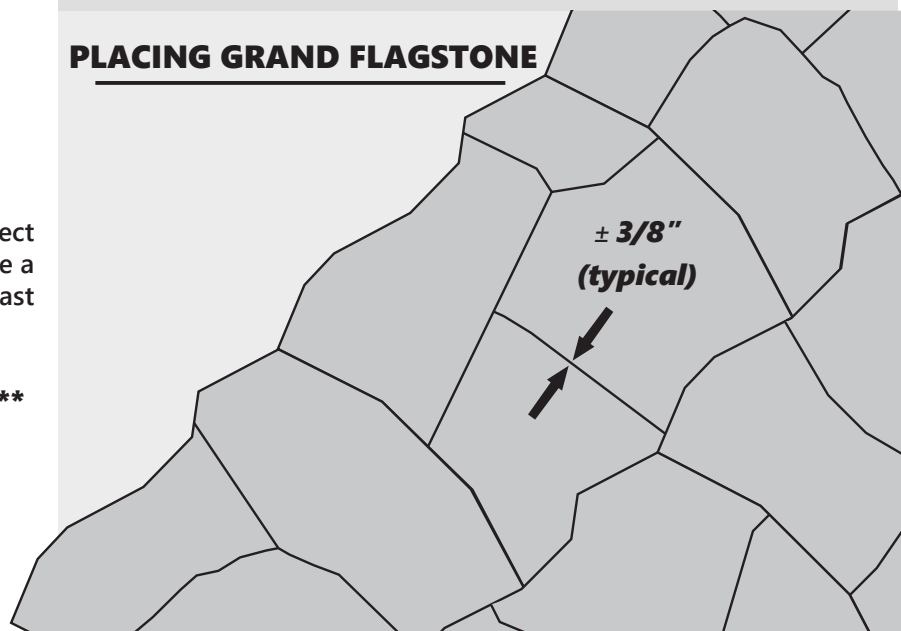

GRAND FLAGSTONE

INTERLOCKING LAYERS:

Grand Flagstone has been designed so that each layer of slabs on pallet is an interlocking set. Each interlocking set, or layer, of slabs has been designed to inter-lock with all other layers.

COMMON POINTS FOR INTERLOCKING LAYERS

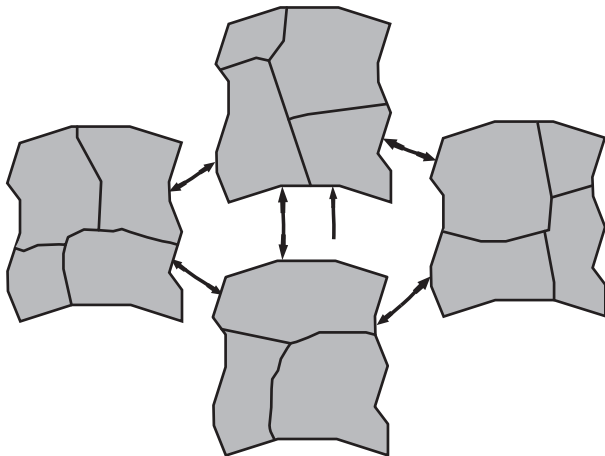

PROPERLY PLACED INTERLOCKING LAYERS

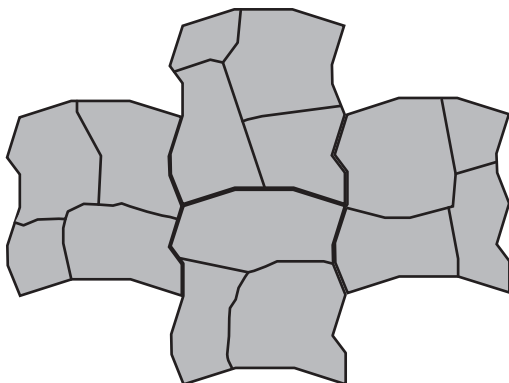

INSTALLING CRACKED PIECES

Individual pieces of Grand Flagstone can crack either during delivery to the job or during on-site handling prior to placement. Typically less than 5% of the pieces will crack. There are two methods to deal with cracked pieces.

The **first method** is to use the cracked pieces to fill in around the edges of the project where there is always a need for small pieces. The **second method** is to use the cracked pieces to enhance the layout pattern.

Since Grand Flagstone is designed to create an irregular flagstone walking surface, an extra crack simply provides another joint line in the Grand Flagstone pattern. Place the cracked pieces next to each other with a 3/8" (10 mm) joint between them. The joint is filled with polymeric jointing sand just like all other joints. If necessary, the cracked pieces may need to be trimmed to create a smooth edge or provide a larger joint to match all the other joints in your project.

LAYOUT ORIENTATION:

Layout orientation is important with Grand Flagstone. Due to the nature of the interlocking sets slabs, there are long, unbroken joints between rows. Often, the irregular nature of the Grand Flagstone limits how noticeable these unbroken joints are in the finished project. However, the lines become slightly more noticeable when you are looking parallel to the unbroken joints than when you are looking at them on an angle. To limit this effect, Grand Flagstone layers should be laid at a 45° angle from the most common viewing angle. This viewing angle would most likely be a patio entrance or step location.

INCORRECT VIEW

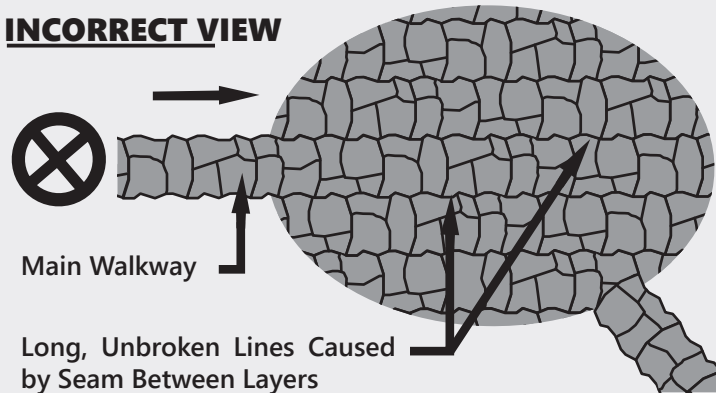

CORRECT VIEW

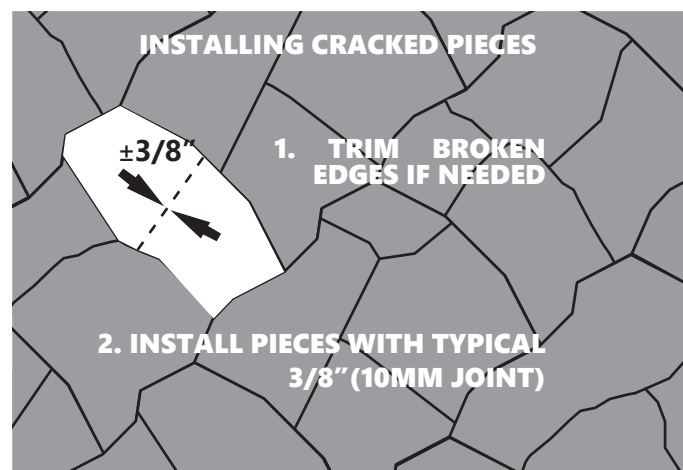
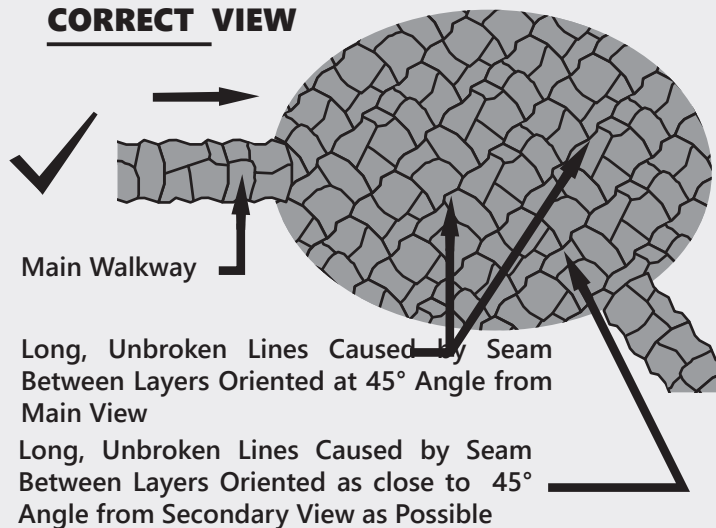

DIMENSIONAL FLAGSTONE INSTALLATION

BEDDING SAND INSTALLATION:

Using screed rails on the compacted granular base, apply bedding sand at a maximum thickness of 1" (25mm). By using a screed board along the top of the screed rails, the bedding sand will level evenly. Bedding sand should be compacted since Dimensional Flagstone slabs should not be compacted after installation.

FLAGSTONE INSTALLATION:

1. Begin by laying the individual pieces of Dimensional Flagstone on the screeded bedding material according to your detailed project plan.
2. Push flagstone slabs directly together so the bottom edges butt tight. There is no need to space the slabs to create the necessary joint. Joint is pre-set in the unit.
3. Cut units as needed to finish edges of installation.

NOTE: To ensure proper color distribution, mix layers from several bundles at one time.

JOINT SAND INSTALLATION:

Once the flagstone pieces are installed, fill all joints with jointing sand suitable for large joints. Sweep the sand into the joints between flagstones until the joints are completely filled. Follow the jointing sand manufacturer's recommendations for wetting the sand. You may need to repeat this process with more dry sand in a few days to completely fill the joints between individual slabs.

CAUTION: Dimensional Flagstone slabs should not be compacted after installation.

OTHER CONSIDERATIONS: You may want to apply a sealer to protect the flagstone slabs from spills and stains. Always use a high quality sealer specifically formulated for wet-cast concrete.

**** NOT SUITABLE FOR VEHICULAR TRAFFIC ****

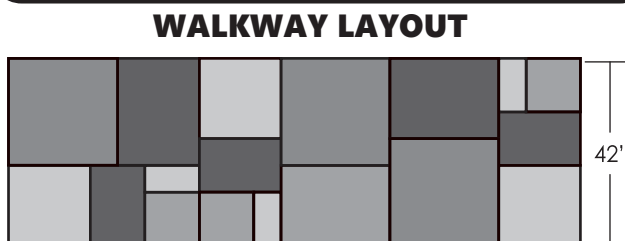
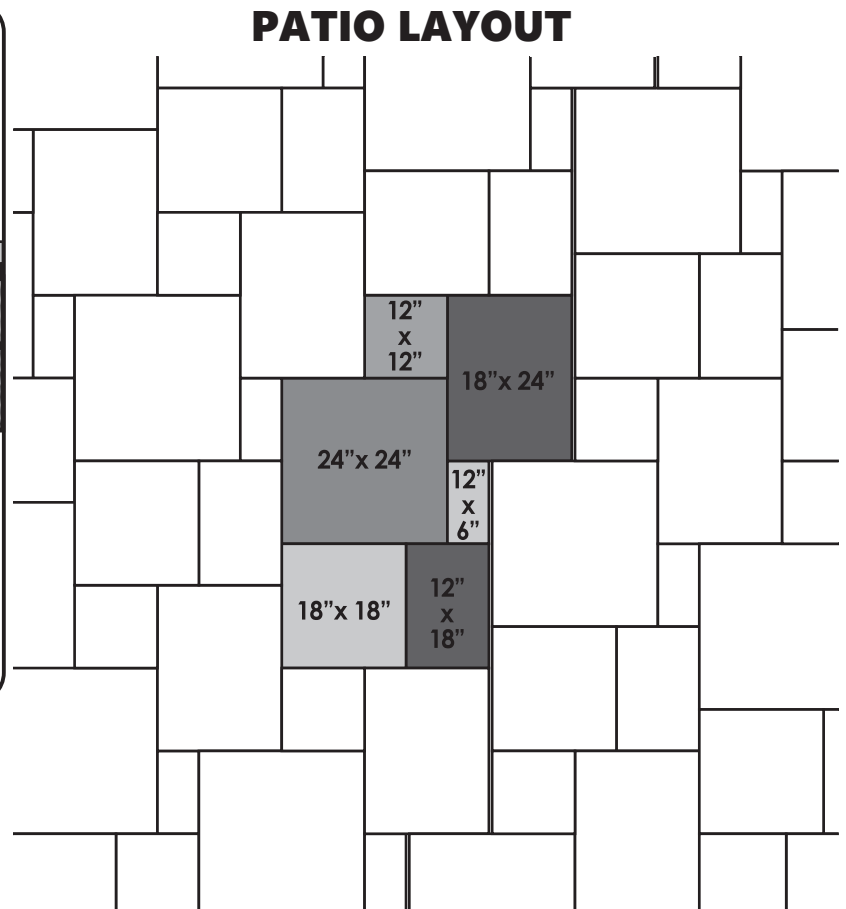
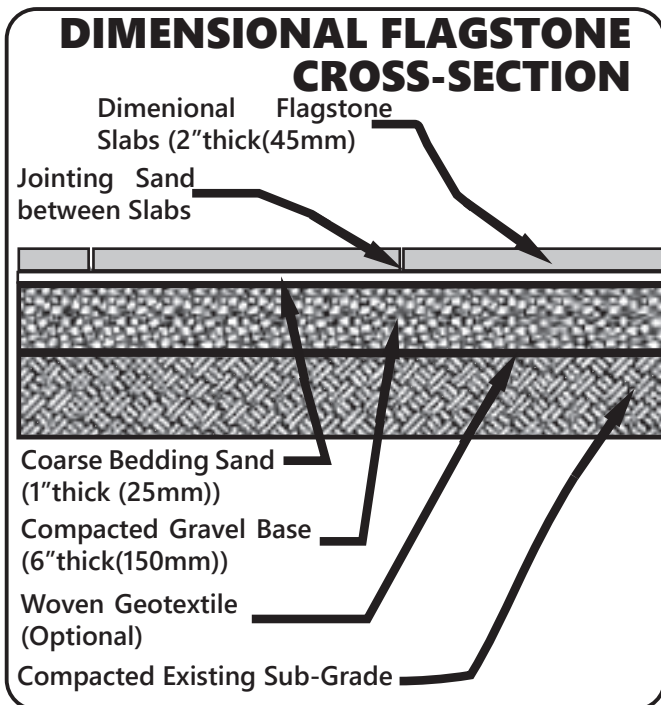

FLAGSTONE & PAVER INSTALLATION GUIDE

Thank you for your interest in installing Rosetta By Brown's paving products. You will find that these products truly combine the look of natural stone with the efficiency and consistency of concrete pavers. The following guide lays out proper installation techniques for Rosetta by Brown's Grand Flagstone and Dimensional Flagstone slabs. For optimal color blending you must mix and install products from several different pallets simultaneously. We hope this provides helpful tips for a fast, enjoyable installation.

SAFETY

Make safety a top priority when installing Rosetta paving products. Before starting your project, be sure to address the following points:

1. Contact your local utility marking service prior to making any excavation. Be sure to follow all governmental safety regulations.
2. Always wear the appropriate personal protective equipment (PPE) including gloves, steel toed boots, safety glasses, hearing protection, and any other needed safety gear.
3. Flagstone slabs are heavy. Follow proper lifting techniques to avoid back injury. Also, use two people to set larger pieces.

PROJECT PLANNING

The first step in installing Rosetta paving products is to plan your project. Paver layout and placement is important to ensure a functional and good-looking installation. Remember, Rosetta flagstone products are suitable for pedestrian loading only (patios, walkways, etc.) and will not support the load of a vehicle. Old Mission Pavers are suitable for vehicular loading.

EXCAVATION AND BASE PREPARATION

Once you are ready to start construction, you will need to lay out the project area:

1. Mark out the area of the installation with marking paint.
2. Mark a second line 12" (305 mm) outside of the first line that indicates the area to be excavated. This over-excavation will allow for proper base installation.
3. Excavate to the required depth and grade for the installation of the specific Rosetta paving product you are installing (see cross-sections for minimum recommended excavation depths).
4. Once the excavation depth has been established, compact the subgrade well using a plate tamper. At this point, Brown's Concrete Products Limited recommends laying a woven geotextile down before applying any granular base materials.

PERMEABLE INSTALLATIONS: *Unless specified, avoid compaction of existing subgrade soils if installing a permeable pavement.*

PLACE THE COMPACTED GRAVEL BASE

For standard paver and flagstone installations, begin by spreading half of granular base material in the excavation.

(Note: lifts should not exceed 6" (150 mm) in thickness).

Compact this first lift to 98% Standard Proctor density using a plate tamper and adding water as needed. Add the second lift of granular material and compact it in the same manner as the first. For permeable paver installations, install open-graded sub-base and base course material as specified in the project drawings.

KEY POINT: *When installing granular base materials, be sure to consider proper grades to prevent water from standing on the surface and make sure that water is directed away from building structures.*

PAVER INSTALLATION

Bedding material requirements and paver installation vary by product type. Please see the following product-specific installation instructions and tips for more details on paver installation.

STEP INSTALLATION

CALCULATING TREAD WIDTH

Generally, when the grade allows, a 12" or wider tread is desirable. To calculate the tread width, divide the total allowable horizontal run minus the width of the top step, by the number of steps minus one. The one less will account for the top step.

1. EXCAVATE AND GRADE THE AREA FOR THE FIRST STEP. Steps should be placed on at least 3" of free draining soil, such as sand or pea-stone. Compact soil to a minimum of 95% Standard Proctor.
2. PLACE STEP with either forks or straps using a small excavator or skid-steer to lift the piece into place. Practice safe handling procedures during this process.
3. FILL BEHIND EACH STEP with free draining soil and compact to 95% Standard Proctor. Remember to slope fill to allow for proper drainage when next step is placed. Continue placing steps in this manner until finish grade is reached.
4. Block size and placement shown are for reference only. Individual steps will vary with installation pattern.

Consider the Following Example:

TOTAL RISE	42"
TOTAL HORIZONTAL RUN	96"
WIDTH OF TOP STEP	18"
RISE OF STEPS	7"
NUMBER OF STEPS CALCULATION	$42" \div 7" / \text{Step} = 6 \text{ Steps}$ $\text{Tread Depth} = (96" - 18") \div (6 - 1)$ $= 15.6" \text{ Tread Depth}$

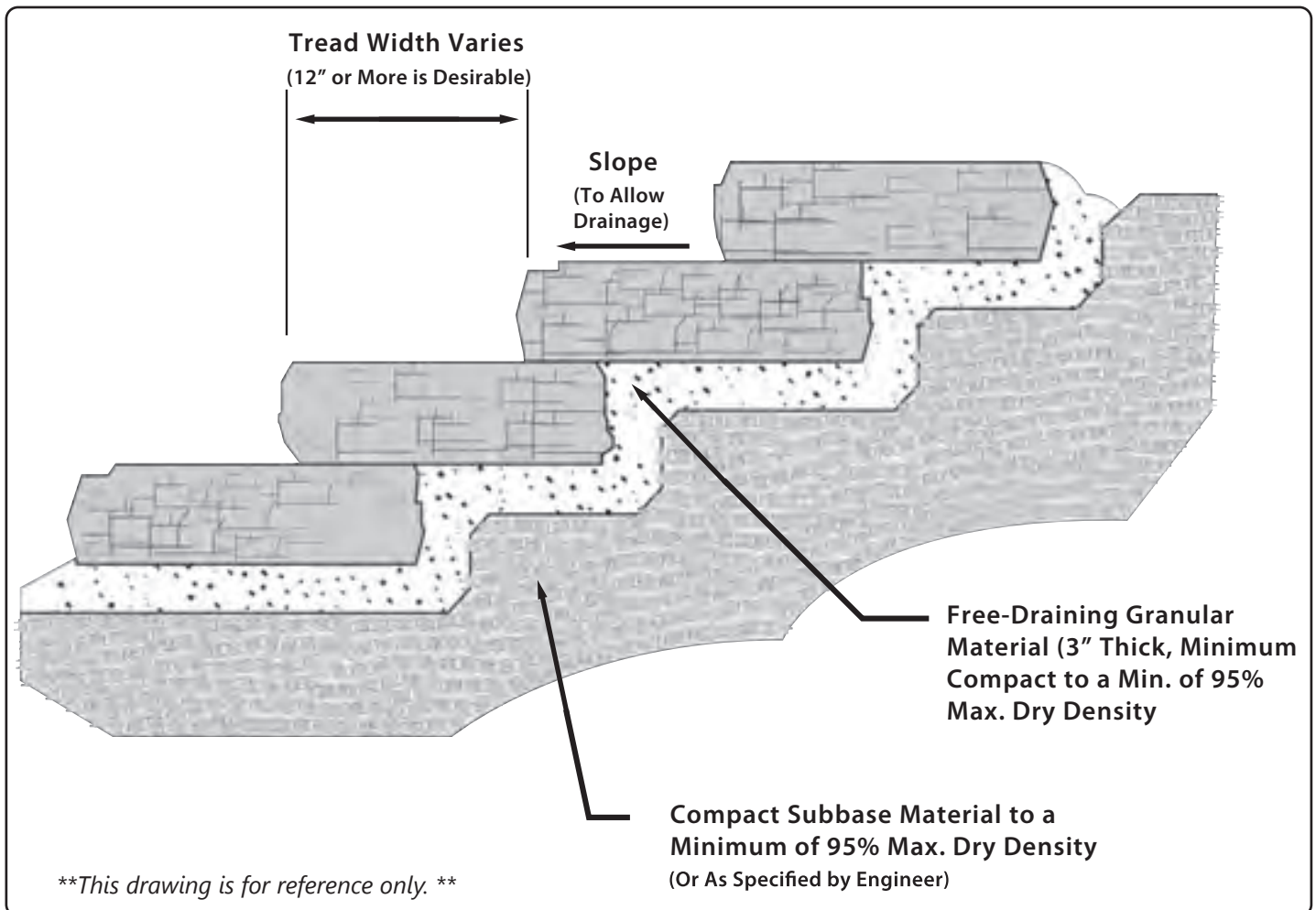

$\pi = 3.1416$, C = Circumference (perimeter of circle), r = Radius, d = Diameter, c = length of arc, θ = angle

Square or Rectangle

$A = bh$
 $P = 2(b + h)$

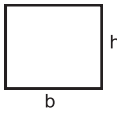

Triangle

$A = \frac{1}{2}bh$
 $P = b + h + l$
where $l = \sqrt{b^2 + h^2}$

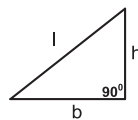

Parallelogram

$A = bh = b \sin \theta$
 $P = 2(b + l)$

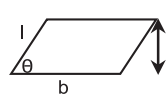

Ellipse

$A = \pi ab$
 $P = \pi [1.5(a+b) - \sqrt{ab}]$

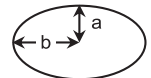

Trapezoid

$A = \frac{1}{2}(b_1 + b_2)h$
 $P = \text{sum of all sides}$

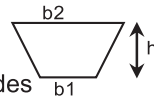

Circle

$A = \pi r^2$
 $C = 2\pi r$
 $= \pi d$

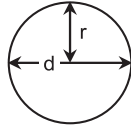

Sector

$A = \frac{1}{2}cr$
 $c = \frac{2\pi r \theta}{360}$

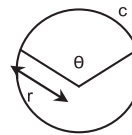

Parabola

$A = \frac{2}{3}bh$

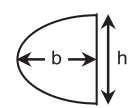

volume chart - cubic metres (cubic yards)

Use the following table to estimate the volume of an excavation or backfill based on the surface area and total depth.

Surface Area square metres (square feet)	Excavation Depth			
	100mm (4")	200mm (8")	300mm (12")	400mm (16")
1m ² (10ft ²)	0.1m ³ (0.12yd ³)	0.2m ³ (0.25yd ³)	0.3m ³ (0.37yd ³)	0.4m ³ (0.50yd ³)
5m ² (50ft ²)	0.5m ³ (0.62yd ³)	1.0m ³ (1.23yd ³)	1.5m ³ (1.85yd ³)	2.0m ³ (2.47yd ³)
10m ² (100ft ²)	1.0m ³ (1.23yd ³)	2.0m ³ (2.47yd ³)	3.0m ³ (3.70yd ³)	4.0m ³ (4.94yd ³)
25m ² (250ft ²)	2.5m ³ (3.09yd ³)	5.0m ³ (6.17yd ³)	7.5m ³ (9.26yd ³)	10m ³ (12.3yd ³)
50m ² (500ft ²)	5.0m ³ (6.17yd ³)	10m ³ (12.3yd ³)	15m ³ (18.5yd ³)	20m ³ (24.7yd ³)
100m ² (1000ft ²)	10m ³ (12.3yd ³)	20m ³ (24.7yd ³)	30m ³ (37.0yd ³)	40m ³ (49.4yd ³)
250m ² (2500ft ²)	25m ³ (30.9yd ³)	50m ³ (61.7yd ³)	75m ³ (92.6yd ³)	100m ³ (123yd ³)
500m ² (5000ft ²)	50m ³ (61.7yd ³)	100m ³ (123yd ³)	150m ³ (185yd ³)	200m ³ (247yd ³)

measurement equivalents

length Equivalents	Units	Centimeters	Metres	Inches	Feet	Yards
	1 Centimeter	1	0.01	0.3937	0.03281	0.01094
	1 Meter	100	1	39.3701	3.28084	1.0936
	1 Kilometer	100,000	1000	39,370	3280.84	1093.6
	1 Inch	2,540	0.0254	1	0.08333	0.0278
	1 Foot	30.48	0.3408	12	1	0.33333
	1 Yard	91.44	0.9144	36	3	1
	1 Mile	160,934	1609.34	63,360	5,280	1,760

surface Equivalents	Units	Square Feet	Square Yards	Acre	Square Metres
	1 Square Foot	1	0.1111	2.2957 x 10 ⁻⁵	0.0929
	1 Square Yard	9	1	0.000207	0.8361
	1 Acre	43,560	4,840	1	4046.86
	1 Square Metre	10.7639	1.19599	0.000247	1
1 Hectare	107,639	11,960	2.471	10,000	

volume Equivalents	Units	Cubic Inches	Cubic Feet	Cubic Yards	Cubic Metres
	1 Cubic Foot	1,728	1	0.03704	0.02832
	1 Cubic Yard	46,656	27	1	0.76455
1 Cubic Metre	61,024	35.3147	1.30795	1	

weight Equivalents	Units	Ounces (avdp)	Pounds (avdp)	Tons	Kilograms	Tonnes
	1 Ounce (avdp)	1	0.0625	3.125 x 10 ⁻⁵	0.02835	2.835 x 10 ⁻⁵
	1 Pound (avdp)	16	1	0.000464	0.4536	0.0004536
	1 Ton	32,000	2000	1	907.185	0.907185
	1 Gram	0.03527	0.002205	1.102 x 10 ⁻⁶	0.001	1 x 10 ⁻⁶
	1 Kilogram	35.27	2.205	0.001102	1	1,000
1 Tonne	1 x 10 ⁶	2,205	1.1023	1,000	1	



Brown's
CONCRETE PRODUCTS LIMITED

3075 Herold Drive Sudbury, ON P3E 6K9
705.522.8220 (phone) 800.461.4888 (toll free)
705.522.2732 (fax)

Sudbury
Marino DiGiacomantonio
705.690.1831
marino@brownsconcrete.com

Northern Ontario
Chris Whitman
705.690.0372
cwhitman@brownsconcrete.com

Central / Eastern Ontario
Nick Lang
705.929.3809
nlang@brownsconcrete.com

SW Ontario & Michigan
Rick Stinchcombe
705.690.7496
rstinchcombe@brownsconcrete.com



PROUD MEMBER

icpi

Interlocking Concrete
Pavement Institute



NATIONAL
CONCRETE MASONRY
ASSOCIATION



CANADIAN
HOME BUILDERS'
ASSOCIATION



HORTICULTURAL TRADES ASSOCIATION
landscape ontario.com



Green for Life!

Authorized Dealer

www.brownsconcrete.com

MADE STRONG WITH THE FINEST GRANITE AGGREGATE