



QUARX

M E D I C A L

**CATÁLOGO DE
EQUIPO MÉDICO**

Presencia Mundial

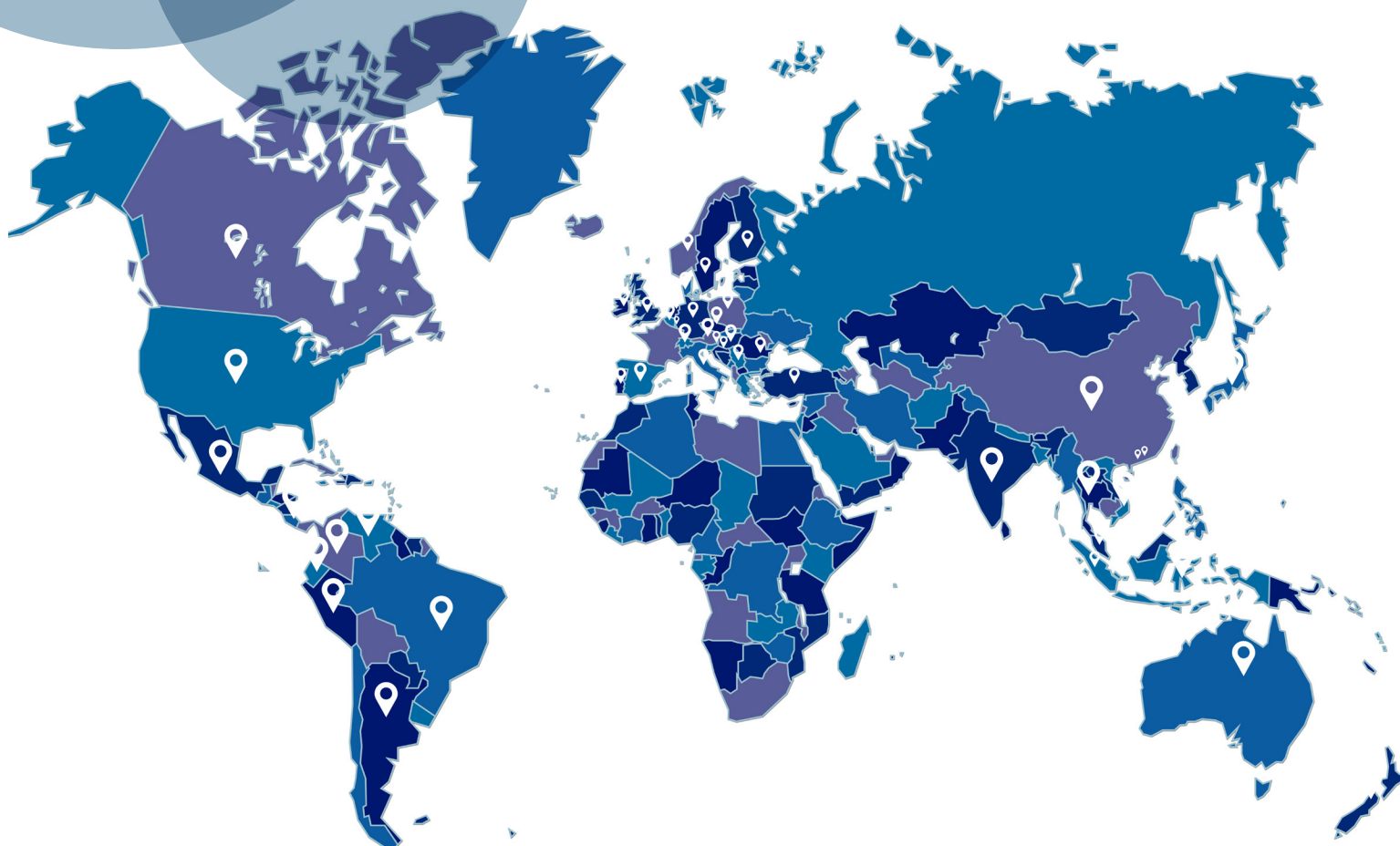

¡Contáctanos hoy mismo para obtener más información sobre nuestros productos y servicios!

Teléfono: 55 - 8977 - 0000

Correo electrónico: contacto@quarx.com.mx

Sitio Web: quarx.com.mx



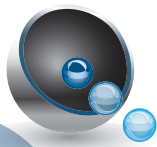

¡Innovación que Transforma Vidas!

Más que una empresa, somos agentes de cambio, visionarios comprometidos con la transformación de nuestro entorno a través de servicios, productos y tecnología que otorgan valor e inspiran confianza y esperanza.

QUARX es una empresa del grupo TD SYNEX, el mayorista de tecnología más grande del mundo, quien cotiza en la Bolsa de Valores de Nueva York con las siglas SNX con presencia en los cinco continentes con el apoyo de más de 22,000 colaboradores. En México QUARX cuenta con una trayectoria de más de 23 años y está respaldado por una sólida base financiera.

Nuestra Misión:

En QUARX, nos levantamos cada día con la determinación de hacer una diferencia tangible en el mundo de la salud. Nuestra misión es ofrecer soluciones médicas innovadoras y de alta calidad que trasciendan las expectativas y transformen vidas. Desde la sala de espera hasta el quirófano, ofrecemos una gama extensa de productos para el tratamiento y cuidado de la salud de los pacientes

Nuestros Valores:

Innovación: Impulsamos constantemente el avance tecnológico para ofrecer soluciones médicas de vanguardia.

Excelencia: Nos comprometemos a superar los estándares de calidad en todo lo que hacemos, desde la planeación hasta la entrega.

Colaboración: Fomentamos la colaboración y el trabajo en equipo para lograr resultados excepcionales.

Impacto positivo: Nos esforzamos por tener un impacto positivo y duradero en la vida de las personas, inspirando esperanza y confianza en cada paso del camino.

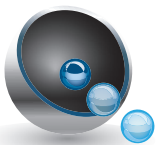

Nuestros Productos

En nuestro catálogo encontrarás una amplia gama de equipos médicos de última generación: Equipo de diagnóstico por imágenes, Equipo médico electrónico, Equipo médico duradero (DME), herramientas quirúrgicas de precisión, en QUARX tenemos todo lo que necesitas para brindar el mejor cuidado a tus pacientes.



LUXAMED®
Medizintechnik Made in Germany



unimed 
medical supplies



eco & electronics
ecoTRON

SonoScape

provita®
medical

mindray™

Brewer

 **AKTORmed™**
ROBOTIC SURGERY



HAcare
MOBILIER MEDICAL

 **Tarry**
MEDICAL PRODUCTS

 **BEYOND
MEDICAL**

 **YHMED**
Since 1969



 **Akuasul**

NISSHA
MEDICAL TECHNOLOGIES



QUARX
MEDICAL

Índice

Homecare	Pág 7
<ul style="list-style-type: none">• Mobiliario Homecare• Colchones inflables	Pág 8-9 Pág 10
Consultorios	Pág 11
<ul style="list-style-type: none">• Mesas de examinación• Instrumentos de diagnóstico	Pág 12-13 Pág 14
Espacios hospitalarios	Pág 15
<ul style="list-style-type: none">• Mobiliario Hospitalario• Mobiliario y Movilidad hospitalaria• Estantería y gestión de medicamentos	Pág 16 Pág 17 Pág 18
Hospitalización	Pág 19
<ul style="list-style-type: none">• Camillas de traslado intrahospitalario• Cama Hospitalria	Pág 20 Pág 21
Urgencias	Pág 22
<ul style="list-style-type: none">• Desfibriladores• Carros de emergencia	Pág 23 Pág 24
Imagenología	Pág 25
<ul style="list-style-type: none">• Imagenología• Ultrasonidos• Rayos X• Pantallas de diagnóstico• Electrocardiógrafos• Negatoscopio	Pág 26 Pág 27 Pág 28 Pág 29 Pág 30 Pág 31

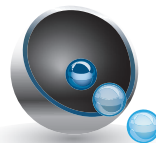

Índice

Quirófano	Pág 32
• Camilla quirúrgica	<i>Pág 33</i>
• Mesas de cirugía	<i>Pág 34</i>
• Iluminación quirúrgica	<i>Pág 35-38</i>
• Medical Pendants	<i>Pág 39</i>
• Pantallas grado quirúrgico	<i>Pág 40</i>
• Máquinas de anestesia	<i>Pág 41-42</i>
• Bomba TIVA/TCI	<i>Pág 43</i>
• Generador electroquirúrgico	<i>Pág 44</i>
• Endoscopia flexible	<i>Pág 45</i>
• Laparoscopia	<i>Pág 46</i>
Sala de recuperación	Pág 50
• Monitoreo de signos vitales	<i>Pág 51-54</i>
• Ventilación Mecánica	<i>Pág 55</i>
• Bomba de infusión	<i>Pág 56</i>
Centro de infusión/ Hemodiálisis	Pág 57
CEyE	Pág 58
• Esterilización de vapor	<i>Pág 59</i>
• Esterilización de baja temperatura	<i>Pág 60</i>
Accesorios y suministros	Pág 61
• Estuche de diagnóstico	<i>Pág 62</i>
• Accesorios médicos	<i>Pág 63</i>

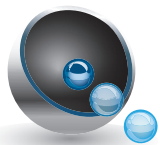

HOME CARE



Mobilirario Homecare

Mobiliario médico con diseño elegante

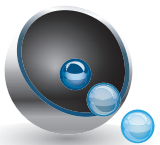

QUARX
MEDICAL

Mobiliario Homecare

Mobiliario médico con diseño elegante

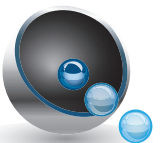

QUARX
MEDICAL

Colchones inflables

Prevención efectiva de lesiones por presión.

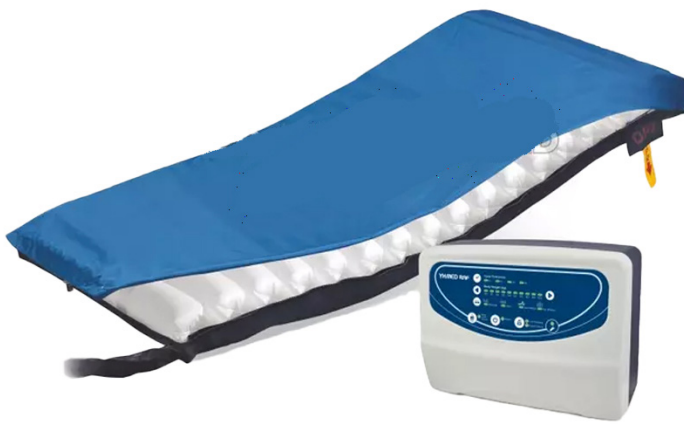

- Modo alterno
- Modo estático
- Modo silla
- Función almohada
- Resistencia al agua
- Resistencia al fuego
- Permeable al vapor
- Biocompatible

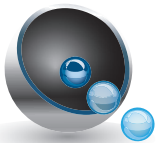

CONSULTORIOS



Mesas de examinación

Calidad, confort y eficiencia en mente.

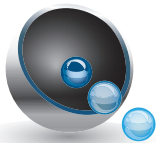

QUARX
MEDICAL

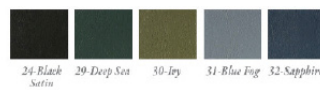

24-Black Satin 29-Deep Sea 30-Ivy 31-Blue Fog 32-Sapphire



21-Cashmere 22-Gunmetal 23-Feather 25-Saddle 26-Tapestry 27-Cabernet 28-Cocoa

Mesas de examinación

Calidad, confort y eficiencia en mente



Instrumentos de diagnósticos

Alta tecnología y calidad alemana

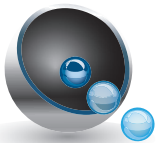

ESPACIOS HOSPITALARIOS



Mobiliario hospitalario

Soluciones para todas las necesidades



Mobiliario y movilidad hospitalaria

Salida frontal para mayor autonomía y comodidad

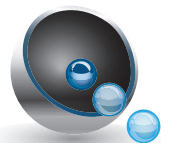

QUARX
MEDICAL

Estantería y gestión de medicamentos

Optimización de espacios en carros personalizados

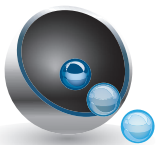

QUARX
MEDICAL

HOSPITALIZACIÓN



Camillas de traslado intrahospitalario

Seguro, ergonómico, inteligente y elegante

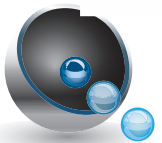

Cama hospitalaria

Salida frontal para mayor autonomía y comodidad

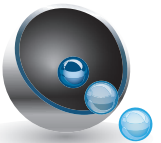

QUARX
MEDICAL

URGENCIAS



Desfibriladores

Diseño integrado y de rápida respuesta

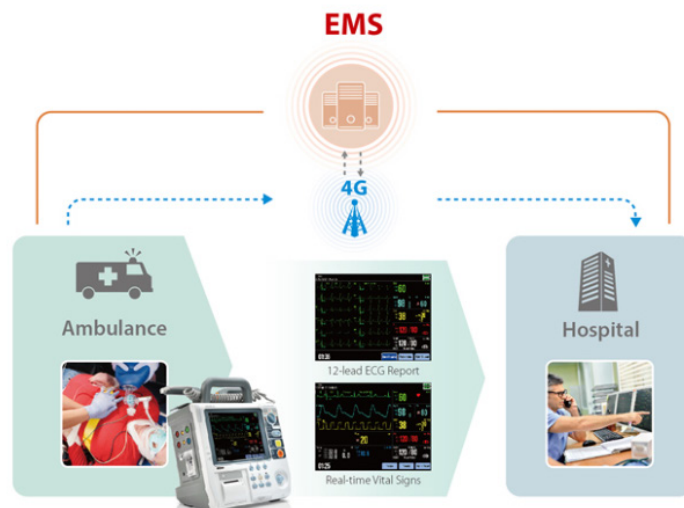

Sistema PHEIS™
ahorra tiempo y
salvavidas



Carros de emergencia

Carros personalizados para cualquier necesidad



Height	Width	Depth
PLY36		
36" 92 cm	33" 84 cm	23" 58 cm
PLY41		
41" 104 cm	33" 84 cm	23" 58 cm
PLY46		
46" 117 cm	33" 84 cm	23" 58 cm

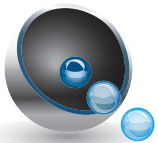

IMAGENOLOGÍA



Imagenología

Innovador arco en C quirúrgico digital

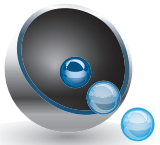

QUARX
MEDICAL

Ultrasonido Point of Care

Solución específica para pioneros
en atención

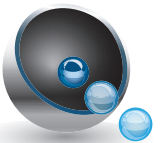

QUARX
MEDICAL

Rx rodable

Inteligencia e innovación en todas partes

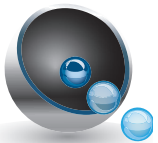

QUARX
MEDICAL

Electrocardiógrafos

Serie Beneheart

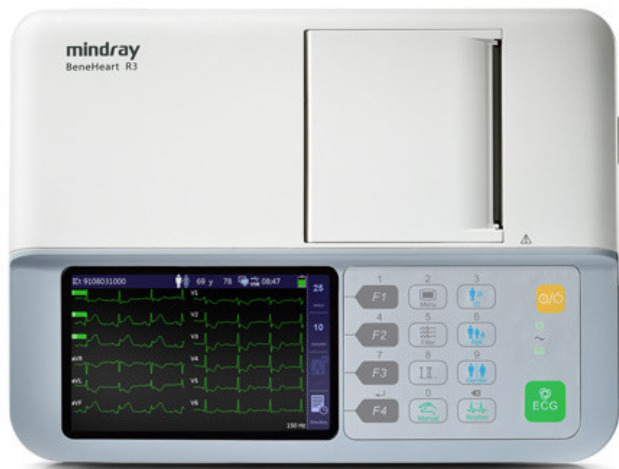

Beneheart R3



Beneheart R12



Carro de traslado
con canastilla



QUARX
MEDICAL

Pantallas de diagnósticos

Diseñado para la mejor calidad e inmersión



Negatoscopio

Desde 1 hasta 4 campos independientes

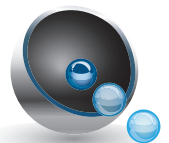

QUARX
MEDICAL

QUIRÓFANOS



Camilla quirúrgica

Seguridad, movilidad y versatilidad

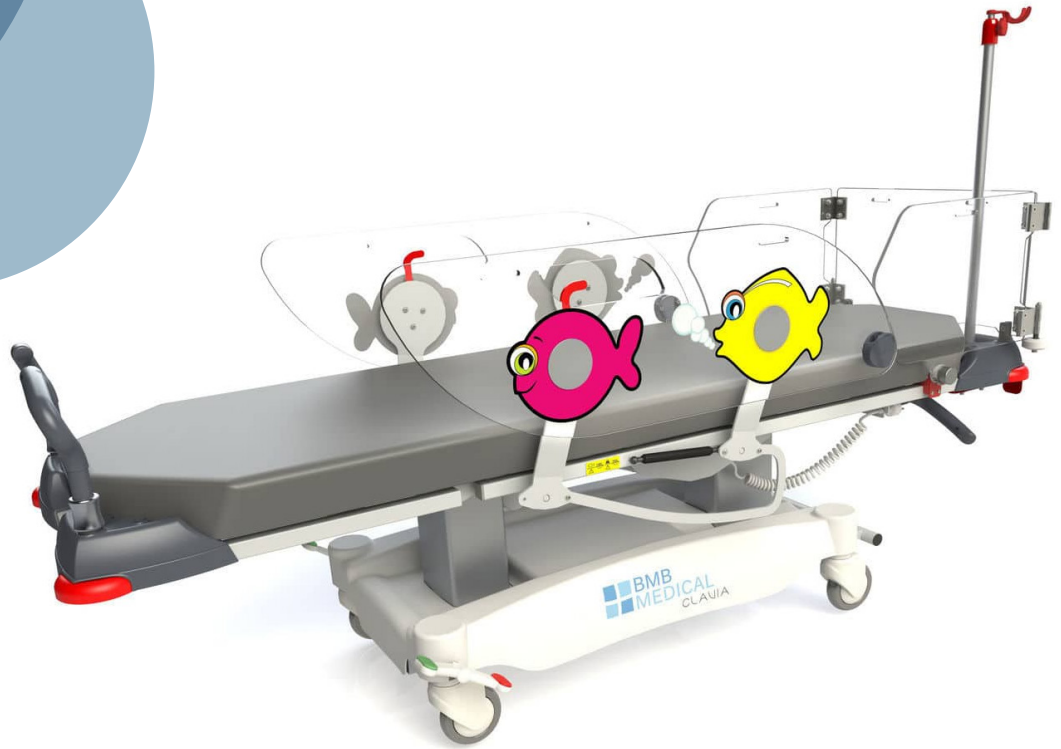

Mesas de cirugía

Tecnología electrohidráulica con versatilidad

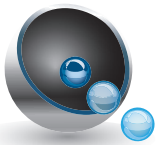

QUARX
MEDICAL

Iluminación quirúrgica

Hyled 7 equipo de alto rendimiento ergonómico y compacto



Iluminación quirúrgica

Hyled 8 Equipo versátil con óptimo rendimiento lumínico

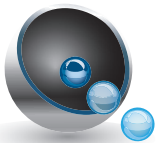
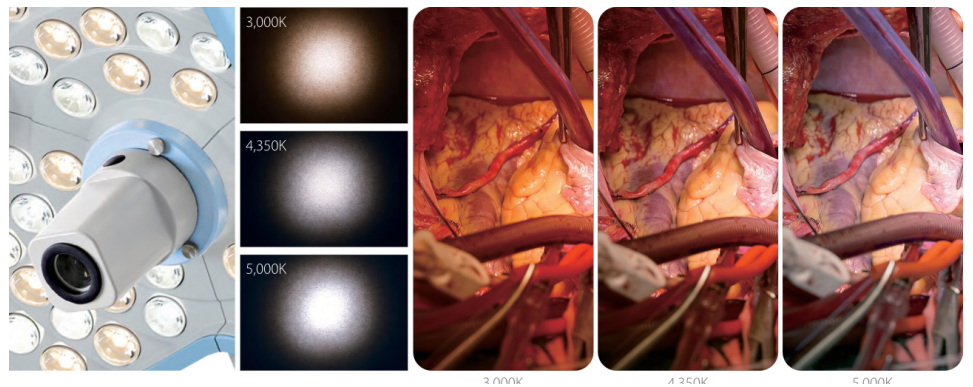

QUARX
MEDICAL

Iluminación quirúrgica

Hyled Serie X Visión mejorada con mejor tecnología



Iluminación quirúrgica

Hyled Serie C Visión mejorada con mejor tecnología



Pendants

Solución avanzada para diferentes aplicaciones

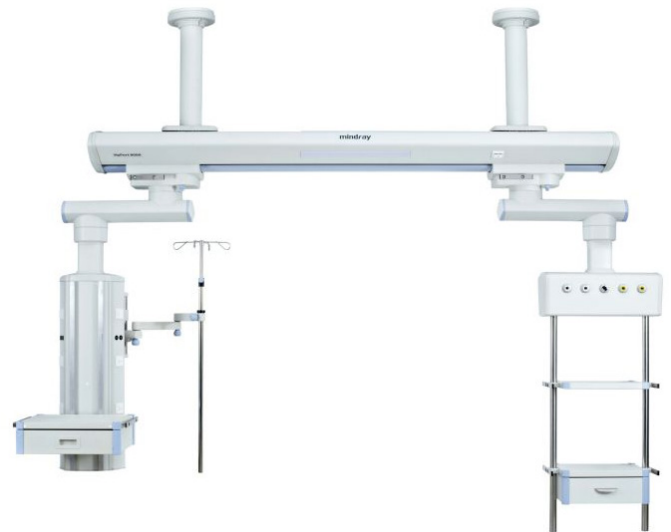

Pantallas grado quirúrgico

Desde Full HD hasta 4K con rojos intensos



IPS



2MP



sRGB 115%



Estabilización de
brillo



Sin parpadeos

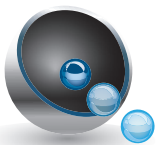

QUARX
MEDICAL

Máquinas de anestesia

WATO

Rendimiento excepcional con
diseño clásico



WATO EX- 20

Confiable y accesible



WATO EX- 35

Máquina versátil



WATO EX- 65

Funciones inteligentes
y más modos de
ventilación



WATO EX- 65 PRO

Funciones inteligentes y más
modos de ventilación



Máquinas de anestesia

Serie A

Tecnología de vanguardia que
brinda seguridad



A5 Interfaz y diseño ergonómico



A7 Avanzada y con precisión visible



A8 Sistema de anestesia de alto rendimiento de última generación



QUARX
MEDICAL
A9 Sistema de anestesia innovador con seguridad

Bomba TIVA/TCI

Eficiencia en la seguridad gota a gota



Benefusión eSP



Sistema SmartRapid™

Interacción intuitiva



Generador electroquirúrgico

Generador completo y universal con pantalla táctil

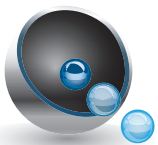

QUARX
MEDICAL

Endoscopia flexible

Sistema de alta definición más rentable y mejorado

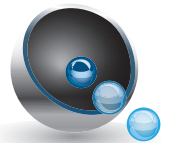
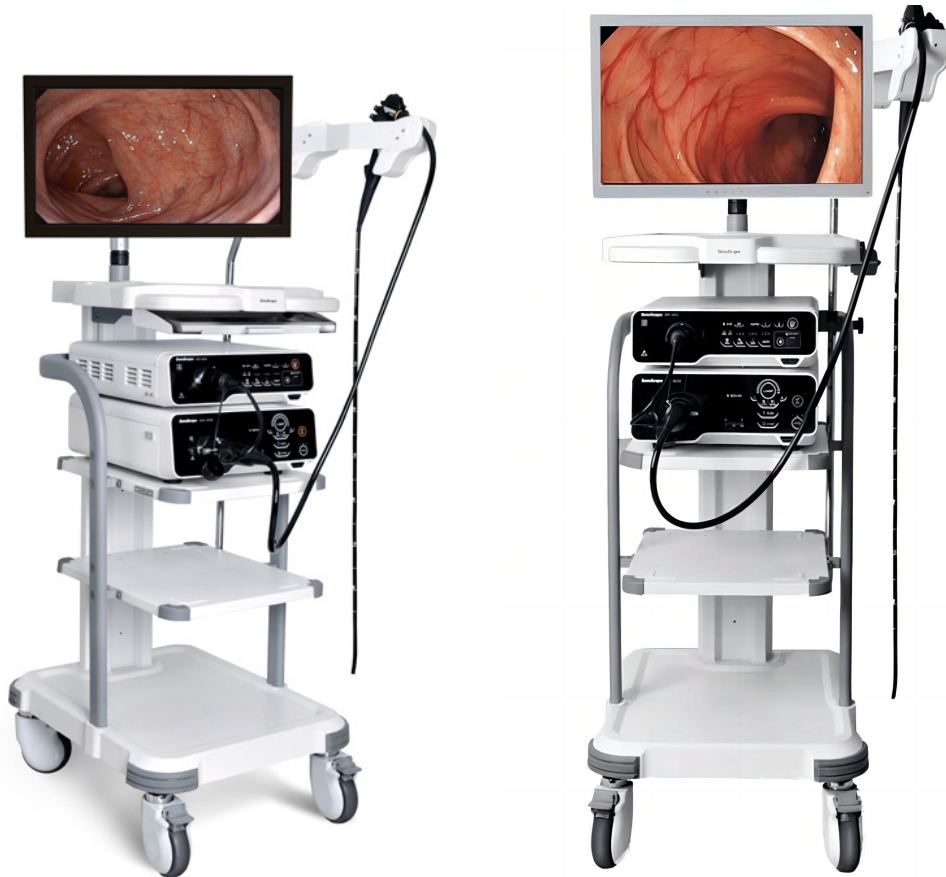

QUARX
MEDICAL

Laparoscopia

Sistema de cámara Full HD con sensor CMOS de 3 chips

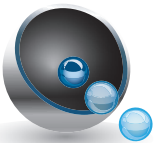

Laparoscopia

Sistema de cámara 4K con nitidez simple

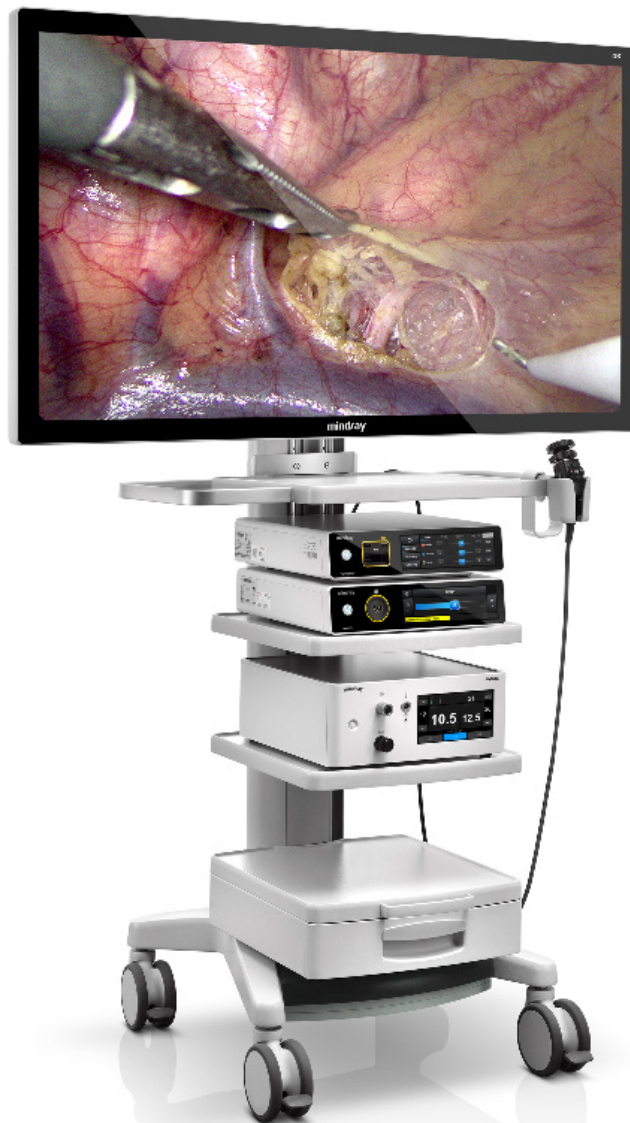

Laparoscopia

Sistema inteligente de asistencia robótica

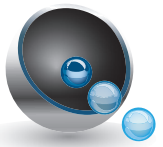
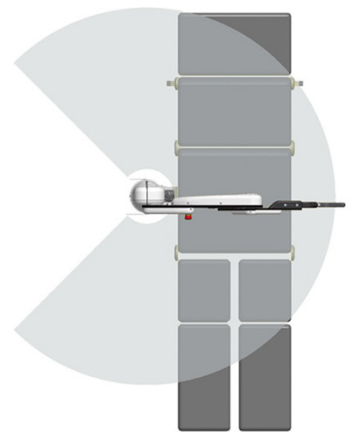

Laparoscopia

Sistema inteligente de asistencia robótica

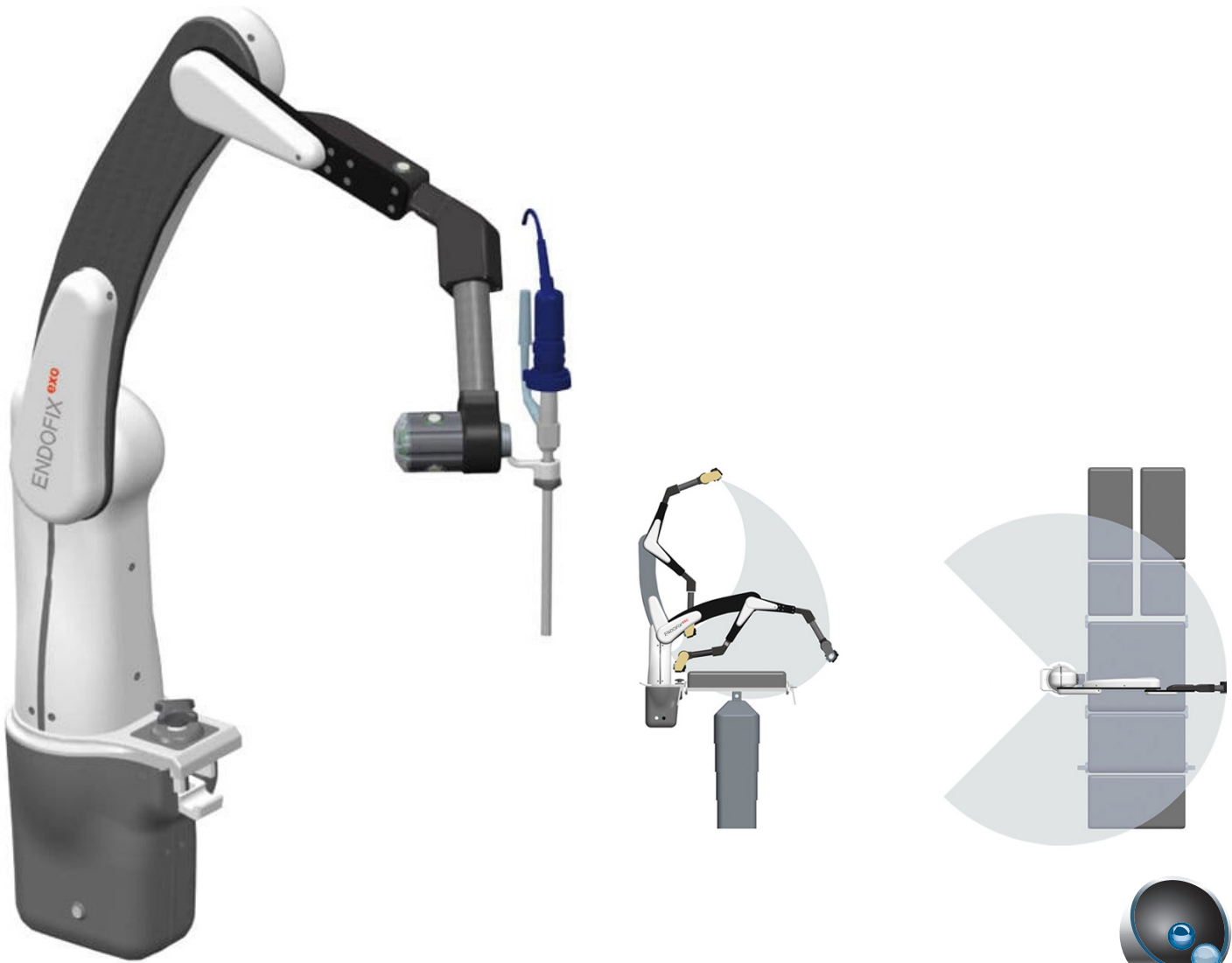

SALA DE RECUPERACIÓN



Monitoreo de signos vitales

Serie Benevisión

Experiencia del usuario mejorada



Monitoreo de signos vitales

Variedad de parámetros

HEMODINAMIA AVANZADA
IBP/PPV. ICG. C.O .• CCO.
PICCO. SCV02. SV02

MONITOREO CEREBRAL
BIS. B1SX4. EEG. INVOS RS02

MONITOREO CARDIACO
AVANZADO ECG. ARR/ST.
QT / QTC, 12-LEAD RESTING
LNTERPRETATION. D12L

RELAJACIÓN MUSCULAR NMT,
TOF-WATCH

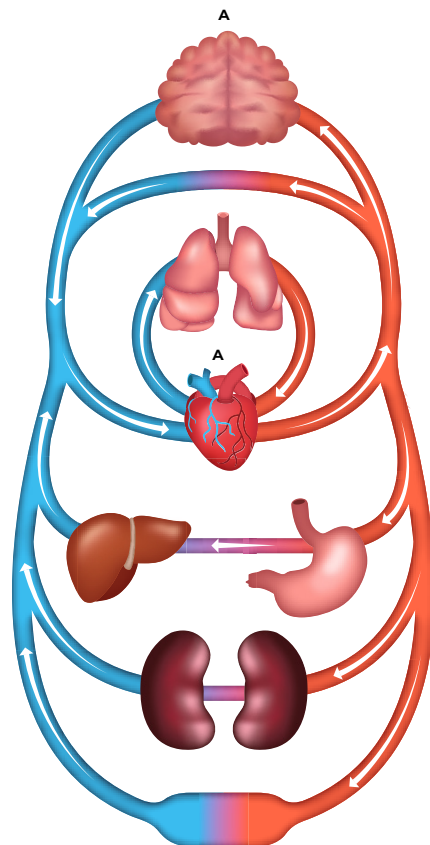

BALANCE SUPERIOR DE O2
SP02, SV02, D02, V02, TCGAS

MECÁNICA RESPIRATORIA RM

BALANCE SUPERIOR DE O2
SP02, SV02, D02, V02, TCGAS

POTENTES HERRAMIENTAS
DE APOYO A LA TOMA
DE DECISIONES CON 48
HORAS DE MUESTRA DE
PARÁMETROS

Monitoreo de signos vitales

Serie ePM

Evolución de la simplicidad

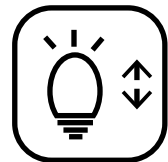

QUARX
MEDICAL

Monitoreo de signos vitales

Serie uMEC

Mediciones precisas para respaldar las decisiones clínicas del médico

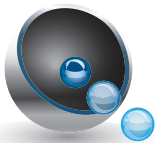

QUARX
MEDICAL

Ventilación mecánica

Soporte para todos los niveles de gravedad



Bomba de infusión

Seguridad, versatilidad y precisión en infusión



Sistema SmartRapid™

CENTRO DE INFUSIÓN / HEMODIALISIS



CEyE



Esterilización de vapor

Tecnología, ahorro y seguridad en cada ciclo

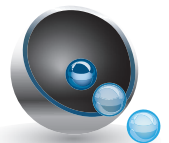

QUARX
MEDICAL

Esterilización de baja temperatura

Sistema inteligente de esterilización por plasma

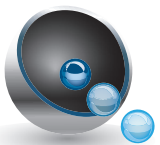

ACCESORIOS Y SUMINISTROS



Estuche de diagnóstico

- Tensiómetros
- Lámparas de diagnóstico
- Termómetro médico



Accesorios médicos

- Basculas médicas
- Otoscopios
- Tablas optométricas
- Martillos de reflejo
- Tablas optométricas

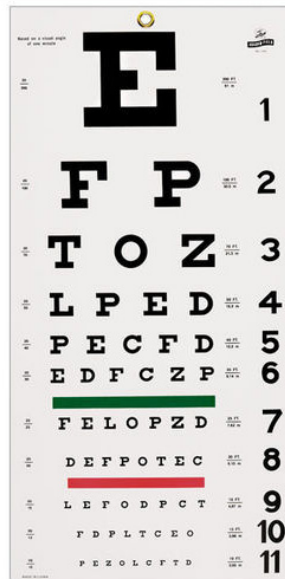

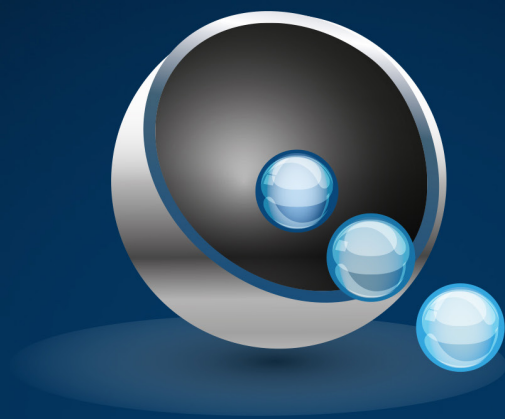

QUARX
M E D I C A L

AVENIDA INSURGENTES SUR 476, PISO 2, C.P. 06760 CDMX, MEXICO. TELÉFONO: 55-8977-0000

QUARX.COM.MX