

Model ADR-110, ADR-125

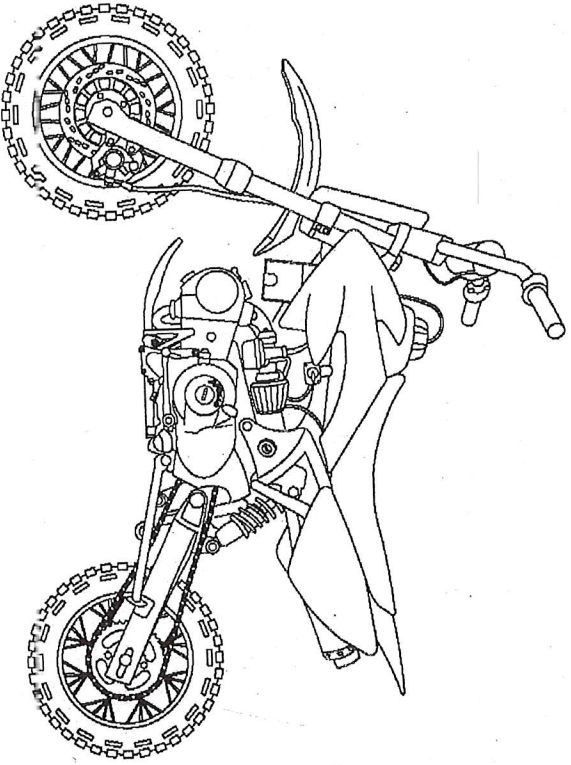

Owner's Manual

This manual should be considered a permanent part of the motorcycle and should remain if it is resold.

This manual contains the latest product information available before printing. Apollo Motor Corporation reserves the right to make changes at any time without notice and without incurring any obligation.

No part of this publication may be reproduced without written permission.

© Apollo Motor Corporation.

APOLLO MOTOR CORPORATION EMISSION CONTROL SYSTEM WARRANTY

YOUR WARRANTY RIGHTS AND OBLIGATIONS

The emission control system warranty period for this vehicle begins on the date the vehicle is delivered to the first purchaser other than an authorized dealer, or the date it is first used as a demonstrator, lease, or company vehicle, whichever comes first and continues for 30 months after that date, or 50,000 miles, whichever comes first, provided there has been no abuse, neglect or improper maintenance of your vehicle. Where a wear-and-tear condition exists, the Distributor will repair your vehicle at no cost to you, including diagnosis, parts and labor. If an emission-related part on your vehicle is defective, the part will be replaced or repaired by the Distributor. This is your emission control defects warranty.

OWNERS WARRANTY RESPONSIBILITIES

As the vehicle owner, you are responsible for the performance of the required maintenance. You should maintain a record of all maintenance performed on your vehicle and retain all receipts covering maintenance on your vehicle. You may not be denied a warranty claim solely because of your failure to ensure the performance of all scheduled maintenance or lack of maintenance records or receipts. You are responsible for presenting your vehicle to an authorized dealer as soon as a problem exists. The warranty repairs should be completed in a reasonable amount of time, not to exceed 30 days.

As the vehicle owner, you should be aware that you may be denied your warranty coverage if your vehicle or a part has failed due to abuse, neglect, improper maintenance, or unapproved modifications.

WARRANTY COVERAGE

- The Distributor warrants that each new 2010 and later vehicle:
 - x Is designed, built, and equipped so as to conform at the time of initial retail purchase with all applicable regulations of the United States Environmental Protection Agency, and the California Air Resources Board; and
 - x Is free from defects in material and workmanship which cause such vehicle to fail to conform with applicable regulations of the United States Environmental Protection Agency or the California Air Resources Board for the periods specified above.

Your emission control system warranty covers components whose failure would increase an engines emission, including selection to controls, fuel injection system, carburetor, the ignition system, and the air cleaner, or any other system inherent in this vehicle in normal operation. Any malfunctions that are not covered by this emission control system warranty is the responsibility of the owner.

Coverage of repairs under this warranty applies only when repairs are completed at an authorized dealer or repair facility. The Distributor will not cover repairs performed outside of an authorized dealer or repair facility, except in an emergency situation. The use of replacement parts not equivalent to the original parts may impact the effectiveness of your vehicles emission control system. If such a replacement part is used and an authorized dealer determines it is defective or causes a failure of a warranted part, your claim for repair to bring your vehicle into compliance with applicable standards may be denied.

If an emergency situation exists when a warranted part or a dealer is not reasonably available to the owner, repairs may be performed at any available service establishment, or by the owner, using any replacement part. The Distributor shall reimburse the owner for the expenses, including diagnostic charges, not to exceed the Distributors suggested retail price for all warranted parts replaced and labor charges based on the Distributors recommended time allowance for the warranty repair and in a geographically appropriate hourly labor rate. The owner may reasonably be required to keep receipts and failed parts in order to receive compensation.

This Emission Control System Warranty is in addition to the standard Limited Warranty.

EXCLUSIONS AND LIMITATIONS

- This warranty does not cover the following:
- x Failures or malfunctions of the emission control systems caused by abuse, alteration, accident, misuse, the use of leaded gasoline.
 - x Replacement of expendable maintenance items unless they are original equipment defective in material or workmanship under normal use and the first required replacement interval for the item has not been reached. Expendable maintenance items include but not limited to spark plugs, filters, coolant, lubricants, gaskets, hoses, and belts.
 - x Replacements of parts and other services and adjustments for required maintenance.
 - x Any vehicle equipped with an odometer or hour meter where the reading is altered so that actual mileage cannot be readily determined.
 - x Repairs or replacements as a result of:
 - c Accident
 - c Misuse
 - c Use of replacement parts or accessories not conforming to the original specifications which adversely affect performance
 - x Physical damage, corrosion, or defects caused by fire, explosions or similar causes beyond the control of the Distributor.
 - x Failures not caused by a defect in material or workmanship.
- Use of the vehicle in any type of competitive racing or related events immediately and completely voids this and all other warranties.

LIMITED LIABILITY

The liability of the Distributor under this Emission Control System Warranty is limited solely to the remedying of defects in material workmanship by an authorized dealer at its place of business during customary business hours. This warranty does not cover inconvenience or loss of use of the vehicle or transportation of the vehicle from the authorized dealer. The Distributor is not liable to any person for incidental, consequential or special damages of any description, whether arising out of express or implied warranty or any other contract, negligence or other tort or otherwise.

No express emission control system warranty is given by the Distributor except as specifically set forth herein. Any emission control system warranty implied by law, including any warranty of merchantability or fitness for a particular purpose is limited to the express emission control system warranty terms stated in this warranty. The foregoing statements of warranty are exclusive and in lieu of all other remedies. All express warranties not stated in this warranty are disclaimed. Some states do not allow limitations on how long an implied warranty lasts, so the above limitations may not apply if it is inconsistent with the controlling state law.

No dealer is authorized to modify this Emission Control System Warranty. If you have any questions regarding your warranty rights and responsibilities, you should contact Apollo Motor Corporation at 818-588-4435 (or you can write to 1528 N. Dominion Ave., Pasadena, CA 91104) or the California Air Resources Board, 5628 Telesar Avenue, El Monte, CA 91731 (for California registered vehicles only).

Contents

Safety Messages	1 - 4
Operating Controls	5 - 9
Before riding	10, 11
Basic Operation & Riding Technique	12 - 15
Starting and Stopping the Engine	12, 13
Shifting Gears	14
Braking Technique	15
Parking & Post Ride Inspection	15
Maintaining your Apollo Dirtbike	16 - 31
Maintenance Schedule	17
Fuel & Engine Oil	19 - 21
Air & Fuel Filter	21
Throttle-Freeplay Adjustment	22
Idle Speed Adjustment	22
Spark Plug	22, 23
Clutch Adjustment	24
Brake Adjustment	25, 26
Suspension Inspection	27
Tires & Wheel Rims	28, 29
Drive Chain	30 - 32
Troubleshooting	33 - 37
Resolving the Unexpected	38, 39

Resolving the Unexpected

If You Have a Flat Tire

How you handle a flat tire on the trail will depend on the severity of the damage to the tire and/or the inner tube and what tools and supplies you keep with you. If you have a slow leak or a minor puncture, there are two ways you can try to make a temporary repair:

1. Use an aerosol tire sealer to seal the puncture and inflate the tube. You can do this without removing the wheel.
2. Use a tube repair kit to patch the hole in the inner tube. This requires removal of the wheel and tire. If the leak is more severe, or a temporary repair does not hold up, you will need to replace the inner tube. If the tire is also severely damaged, you will need to replace the tire as well.

If you cannot repair the flat tire on the trail, you will need to push the motorcycle back to your base or send for help. Do not ride on a flat tire. The motorcycle will be hard to handle, and if the tire comes off the rim, it can lock up the wheel and cause you to crash.

If You Crash

Personal safety is the first priority after an accident. If you or anyone else has been injured, take plenty of time to assess the severity of the injuries and determine if it is safe to continue riding. If you cannot ride safely, send someone for help. Do not ride if you will risk further injury or if your motorcycle has been damaged too severely.

If you decide you are capable of riding safely, carefully inspect the motorcycle for damage. Check the tightness of critical nuts and bolts such as the handle bars, control levers, brakes and wheels. If there is minor damage, or you are not sure about possible damage but decide to ride back to your base, ride slowly and cautiously.

Sometimes crash damage is hidden or not immediately apparent. Once you get home, go over your motorcycle thoroughly and fix any problems that you find. Also, be sure to have your Apollo dealer inspect the frame and suspension after a serious crash.

If a Component Fails

The drive chain, master link, control cables, brake controls, and other components can be damaged if you ride in dense brush or over rocky terrain. As mentioned earlier, making the repair on the trail will depend on the severity of the damage, tools, supplies, and skills that you have.

1. If the drive chain comes off because the master link clip has been knocked off, you may be able to repair the chain with a new master link. However, if the chain is broken or causes damage when it comes off, you may not be able to make a trailside repair.
2. If any component of the front braking system is damaged, you may be able to ride back to your base carefully using the rear brake for slowing and stopping. Likewise, if a component of the rear braking system fails, you can use the front brake for slowing and stopping.
3. If you damage the throttle cable or some other critical component, the motorcycle may be unsafe to ride. Carefully assess the damage and make any repairs that you can. But if you have any doubts, it is best to be conservative and safe.

39 Resolving the Unexpected

Important Safety Information

Your personal safety, and the safety of those around you, is extremely important. Operating this motorcycle safely is an important responsibility. Apollo Motor Corporation has provided operating procedures and other information on labels and in this manual to help you make informed decisions about safety. This information will alert you to potential hazards that could harm you or others.

It is understood that it is not practical or possible to warn you about all possible hazards associated with operating and maintaining a motorcycle. You must use your own good judgment.

Safety information will come in a variety of different forms, including:

- **Safety Labels** on the motorcycle
- **Safety Messages** preceded by a safety symbol  and one of these three signal words: **DANGER, WARNING, or CAUTION.**

Below are the definitions of these three words:

DANGER

You WILL be KILLED or SERIOUSLY INJURED if you do not follow instructions.

WARNING

You CAN be KILLED or SERIOUSLY INJURED if you do not follow instructions.

CAUTION

You CAN be INJURED if you do not follow instructions.

- **Safety Headings** such as important safety reminders and/or precautions.
- **Safety Section** such as motorcycle safety.
- **Instructions** how to use the motorcycle safely and correctly.

This entire manual is filled with important safety information - please read it carefully.

Troubleshooting

Poor Handling

Steering is heavy

- Steering stem nut too tight.
- Damaged steering head bearings

Either wheel has a Wobble

- Excessive wheel bearing play
- Bent Rim
- Improperly installed wheel hub
- Damaged swingarm
- Bent frame
- Loose or broken spokes
- Old tires with "dryrot"

The motorcycle pulls to one side

- Front and rear wheels out of alignment
- Faulty shock absorber
- Damaged fork(s)
- Bent Swingarm
- Damaged axel
- Damaged frame
- Damaged upper or lower triple clamp

Important Safety Information for Parents

As a parent, your child's safety is your first priority. Riding an off-road motorcycle is very fun. However, just like riding a bicycle, bad decisions can result in injury. As a parent, you can greatly prevent accidents by making informed decisions about if, when and how your child will ride. Always supervise your child when he/she is riding.

Before you allow your child to ride, you need to decide if he/she is capable of riding. Riding readiness can vary tremendously from one person to another. Age and size are not be the only factors that help determine one's riding readiness. There are three other factors that you should also consider before deciding if your child is ready to ride.

First, consider the **physical ability** of your child. Riders must be able to hold the motorcycle up, get on, and sit comfortably with both feet on the ground. The rider must also be able to reach all of the controls on the handlebars and work the brakes and clutch. Second, consider your child's **athletic ability**. Your child should be good at riding a bicycle before riding a motorcycle. Determine if your child can judge speeds and distances while riding a bicycle and react with the proper hand and foot actions. Any person who does not have good coordination, balance, and agility should not ride this motorcycle.

Finally, determine your child's level of **mental maturity**. It is imperative that you are honest with yourself when you ask yourself the following questions: Does your child think through problems and come to logical conclusions? Does your child obey your rules when they ride their bicycle? If your child makes bad judgements, takes un-warranted risks and/or does not obey your rules, they should not ride this motorcycle.

If you have decided that your child is ready to ride, please remember the following points and never let your child ride without a helmet. It is up to you (parent) to ensure your child's safety, even if they learn to ride from another experienced adult. Never push your child to try things faster than they are willing or capable. Always supervise your child when they are riding and regularly remind them about safety rules. As a parent it is your responsibility to be sure that the motorcycle is properly maintained and kept in safe operating condition.

Modifying this motorcycle or using parts not manufactured by Apollo Motors can make your motorcycle unsafe. Before you consider making any modifications or adding an accessory, please read the following information carefully.

WARNING Improper accessories or modifications can cause a crash in which you can be seriously hurt or killed. Follow all instructions in this owner's manual regarding modifications and accessories.

Apollo Motors strongly recommends that you do not remove any original equipment or modify your motorcycle in any way that may alter the design and/or operation. Such a change could drastically impair the stability, handling, acceleration, and braking capabilities of the motorcycle and cause a crash. We also strongly suggest that you do not make any modifications to the exhaust system components.

Troubleshooting

Poor Performance at Idle & Low Speed (cont.)

2. Spark Test - Part for ignition spark by removing the spark plug and inserting it into the spark plug cap. Place the open end of the spark plug on a metal part of the engine and kickstart the engine. You should see a nice blue spark on the end of the spark plug. A faint spark will not start the engine.

DANGER Do not touch the spark plug or plug cap while kickstarting the engine. You will receive an electrical shock which could result in serious injury or death.

Is there a good spark?

No

- Fouled or faulty spark plug
- Broken or shorted spark plug wire or spark plug cap
- Broken or shorted ignition coil
- Faulty ignition CDI Box
- Faulty or shorted magneto assembly
- Broken or shorted engine stop switch
- Loose or corroded wires and/or connectors (always clean bad electrical connectors)

Yes

- SEE STEP 3

3. Carburetor Air Screw Inspection - Check the carburetor air screw. Turn the screw clockwise until you feel it stop. Do not tighten. Back out the screw counter clockwise 1.5 turns.

Is the air screw setting correct?

No

- Adjust using the procedure above.

Yes

- SEE STEP 4

4. Ignition Timing Inspection - See your local Apollo dealer or motorcycle repair shop to have the ignition timing inspected. Only attempt these procedures if you are qualified and have the proper tools needed.

Is the ignition timing normal?

No

- Faulty CDI ignition box
- Faulty ignition pulse generator

Yes

- See your Orion dealer to have your motorcycle serviced

Poor Performance at High Speed

1. Examine the Fuel Line - Disconnect the fuel hose at the carburetor.

Is there fuel flowing freely?

No

- Clogged fuel hose/line or clogged fuel filter
- Clogged Fuel Valve
- Clogged fuel tank breather hose

Yes

- SEE STEP 2

2. Carburetor Inspection - Disassemble the carburetor and check for clogs. Wipe the carburetor clogged and dirty?

Yes

- SEE STEP 3

No

- Carburetor is not serviced frequently enough, contaminated fuel

3. Ignition Timing & Valve train Inspection - See your local Apollo dealer or motorcycle repair shop to have the ignition timing inspected. Only attempt these procedures if you are qualified and have the proper tools needed. Are the ignition timing, valve timing and valve springs normal?

No

- Faulty CDI ignition box
- Faulty ignition pulse generator
- Broken valve spring
- Broken or damaged camshaft sprocket

Yes

- See your Apollo dealer to have your motorcycle serviced

Operating Controls

When you ride a motorcycle off-road, you need to be able to operate the throttle, clutch, brakes, and other controls without stopping to look at them. Please read this section carefully before you ride your motorcycle. This section of the manual will describe the function, location, and operation of all the basic controls of your motorcycle.

Component Locations

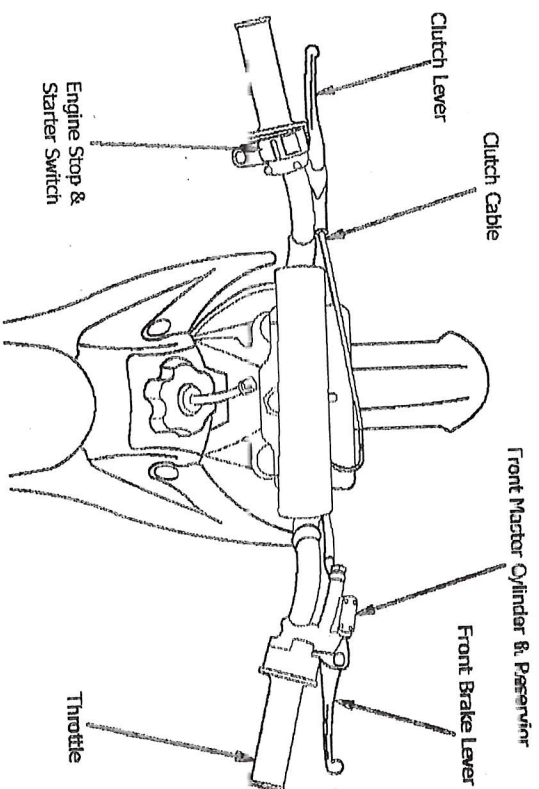

Troubleshooting

Engine does not start or is hard to start

1. Examining the Carburetor - Be sure there is fuel flowing into the carburetor.

Is there fuel flowing into the carburetor?

No

- Clogged fuel hose/line or clogged fuel filter
- Clogged Fuel Valve
- Clogged fuel tank breather hose
- Sticking or stuck carburetor float

Yes

- SEE STEP 2

2. Examining the Spark Plug - Remove the spark plug and inspect. (see page 23)

Is the spark plug in good working condition?

No

- Flooded engine and/or carburetor
- Choke valve is closed
- Throttle is stuck open
- Dirty or clogged air filter
- Excessively worn piston rings (replace engine or piston)

Yes

- SEE STEP 3

3. Spark Test - Test for livid spark by removing the spark plug and inserting it into the spark plug cap. Place the open end of the spark plug on a metal part of the engine and kickstart the engine. You should see a nice blue spark on the end of the spark plug. A faint spark will not start the engine.

WARNING

Do not touch the spark plug or plug cap while kickstarting the engine. You will receive an electrical shock which could result in serious injury or death.

Is there a good spark?

No

- Fouled or faulty spark plug
- Broken or shorted spark plug wire or spark plug cap
- Broken or shorted ignition coil
- Faulty ignition CDI Box
- Faulty or shorted magneto assembly
- Ditch or shorted engine from switch
- Loose or corroded wires and/or connectors (always clean bad electrical connections)

Yes

- SEE STEP 4

4. Cylinder Compression Test - Perform a simple compression test by kickstarting the engine slowly. Be sure you have the spark plug installed. While pushing down on the kickstart slowly, you should feel a very hard firmness that will abruptly soften as the kickstart lever moves further down. No hard firmness in the kickstart lever means you have poor compression.

Is the compression normal?

No

- Valve stuck open/seized or improper valve timing (see your Apollo dealer)
- Worn cylinder wall and/or piston rings (replace engine or piston)
- Leaking or damaged cylinder head gasket (see your Apollo dealer)

Yes

- SEE STEP 5

5. Engine Start Condition - Start the engine by using the normal starting procedure (see page 12,13)

Does the engine start but then stop quickly afterward?

Yes

- Improper choke operation
- Dirty or improperly adjusted carburetor (Contact your Apollo Dealer)
- Dirty or contaminated gasolene
- Dirty or contaminated gasolene

Operating Controls

Fuel Valve

The two way fuel valve is used to control the flow of fuel from the gas tank to the carburetor. The valve is located under the gas tank. Turning the fuel valve to the "ON" position before starting the engine allows fuel to flow from the tank to the carburetor. Turning the fuel valve to the "OFF" position after shutting off the engine stops the flow of fuel from the gas tank to the carburetor. Always keep the fuel valve in the "OFF" position when you are not using the motorcycle.

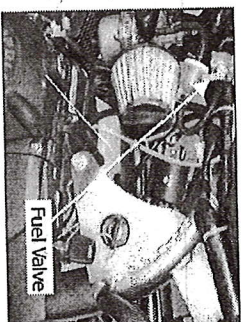

Choke Lever

The choke lever is used for starting the engine when it is cold or when you live in a cold weather climate. The choke lever increases the amount of fuel in the air/fuel mixture that is delivered to the engine. See the photo to the right.

Position A - Choke Fully ON
Position B - Choke Fully OFF

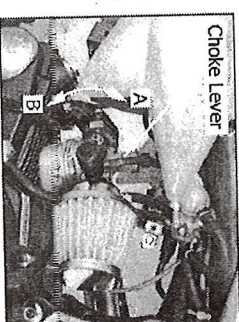

Engine Stop/Electric Start Switch

The engine stop switch is used to turn off the engine. When the switch is in the "OFF" position it will remove the spark from the ignition system. To start and ride the motorcycle, push the small red button (bottom). This is the "RUN" position. To shut off the engine, push the large red button (top). This is the "OFF" position. To start the engine, pull and hold the front brake lever and push the yellow start button. Release the start button when the engine is running.

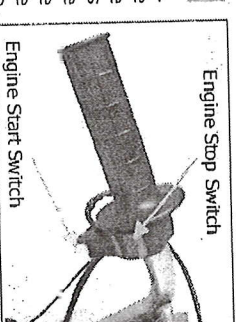

Ignition Key Switch

The ignition key switch is used to supply power from the battery to the components of the motorcycle. Turn the switch to "ON" before starting and riding the motorcycle. Turn the switch to "OFF" when you are through riding or if you wish to stop the engine. In an emergency, use the engine stop button to stop the engine.



Operating Controls

Kickstarter

The kickstarter is used to start the engine. To use the kickstarter, pull it out from its stored position and depress it through its entire stroke with your foot. Please refer to the Basic Operation and Riding section of this manual for detailed instructions on starting the engine.

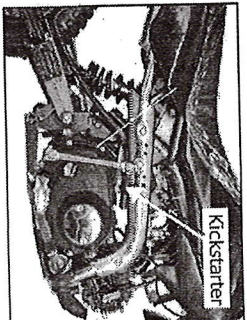

Clutch Lever

The clutch lever is used to engage and disengage the clutch. The clutch lever is used when starting from a standstill and when shifting gears. Please refer to the Basic Operation & Riding section of this manual for instructions on shifting gears. To engage the clutch, pull the clutch lever completely back to the handlebar. Release the clutch lever to disengage the clutch.

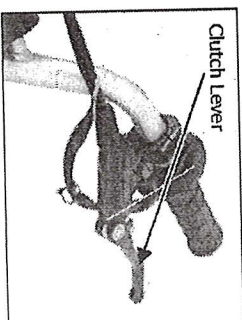

Spark Plug

The spark plug is used to produce the spark that fires the engine. You should never touch the spark plug when the engine is running or you will be shocked. Please refer to the Servicing section of this manual for detailed instructions on cleaning and replacing a spark plug.

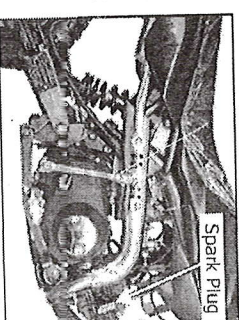

Must dump out the used oil before the used oil exceed 2/3 capacity of the save tubing, otherwise it will go against the power performance, even damage the engine.

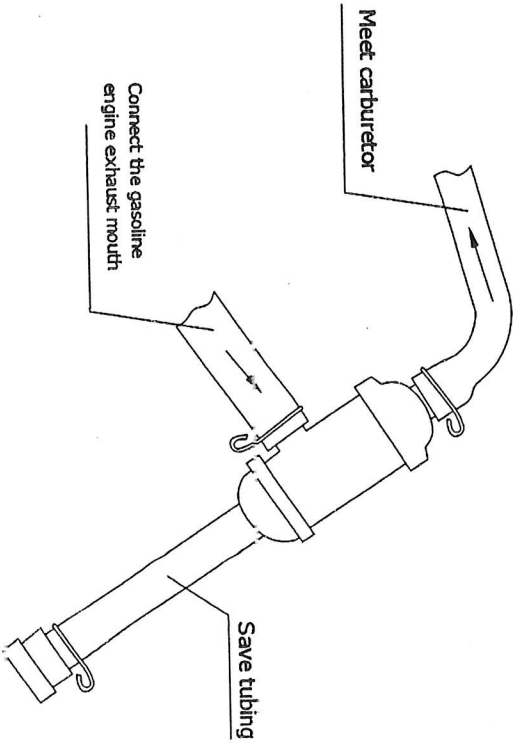

WARNING

Sidestand

The side stand is used to support the motorcycle when it is parked. To operate, use your foot to lower the stand. Always raise the stand before riding.

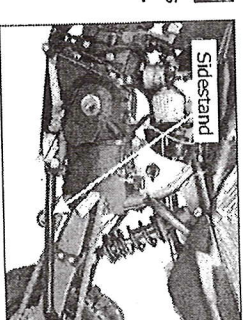

Basic Maintenance Procedures

Drive Chain Inspection

The service life of your drive chain will depend on several factors, including proper lubrication, adjustment, and riding style. If you are an experienced rider and tend to ride in a more intense manner, or you ride in muddy/dusty areas, you will need to check the drive chain more frequently. Poor maintenance will cause pre-mature wear and/or damage to the drive chain and sprockets.

Before you service your drive chain, be sure you are parked on a level surface and you turn the engine OFF. Be sure the transmission is in neutral. It is not necessary to remove or replace the chain to perform recommended maintenance service.

1. Check the slack in the lower drive chain midway between the sprockets (2). Push upward on the chain with your finger. The vertical movement should measure between $3/8$ - $3/16$ in (10-20mm).
2. Repeat step 1 along several prints of the drive chain. The slack should remain constant through out. If it is not, some links may be kinked and binding. Lubricating the chain will often stop this.

NOTICE

Excessive drive chain slack may allow the drive chain to damage the engine cases.

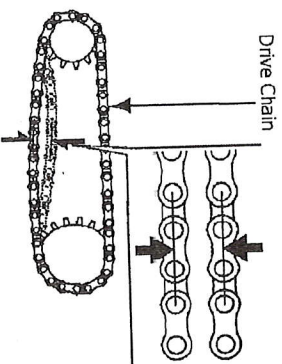

3. Inspect the drive chain for the following: damaged rollers, loose pins, dry or rusted links, kinked or binding links and excessive wear. Replace the chain if it has damaged rollers, loose pins, or kinks that cannot be freed. Lubricate the drive chain if it appears dry or shows signs of rust. Lubricate any kinked or binding links and work them free.
4. You should replace the drive chain once the rear axle is moved as far back as possible and slack still remains. This indicates that the chain is worn beyond its service limit.
5. Inspect the front and rear sprockets for excessive wear or damage. Refer to the illustration at the top of page 30. If needed, replace any worn or damaged sprockets. See your Apollo dealer for assistance.

Is the Motorcycle Ready to Ride?

Before each and every ride you take, it is extremely important that you inspect the motorcycle and make sure any problems you find are corrected. A pre-ride inspection is a must because off-road riding can be very tough on the motorcycle and you do not want to have a breakdown far from help.

WARNING Improperly maintaining your motorcycle or failing to correct a problem before riding can cause a crash in which you can be seriously hurt or killed. Always perform a pre-ride inspection before any ride and correct any problems.

Note to Parents: If a youngster will be performing any of the following pre-ride inspection procedures, it is your responsibility to provide careful supervision and make sure they are performed safely.

Pre-ride Inspection

Check the following items before you get on the motorcycle:

- Tires** - Use a tire pressure gauge to check the air pressure. Inflate or deflate as needed. Also check for signs of damage or excessive wear.
 - Spokes & Rims** - Make sure all of the spokes are tight. Inspect the rim to be sure it is not bent.
 - Leaks** - Look under the motorcycle for signs of leaking fluid such as engine oil or gasoline.
 - Engine Oil** - Check the level of engine oil and add if needed.
 - Fuel** - Check the level of fuel in the gas tank. Add if needed. Be sure the gas cap is tightened securely.
 - Drive Chain** - Inspect the drive chain condition and slack. Adjust and lubricate if needed. Also check the chain slider for wear and replace when it is worn. For detailed instructions on drive chain slack adjustment, see the Servicing section of this manual.
 - Brake Hoses** - Inspect the brake hoses for leaks and replace if needed.
 - Nuts & Bolts** - Inspect all accessible nuts and bolts. Tighten them if it is needed.
 - Spark Plug & Cap** - Check the spark plug for looseness. Tighten if needed. Be sure the cap is fastened to the spark plug properly.
- Check the following items after you get on the motorcycle:
- Throttle** - Check the throttle freeplay and adjust if needed. Rotate the throttle to be sure it moves easily and freely. Make sure that it snaps shut automatically when you release it in all steering positions.
 - Brakes** - Step on the rear brake pedal and squeeze the front brake lever to be sure the brakes are working properly. Remember, be sure to take care of any problems you find or have your Apollo Motors dealer correct it before you ride.

Basic Maintenance Procedures

Wheel Rims & Spokes

Maintenance of spoke tension and wheel trueness (roundness) is critical to safe motorcycle operation. During the first 100 miles of riding, spokes will loosen faster due to the initial seating of the parts. Excessively loose spokes will cause the motorcycle to become unstable at high speed and could cause you to lose control. Loose spokes can also cause rim and spoke damage (not covered in the warranty).

It is not necessary to remove the wheels for regular maintenance, however, information on wheel removal is available from Apollo Motors or your Apollo dealer.

Wheel Rim Inspection Procedure

1. Inspect the wheel rims and spokes for damage. Feel all of the spokes with your fingers to make sure none are loose.
2. Tighten any loose spokes with a small adjustable wrench or spoke wrench.
3. Elevate each wheel off the ground, one at a time, and spin the wheel slowly. Look for a wobble in the wheel. If a wobble is evident, the wheel is not "true". See your Apollo dealer or local motorcycle shop for inspection.

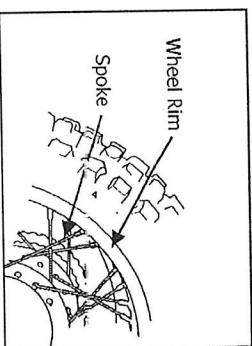

Tire Air Pressure

Properly inflated tires will provide you with the best combination of handling, tread life, and riding comfort. Generally speaking, underinflated tires will wear unevenly and adversely affect handling. Underinflated tires are also more likely to fall from being overcorrected and can cause wheel damage on rocky terrain. Overinflated tires will cause the motorcycle to ride harshly, are prone to failure from surface hazards and wear unevenly.

WARNING Using tires that are excessively worn or improperly inflated can cause a crash in which you can be seriously hurt or killed. Follow all instructions in this owner's manual regarding tire inflation and maintenance.

Make sure the valve stem caps are secure. If needed, install a new cap. Always check air pressure when your tires are cold. If you check the air pressure when the tires are warm, you will get higher readings. If you let air out of warm tires to match the recommended cold tire pressure, the tires will be underinflated. The correct cold tire pressures are listed below. If you replace the tire, follow the tire pressure marked on the sidewall of the tire.

Front Tire (Cold)	32 PSI (220 kPa, 2.2 kgf/cm ²)
Rear Tire (Cold)	36 PSI (248 kPa, 2.5 kgf/cm ²)

Starting & Stopping the Engine

Starting Procedure (cont.)

3. Once the engine starts, warm up the engine by opening and closing the throttle slightly.
4. About 15 seconds after the engine starts, push the choke lever all the way down to position B (fully off).
5. If the engine idle is unstable, open the throttle slightly. The idle will smooth out as the engine gets warmer.

Higher Air Temperature 95° F (35° C) or above.

1. Do not use the choke.
2. Start the engine (Follow step 2 under normal air temperature)

Lower Air Temperature 50° F (10° C) or below.

1. Follow steps 1 - 2 under normal air temperature.
2. Warm up the engine by opening and closing the throttle slightly.
3. Continue warming up the engine until it idles smoothly and responds to the throttle with the choke lever in position B (fully off).

Notice: Extended use of the choke in position A (fully on) may impair piston and cylinder wall lubrication and damage the engine.

Flooded Engine

If the engine fails to start after repeated attempts, it may be flooded with excess fuel. Follow the steps below to clear a flooded engine:

1. Push the engine stop switch into the "OFF" position.
2. Push the choke lever down to the all the way off position.
3. Open the throttle completely.
4. Crank the engine several times using the kick starter.
5. Push the engine stop switch into the "ON" position.
6. Follow the high air temperature starting procedure.

How to Stop the Engine

To stop the engine, shift into neutral or squeeze the clutch lever, push the engine stop switch into the "OFF" position.

Basic Maintenance Procedures

Brake Pad Wear

Hydraulic disc brake systems use a brake caliper to squeeze the rotor (brake disc) which causes the motorcycle to stop. Inside the brake calipers are brake pads. The brake pads are the part of the brake system that make contact with the brake rotor. The pads must be checked in accordance with the maintenance schedule for the brake system as described on page xx. Follow the procedure below to check the brake pad wear.

Brake pad inspection procedure.

1. Clean all dust and dirt away from the brake calipers and brake rotors. Avoid spraying any cleaners directly into the caliper. Some cleaners will damage the seals and cause a leak.
2. Check the thickness of the brake pad abrasive material. The thickness should be no less than .0625 inches or 1.5 mm.
3. If you find that both pads on each caliper are not wearing down evenly, you may need to replace the brake pads. Replace any worn brake pads immediately.
4. If you are unsure how to replace the brake pads, refer to the diagrams at the end of this section or contact your local Apollo dealer.

Minimum .0625" (1.5 mm)

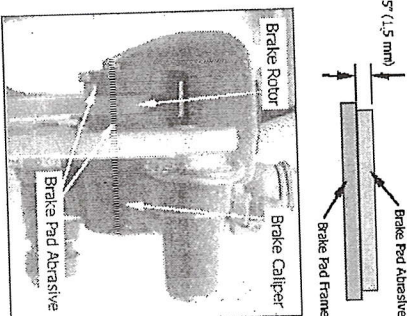

Bleeding the Brake System

Because the brake system utilizes fluid, any air bubbles inside the brake system will cause you to lose braking efficiency. Air generally enters the brake system when the motorcycle sits unused for long periods of time. Air will also enter the system if you have a leaking brake hose, brake caliper or master cylinder. A brake system with air will cause the brake lever and pedal to feel soft and spongy. Use the procedure below to bleed air from both the front and rear brake system.

Brake system bleeding procedure:

1. Clean all dust and dirt from the master cylinder and remove the master cylinder cap.
2. Pump the brake lever or pedal slowly and firmly 4 times and then hold it.
3. Using a 8mm wrench or socket, loosen the bleeder valve located on the brake caliper. You will see brake fluid and possibly some air bubbles exit out the bleeder valve.
4. Tighten the bleeder valve and then release the lever or pedal.
5. Repeat steps 1 - 4 until all air bubbles have stopped flowing from the bleeder valve. The lever/pedal should feel hard and firm when you are complete.

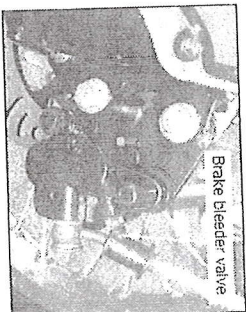

Braking Technique

This section will cover basic braking technique for your motorcycle. To slow or stop the motorcycle, squeeze and hold the clutch lever and apply the front brake lever and rear brake pedal firmly and smoothly. If your speed is reduced a significant amount, you may need to downshift to a lower gear. Gradually increase your braking pressure as you feel it is needed. When you come to a stop, put your left foot down first, then your right foot. Do this so that your brake pedal foot remains on the brake pedal until you come to a complete stop. To prevent the engine from stalling, always pull and hold the clutch lever when slowing to a complete stop unless you are in neutral.

For maximum braking, close the throttle and firmly apply both the front and rear brake. On a motorcycle, the front brake accounts for 70% of the total stopping power of the motorcycle. The rear brake only accounts for 30%. This is because of the weight transfer that occurs when you apply the brakes. When you must stop quickly, you must use the front brake together with the rear brake. Remember that you can apply more brake to the front wheel than you can to the rear wheel before it will lock up and cause a skid. Finding the proper balance between the amount of front and rear brake pressure you use will come with experience. Attempting an abrupt stop with only the rear brake will likely cause a skid.

Applying the brakes too hard or too fast can cause the wheels to lock and cause a skid, reducing your control of the motorcycle. If this happens, release the brake controls and steer straight ahead until you regain control of the motorcycle. Once you have control, reapply the brakes with less force.

Generally, reduce your speed and complete your braking before you begin a turn. Avoid braking or rinsing the throttle quickly while turning. Either of these actions may cause one or both of the wheels to slip. Any wheel slip will reduce your control over the motorcycle and could cause a crash.

When riding in wet or rainy conditions, or on loose surfaces such as mud or sand, your ability to maneuver and stop the motorcycle will be reduced. All of your actions should be done in a smooth and steady manner under these conditions. Rapid acceleration, braking, or turning can cause you to lose control of the motorcycle. For your safety, exercise extreme caution when riding under wet, rainy, and/or muddy conditions.

When descending a long, steep grade, use engine compression braking by downshifting with intermittent use of both brakes.

Parking & Post Ride Inspection

Lower the side stand to support your motorcycle. Turn the engine stop switch to the "OFF" position. If you are through riding for the day, turn the fuel valve to the "OFF" position. Always park the motorcycle on a flat level surface. If you will be storing the motorcycle for a long period of time, turn the fuel valve to the "OFF" position while the engine is still running. Open and close the throttle repeatedly until the engine stops running on its own. Do this to use up any fuel that still remains in the carburetor. This will help you avoid carburetor problems that can occur when your motorcycle is stored for long periods of time with gasoline left in the carburetor.

When you return home from a ride, completely clean your motorcycle and remove dirt, mud, bush, rocks and other objects you may have picked up when riding. Check your motorcycle for damage and leaks. Be sure to lubricate the drive chain to prevent rusting.

Basic Maintenance Procedures

Clutch Freeplay & Adjustment

In order to ensure the best performance and durability from the clutch, always be sure you have proper clutch freeplay. Freeplay is needed to ensure that the clutch has room for wear. A clutch with no freeplay will begin to slip as the discs wear down. Failure to fix a slipping clutch can cause clutch damage. To check the freeplay, simply pull on the clutch lever. The lever should move very easily within the freeplay range before you feel the clutch begin to engage. If too much or too little freeplay exists, adjust as needed.

Clutch Freeplay - 1/16 - 1/4 inch (2 - 6mm)

1. Pull back the dust cover.
2. Loosen the adjuster lock nut.
3. Turn the adjuster clockwise to add freeplay and counter clockwise to remove freeplay.
4. After adjustment, check the clutch lever pull for smoothness and proper freeplay.
5. Periodically lubricate the clutch cable to prevent rust.
6. Tighten the adjuster lock nut and push back the dust cover.

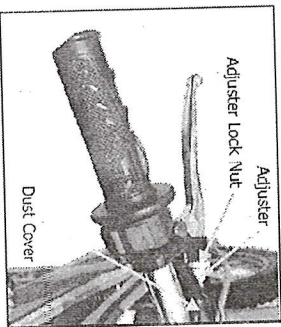

A second adjustment may be needed if the clutch is slipping or if the clutch will not engage. Follow the steps below carefully to perform this adjustment. If the clutch is slipping, you will need to decrease the amount of clutch engagement. If you squeeze the clutch lever all the way and the clutch still will not engage, you need to increase the engagement.

1. Remove the right side dust cover using a Phillips head screwdriver.
2. Loosen the lock nut.
3. Turn the adjustment screw clockwise one full turn. Do not turn excessively.
4. Slowly turn the adjustment screw counter clockwise until you feel slight resistance.
5. From this position, turn the adjustment screw clockwise 1/8 to 1/4 turn and tighten the lock nut.
6. Check the clutch lever to be sure you have proper freeplay.
7. Replace the right side dust cover and securely tighten the two screws.
8. Test ride the motorcycle to be sure the clutch is working properly.

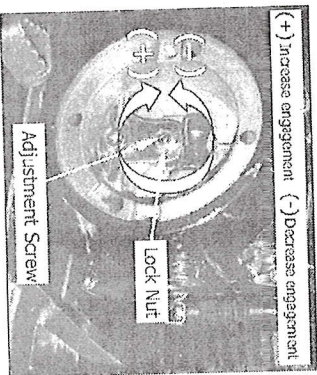

If you are unable to get the proper adjustment and/or freeplay, or the clutch still will not work properly, your clutch may need service. Contact your local Apollo Motors Dealer.

Maintenance Schedule

To keep your motorcycle safe and reliable when you ride, regular inspections and service is required. Below you will find a maintenance schedule that describes when components need to be inspected or serviced. The maintenance schedule lists items that can be performed with basic mechanical skills and hand tools. In addition, the maintenance schedule will list items that involve more extensive procedures and could require special training, tools and/or equipment.

Because this motorcycle does not have an odometer, service intervals in the maintenance schedule are expressed in terms of riding days. To avoid missing required maintenance, we suggest that you develop a good way to record the amount of time you spend riding your motorcycle. If you do not feel capable of performing any of the procedures described in this manual or if you need assistance, please contact your nearest Apollo dealer. If you decide to do your own maintenance, use only replacement parts that you have purchased from a Apollo dealer or parts purchased directly from Apollo Motors. This will ensure the best quality and reliability for your motorcycle.

Always perform the pre-ride inspection described on page 14 at each scheduled maintenance interval.

Each item on the maintenance schedule requires some mechanical knowledge. You will find that some items in the table (marked * and **) may require a higher level of mechanical skill and special tools. If you do not feel capable of performing any procedure, please consult your nearest Apollo Motors dealer.

- * Indicates items that require a moderate to high level of mechanical skill. We recommend service by an Apollo dealer if the owner is not mechanically qualified.
- ** Indicates items and procedures that require special tools.

Note: Service your motorcycle more frequently when you ride in wet or dusty conditions.

Maintenance Procedures: I = Inspect (clean, adjust or replace if needed), C = Clean, A = Adjust, L = Lubricate, R = Replace

Items	Frequency	Month					Refer to Page:
		1	6	12	18	24	
Fuel Line				I			
Fuel Filter				I	R		R
Theoretic Operation				I			
Air Filter			C		C		C
Spark Plug				I	I		I
Engine Oil				R		R	R
Engine Idle Speed				I			I
Drive Chain				I			I
Drive Chain Sprocket				I			I
Brake Pad Wear				I			I
Brake System				I			I
Clutch System				I			I
Side Stand				I			I
Suspension				I			I
Spark Arrestor	**			C			C
Nuts, Bolts, Fasteners	**			I			I
Wheels & Tires	*			I			I
Sprocket Head Bearings	*			I			I

Basic Maintenance Procedures

Throttle Freeplay

Throttle Freeplay - 1/16 - 1/4 inch (2 - 6mm)

1. Loosen the lock nut on the throttle cable mechanism.
2. Turn the adjuster nut in the direction needed to obtain the proper throttle freeplay.
3. Tighten the lock nut.
4. After adjustment, check the throttle for smooth rotation from fully closed to fully open in all steering positions.

If you cannot obtain proper freeplay, contact your Apollo dealer or Apollo Motors directly for assistance.

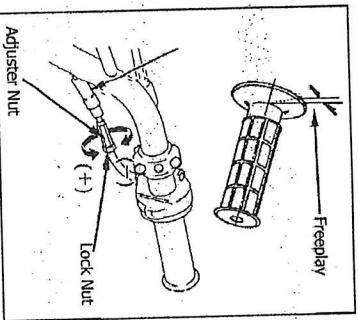

Engine Idle Speed Adjustment

The engine must be at normal operating temperature in order to have an accurate idle speed adjustment. Ten minutes of normal riding is sufficient to warm up the engine. Never attempt to compensate for faults in other systems by adjusting the idle speed. If you are having trouble, please contact your Apollo dealer or Apollo Motors Directly.

Idle Speed - 1,400 rpm plus or minus 100 rpm.

1. Warm up the engine, shift into neutral and place the motorcycle on its side stand.
2. Connect a tachometer to the engine using the procedure outlined by the tachometer manufacturer. If you do not have a suitable tachometer, small digital units can be purchased at most local auto part stores.
3. Adjust the idle by turning the idle speed adjustment screw in the desired direction. The idle adjustment screw is located on the left side of the carburetor.

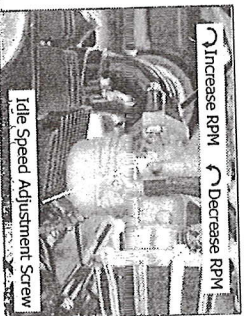

Spark Plug Maintenance

Standard	Torch A7TC or NGK C7HSA
For Cold Climate	Torch A6TC or NGK C6HSA
For Extended High Speed Riding	Torch A8TC or NGK C8HSA

The recommended standard spark plug will work well in most riding conditions. However, if you plan on riding for extended periods of time at high speed or high engine rpm in hot climates, or plan extended riding in cold climates, a different plug may be recommended.

Basic Maintenance Procedures

Fuel

Fuel Recommendation - Any unleaded gasoline with a pump octane rating of 92 or higher.

The engine in your motorcycle has been designed to run on any gasoline with a pump octane rating of 86 or higher. Most service stations will display the octane rating above each pump. Although it is not required, Apollo Motors recommends use of gasoline with a 92 octane rating or higher to ensure maximum performance and reliability.

Use of a lower octane gasoline can cause pre-detonation in the engine. When this occurs, you will hear a persistent "pinging" or "spark knock" which, if severe, can cause engine damage. It is however no cause for concern if you hear light pinging while the engine is under hard acceleration, such as climbing up a hill. If pinging occurs under normal load and a steady engine speed, switch brands of gasoline and be sure you are using the proper octane rating. Use of unleaded fuel is recommended because it produces fewer engine deposits and extends the life of the engine and exhaust components.

Never use stale or contaminated gasoline. Never use gasoline that has been mixed with oil. Avoid getting dust, dirt and water into the fuel tank.

Refueling Procedure

1. Twist the fuel tank cap counter-clockwise and remove the cap from the tank.
2. Using a funnel, add fuel to the tank until the level reaches about 2 inches from the top of the tank.
3. Twist the fuel cap clockwise until it is securely tight.
4. Be sure that you have the breather tube connected to the gas tank cap.

WARNING Gasoline is highly flammable and explosive. You can be burned or seriously injured when handling gasoline. Always stop the engine. Only handle gasoline outdoors. Clean all spills immediately.

Engine Oil Recommendation

Engine Oil Recommendation - SAE 10W-40 Motor Oil. *

* Indicates Oil for regular air temperatures. Please see the oil / air temperature chart to help you choose the best oil for your climate.

CAUTION Your motorcycle does not need oil additives. Only use the recommended oil. Do not use oils with graphite or molybdenum additives, they may adversely affect the clutch operation. Do not use motor oils that display the API circular logo that is labeled "energy conserving," they may affect the lubrication and clutch performance.

Basic Maintenance Procedures

Engine Oil Recommendation (Cont.)

Other viscosities shown in the chart below can be used when the average temperature in your riding area are within the indicated range.

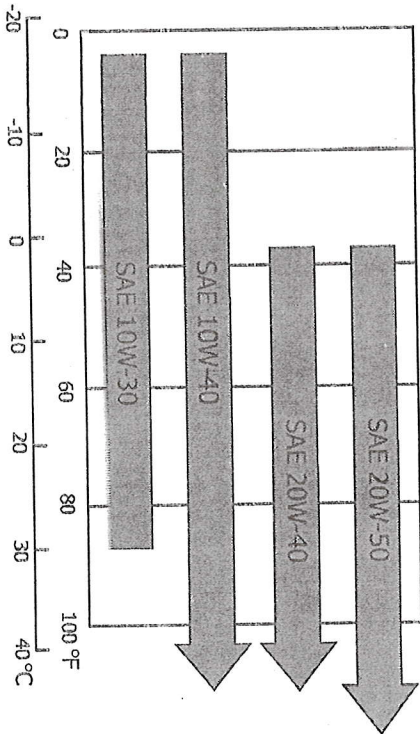

Checking and Adding Oil

1. Park the motorcycle on a firm level surface.
2. Clean around the oil fill cap and any nearby surfaces.
3. Unscrew the oil fill cap and wipe it clean.
4. Hold the motorcycle upright so that it is not resting on the sidestand.
5. Insert the oil fill cap back into the engine until it seats, but do not screw it in.
6. Remove the oil fill cap and check the oil level. If the oil level is at or near the upper mark (1), you do need to add oil. If the oil level is below or near the lower level mark (2), add the recommended oil until it reaches the upper level mark (1). Do not overfill.
7. You can also check the oil level through the sightglass as shown in the photo to the right.
8. Insert the oil fill cap and screw it in tightly.
9. Start the engine and check for oil leaks.

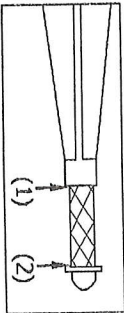
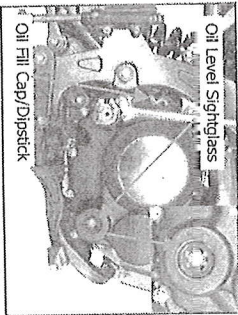

Maintaining Your Apollo Dirtbike 20

Basic Maintenance Procedures

Changing Engine Oil

1. Park the motorcycle on a firm level surface.
2. Remove the oil fill cap/dipstick.
3. Place an oil drain pan under the engine.
4. Unscrew and remove the oil drain bolt.
5. Once most of the oil has drained, move the motorcycle from side to side to drain out any remaining oil.
6. Examine the sealing washer for damage and replace if any damage is present.
7. Install the oil drain bolt and tighten to the specified torque of 18 foot pounds.
8. Pour the recommended oil into the engine and fill until the oil level is correct.
9. Install the oil filler cap/dipstick and tighten securely.
10. Start the engine and let it run for a minute or two.
11. Shut off the engine and check the engine oil level, add oil if needed. Do not overfill.
12. Check for any oil leaks.
13. Dispose of waste oil in an approved manner.

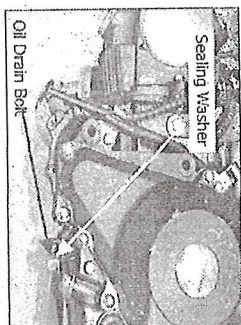

NOTICE
Always dispose of waste oil in the proper manner. Failure to do so is harmful to the environment and illegal in most states.

Air & Fuel Filter

Proper air filter maintenance is extremely important for off-road vehicles. Dirty, water-soaked, worn out, or defective air filters will allow dirt, dust, mud and other impurities to pass into the engine. If you are riding in wet and muddy areas, you should service the air filter more often. Always replace the air filter with a filter of the same size and construction. Failure to do so can cause the engine to run in a lean or rich condition, which if severe, can cause damage to the engine and/or spark plug.

1. Unscrew the filter clamp screw using a flat screwdriver.
2. Remove the air filter.
3. Clean the filter element (foam) with a non-flammable solvent such as kerosene, not gasoline. After cleaning, try to squeeze out any remaining solvent. Be careful that you do not tear the air filter element.
4. Inspect the foam for tears or cracks and replace if needed.
5. Allow the air filter to dry before applying any air filter oil. A wet air filter will not absorb the air filter oil.
6. Apply a quality air filter oil to the filter element.
7. Install the air filter and tighten the filter clamp screw Securely.
8. Replace the fuel filter every 12 months or when it is dogged. See your Apollo dealer for replacements.

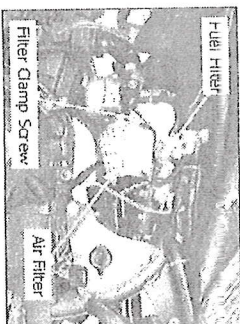

Component Locations

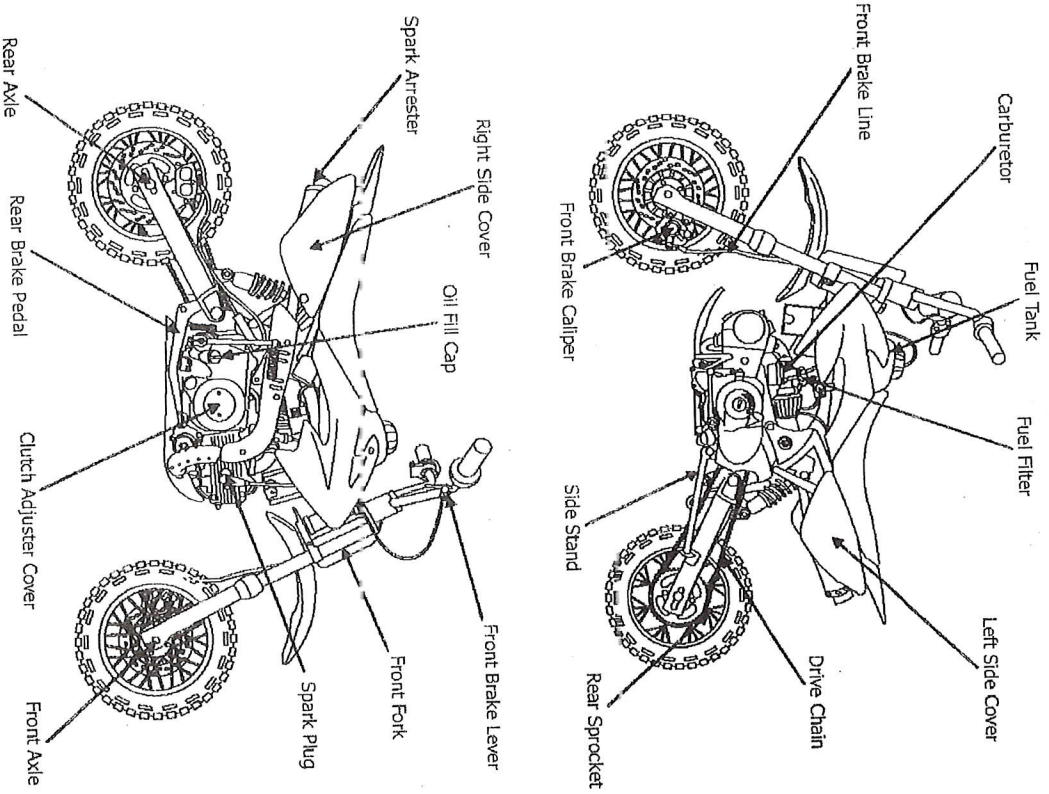

Basic Maintenance Procedures

Spark Plug Maintenance (cont.)

A fouled (dirty) spark plug can cause your motorcycle to run poorly and lose performance. Follow the steps below to inspect, clean and/or replace the spark plug if needed.

1. Clean any dust and dirt from around the spark plug base.
2. Disconnect the spark plug cap.
3. Remove the spark plug using a 5/8 in socket or wrench.
4. Using the photos below for reference, examine the plug to determine its cleanliness. If the plug is a normal color, go on to step 6. If the plug is fouled (dirty), go to step 5.
5. Using a moderate grit sandpaper (Z20-400), sand between the center electrode and the side electrode until all carbon and oil deposits are removed. Apollo Motors recommends that you use a spark plug cleaner or a new spark plug if the plug is very dirty.
6. Inspect the spark plug electrodes for wear. The center electrode should have square edges. The side electrode should not be eroded at all. The insulator should not be cracked or chipped. Replace the plug if any electrode wear and/or cracks are present.
7. Check the spark plug gap using a spark plug gapper. Gappers can be purchased at your local auto parts store. The spark plug gap should be .02 - .03 in (0.6 - 0.7mm). Always check the gap of a new spark plug before you install it. Be sure all dirt has been cleaned from the threads. Install the spark plug by hand. This will prevent stripping and/or cross threading of the threads. Use a 5/8 in socket or wrench to securely tighten the spark plug. Do not over or under tighten the spark plug.

Notice: Improperly tightened spark plugs can damage the engine. Too loose, you can burn a hole in the piston. Too tight, you can damage the threads of the engine.

Normal Spark Plug (light brown center)	Lean Spark Plug (White center)	Fouled Spark Plug (Heavy carbon buildup)	Fouled Spark Plug (Heavy oil buildup)

When you inspect the spark plug, generally it will fit into one of the four categories shown above. A normal/clean spark plug will have a light brown center and displays no wear around the electrodes. A spark plug with a bright white center indicates a lean condition in the engine. If your plug looks like this, have your motorcycle serviced by your Apollo dealer immediately. A carbon fouled plug will be completely black with no gloss. An oil fouled plug will appear a dark shiny brown or shiny black as shown above. An oil fouled plug is caused when the engine oil seeps by the piston ring and is burned with the fuel. Oil fouled plugs are not uncommon, however, if your motorcycle is consistently oil fouling spark plugs, have it serviced by your local Apollo dealer immediately.

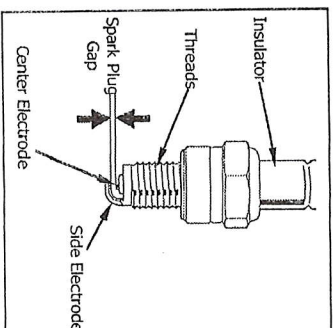

Maintaining Your Apollo Dirtbike

Keeping your motorcycle in perfect operating condition is absolutely essential to your safety. It is also the best way to protect your investment, get maximum performance, avoid breakdowns, and have more fun. To help keep your motorcycle well maintained, this section includes a maintenance schedule for required servicing and step-by-step instructions on how to perform specific maintenance tasks. In this section you will also find important safety precautions, information on oils, and tips for keeping your Apollo looking good.

Careful pre-ride inspections and good maintenance are invaluable because your motorcycle is designed to be ridden over rough, off-road terrain. To help you properly care for your motorcycle, this section provides you with a maintenance schedule. The service intervals in this section are based on average riding conditions. More frequent service is needed if you subject your motorcycle to severe use, such as competition, or ride in unusually wet and dusty areas. Frequent checks of the air cleaner are very important to help you avoid engine damage.

WARNING Improperly maintaining this motorcycle or failing to correct a problem before you ride can cause a crash in which you can be seriously hurt or killed. Always follow the inspection and maintenance recommendations and schedules in this manual.

Remember, proper maintenance is the responsibility of the owner. Be sure to inspect your motorcycle before each ride and follow the maintenance schedule in this section.

Note to Parents: As a parent, it is up to you to make sure the motorcycle is properly maintained and kept in safe operating condition. For youngsters, learning how to take care of a motorcycle and perform basic maintenance can be an important part of their riding experience. However, if you allow a youngster to perform or assist in any maintenance task, such as filling the tank with gasoline, you need to provide close supervision and make sure the task is performed safely.

WARNING Failure to properly follow maintenance instructions and precautions can cause you to be seriously hurt or killed. Always follow the procedures and precautions in this manual.

Important Safety Precautions

Make sure the engine is off before you begin any maintenance or repairs. This will help eliminate the following hazards:

1. **Carbon monoxide poisoning from engine exhaust** - Be sure you have adequate ventilation whenever you operate the engine.
2. **Burns from hot motorcycle parts** - Let the engine and exhaust system cool off before you touch them.
3. **Injury from moving parts** - Do not run the engine unless instructed to do so.

Read all instructions before you begin a procedure. Make sure you have all of the tools and skills required. To help prevent the motorcycle from falling over, park it on a firm, level surface, using the side stand or a maintenance stand to provide support. To reduce the chance of a fire or explosion, be careful when working around gasoline. Use only a non-flammable (high flash point) solvent such as kerosene to clean parts. Keep cigarettes, sparks, and flames away from all fuel related parts.

Basic Maintenance Procedures

Brake Fluid

Your motorcycle is equipped with hydraulic disc brakes on both the front and rear wheels. Hydraulic brakes require brake fluid for its operation. Both front and rear brakes have a brake fluid reservoir built into the master cylinders. Follow the procedures below to check and fill the brakes with the specified brake fluid.

Recommended Brake Fluid - DOT3 or DOT4

Front brake fluid check and fill procedure:

1. Clean all dirt and dust from the master cylinder cap.
2. Remove the master cylinder cap screws with a Phillips head screwdriver.
3. Remove the master cylinder cap. Be careful not to damage the gasket that is seated under the cap.
4. Add the specified fluid into the master cylinder.
5. Replace the cap and tighten the screws securely.
6. Squeeze the brake lever to be sure the brakes are working properly.
7. Check the brake hose and caliper for leaks.

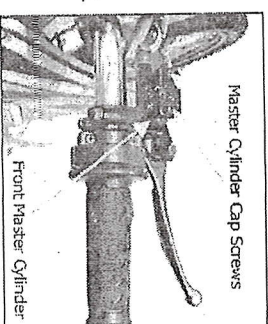

Rear brake fluid check and fill procedure: *

1. Clean all dust and dirt from the master cylinder and site glass.
2. Check the site glass. If the master cylinder needs to be refilled, an air bubble will appear in the site glass or no fluid at all will be present inside the site glass.
3. Remove the master cylinder cap bolts using a hex key/Allen wrench.
4. Remove the master cylinder cap. Be careful not to damage the gasket seated under the cap.
5. Add the specified fluid into the master cylinder if needed.
6. Replace the master cylinder cap and tighten the bolts securely.
7. Depress the rear brake pedal to be sure the brake is working properly.
8. Check the brake hose and caliper for leaks.

* Model ADR-110 Requires exhaust pipe removal for access.

If you are unsure how to re-assemble a part, see your Apollo dealer for servicing information and/or servicing.

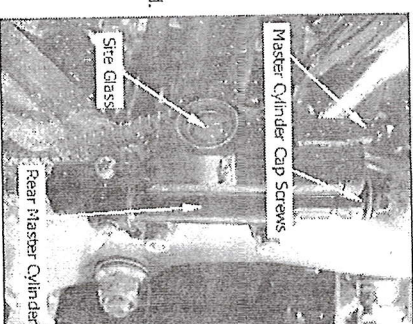

Shifting Gears

This motorcycle has four forward gears.

To start riding, after the engine has been warmed and the sidestand raised:

1. Close the throttle and squeeze the clutch lever all the way in.
2. Depress the shift lever from neutral down to first gear. Once the transmission clicks into gear, the shift lever will return to the "N" position once you remove your foot.
3. Slowly and gradually open the throttle and release the clutch lever in a simultaneous motion. When you feel the clutch begin to grab and the motorcycle starts to ease forward, you have reached the "friction zone" of the clutch. Gradually open the throttle more and release the clutch lever completely as the motorcycle moves forward.
4. When you attain moderate speed, close the throttle and squeeze the clutch lever at the same time. Raise the shift lever until it clicks into second gear. After shifting, re-open the throttle and release the clutch lever.
5. To continue shifting up to each higher gear, repeat step 4.
6. To shift down to a lower gear, close the throttle and pull the clutch. Depress the shift lever until you feel it click into gear. After shifting, re-apply the throttle and release the clutch lever smoothly.

Remember to close the throttle before shifting gears.

Notice: Improper shifting may damage the engine, transmission, and drive train.

Learning when to shift gears will come with riding experience. Up-shift into a higher gear when you hear the engine speed (rpm) get too high. When engine rpm gets too high in a gear, you will feel the motorcycle stop accelerating. This is another way to know when to up-shift.

Downshift to a lower gear when you feel the engine lugging at a low rpm. Downshifting is usually done when you slow down for a turn or when you stop the motorcycle. Downshifting into a lower gear can help slow down your motorcycle, especially when going down a hill. However, downshifting when the engine rpm is too high can cause engine damage.

The neutral position of the transmission is located between the first and second gear position. To shift into neutral, pull the clutch lever in and depress the shift lever as many times as needed to get into first gear. Once you are in first gear, pull up on the shift lever $\frac{1}{2}$ the distance required to up-shift into second gear. You can also shift into neutral from second gear by depressing the shift lever $\frac{1}{2}$ the distance required to downshift into first gear.

To prevent transmission damage, do not coast or tow the motorcycle for long distances with engine off.

WARNING Never attempt to start the engine in gear. Doing so may cause a crash that could result in serious injury or death.

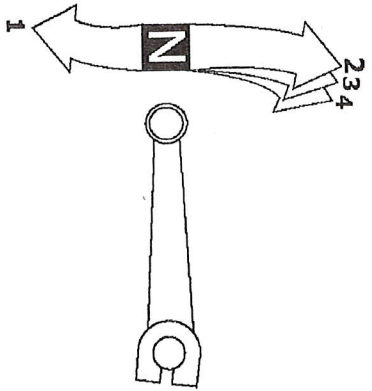

Basic Maintenance Procedures

Front Suspension Inspection

1. Check the fork operation. Pull in the front brake lever to lock the front wheel. Next, pump up and down on the forks several times. The suspension should feel clean and smooth.
2. Check the lower end of the forks (near the wheel) for oil leakage.
3. Inspect the upper and lower triple clamps for tightness. Be sure all of the triple clamp bolts are tight. Examine the metal for any cracks, wear, or other damage.
4. Be sure there is no freeplay in the steering head.

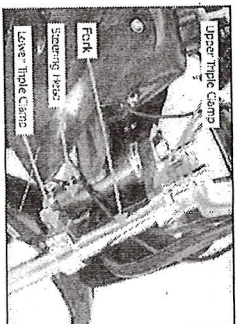

Rear Suspension Inspection

1. Sit on the motorcycle and hold the handle bars firmly. Push the motorcycle firmly from side to side. Feel for any freeplay in the swingarm bushing and bearings.
2. Check all of the shock absorber bolts and swingarm bolts for tightness.
3. Pump up and down on the rear suspension. The suspension should feel clean and smooth.
4. Examine the coil spring for cracks or other damage.
5. Check the spring adjuster ring for tightness.
6. Check the shock absorber for any oil leaks.



Rear Suspension Adjustment

The rear suspension of your motorcycle comes from the factory set in the softest setting. If you wish to make the rear suspension harder, follow the procedure below. You will need a spring adjustment wrench.

1. Place the motorcycle on a maintenance stand.
2. Turn the spring adjuster ring counter-clockwise to make the rear suspension harder. Turn the ring clockwise to make the suspension softer. Notches in the spring allow for 5 positions of adjustments.
3. Place the motorcycle on a level surface and pump the rear suspension to be sure it is working smoothly.

Basic Operation & Riding

This section of the manual gives basic information on how to begin riding your motorcycle. In this section we will cover how to start and stop the engine, how to use the throttle and brakes, how to use the clutch and shift gears, and things you need to do when you are finished riding.

To protect your new engine and enjoy optimum performance and service life, be sure you break-in your motorcycle properly. To do this, avoid full throttle starts and rapid acceleration for the first 15 miles (25 km) of riding. For information about carburetor adjustment for riding in high altitudes, refer to the Servicing section of this manual.

Safe Riding Precautions

Before riding this motorcycle, be sure you have read this entire manual up to this point including the section titled Important Safety Information & Before Riding.

Even if you have ridden other motorcycles in the past, take time to get familiar with the way the motorcycle works and handles. Always practice in a safe area until you have built your skill level to point at which it is safe to ride.

CAUTION For your safety, avoid starting or operating the motorcycle in an enclosed area with poor ventilation, such as a garage. The motorcycle's exhaust gas contains poisonous carbon monoxide which can collect rapidly in an enclosed area and result in illness or death.

WARNING Your motorcycle is not equipped with lights. Do not ride at night.

Starting & Stopping the Engine

Always follow the proper starting procedure as described below.

Preparation

Check the engine stop switch and switch to "RUN" if needed. Make sure the transmission is in neutral. Turn the fuel valve to the "ON" position.

Starting Procedure

To restart a warm engine, follow the procedure for high air temperature.

Choke Lever

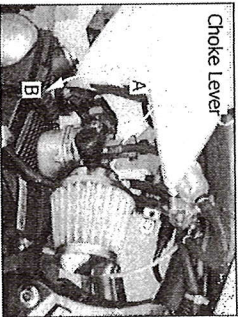

Normal Air Temperature 50° - 95° F (10° - 35° C)

1. Pull the choke lever up all the way up to position A (fully on).

2. With the throttle slightly open, operate the kickstarter. Kick from the top of the stroke through the bottom with a rapid, continuous motion.

Notice: Allowing the kickstarter to snap back freely against the pedal stop can damage the engine case.

Basic Maintenance Procedures

Tire Inspection

A flat tire or tire blowout can be very inconvenient and can even cause you to have an accident. Take the time to inspect your tires and wheels before you ride. For more information about handling a flat tire, refer to the section of this manual titled Taking Care of the Unexpected.

- Inspect the tire carefully for bumps or bulges in the sidewall of the tire and inside of the treads. Replace any tires that have bumps or bulges in them.
- Look closely for cuts, slits or cracks in the tires. Replace any tire if you can see a fabric or cord showing through.
- Check for rocks or other objects embedded in the tires or tread. Remove any foreign objects. Be sure there are no screws or nails in the tires.
- Measure the tread depth of the tires. Replace all tires before the tread depth gets below 0.12 in (3mm) or anytime you notice a reduction in your traction.
- Check the position of both valve stems. A tilted valve stem indicates that the tube is slipping inside of the tire or the tire is slipping on the rim. See your Orion dealer for assistance.

Tube & Tire Replacement

If a tube has been punctured or damaged, it should be replaced immediately. You may repair the tube using a tube patch kit, however, a repaired tube may not have the same reliability as a new one and could fail while riding. For more information on a temporary repair, see the section titled Resolving the Unexpected.

Always use replacement tubes that are the same size as the original. We recommend that you have tubes changed at your local Apollo dealer or your local motorcycle shop. Replacing a tube requires removal and installation of the wheel. Anytime you have a tube replaced, perform the tire inspection listed at the top of this page. The tires that came on your motorcycle were designed to provide a good combination of handling, braking, durability and comfort across a broad range of riding conditions.

WARNING Installing improper tires on your motorcycle can affect handling and stability, which, if severe, can cause a crash in which you can be seriously hurt or killed. Always use the size and type of tires recommended in this owner's manual.

Front Tire	2.75 - 12
Rear Tire	3.00 - 10
Type	Bias-ply, tube type

- Use a replacement tire equivalent in size and type to the original tire.
- Replace the tube anytime you replace a tire. Old tubes are usually stretched and, if installed in a new tire, could fail.
- Have the wheel balanced after a new tire has been installed.
- We recommend that tires be replaced by your Apollo dealer or a local motorcycle shop.

Before Riding

Before you ride, you must be absolutely sure that you and your motorcycle are ready to ride. To help you get prepared, this section of the manual will discuss how to evaluate your riding readiness and how to perform our recommended pre-ride inspection of your motorcycle. If you are a parent, please be sure you have read the section Important Message to Parents on page 3.

Are you Ready to Ride?

Before you ride your motorcycle for the first time, we strongly recommend the following:

1. Completely read this manual.
2. Be sure you have read and understand all of the safety messages and labels.
3. You know how to operate all of the motorcycle's controls.

Before each ride, we also strongly recommend that you:

1. are in good physical and mental condition.
2. are free of alcohol and other drugs.
3. are wearing an approved motorcycle helmet with a tight chin strap, eye protection and other protective clothing.

Protective Gear & Apparel

For your safety, we strongly recommend that you always wear an approved helmet, eye protection, boots, gloves, long pants and a long sleeved jersey, shirt or jacket whenever you ride. Although complete protection is not possible, wearing the proper gear can reduce the chance of and severity of injuries when you ride.

WARNING Not wearing a helmet increases the chance of serious injury or death in a crash. Be sure you always wear your helmet and other protective apparel when you ride.

Helmets and Eye Protection - Your helmet is your most important piece of riding gear because it offers the best protection against head injuries. A good helmet will be approved by a testing organization independent of the helmet manufacturer and will have a chin strap that can be tightened securely. Open-face helmets offer some protection, but a full-face helmet offers the most protection. When purchasing a helmet, regardless of style, look for a DOT (Department Of Transportation) sticker (USA only). If the helmet has been tested by an independent organization such as the Snell Institute, you will usually find their logo on a tag inside the padding of the helmet.

Additional Riding Gear - In addition to your helmet and eye protection, we also recommend:

1. Sturdy off-road motorcycle boots to help protect your feet, ankles and lower legs.
2. Off-Road motorcycle gloves to protect your hands.
3. Riding pants with knee and hip pads, a riding jersey with elbow pads and a chest/shoulder protector.

Basic Maintenance Procedures

Drive Chain Inspection (cont.)

Use the diagram below to determine if the sprockets need to be replaced. Never use a new chain with a damaged or worn sprocket.

NOTICE

Use of a new chain on worn sprockets will cause rapid chain wear.

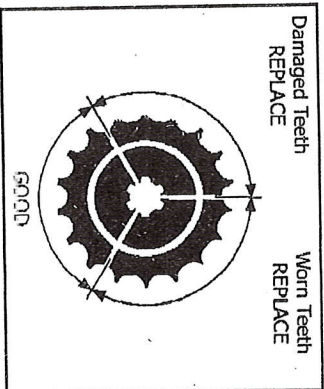

Drive Chain Slack Adjustment

Follow the procedure below to adjust the drive chain slack. Be sure that you are parked on a level surface and the engine is turned OFF:

1. Loosen the rear axle nut.
2. To decrease chain slack, turn both the left and right chain adjuster bolts clockwise equally. To increase chain slack, turn both the left and right chain adjuster bolts counter-clockwise equally. Be sure that the wheel is aligned properly with the chain.
3. Tighten the rear axle nut.
4. Recheck the drive chain slack.
5. Once you have obtained proper slack, torque the rear axle nut to 43 foot-pounds (59 Nm, 6.0 kgfm).

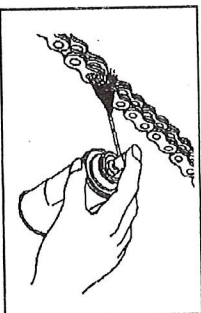
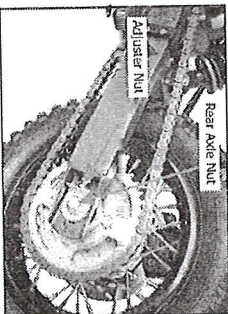

Operating Controls

Front Brake Lever

The front brake lever is used to apply the brake to the front wheel and will slow or stop the motorcycle. When you pull back on the lever, brake fluid is forced into the brake caliper causing the caliper to close on the brake disc. The amount of force that you use when pulling the front brake lever will determine how much braking power is applied. To release the front brake, release the front brake lever.

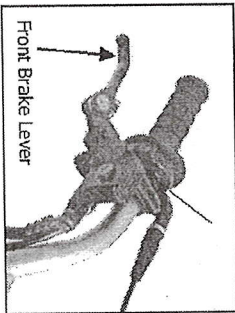

Throttle

The throttle controls the speed of the engine or RPM (revolutions per minute). To raise the rpm of the engine, twist the throttle grip toward you. To reduce the engine rpm, twist the throttle grip away from you. The throttle is spring loaded and will return to the closed position (engine idle) when you remove your hand.

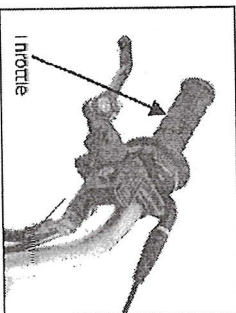

Shift Lever

The shift lever is used to select the next higher or lower gear in the transmission. To shift gears, raise the shift lever with your foot (after closing the throttle and pulling the clutch lever) to engage the next higher gear or depress the lever to engage the next lower gear. Please refer to the Basic Operation and Riding section of this manual for detailed instructions on shifting gears.

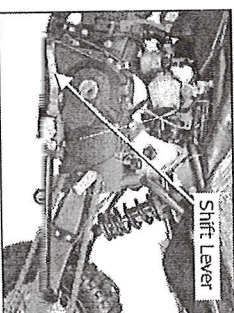

Rear Brake Pedal

The rear brake pedal is used to apply the brake to the rear wheel and will slow or stop the motorcycle. When you push down on the pedal, brake fluid is forced into the brake caliper causing the caliper to close on the brake disc. The amount of force that you use when pushing the rear brake pedal will determine how much braking power is applied. To release the rear brake, release the rear brake pedal.

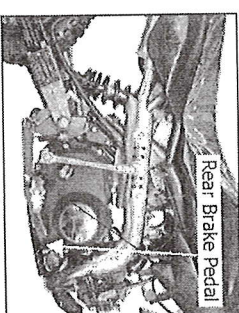

Basic Maintenance Procedures

Drive Chain Removal, Cleaning & Replacement

If you have been riding in extremely muddy or dusty conditions, the drive chain should be removed and cleaned before you apply lubricant. Follow the procedure below to remove and clean or replace the drive chain with a new one.

1. Remove the master link retaining clip (1) with needle nose pliers. Do not bend or twist the clip. Remove the master link and remove the drive chain.
2. Clean the drive chain with a non-flammable solvent such as kerosene - not gasoline - and allow it to dry.
3. Inspect the drive chain for possible wear or damage. Replace the drive chain if it has any damaged rollers, loose fitting links, or otherwise appear unserviceable.
4. Inspect the sprockets for wear or damage. Apollo Motors recommends that you replace the sprockets when you install a new drive chain.
5. Pass the chain over the sprockets and join the ends of the chain with the master link. For ease of assembly, hold the chain ends against adjacent rear sprocket teeth while inserting the master link. Install the master link retaining clip so that the closed end of the retaining clip will face the direction of forward wheel rotation.
6. Lubricate the chain.

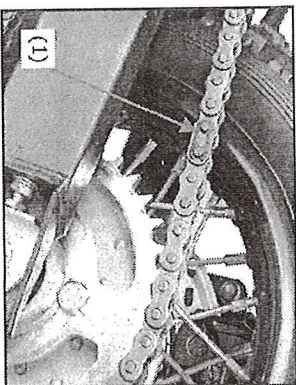

The master link is the most critical element of drive chain security. Master links are reusable, as long as they are in excellent condition. We recommend installing a new master link when you install a new drive chain. You may find it easier to install a new chain by connecting it to the old chain, using a master link and pinning the old chain to position the new chain on the sprockets.

Appearance Care

To clean the motorcycle you can use any of the following: water, mild neutral detergents, mild spray and wipe cleaner, mild spray and rinse cleaner/degreaser. Avoid products that contain harsh detergents or chemical solvents that can damage the metal, paint and plastic on your motorcycle.

We recommend that you use a garden hose to wash your motorcycle. High pressure washers (like coin operated car washes) can damage certain parts of the motorcycle. If you must use a high pressure washer, avoid spraying the following areas: Wheel hubs, muffler outlet, underneath the seat, engine stop switch, underneath the gas tank, drive chain and carburetor.

NOTICE

High pressure water or air can damage certain parts of the motorcycle. Never wash the motorcycle while the engine is running. Always lubricate the drive chain after you are finished washing and the motorcycle is dry.

Component Locations

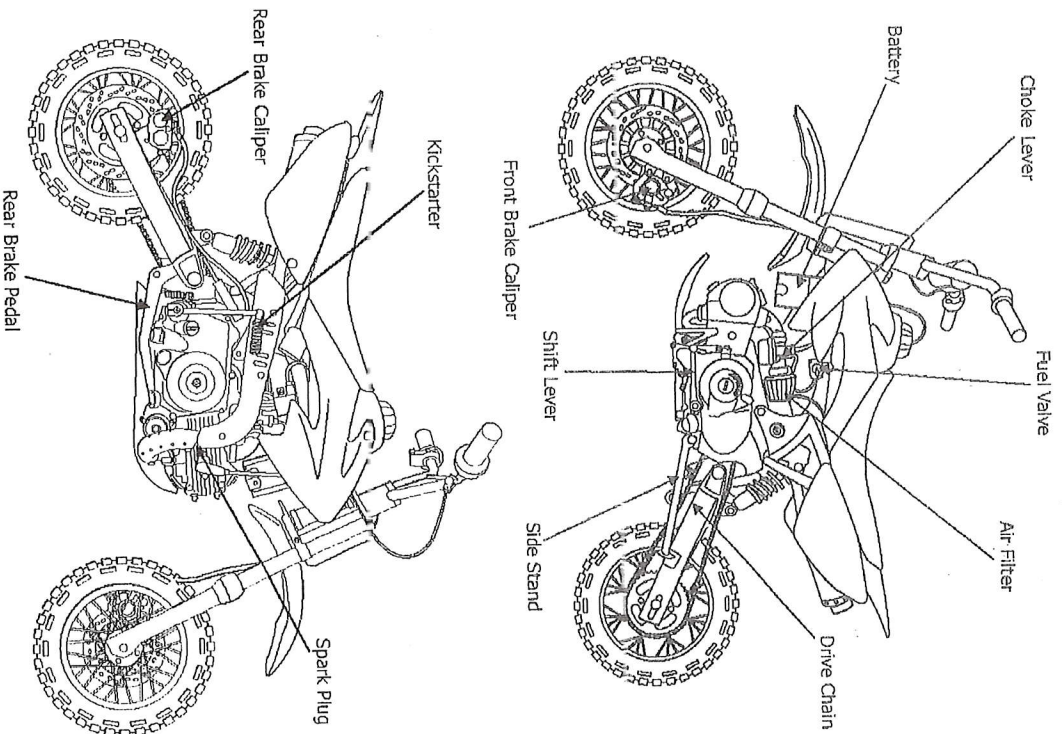

Troubleshooting

Engine Lacks Power (cont.)

- 8. Carburetor Inspection** - Disassemble the carburetor and check for clogs Was the carburetor clogged and dirty?
No - SEE STEP 9
Yes - Carburetor is not serviced frequently enough
 - Contaminated fuel
- 9. Over-Heating Inspection** - Check the engine for overheating Is the engine overheating?
No - GO TO STEP 10
Yes - Excessive carbon buildup in the combustion chamber
 - Use of poor quality fuel
 - Clutch slipping
 - Lean fuel mixture or improper octane rating of fuel
- 10. Engine Condition Inspection** - Accelerate rapidly through all gears and ride at high speed. Does the engine knock?
No - SEE STEP 11
Yes - Worn piston and cylinder (replace engine)
 - Wrong type of fuel (octane rating)
 - Lean fuel mixture
 - Excessive carbon buildup in the combustion chamber
- 11. Ignition Timing Inspection** - See your local Apollo dealer or motorcycle repair shop to have the ignition timing and engine lubrication system inspected. Only attempt these procedures if you are qualified and have the proper tools needed. Is the ignition timing normal?
No - Faulty CDI ignition box
 - Faulty ignition pulse generator
Yes - SEE STEP 12
- 12. Lubrication Inspection** - Remove the valve adjuster hole cap on the cylinder head and inspect for lubrication. Is the valve train lubricated properly?
No - Check oil passage (replace engine)
Yes - Dirty and/or contaminated engine oil
 - See your Apollo dealer to have your motorcycle serviced.

Poor Performance at Idle & Low Speed

- 1. Intake Manifold Inspection** - Check the intake manifold for leaks Is there a leak in the manifold?
No - SEE STEP 2
Yes - Loose carburetor mounting bolts
 - Loose carburetor spacer
 - Damaged insulator/gasket
 - Damaged intake manifold gasket
 - Cracked or broken intake manifold/pipe

Safety Label Information

This page will show you where to find the safety labels on your motorcycle. You will find that some labels warn you of potential hazards. Others will provide important safety and maintenance information. Please read them carefully and do not remove them. If your label wears off from riding or becomes hard to read, contact Apollo Motors for a replacement.

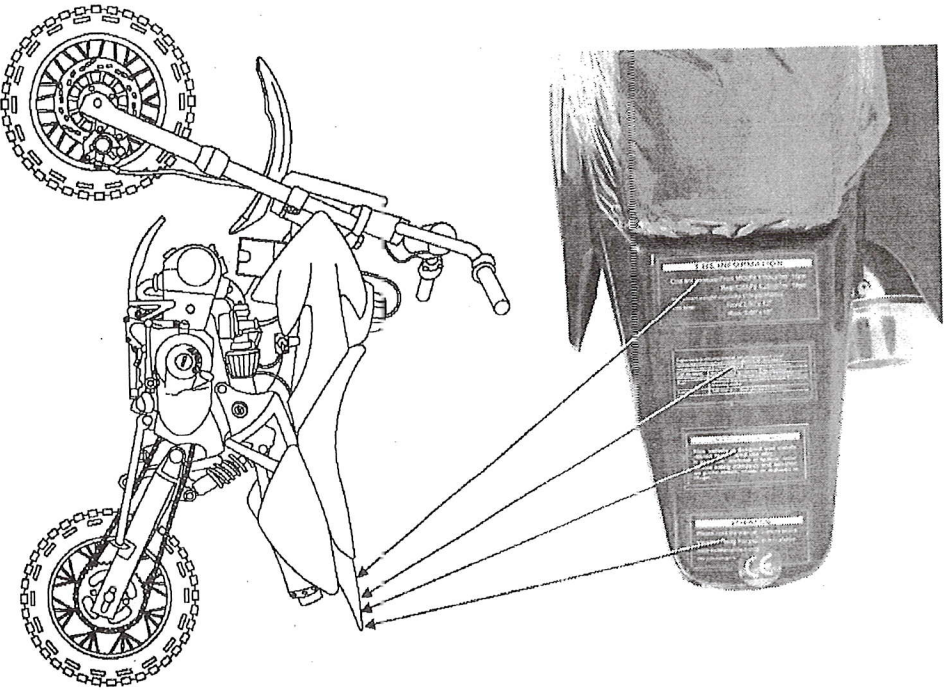

Troubleshooting

Poor Performance at Idle & Low Speed (cont.)

2. Spark Test - Test for ignition spark by removing the spark plug and inserting it into the spark plug cap. Place the open end of the spark plug on a metal part of the engine and kickstart the engine. You should see a nice blue spark on the end of the spark plug. A faint spark will not start the engine.

⚠ DANGER Do not touch the spark plug or plug cap while kickstarting the engine. You will receive an electrical shock which could result in serious injury or death.

Is there a good spark?

No

- Fouled or faulty spark plug
- Broken or shorted spark plug wire or spark plug cap
- Broken or shorted ignition coil
- Faulty ignition CDI Box
- Faulty or shorted magneto assembly
- Broken or shorted engine stop switch
- Loose or corroded wires and/or connectors (always clean bad electrical connections)

Yes

- SEE STEP 3

3. Carburetor Air Screw Inspection - Check the carburetor air screw. Turn the screw clockwise until you feel it stop. Do not tighten. Back out the screw counter clockwise 1.5 turns.

Is the air screw setting correct?

No

- Adjust using the procedure above.

Yes

- SEE STEP 4

4. Ignition Timing Inspection - See your local Apollo dealer or motorcycle repair shop to have the ignition timing inspected. Only attempt these procedures if you are qualified and have the proper tools needed.

Is the ignition timing normal?

No

- Faulty CDI ignition box
- Faulty ignition pulse generator

Yes

- See your Orion dealer to have your motorcycle serviced

Poor Performance at High Speed

1. Examine the Fuel Line - Disconnect the fuel hose at the carburetor.

Is there fuel flowing freely?

NU

- Clogged fuel filter/line w/ Clogged Fuel Filter
- Clogged Fuel Valve
- Clogged fuel tank breather hose

Yes

- SEE STEP 2

2. Carburetor Inspection - Disassemble the carburetor and check for doggs. Was the carburetor clogged and dirty?

No

- SEE STEP 3

Yes

- Carburetor is not serviced frequently enough, contaminated fuel

3. Ignition Timing & Valve train Inspection - See your local Apollo dealer or motorcycle repair shop to have the ignition timing inspected. Only attempt these procedures if you are qualified and have the proper tools needed. Are the ignition timing, valve timing and valve springs normal?

No

- Faulty CDI ignition box
- Faulty ignition pulse generator
- Broken valve spring
- Broken or damaged camshaft sprocket

Yes

- See your Apollo dealer to have your motorcycle serviced

Important Safety Information

A motorcycle can provide many years of service and pleasure, provided you take responsibility for safety, properly maintain your motorcycle and understand the challenges you may encounter while riding.

This motorcycle has been designed for younger riders. However, not all youngsters meet the physical and emotional levels that are needed for riding. Before parents allow any children to ride this motorcycle, we strongly recommend that they read this entire manual so that they are fully informed before deciding if their children are ready to ride. Listed below are some of the most important safety measures one should take when riding.

⚠ DANGER Never Ride Without a Helmet The following statement is a proven fact: "Helmets significantly reduce the number and severity of head injuries." Never ride your motorcycle without a helmet. Even a crash at slow speed can result in a fatal head injury if you are not wearing a helmet. Apollo Motors recommends wearing helmets that have been certified for safety by helmet testing organizations whom are independent from the helmet manufacturer. We also recommend that you wear eye protection, boots, gloves, and other protective gear such as off-road riding pants.

⚠ WARNING Never Carry a Passenger This motorcycle has been designed for ONE rider only. There are no passenger pegs, footrests, handles or seat room for a passenger. Riding with a passenger can interfere with your ability to operate and/or control the motorcycle and may result in serious injury or death.

⚠ WARNING Ride Off-Road Only This motorcycle has been designed and manufactured for off-road use only. The motorcycle is not equipped with lights, turn signals, horn and other features required to drive a motorcycle on public roads. The tires are not designed for pavement and will make the motorcycle unstable if it is ridden on pavement. If you have to cross a paved road, dismount and walk the motorcycle across the road.

⚠ WARNING Ride Within Your Limits Never attempt to ride your motorcycle in a manner that is beyond your skill level. It takes time to learn off-road riding skills. Learn to ride your motorcycle step by step. Start by practicing on safe terrain at slow speeds and gradually build your skill level. Instruction from an experienced rider(s) is highly recommended. Remember that alcohol, drug use, fatigue and ignorance can reduce your ability to make good decisions and ride safely.

⚠ WARNING Be Alert for Hazards The terrain in which you ride can present many hazards. Always "scan" the terrain ahead of you continually. Watch for un-expected turns, drop-offs, ditches, rocks and other hazards. Always maintain a speed slow enough to allow you enough time to see and react to hazards.

⚠ DANGER Do Not Drink and Ride Even one drink can impair your ability to ride a motorcycle safely. Each drink afterward will make the impairment worse. Do not drink and ride. Do not let your friends drink and ride. Remember, in most states throughout the United States, you can be arrested and charged with Driving Under the Influence (DUI) if you are riding a motorcycle while intoxicated. This applies to off-road motorcycles as well.

Resolving the Unexpected

General Guidelines

If you encounter trouble during a ride, the first thing you should do is stop as soon as it is safely possible. Do not continue to ride if you have a flat tire, if you hear an unusual noise, or if your motorcycle just does not feel right. If you continue to ride, you will cause more damage to the motorcycle and endanger your own safety.

After you stop, take time to carefully look over your motorcycle and identify the problem. Always consider all of your options before you make a decision. Sometimes a problem can be relatively minor and can be permanently repaired on the trail provided you have the tools, supplies and skills needed to do so. In addition, you may be able to make a temporary repair and ride slowly back to your base where you can get further help and/or supplies.

When a problem appears to be more serious, or you do not have the tools, supplies and skills needed to make a repair, you will need to choose a safe way to get yourself and the motorcycle back to your base. If you are close enough, you can often push the motorcycle back.

Whatever the problem may be, always follow the instructions below:

1. Always put safety first.
2. If the problem is minor and you have the tools, supplies and skills needed to make a temporary repair, be sure to make permanent repairs as soon as possible.
3. Do not continue riding if you are hurt or if your motorcycle is not in safe riding condition.

Recommendations for specific problems follow.

If Your Engine Quits or Will Not Start

If the engine was not making unusual noises before it quit running, and it feels normal when you operate the kickstarter, you can probably rule out a major mechanical problem.

First, check the fuel system:

1. Make sure you have fuel in the gas tank and the fuel valve is set to the "ON" position.
 2. Check the fuel tank cap breather hose to be sure it is not pinched or clogged.
 3. Turn the fuel valve to the "OFF" position. Disconnect the fuel line from the carburetor and momentarily turn the fuel valve to "ON". If fuel does not flow out, there is an obstruction in the fuel tank, fuel filter, or in the fuel line.
- If the fuel system appears to be okay, check the ignition system.
1. Check the spark plug cap. Be sure that it is not loose or disconnected.
 2. Disconnect the spark plug cap and remove the spark plug. Connect the spark plug to the plug cap and place the threaded end of the spark plug on a metal part of the engine.
 3. Kick the kickstarter while you watch the spark plug. If it sparks, the ignition system is probably working. If there is no spark, replace the spark plug with a new one. If there is still no spark, there is a problem with the ignition system.

If you cannot identify or correct a problem, you will have to push your motorcycle back to your base or get some help.

Introduction

Congratulations on choosing your Apollo off-road motorcycle.

Your Apollo Dirtbike was designed as a recreational motorcycle for off-road use only by a single rider only. This motorcycle is ideal for younger riders with basic experience.

Before riding, take plenty of time to get acquainted with your motorcycle and how it works. To protect your investment, we urge you to keep your motorcycle well maintained. In addition to regular maintenance, it is just as important to observe and perform all pre-ride and periodic checks detailed in this manual. We also recommend that you read this manual before you begin riding. In this manual you will find safety information, facts, instructions, helpful tips and illustrations. To make it easy to use, the manual contains a table of contents and an index at the end of the manual.

As you read through this manual, you will find information that is preceded by a **NOTICE** symbol. This information is intended to help you avoid damage to your motorcycle and/or property around you. This manual covers basic maintenance procedures. A detailed parts diagram manual and service manual is available for models (ADR-110) and it can be purchased separately from Apollo Motors. The parts manual will be helpful to those with the mechanical skills and tools required to service their own motorcycle.

Read the warranty page carefully so that you understand the coverage on your dirtbike and are aware of your rights and responsibilities.

Whenever you ride, tread lightly. By staying on established trails and riding in approved areas, you will help protect the environment and keep off-road riding areas open for future use.

If you have any questions or you need any special service or repair, remember that your Apollo dealer knows your motorcycle best and will be dedicated to your complete satisfaction. Replacement parts and technical support can be obtained through your Apollo dealer. Please be sure to register your motorcycle with Apollo Motors and report any address changes so that we may contact you in the future concerning important product information.

You can also visit our website at www.apollovehicle.com

Introduction

Electrical Circuit Chart

