

READ THIS MANUAL CAREFULLY
BEFORE YOU USE THIS VEHICLE!
It contains important safety information.

OWNER'S MANUAL

PLEASE CHECK YOUR LOCAL RIDING LAWS AND REGULATIONS BEFORE OPERATING THIS VEHICLE. **ATA125-D**
This ATV should not be ridden by anyone under 14 years of age.

INTRODUCTION

Congratulations on your purchase of the atv. This ATV represents the result of many years of the factory experience in the production of fine sporting, touring, and pacesetting racing machines. This manual will provide you with a good basic understanding of the features and operation of this ATV. This manual includes important safety information. It provides information about special techniques and skills necessary to ride the ATV. It also includes basic maintenance and inspection procedures. If you have any questions regarding the operation or maintenance of your ATV, please consult the sales dealer.

SAFETY INFORMATION

- ★ AN ATV IS NOT A TOY AND CAN BE HAZARDOUS TO OPERATE.
- ★ READ THIS MANUAL TOGETHER WITH TIPS FOR THE ATV RIDER CAREFULLY AND COMPLETELY BEFORE OPERATING YOUR ATV. MAKE SURE YOU UNDERSTAND ALL INSTRUCTIONS.
- ★ PAY CLOSE ATTENTION TO THE WARNING AND CAUTION LABELS ON THE ATV.
- ★ NEVER OPERATE AN ATV WITHOUT PROPER TRAINING OR INSTRUCTION.
- ★ THIS ATV, AND ANY OTHER ATV OVER 90 cc, SHOULD NOT BE OPERATED BY A CHILD UNDER 14 YEARS OF AGE. THESE CHILDREN MAY NOT BE ABLE TO OPERATE THIS VEHICLE SAFELY DUE TO PHYSICAL OR MENTAL LIMITATION.

- ☆ Always avoid operating an ATV on any paved surfaces, including sidewalks, driveways, parking lots and streets.
- ☆ This ATV is designed for operation by a single person without passengers.
- ☆ Never operate an ATV on any public street, road or highway, even a dirt or gravel one. This ATV is designed and manufactured for use only off public roads.
- ☆ Never operate an ATV without wearing an approved motorcycle helmet that fits properly. You should also wear eye protection (goggles or face shield), gloves, boots, a long-sleeved shirt or a jacket, and long pants.
- ☆ Never consume alcohol or drugs before or while operating this ATV.
- ☆ Never operate the ATV on hills too steep for the ATV or for your abilities. Practice on smaller hills before attempting larger hills.
- ☆ Never modify an ATV through improper installation or use of accessories.
- ☆ Never attempt wheelies, jumps, or other stunts.
- ☆ Always inspect your ATV each time you use it to make sure it is in safe operating condition. Always follow the inspection and maintenance procedures and schedules described in this manual.
- ☆ Always keep both hands on the handlebars and both feet on the footrests of the ATV during operation.
- ☆ Always follow proper procedures for turning as described in this manual. Practice turning at low speeds before attempting to turn faster speeds and never turn at excessive speeds.
- ☆ Never permit vehicle refueling by anyone other than an adult.
- ☆ Never permit anyone other than an adult to start the ATV.
- ☆ Drain gasoline from the fuel tank and carburetor prior to transporting the ATV.
- ☆ Caution the child and others near the vehicle not to get close to or touch any moving parts or any heated areas such as the engine and exhaust pipe.
- ☆ Do not allow the vehicle to be ridden at night, because this vehicle is not equipped with a headlight.

IMPORTANT

Please read this manual carefully. You should pay special attention to these items with "WARNING" and "CAUTION" words and must review the contents for the items.

**WARNING**

Failure to follow WARNING instructions could result in severe injury or death to the ATV operator, a bystander, or a person inspecting or repairing the ATV.

**CAUTION**

A CAUTION indicates special precautions that must be taken to avoid damage to the ATV.

⚠ WARNING

POTENTIAL HAZARD

Improper handling of gasoline.

WHAT CAN HAPPEN

Gasoline can catch fire and you could be burned.

HOW TO AVOID THE HAZARD

Always turn off the engine when refueling.

Do not refuel right after the engine has been running and is still very hot.

Do not spill gasoline on the engine or exhaust pipe/muffler when refueling.

Never refuel while smoking, or in the vicinity of sparks, open flames, or other sources of ignition such as the pilot lights of water heaters and clothes dryers.

When transporting the ATV in another vehicle, be sure it is kept upright and that the fuel cock is in the "OFF" position. Otherwise, fuel may leak out of the carburetor or fuel tank.

WHAT CAN HAPPEN

Gasoline is poisonous and can cause injuries.

HOW TO AVOID THE HAZARD

If you should swallow some gasoline or inhale a lot of gasoline vapor, or get some gasoline in your eyes, seek medical help immediately.

If gasoline spills on your skin, wash with soap and water. If gasoline spills on your clothing, change your clothes.



Contents

AN IMPORTANT NOTE TO PARENTS	1
LOCATION OF THE WARNING AND SPECIFICATION LABELS	2
DESCRIPTION	3
Serial number location.....	3
Location and function of parts.....	4
Left view.....	4
Right view.....	4
Front view.....	5
Ignition switch.....	5
Remote engine stop switch.....	5
Engine kill switch	6
Start button	6
Rear brake pedal	6
Front brake lever.....	7

Parking brake plate.....	7
Throttle lever	7
Throttle limiter screw	8
Fuel Petcock	9
Chock lever	9
Shift pedal	10
Fuel tank cap	10
Fuel.....	10
Seat.....	11
Charging and installation of battery.....	12
Checking before riding.....	13
Adding fuel and engine oil.....	14
Front and rear brakes.....	15
Ride with care and good judgement.....	16
Get training if you are inexperienced.....	16
Not recommended for children under 14 years of age.....	16

This ATV is designed to carry operator onlypassengers prohibited.....	17
Apparel	18
Do not operate after consuming alcohol or drugs.....	19
Starting and riding.....	19
Starting the engine.....	19
Riding	20
Turning.....	21
Braking.....	21
Stopping.....	22
Parking brake.....	22
Use of remote engine stop switch	23
Instructing the young rider.....	23
INSPECTION AND MAINTENANCE	25
Periodic maintenance chart for the emission control system	26
General maintenance and lubrication chart.....	27

Toolkit	30
Tire	30
Braking system	30
Lubricating driven chain	31
Gear box lubricating oil	32
Inspection of battery	32
Troubleshooting chart	33
CLEANING AND STORAGE	34
Cleaning	34
Storage	34
SPECIFICATION	36
MAINTENANCE RECORD	36
WARRANTY	37
WIRING DIAGRAM	41
WARNING	42

AN IMPORTANT NOTE TO PARENTS:

This ATV is not a toy. Before you let your child ride this ATV, you should understand the instruction and warning in this Owner's Manual. Then be sure your child understands and will follow them. Children differ in skills, physical abilities and judgment. Some children may not be able to operate an ATV safely. Parents should supervise their child's use of the ATV at all times. Parents should permit continued use only if they determine that the child has the ability to operate the ATV safely.

Your ATV was delivered with an adjustable speed limiter and also with an air intake restrictor. We recommend that all beginners start off with the speed limiter screw turned in and the air intake restrictor plate installed to limit the amount of speed available while they learn. The limiter screw may be gradually turned out to increase maximum speed as the beginner becomes more familiar with operating the ATV. Parents should decide when to adjust the ATV for more power as their youngster's riding skills improve. Once the ATV rider can operate with skill at the top speed permitted by adjusting the speed limiter alone, the air intake restrictor plate can be removed. Since removal of this plate will result in a significant increase in power, turn the speed limiter back in again; adjust it out in stages as you did before.

If your child is a beginner or is inexperienced, he or she should take a training course. See the previous page for information about the free training available to purchasers of new ATVs.

LOCATION OF THE WARNING AND SPECIFICATION LABELS

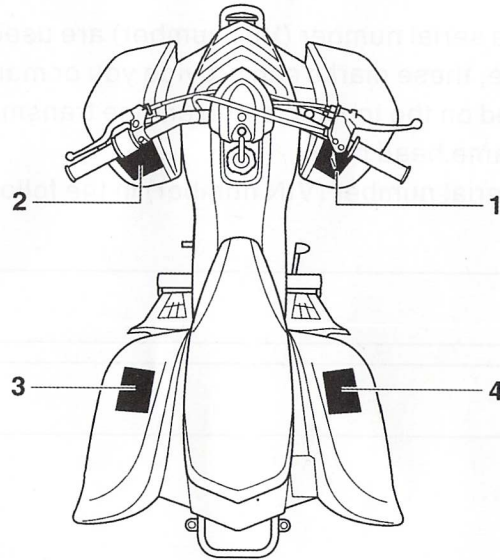

- ★ Read and understand all of the labels on your ATV. These labels contain important information for safe and proper operation.
- ★ Never remove any labels from your ATV. If a label becomes difficult to read or comes off, request a replacement label from your sales dealer.

DESCRIPTION

1. Serial Number Location

Engine serial number and frame serial number (VIN number) are used to mark the motor vehicle, if some parts need special service, these marks can provide you or maintenance man some information. Engine serial number is stamped on the topside of the engine transmission case. Frame serial number (VIN brand) is located on the frame head pipe.

Please write down the engine serial number (VIN number) in the following blanks, in the future.

Engine Serial Number:

Frame Serial Number:

2.Location and Function of parts

LEFT VIEW

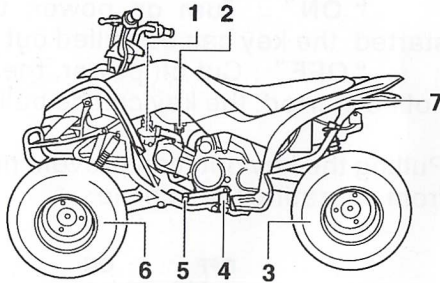

- 1.Chock
- 2.Fuel petcock
- 3.Rear wheel
- 4.Footrest
- 5.Shift pedal
- 6.Front wheel
- 7.Remote engine stop switch

RIGHT VIEW

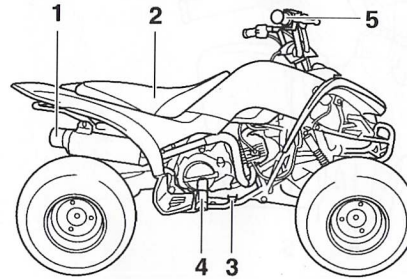

- 1.Spark arrester
- 2.Seat
- 3.Rear brake pedal
- 4.Footrest
- 5.Front brake lever

FRONT VIEW

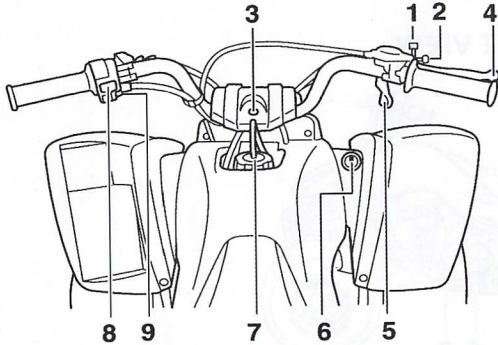

1. Parking brake plate
2. Throttle limiter screw
3. Neutral indicator light
4. Front brake lever
5. Throttle lever
6. Ignition switch
7. Fuel tank cap
8. Engine kill switch
9. Start button

NOTE:

The ATV you have purchased may differ slightly.

2.1 Ignition switch

Ignition switch is located at right side of the body, Which has two positions “ON” and “OFF”.

“ON” : Turn on power, the vehicle is started, the key can be pulled out.

“OFF” : Cut off power, the vehicle could not be started, the key can be pulled out.

Pulling the key out, can prevent non-owners from operating the vehicle.



2.2 Remote engine stop switch

Remote Engine stop switch is located at rear of body. Pull the lanyard until the safe pull plate comes off, this moment, the engine can not be

ignited or will die during running, this unit can be used to supervise child by adult.

2.3 Engine kill switch

Engine kill switch is located on left handlebar, which has two positions with “RUN” position and “OFF” positions.

“RUN” : Turn to this position, the circuit is connected, the engine can be started and driven.

“OFF” : Turn to this position, the circuit is cutoff, the engine can not be started or will die during riding.

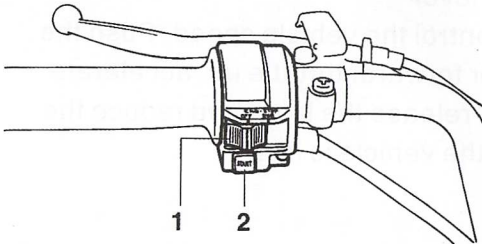

1. Engine kill switch
2. Start button

2.4 Start Button

Method: set the parking brake, press down start button with left hand, the engine can be started.

2.5 Rear Brake pedal

Hold the rear brake lever with right foot, the rear brake is in action, the vehicle speed will decrease until the vehicle stops. In addition, hold the rear brake lever firmly, start clutch engages, then you can use the pedal lever to start the engine.

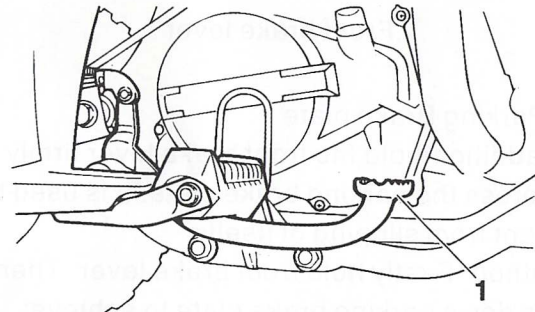

1. Brake pedal

2.6 Front brake lever
The front brake lever is located on the right handlebar. To apply the front brake, pull the brake lever toward the handlebar grip.

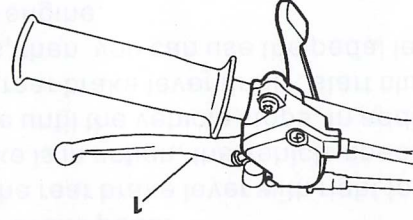

1. Front brake lever

2.7 Parking Brake plate
In addition, hold the front brake lever firmly and press the parking brake plate. It is used to prevent from slipping of itself.
Method: Firstly hold front brake lever. Then press down parking brake plate to achieve parking brake.

2.8 Throttle lever
Used to control the vehicle speed. Push the throttle lever forward, throttle up, accelerate the vehicle, release the lever and reduce the speed until the vehicle is idle.

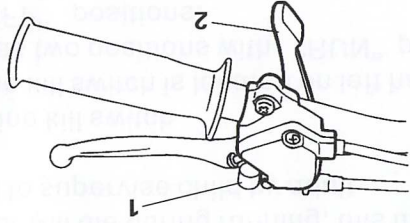

1. Parking brake plate
2. Throttle lever

2.9 Throttle limiter screw

The throttle limiter screw can restrict maximum engine, power by limiting throttle lever travel, thus restricting the vehicles maximum speed, Adjust the thouttle limiter screw according to the riders skill and experience.

Method: loosen the lock nut. Turn the throttle limiter screw clockwise to decrease the maximum speed or counterclockwise to increase the maximum speed,after adjusting, tighten the lock nut.

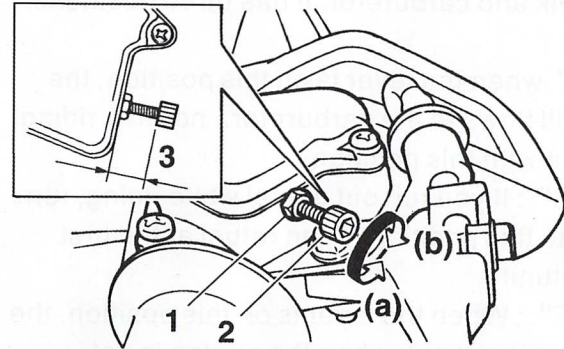

- 1.Locknut
- 2.Adjusting screw
- 3.No more than 20mm(0.8in)

2.10 Fuel petcock

The fuel petcock is a rotary valve between the tank and carburetor, it has three positions.

“ON” when the lever is on this position, the fuel will flow to the carburetor., normal riding is done with this position.

“RES” : if you run out of fuel while riding, turn lever to this position. Then refuel at the first opportunity.

“OFF” : When the lever is on this position, the fuel line is cut out; when the engine is not running, the lever should be set to this position.

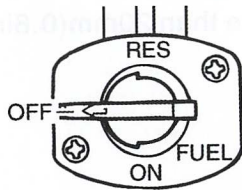

2.11 Choke lever

Choke lever is located in the right side of the body. It is used to increase the fuel/air mixing ratio when the engine starts in cold state. Pull the choke lever out “a” position the engine is in start state. After the vehicle starts, preheat the engine for 2–3 minutes, then push it back to the “b” position, it is in run state this time.

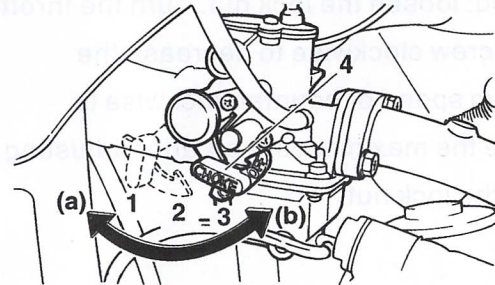

1. Fully open “ON”
2. Half open (warming up position)
3. Closed “OFF”
4. Chock

2.12 Shift pedal

This ATV is equipped with a constant-mesh 3/4speed transmission. The shift pedal is located on the left side of the engine.

2.13 Fuel tank cap

Remove the fuel tank cap by turning it counterclockwise.

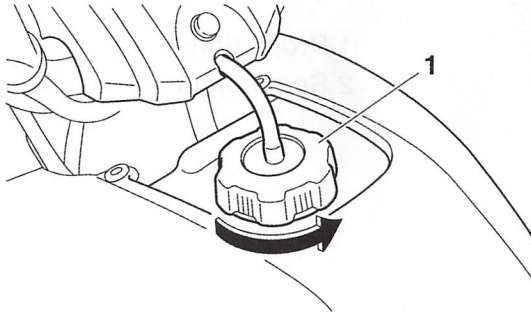

1. Fuel tank cap

2.14 Fuel

Make sure that there is sufficient fuel in the tank. Fill the fuel tank to the bottom of the filler tube as Shown.

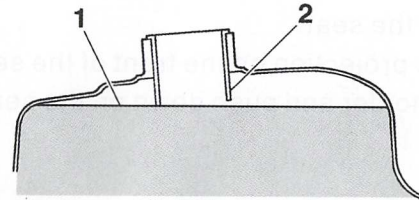

1. Fuel level
2. Filler tube

**Recommended fuel: UNLEADED
GASOLINE ONLY**

⚠ CAUTION:

Use only unleaded gasoline. The use of leaded gasoline will cause severe damage to internal engine parts, such as the valves and piston.

2.15 Seat

To remove the seat:

Pull the seat lock lever upward and pull up the seat at the rear.

To install the seat:

Insert the projection on the front of the seat into the seat holder and push down on the seat at the rear..

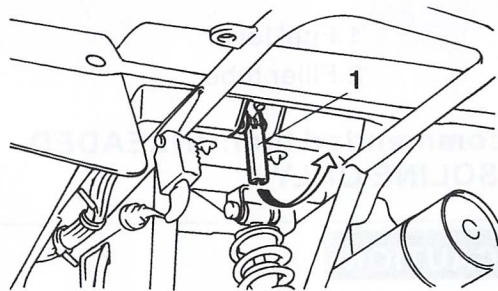

1. Seat lock lever

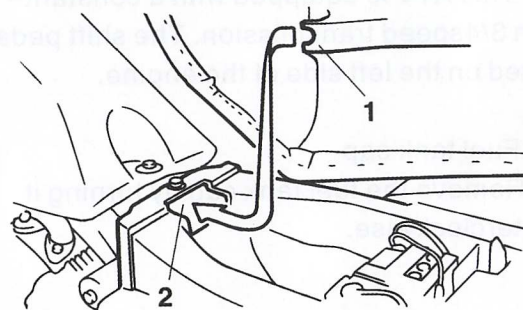

1. Projection

2. Seat holder

3. Charging and Installation of Battery

Before starting the vehicle, install the battery first. Before installing the battery, pour in the electrolyte first. then press the strip seal on the top cap firmly. Charge the battery according to the battery service manual. This will achieve the best starting effectiveness. And prolong to the battery's life. After charging, install the battery into the battery case, and tighten it firmly with tighten belt.

CAUTION:

- Never take out the seal plug, so as to avoid causing danger such as the water entering into the battery and electrolyte leaks.
- The battery should be installed firmly, no looseness.
- Do not connect the “+” . “-” electrodes reversed. Check red to red (+) black to black(-).
- Do not place the battery near high temperature fire and smoke.

4. Checking before riding

Before operating this ATV, be sure to check the items listed in the following table.

ITEM	ROUTINE
Fuel	<ul style="list-style-type: none">• Check fuel level in fuel tank, and add recommended fuel if necessary.• Check fuel line for leakage. Correct if necessary.
Engine oil	<ul style="list-style-type: none">• Check oil level in engine, and add recommended oil to specified level if necessary.• Check ATV for oil leakage. Correct if necessary.
Final gear oil	<ul style="list-style-type: none">• Check ATV for oil leakage. Correct if necessary.
Front brake	<ul style="list-style-type: none">• Check operation, and correct if necessary.• Lubricate cable if necessary.• Check lever free play, and adjust if necessary.
Rear brake	<ul style="list-style-type: none">• Check operation, and correct if necessary.• Lubricate cable if necessary.• Check lever and pedal free play, and adjust if necessary.
Throttle lever	<ul style="list-style-type: none">• Make sure that operation is smooth, and check cable free play.• Lubricate cable and lever housing if necessary.
Control cables	<ul style="list-style-type: none">• Make sure that operation is smooth. Lubricate if necessary.
Wheels and tires	<ul style="list-style-type: none">• Check wheel condition, and replace if damaged.• Check tire condition and tread depth. Replace if necessary.• Check air pressure. Correct if necessary.
Brake and shift pedals	<ul style="list-style-type: none">• Make sure that operation is smooth. Lubricate pedal pivoting points if necessary.
Brake levers	<ul style="list-style-type: none">• Make sure that operation is smooth. Lubricate lever pivoting points if necessary.
Chassis fasteners	<ul style="list-style-type: none">• Make sure that all nuts, bolts and screws are properly tightened.
Instruments and switches	<ul style="list-style-type: none">• Check operation, and correct if necessary.
Battery	<ul style="list-style-type: none">• Check electrolyte level. Fill with distilled water if necessary.

4.1 Adding Fuel and Engine oil

Check before riding, add it in time, if you find fuel is not enough.

CAUTION:

- Spilling gasoline can harm your vehicle , any gasoline can damage painted surface .
- Be careful not to spill any gasoline when fill the fuel tank. Wipe spilled gasoline up immediately.

4.1.1 Refueling

Screw off the fuel tank cap counterclockwise, refuel until reaching to the position as shown in fig. 2.14

4.1.2 Adding engine oil

Using premium four-stroke engine oil Recommended oil: SAE 15W/40.

- Warm the engine up for about 5 minutes , Remove to oil drain screw to let all oil flow out.
- Clean the oil screw and mount it.
- Remove the oil gauge and the oil to the upper limitation position of the oil to the upper limitation position of the gauge.
- Reinstall the oil gauge.



WARNING

- **After adding fuel or engine oil, the tank cap must be screwed on tightly.**
- **Do not permit anyone except adult to add fuel or engine oil.**
- **Add fuel in well ventilated area only.**
- **The engine must be stopped when adding fuel, and prevent fuel from fuel from spurting
Out onto the warm engine.**
- **No smoking and fire when adding fuel.**
- **The children should be far away when the adult is adding fuel.**
- **Avoid contacting skin with the gasoline and breathing in gasoline vapors.**

4.2 Front and rear brakes

4.2.1 Brake and rear pedal

Check for correct free play in the brake levers and brake pedal. If the free play is incorrect, adjust it.

Check operation of the brake levers and brake pedal. They should move smoothly and there should be a firm feeling when the brakes are applied. If not, have the ATV checked by the sales dealer.

4.2.2 Brake operation

Test the brakes at slow speed after starting out to make sure they are working properly. If the brakes do not provide proper braking performance, check the brake linings for wear.

5. Ride with care and good judgement

5.1 Get training if you are inexperienced.

Beginners should get training from a certified instructor.

Become familiar with this ATV at slow speeds first, even if you are an experienced operator. Do not attempt to operate at maximum performance until you are totally familiar with the ATV's handling and performance characteristics.

5.2 Not recommended for anyone under 14 years of age.



5.3 This ATV is designed to carry operator only passengers prohibited.

⚠ WARNING

POTENTIAL HAZARD

Carrying a passenger on this ATV.

WHAT CAN HAPPEN

Greatly reduces your ability to balance and control this ATV. Could cause an accident, resulting in harm to you and/or your passenger.

HOW TO AVOID THE HAZARD

Never carry a passenger. The long seat is to allow the operator to shift position as needed during operation. It is not for carrying passengers.

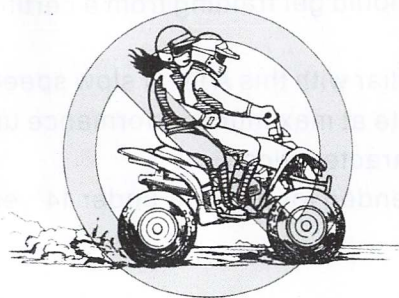

5.4 Apparel

WARNING

POTENTIAL HAZARD

Operating this ATV without wearing an approved motorcycle helmet, eye protection and protective clothing.

WHAT CAN HAPPEN

Operating without an approved motorcycle helmet increases your chances of a severe head injury or death in the event of an accident.

Operating without eye protection can result in an accident and increases your chances of a severe injury in the event of an accident.

Operating without protective clothing increases your chances of severe injury in the event of an accident.

HOW TO AVOID THE HAZARD

Always wear an approved motorcycle helmet that fits properly.

You should also wear:

- eye protection (goggles or face shield)
- gloves
- boots
- long-sleeved shirt or jacket
- long pants

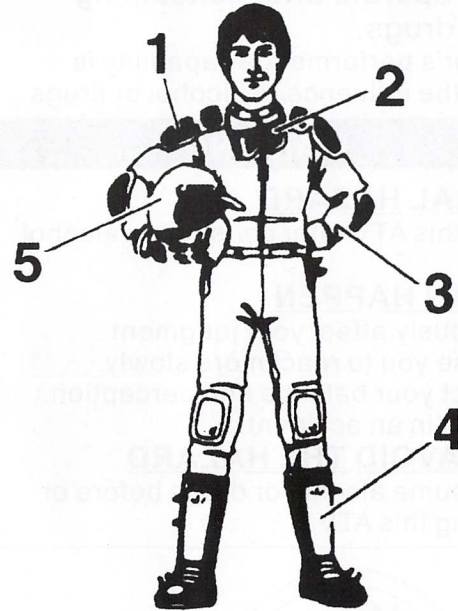

1. Protective clothing
2. Goggles
3. Gloves
4. Boots
5. Helmet

5.5 Do not operate after consuming Alcohol or drugs.

The operator's performance capability is reduced by the influence of alcohol or drugs.

WARNING

POTENTIAL HAZARD

Operating this ATV after consuming alcohol or drugs.

WHAT CAN HAPPEN

Could seriously affect your judgment.
Could cause you to react more slowly.
Could affect your balance and perception.
Could result in an accident.

HOW TO AVOID THE HAZARD

Never consume alcohol or drugs before or while driving this ATV.



6. Starting and riding

Before riding, please read this section carefully.

6.1 Starting the engine

Insert the key into the ignition switch (Now it on the "OFF" position). Turn the fuel petcock to the "ON" position, the engine kill switch to the "RUN" position, the remote engine stop switch to the installed position. Shift to neutral.

6.1.1 Starting in cold state

(1) Pull the choke lever out.

Turn the key switch to "ON" position. After the rider bestrides on the saddle, set the parking brake plate, press the starting button with the left thumb, then the engine should start up.

6.1.2 Starting in warm state

(1) Don't pull the choke lever and let it in the original position.

(2) Start the engine following the step 2-3 in

6.1.1

WARNING

- Do not start the engine in doors or with little or no ventilation.
- Release the throttle temporarily after the engine has started.

 **CAUTION:**

- Do not press the thumb continuously on the starting button after the engine has started.
- Do not press the starting button while the engine is running, so as to avoid damaging the engine.
- In order to save electricity in the battery, don't press starting button more than 5 seconds at a time. Intermittent time is less than 10 seconds.
- If the engine fails to start after pressing the start button for 3-4 times or more than 15 seconds by pedal starting, please check the vehicle.
- In cold starting state, the choke lever can't open too long after the engine is preheated, otherwise the plug will deposit carbon and this will increase the oil consumption.

6.2 Riding

After the engine runs 30–40 seconds at idle speed and the rider is ready to ride:

 **WARNING**

- While beginning to run just , do not throttle up quickly
- When riding , the rider should always pay his/her attention to putting his/her feet on the footrest , otherwise may cause the feet to touch the wheels or reduce the rider ' s ability to control the vehicle , and could lead to an accident .

Step:

1. apply the brake
2. Push down shift from neutral to drive position(If has the gear)
3. throttle up gradually the vehicle begin to accelerate .

6.3 Turning

To turn the vehicle, the rider should shift body weight forward and support weight on the outer foot. Lean upper body into the turn and turn the handlebars in the direction of the turn.

WARNING

● **The rider should first practice the turning technique in a wide open area until he/she has mastered it , Then the rider and ride on the complicated road .**

6.4 Braking

Release the throttle and hold the brake lever , then force gradually , the vehicle will decrease gradually until stop.

WARNING

● **Avoid braking during turns. Whenever possible, use the brake to slow down before entering turns. If the vehicle has to be braked while turning, the brake lever should be used gently, otherwise could cause the Vehicle to slide or tip over easily.**

 **CAUTION**

- **Avoid braking quickly**
- **Use brakes for advance when riding in a rainy day.**

6.5 stopping

If the rider needs to stop the vehicle while riding, he/she should first release the throttle. Hold the brake lever to decelerate, then put the engine cutoff switch to “off” position. Shift into neutral.

 **WARNING**

- **After shutting off engine, do not touch the engine and exhaust pipe so as to avoid being burned.**

6.6 Parking brake

When parking the vehicle on a slope, the parking brake should be used.

Hold the front brake lever and press the parking brake plate. After releasing the brake lever, the parking brake plate should not leap up. This means that the parking brake plate has taken effect, if you want cancel the parking brake. you only need squeeze the front lever, then the parking brake plate will pop out.

6.7 Use of remote Engine Stop Switch

This device is used to help the adult control the vehicle driving by the child. When the adult finds that the vehicle should be stopped in the case of faulted ride by the child or bad road condition, the adult can pull out this switch to make the engine die out. This switch has the function of key switch too. Pull out the switch and take care of it. this can prevent the unauthorized rider from using the vehicle without permission.

WARNING

- **The device must be used until the adult confirms that the child has developed sufficient skills for safe riding the vehicle alone.**
- **When not using the device, please remove the lanyard or tie it on the frame to avoid getting caught on something and creating a hazard.**
- **While pulling out the switch, you should put your fingers through the loop so as to avoid it slipping away from your hand suddenly.**
- **When you pull out the stop switch plate, the engine will die out, and the vehicle will continue to run through the inertial force. When using this switch, you should remember this feature.**

7. Instructing the young rider

To make your child ride this vehicle safely and familiarly, you must take certain time to instruct him/her. The instruction includes the instruction before your child begins to ride and instruction and supervision during ride. Before you guide your child, you should first read this manual familiarly, and practice some basic function personally, then tell the main points ,especially the "warning"parts in this manual to your child carefully.

Following is a step by step guide to help your child have a safe and enjoyable ATV experience.

Step1: proper clothing and protective gear

Clothing and protective gear are necessary for child to ride safely. the requirement for clothing is not wearing any loose fitting clothes so as to avoid causing danger. In addition, your child should wear long pants and a long sleeved shirt, these protect against abrasive injuries and Loss of body heat. The protective gear such as helmet, eye protection and gloves is necessary for the child to wear.

Step2: familiarity with the vehicle

Your child should become completely familiar with the name and function of all controls. Let the young rider sit on the vehicle with the engine off. Demonstrate operation of the controls to the child. Ask him/her to do such things as start the engine, turn off the engine, lock the parking brake ,etc . Practice this exercise until the child can operate all of the controls hesitation and without looking at the controls.

Step3:Starting up the stopping

You can let the child sit on the vehicle. You push the vehicle from behind, this will allow your child to get feel of ridding a moving vehicle, and become familiar with its operation. Then according to the introduction on the above chapter of the manual, let the child practice the exercise of starting and parking, and you can use the remote engine stop switch to control the child until he/her can master the program of starting, accelerating, decelerating and parking the vehicle.

Step4: Turning

Explain the skill of turning to the child on a open and wide ground, let your child practice first with the engine off ,as you push the vehicle from behind .After your child is familiar with it, she/he can practice

under power. At the same time, you should control the vehicle by using remote engine stop switch.

Step 5: Putting all together

When your child has mastered above steps, you can let your child practice putting them all together until he/her is familiar with them.

The above steps will help you guide your child master the most basic techniques .Your child will need a great deal of practice after these steps have been completed .During this period guiding your child ,you must be patient and careful ,then you can realize the aim of the guide.

8. Inspection and Maintenance

It is very important to inspect and maintain your ATV regularly. If you have proper tools and are qualified, you can perform the maintenance yourself according to the instructions in this section.

If you are not sure whether you can complete it, please consult your sales dealer.

WARNING

Keep the child far away when you perform inspection and maintenance to avoid injury.

8.1 Periodic maintenance chart for the emission control system.

NO.	ITEM	CHECK OR MAINTENANCE JOB	Whichever comes first ⇒	INITIAL			EVERY		
				month	1	3	6	6	12
				km (mi)	320 (200)	1300 (800)	2500 (1600)	2500 (1600)	5000 (3200)
hours	20	80	160	160	320				
1	* Fuel line	<ul style="list-style-type: none"> • Check fuel hoses for cracks or other damage, and replace if necessary. 		√		√	√	√	
2	Spark plug	<ul style="list-style-type: none"> • Check condition and clean, regap, or replace if necessary. 		√	√	√	√	√	
3	* Valves	<ul style="list-style-type: none"> • Check valve clearance and adjust if necessary. 		√		√	√	√	
4	* Carburetor	<ul style="list-style-type: none"> • Check choke operation and correct if necessary. • Check engine idling speed and adjust if necessary. 		√	√	√	√	√	
5	* Crankcase breather system	<ul style="list-style-type: none"> • Check breather hose for cracks or other damage, and replace if necessary. 		√		√	√	√	
6	* Exhaust system	<ul style="list-style-type: none"> • Check for leakage and replace gasket(s) if necessary. • Check for looseness and tighten all screw clamps and joints if necessary. 		√		√	√	√	
7	Spark arrester	<ul style="list-style-type: none"> • Clean. 				√	√	√	

WARNING

Let your sales dealer maintain the item with “ * ”

If you are not qualified, it is better not to perform maintenance yourself, or you may damage your vehicle.

The engine stop switch usually on the “off” position unless the engine be running to perform the required maintenance.

Keep ATV far away form children when you do maintenance to avoid injury.

8.2 General maintenance and lubrication chart

NO.	ITEM	CHECK OR MAINTENANCE JOB	Whichever comes first ⇒	INITIAL			EVERY		
				month	1	3	6	6	12
				km (mi)	320 (200)	1300 (800)	2500 (1600)	2500 (1600)	5000 (3200)
				hours	20	80	160	160	320
1	* Timing chain	<ul style="list-style-type: none"> • Check chain tension. • Adjust if necessary. 		√		√	√	√	
2	Air filter element	<ul style="list-style-type: none"> • Clean and replace if necessary. 		Every 20–40 hours (more often in wet or dusty areas)					
3	* Clutch	<ul style="list-style-type: none"> • Check operation and adjust if necessary. 		√		√	√	√	
4	* Front brake	<ul style="list-style-type: none"> • Check operation and correct if necessary. • Check brake lever free play and adjust if necessary. 		√	√	√	√	√	
		<ul style="list-style-type: none"> • Replace brake shoes. 		Whenever worn to the limit					

NO.	ITEM	CHECK OR MAINTENANCE JOB	Whichever comes first ⇒	INITIAL			EVERY		
				month	1	3	6	6	12
				km (mi)	320 (200)	1300 (800)	2500 (1600)	2500 (1600)	5000 (3200)
hours	20	80	160	160	320				
5	*	Rear brake	<ul style="list-style-type: none"> • Check operation and correct if necessary. • Check brake lever and pedal free play, and adjust if necessary. 	✓	✓	✓	✓	✓	
				<ul style="list-style-type: none"> • Replace brake shoes. 	Whenever worn to the limit				
6	*	Wheels	<ul style="list-style-type: none"> • Check runout and for damage, and replace if necessary. 	✓		✓	✓	✓	
7	*	Tires	<ul style="list-style-type: none"> • Check tread depth and for damage, and replace if necessary. • Check air pressure and balance, and correct if necessary. 	✓		✓	✓	✓	
8	*	Wheel hub bearings	<ul style="list-style-type: none"> • Check for looseness or damage, and replace if necessary. 	✓		✓	✓	✓	
9	*	Chassis fasteners	<ul style="list-style-type: none"> • Make sure that all nuts, bolts, and screws are properly tightened. 	✓	✓	✓	✓	✓	
10	*	Shock absorber assemblies	<ul style="list-style-type: none"> • Check operation and correct if necessary. • Check for oil leakage and replace if necessary. 			✓	✓	✓	
11	*	Front knuckle pivots	<ul style="list-style-type: none"> • Lubricate with lithium-soap-based grease. 			✓	✓	✓	
12	*	Steering shaft	<ul style="list-style-type: none"> • Lubricate with lithium-soap-based grease. 			✓	✓	✓	
13	*	Steering system	<ul style="list-style-type: none"> • Check operation and repair or replace if damaged. • Check toe-in and adjust if necessary. 	✓	✓	✓	✓	✓	

NO.	ITEM	CHECK OR MAINTENANCE JOB	Whichever comes first →	INITIAL			EVERY		
				month	1	3	6	6	12
				km (mi)	320 (200)	1300 (800)	2500 (1600)	2500 (1600)	5000 (3200)
				hours	20	80	160	160	320
14	Engine oil	<ul style="list-style-type: none"> Change. Check ATV for oil leakage, and correct if necessary. 		√	✓	√	√	√	
15	Final gear oil	<ul style="list-style-type: none"> Change. Check ATV for oil leakage, and correct if necessary. 		√				√	
16	* Moving parts and cables	<ul style="list-style-type: none"> Lubricate. 			√	√	√	√	
17	* Throttle lever housing and cable	<ul style="list-style-type: none"> Check operation and correct if necessary. Check throttle cable free play and have a Sales dealer adjust if necessary. Lubricate throttle lever housing and cable. 		√	√	√	√	√	
18	* Front and rear brake switches	<ul style="list-style-type: none"> Check operation and correct if necessary. 		√	√	√	√	√	
19	* Battery	<ul style="list-style-type: none"> Check electrolyte level and specific gravity, and correct if necessary. Make sure that the breather hose is properly routed. 		√	√	√	√	√	

NOTE:

The air filter needs more frequent service if you are riding in unusually wet or dusty areas.

8.3.1 Toolkit

You are provided a tool kit for the convenience of inspection and maintenance as well as testing tire pressure. Included are some general tools, such as spanner, box wrench and tire pressure gauge.

8.3.2 Tire

Mainly check the surface of tire and air pressure gauge.

- Inspect if there are cuts in surface of tire and nails or stones bedded in the tire tread.
- Check whether the depth of the tire tread is enough, please replace the tires when the depth of the tire tread is less than 0.16 inch (4.0mm).
- Air pressure in tire should be about 68.94 kpa 10 psi Never under-inflate or over-inflate.

WARNING

- **Operating the vehicle with excessively worn tires can cause skidding due to reduced traction.**
- **Improper air pressure can affect handling characteristics, under-inflation could cause slip or skid off the tire bead, over-inflation can cause the tire to burst or tire serious damage.**
- **Be sure to use equal air pressure in left and right tires. Unequal air pressure may be adversely effect riders CONTROL. Please replace the tire if they are extremely worn out, It is very important to replace the tires, we recommend that you let the dealer complete this work leaks due to a puncture should also be repair by dealer.**

8.3.3 Braking system

- Inspect for brake travel. The brake level travel should be between 5mm and 8mm, to adjust the Brake level travel, please use following procedure.
- Loose the adjusting nut and adjust the brake level travel.

- After adjustment. Hold the brake level and check whether the brake level travel is between 5mm and 8mm
- Periodically inspect the thickness of the brake pads .When its warness more than 1 mm, it should be replaced.
- Often inspect the liquid level of brake fluid in the oil cup. When the brake fluid level is below the mark line, drain out the remaining brake fluid, and fill new DOT3 brake fluid.
- Always keep the brake disc and the brake pads clean.

8.3.4. Lubricating driven chain

Lubricating the driven chain frequently as necessary, please use the following procedures.

- Remove the chain by taking off the chain joint clip.
- Wash the chain in the solvent and lubricate it with chain lube.
- Remount it after lubrication

WARNING

- **Must be carefully during use of solvent, keep children away from solvent.**
- **When reinstalling the driven chain, be sure to position the chain joint clip so the slit end faces opposite the turning direction of the driven chain as illustrated. The driven chain will come off if you installed it improperly.**

8.3.5 Gear box lubricating oil

Using good-quality SAE 15W/40 motor oil.

Add oil according to the following steps.

- Remove the rubber plug in the gearbox and add 400–450ml oil.
- Tighten the plug after adding and check if it is leaking.

WARNING

Keep children away from oil.

CAUTION:

- **After the new vehicle breaks in 20 hours, change the oil in gearbox. Clean the Box with kerosene and the add new oil.**
- **Check the oil level frequently and add it quickly if is not enough.**
- **Oil under-level or over-lever can affect engine performance, and cause trouble.**

8.3.6 Inspection of battery.

If you find the vehicle is hard to start during operation, please remove the battery and charge battery according to the manual.

CAUTION:

Never open top cap strip and seal plugs when charging.

9. Troubleshooting chart

1. Fuel

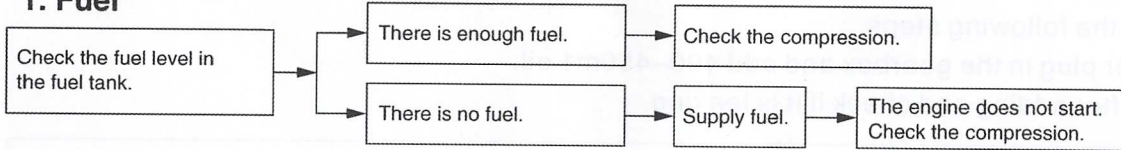

2. Compression

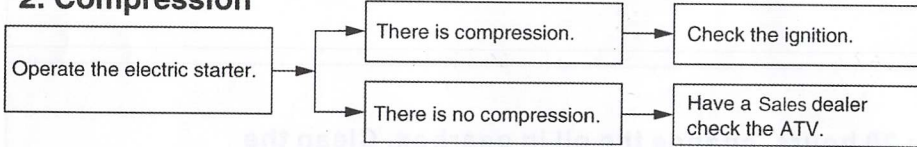

3. Ignition

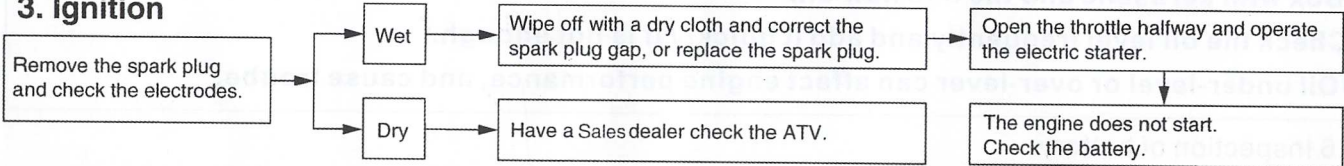

4. Battery

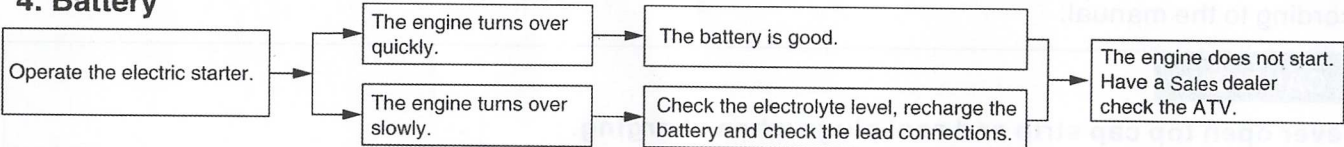

10. Cleaning and storage

10.1 Cleaning

Frequent, thorough cleaning of your ATV will not only enhance its appearance but will improve its general performance and extend the useful life of many components.

1. Before cleaning the ATV:

a, Block off the end of the exhaust pipe to prevent water entry. A plastic bag and strong rubber band may be used.

b, Make sure the spark plug and all filler caps are properly installed.

2, If the engine case is excessively greasy, apply degreaser with a paint brush. Do not apply degreaser to the wheel axles.

3. Rinse the dirt and degreaser off with a garden hose. Use only enough pressure to do the job.

4, Once most of the dirt has been hosed off, wash all surfaces with warm water and

mild, detergent-type soap. An old toothbrush or bottle brush is handy for hard-to-reach places.

5. Rinse the ATV off immediately with clean water and dry all surfaces with a chamois, clean towel or soft absorbing cloth.

6. Clean the seat with a vinyl upholstery cleaner to keep the cover pliable and glossy.

7. Automotive type wax may be applied to all painted and chrome plated surfaces. Avoid combination cleaner-waxes. Many contain abrasives which may mar the paint or protective finish. When finished cleaning, start the engine and let it idle for several minutes.

10.2 Storage

10.2.1 Short-term

Always store your ATV in a cool, dry place and, if necessary, protect it against dust with a porous cover.

10.2.2 Long-term

Before storing your ATV for several months:

- a. Follow all the instructions in the “Cleaning” section of this chapter.
- b. Turn the fuel petcock lever to “OFF” .
- c. Drain the carburetor float chamber by loosening the drain bolt;this will prevent fuel deposits from building up.Pour the drained fuel into the fuel tank.
- d. Fill up the fuel tank and add fuel stabilizer(if available) to prevent the fuel from deteriorating.
- e. Perform the following steps to protect the cylinder,piston rings,etc. from corrosion.
 - 1.Remove the spark plug cap and spark plug.
 - 2.Pour a teaspoonful of engine oil into the spark plug bore.
 - 3.Install the spark plug cap onto the spark plug,and then place the spark plug on the cylinder head so that the electrodes are grounded.(This will limit sparking during the next step.)
 - 4.Turn the engine over several times with the

starter.(This will coat the cylinder wall with oil.)

- 5.Remove the spark plug cap from the spark plug,and then install the spark plug and the spark plug cap.
- f. Lubricate all control cables and the pivoting points of all levers and pedals.
- g.Check and, if necessary, correct the tire air pressure,and then block up the ATV so that all of its wheels are off the ground.Alternatively,turn the wheels a little every month in order to prevent the tires from becoming degraded in one spot.
- h. Cover the muffler outlet with a plastic bag to prevent moisture from entering it.
- i. Remove the battery and fully charge it.Store it in a cool,dry place and charge it once a month.Do not store the battery in an excessively cold or warm place (less than 0 °F(30 °F) or more than 30 °F(90 °F))

NOTE:

Make any necessary repairs before storing the ATV.

11. Specification

Engine: Air cooled, 4-stroke, single cylinder

Start Type: Electric Start

Max Torque: 6.5 N.M, 6000 RPM

Ignition: CDI

Front Brake: Drum brake, right hand operation.

Rear Brake: Disc brake, right foot operation.

12. Maintenance record

Copies of work orders and/or receipts for parts you purchase and install will be required to document maintenance done in accordance with the warranty. The chart below is printed only as a reminder to you that the maintenance work is required. It is not acceptable proof of maintenance work.

Battery: 12V/4AH

Catalytic converter: 1 Catalytic converter,
Single configuration.

Exhaust emission control system: Three-way
converter (TWC)

MAINTENANCE INTERVAL			DATE OF SERVICE	MILEAGE	SERVICING DEALER NAME AND ADDRESS	REMARKS
month	km (mi)	hours				
1	320 (200)	20				
3	1300 (800)	80				
6	2500 (1600)	160				
12	5000 (3200)	320				
18	7500 (4800)	480				
24	10000 (6400)	640				
30	12500 (8000)	800				
36	15000 (9600)	960				
42	17500 (11200)	1120				
48	20000 (12800)	1280				
54	22500 (14400)	1440				
60	25000 (16000)	1600				

EMISSION CONTROL SYSTEM WARRANTY

Below is the emission control system warranty printed in the owner's manual, the copy of the owner's manual is available upon your request.

YOUR WARRANTY RIGHTS AND OBLIGATIONS

The U.S. Environmental Protection Agency, and **Taotao USA Inc.** (hereinafter "**Taotao USA**") are pleased to explain the emission control system warranty on your 2014 Model Year OFMC. New vehicle must be designed, built and equipped to meet U.S. EPA Federal over the full useful life.

Taotao USA must warrant the emission control system on your vehicle for 5,000 km or for 30 months, whichever comes first, provided that there has been no abuse, neglect or improper maintenance of your vehicle.

Your emission control system may include parts such as the carburetor or fuel injection system, the ignition system, catalytic converter and engine computer, if it is equipped. Also included may be hoses, belts, connectors and other emission-related assemblies.

Where a warrantable condition exists, Taotao USA will repair your vehicle at no cost to you, including diagnosis, parts and labor.

If an emission-related part on your vehicle is defective, the part will be repaired or replaced by Taotao USA. This is your emission control system defects warranty.

NOTICE! Use of any Taotao USA vehicles in any type of competitive event completely and absolutely voids this and all other warranties offered by Taotao USA.

OWNER'S WARRANTY RESPONSIBILITIES

As the vehicle owner, you are responsible for the performance of the required maintenance listed in your owner's manual. Taotao USA recommends that you retain all receipts covering maintenance on your vehicle, but Taotao USA cannot deny warranty solely for the lack of receipts or for your failure to ensure the performance of all scheduled maintenance.

You are responsible for presenting your vehicle to the Taotao USA's dealer as soon as a problem exists. The warranty repairs should be completed in a reasonable amount of time, not to exceed 30 days.

As the vehicle owner, you should be aware that Taotao USA may deny your warranty coverage if your vehicle or a part has failed due to abuse, neglect, improper maintenance or unapproved modifications.

If you use your vehicle in any type of sanctioned competitive event, this warranty is immediately and completely void.

If you have any questions regarding your warranty rights and responsibilities, you should contact Taotao USA Inc., 11550 Newberry Street, Suite 100, Dallas, TX 75229, TEL: 214 635 3980

Taotao USA warrants that each new 2014 and later Taotao USA's OFMC:

A. is designed, built and equipped so as to conform at the time of initial retail purchase with all applicable regulations of the United States Environmental Protection Agency, and

B. is free from defects in material and workmanship which cause such vehicle to fail to conform with applicable regulations of the United States Environmental Protection Agency for the periods specified above.

I. **Coverage.** Warranty defects shall be remedied during customary business hours at any authorized Taotao USA's dealer located within the United States of America in compliance with the Clean Air Act and applicable regulations of the United States Environmental Protection Agency. Any part or parts replaced under this warranty shall become the property of Taotao USA.

II. **Limitations** This Emission Control System Warranty shall not cover any of the following:

A. Repair or replacement as a result of

- (1) accident,
- (2) misuse,
- (3) repairs improperly performed or replacements improperly installed,
- (4) use of replacement parts or accessories not conforming to Taotao USA's specifications which adversely affect performance and/or
- (5) use in competitive racing or related events.

B. Inspections, replacement of parts and other services and adjustments required for required maintenance.

C. Any vehicle equipped with an odometer or hour meter on which the odometer mileage or hour meter reading has been changed so that actual mileage cannot be readily determined.

III. Limited Liability

A. The liability of Taotao USA under this emission control system warranty is limited solely to the remedying of defects in material or workmanship by an authorized Taotao USA's dealer at its place of business during customary business hours. This warranty does not cover inconvenience or loss of use of the vehicle or transportation of the vehicle to or from the Taotao USA's dealer. Taotao USA shall not be liable for any other expenses, loss or damage, whether direct, incidental, consequential or exemplary arising in connection with the sale or use of or inability to use the vehicle for any purpose. Some states do not allow the exclusion or limitation of any incidental or consequential damages, so the above limitations may not apply to you.

B. No express emission control system warranty is given by us except as specifically set forth herein. Any emission control system warranty implied by law, including any warranty of merchantability or fitness for a particular purpose, is limited to the express emission control system warranty terms stated in this warranty. The foregoing statements of warranty are exclusive and in line of all other remedies. Some states do not allow limitations on how long an implied warranty lasts so the above limitations may not apply to you.

C. No dealer is authorized to modify this Taotao USA Limited Emission Control System Warranty.

IV. Legal Rights. This warranty gives you specific legal rights, and you may also have other rights which vary from state to state.

V. This emission control system warranty is in addition to the standard limited warranty for all vehicles.

VI. Additional Information. Any replacement part that is equivalent in performance and durability may be used in the performance of any maintenance or repairs. However, Taotao USA is not liable for these parts. The owner is responsible for the performance of all required maintenance. Such maintenance may be performed at a service establishment or by any individual. The warranty period begins on the date the motorcycle is delivered to an ultimate purchaser.

Taotao USA Inc.

11550 Newberry Street, Suite100, Dallas, TX 75229

U.S.A

TEL: 214 635 3980 FAX: 214 635 3985

CHASSIS

Front/Rear Brake	Drum - Disc
Parking Brake	Foot control, hand control
Front Tire	16x8-7
Rear Tire	16x8-7
Front Tire Pressure	68.94 kpa 10 psi
Rear Tire Pressure	68.94 kpa 10 psi
Net Weight	105 kg / 231.49 lbs

SPECIFICATIONS

DIMENSIONS

Overall Length	50 inches
Overall Width	33.5 inches
Overall Height	38 inches
Wheelbase	31.89 inches

ENGINE

Type	air-cooled, single cylinder, 4 stroke
Displacement	107cc
Bore X Stroke	107cm ³
Max Power	5.5 kw @ 8000 RPM
Max Torque	6.5 Nm@ 6000 RPM
Idle Speed	1400+-100 rpm
Ignition	C.D.I
Starting	Electric
Spark Plug Gap	0.6-.07 mm
Transmission	Chain
Compression Ratio	9:2:1
Valve Clearance	0.03+-0.01 mm In Ex
Spark Plug	A7RTC

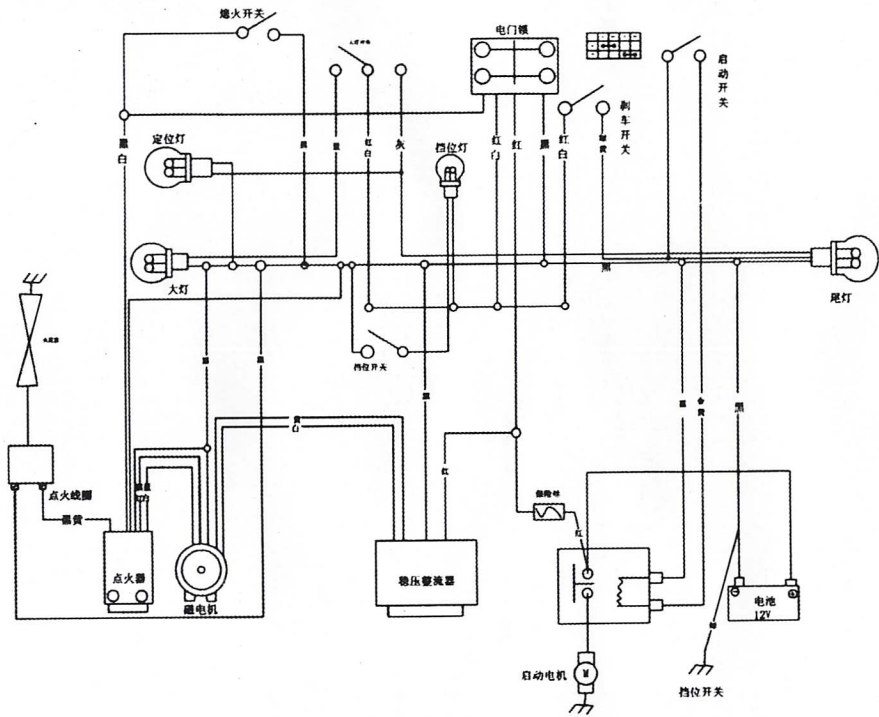

⚠ WARNING

Improper ATV use can result in SEVERE INJURY or DEATH.



ALWAYS USE AN APPROVED HELMET AND PROTECTIVE GEAR



NEVER USE ON PUBLIC ROADS



NEVER CARRY PASSENGERS



NEVER USE WITH DRUGS OR ALCOHOL

NEVER operate :

- without proper training or instruction.
- at speeds too fast for your skills or the conditions.
- on public roads-a collision can occur with another vehicle.
- with a passenger-passengers affect balance and steering and increase risk of losing control.

ALWAYS:

- use proper riding techniques to avoid vehicle overturns on hills and rough terrain and it turns.
- avoid paved surfaces-pavement may seriously affect handling and control.
- Training courses to teach ATV riding are available for information contact your dealer.

LOCATE AND READ OWNER'S MANUAL.
FOLLOW ALL INSTRUCTIONS AND WARNINGS.

TAOTAO USA INC

2425 CAMP AVE. SUITE 100. CARROLLTON, TX 75006

TEL: 214-635-3980 FAX: 214-635-3985