

OWNERS MANUAL FOR THE GIO TITAN



3-Wheeled Electric Power Assisted vehicle Manual (Recreational vehicle)

Matters needing attention to users

Please note the following important safe matters in order to ensure your safe driving and use this vehicle better.

1. Please read the user manual carefully and check whether all spare parts is perfect before driving in order to ensure your safe driving.
2. Overloading is prohibited strictly.
3. It is recommended to carry out charging every day, to charge after electric quantity of battery exhausts is prohibited strictly
4. Inside the battery box of this vehicle there is a safety power source, when battery box is taken out, both jacks in lower end (namely positive pole + and negative pole - of battery) can't be touched by hand (particularly damp hands) at the same time, and also be prohibited to touch metal body (like key, etc.) or else unlimited short-circuit current produced will cause an accident and burn of human body. Please give a great attention to the above.
5. Please don't detach and disassemble spare parts or rebuild electric vehicle by itself, please purchase standard spare parts from the dealer of Z-TECH brand electric vehicle if to replace spare parts. Please repair timely if find power-cut don't happen when do a front or rear brake.
6. This vehicle can drive normally under the condition that depth of deposit water don't surpass center of electric hub when driving on road surface with dropsy in rainy weather. Electric hub will be infiltrated by water and cause a trouble from electric hub if dropsy of road surface surpass center of electric hub.

RIDING SAFELY

General Rules

- Always wear an approved helmet when riding your bike, and follow the helmet manufacturer's instructions for fit, use and care of your helmet.
- When riding obey the same road laws as all other road vehicles, including giving way to pedestrians, and stopping at red lights and stop signs.
- Ride predictably and in a straight line. Never ride against traffic.
- Use correct signal lights to indicate turning or stopping.
- Ride defensively. To other road users, you may be hard to see.
- Concentrate on the path ahead. Avoid potholes, gravel, wet road markings, oil, curbs, speed bumps, drain grates and other obstacles.
- Expect the unexpected such as opening car doors or cars backing out of concealed driveways.
- Be very careful at intersections and when preparing to pass other vehicles.
- Familiarize yourself with all the bike's features. Practice signal lights, braking and the use of horns.
- Don't carry packages or passengers that will interfere with your visibility or control of the bike. Don't use items that may restrict your hearing.
- Maintain a comfortable stopping distance from all other riders, vehicles and objects. Safe braking distance and forces are subject to the prevailing weather conditions.

Wet Weather

- In wet weather you need to take extra care.
- Brake earlier, you will take a longer distance to stop.
- Decrease your riding speed, avoid sudden braking, and take corners with additional caution.
- Be more visible on the road.
- Wear reflective clothing and use safety lights.
- Potholes and slippery surfaces such as line markings and train tracks all become more hazardous when wet.

Night Riding

- Ensure that the front lights are on.
- Wear reflective and light coloured clothing.
- Ride at night only if necessary. Slow down and use familiar roads with street lighting, if possible.

Chapter I Overview of Recreational Electric Vehicle

This recreational electric vehicle is the modern means of transport developed and manufactured to meet the needs of urban users at home and abroad. It adopts advanced production technologies and parts in China, highly adaptable, easy to operate, solid and durable, novel in style and simple to drive.

The vehicle is also known as the means of transport for the elder and proves to be the ideal choice for the elder and the special to drop in and move around. It is designed with more human-oriented configurations for special population and has four specialist functions of recreational vehicle:

1. Voice enabled reversing;
2. Buffered soft start;
3. Low-speed gear regulation;
4. Rear brake parking.

In the course of development, inspired by the motorcycle design concept, we focus on the stability and stability of complete vehicle, as well as harmony of the appearance, which make users safer and more comfortable in the operation. The vehicle is equipped with automotive differential rear axle, brushless motor and front & rear hydraulic shock absorbers. It runs more stable and is the ideal means of transport featuring efficiency, environmental protection and energy saving.

Thanks for your choosing this recreational vehicle, and may you have a pleasant driving experience!

Chapter II Parts and specification of the Recreational Electric Vehicle



No.	Name
1	Headlight
2	Front turn signal
3	Front shock absorber
4	Rearview mirror
5	Steering handle
6	Seat
7	Charging socket

8	Front tire
9	Armrest
10	Rear rim
11	Rear carrier
12	Taillight
13	Differential motor
14	Rear tire

No.	Parameter	Model Number
		XL-T408
1	Overall dimensions(mm)	165×69×1080
2	Wheelbase	1075
3	Min. turning diameter(m)	≤2.5
4	Min. speed(km/h)	≤9
5	Max. speed(km/h)	≤25
6	Driving range(km)	≤60
7	Rated load(kg)	≤100
8	Battery capacity(Ah)	20AH
9	Rated voltage(V)	48
10	Motor type	Brushless differential
11	Rated output power(W)	500
12	Rated output torque(N.m)	≥16
13	Rated current	≤15
14	Rated climbing ability	≤25°
15	Charger input voltage(V)	220V
16	Charging time(h)	4h-8h
17	Standard brake distance(m)	≤3
18	Headlight power(W)	35
19	Working voltage of lighting system(V)	12
20	Wheel diameter	300-10
21	Mass of complete vehicle	100

The "driving range" means the distance that the vehicle travels continuously on the flat concrete or asphalt surface at the fixed speed of 15km/h in the scope of rated load, with the wind speed not greater than 3m/s and the

battery fully charged.

Ambient temperature, tire pressure and load condition all are important factors affecting the driving range.

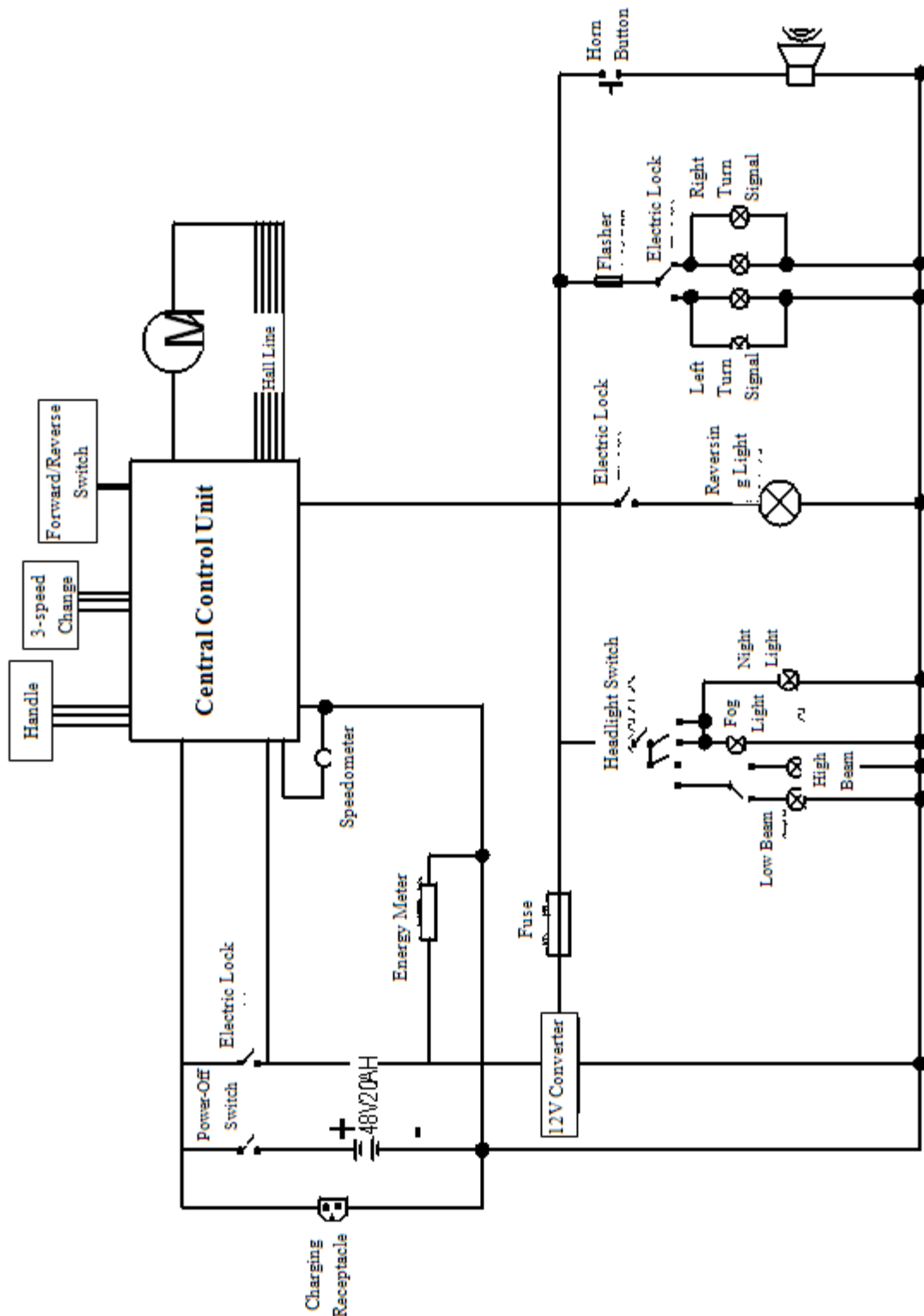

Chapter III Daily Inspection and Adjustment

For driving safety, the user shall take note of the following important items:

1. Inspection and Adjustment of Brake System

- a. Do the right and left brake levers function well? Is the power supply automatically cut off when a brake is applied?

- b. When driving at 20km/h on the road, the vehicle shall safely stop in a distance of 5 meters after the emergency braking; if the brake distance is too long, the brake shall be adjusted; if the brake pad is worn, then replace it as appropriate.
- c. Do the front and rear wheels unloaded rotate normally with the power supply not put through? Is there any friction resistance?
- d. Adjust the brake system by adjusting the set screws on the brake drum cover to the extent that the brake lever is 1/2 gripped. Note: The gripping force varies with individual persons and the inspection shall take the Point b as the basic standard.

2. Inspection and Adjustment of Other Safety System

- a. Is the pressure of front and rear tires normal? Inflate timely if the pressure is inadequate.

- b. Do the left and right turn signals and the tail light work properly?

- c. Does the power-off brake lever work properly?

3. Cautions during the Driving

- a. Does the vehicle get off smoothly? Do you have the feeling that the driving speed is sometimes slow and sometimes high?

- b. Does the handle turn freely and easily?

- c. Are the front and rear brakes flexible and reliable? Is there any abnormal sound when the front and rear wheels are rotating?

- d. Do the turn signals, horn, headlight, tail light and instrument light work properly?

- e. Is the pressure of front and rear tires adequate?

- f. Do the fastening screws, bolts and nuts throughout the vehicle become loose?

- g. Is the free travel of front and rear brake cables is appropriate?

Note: Make replacements immediately in case of any abnormality.

4. Simple Adjustment of Complete Vehicle

- a. The vehicle should be able to be braked when the brake lever is 1/2 gripped.

Maintain appropriate air pressure of tires(standard pressure: 300kpa(3.0kpa/cm²))

Chapter IV Safe Riding Precautions

1. Strictly observe traffic rules, do not cut in on the queue and do not drive on nonmotorized vehicle lane;
2. The recreational vehicle has the same rated capacity as the vehicle and electric vehicle, and hence it is not allowed to carry another adult(except a child);
3. The vehicle shall not run with the handle carrying a load so as to prevent loss of control resulting in accident;
4. Only the poncho could be used when riding in the rain. Holding up an umbrella is not allowed and operating the vehicle with a single hand is forbidden.
5. Never wash the vehicle with water directly during the cleaning and the use of high-pressure gun is forbidden to avoid electric items being shorted due to moisture;
6. Over-speeding on the downhill is forbidden and never apply the brake with a single hand or all of sudden while driving at high speed to avoid risk due to the forward shifting of gravity center;
7. Any unauthorized dismantlement may bring about hazard and risk to your vehicle;
8. Before riding, be certain that wheel fasteners and etc. are secure and reliable to prevent accidents;
9. Avoid driving on bumpy, muddy, cobbled and step-like roads to prevent damage to your vehicle in case of a flat tire and distorted rim, resulting in risks.

! Note: the brake distance advance shall be increased when you are riding in the rainy or snowy days.

Chapter V Key Points in the Operation of Recreational Electric Vehicle

! Warning:

For your safety, practice your riding skills in the open if you are a learner. Do not drive your vehicle on the roads until you get the hang of it. Observe the traffic rules voluntarily and drive on the nonmotorized vehicle lane. Do not offer the vehicle to others unaware of its operation.



I. Functionality of Control Parts

The structure of control parts are shown above and each part has the following functions:

1. The left brake lever is the lever for rear brake and brake power-off control switch. Gripping this lever will allow the rear brake to function and the rear wheel will stop, here the brake light will turn on and the voltage from controller output to the motor is reduced to zero, the motor will stop working to realize double safety of rear wheel braking.
2. For the light switch(headlight and dimmer switches), when driving in the evening, firstly set this switch to the first-gear position, both the instrument light and tail light will turn on; then set the headlight switch to the second-gear position, both high beams and low beams can work.
3. High- & low-beam light switch can switch between the weak and strong, between the high and low, of headlight beams; at HI position, the beam irradiates upwards, this is the high beam with strong density; at L0 position, the beam irradiates downwards, this is the low beam with weak density. Note: For safety reason, when there is an oncoming vehicle at night, it is necessary to set the dimmer switch to the L0 position.
4. The turn signal switch is the signal light switch which is used when you are turning right or left and are changing your lane. When it is set to the R(right)position, both front and rear turn signals on the right side flash, signaling a right turn. When it is set to the L(left)position, both front and rear turn signals on the left side flash, signaling a left turn. The middle is the Off position and simply pressing the switch inward will allow it to return to its original position.

5. The speedometer in the instrument cluster is the device showing the driving speed(unit: km/h) and the distance traveled. The energy meter shows the voltage level of battery, with the pointer at H position meaning a high level of energy and at L position meaning a low level of energy. The pointed lamp in the instrument cluster indicates the direction of turn or lane change when flashing and the lamp in the middle is the high- & low-beam indicator light.
6. The right brake lever(front brake lever) is the lever for front wheel brake and brake power-off control switch. When the lever is gripped, the front brake functions and the front wheel stops rotating. It is recommended to use both front and rear brake levers for emergency braking. Note: DO NOT use the front brake lever alone, otherwise your vehicle may skid.
7. The rearview mirror is used to check if there is pedestrian or other vehicle on the left and right sides so as to ensure driving safety at the time of turning (or overtaking).
8. The speed governor handle controls the high or low RPM of the motor, i.e. the speed of the driving. To accelerate, turn the handle towards yourself(inwards)gently, the more you turn, the higher the speed will be, and vice versa.
9. The master lock(electric lock) is the switch that controls the power supply of complete vehicle and the controller. The vehicle will not work until the lock is enabled. If the vehicle develops a malfunction or the speed governor handle can not control the speed of motor, then set the switch to the OFF position to prevent the vehicle from further working and to avoid safety accidents.
10. The horn switch is to sound the horn when it is pressed.
11. The parking lock functions to park the vehicle after stop. With the vehicle coming to a complete stop, gripping the left brake lever, holding upwards the parking lock and then releasing the left brake lever will allow the parking lock to get the parking results. If the shoe of rear brake is excessively worn, the parking lock may not perform well and it is necessary to adjust the rear brake.
12. The 3-speed switch(speed regulation switch) is designed for special population. When the switch is set to the low-speed mode, the driving speed is 9km/h, when it is set to the medium-speed mode, the driving speed is 15km/h and when it is set to the high-speed mode, the driving speed is 25km/h. Note: For safety reason, at the initial stage it is recommended to set the switch to the low-speed mode to avoid accidents!
13. The reversing switch functions to reverse the vehicle through rotation of the speed governor handle by setting the switch to the O position as needed. The reversing speed is limited to 5km/h.
14. The remote control switch(alarm switch) is optional as required by the user. It functions to remotely control to turn on or off the power of complete vehicle; refer to the alarm specifications for details.
15. The player's switch(MP3 player) is optional as required by the customer. It supports the access to USB flash drive and SD card. It can automatically identify files and music and also has the radio feature; refer to MP3 player specifications for details.
16. The player speaker is used with MP3 player for amplification.
17. The circuit breaker(in saddle support) controls the mains switch of electric vehicle and shall be set to the closed position when you are riding.

The charging receptacle(at the lower seat end of front cover) is the battery charging input socket of recreational vehicle. NEVER cover this socket with the receptacle cap to avoid contact of other conductor with charging pins, resulting in sparking accidents.

Chapter VI Proper Operation & Service of Light-duty Electric Vehicle

(I) Cautions for Use of the Vehicle

1. Insert the key into the power switch and turn it clockwise to start, at this moment the power and battery level indicators on the instrument cluster will turn on, indicating the connectivity of the power supply.
2. Turn the governor handle inwards slowly with your right hand after startup and accelerate gradually to drive. Slowly releasing the handle will reduce the speed and even switch off the power supply of electric motor. During the traveling, operate your vehicle at low speed on the nonmotorized vehicle lane.
3. The vehicle is designed with the brake power-off protection, i.e. the use of either left or right handle while driving will cut off the power of the motor for safe operation.
4. If the motor restart is required after stop, it is necessary to reset the governor handle in the first place and then slowly turn the handle to accelerate.

★ (II) Cautions for Use of Motor and Controller

1. When driving upwind or uphill, do not accelerate abruptly and the speed should be increased gradually to avoid overloading the motor and battery.
2. In rainy days, try not to drive your vehicle through the water with a level greater than the centerline of rear wheel, so as to avoid the motor and battery being wet, resulting in the burnt motor.

3. During the driving, do not operate both the governor handle and brake lever to avoid any damage to other parts due to overload of the motor.

4. The vehicle is not intended for runs on the bumpy or steep roads and any heavy vibration may lead to a poor contact of electrical parts. If any of those roads are met, it is best to drive at a low speed.

Notes:

1. With the safety ensured, reduce the braking frequency as practical as possible and avoid frequent starting.
2. Reduce the speed as low as possible when driving on a bumpy surface or muddy road or when the traffic is heavy.

Warning: 1. For driving safety and to protect the motor and battery, DO NOT turn the governor handle instantly to accelerate.

2. This vehicle is designed with a differential motor for rear axle and the differential is the gear combination that is usually called the gear box and needs lubrication with the gear oil, which should be changed every three months in the normal driving conditions.

(III) Cautions for Use of Battery

1. Technical Features:

Currently, the most commonly used batteries are the sealed serviceable lead-acid type which is an energy storage component of recreational vehicle, featuring big capacity, long life and good maintainability.

2. Battery is a Consumable Item.

The battery like the fuel tank for the car is the place where the energy is stored, however its difference from the fuel tank lies in the fact that its volume may be reduced as it is used, and in this connection the batteries are consumables. But this "reduction" or "deterioration" occurs at different speeds. Selection and proper use of quality battery, keeping the vehicle in good order, and particularly the use of efficient motor, will effectively suppress the deterioration of battery capacity.

3. Considerations in Proper Use of Battery

! Keep the battery fully charged at all times. It is better to charge the lead-acid battery to the full as appropriate, which helps to extend its service life. If the battery will not be used for a long time, make sure to store it fully charged and it shall be charged monthly. Never store the battery in an exhausted condition.

! Be noted to check if the temperature on the battery case is too high while the charger is charging the battery and if the charge indicator turns orange to green; if not, then switch off the power supply immediately and send the charger along with the battery to the service center for inspection.

! At low temperatures (below 15°C), the battery capacity is subject to natural deterioration of 20%~30% and the corresponding mileage range is reduced.

! When replacing a battery in the battery pack, NEVER mix the batteries of different parameters, otherwise the battery damage may be resulted in.

! DO NOT allow the battery to come into contact with a flame, heat source or alkaline material, and do not expose it under direct sunshine, otherwise its life could be reduced.

! The battery should not be charged immediately after the end of use in summer days due to high temperature. The battery is in the cold condition at the temperature below 0°C in winter, so its charging shall be conducted in the house.

Notes: There are three most important rules to keep adequate traveling range:

1) Drive at low speed as practical as possible. The working current of the vehicle is nonlinearly rising to the speed and both the range ability and the battery life are in reverse proportion to the driving speed, that is, keeping a good habit of driving at low speed is conducive to a prolonged life of the battery.

2) Keep the habit of frequently charging the battery as possible as case may be, to prevent the battery working in the under-voltage condition all the time and also to reduce the potential of exhausted capacity.

3) For vehicles with the low-speed range, use this range as much as possible. Traveling at low speed contributes to a better driving performance.

(IV) Cautions for Adapter and Battery Charging

! The charger does not need earthing.

2. Charging Method

The user is recommended to have the battery charged while it is in service where conditions permit. When the charger indicator turns green, it indicates the battery is fully charged and here it is in the float-charge condition, which requires no power cut-off. If the use of battery is necessary, the battery could also be used when the indicator is orange illuminated.

In the battery charging, NEVER turn off the air switch of mains supply on the vehicle. Insert the output plug of the charger into the charging receptacle on the vehicle body and then insert the power plug of the charger into AV220V power socket.

3. Charging Instructions

When the charger is connected to the mains to charge the battery, the charging status indicator remains red, indicating the battery is in the constant-current charging state. When the charger enters this state, the orange indicator turns on, indicating the battery has been 90% charged. When the indicator alternates flashing green and orange and then changes to the steady green about 1 hour later, it indicates the battery has been 100% charged basically; any further charging will enable the on-line maintenance, capacity preservation or restoration. If the charging is continued at the end of maintenance, the charger will perform the micro-current supplement to the battery and the further charging will return the process to the on-line maintenance step.

! To facilitate ventilation and heat dispersion, it is forbidden to put any item onto the charger and battery case during the charging.

! When carrying the charger, remember not to subject it to rough bumps or impact, otherwise damage may be easily resulted in.

4. Other Important Information

! The charger shall be protected against liquid or metal chip ingress during the use and storage to avoid damaging the charger due to internal short circuit.

! The charger may generate certain heat while in operation and the user shall never put flammable materials at the bottom of the charger, such as flammable plastics or foams. Never cover the top and sides of the charger. Use the charger in a well ventilated place. If, during the charging, you smell an odor or notice a high temperature(above 65°C) on the charger case, then stop charging immediately and send the charger to the service center for treatment.

! The battery's on-line maintenance needs a little longer charging time as appropriate. The user may conduct the on-line maintenance for the battery at the right time and at right intervals and a long-time charging once a week may achieve better results.

! For battery products from different manufacturers and in different seasons(working temperature also varies), the on-line maintenance charger has the adaptive feature. With this feature, the charging voltage is regulated automatically to ensure the battery is fully charged without battery damage. In addition, it contributes to the slow deterioration of battery capacity and effective extension of its service life.

● Tips

! In the case of failure of the charger or battery, the charger indicator is likely not to change its color for a long time (usually more than 12 hours) and remains red all the time and the battery produces a plenty of heat, then stop the battery charging and send it to the service center for inspection.

! For operation and other cautions about on-line maintenance charger, refer to the instructions for the charger.









IMPORTANT CHARGING INSTRUCTION:

The Ignition Switch must be in the off position when the electric vehicle is being charged.

All batteries charge simultaneously. You should charge your electric bike after each ride. You must charge your electric bike if it has not been used for 30 days or more. Recharging time is between 4-6 hours.

WARNING:

Do not place the battery near heat or fire. Do not expose the charger near water.

	Read the user manual carefully!		Explosive gas! Under charging, explosive gases may generate. Take care of the ventilation if you charge the battery in closed place.
	Seal lead acid battery! Very mordant sulphuric-acid!		No smoking and naked light!
	Wear protective glasses! In case of your eye get touched by acid, wash your eye carefully by water and go to the doctor! In case of your skin get touched by acid, wash by water, treat the injured skin by 5% baking-soda tincture and go to the doctor! In case of you drink acid, drink warm water, milk or egg-white. Do not try to puke! Go to the doctor immediately!		Dangerous waste! Must not collect together with the public-waste!
	Keep away from children! Keep the children away from the acid!		Take care the recycling of this product!

WARNING!

The attached cables of the battery charger can be used for the battery-charger only!

Troubles and solutions

No	Description of malfunction	Analysis of malfunction	Way of eliminating
1	Can not be started	(1) low voltage of battery (2) bad touching between battery box and socket (3) power lock switch is not in correct position	(1) charge the battery (2) clean the dirt on the touching piece (*) (3) turn to correct position
2	Fail to adjust the speed or max speed is relatively slow	(1) low voltage of battery (2) magnetic steel in the speed-adjusting handle is loose (3) spring in the speed-adjusting handle fails to work or damage	(1) charge the battery (2) clamp after welding (*) (3) look for projectionists or maintenance station.
3	Motor doesn't work after switching on	(1) wire connection is loose (2) magnetic steel in the speed-adjusting handle is loose (3) connectors of motor wire connection loose or damage	(1) connect after repair (*) (2) clamp after welding (*) (3) look for projectionists or maintenance station.
4	Driving miles is not enough after one charge	(1) air pressure low in the tyre (2) not enough charging or charger fault (3) too much upslope, heavy dead wind, brake quite often, big load (4) discharge battery completely for long time, and not charge in time, the battery is aging or damaged (5) low temperature in winter affects driving miles obviously	(1) charge air (2) fully charge or check the touching of connectors (*) (3) suggest use feet under these situations (4) change the battery (5) suggest charge longer indoor
5	Charger doesn't charge	(1) socket of charger falls off or loose between plug and socket (2) burnt fuse in battery box (3) wire connection of battery falls off	(1) tighten socket and connector(*) (2) change the fuse (3) welding the connection wire(*)
6	Electric wheel has a strange	(1) abrasion of motor bearing (2) abrasion of carbon brush	(1) change the bearing (*) (2) change the carbon

	sound	(3) big deviation of the wheel or deform	brush(*) (3) adjust the rim
--	-------	--	--------------------------------

For the sake of your safety, please often carry out upkeep and check whether the fasteners of net basket, support, mandrel and centre shaft are loose or not. Please tighten at any moment, otherwise danger may occur.

Inspection and Maintenance

Inspect● Adjust○ Replace▲ Lubricate△

Inspection Items	Daily	Every 60 days	Every 180 days
1. Inspect if rotating and steering parts of the handle become loose or worn.		●△	
2. Inspect if the tire pressure is appropriate and tire shoe is worn.	●		
3. Inspect if the rim swings or is distorted.		●	●
4. Inspect if the gearbox oil has been replaced.		●	●
5. Inspect if the brake is good.	●	●○	●○
6. Inspect if the horn sounds well.	●		
7. Inspect if the charger and cables are worn.	●		

Remote Fob Instructions

1. Press the center power button twice to turn on/turn off the power to the scooter.
2. The top (unlock) button disables the alarm.
3. The bottom (lock) button sets the alarm.

Special hints

1. Pattern of this user's manual is only used for explanation of operation, not for reference of product inspection.
2. Diagrammatic representation of this user's manual may be different with actual products; please refer to actual sale products of shop.
3. Our company owns right of change in order to improve the performance of products, further notice won't be given.

**This vehicle is equipped with speed limit device, which is prohibited strictly to detach!
The vehicle speed will be out of control will have a safe danger to your driving if the speed limit device is detached.**

The attached charger cable can be used for charging the vehicle only!