

# OWNERS MANUAL

Please note that this is a general manual. So, the style of the 2-wheelers that you have may differ from the picture shown in this manual.

## Original instructions

Please read this owner's manual carefully before using this product ! This is most important !

Please read this owner's manual carefully! It's good for driver's safety and vehicle's maintenance!

**If the rider is without safety awareness or driving experiences, please do drive under the adult's supervision! This is most important! It's very important for your safety.**

**This product is recommended for riders of 16 years old or over.**

**Do not lend the vehicle to others who don't know how to operate.**

**Please observe the local law and regulations.**

## Content

- P2 Safety warning
- P2 compliance with the law
- P2 Assembling
- P3 The position of the VIN/PIN
- P3 Key switch
- P4 Function switch
- P4 Charger
- P4 Emergency turn off stop switch
- P4 Burglar Alarm
- P5 Tire and Tire pressure gauges
- P5 Operating
  - Inspection before riding
  - P5 Idling (**inspection**)
  - P5 Front ,rear suspension (**inspection**)
  - P5 Front brake system(**inspection**)
  - P5 Rear brake system(**inspection**)
  - P5 Battery (**inspection**)
  - P5 Tool bag(**inspection**)
  - P5 Self-Protection(**inspection**)
- P5 Starting
- P6 Training
- P6 Riding
- P6 Parking
- P6 Cleaning
- P7 Storage
- P7 Transport
- P7 Delivery
- P7 Maintenance & accessories
- P8 Accessory description, data, circuit diagram, age warning and warning labels.

## WARNING

The personal safety of the rider or bystanders may be involved.  
Disregarding this information could result in personal injury.

## CAUTION

This caution symbol identifies special instruction or procedures which, if not strictly observed, could result in damage to or destruction of equipment

## NOTE

This note symbol identifies points of particular interest for more efficient and convenient operation

**Whenever you see the symbols shown below, heed their instruction. Always follow safe operating and maintenance practice.**

## WARNING

1. This vehicle is not a toy.
2. Rider under 16 years old must use this product under adult's supervision
3. Children must be trained before driving. This is very important.
4. Be sure of children's ability to forbid the risk. This is very important.
5. Children must understand the manual and the importance of warnings on the manual.
6. User must read the owner manual carefully and understand the content of the manual.
7. Incorrect operation of this off road two-wheel vehicle will result serious injury or even death.
- 8. Age limit warning.(See aluminum warning plate on the bike)**
9. This product is intended for OFF-ROAD use. Please get off the vehicle and walk with it when crossing the roads.
10. Never ride with more than one person.
11. Never attempt to operate this vehicle while under the influence of alcohol or drugs, avoid injury or death.
12. Please control the speed, do not drive at excessive speed.
13. The vehicle is not allowed to use in the adjustment or maintenance period.
14. Be sure the vehicle is in a good condition before using it.
15. Do not modify the vehicles or change the spare parts. This is unsafe and illegal.
16. The accelerating installation of the vehicle has been set. Users should not adjust it, which may result in serious injuries and death.
17. Before riding ,please wear the safety helmet、 gloves、 protection dress and footwear ,to ensure the safety .
18. It is necessary to receive training from importer or retailer, and learn the operation skills.
19. Learn local laws and regulations of off road two-wheel vehicle driving from the retailers.
20. It's easy to be burned by break after using the vehicle for a long time.
21. Although the vehicle is with safety designed measures, harms still can not be avoided.

**Please read the warning labels on the vehicle carefully, and understand them fully.**

1. Warning caution label includes important safety information .
2. User must understand the content of labels completely, and carry out.
3. Make sure all the labels are put on the vehicles already.
4. When finding the labels are not clear or fall off, please ask dealers for them to stick on the vehicles to ensure the integrity of all the labels.

**Compliance with the laws and directives:**

2006/42/EC	MACHINERY DIRECTIVE
2004/108/EC	EMC DIRECTIVE
97/68/EC	ENGINE POLLUTANT DIRECTIVE

**Assembling guide:**

1. Place packing box on the flat ground, then open it.(with the scissors or cutter)
  2. Use 10# open-end wrench and 6# allen wrench to apart the packing metal. (for iron cage packed models, this step is not applicable)
- 1<sup>st</sup> step:** Please install rear shock absorbers, and tighten nuts on both sides with 25N.m force.
- 2<sup>nd</sup> step:** Please install the front tires (make the tread pattern and cycle valve outside),and tighten nuts with force between 35N.m ~ 45N.m.
- 3<sup>rd</sup> step:** Please install handlebar (adjust to proper angles), and tighten nuts with force between 15N.m ~ 25N.m.
- 4<sup>th</sup> step:** Connect battery cables. When you connect battery cables, electric lock is in the sate of "OFF". Positive first, then negative. Disassembly is opposite.

**CAUTION**

**If you fail to understand the instruction, please contact with the local retailers and get professional confirmation after installation.**

**NOTE**

Make sure the connection is ON, and no part is OFF. So vehicle can be started at anytime.

**Loading Adjustment (This step should be checked regularly to ensure safety and convenience):**

**Adjust the Chain:** Use the index finger, to press lightly the middle position between power output sprocket and rear sprocket. The best condition should be pressed 15mm to 20mm. If it is not in this range, please adjust the chain adjuster. (Please note: The chain adjuster should be adjusted at the same time to ensure the balance of both side).To loosen the fasten nuts of chain adjuster first, and then unscrew or screw nuts to be best condition. Finally, make the nuts of chain adjuster screwed .

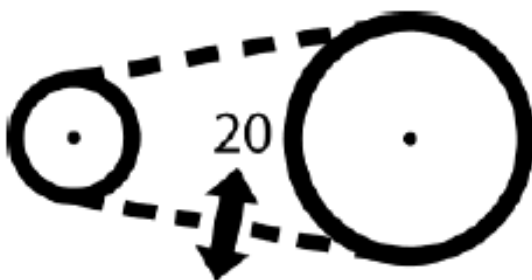

## The position of the PIN

The VIN/PIN is on the right/left side of the front frame.

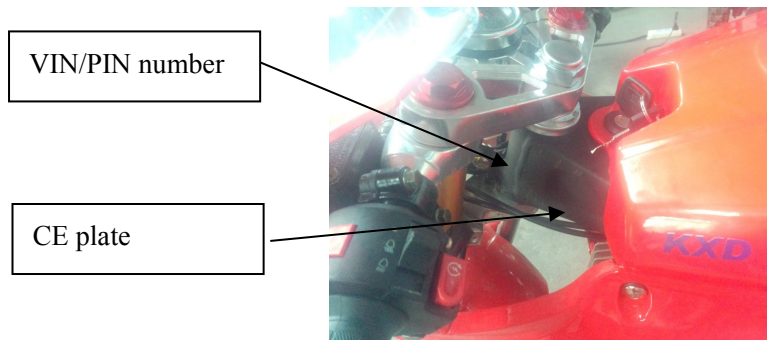

## Key switch







Key switch is on the right side of the vehicle front part, indicating "OFF" and "NO".

"OFF" condition: Key can be taken out. Light can not be turned on (if light available); engine can not be started.

"ON" condition: Key can not be taken out. When engine is being started, headlight can be turned on (if headlight available).

## Function Switch

Functional switch is in left side of handlebar, which consists of horn, start, headlight, flame-out function.

1. Electric horn button: , When key switch is on, press it, then it rings.  
(2 stroke, pull start engine have not equipped electric horn as the product construction. But manual horn should be assembled according to customers' needs.)
2. Start horn button: Red, , Press it to start the vehicle (when brake hand is ready ).
3. Headlight button: , 'near light'; , 'distance light .
4. Turn-off switch: , 'turn off'; , 'turn on.

## Charger (optional)

1. The input voltage is 220V or 110V (the same as voltage in local place), and output voltage is 12V.
2. When the vehicle is charging, the indicator light turns to be red. When the vehicle is fully charged, the indicator light turns to be green.

## Burglar alarm (optional)

1. The input voltage is 12V.  
Anti-theft function: Press the "lock" key, vehicle is in alerting condition.
2. Keyless function: Don't need to turn on the key switch. Press the "start" button twice continuously, and then operate the vehicle.

## Emergency turn off stop switch

It's put in the left side of the rear frame, or on the left handlebar. Pull or press down the switch, the engine will be stopped.

The emergency rope can be fastened on the driver. When there is emergency, the vehicle will be stopped automatically by the driver getting off the seats and pulling down the rope.

## Tire and Tire gauge

Tire: The proper tire pressure can provide the maximum stability and comfortableness.

Do check and adjust the tire pressure regularly, to make sure the pressure to be on the standard grade.

**To find the tire size and standard pressure, please check parameter list and warning label on the vehicle. To find the “Load-bearing” and “speed grade”, please check the tire surface.**

1. Check tire pressure and condition before driving. Please make the replacement if there is any following condition happened: broken, stabbing, or rim is out of shape. **(Please seek assistance from qualified technician or local retailer for replacement.)**

2. Improper tire pressure will result in hazards. Over the standard pressure can cause a flat tire. Lower than the standard pressure can cause tire relaxation or even dropping, and resulting in losing control of the vehicle.

3. When the tire-tread wearing is over 2mm, please replace new tire in time. **(Please seek assistance from qualified technician or local retailer for replacement.)**

Tire gauge (optional): Manufacturer will provide to customers to measure tie pressure.

Tire gauge is put on the key ring of the key switch for users' convenience.

Measure method: Unscrew valve cap, then press it toward the valve cap with tire gauge. The measured value is tie pressure. Put back the valve cap and screw it after measuring. .

## Operating

### Inspection before riding

#### Idling inspection

1. Stabilize the vehicle, each mechanical parts, to make sure it move normally and without interference.
2. Check whether the front and rear the shock absorber is deformed or leakage or not.
3. Check whether the front suspension and the rear flat fork is fastened in place.
4. Hold the vehicle when checking.
5. Repair and replace parts in time when finding that negative phenomena.
6. Contact with the dealer when the situation is out of control.

#### Front brake inspection

Check whether the front brake installation is firm, the braking effect is valid.

1. Front brake handle is mounted on the right side.
2. The brake is working well if backward movement of the brake handle is in the top 20-30mm.
3. Check if the tire rotation is good after releasing the brake lever
4. Contact the dealer for the need of brake maintenance.
5. The front brake lever is with parking feature as well. Use it when parking.

#### Rear brake inspection

Check whether the rear brake installation is firm, the braking effect is valid.

1. The rear brake is mounted on the left hand, or on the right foot.
2. The brake is working well if backward movement of the brake handle is in the top 20-30mm or downward movement of the top of the foot brake lever 20-30mm.
3. Put the brake lever or foot brake lever back into place quickly and check if the tire rotation is good when the force is removed.
4. Contact the dealer for the need of brake maintenance.
5. Inspect the brake shoe regularly, and replace if timely when it is worn out as the brake shoe is a worn pieces of block.
6. Do not open the brake casually as the brake fluid will damage people's skin. Clean the skin with

water of go to the doctor when it happens.

7. The rear brake lever is with parking feature as well. Use it when parking.

### **Battery check (if available)**

The battery of this vehicle is maintenance free.

1. Check whether battery joint is tight. If there is some part broken ,please change it.
2. Do not throw off the battery which resulting in environment pollution.
3. Do not charge the battery until it is out of power.
4. When the vehicle placed for extended period of inactivity, check the electric quantity every 3 weeks.

Charge it when below 12V.

5. When charging, using or placing the battery, do not put it upside down.

### **Tool bag inspection**

Check whether tool bag is taken every time before riding.

The tool bag is equipped with some professional tools. You can use time when in need.

### **Self-protection inspection**

Self-protection inspection is the guarantee of pleased driving and life safety. Please wear the protective clothing correctly to ensure your safety.

**Protective clothing consists of these parts below:**



## **WARNING**

Every check and inspection step above is necessary, there is danger existing when driving. Please conform the above process before driving, and operate in accordance with the standard strictly when driving will protect your and life safety. The warning sticker put on the surface of vehicle includes important safety information. User must comprehend fully and act strictly. It will cause the extreme injure and even death, if not carefully checking or executing.

### **Starting**

Following the steps below to start the engine:

1. Park the vehicle on the flat ground.
2. Turn on the key switch to "NO" position. Make sure it's well connected.
3. If the engine doesn't start, please open the choke valve first. Try again. Close the choke valve, when the engine steady runs.
3. At the beginning, turn the throttle slowly.

## WARNING

During this period, do not turn the throttle into maximum, should alter the speed often.

After training period, maintain the vehicle according to maintenance form strictly. Keep the vehicle in good condition. Training is necessary. **Improper operation will result in the vehicle, and result in serious injuries and death.**

If the driver is without the safety awareness or driving experiences, please drive it under the supervision of the adults.

### Training

Unprofessional person may not understand the large information of this part. So "Training "will not explain in details .

**Advice: Learn from local professional institution or the retailer.**

Operating and driving way in the first or second weeks may affect the vehicle future performance. Please pay more attention.

During this period, do not turn the throttle into maximum, should alter the speed often.

After training period, maintain the vehicle according to maintenance form strictly. Keep the vehicle in good condition.

Training is necessary. Improper operation will result in the vehicle, and result in serious injuries and death.

If the driver is without the safety awareness or driving experiences, please drive it under the supervision of the adults.

### Riding

Before driving, please review the safety driving way and its importance.

1. Pay attention to the brakes working condition always.
2. Driving with only one hand is dangerous and forbidden.
3. Turn the throttle slowly. Never turn it suddenly.
4. Release the throttle and use the brake, to make it slow down.
5. Make sure both the front brake and the rear brake work at the same time when braking. Never force too hard, that will reduce the working life of the brakes.
6. Do not make dangerous movement while driving to ensure safety.

### Parking

1. Turn back the throttle and brake at the same time.
2. Turn the key to "OFF" position when the vehicle stops, then take out the key.
3. Parking function is recommended at this moment to avoid sliding.

### Cleaning

After every riding, the driver should clean the vehicle. Then place it on flat ground to clean, and then check.

1. High pressure air or water will harm the vehicle.
2. Do not splash water on these parts: key switch, cables, and battery.
3. Generally, to wash the vehicle with clean water..
4. Do not turn on the key switch immediately after cleaning.
5. Chain should be daubed with lubricating grease.



## Storage

The quality will be influenced if you do not use vehicle for a long time. Before storage, vehicle must be checked to ensure it is in a good condition.

1. Check the weight of vehicle from the parameter list.
2. Clean up the vehicle, and then wax its surface.
3. Turn off the key switch
4. Clean the chain, and then lubricate it.
5. Lubricate all the cable parts.
6. Place the vehicle well-packed in a cool ventilated place to avoid damp and sun exposure.

## Transport

This is a process of transport the well-packed vehicle.

1. Check the weight of vehicle from the parameter list.
2. Ensure the package well protects the vehicle.
3. Ensure the vehicle is well fixed on the trailer or forklift.
4. Handling with care.

## Delivery

This is the process of delivery the well-packed vehicle.

1. Check the weight of vehicle from the parameter list.
2. Ensure the vehicle is placed normally. Do not turn it upside down or side lay it.
3. Ensure the vehicle is well fixed on the trailer or forklift.
4. Handling with care.

## Maintenance

Unprofessional person may not understand the large information of this part. So" Training "will not explain in details .For more details ,please contact local retailer.

Necessary maintenance is the important guarantee to keep the vehicle in good condition. Please maintain the vehicle according to time list.

## CAUTION

**Engine maintenance: After every driving, please close the switch of carburetor and oil-way. Release the rest oil. This is very important. If not do it accordingly, the vehicle will not be easily started after it has been placed for a long time, or carburetor will leak.**

**Maintenance time list** (Please do operate strictly according to maintenance list)

I: Inspection, Maintenance or lubricant replacement C: Cleaning L: Add lubricant

	First week	30days after driving	Each year
Fuel System	I		
Throttle		I	
Air filter		C	
spark plug		I	
carburetor	I	I&C	
chain	I&L	I&L	
Brake pads			
brake system	I	I	I
Nuts and bolts	I	I	
Tire	I	I	I
Steering system			I
suspension system		I	I
Battery (if available)		I	

The position of spare parts, parameter, Electrical diagram, age warning and other warning labels and plates.

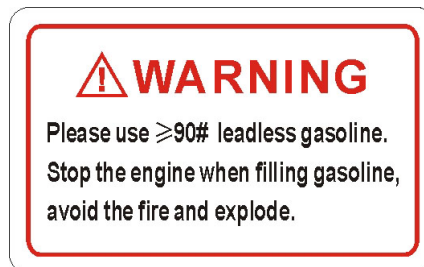

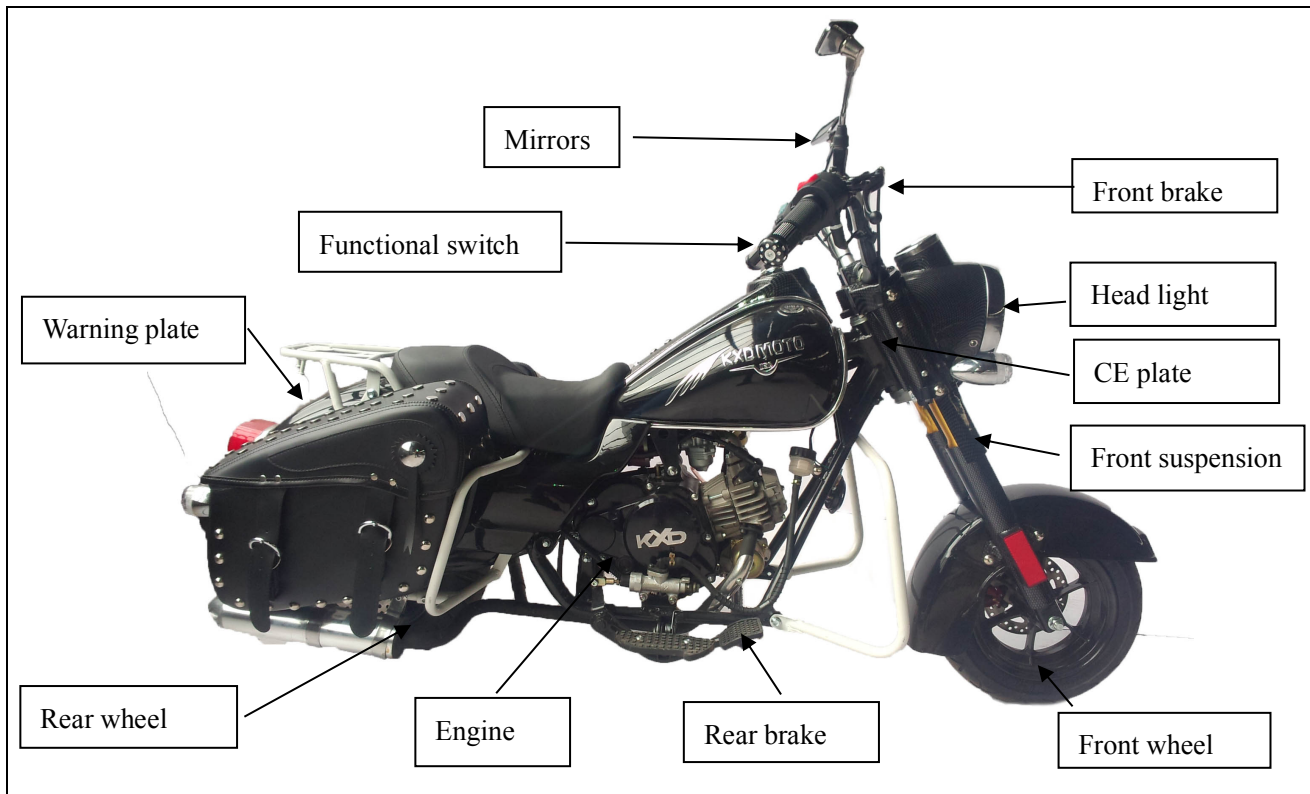

PRODUCT NAME	MOTOR BIKE	PRODUCT MODEL	KXD009
LENGTH X WIDTH X HEIGHT (mm)	1520×720×950	ENGINE MODEL	1P44FZA
AXLE BASE (mm)	1060mm	BORE×STROKES	44X37.4
WHEEL BASE (mm)	/	DISPLACEMENT (ml)	49.0
MIN GROUND CLEARANCE (mm)	120	COMPRESSION RATE	9.0: 1
TURNING CIRCLE DIAMETER (mm)	3200	UNLOADING AND ROTATE SPEED(r/min)	1700±100
DRY WEIGHT (kg)	52	RATED POWER Kw (r/min)	1.8/6000
THE WEIGHT OF FULL FURNISHMENT (Kg)	60	MAXIMUM TORQUE N.m (r/min)	3.0/4500
RATED LOAD QUALITY (kg)	80	CARBURETOR TYPE	PLUNGER TYPE
MAXIMUM SPEED (Km/h)	45	CLUTH TYPE	MULTI-DISC WET CLUTCH
OIL TANK CAPACITY (L)	5	SPARK PLUG TYPE	A7TC
FRONT/REAR SHOCK ABSORBER TYPE	F:HYDRAULIC SPRING SUSPENSION R: SPRING	MUFFLER TYPE	IMPEDANCE COMPOUND MUFFLER
FRONT/REAR BRAKE TYPE	DISC BRAKE OR HYDRAULIC BRAKE	STARTING MODE	ELECTRIC START
FRONT/REAR BRAKE OPERATION MODE	F: BY HAND R: BY FOOT	IGNITION MODE	CDI
FRONT/REAR TIRE SPECIFICATION	90/65-8 130/50-8	DRIVE MODE	CHAIN DRIVE

FRONT/REAR TIRE PRESSURE	36PSI	LUBRICATION MODE	PRESSURE、 SPLASH
FRONT/REAR RIM TYPE	ALUMINUM RIM	COOLING MODE	AIR COOLED
HEADLIGHT SPECIFICATION	/	FUEL BRAND	≥90#
PRIMARY REDUCTION RATIO	3.0	ENGINE OIL	0.7L
FINAL REDUCTION RATIO	3.5	LWA dB(A)	78
DRIVE RATIO	13.95	VIBRATION(m/s <sup>2</sup> )	1.0

**CIRCUIT DIAGRAM**

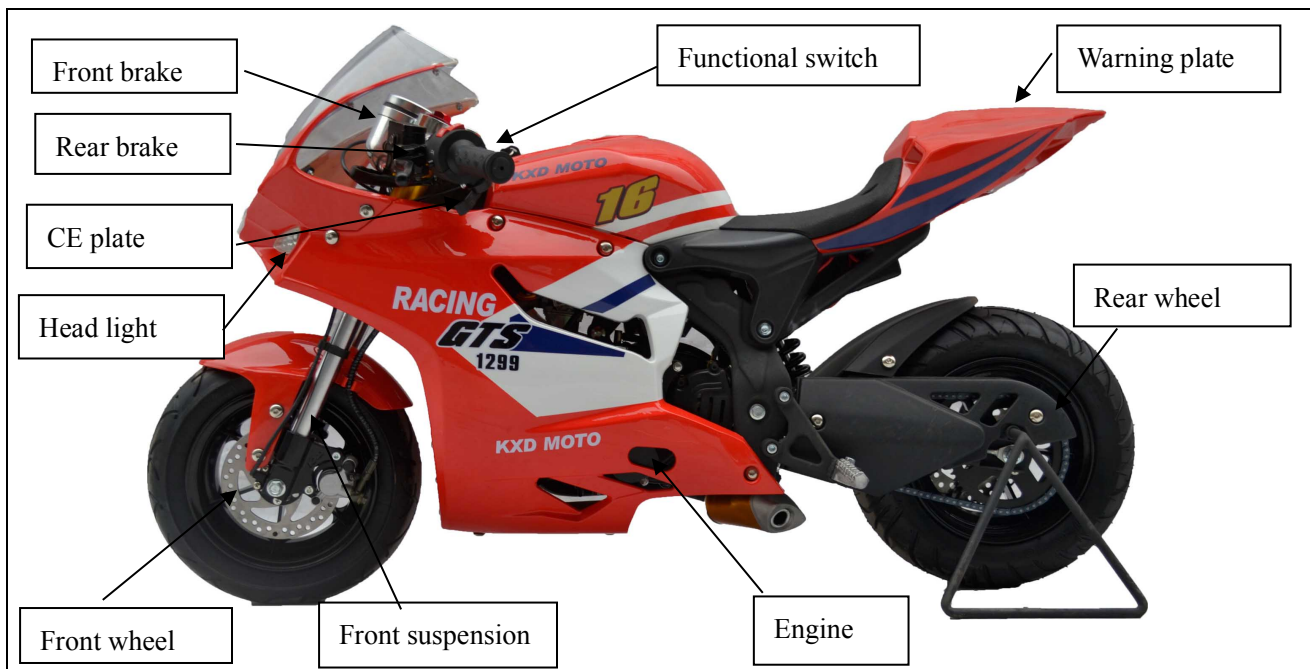
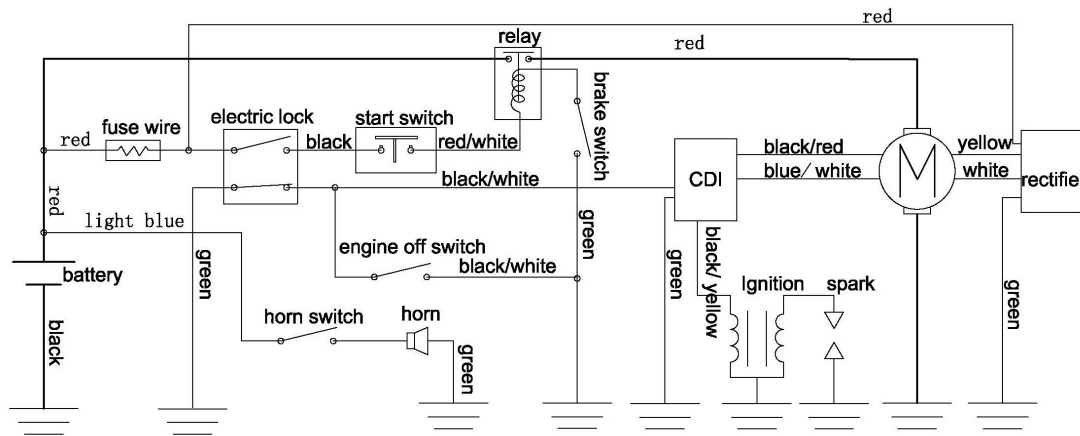

PRODUCT NAME	MOTOR BIKE	PRODUCT MODEL	KXD010
LENGTH X WIDTH X HEIGHT (mm)	1230×520×730	ENGINE MODEL	1P44FZA
AXLE BASE (mm)	1060mm	BORE×STROKES	44X37.4
WHEEL BASE (mm)	/	DISPLACEMENT (ml)	49.0
MIN GROUND CLEARANCE (mm)	120	COMPRESSION RATE	9.0: 1

TURNING CIRCLE	3200	UNLOADING AND ROTATE SPEED(r/min)	1700±100
DIAMETER (mm)			
DRY WEIGHT (kg)	45	RATED POWER Kw (r/min)	1.8/6000
THE WEIGHT OF FULL FURNISHMENT (Kg)	50	MAXIMUM TORQUE N.m (r/min)	3.0/4500
RATED LOAD QUALITY (kg)	80	CARBURETOR TYPE	PLUNGER TYPE
MAXIMUM SPEED (Km/h)	45	CLUTH TYPE	MULTI-DISC WET CLUTCH
OIL TANK CAPACITY (L)	1.5	SPARK PLUG TYPE	A7TC
FRONT/REAR SHOCK ABSORBER TYPE	F:HYDRAULIC SPRING SUSPENSION R: SPRING	MUFFLER TYPE	IMPEDANCE COMPOUND MUFFLER
FRONT/REAR BRAKE TYPE	DISC BRAKE OR HYDRAULIC BRAKE	STARTING MODE	ELECTRIC START
FRONT/REAR BRAKE OPERATION MODE	F: BY HAND R: BY FOOT	IGNITION MODE	CDI
FRONT/REAR TIRE SPECIFICATION	90/65-8 130/50-8	DRIVE MODE	CHAIN DRIVE
FRONT/REAR TIRE PRESSURE	36PSI	LUBRICATION MODE	PRESSURE、 SPLASH
FRONT/REAR RIM TYPE	ALUMINUM RIM	COOLING MODE	AIR COOLED
HEADLIGHT SPECIFICATION	/	FUEL BRAND	≥90#
PRIMARY REDUCTION RATIO	3.0	ENGINE OIL	0.7L
FINAL REDUCTION RATIO	3.7	LWA dB(A)	78
DRIVE RATIO	13.95	VIBRATION(m/s <sup>2</sup> )	1.0

CIRCUIT DIAGRAM

