

edge banders - sizing edge banders

# stefani xd

single sided edge bander for the furniture industry





TO THE HNK

DELL



# THE COMPACT SOLUTION



**TO LARGE  
REQUIREMENTS**

## EASY



**Immediate use** even for inexperienced operators thanks to the operating logic of “what has to be done” and not “how to do it”.

**Zero errors** with the **Side Finder** technology indicating to the operator the correct panel side to be inserted into the machine.

**Total control** thanks to the **3D adaptive preview** of the workpiece.

## POWERFUL



**Industrial productivity** with speeds up to 30 m / min and distance between panels of 600 mm also with machining changeover.

**All the range of panels as standard**, from 8 to 60 mm thickness.

## HEAVY DUTY



**No compromise on stiffness.** 40% of the weight of the machine is its frame.

**Productivity over multiple shifts per day.** Frame, pressers, columns, operating units, are all designed for intense non-stop production.

**Automation Ready.** Ready for the use with automation, devices for panel return, systems for semi-automatic or automatic panel loading.



## SMART



**One touch for Just in Time processing from HMI.** Up to 3 radii + infinite thin edges with Multiedge devices.

**Easy set-up** for panels with holes for hardware thank to the Nesting Lock device.

**Fast and flexible management** of glue type and colour change, with SGP, PU BOX L and Easy Lock technologies.

## QUALITY



**High quality standards** thanks to the Hydro Lock, Zero Lock, Ed-System technologies for tools.

**Perfect machining** thanks to the operating units specifically designed for precise and constant removal, with -20% column/tool distance and -50% dynamic mass on the panel.

**Marks-free copying** with the Twin Feeler device.

## SAVE



**Save up to 9%** on yearly energy consumption with the **Sav€nergy** technology.

**Reduction** of up to 10000 m/year of edge consumption with **Opti Cut** technology.

**High return on investment** thanks to high productivity combined with constant repeatability with all production scenarios.

# OVERVIEW OF TECHNICAL FEATURES

TECHNOLOGICAL ADVANTAGES



**Agile**  
complete machining up to 3 radii + infinite thin edges with just one touch from HMI without production stops.



**Stiff and clean**  
Upper steel presser, dirt and scratch-resistant polyurethane belt.



**Groove robotic machining,** with position and depth automatically set-up with a touch by HMI.

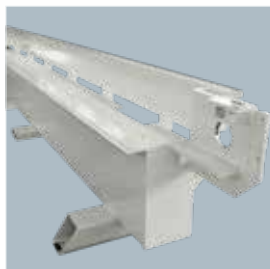
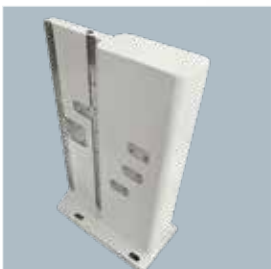

**Solid like a sizing-edgebanding machine**  
Monolithic closed steel base.  
Monolithic cast iron columns with anti-vibration design.





### **All in One**

*No limits in the choice of finishing for the joint between the edge and the panel.*

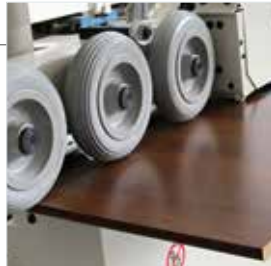

### **Integrated**

*Ready for integration in production lines with semiautomatic, automatic systems for panel loading and unloading, with or without operator.*



### **Digital**

*HMI Maestro active edge with touch screen eye-M.*



### **Adaptive**

*Dual-Mode panel preparation (std): for panels coming from Nesting processing or for panels to be squared, all by HMI.*



### **Flexible**

*Magazine for up to 6 edges in rolls with automatic changeover by HMI.*

# MATERIALS



*Paper/  
Melamine*



*PVC/ABS  
PP*



*0.6/0.8 mm strips  
Veneer  
Formica  
HPL  
Unicolor*



*Max 22 mm  
solid wood*

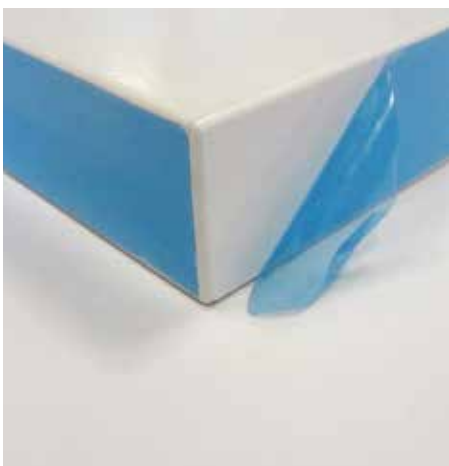

*Panels/edges with  
protective film*



*PMMA  
High gloss/Matt  
finishing*



*Glass effect 45° chamfering with depth up to 3mm*

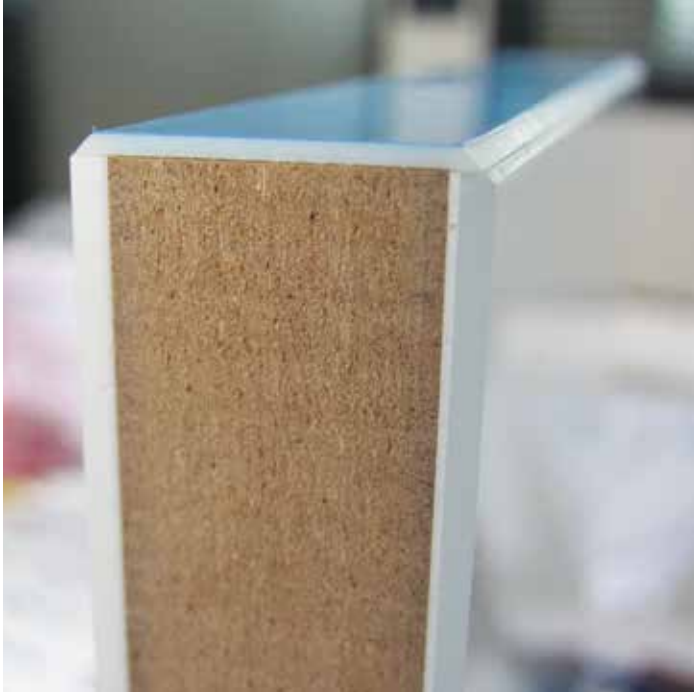

*Automatic set up from HMI when a nesting hole is present*



*Narrow pieces starting from 60 mm*

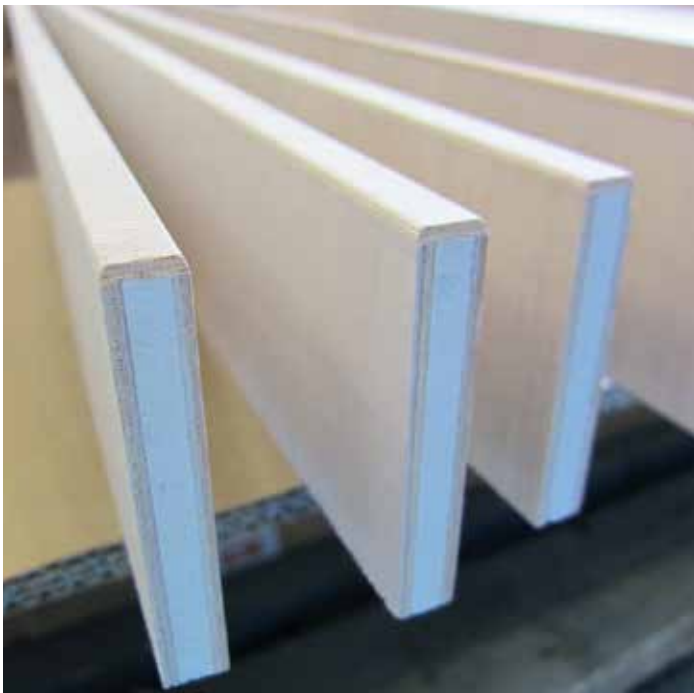

*Panels with minimum 8 mm thickness (std)*



# PANEL INFEED



*2P infeed guide with manual micro-adjustment (std). Adjustment on infinite positions by HMI (opt).*



*Productivity optimized thanks to the panel spacing device (std) which determines the best distance between panels according to the various conditions.*



*Device for the automatic insertion of the panels coming from the handling system placed at the entrance of the machine (opt).*



*Panel feed track with pads with specific design, high stability and gentle grip.*



*Top pressure belt, with automatic vertical movement by HMI depending on the panel thickness.*





*Outfeed transfer for the machine integration with external automation systems (opt).*



*Outfeed multichain transfer (opt). Fixed panel support (opt).*

*Telescopic wheel support adjustable from 0 to 700 mm (std).*



*Counter shoulder for narrow panels or solid wood (opt).*



# SOLUTIONS FOR THE AUTOMATION



*Maximum machining precision even with narrow panels / drawers thanks to the manual infeed device (opt).*



*Easy Order M manual infeed device for easy and error-free introduction of panels orthogonally to the feed direction. For dimensions up to 2,200 mm x 1,200 mm (opt).*

*Easy and fast movement of panels in the loading area with the air cushion table (opt).*







*Productivity increased up to 30% - 40% with one single operator thanks to the Fastback device for automatic panel return to the operator.*

	LENGTHWISE FEEDING		CROSSWISE FEEDING		Panel thickness	Maximum panel weight (Kg)
	Minimum length	Maximum length	Minimum length	Maximum length		
Fastback 21	250	2100	120	800	8 - 60	40
Fastback 25	250	2500	120	1200	8 - 60	50

#### MAXIMUM FREEDOM:

with the **Buffer Kit** (opt) the non-collection of the temporary panel does not block the operation of the edgebander.

#### OUT-OF-SIZE WITHOUT PROBLEMS:

with the **Extra Size Kit** (opt) the production also of the oversize is however possible in a simple and assisted way.

#### THINK BIG:

with the **Re-Loop Kit** (opt) it is possible to set up one complete cell where the operator can manage the machining of the various panel sides easily and ergonomically.

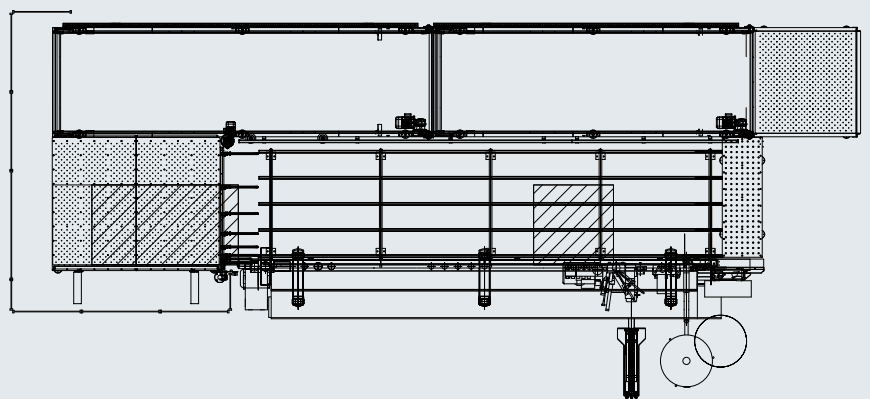

# PANEL PREPARATION AND EDGE TREATMENT



*Liquid to cool the temperature of the glue in the area exceeding the edge, after the edging, in order to keep the tools clean for the subsequent processing.*



*Sliding liquid suitable for processing delicate edges or with protective film.*



*Liquid for smoothing the plastic edge and for brightening the ABS edge.*

*Anti-adhesive liquid to prevent the adhesion between panels due to the scraps of the glue when forming stacks of machined panels.*



# PANEL PREPARATION

## PREMILLING UNIT

### RT-H PREMILLING UNIT

Working unit for milling and micro-finishing the surface of the raw panel. It contributes to the creation of a homogeneous and minimal glue line, allowing high quality of application. Structure with specific anti-vibration design.

100 mm tool diameter 4 kW motor power.

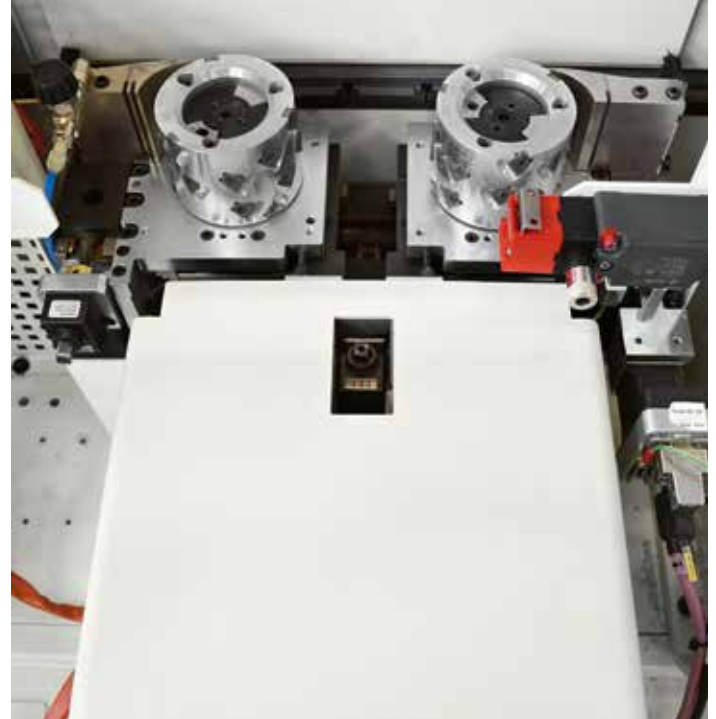

*Adaptive operation  
Dual-Mode panel  
preparation (std):  
for panels coming  
from nesting  
processing or  
for panels to be  
squared, all from  
HMI.*

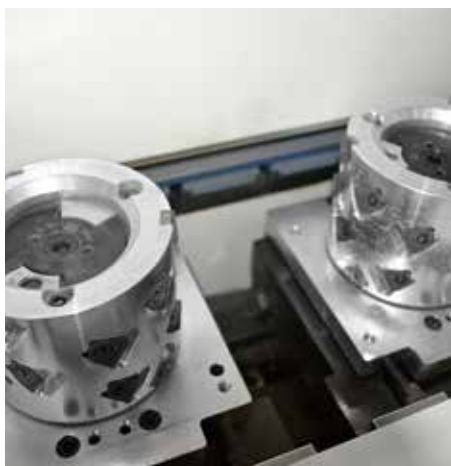

*Zero vibration with  
motor-tool interface  
Hydro Lock (opt):  
+ 20% tool life.*



*Cutting section set  
up by HMI with  
microadjustment  
thanks to NC axis  
of the first copying  
device.*

**stefani xd**

electronic single sided edge bander



# GLUING

## GLUING UNIT

### VC600 AND HM3002- E3 GLUING UNITS

Working unit for the spread of the glue and the subsequent application of the edge in rolls, in strips, plastic, veneer, solid wood. Working speed up to 30 m/min depending on the machine equipment. Flexible type / colour glue change (EVA / PU, colour). Batch 1 processing with edges of different types with constant panel pitch.



VC600

HM3002-E3

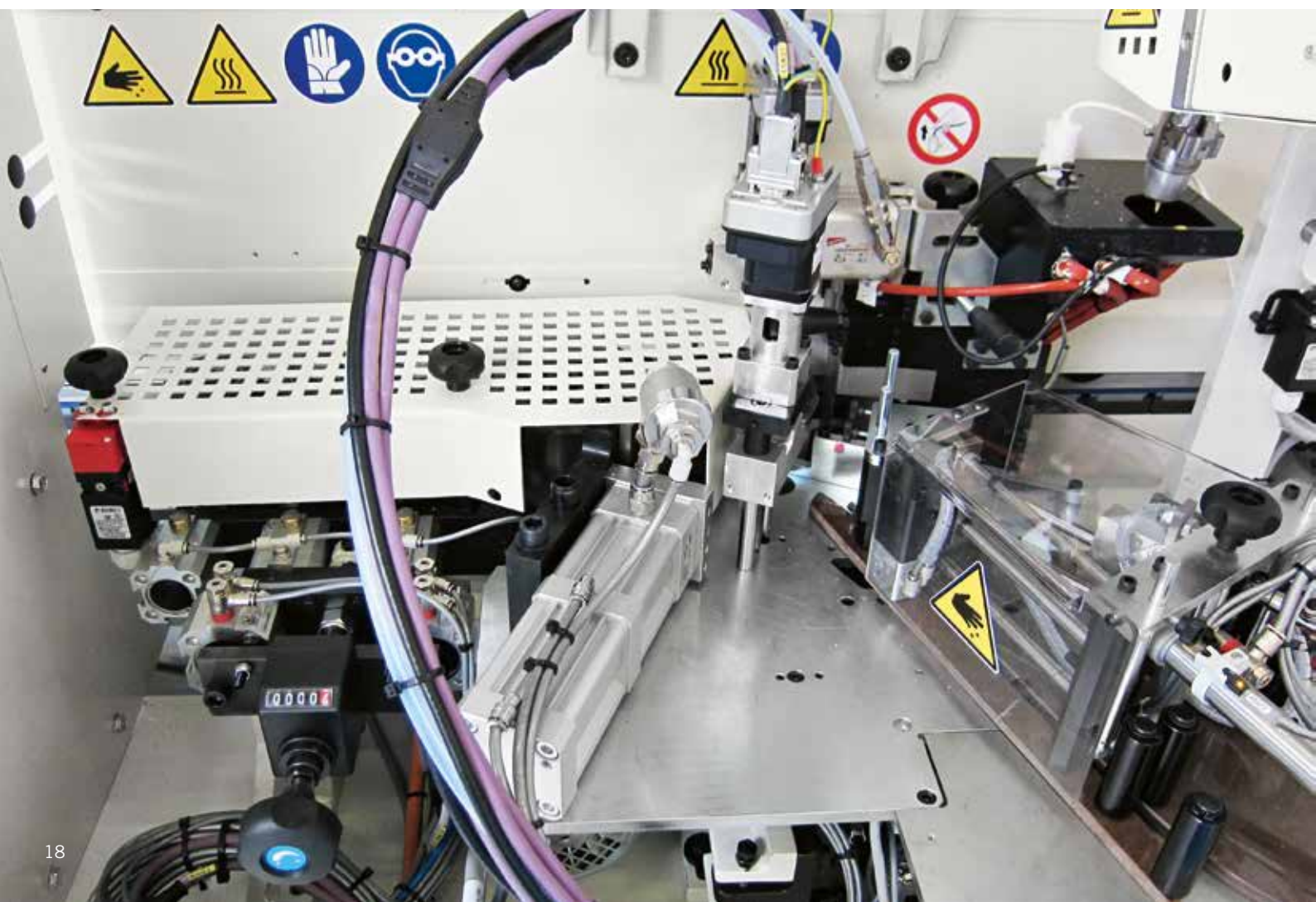



**stefani xd**

bordatrice monolaterale elettronica



# GLUING

## AVAILABLE TECHNOLOGIES



*Edge detecting sensor.*



*HIGH END solutions for working time reduction. NC edge guide (opt).  
NC glue dosing (opt). NC pressure zone (opt).*



***SGP Smart glue pot (std)***  
*Always new glue available.  
Automatic glue type  
changeover by HMI.  
Automatic closing of the  
glue circuit when the  
machine is stopped.  
Adjustment of glue  
dosage. Quick and easy  
access to the parts for  
cleaning.*



**AirFusion+ (opt)**

*It makes the junction line between edge and panel invisible using edging specific for Laser / Hot Air application. High temperature air melts the special adhesive layer in the edging and allows it to adhere to the panel.*

*Simple and fast processing of up to 22 mm thick solid wood strips (opt).*



# GLUING

## AVAILABLE TECHNOLOGIES



**QMS-P premelter**  
 For pre-melting up to 8.5 Kg/h of EVA glue in granules. Quick changeover of the glue colour with quick release of the hopper.



**PU BOX L premelter**  
 For pre-melting up to 6 Kg/h of PU glue in cartridge or granules.



Quick changeover of the glue type, from EVA to PU or vice versa, with manual selection of the pre-melter.



**AltaPUR 4HO premelter**  
 For pre-melting up to 6 Kg/h of PU glue in cartridge. Suitable for the glue filling of the glue pot or the EB 60 V slot applicator (opt).

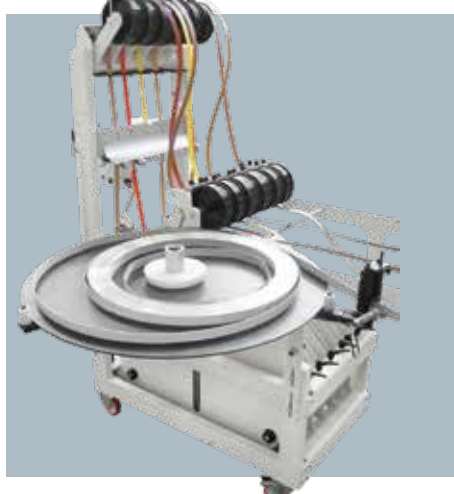

6-position coil magazine with automatic changeover by HMI depending on the program or at the end of the coil (opt).



Application of edging in ready-cut strips, veneer or rigid plastic (unicolor, formica, PC).



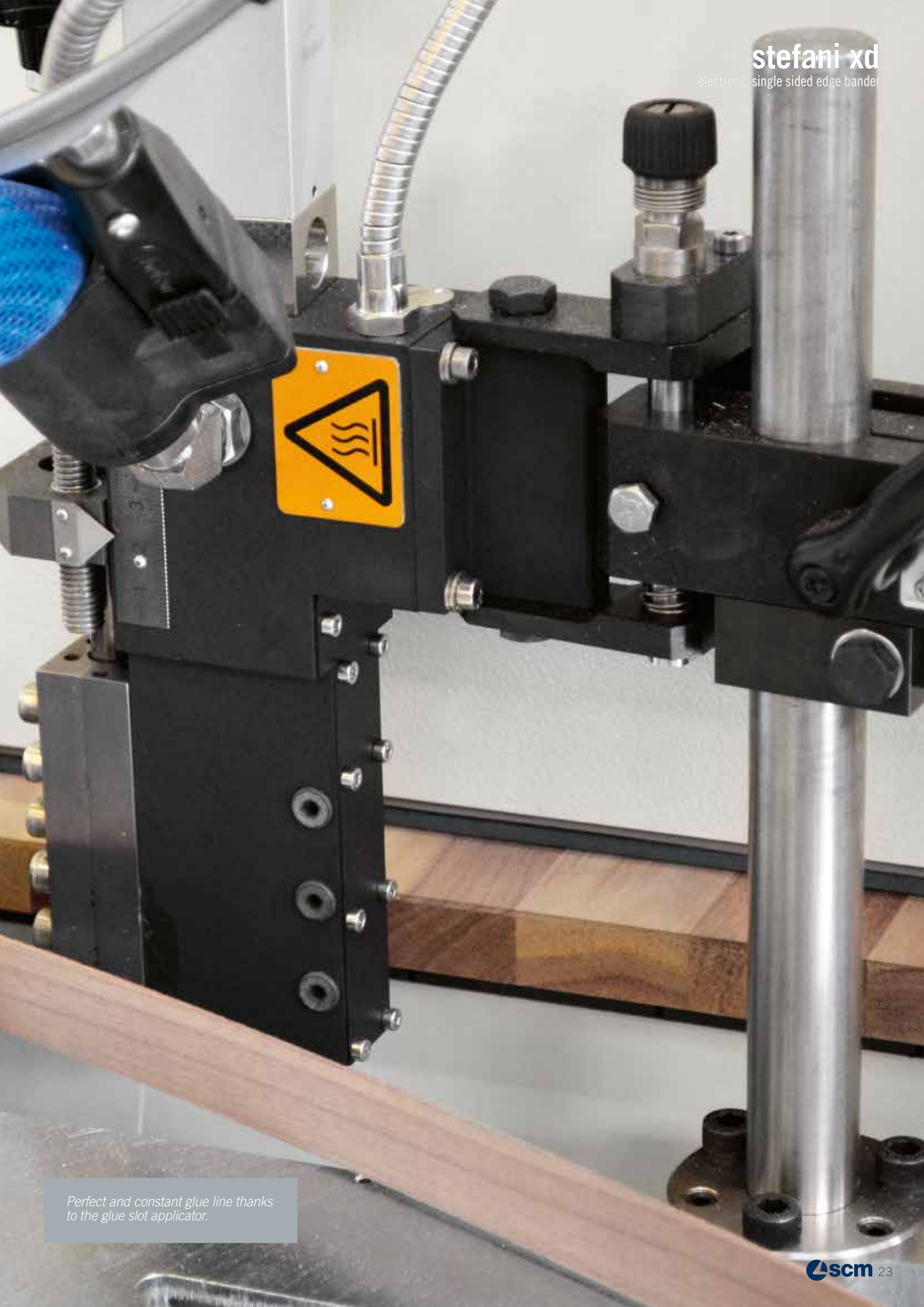

*Perfect and constant glue line thanks to the glue slot applicator.*

# FINISHING

## END TRIMMING UNIT

### YU/SP-750, YU/SP-1000, YU-1200 END TRIMMING UNITS

Working unit for the trimming of the excess after the edge application.  
Precise and constant cut thanks to lateral and front copying devices.



YU/SP- 750, YU/SP-1000 Speed: 25 m/min



YU-1200 Speed: 30 m/min

*Manual microadjustment of the lateral copying.*



*0-15° automatic tool tilting by HMI depending on the panel pass.*



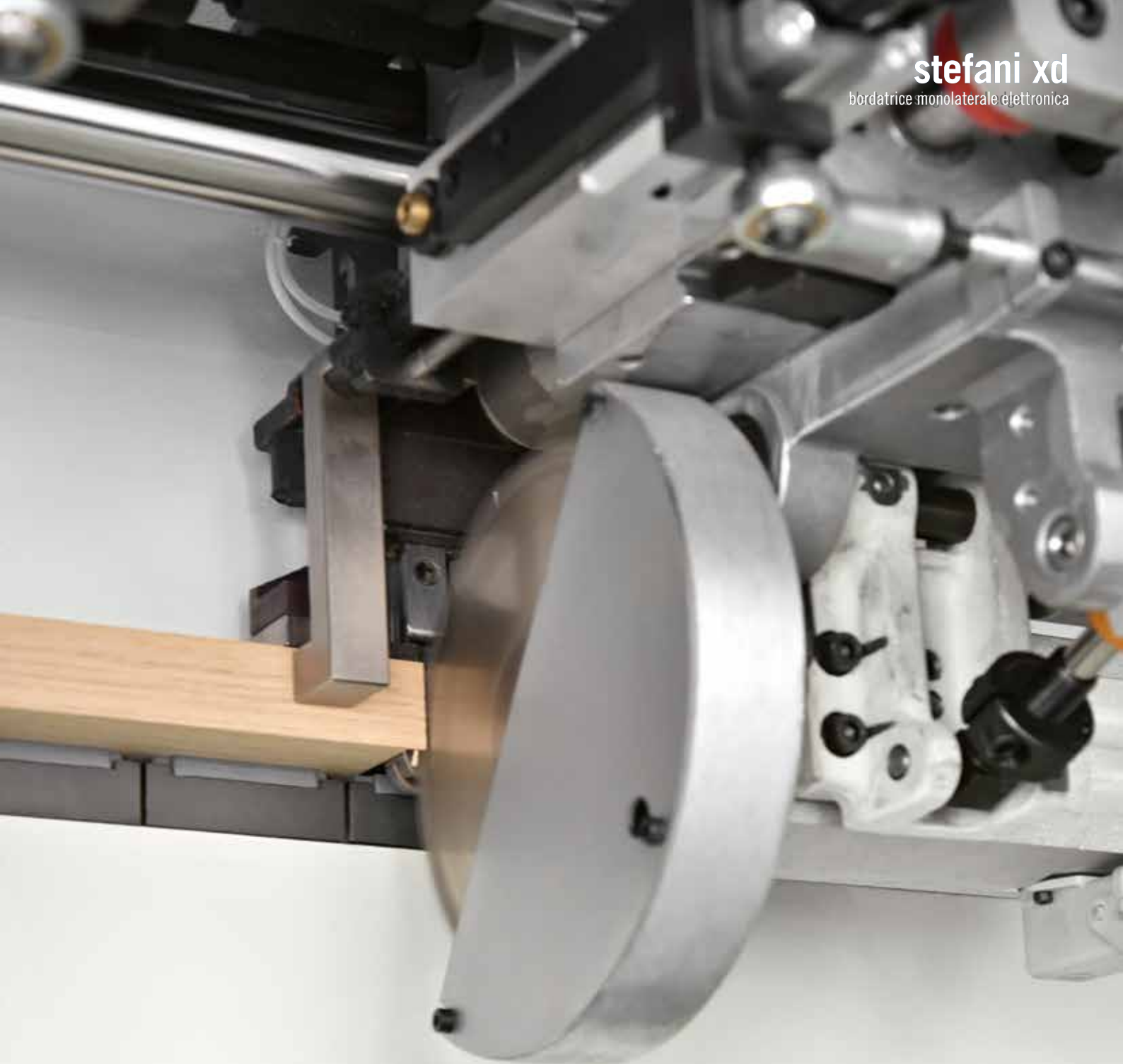



# FINISHING TRIMMING UNIT

## R-E TRIMMING UNIT

Working unit for the top and bottom trimming of the plastic edge excess or for the finishing of the solid wood.

“Vibration-free” design allowing to obtain a flat surface, smooth and constant in the processing of solid wood thanks to the study of R&D department that allowed a reduction of 10% of the dynamic masses and 15% of the distance between tool and column.

“Stick-slip free” design (std). All movements are on ball recirculation guides with manual greasing.

Power available up to 1.8 kW.



*Horizontal adjustment of the motor position with numerical decimal readout.*



*Automatic vertical double position by HMI for the trimming of plastic or wood edging (std). Manual micro-adjustment of the stop.*







# FINISHING CHAMFERING UNIT



## RSU-E CHAMFERING UNIT

Working unit for the beveling of the corner of the edge with a chamfer or radiused finishing.

“Vibration-free” design making the edge surface incredibly homogeneous thanks to the study of R&D department that allowed a reduction of 55% of the dynamic masses and 15% of the distance between tool and column.

“Stick-slip free” design (std). All movements are on ball recirculating guides with manual greasing.

*Version for automatic machining of 1 radiused edge + microadjustment for infinite thin edges by HMI and thanks to NC positioners (std).  
3 radiused edges + microadjustment for infinite thin edges (opt)  
Power available up to 1.8 kW  
Minimum panel thickness: 8 mm*







# FINISHING

## AVAILABLE TECHNOLOGIES



*The Zero Lock motor / tool interface helps to obtain a surface incredibly homogeneous and free of marks due to vibrations. + 20% average tool life, -15% produced noise.*



*Possibility to machine up to 22 mm thick solid wood Possibility to bevel Formica / HPL with variable inclination.*



*Twin Feeler copying system allowing a constant processing without marks, especially at high speeds.*



*Additional opposite-copying system with large diameter disc. For processing of panels with reduced thickness and tendency to bend.*



*Nesting Lock kit instantly stops the vertical copying movement in the presence of nesting holes.*



*Nesting Lock sensor.*





# FINISHING

## CORNER ROUNDING UNIT

### ROUND 4 CORNER ROUNDING UNIT

Complete processing of the straight / shaped panel profile with rounding of corners. Speed up to 30 m/min depending on the machine compositions. Selection of up to 3 different radii + infinite thin edges by HMI. Universal, ideal for processing even the solid wood edge and delicate materials.

### ROUND 2 SERVO CORNER ROUNDING UNIT

Complete processing of straight / shaped panels with rounding and trimming.

High quality of processing of all materials even the most delicate and lasting reliability guaranteed by the power assisted movements of which the unit is equipped. Possibility to process up to 3 different radii and infinite thin edges.

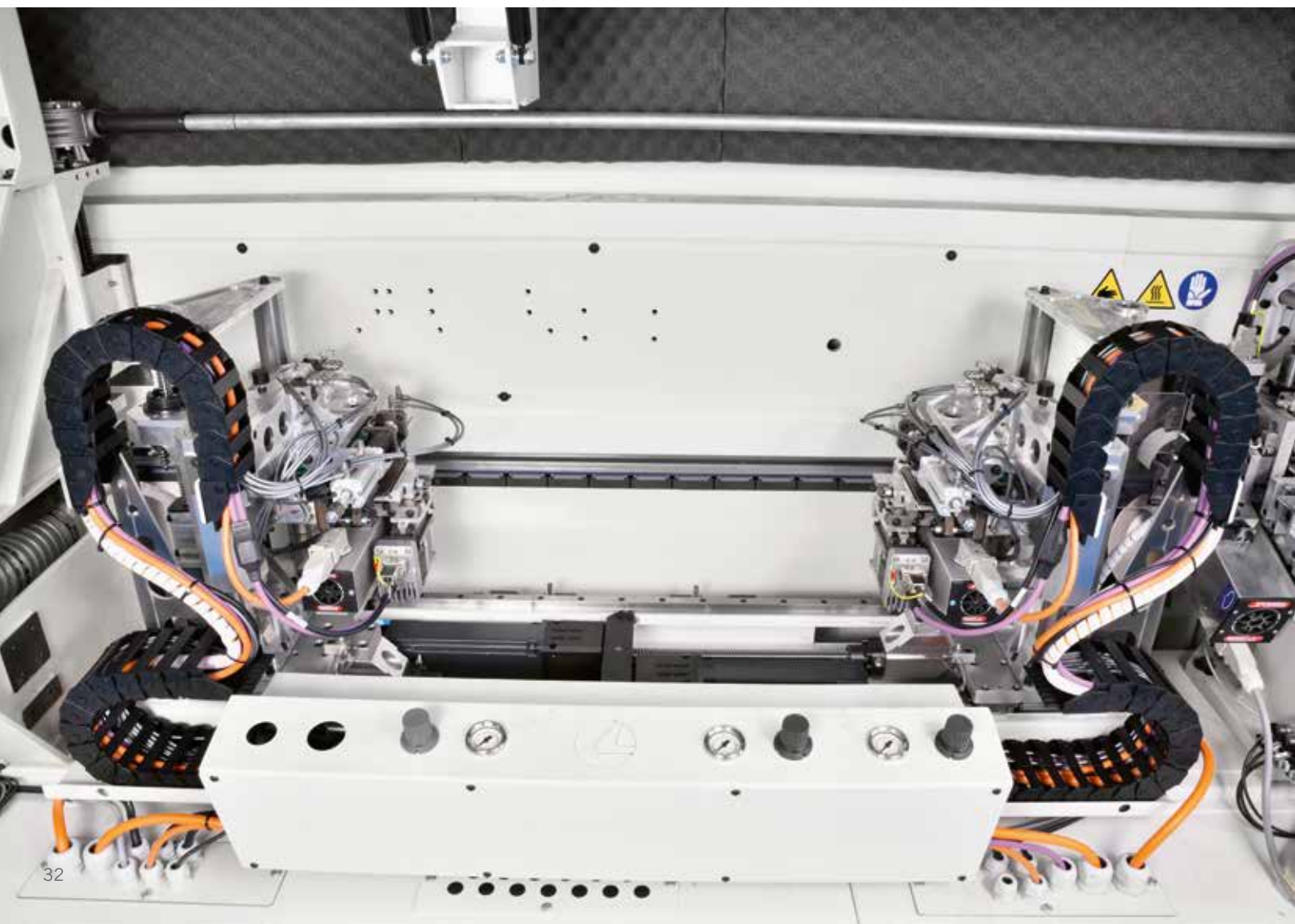

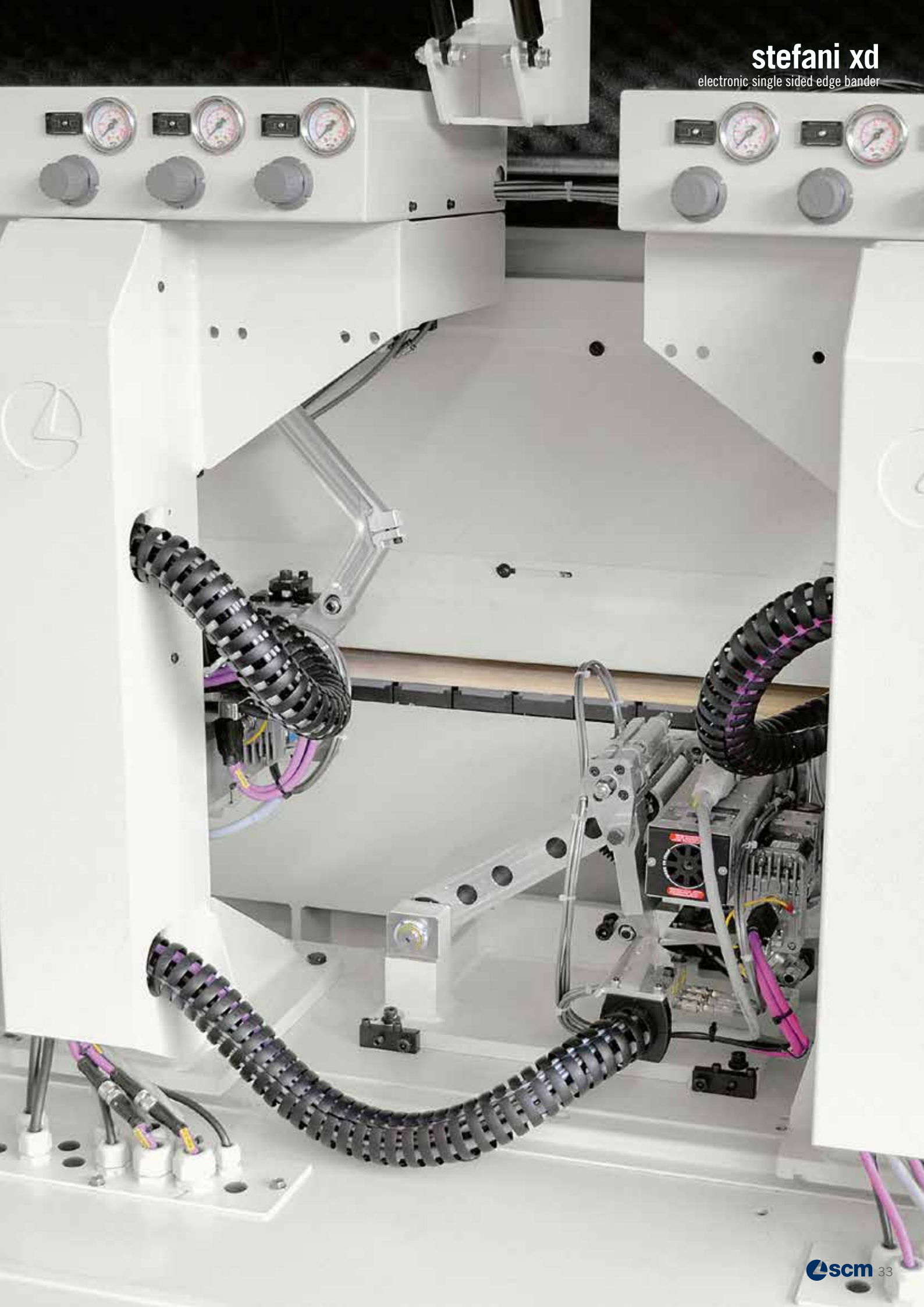



# FINISHING

## AVAILABLE TECHNOLOGIES



*Excellent processing also with changeover of material or set-up thanks to the microadjustment system of the tool position by HMI. The tool is always in the right processing position.*

*Advanced copying systems with a delicate approach to the panel, offer constant processing also with different kinds of materials (delicate, with/without protection).*



*The Zero-Lock device for the motor / tool interface helps to achieve an incredibly flat and vibration-free surface. + 20% average tool life, -15% produced noise.*







105003139

032

925652G  
501-2  
0710206  
11RB2

8x5.5x10  
035463

MEC 21  
n max 18000

# FINISHING

## EDGE SCRAPING UNIT

### RCS-E EDGE SCRAPING UNIT

Working unit for the final smoothing of the edge, rounded or flat, previously machined with rotary tools for material removal. It determines the final appearance of the edge surface. Machining in the absence of vibrations, thanks to the monolithic structure and the reduced number of parts that bring the tool closer to the column, and thanks to the specific design that allowed a reduction of up to 55% of dynamic masses and of 22% of the tool / column distance.



*Version for automatic processing of 2 rounded edges by HMI selection or of 1 rounded edge + 1 straight edge at 45° (standard).*



*Version for automatic processing of 3 rounded edges + 1 straight edge (at 20° or 45°) by HMI selection (opt) by means of 6 NC positioners allowing the tool micropositioning in any direction, also selective.*







# FINISHING

## AVAILABLE TECHNOLOGIES

SCM research has developed a full range of devices to make the finishing quality excellent in all possible conditions.



*Additional opposite-copying system with large diameter disc. For processing of panels with reduced thickness and tendency to bend.*



*TWIN FEELER copying system allowing a constant processing, without marks, especially at high speeds.*

*Stick-slip free design (standard): All movements are on ball recirculation guides with manual greasing.*



*Nesting Lock kit. It stops instantly the vertical copying movement in the presence of nesting holes.*



*Vibration-free design:  
it reduces the bleaching  
phenomenon especially  
on the ABS edge.*

# FINISHING

## SPINDLE GROOVING UNIT

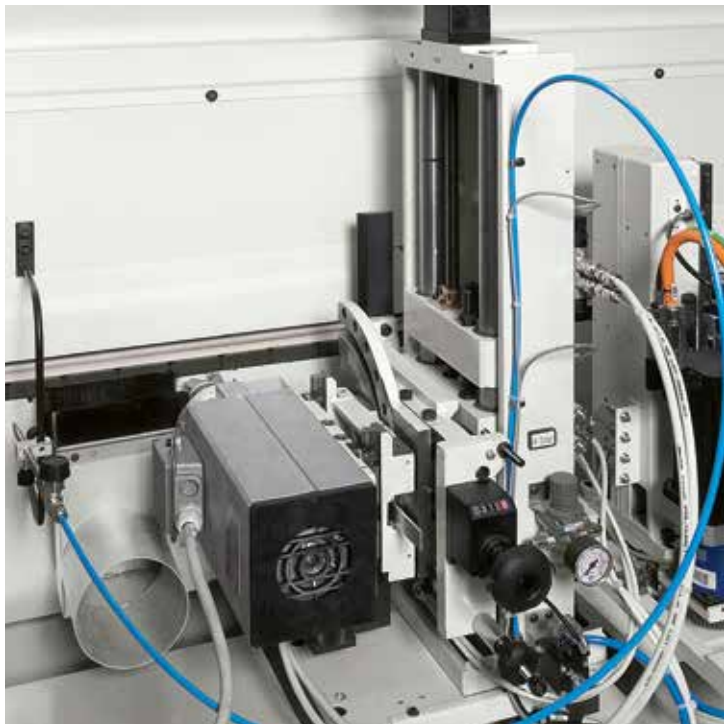

*Standard version.*

### U SPINDLE GROOVING UNIT

Working unit for slots / grooves. Machining of through or timed grooves with automatic selection by HMI. Possibility of horizontal and vertical movement with axes by HMI for automatic adjustment of position and depth. Possibility to install more tools in the same shaft. 125 mm tool diameter.

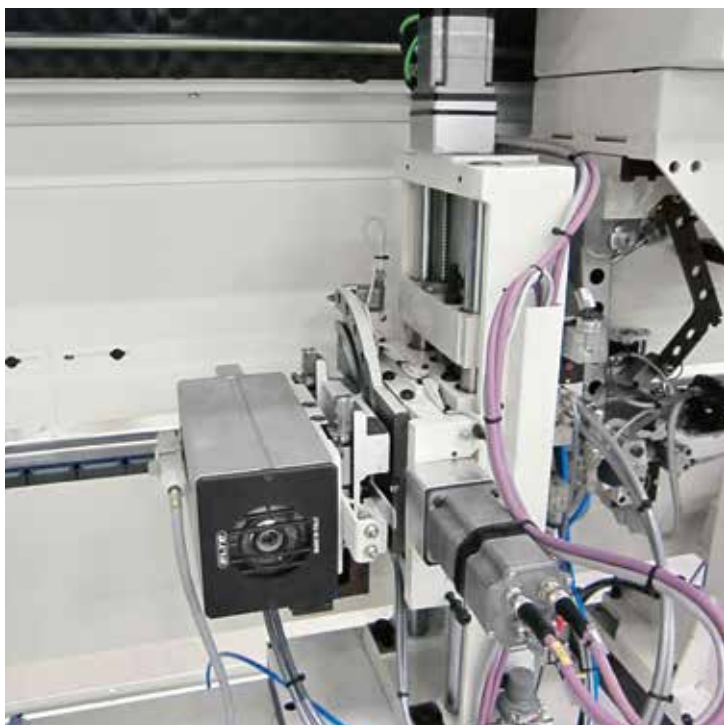

*Version with machining positioning by HMI (groove position and depth).*





# FINISHING SANDING UNIT

## GLC SANDING UNIT

Compact working unit for the finishing of MDF / HDF panels in preparation for painting, or for machined panels with wooden edges, veneer, paper, where the need is a surface sanding.

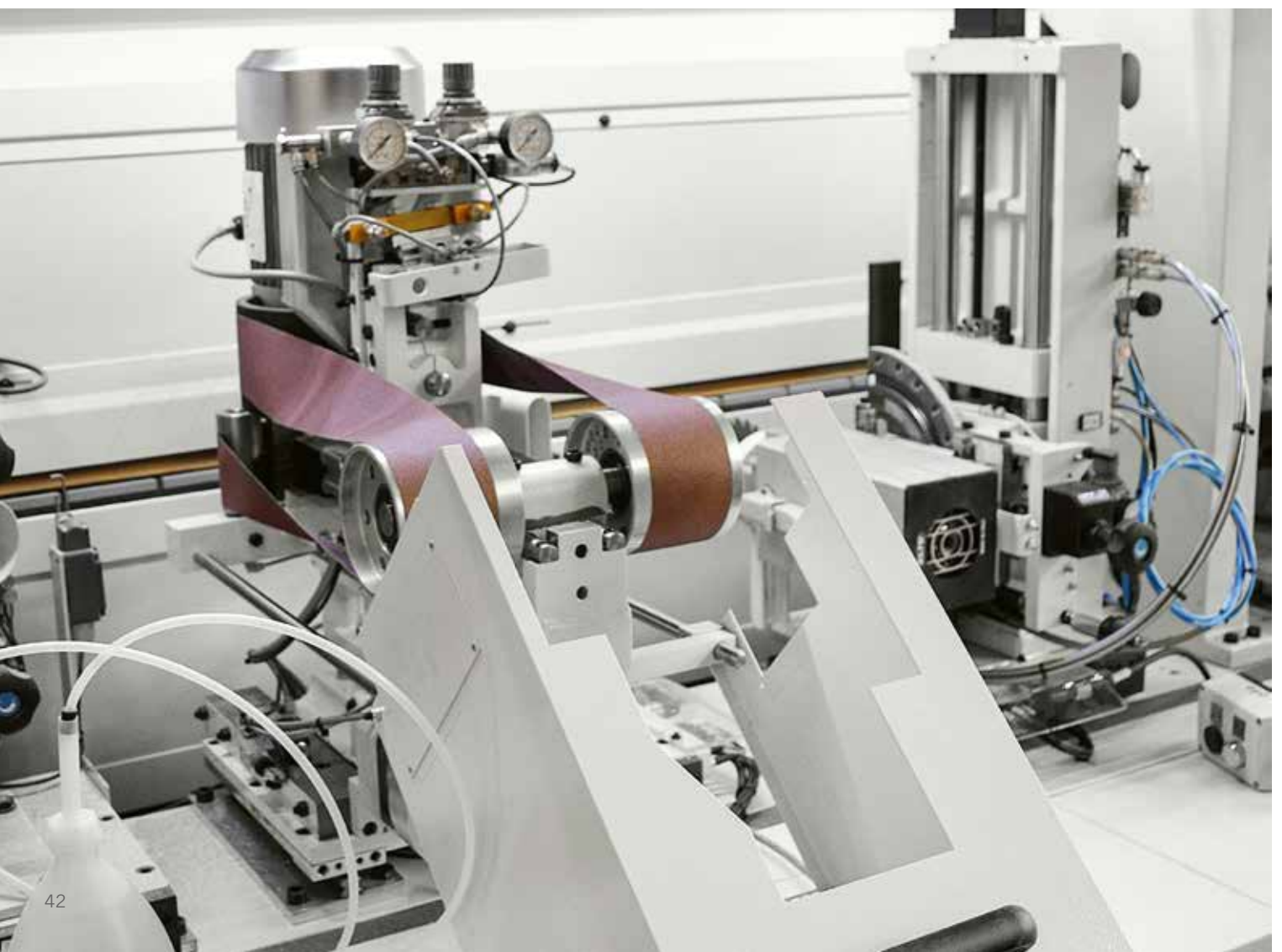

**stefani xd**  
electronic single sided edge bander





# FINISHING



## RCA/2C-L GLUE SCRAPING UNIT

Working unit for removing any micro-residual glue on the junction line.

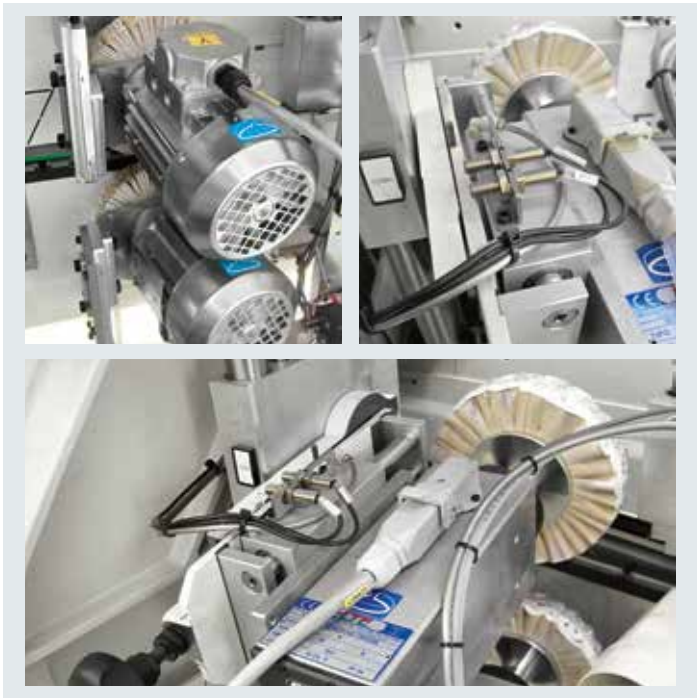

## SPE AND SP/F BRUSHING UNITS

Rotating brush device for the brightening and the final cleaning of the applied edge.



## PH/1600 EDGE BRIGHTENING UNIT

Hot air blowing device for raising the edge quality of the ABS edge in the case of highly pigmented materials.

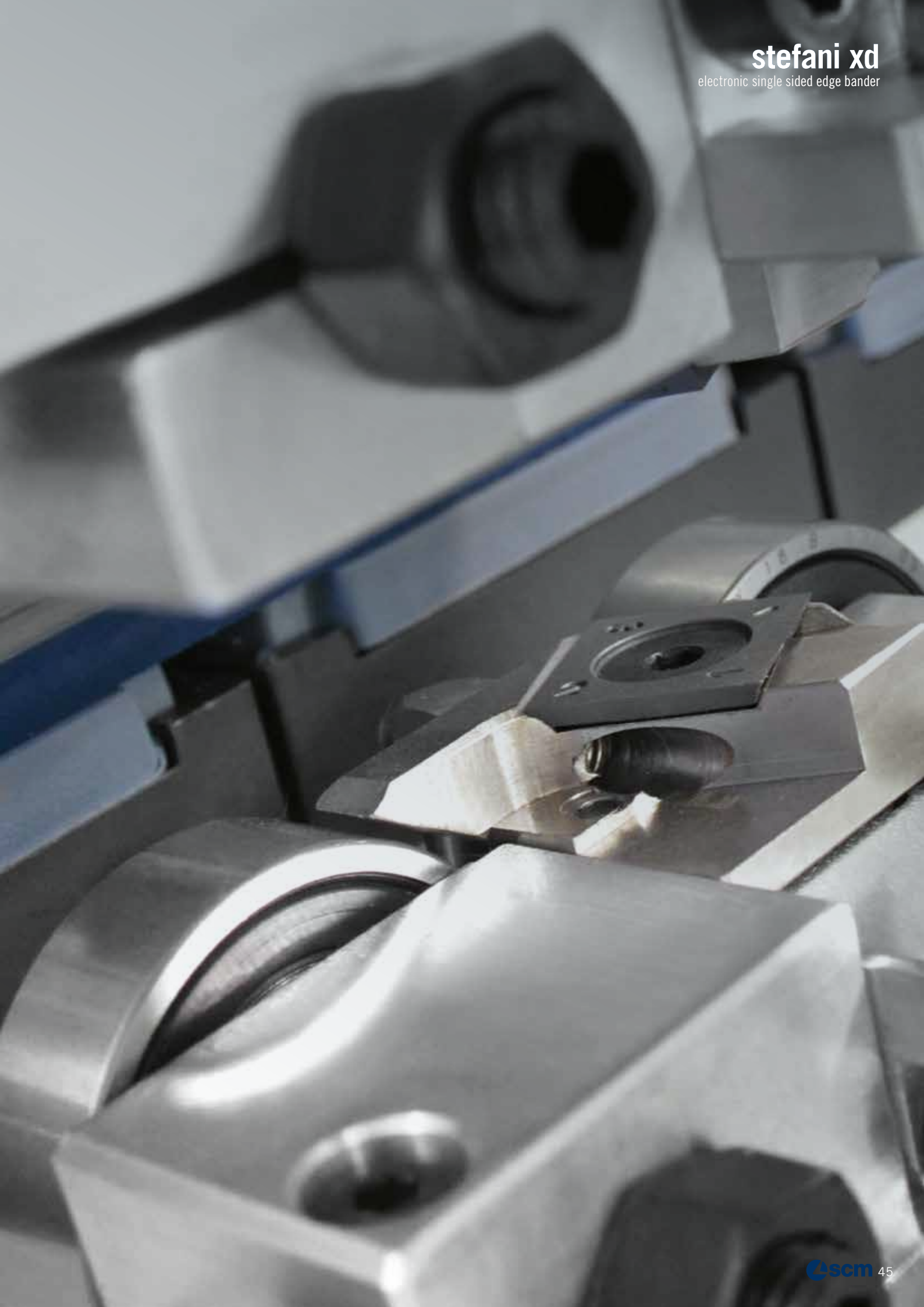



# M Maestro Digital Systems

SMART SOFTWARE AND DIGITAL SERVICES TO ENHANCE PRODUCTIVITY OF WOODWORKING AND FURNITURE INDUSTRIES.

> programming and data generation

Maestro office

Office

Factory

Maestro active

> edge banding

## SOFTWARE

### Simple, smart and open.

Maestro software are tailored on the machine technology as well as on the entire process. All Maestro software share a common mission:

**easy to use**, so that any operator can easily and confidently learn and use the software

**smart**, with algorithms and computing modules aiming at the best possible result

**open** in order to integrate existing software, and provide customer the coverage of all his process.





SCM accompanies woodworking companies throughout their whole process combining machines with matching software solutions and digital services, with a constant strive to enhance company productivity.

The software solutions powered by SCM are developed to optimize machine usage as well as the entire process, providing integration with the different software existing in the company.

## DIGITAL SERVICES

Transforming the way it delivers services to its customers through digital technologies and particularly, the IoT platform that collects and analyses data coming from the machine, **SCM created a world of services enabled by Maestro connect.**

Meaning that connecting an SCM machine through Maestro connect will let customer subscribe a program of fast-evolving services and access a wide range of benefits that even go beyond the machine experience and will support and assist you through the whole life-cycle of your machine.

### Maestro connect IoT Platform

**1**  
Machine monitoring,  
KPIs, early warning

**2**  
Maintenance  
equipment

**3**  
Predictive  
maintenance

**4**  
Report and historical  
data export to MES

**5**  
Warranty  
extension

**6**  
Augmented  
remote support

**7**  
Smart learning,  
SELF-HEALING,  
video tutorials

**8**  
Asset management  
with e-shop SCM  
Spare Parts





# Maestro edge



Before the production, it is possible to program and generate edge banding programs directly from the office.

## SOFTWARE

Office

## Maestro edge

# PROGRAMMING THE EDGE BANDER DIRECTLY FROM THE OFFICE

### FUNCTIONS

- Display of all the information present in Maestro active edge
- Receipt of machine production reports generated by the Maestro active edge
- Remote programming with creation of new edges and tools

With the same interface of Maestro active edge, the office software Maestro edge allows to:

- edit machine programs directly from the office
- recall, view and modify existing programs in the machine

## Maestro active edge

Maestro active is the new operator interface software which has been unified across all SCM technologies. A single operator can easily and confidently run multiple machines due to controller and interface consistency: regardless the machine, Maestro active maintains the same look&feel, with many identical icons and navigation buttons, thus ensuring the same approach to interaction.

### EASE OF USE

The new interface has been specifically designed and optimized for immediate use via touch screen. Graphics have been redesigned for simple and comfortable navigation, with tablet-like icons on touch screen controller.

### “ZERO” ERRORS

Improved productivity thanks to integrated help and recovery procedures that reduce the possibility of error from the operator’s side.

## SOFTWARE

## Factory

## Maestro active edge

# A REVOLUTIONARY APPROACH TO INTERACT WITH YOUR SCM MACHINE

### FULL CONTROL OF PRODUCTION PERFORMANCES

The creation of customizable reports by operator, shift, program, forecast period (and much more) allows to monitor, optimize and improve the production performance.

### FULL MACHINE AWARENESS AND KNOWLEDGE MANAGEMENT SYSTEM

Maestro active allows to record the times related to setup, maintenance, training and other events, tracing all the activities in a database. The operator’s know-how is also stored and made available to other people inside the organization thanks to the possibility to comment and document all production events or notifications.

### ORGANIZE YOUR PRODUCTION

Maestro active allows to create different users with different roles and authorizations (e.g.: operator, maintainer, administrator, ...). Any user can only execute the functions whose permissions have been assigned to him. It is also possible to define the work shifts on the machine and then detect activities, productivity and events that occurred in each shift.



# A WORLD OF SERVICES FOR GREATER EFFICIENCY

## Maestro connect

### CONNECT YOUR MACHINE AND GAIN ACCESS TO A WORLD OF SERVICES

Connecting your machine through IoT technology, Maestro Connect will let you subscribe a program of fast-evolving services. You will access a wide range of benefits that even go beyond the machine experience and will support and assist you through the whole life-cycle of your machine.

### FASTER SERVICE INTERVENTION AND PROBLEM RESOLUTION

Maestro Connect provides real time data and Health Records of the Machine also to SCM Service drastically reducing its troubleshooting time.

### WORKING ALWAYS IN PERFECT CONDITIONS

Maestro Connect can provide a full kit of sophisticated sensor devices to detect and warn the operator in case of alarming conditions of the machine.

## DIGITAL SERVICES

### SMART MAINTENANCE: DOWN TIME REDUCTION

Maestro Connect reduces maintenance downtime thanks to:

- Automatic maintenance notifications and scheduling, to prevent failures and work in the best conditions of use
- Direct connection to SCM Service thanks to an automatic ticket opening function

### SMART MACHINE: ANYTIME, ANYWHERE AWARENESS

Connecting your SCM machine also means having your machine always at hand.

Immediate instant notifications in case of alarms or downtimes allow customers to immediately take an action thus optimizing his productivity.

### SMART MANAGEMENT: PRODUCTION PERFORMANCE OPTIMIZATION

Reports and KPIs allow further analysis thus increasing Customer Knowledge about his performance and results.

### SMART PARTS: FAST PARTS REPLENISHMENT

MRepairs are scheduled proactively since the system provides Spare Parts suggestions and a direct Integration with Smart Parts e-shop.

### SMART LEARNING: EXECUTE WORK AND RECEIVE PROBLEM SOLVING SUPPORT

Maestro connect provides an intuitive Problem Solving Management System to help the operator to self solve any issue..

### SMARTECH: FASTER AUGMENTED SUPPORT

Maestro connect allows augmented reality support by means of Smartech: the head-wearable computers with wireless connectivity that will bring the interaction between customer and SCM service to a higher level.

### SMART WARRANTY: YOUR MACHINE ALWAYS IN PERFECT CONDITIONS

Together with scheduled maintenance contracts, you can take care of your asset by doubling the warranty from 1 year to 2 years\* for complete peace of mind!

\* Please read the complete contract to understand terms and conditions.

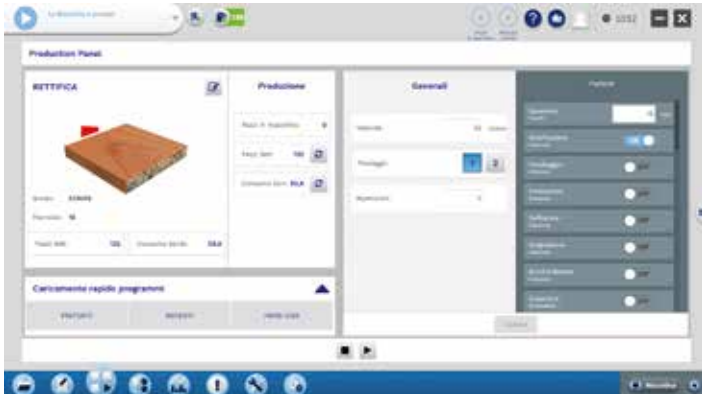

### PRODUCING IN SMART MODE

Operator interface with immediate and intuitive panel programming thanks to the adaptive 3D design of the processing with real time preview. Customization of the “production panel” page with the main functions (favorites) and quick recall of the main working programs.

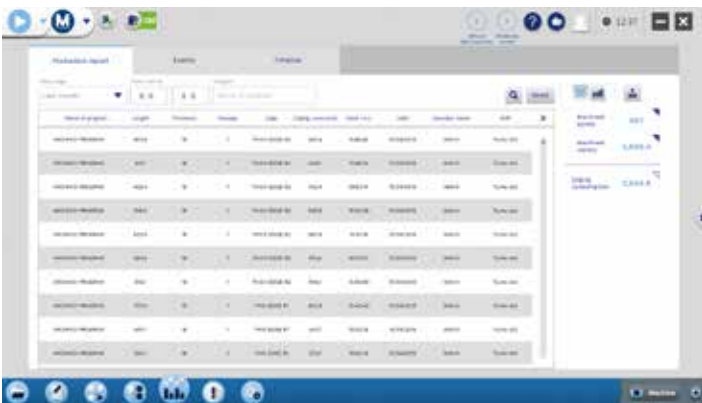

### MAXIMUM EFFICIENCY POSSIBLE

Automatic and continuous diagnostics of every functional aspect of the machine. Automatic alerts for scheduled maintenance.

### BUSINESS ALWAYS UNDER CONTROL

Immediate and profiled production reports per operator, shift, program etc, and instant sharing with the company network.

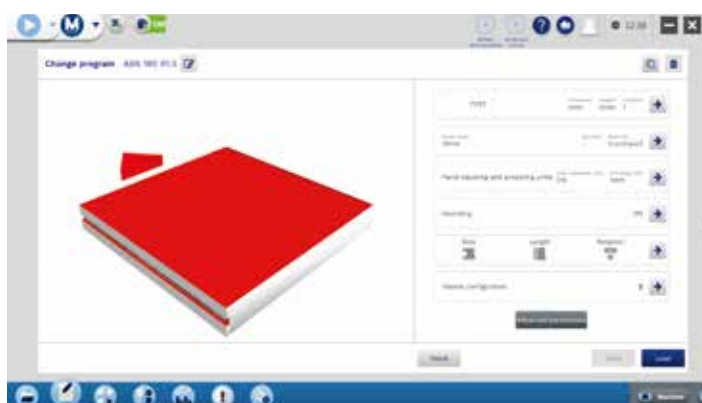

### 3D DESIGN

All set machinings are displayed in real time and with a realistic preview of the virtual panel (slots, texture of edges and surfaces, edges thickness, solid wood).



### SIMPLE AS A TOUCH

Production management directly by Bar code and label. The “Side Finder” application provides an immediate preview of the correct panel side to be inserted into the machine to complete the machining sequence.

# COMPOSITIONS

## FEED SPEED UP TO 25 m/min

- thin edge 1<sup>st</sup> pass + 2<sup>nd</sup> pass - 25 m/min
- thick edge only 1<sup>st</sup> pass: comp. E - 25 m/min

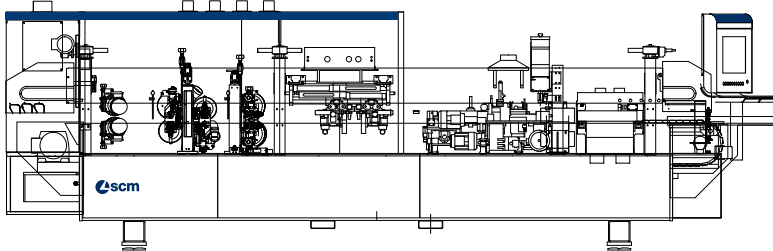

Stefani XD D

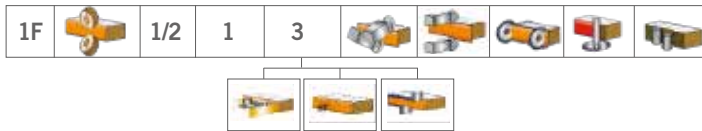
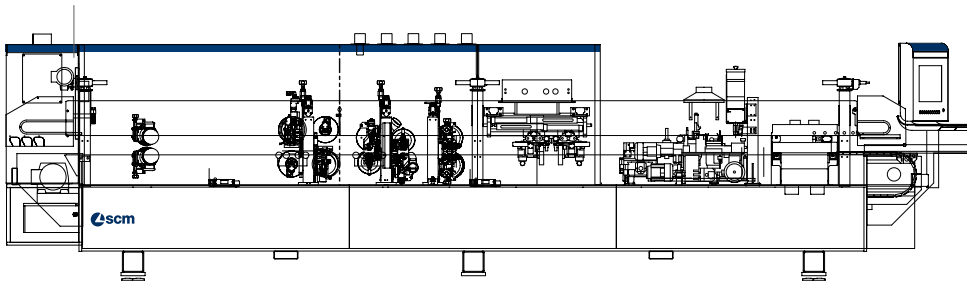

Stefani XD E+

## FEED SPEED UP TO 25 m/min

- thin edge 1<sup>st</sup> pass + 2<sup>nd</sup> pass - 25 m/min
- thick edge 1<sup>st</sup> pass + 2<sup>nd</sup> pass - 25 m/min

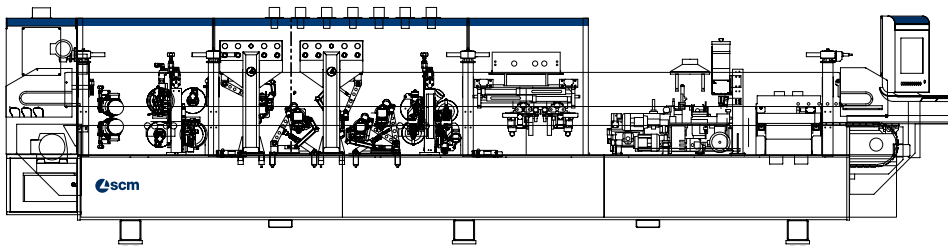

Stefani XD G



**FEED SPEED UP TO 25 m/min**

- thin edge 1<sup>st</sup> pass + 2<sup>nd</sup> pass - 25 m/min
- thick edge 1<sup>st</sup> pass + 2<sup>nd</sup> pass - 25 m/min

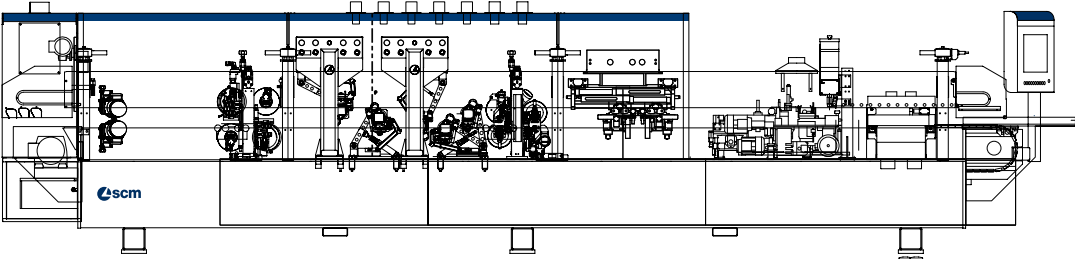

Stefani XD G+

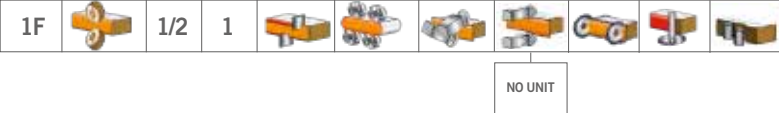
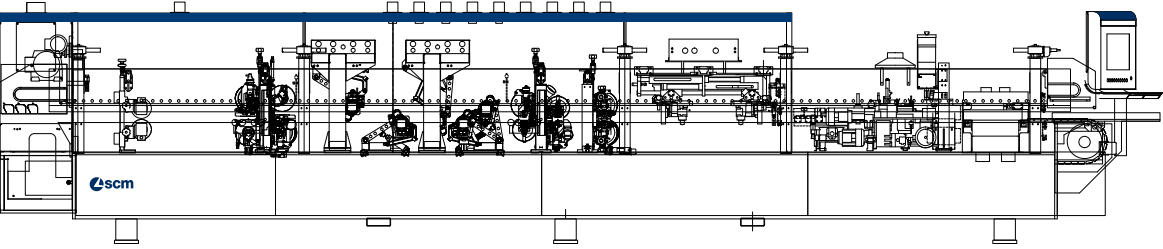

Stefani XD W+

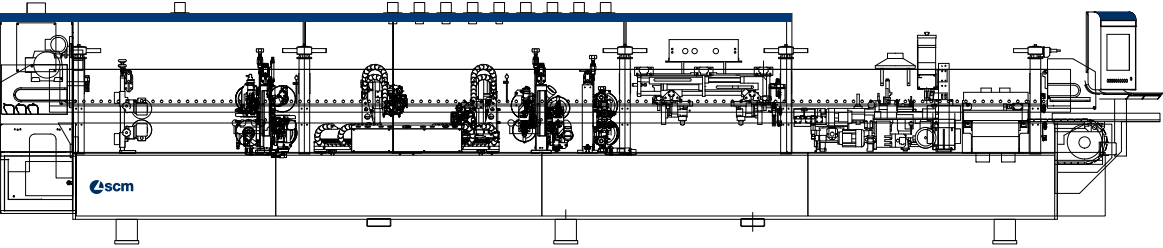

Stefani XD Z+

# COMPOSITIONS

## FEED SPEED UP TO 30 m/min

- thin edge 1<sup>st</sup> pass + 2<sup>nd</sup> pass
- thick edge 1<sup>st</sup> pass

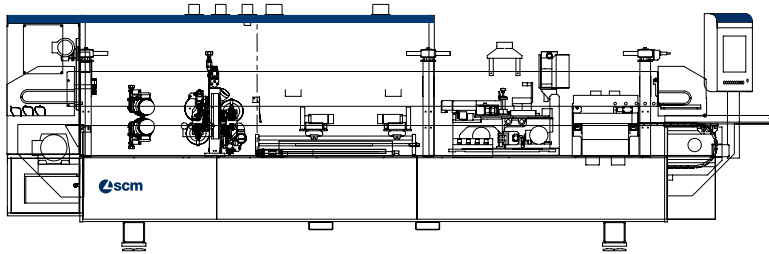

Stefani XD L

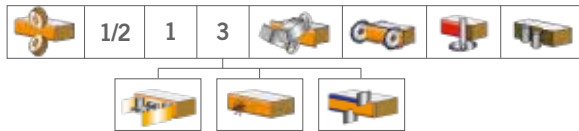
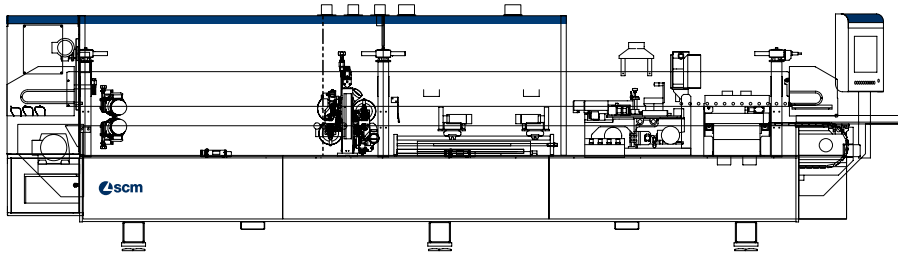

Stefani XD L+

## FEED SPEED UP TO 30 m/min

- thin edge 1<sup>st</sup> pass + 2<sup>nd</sup> pass
- thick edge 1<sup>st</sup> pass + 2<sup>nd</sup> pass

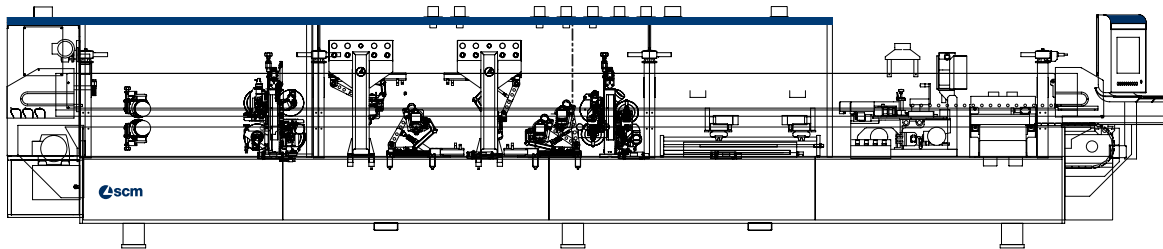

Stefani XD M+

## OPTIONAL UNITS



**stefani xd**

electronic single sided edge bander





# TECHNICAL DATA

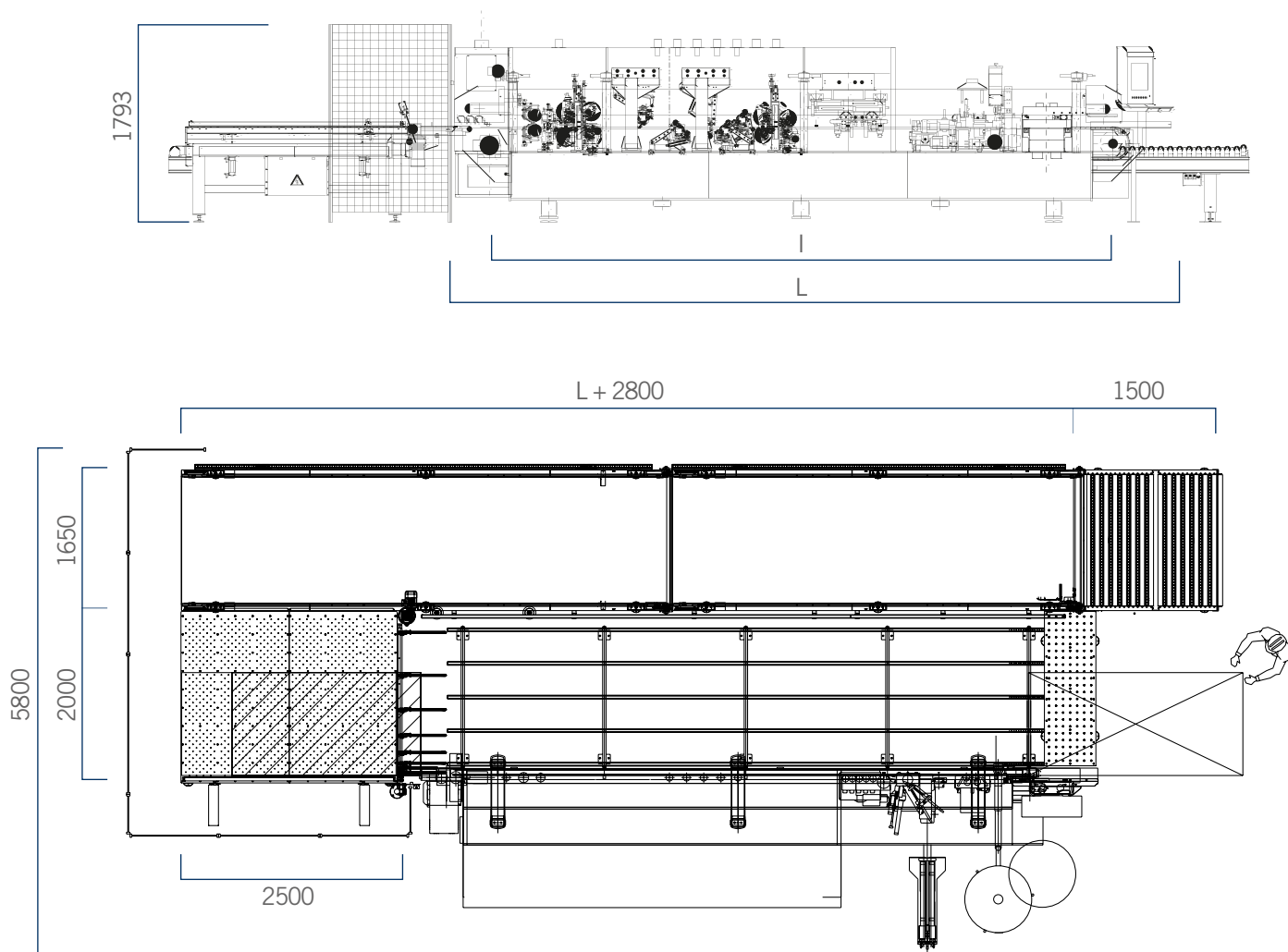

STEFANI XD		D	E+	G	G+	W+	Z+	L	L+	M+
Interaxis (I)	mm	4800	6300	6300	6800	7800	7800	4800	5800	8300
Length (L)	mm	5750	7250	7250	7750	8750	8750	5750	6750	9250

## TECHNICAL DATA

Max speed (depending on the machine equipment)	m/min	10-30
Panel thickness	mm	8 - 45 std 8 - 60 opt 8 - 80 opt
Coil edge thickness	mm	0,3 - 3
Strip edge thickness	mm	0,3 - 22
Minimum panel length with coil edge	mm	145
Minimum panel length with solid wood edge	mm	200
Minimum panel width (with 250 mm minimum length)	mm	95
Minimum panel width with kit for narrow pieces	mm	60

TYPE OF EDGE		
Type of edge	Example of application	Max thickness (mm)
Paper	Raw/prepainted	10-30 8 - 45 std 8 - 60 opt
Melamine	Raw/prepainted	8 - 80 opt
Plastic in coil	ABS, PVC, PP (with/without film) PMMA (polished or rough to polish / smooth)	0,3 - 3
Precut strips	Veneer, PC, Unicolor	0,3 - 22
Solid wood	Raw/sanded	145
Pre-glued plastic edge	AirFusion+ application	200
Coextruded plastic edge	AirFusion+ application	60

TYPE OF PANELS	
Type of panels	Example of application
Chipboard	
MDF/HDF	Only profiled/edged
Hollow-core / light panel	With frame/without frame
Solid wood	Only sanded
Other materials	Aluminium/Cardboard/PC/honeycomb

GLUES	
EVA glue	
PU glue	
CONNECTIVITY	
Ethernet	std
USB	std
Wi-Fi	opt



## ENERGY ONLY WHEN NEEDED

**SavEnergy** allows the operation of the devices only when really necessary. The machine automatically enters stand-by mode when there are no panels to be machined.

#### CONSUMPTION/POWER

Supply voltage: 400 V/50 Hz EU (customizable depending on the country)

Installed power (kW): depending on the machine equipment

Compressed air consumption (NL / min): depending on the machine equipment

Suction: air speed 30 m/sec

Suction: air consumption (m3/sec): depending on the machine equipment

Suction: exhaust outlet diameter from 80 mm to 140 mm

**COMPANY WITH  
QUALITY SYSTEM  
CERTIFIED BY DNV GL  
= ISO 9001 =**

*The technical data can vary according to the requested machine composition. In this catalogue, machines are shown with options. The company reserves the right to modify technical specifications without prior notice; the modifications do not influence the safety foreseen by the EC Norms.*

Maximum noise levels measured according to the operating conditions established by EN ISO 18217:2015

Acoustic pressure in process 79 dbA (measured according to EN ISO 11202:2010, uncertainty K≤4 dB)

Acoustic power in process 97 dbA (measured according to ISO 3746:2010, uncertainty K≤4 dB)

Even if there is a correlation between above mentioned "conventional" noise emission values and average levels of personal exposure over eight hours of operators, these last also depend on the real operating conditions, duration of exposure, acoustic conditions of the working environment and presence of further noise sources, this means the number of machines and other adjacent process.

# PROMPT AND EXPERT TECHNICAL SUPPORT THROUGH A NETWORK OF 1000 TECHNICIANS AND AN INVENTORY OF 36,000 SPARE PARTS.

HIGHLY SPECIALISED TECHNICIANS, EFFICIENT MANAGEMENT AND 6 SPARE PARTS BRANCHES AROUND THE WORLD GUARANTEE A CLOSE, SAFE AND EFFECTIVE TECHNICAL SUPPORT.

## SERVICE

SCM provides a service that goes beyond the purchase, to guarantee the long term performance of your technological production system and peace of mind for your business.

### A COMPLETE RANGE OF AFTER-SALES SERVICES

- installation and start-up of machines, cells, lines and systems
- tailored training programs
- telephone support to reduce times and costs when machines are not working
- preventive maintenance programs to guarantee long term performance
- complete renovation of machines and plants to renew the added value of the investments
- custom upgrading to update machines and plants and meet new production requirements

## SPARE PARTS

SCM Group can count on 140 spare parts professionals worldwide to meet any request with real time shipments.



### 36,000 SPARE PARTS

Our spare parts inventory, with a value of 12 million euros, covers every single machine



### SPARE PARTS GUARANTEED

We guarantee also hard to find parts, with 3,5 million euros invested in "critical" spare parts.



### IMMEDIATE AVAILABILITY

Over 90% of orders received are carried out the same day thanks to the huge inventory available.



### 6 BRANCHES AROUND THE WORLD

The spare parts service can count on worldwide support (Rimini, Singapore, Shenzhen, Moscow, Atlanta, São Bento do Sul)



### 500 SHIPMENTS A DAY





# THE STRONGEST WOOD TECHNOLOGIES ARE IN OUR DNA

## SCM. A HERITAGE OF SKILLS IN A UNIQUE BRAND

Over 65 years of success gives SCM the centre stage in woodworking technology. This heritage results from bringing together the best know-how in machining and systems for wood-based manufacturing. SCM is present all over the world, brought to you by the widest distribution network in the industry.

**65** years history

**3** main production sites in Italy

**300.000** square metres of production space

**20.000** machines manufactured per year

**90%** export

**20** foreign branches

**400** agents and dealers

**500** support technicians

**500** registered patents

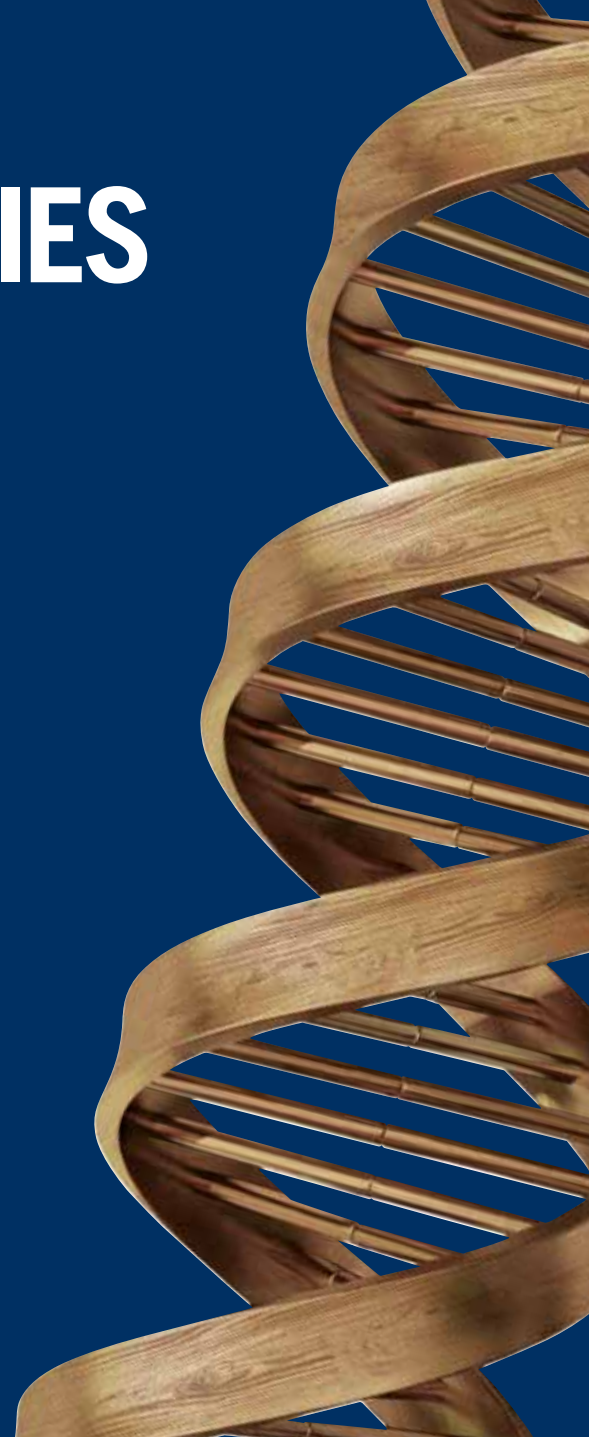

In SCM's DNA also strength and solidity of a great Group. The SCM Group is a world leader, manufacturing industrial equipment and components for machining the widest range of materials.

## SCM GROUP, A HIGHLY SKILLED TEAM EXPERT IN INDUSTRIAL MACHINES AND COMPONENTS

### INDUSTRIAL MACHINERY

Stand-alone machines, integrated systems and services dedicated to processing a wide range of materials.



WOODWORKING TECHNOLOGIES



TECHNOLOGIES FOR PROCESSING COMPOSITE MATERIALS, ALUMINIUM, PLASTIC, GLASS, STONE, METAL

### INDUSTRIAL COMPONENTS

Technological components for the Group's machines and systems, for those of third-parties and the machinery industry.



SPINDLES AND TECHNOLOGICAL COMPONENTS



ELECTRIC PANELS



METALWORK



CAST IRON



*is more*



**SCM GROUP SPA - STEFANI**

viale del lavoro 1/3 - 36016 Thiene (VI) - Italy  
tel. +39 0445 359511  
stefani@scmgroup.com  
www.scmwood.com



00L0487714E