



AQUATEC® BATH LIFTS



Yes, you can.®





The Aquatec Bath Lift family provides **quality and durable bath lifts** that are designed to help provide **comfort, safety,** and reassurance to those most in need of support as they bathe.

Comfortable, safe and highly efficient

The *Aquatec Bath Lifts* have been **designed with the user in mind**, giving a comfortable and straightforward bathing experience. Key features include:

- Reclining backrest
- Integrated head support
- Quick release hand control
- Battery with Sony™ technology
- Auto unlock for quick removal from bath
- Backrest recline up to 40°
- 3 models available:

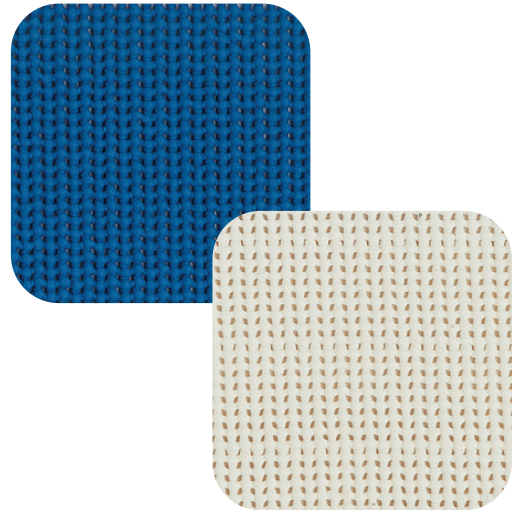

Aquatec R

- ▶ Entry-Level Aquatec Bath Lift
- ▶ Recline up to 40°
- ▶ Minimum Seat Height 2.5"
- ▶ Weight Capacity 300 lbs.
- ▶ **1573972** (blue),
1573877 (white)



Aquatec SRB

- ▶ Lateral Side Supports for Added Safety
- ▶ Recline up to 40°
- ▶ Minimum Seat Height 2.5"
- ▶ Weight Capacity 300 lbs.
- ▶ **1573999** (blue),
1573878 (white)



Aquatec XL

- ▶ Entry-Level Aquatec Bath Lift
- ▶ Recline up to 40°
- ▶ Minimum Seat Height 2.5"
- ▶ Weight Capacity 375 lbs.
- ▶ **1573862** (white)

Features and options



Textured seating surface

The *Aquatec Bath Lift* has a textured surface **allowing use without covers** if desired. The side flaps are hinged flush to the main seating surface and **help enable comfortable and safe side transfers**, without entrapment of skin.



Two-piece design

When pushed forward the *Aquatec Bath Lift* backrest folds down and automatically unlocks. The backrest and base section **can then be removed from the bath with ease**. The two sections fit neatly into one another to **give a compact size for storage**.



Easy to clean

The open, clean-cut design of the *Aquatec Bath Lift* combines with its smooth surfaces to offer nearly **effortless cleaning**. The durable soft cover is machine washable using a mild detergent at 140°F.

Accessories for *Aquatec Bath Lifts*



Height adaptors

The *Bath Lift* can be adapted to suit a full range of bath heights. The 0.75", 1.5" or 2.25" height adapters can be quickly fitted to the bath lift base.

15170 Height adapter 0.75" (4 pcs.) incl. conversion kit
14694 Height adapter 0.75" (4 pcs) Extension kit without conversion kit

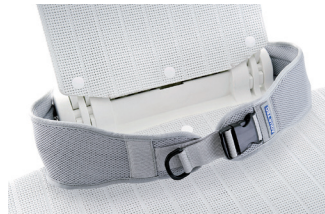

Positioning Strap

Padded, adjustable strap for the chest or waist.

1528702



Transport Bag with Casters

Ideal for easy transport and storage. Complete with roller casters.

14586AQT



Extra Large Suction Cups

Adapt to any of the *Aquatec* bath lifts. Helps provide stability and helps enable secure suction on treaded and uneven surfaces.

16240AQT
(set of 4 per set)

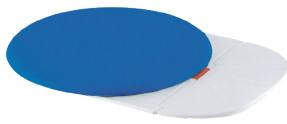

Transfer Board with Rotary Disk

For easy transfers, minimal shearing and effortless turning into desired position. 300 lb. capacity.
4.03.002 - Blue



Rotary Disk

14" diameter seat area with soft seating surface. Easy to clean, just wipe off. 300 lb. capacity.
4.02.002 - Blue

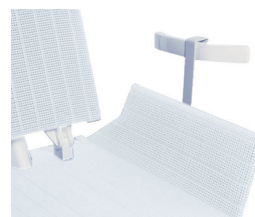

Sideflap Diverter

Used to position sideflap away from grab bars and soap dishes that may be mounted inside of the tub.
15309



Step Stool

Provides assistance getting in and out of the bath. Features non-slip feet and removable, non-slip cover. 17" L x 10 1/2" W x 6" H
3.00.002

Accessories for *Aquatec Bath Lifts*



Pommel

Helps prevent slipping forward on the seat surface. Available in blue.
 Model no. 1525932,
 2.5" (7 cm)
 Model no. 1525933,
 4.75" (12 cm)

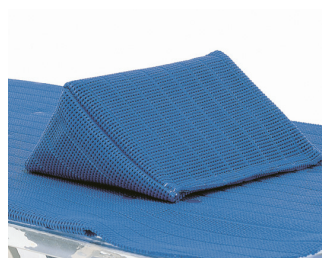

Foam/Sand Wedge Cushion

Used as seating support under knees or thighs to aid in proper positioning.
 Model no. 13694 - White sand
 Model no. 13693 - Blue sand

Technical data

	<i>Aquatec R</i>	<i>Aquatec XL</i>	<i>Aquatec SRB</i>
Dimensions	1573972 & 1573877	1573862	1573999 & 1573878
Seat width without side flaps	15 in / 375 mm	15 in / 375 mm	15 in / 375 mm
Seat width with side flaps	28 in / 715 mm (A)	28 in / 715 mm (A)	28 in / 715 mm (A)
Seat depth	19 in / 490 mm (B)	19 in / 490 mm (B)	19 in / 490 mm (B)
Seat height max.	16.5 in / 420 mm (C)	16.5 in / 420 mm (C)	16.5 in / 420 mm (C)
Seat height min.	2.5 in / 60 mm	2.5 in / 60 mm	2.5 in / 60 mm
Width of backrest	14 in / 360 mm (D)	14 in / 360 mm (D)	14 in / 360 mm (D)
Height of backrest	26 in / 665 mm (E)	26 in / 665 mm (E)	26 in / 665 mm (E)
Total depth (backrest upright)	25.5 in / 650 mm (F)	25.5 in / 650 mm (F)	25.5 in / 650 mm (F)
Total depth (backrest reclined)	36 in / 920 mm	36 in / 920 mm	36 in / 920 mm
Total height with backrest	42 in / 1075 mm (G)	42 in / 1075 mm (G)	42 in / 1075 mm (G)
Base area	23 in x 11.5 in / 580 x 295 mm	23 in x 11.5 in / 580 x 295 mm	23 in x 11.5 in / 580 x 295 mm
Cover thickness	.12 in / 3 mm	.12 in / 3 mm	.12 in / 3 mm
More info			
Total weight without hand control	24 lbs / 10.8 kg	25.5 lbs / 11.6 kg	25.5 lbs / 11.6 kg
Total weight without battery pack	-	-	-
Weight, seat	14.5 lbs / 6.6 kg	16 lbs / 7.4 kg	14.5 lbs / 6.4 kg
Weight, backrest	9 lbs / 4.2 kg	9 lbs / 4.2 kg	11 lbs / 5 kg
Weight, hand control	14 oz / 0.4 kg	14 oz / 0.4 kg	14 oz / 0.4 kg
Weight, battery pack	-	-	-
Load capacity	300 lbs / 140 kg	375 lbs / 170 kg	300 lbs / 140 kg
Backrest can be reclined by up to	40°	40°	40°
Color	Blue (1573972) White (1573877)	White (1573862)	Blue (1573999) White (1573878)

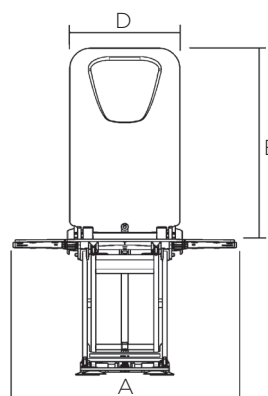
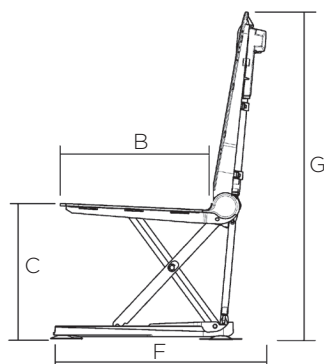

Invacare Corporation
www.invacare.com

USA
 One Invacare Way
 Elyria, Ohio
 44035- 4190
 (800) 333-6900

Canada
 570 Matheson Blvd. E.,
 Unit 8
 Mississauga, Ontario
 L4Z 4G4 Canada
 (800) 668-5324



Yes, you can.™