



ENT



HNO Hauptkatalog
ENT Main Catalog

Catalogue Général ORL
Catálogo General ORL
Catalogo Generale ORL

Kataloge
Catalogues
Catalogues
Catálogos
Cataloghi

Endoskopie
Endoscopy
Endoscopia
Endoscopia
Endoscopia



Geräte
Units
Appareils
Equipos
Apparecchi

ENDOSCOPY No. **205**



Sinuskopie
Sinuscopy
Sinuscopie
Sinuscopía
Sinuscopia

ENDOSCOPY No. **211**



Optiken
Scopes
Optiques
Ópticas
Ottiche

ENDOSCOPY No. **206**



Mini & Mikro System für MIC
Mini & micro system for MIS
Système mini & mikro pour MIC
Sistema mini y micro para MIC
Sistema mini e micro per MIC

ENDOSCOPY No. **213**



Laparoskopie
Laparoscopy
Laparoscopie
Laparoscopia
Laparoscopia

ENDOSCOPY No. **207**

Sterilisation
Sterilization
Stérilisation
Esterilización
Sterilizzazione



Urologie
Urology
Urologie
Urología
Urologia

ENDOSCOPY No. **208**



Steril Container - System I
Sterile container - system I
Contenaires pour stérilisation - système I
Contenedores para esterilización - sistema I
Container per sterilizzazione - sistema I

STERILIZATION No. **302**

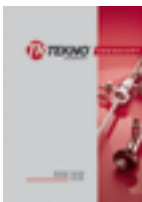

Gynäkologie
Gynaecology
Gynécologie
Ginecología
Ginecologia

ENDOSCOPY No. **209**



Steril Container - System II
Sterile container - system II
Contenaires pour stérilisation - système II
Contenedores para esterilización - sistema II
Container per sterilizzazione - sistema II

STERILIZATION No. **303**



Arthroskopie
Arthroscopy
Arthroscopie
Artroscopia
Artroscopia

ENDOSCOPY No. **210**

Kataloge | Catalogues
 Catalogues | Catálogos
 Cataloghi

Chirurgie | Chirurgie
 Surgery | Cirugía
 Chirurgia



Hauptkatalog Chirurgie
Main catalogue surgery
 Catalogue général
Catálogo general
 Catalogo generale

SURGERY No. 111



Aneurismen Clips
Aneurysm clips
 Clips pour anévrismes
Clips para aneurismas
 Clips per aneurismi

SURGERY No. 134



Plastische Chirurgie
Plastic surgery
 Chirurgie plastique
Cirugía plástica
 Chirurgia plastica

SURGERY No. 112



HNO Hauptkatalog
ENT main catalogue
 ORL catalogue général
ORL catálogo general
 ORL catalogo generale

ENT No. 501



Ophthalmologie
Ophthalmology
 Ophthalmologie
Oftalmología
 Oftalmologia

SURGERY No. 113

Elektro Chirurgie | Eléctrochirurgie
 Electro surgery | Electro-Cirugía
 Elettrobisturi



Traumatologie
Traumatology
 Traumatologie
Traumatología
 Traumatologia

SURGERY No. 114



Elektro Chirurgie
Electro surgery
 Eléctrochirurgie
Electro-Cirugía
 Elettrobisturi

ELECTRO SURGERY No. 212



Gefäßschirurgie
Vascular surgery
 Chirurgie vasculaire
Cirugía vascular
 Chirurgia vascolare

SURGERY No. 115

Dental | Dentaire
 Dental | Dental
 Dentale

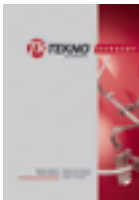

Retraktor Systeme
Retractor systems
 Systèmes des écarteurs
Sistema de retractores
 Sistemi di retrattori

SURGERY No. 133

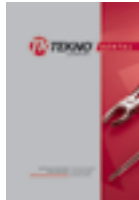

Dental
 Dental
 Dentaire
 Dental
 Dentale

DENTAL No. 402

Inhalt
Content

Contenu
Indice
Indice

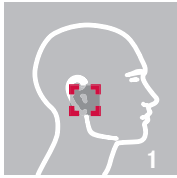

Otologie
Otology
Otologie
Otología
Otología

8 - 38

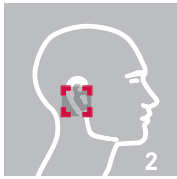

Ohr Mikrochirurgie
Ear microsurgery
Micro chirurgie pour l'oreille
Micro cirugía para el oído
Microchirurgia dell'orecchio

39 - 62

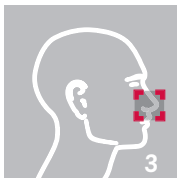

Rhinologie
Rhinology
Rhinologie
Rinología
Rinologia

63 - 94

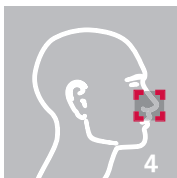

Nasenplastik
Rhinoplasty
Rhinoplastique
Rinoplastica
Rinoplastica

95 - 118

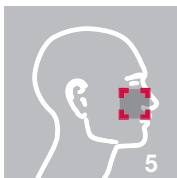

Sinuskopie
Sinuscopy
Sinuscopie
Sinuscopía
Sinuscopia

119 - 136

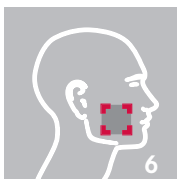

Adenotomie - Tonsillektomie
Adenotomy - Tonsillectomy
Adénotomie - Amigdalotomie
Adenotomía - Amigdalotomía
Adenotomia - Tonsillectomia

137 - 158

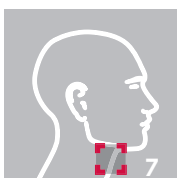

Laryngologie
Laryngology
Laryngologie
Laringología
Laringologia

159 - 182

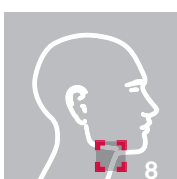

Tracheotomie
Tracheotomy
Trachéotomie
Traqueotomía
Tracheotomia

183 - 188

Inhalt | **Contenu**
Content | **Indice**
Indice

	<p>Broncho-Oesophagoskopie <i>Broncho-oesophagoscopy</i> Broncho-oesophagoscopie <i>Bronco-esofagoscopia</i> Bronco-esofagoscopia</p>	<p>189 - 196</p>
	<p>Allgemeines Instrumentarium <i>General surgical instruments</i> Instruments généraux <i>Instrumental general</i> Strumentario generale</p>	<p>197 - 312</p>
	<p>Endoskopie <i>Endoscopy</i> Endoscopie <i>Endoscopia</i> Endoscopia</p>	<p>313 - 342</p>
	<p>Elektro Chirurgie <i>Electro surgery</i> Eléctrochirurgie <i>Electrocirugia</i> Elettrochirurgia</p>	<p>343 - 348</p>
	<p>Instrumentensätze <i>Instrument sets</i> Jeux d'instruments <i>Juegos de instrumentos</i> Set di strumenti</p>	<p>349 - 360</p>
	<p>Nummernverzeichnis <i>Numerical Index</i> Index numériques <i>Indice numerico</i> Indice dei numeri d'articolo</p>	<p>361 - 370</p>
	<p>Inhaltsverzeichnis <i>Index</i> Table de matière <i>Indice</i> Indice</p>	<p>371 - 401</p>

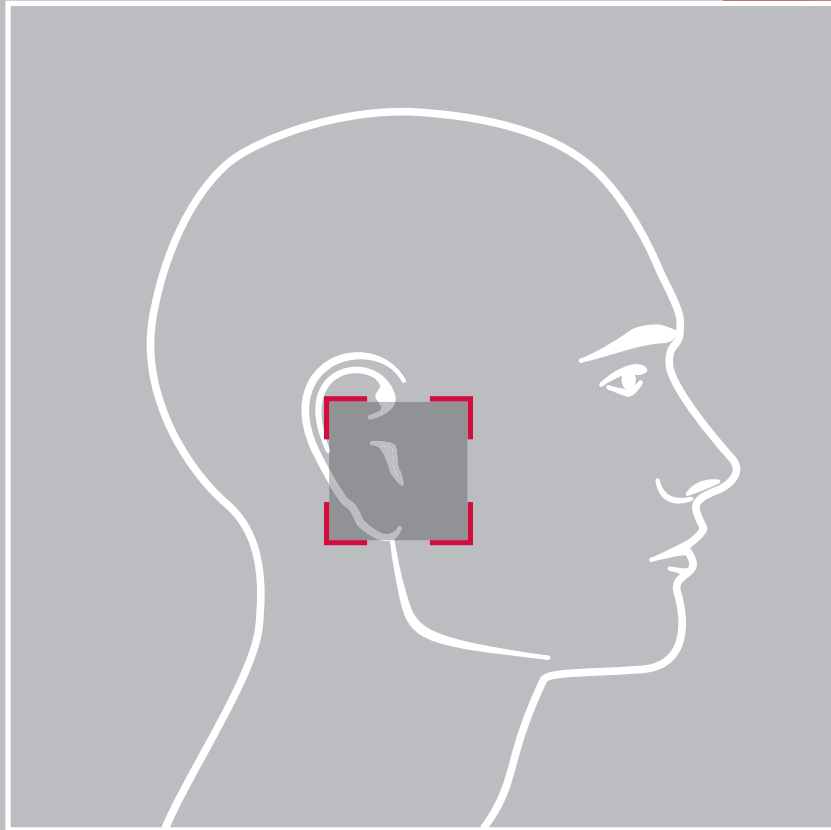

Otologie | Otologie
Otology | *Otología*
Otologia



Otoskope
Otoscopies

Otoscoptes
Otoscopios
Otoscopi

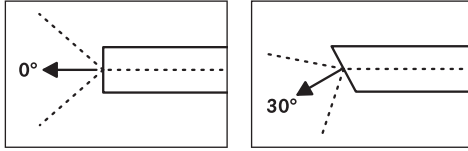

autoklavierbar / autoclavable
134°C / 273°F - 18 min.



Ø 2,7 mm - 50 mm	tk 700-080	tk 700-083
Ø 4,0 mm - 50 mm	tk 700-090	tk 700-093

Ø, Arbeitslänge
Ø, *Working length*

Ø, Longueur de travail
Ø, *Longitud de trabajo*
Ø, Lunghezza operativa

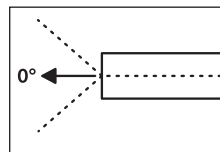

autoklavierbar / autoclavable
134°C / 273°F - 18 min.

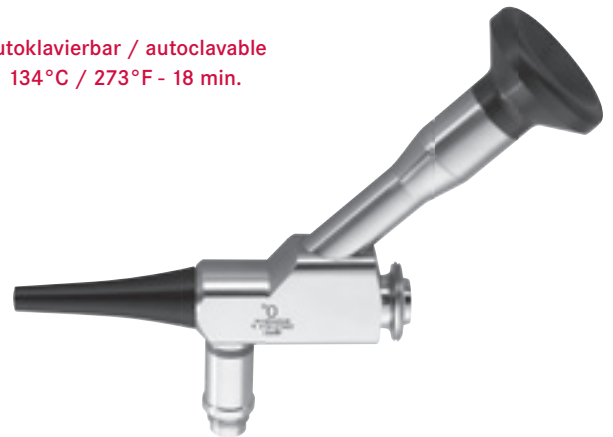

Ø 4,3 mm - 40 mm	Ø 1,8 mm	tk 700-094
------------------	----------	-------------------

Ø, Arbeitslänge
Ø, *Working length*

Ø, Longueur de travail
Ø, *Longitud de trabajo*
Ø, Lunghezza operativa

Instrumentenkanal
Instrument channel
Canal d'instrument
Canal para instrumentos
Canale operativo

tk 4434-00

Otoskop-Besteck
Otoscope set

Trousse à otoscopie
Otoscopio
Otoscopio



Stimmgabeln | Diapasons
 Tuning forks | Diapasones
 Diapason

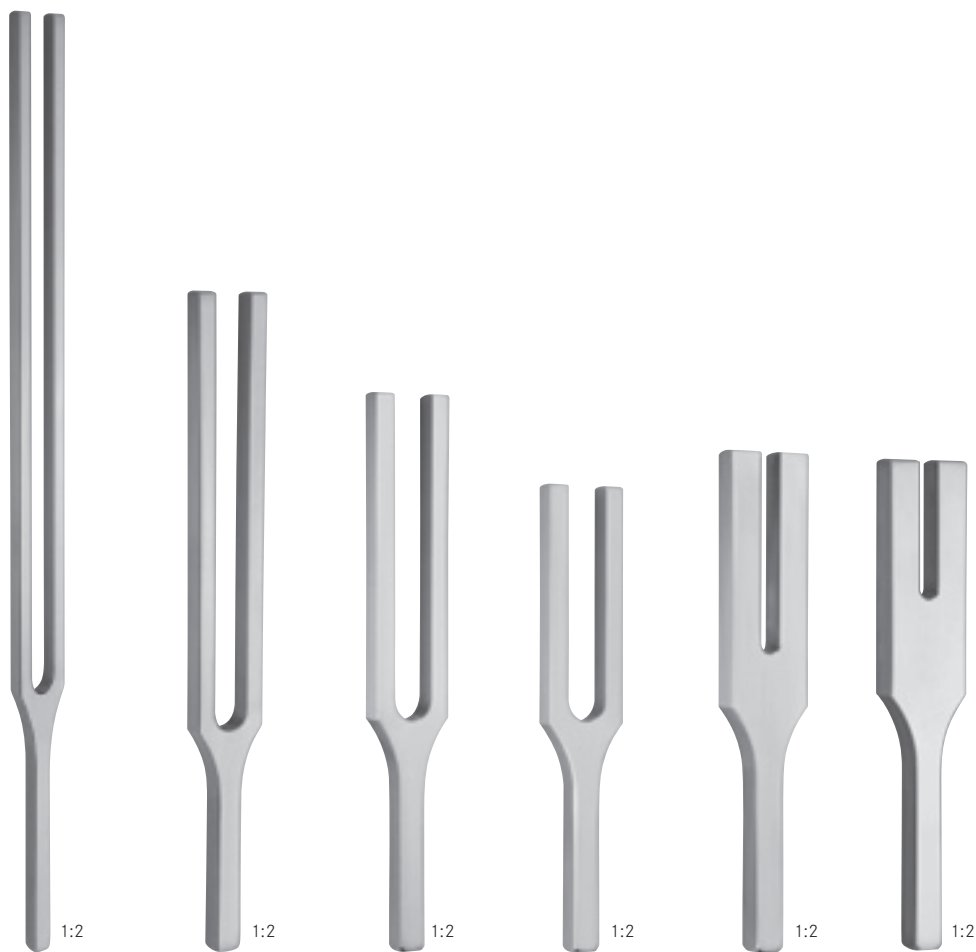

HARTMANN

c 128	c ¹ 256	c ² 512	c ³ 1024	c ⁴ 2048	C ⁵ 4096
tk 50050-10	tk 50052-11	tk 50053-10	tk 50054-12	tk 50056-13	tk 50058-14



HARTMANN

tk 50050-00

Satz im Etui (tk 50045-10, tk 50047-11, tk 50053-10, tk 50054-12, tk 50056-13)

Set in case (tk 50045-10, tk 50047-11, tk 50053-10, tk 50054-12, tk 50056-13)

Jeu en boîte (tk 50045-10, tk 50047-11, tk 50053-10, tk 50054-12, tk 50056-13)

Juego en estuche (tk 50045-10, tk 50047-11, tk 50053-10, tk 50054-12, tk 50056-13)

Serie in astuccio (tk 50045-10, tk 50047-11, tk 50053-10, tk 50054-12, tk 50056-13)

Stimmgabeln | Diapasons
 Tuning forks | Diapasones
 Diapason



LUCAE

c 128

tk 50035-10

verschiebbar bis h
variable up to h (engl. b)
 variable jusqu'à h (franc. si)
 variable hasta h (esp. si)
 regolabile fino a h (ital. si)



RYDEL-SEIFFER

C 64 / c 128

tk 50036-11

mit Dämpfer C 64, ohne Dämpfer c 128
with clamps C 64, without clamps c 128
 avec curseurs C 64, sans curseurs c 128
 con sordinas C 64, sin sordinas c 128
 con cursori C 64, senza cursori c 128

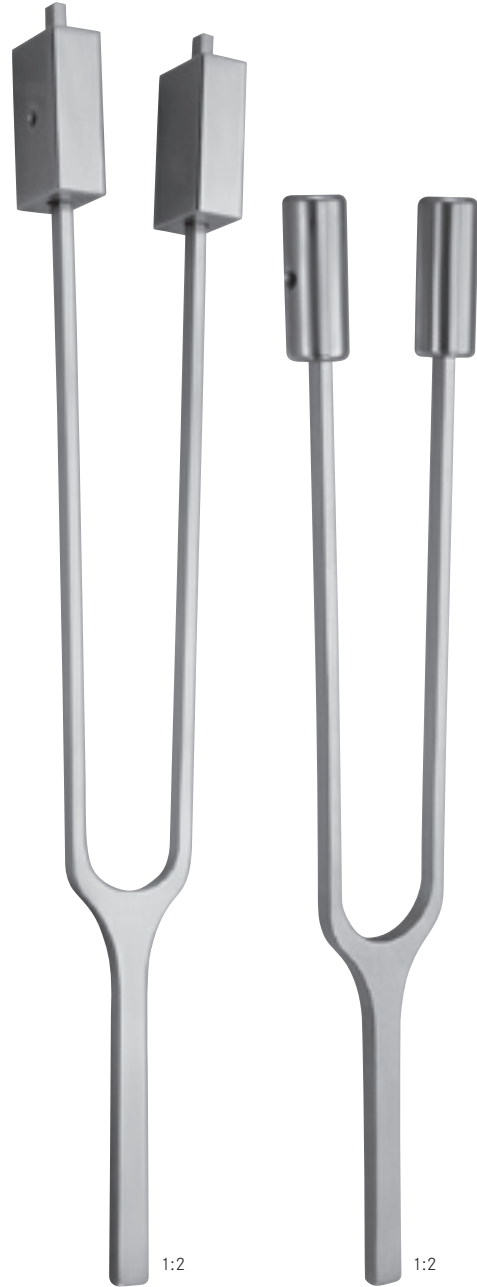

FRENCH

C₂16

tk 50040-07

C₁32

tk 50042-08

Stimmgabeln | Diapasons
 Tuning forks | Diapasones
 Diapason

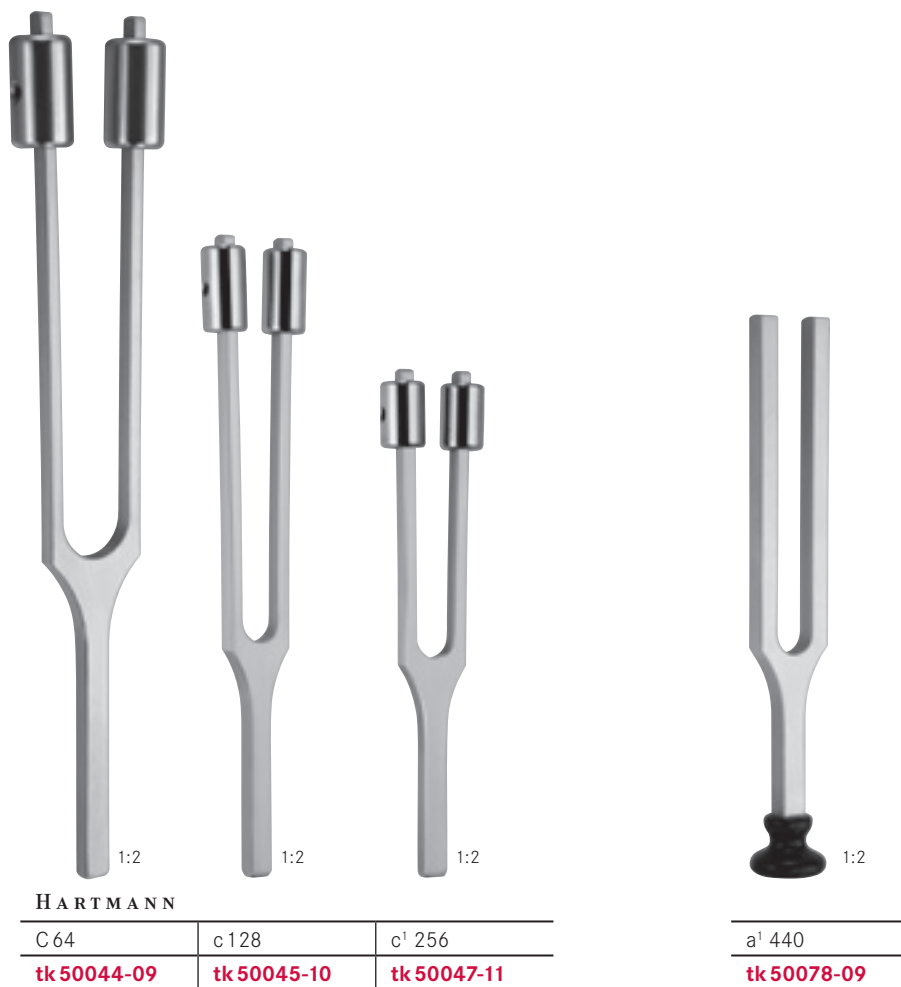

Lärmtrommel | Assourdiseur
 Noise drum | Aparato de ruido
 Assordatore



Stimmgabeln
Tuning forks

Diapasons
Diapasones
Diapason

ALUK



tk 50250-00

Satz im Etui (tk 50250-01 – tk 50250-05)

Set in case (tk 50250-01 – tk 50250-05)

Jeu en boîte (tk 50250-01 – tk 50250-05)

Juego en estuche (tk 50250-01 – tk 50250-05)

Serie in astuccio (tk 50250-01 – tk 50250-05)

Ohrspekula | Spéculums auriculaires
 Ear specula | Espéculos auriculares
 Specoli auricolari



1:1

TOYNBEE	○ 1:1	○ 1:1	○ 1:1	○ 1:1
	Fig. 1	Fig. 2	Fig. 3	Fig. 4
	4.5 mm Ø	5.5 mm Ø	6.5 mm Ø	7.5 mm Ø
36 mm - 1 1/2"	tk 50010-11	tk 50010-12	tk 50010-13	tk 50010-14
tk 50010-03		x	x	x
tk 50010-04	x	x	x	x

Satz, für Erwachsene
 Set, for adults
 Jeu, pour adultes
 Juego, para adultos
 Serie, per adulti

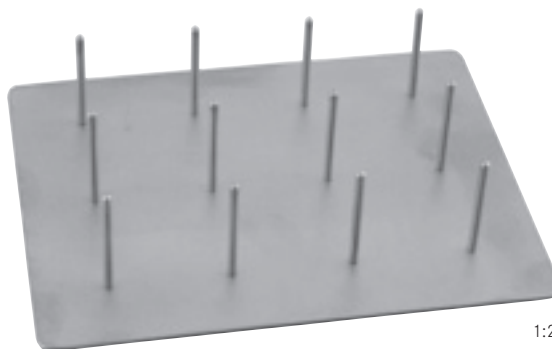

1:2

tk 50027-00

Lager- und Sterilisiergestell
 Storage and sterilizing rack

Support de conservation et stérilisation
 Soporte de conservación et esterilización
 Sostegno per conservare e sterilizzare



1:1

RICHNAU HOLMGREN	○ 1:1	○ 1:1	○ 1:1	○ 1:1
	Fig. 0	Fig. 1	Fig. 2	Fig. 3
	3 mm Ø	4 mm Ø	5 mm Ø	6 mm Ø
	tk 50030-00	tk 50030-01	tk 50030-02	tk 50030-03

Ohrspekula | Spéculums auriculaires
 Ear specula | Espéculos auriculares
 Specoli auricolari



GRUBER	1:1	1:1	1:1	1:1
	Fig. 1	Fig. 2	Fig. 3	Fig. 4
	a = 4.5 mm	a = 5.5 mm	a = 6.5 mm	a = 7.5 mm
	tk 50012-11	tk 50012-12	tk 50012-13	tk 50012-14
tk 50012-03		x	x	x

Satz für Erwachsene
 Set for adults
 Jeu pour adultes
 Juego para adultos
 Serie per adulti



GRUBER	1:1	1:1	1:1	1:1
	Fig. 1	Fig. 2	Fig. 3	Fig. 4
	4.5 mm Ø	5.5 mm Ø	6.5 mm Ø	7.5 mm Ø
	tk 50013-11	tk 50013-12	tk 50013-13	tk 50013-14
tk 50013-03	x	x	x	x

Satz für Erwachsene
 Set for adults
 Jeu pour adultes
 Juego para adultos
 Serie per adulti



ZÖLLNER	1:1	1:1	1:1	1:1	1:1	1:1
	Fig. 1	Fig. 2	Fig. 3	Fig. 4	Fig. 5	Fig. 6
	5.5 x 6.5 mm	6.5 x 7.5 mm	7.5 x 8.5 mm	8.5 x 9.5 mm	9.5 x 10.5 mm	10.5 x 11.5 mm
	tk 50015-01	tk 50015-02	tk 50015-03	tk 50015-04	tk 50015-05	tk 50015-06
tk 50015-00	x	x	x	x	x	x

Satz für Erwachsene, schwarz
 Set for adults, black
 Jeu pour adultes, noir
 Juego para adultos, negro
 Serie per adulti, nero



POLITZER	1:1	1:1	1:1	1:1
	Fig. 1	Fig. 2	Fig. 3	Fig. 4
	2 mm Ø	3 mm Ø	4 mm Ø	5 mm Ø
	tk 50018-11	tk 50018-12	tk 50018-13	tk 50018-14
tk 50018-03	x	x	x	
tk 50018-04	x	x	x	x

Satz für Erwachsene
 Set for adults
 Jeu pour adultes
 Juego para adultos
 Serie per adulti

Ohrspekula | Spéculums auriculaires
 Ear specula | Espéculos auriculares
 Specoli auricolari



1:1

BOUCHERON		○ 1:1	○ 1:1	○ 1:1	○ 1:1
	Fig. 1	Fig. 2	Fig. 3	Fig. 4	
	4.5 mm Ø	5.5 mm Ø	6.5 mm Ø	7.5 mm Ø	
	tk 50019-11	tk 50019-12	tk 50019-13	tk 50019-14	
tk 50019-04	x	x	x	x	

Satz für Erwachsene
 Set for adults

Jeu pour adultes
 Juego para adultos
 Serie per adulti



1:1

HARTMANN		○ 1:1	○ 1:1	○ 1:1
	Fig. 0	Fig. 1	Fig. 2	
	3.0 mm Ø	4.5 mm Ø	5.5 mm Ø	
	tk 50020-10	tk 50020-11	tk 50020-12	
tk 50020-03	x	x	x	

Satz für Kinder
 Set for children

Jeu pour enfants
 Juego para niños
 Serie per bambini



1:1

HARTMANN		○ 1:1	○ 1:1	○ 1:1	○ 1:1
	Fig. 1	Fig. 2	Fig. 3	Fig. 4	
	4.5 mm Ø	5.5 mm Ø	6.5 mm Ø	7.5 mm Ø	
	tk 50022-11	tk 50022-12	tk 50022-13	tk 50022-14	
tk 50022-03		x	x	x	
tk 50022-04	x	x	x	x	

Satz für Erwachsene
 Set for adults

Jeu pour adultes
 Juego para adultos
 Serie per adulti



1:1

HARTMANN		○ 1:1	○ 1:1	○ 1:1	○ 1:1	○ 1:1
	Fig. 1	Fig. 2	Fig. 3	Fig. 4	Fig. 5	
	2.0 mm Ø	3.5 mm Ø	5.0 mm Ø	6.5 mm Ø	7.5 mm Ø	
	tk 50023-11	tk 50023-12	tk 50023-13	tk 50023-14	tk 50023-15	
tk 50023-04		x	x	x	x	

Satz für Erwachsene, schwarz
 Set for adults, black

Jeu pour adultes, noir
 Juego para adultos, negro
 Serie per adulti, nero

Ohrspekula | Spéculums auriculaires
 Ear specula | *Espéculos auriculares*
 Specoli auricolari



SIEGLE

	Fig. 1	Fig. 2	Fig. 3	
	6.5 mm Ø	7.0 mm Ø	8.0 mm Ø	
	tk 50025-01	tk 50025-02	tk 50025-03	tk 50026-07
tk 50025-00	x	x	x	x

Satz komplett
 Set complete
 Jeu complet
 Juego completo
 Serie completa

tk 50025-10

Lupenkörper, allein
Magnifyer, alone
 Loupe, seule
Lupa, sola
 Lente, solo



BRUENINGS

	Fig. 1	Fig. 2	Fig. 3	Fig. 4	
	6.5 mm Ø	7.5 mm Ø	8.5 mm Ø	9.5 mm Ø	
	tk 50026-01	tk 50026-02	tk 50026-03	tk 50026-04	tk 50026-07
tk 50026-00	x	x	x	x	x

Satz komplett
 Set complete
 Jeu complet
 Juego completo
 Serie completa

tk 50026-10

Lupenkörper, allein
Magnifyer, alone
 Loupe, seule
Lupa, sola
 Lente, solo

Flexibler Spannarm
Flexible tension arm

Bras flexible
Brazo flejible
 Braccio flessibile



tk 50029-00

Flexibler Spannarm mit Befestigungsstange für OP-Tische
Flexible tension arm with holding rod for OP-tables
Tendeur flexible avec tige pour tables d'opérations
Brazo flejible con tija para mesas de operaciones
 Braccio flessibile con morsetto pertavolo operatorro

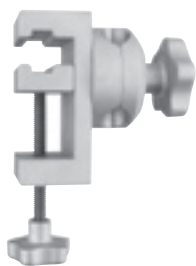

tk 50029-01

Drehbare Halterung für flexiblen Spannarm
Rotatable for flexible tension arm
Support rotatif pour tendeur flexible
Soporte giratorio para brazo flejible
 Supporto rotante per braccio flessibile



tk 50029-02

Ohrtrichterhalter
Ear speculum clamp
 Support pour spéculums auriculaires
Soporte para espejulos auriculares
 Supporto per specoli auricolari



tk 50029-03

Endoskophalterung
Endoscope holder
Support pour optiques
Soporte para opticus
 Supporto per ottiche

Ohrkatheter
Eustachian catheters

Sondes auriculaires
Sondas auriculares
Sonde auricolari



HARTMANN

	Fig. 1	Fig. 2
2.0 mm Ø	tk 6361-20	tk 6363-20
2.5 mm Ø	tk 6361-25	tk 6363-25
3.0 mm Ø	tk 6361-30	tk 6363-30



HARTMANN

	Fig. 0	Fig. 1	Fig. 2	Fig. 3	Fig. 4	Fig. 5
150 mm - 6"	tk 6380-00	tk 6380-01	tk 6380-02	tk 6380-03	tk 6380-04	tk 6380-05

1:2

Ohrkatheter | Sondes auriculaires
Eustachian catheters | *Sondas auriculares*
 Sonde auricolari



1:2 **tk 6385-00**

Schlaucholive für Ohrkatheter
Tube end piece for eustachian catheter
 Olive pour sonde auriculaire
Olive para sondas auriculares
 Olive per sonde auricolari

TRÖLTSCH



1:1



1:1



1:1



1:1



1:1

Fig. 1	Fig. 2	Fig. 3	Fig. 4	Fig. 5
150 mm - 6"	tk 6382-01	tk 6382-02	tk 6382-04	tk 6382-05

Ohrspritze | Seringue auriculaire
Ear syringe | *Jeringa auricular*
 Siringhe auricolari



1:2



1:2

50 ccm - 2 oz	tk 6375-00
100 ccm - 4 oz	tk 6375-10

komplett mit 2 Aufsätzen
complete with 2 nozzles
 complet avec 2 canules
completa con 2 canulas
 completa con 2 terminali

1:2

Pulverbläser
Atomizers

Pulvérisateurs
Pulverizadores
Soffiatori



POLITZER

tk 50930-00

komplett mit 3 Nasenoliven
complete with 3 nasal olives

complet avec 3 olives nasales

completo con 3 olivas nasales

completo con 3 olive nasali



15 mm Ø

tk 50930-15

Nasenoliven
Nasal olives

Olives nasales

Olivas nasales

Olive nasali



17 mm Ø

tk 50930-17



22 mm Ø

tk 50930-22



4 mm Ø

tk 50930-04

Ohrlive
Ear olive

Olive auriculaire

Oliva auricular

Oliva auricolare

tk 50930-50

Gummibirne mit Einsteckkonus
Rubber bulb with connecting nozzle

Poire en caoutchouc avec embout de raccordement

Pera de goma con cono de conexión

Pera in gomma con cono di connessione

Pulverbläser | Pulvérisateurs
 Atomizers | Pulverizadores
 Soffiatori



KABIERSKE

tk 50920-00	tk 50920-01	tk 50920-50
Pulverbläser, komplett <i>Atomizer, complete</i>	Ersatzflasche, 30 ccm <i>Spare bottle, 30 ccm</i>	Ventilball <i>Valve rubber bulb</i>
Pulvérisateur, complet <i>Pulverizador, completo</i>	Flacon de recharge, 30 ccm <i>Frasco suelto, 30 ccm</i>	Poire en caoutchouc avec valve <i>Pera de goma con valva</i>
Soffiatore, completo	Bottiglia di ricambio, 30 ccm	Pallone in gomma con valva

KABIERSKE

80 mm - 3¼"	tk 50920-08	
110 mm - 4¼"	tk 50920-11	
130 mm - 5"		tk 50920-13

Kanüle gerade <i>Cannula, straight</i>	Kanüle gebogen <i>Cannula curved</i>
Canule droit	Canule courbe
<i>Cánula recta</i>	<i>Cánula curva</i>
Cannula retta	Cannula curva

Ohr- und Nasenpinzetten
Ear and nose dressing forceps

Pinces auriculaires et nasaux
Pinzas auriculares y nasales
Pinze auricolari e nasali

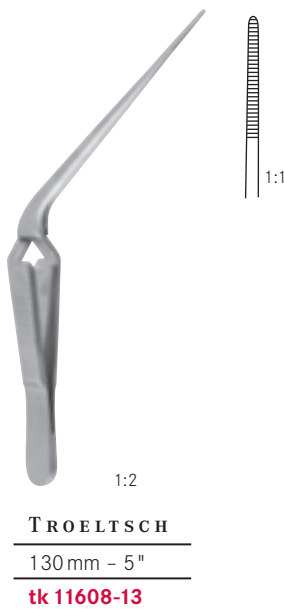
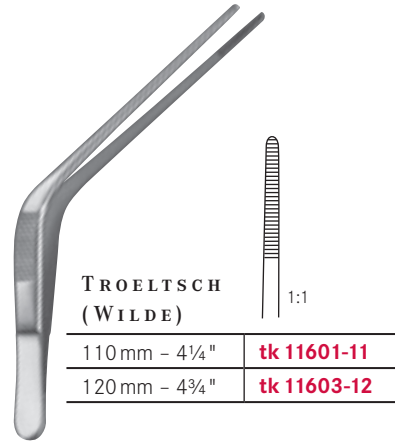
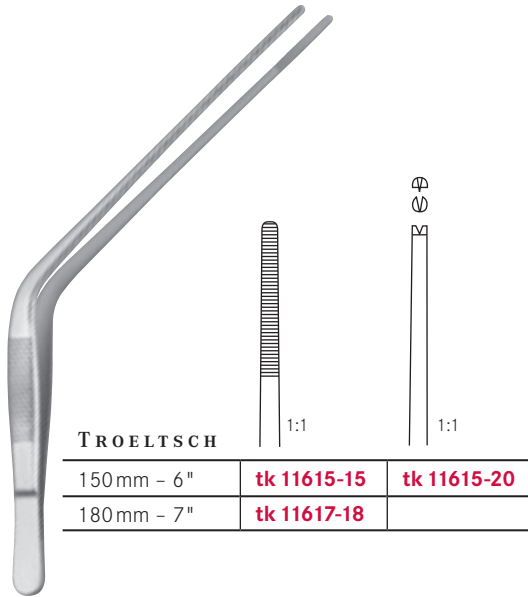

gekreuzt
cross
croisée
cruzada
crociato



Columella Pinzette
Columella forceps
Pince à columella
Pinza para columella
Pinze per columella

Ohr- und Nasenpinzetten | Pincés auricolaires et nasaux
 Ear and nose dressing forceps | Pinzas auriculares y nasales
 Pinze auricolari e nasali



LUCAE

140 mm - 5½"

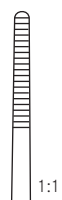

1:1

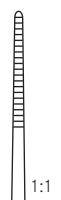

1:1

tk 11605-14

tk 11606-14



JANSEN
(GRUENWALD)

160 mm - 6¼"

tk 11609-16

200 mm - 8"

tk 11609-20



JANSEN
(GRUENWALD)

160 mm - 6¼"

tk 11607-16

200 mm - 8"

tk 11607-20

Ohrpolypenzangen
Ear polypus forceps

Pinces pour polypes auriculaires
Pinzas para pólipos auriculares
Pinze per polipi auricolari



LITTAUER

120 mm - 4¾"

tk 50403-12

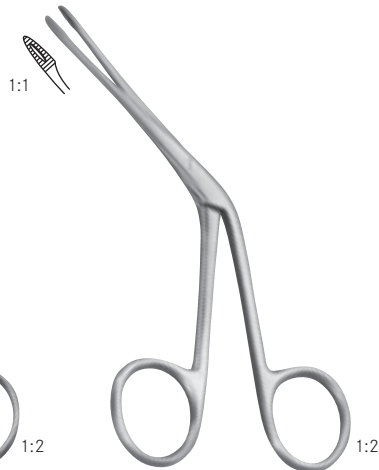

HARTMANN

120 mm - 4¾"

tk 50405-12

feines Modell
delicate jaw
modèle fin
modelo fino
modello fino



HARTMANN

140 mm - 5½"

tk 50407-14

normales Modell
standard model
modèle standard
modelo estandard
modello standard



QUIRE

105 mm - 4¼"

tk 50419-10

Fremdkörperheber
Foreign body lever

Levier pour corps étrangers
Elevador para cuerpos extraños
Leva per corpi estranei

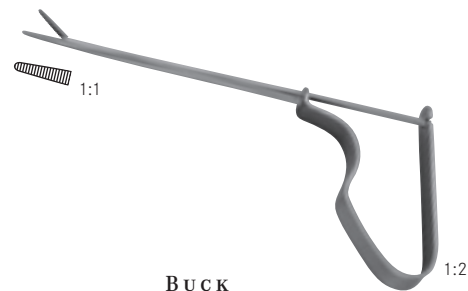

BUCK

115 mm - 4½"

tk 50417-11

Fremdkörperzängchen
Foreign body forceps

Pince pour corps étrangers
Pinza para cuerpos extraños
Pinza per corpi estranei

Ohrhäkchen – Messer
Ear hooks – knives

Crochets – couteaux auriculaires
Ganchos – cuchillos auriculares
 Uncini – coltelli auricolari



1:2

MUCK	
135 mm – 5¼"	tk 50690-13



1:2

GERZOG-SEXTON	
170 mm – 6¾"	tk 50705-17



1:1



1:2

DAY		
160 mm – 6¼"	tk 50665-01	tk 50665-02



1:1





1:1

Ohrschlingen - Hakchen
 Ear loops - hooks

Anses - crochets auriculaires
 Asas - ganchos auriculares
 Anse - uncini auricolari





1:2







BILLEAU	 1:1	 1:1	 1:1
	165 mm - 6½"	tk 50634-01	tk 50634-02



1:2









LUCAE	 1:1	 1:1	 1:1
	140 mm - 5½"	tk 50644-01	tk 50644-02











WAGENER	 1:1	 1:1	 1:1	 1:1	 1:1	 1:1	 1:1
	140 mm - 5½"	tk 50661-01	tk 50661-02	tk 50661-03	tk 50661-04	tk 50661-05	tk 50661-06

Ohrküretten | Cures auriculaires
 Ear cures | Cures auriculaires
 Curette auricolari



	 1:1	 1:1	 1:1	 1:1	 1:1	 1:1	 1:1	 1:1
Buck	Fig. 000	Fig. 00	Fig. 0	Fig. 1	Fig. 2	Fig. 3	Fig. 4	Fig. 5
165 mm - 6½"	tk 50610-01	tk 50610-02	tk 50610-10	tk 50610-11	tk 50610-12	tk 50610-13	tk 50610-14	tk 50610-15

stumpf
 blunt
 mousse
 roma
 smussa

	 1:1	 1:1	 1:1	 1:1	 1:1	 1:1	 1:1	 1:1
	Fig. 000	Fig. 00	Fig. 0	Fig. 1	Fig. 2	Fig. 3	Fig. 4	Fig. 5
165 mm - 6½"	tk 50611-01	tk 50611-02	tk 50611-10	tk 50611-11	tk 50611-12	tk 50611-13	tk 50611-14	tk 50611-15









scharf
 sharp
 tranchante
 cortante
 tagliente











Abbildungen zeigen den Außendurchmesser.
 Pictures show the outer diameter.
 Illustrations représentent le diamètre externe.
 Ilustraciones presentan el diámetro externo.
 Le illustrazioni mostrano il diametro esterno.

Ohrküretten | Cures auriculaires
 Ear cures | Cures auriculaires
 Curette auricolari



BUCK	 1:1	 1:1	 1:1	 1:1	 1:1	 1:1	 1:1	 1:1
	Fig. 000	Fig. 00	Fig. 0	Fig. 1	Fig. 2	Fig. 3	Fig. 4	Fig. 5
165 mm-6½"	tk 50614-01	tk 50614-02	tk 50614-10	tk 50614-11	tk 50614-12	tk 50614-13	tk 50614-14	tk 50614-15

gebogen, stumpf
curved, blunt
 courbe, tranchante
curva, cortante
 curva, smussa

	 1:1	 1:1	 1:1	 1:1	 1:1	 1:1	 1:1	 1:1
	Fig. 000	Fig. 00	Fig. 0	Fig. 1	Fig. 2	Fig. 3	Fig. 4	Fig. 5
165 mm-6½"	tk 50615-01	tk 50615-02	tk 50615-10	tk 50615-11	tk 50615-12	tk 50615-13	tk 50615-14	tk 50615-15

gebogen, scharf
curved sharp
 courbe, pointue
curva, aguda
 curva, tagliente

1:1



Abbildungen zeigen den Außendurchmesser.
Pictures show the outer diameter.
 Illustrations représentent le diamètre externe.
Illustraciones presentan el diametro externo.
 Le illustrazioni mostrano il diametro esterno.

Ohrküretten und scharfe Löffel
Ear cures and sharp spoons

Curettes auriculaires et cuillères tranchantes
Curetas y cucharillas auriculares cortantes
 Curette auricolari e cucchiari taglienti



LANGENBECK

130 mm - 5"

tk 50620-13

stumpf
blunt
 mousse
roma
 smussa



JANSEN

170 mm - 6¾"

tk 50622-17

scharf
sharp
 tranchante
cortante
 acuta

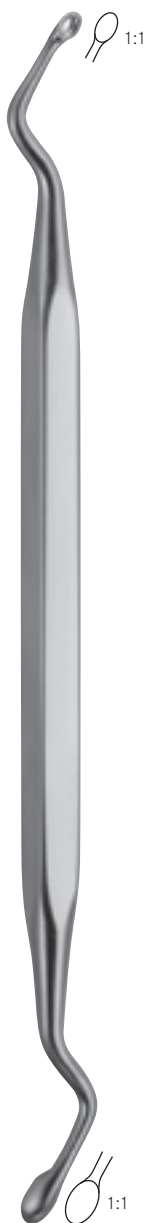

160 mm - 6¼"

tk 50628-16

scharf
sharp
 tranchante
cortante
 acuta



GROSS

120 mm - 4¾"

tk 50623-12

scharf, voll
sharp, not fenestrated
 tranchante, pleine
cortante, lleno
 acuta, pieno

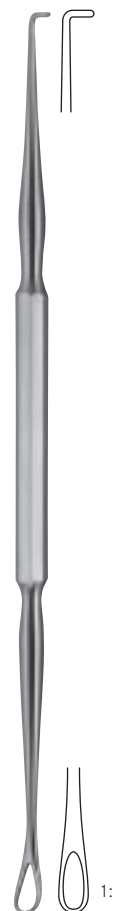

120 mm - 4¾"

tk 50624-12

stumpf, gefenstert
blunt, fenestrated
 mousse, fenêtrée
romas, fenestrada
 smussa, fenestrata

Parazentesenadeln
Paracentesis needles

Aiguilles de paracentèse
Agujas para paracentesis
Aghi per paracentesi



POLITZER
150 mm - 6"
tk 50710-15

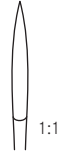

GERZOG
160 mm - 6¼"
tk 50712-16



BUCK
160 mm - 6¼"
tk 50714-16



LUCAE

180 mm - 7" **tk 50761-18**

tk 50763-18



LUCAE
190 mm - 7½"
tk 50765-19



POLITZER
170 mm - 6¾"
tk 50757-16



POLITZER

160 mm - 6¼"

tk 50753-16

Nadel senkrecht
Needle vertical

Aiguille verticale
Aguja vertical
Ago verticale



160 mm - 6¼"

tk 50755-16

Nadel waagrecht
Needle horizontal

Aiguille horizontale
Aguja horizontal
Ago orizzontale

Ohrraspatorien | Raspateurs auriculaires
 Ear-raspatories | Raspatorias auriculares
 Raspatori auricolari



WULLSTEIN

160mm - 6¼" tk 50578-01 tk 50578-02

gerade	gebogen
straight	curved
droite	courbe
recta	curva
rette	curvo



ROSEN

	2.5 mm	1.5 mm
175 mm - 7"	tk 50781-00	tk 50783-00

bajonettförmig
 bayonet shaped
 en forme de baionette
 en forma de bayoneta
 forma a baionetta



bajonettförmig
 bayonet shaped
 en forme de baionette
 en forma de bayoneta
 forma a baionetta



LEMPERT

tk 50784-02

160mm - 6¼"
 3.0 mm

Ohrpolypenschnürer | Serre noeuds auriculaires
Ear polypus snares | *Polipótomos auriculares*
 Serranodi auricolari



	10 m - 33 ft.
0.3 mm Ø	tk 50319-30
0.4 mm Ø	tk 50319-40



0.2 mm Ø x 75 mm	tk 50320-20
0.3 mm Ø x 100 mm	tk 50320-30

in Bündeln mit 12 Stück
in bundles of 12 pieces
 en paquets de 12 pièces
 en líos de 12 piezas
 pacchetto di 12 pezzi



KRAUSE 1:2
 160 mm - 6¼" **tk 50311-16**



KRAUSE-VOSS 1:2
 160 mm - 6¼" **tk 50313-16**



LANGE-WILDE 1:2
 170 mm - 6¾" **tk 50315-17**

Ohr-Knochenstanzen
Mastoid-rongeurs

Rongeurs auriculaires
Pinzas osteótomos auriculares
 Concotomi auricolari

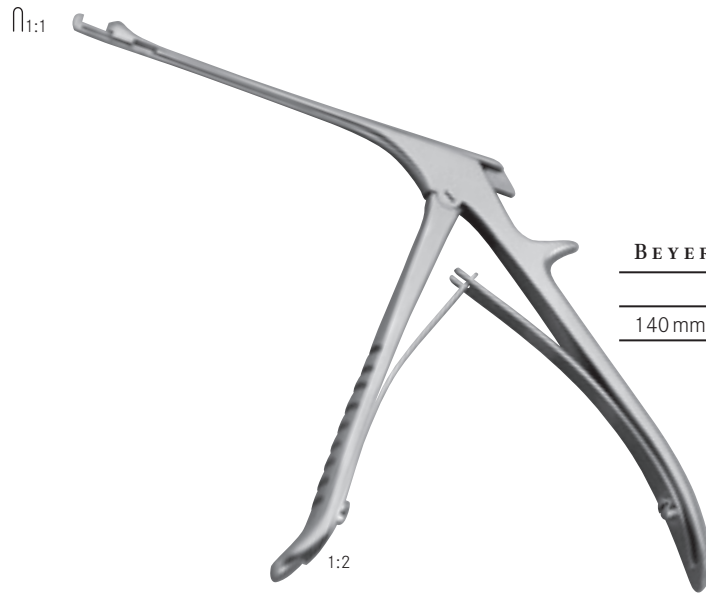

BEYER	
	1 mm
140 mm - 5½"	tk 50494-14





BEYER	
	2 mm
190 mm - 7½"	tk 50493-19





Ohr-Knochenstanzen
Mastoid-rongeurs

Rongeurs auriculaires
Pinzas osteótomos auriculares
Concotomi auricolari



CITELLI	 1:1	 1:1
170 mm - 6¾"	2.2 mm	3.0 mm
x = 60 mm	tk 50491-02	tk 50491-03



KERRISON	 1:1	 1:1	 1:1	 1:1
200 mm - 8"	3 x 3 mm	4 x 4 mm	5 x 5 mm	6 x 6 mm
x = 80 mm	tk 51251-00	tk 51251-01	tk 51251-02	tk 51251-03

Wundsperrer | Ecarteurs autostatiques
 Self-retaining retractors | Separadores autoestáticos
 Divaricatori autostatici



CLOWARD-CONTOUR

1:2

140 mm - 5½"	tk 17406-01	tk 17406-02
3x4	scharf	3x4
	sharp	stumpf
		blunt
pointu		mousse
agudo		romo
acuto		smusso



WULLSTEIN

1:2

100 mm - 4"	tk 17408-01	tk 17408-02
3x3	scharf	3x3
	sharp	stumpf
		blunt
pointu		mousse
agudo		romo
acuto		smusso



WEITLANER-WULLSTEIN

1:2

130 mm - 5"	tk 17408-13	tk 17408-14
3x3	scharf	3x3
	sharp	stumpf
		blunt
pointu		mousse
agudo		romo
acuto		smusso

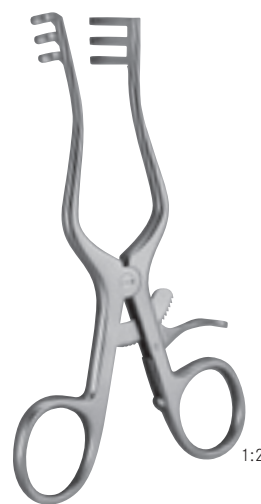

MILLIGAN

1:2

130 mm - 5"	tk 17409-13
3x3	scharf
	sharp
	stumpf
	blunt
	mousse
	romo
	smusso

Wundsperrer
Self-retaining retractors

Ecarteurs autostatiques
Separadores autoestáticos
Divaricatori autostatici

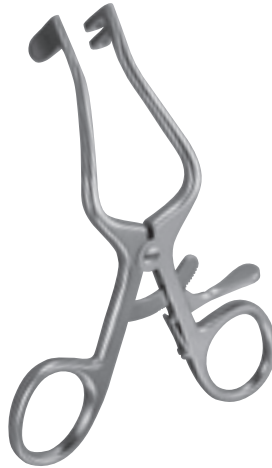

BELUCCI

110mm - 4 1/4"

tk 17410-11

tk 17411-11

130mm - 5"

tk 17410-13

tk 17411-13

1x2
links, stumpf
left, blunt
gauche, mousse
izquierda, romo
sinistra, smusso

1x2
rechts, stumpf
right, blunt
droit, mousse
derecha, romo
destra, smusso

MOLLISON

150mm - 6"

tk 17419-15

4x4
scharf
sharp
pointu
agudo
acuto

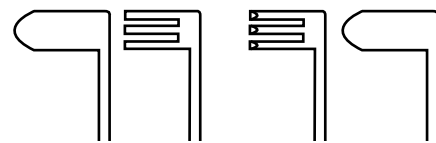

FISH

165mm - 6 1/2"

tk 56765-00

tk 56765-01

1x3
Blatt links
Blade left

1x3
Blatt rechts
Blade right

Lame gauche
Hoja izquierda
Lama a sinistra

Lame droite
Hoja derecha
Lama a destra

Wundsperrer | Ecarteurs autostatiques
Self-retaining retractors | Separadores autoestáticos
 Divaricatori autostatici



PLESTER		
130 mm - 5"	tk 17450-13	tk 17451-13
	2x2	2x2
	stumpf	scharf
	blunt	sharp
	mousse	pointu
	romo	agudo
	smusso	acuto



PLESTER		
110 mm - 4¼"	tk 17452-11	tk 17453-11
	1x2	1x2
	links, stumpf	rechts, stumpf
	left, blunt	right, blunt
	gauche, mousse	droit, mousse
	izquierda, romo	derecha, romo
	sinistra, smusso	destra, smusso

Wundsperrer
Self-retaining retractors

Ecarteurs autostatiques
Separadores autoestáticos
Divaricatori autostatici

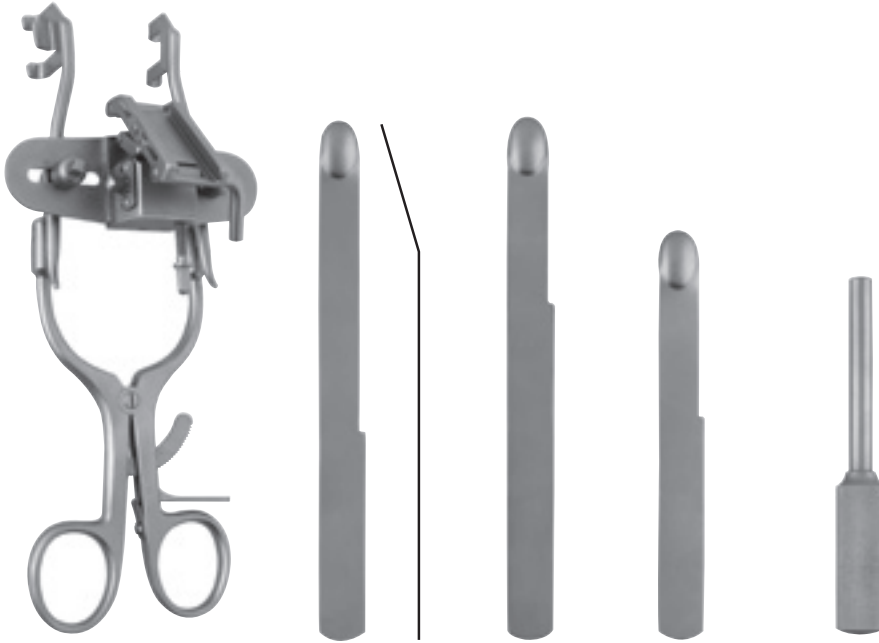

F I S H

	tk 56766-01	tk 56766-02	tk 56766-03	tk 56766-04	tk 56766-05
--	--------------------	--------------------	--------------------	--------------------	--------------------

leichtgebogen
slightly curved
légèrement courbé
ligeramente curva

tk 56766-00	x	x	x	x	x
--------------------	---	---	---	---	---

Satz komplett
Set complete
Jeu complet
Juego completo
Serie completa

WILLIGER

130mm - 5"

tk 56775-13

scharf
sharp
pointu
agudo
acuto



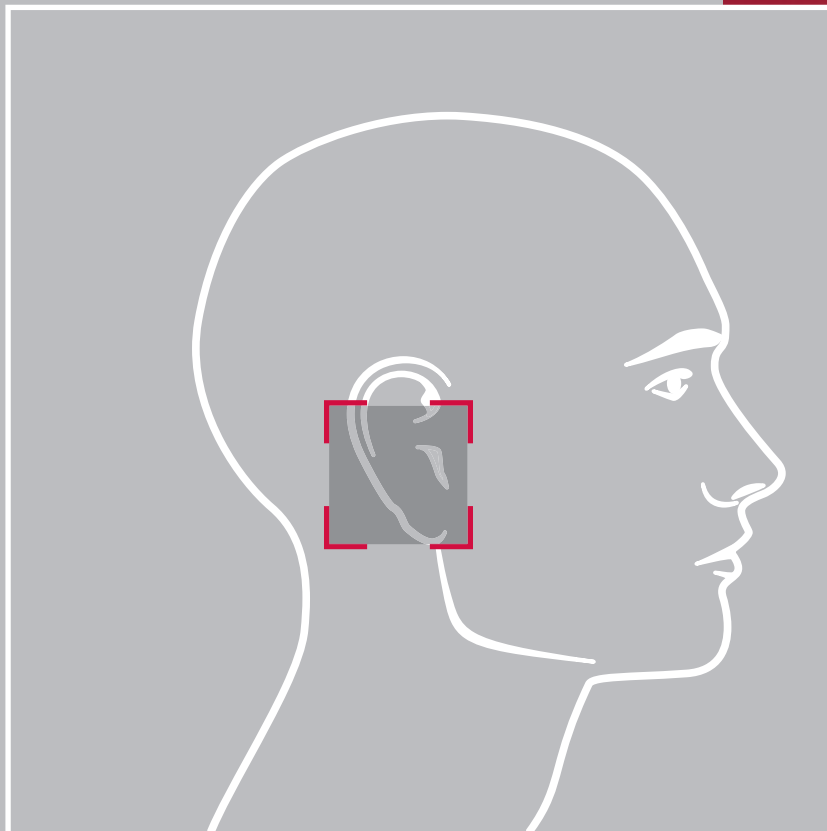

Ohr Mikrochirurgie
Ear microsurgery

Microchirurgie pour l'oreille
Micro cirugía para el oído
Microchirurgia dell'orecchio

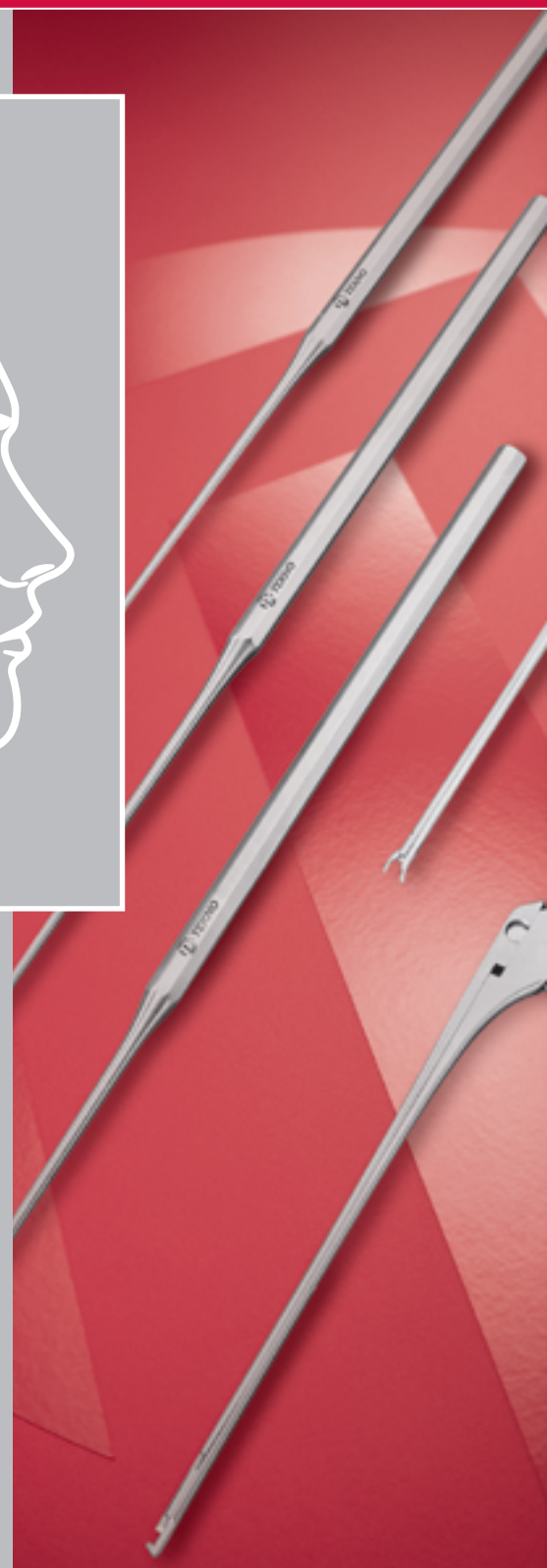

Saugrohre
Suction tubes

Tubes d'aspiration
Tubos para aspiración
Cannule d'aspirazione



BARON

		75 mm - 3"	100 mm - 4"
1 mm Ø	3 Charr./Fr.	tk 25226-03	tk 25226-53
1 2/3 mm Ø	5 Charr./Fr.	tk 25226-05	tk 25226-55
2 1/3 mm Ø	7 Charr./Fr.	tk 25226-07	tk 25226-57



HOUSE

		75 mm - 3"	100 mm - 4"
1 mm Ø	3 Charr./Fr.	tk 25227-53	tk 25227-03
1 2/3 mm Ø	5 Charr./Fr.	tk 25227-55	tk 25227-05
2 1/3 mm Ø	7 Charr./Fr.	tk 25227-57	tk 25227-07
2 2/3 mm Ø	8 Charr./Fr.	tk 25227-58	tk 25227-08
3 1/3 mm Ø	10 Charr./Fr.	tk 25227-60	tk 25227-10
4 mm Ø	12 Charr./Fr.	tk 25227-62	tk 25227-12
4 2/3 mm Ø	14 Charr./Fr.	tk 25227-64	tk 25227-14



FERGUSSON

		170 mm - 6 3/4"
2 mm Ø	6 Charr./Fr.	tk 25228-06
2 1/3 mm Ø	7 Charr./Fr.	tk 25228-07
2 2/3 mm Ø	8 Charr./Fr.	tk 25228-08
3 mm Ø	9 Charr./Fr.	tk 25228-09
3 1/3 mm Ø	10 Charr./Fr.	tk 25228-10
4 mm Ø	12 Charr./Fr.	tk 25228-12
5 mm Ø	15 Charr./Fr.	tk 25228-15

1:2

Saugrohre
Suction tubes

Tubes d'aspiration
 Tubos para aspiración
 Cannule d'aspirazione



0.5 mm Ø	tk 25221-05
0.7 mm Ø	tk 25221-07
0.9 mm Ø	tk 25221-10
1.2 mm Ø	tk 25221-12

aufsetzbare Kanüle
slip-on cannula
canule démontable
cánula desmontable
cannula applicabile

ZÖLLNER

1:2

0.7 mm Ø	tk 25221-01	tk 25221-00
----------	--------------------	--------------------

ohne Kanüle without cannula	komplett mit 1 aufsetzbaren Kanüle, 0.7 mm Ø complete with 1 slip-on cannula, 0.7 mm Ø
sans canule sin cánula	complet avec 1 canule démontable, 0.7 mm de Ø completo con 1 cánula desmontable de 0.7 mm Ø
senza cannula	completa di 1 cannula applicabile di mm 0.7 di Ø



IOWA

1:2

	0.7 mm Ø
160 mm - 6¼"	tk 25223-16



MAGILL

	245 mm - 9¾"
3.0 mm Ø	tk 25225-01
3.5 mm Ø	tk 25225-02
4.0 mm Ø	tk 25225-03

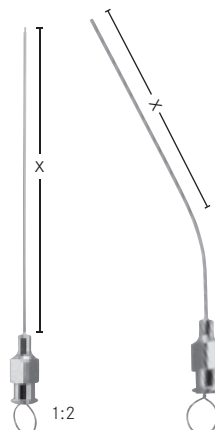

ROSEN

	x = 80 mm	x = 65 mm
0.7 mm Ø	tk 25243-01	tk 25244-01
0.9 mm Ø	tk 25243-02	tk 25244-02
1.2 mm Ø	tk 25243-03	tk 25244-03

Saugrohre
Suction tubes

Tubes d'aspiration
 Tubos para aspiración
 Cannule d'aspirazione

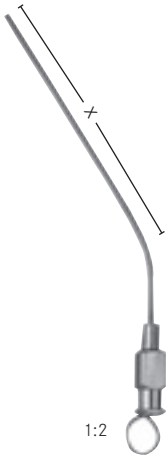

1:2

HOUSE

	x = 70 mm
0.6mm Ø	tk 25227-20
0.8 mm Ø	tk 25227-21
1.0mm Ø	tk 25227-22
1.2 mm Ø	tk 25227-23
1.5 mm Ø	tk 25227-24
1.8 mm Ø	tk 25227-25
2.0 mm Ø	tk 25227-26
2.2 mm Ø	tk 25227-27
2.5 mm Ø	tk 25227-28
3.0 mm Ø	tk 25227-29



NIJMEGEN

1.5 mm Ø	tk 25228-01
2.0 mm Ø	tk 25228-02
2.5 mm Ø	tk 25228-03
3.0 mm Ø	tk 25228-04
4.0 mm Ø	tk 25228-05



1:2

HOUSE ADAPTER

	luer
52 mm - 2"	tk 25227-01



VERHOEVEN

		170 mm - 6¾"	170 mm - 6¾"	170 mm - 6¾"
1.5 mm Ø	16 Charr./Fr.	tk 25230-01	tk 25234-01	tk 25234-02
2.0 mm Ø	17 Charr./Fr.	tk 25230-02	tk 25234-03	tk 25234-04



gerade
straight
droite
recta
retta

nach unten gebogen
curved down
courbe en bas
curva a bajo
curva in basso

nach oben gebogen
curved up
courbe en haut
curva arriba
curva in alto

Saugrohre
Suction tubes

Tubes d'aspiration
 Tubos para aspiración
 Cannule d'aspirazione



1:2



FRAZIER

		170 mm - 6 ³ / ₄ "	170 mm - 6 ³ / ₄ "	170 mm - 6 ³ / ₄ "	170 mm - 6 ³ / ₄ "	170 mm - 6 ³ / ₄ "
2 mm Ø	6 Charr./Fr.	tk 25230-06				
2 ¹ / ₃ mm Ø	7 Charr./Fr.	tk 25230-07				
2 ² / ₃ mm Ø	8 Charr./Fr.	tk 25230-08				
3 mm Ø	9 Charr./Fr.	tk 25230-09				
3 ¹ / ₃ mm Ø	10 Charr./Fr.	tk 25230-10	tk 25220-02	tk 25220-01	tk 25220-06	tk 25220-05
4 mm Ø	12 Charr./Fr.	tk 25230-12	tk 25220-04	tk 25220-03	tk 25220-08	tk 25220-07
5 mm Ø	15 Charr./Fr.	tk 25230-15				



1:2

FRAZIER

		170 mm - 6 ³ / ₄ "
2 ² / ₃ mm Ø	8 Charr./Fr.	tk 25230-20
3 ¹ / ₃ mm Ø	10 Charr./Fr.	tk 25230-21
4 mm Ø	12 Charr./Fr.	tk 25230-22
5 mm Ø	15 Charr./Fr.	tk 25230-23

Saugrohre
Suction tubes

Tubes d'aspiration
 Tubos para aspiración
 Cannule d'aspirazione

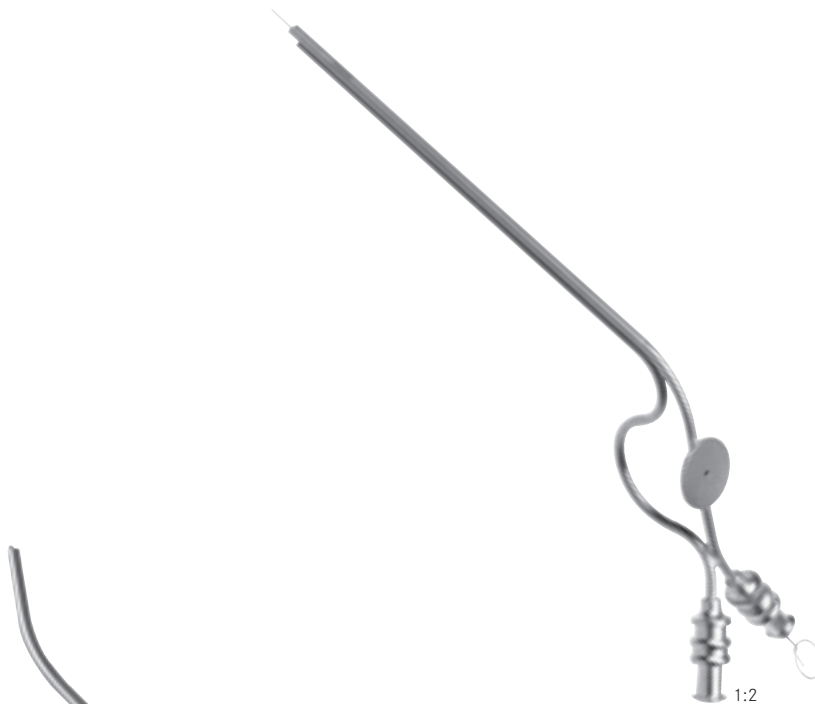

FISCH

Ø 4.0mm-90mm

tk 6381-02

KAHN-FRAZIER

10 Char. Ø	tk 25220-09	tk 25220-10
leicht gebogen <i>slightly curved</i>		stark gebogen <i>strongly curved</i>
légèrement courbé <i>ligeramente curvada</i>		très courbé <i>muy curvada</i>
leggermente curv		fortemente curva

1:2

Saugrohre
Suction tubes

Tubes d'aspiration
Tubos para aspiración
Cannule d'aspirazione

1:2

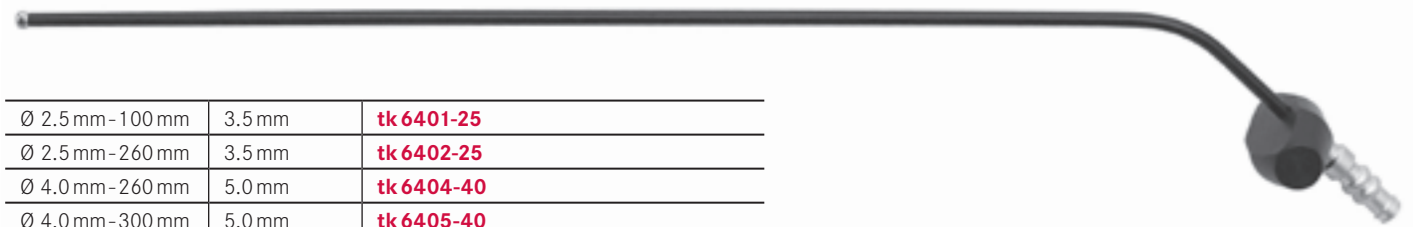

Ø 2.5 mm - 100 mm	3.5 mm	tk 6401-25
Ø 2.5 mm - 260 mm	3.5 mm	tk 6402-25
Ø 4.0 mm - 260 mm	5.0 mm	tk 6404-40
Ø 4.0 mm - 300 mm	5.0 mm	tk 6405-40

Ø, Nutzlänge Ø, Length	Kugel Ø Ball Ø	Koagulations-Saugrohre, gerade Coagulation suction tubes, straight
Ø, Longueur Ø, Longitud	Boule Ø Bola Ø	Canules de suction et coagulation, droits Canulas de succión et coagulación, rectas
Ø, Lunghezza operativa	Sfera Ø	Cannule di aspirazione e coagulazione, rette

Ohrzängchen
Ear forceps
Pincés auriculaires
Pinzas auriculares
Pinze auricolari



HARTMANN-WULLSTEIN
x = 85 mm - 3¼" **tk 50455-08**



HARTMANN-WULLSTEIN
1 mm Ø
x = 85 mm - 3¼" **tk 50457-08**

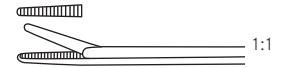

HARTMANN
x = 185 mm - 3¼" **tk 50459-08**
x = 140 mm - 5½" **tk 50459-14**
x = 160 mm - 6¼" **tk 50459-16**



HARTMANN
x = 185 mm - 3¼" **tk 50461-08**
x = 140 mm - 5½" **tk 50461-14**

1x2

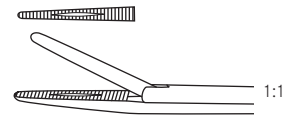

HARTMANN-NOYES
x = 90 mm - 3½" **tk 50463-09**



HARTMANN-WEINGÄRTNER
x = 85 mm - 3¼" **tk 50467-08**

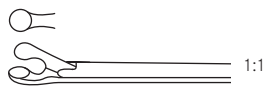

HARTMANN
x = 85 mm - 3¼"
2.0 mm Ø **tk 50469-01**
2.5 mm Ø **tk 50469-02**
3.0 mm Ø **tk 50469-03**

STRUEMPEL
x = 85 mm - 3¼"
0° **tk 50472-08**



45° **tk 50472-45**



90° **tk 50472-90**

Mikro-Ohrzängchen
Micro ear forceps

Micro pinces auriculaires
Micro-pinzas auriculares
Micro-pinze auricolari



MCGEE



1:1

3.5 mm x 0.8 mm

tk 50430-00

Drahtbiegezängchen
Wire bending forceps

Pince pour plier fils métalliques
Pinza para plegar alambres
Pinza per piegare fili metallici

FULLER



1:1

80 mm - 3 1/4"

tk 50434-01

Einführungszängchen für Teflonprothesen
Introducing forceps for teflon prosthesis

Pince pour introduction pour prothèses de téflon
Pinza para introducir prótesis de teflon
Pinza per introduzione di protesi in teflon

DIETER

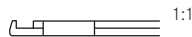

1:1



1:1



1:1



1:1

x = 80 mm - 3 1/4"

tk 50432-01

tk 50432-02

tk 50433-01

tk 50433-02

Hammerkop fzängchen
Malleus nipper

Pince pour l'os marteau
Pinza para cabezal del martillo
Pinza per testa del martelletto

oben schneidend
up-cutting

coupe en haut
corte arriba
tagliente in alto

unten schneidend
down-cutting

coupe en bas
corte abajo
tagliente in basso

rechts schneidend
right-cutting

coupe à droite
corte derecha
tagliente a destra



links schneidend
left-cutting



coupe à gauche
corte izquierda
tagliente a sinistra

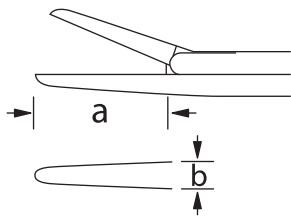

Mikro-Ohrzängchen
Micro ear forceps

Micro pinces auriculaires
Micro-pinzas auriculares
Micro-pinze auricolari



MINI MCGEE	 1:1	 1:1
a x b	x = 75 mm - 3"	x = 75 mm - 3"
3.5 mm x 0.6 mm	tk 50421-01	tk 50421-02
	gerade, glatt <i>straight, smooth</i> droit, lisse <i>recta, lisa</i> retta, liscia	gerade, gerieft <i>straight, serrated</i> droit, strié <i>recta, estriada</i> retta, zigrinata





	 1:1	 1:1	 1:1
a x b	x = 75 mm - 3"	x = 75 mm - 3"	x = 75 mm - 3"
3.5 mm x 0.6 mm			tk 50421-03
4.0 mm x 0.8 mm	tk 50420-01	tk 50420-02	tk 50420-03
	gerade, glatt <i>straight, smooth</i> droit, lisse <i>recta, lisa</i> retta, liscio	gerade, gerieft <i>straight, serrated</i> droit, strié <i>recta, estriada</i> retta, zigrinata	aufgebogen, gerieft <i>curved upwards, serrated</i> coudé en haut, strié <i>curvada arriba, estriada</i> curvata in alto, zigrinata

	 1:1	 1:1	 1:1
a x b	x = 75 mm - 3"	x = 75 mm - 3"	x = 75 mm - 3"
3.5 mm x 0.6 mm	tk 50421-04	tk 50421-05	tk 50421-06
4.0 mm x 0.8 mm	tk 50420-04	tk 50420-05	tk 50420-06
	rechts gebogen, gerieft <i>curved to right, serrated</i> coudé à droite, strié <i>curvada a la derecha, estriada</i> curvata a destra, zigrinata	links gebogen, gerieft <i>curved to left, serrated</i> coudé à gauche, strié <i>curvada a la izquierda, estriada</i> curvata a sinistra, zigrinata	abwärts gebogen, gerieft <i>angled down, serrated</i> coudé en bas, strié <i>curvada a bajo, estriada</i> curvata in basso, zigrinata

Mikro-Löffelzängchen
Micro cup forceps

Micro pinces auriculaires à cuillère
Micro-pinzas auriculares a cucharilla
Micro-pinze auricolari a cucchiaino





	 1:1	 1:1	 1:1
a x b x c	x = 75 mm - 3"	x = 75 mm - 3"	x = 75 mm - 3"
4.0 x 1.0 x 0.9 mm	tk 50424-10	tk 50424-11	tk 50424-12
	gerade, oval <i>straight, oval</i> droit, ovale <i>recta, oval</i> retta, ovale	aufgebogen, oval <i>curved upwards, oval</i> coudé en haut, ovale <i>curvada arriba, oval</i> curvata in alto, ovale	links gebogen, oval <i>curved to left, oval</i> coudé à gauche, ovale <i>curvada a la izquierda, oval</i> curvata a sinistra, ovale
	 1:1	 1:1	
a x b x c	x = 75 mm - 3"	x = 75 mm - 3"	
4.0 x 1.0 x 0.9 mm	tk 50424-13	tk 50424-14	
	rechts gebogen, oval <i>curved to right, oval</i> coudé à droite, ovale <i>curvada a la derecha, oval</i> curvata a destra, ovale	abwärts gebogen, oval <i>curved downwards, oval</i> coudé en bas, ovale <i>curvada a bajo, oval</i> curvata in basso, ovale	

Mikro-Löffelzängchen
Micro cup forceps



Micro pinces auriculaires à cuillère
Micro-pinzas auriculares a cucharilla
Micro-pinze auricolari a cucchiaio



	 1:1	 1:1
a x b x c	x = 80 mm - 3¼"	x = 80 mm - 3¼"
3.5 x 0.6 x 0.5 mm	tk 50425-01	tk 50425-02
4.0 x 1.0 x 0.9 mm	tk 50424-01	tk 50424-02

gerade, oval
straight, oval
droit, ovale
recta, oval
retta, ovale

aufgebogen, oval
curved upwards, oval
coudé en haut, ovale
curvada arriba, oval
curvata in alto, ovale

	 1:1	 1:1
a x b x c	x = 80 mm - 3¼"	x = 80 mm - 3¼"
3.5 x 0.6 x 0.5 mm	tk 50425-03	tk 50425-04
4.0 x 1.0 x 0.9 mm	tk 50424-03	tk 50424-04



rechts gebogen, oval
curved to right, oval
coudé à droite, ovale
curvada a la derecha, oval
curvata a destra, ovale



aufgebogen, oval
curved to left, oval
coudé à gauche, ovale
curvada arriba, oval
curvata in alto

Mikro-Ohrscheren
Micro ear scissors

Micro ciseaux auriculaires
Micro-tijeras para oídos
Micro-forbici auricolari



BELUCCI	 1:1	 1:1
a x b	x = 75 mm - 3"	x = 75 mm - 3"
4.0 mm x 0.8 mm	tk 50426-07	tk 50426-02
sehr fein very fine	gerade, spitz/spitz straight, sharp/sharp	aufgebogen, stumpf/stumpf curved upwards, blunt/blunt
très fine muy fina	droit, pointue/pointue recta, aguda/aguda	courbés en haut, mousse/mousse curvada arriba, roma/roma
molto delicata	retta, acuta/acuta	curvata in alto, smussa/smussa



	 1:1	 1:1
a x b	x = 75 mm - 3"	x = 75 mm - 3"
4.0 mm x 0.8 mm	tk 50426-05	tk 50426-06
sehr fein very fine	rechts gebogen, spitz/spitz curved to right, sharp/sharp	links gebogen, spitz/spitz curved to left, sharp/sharp
très fine muy fina	coudé à droite, pointue/pointue curvada a la derecha, aguda/aguda	coudé à gauche, pointue/pointue curvada a la izquierda, aguda/aguda
molto delicata	curvata a destra, acuta/acuta	curvata a sinistra, acuta/acuta

	 1:1
a x b	x = 75 mm - 3"
4.0 mm x 0.8 mm	tk 50426-08
sehr fein very fine	gerade, spitz/stumpf straight, sharp/blunt
très fine muy fina	droit, pointue/mousse recta, aguda/roma
molto delicata	retta, acuta/smussa

Mikro-Ohrscheren
Micro ear scissors

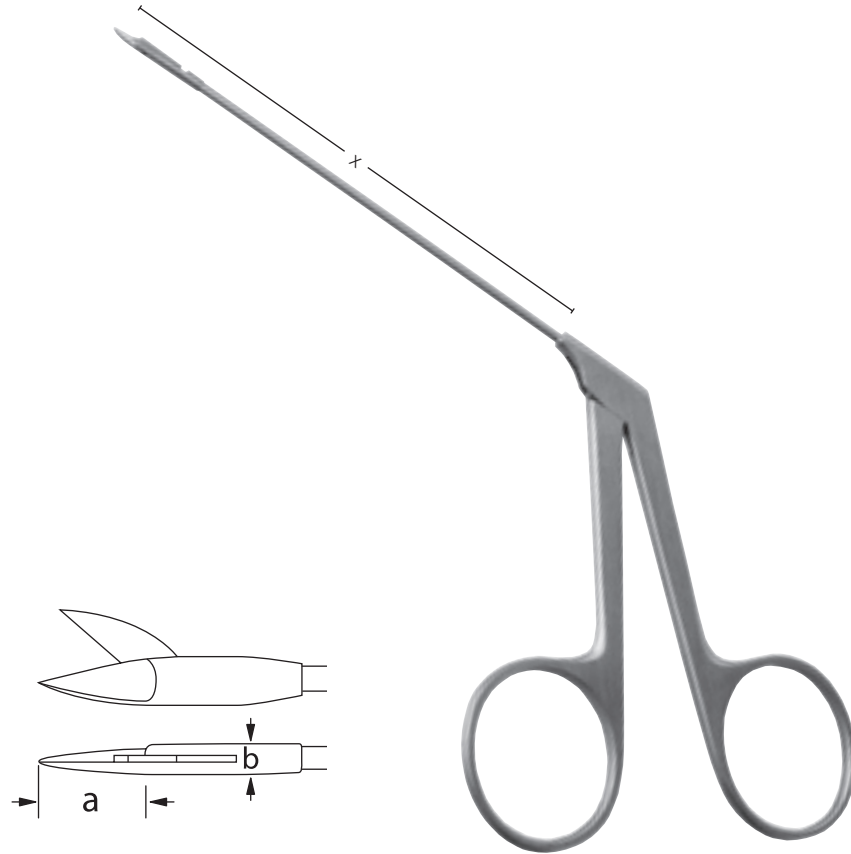
Micro ciseaux auriculaires
Micro-tijeras para oídos
Micro-forbici auricolari





WULLSTEIN	 1:1	 1:1
a x b	x = 80 mm - 3¼"	x = 80 mm - 3¼"
4.0 mm x 0.8 mm	tk 50427-01	tk 50427-02

gerade, spitz/spitz
straight, sharp/sharp

droit, pointue/pointue
recta, aguda/aguda
retta, acuta/acuta

aufgebogen, spitz/spitz
curved upwards, sharp/sharp

coudée en haut, pointue/pointue
curvada arriba, aguda/aguda
curvata in alto, acuta/acuta

WULLSTEIN	 1:1	 1:1
a x b	x = 80 mm - 3¼"	x = 80 mm - 3¼"
4.0 mm x 0.8 mm	tk 50427-03	tk 50427-04

rechts gebogen, spitz/spitz
curved to right, sharp/sharp

coudé à droite, pointue/pointue
curvada a la derecha, aguda/aguda
curvata a destra, acuta/acuta



links gebogen, spitz/spitz
curved to left, sharp/sharp

coudé à gauche, pointue/pointue
curvado a la izquierda, aguda/aguda
curvata a sinistra, acuta/acuta

Ohr Mikro-Raspatorien und Sonden
Micro ear-raspatories and probes

Micro rugines et sondes auriculaires
Micro-sondas y raspatorios auriculares
 Micro-raspatori e sonde auricolari





PLESTER	 1:1	 1:1	 1:1
	160mm - 6¼"	tk 50530-00	tk 50531-00

Führungsgabel
Wire guide
 Fourchette d'introduction
Tenedor guía
 Forchetta guida

Raspatorium
Raspatory
 Rugine
Raspatorio
 Raspatorie

Elevatorium
Elevator
 Élévateur
Elevador
 Elevatorie



 1:1	 1:1	 1:1
--	--	--

160mm - 6¼"	1.8 mm	1.0 mm	
	tk 50533-00	tk 50534-00	tk 50535-00

Raspatorium
Raspatory
 Rugine
Raspatorio
 Raspatorie

Raspatorium
Raspatory
 Rugine
Raspatorio
 Raspatorie

Dissektor, doppelt links gebogen
Dissector, double curved left
 Dissecteur, double courbe à gauche
Disector, doble curvado a la izquierda
 Dissettore doppio curvato a sinistra

 1:1	 1:1
---	---

160mm - 6¼"	tk 50536-00	tk 50537-00
-------------	--------------------	--------------------

Dissektor, doppelt rechts gebogen
Dissector, double curved right
 Dissecteur, double courbe à droite
Disector, doble curvado a la derecha
 Dissettore, doppio curvato a destra

Handinstrument zum Andrücken von Drahtprothesen
Instrument for placing wire prothesis
 Instrument pour mettre en place des protheses en fils métalliques
Instrumento para posicionar protèsis de alambre
 Strumento per posizionare prothesi di fili metallici

HOUSE	
	160mm - 6¼"





3.5 mm	tk 50571-01
4.0 mm	tk 50571-02
4.5 mm	tk 50571-03
5.0 mm	tk 50571-04





Messsonde
Measuring rod
 Sonde à mesurer
Sonda para medir
 Sonda per misurare

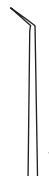



Ohrsichelmesser – Rundschnittmesser
Ear sickleknifes – Circular cutting knife

Couteaux faucilles – Couteaux ronds
Cuchillos en forma de hoz – Cuchillos redondos
Coltelli auricolari



ROSEN	 1:1	 1:1	 1:1	 1:1
	1.5 mm Ø – 90°	45°	45°	45°
160mm – 6¼"	tk 50538-00	tk 50539-01	tk 50539-02	tk 50539-03
	Rundschnittmesser <i>Circular cutting knife</i> Couteau rond <i>Cuchillo redondo</i> Coltello rotondo	Trommelfellmesser <i>Tympanum knife</i> Couteau pour le tympan <i>Cuchillo para el timpano</i> Coltello per timpani	Lanzenmesser <i>Lancet knife</i> Couteau lanceolaire <i>Cuchillo lanceolado</i> Coltello lanceolato	Lanzenmesser, kurz <i>Lancet knife, short</i> Couteau lanceolaire, court <i>Cuchillo lanceolado, corto</i> Coltello lanceolato, corto

SCHUHKNECHT	 1:1	 1:1	 1:1	 1:1
160mm – 6¼"	tk 50550-01	tk 50550-02	tk 50550-03	tk 50550-04
	Rollermesser, parallel <i>Roller knife, parallel</i> Couteau à lame, tournante, verticale <i>Cuchillo redondo, vertical</i> Coltello rotondo, parallelo	Rollermesser, rechtwinklig <i>Roller knife, right angled</i> Couteau à lame, tournante, horizontale <i>Cuchillo redondo, horizontal</i> Coltello rotondo, orizzontale	Sichelmesser, leicht gebogen <i>Sickle knife, slightly curved</i> Couteau faucille, légèrement courbe <i>Cuchillo de hoz, ligeramente curvado</i> Coltello a forma di falce, leggermente curvo	Diszisionsmesser, gerade <i>Discision knife, straight</i> Couteau à discision, droit <i>Cuchillo de discición, recto</i> Coltello da dissezione, retto

PLESTER	 1:1	 1:1	ZÖLLNER	 1:1	 1:1
160mm – 6¼"	tk 50550-06			tk 50567-01	tk 50577-01
	Lappenmesser <i>Flap knife</i> Couteau à lambeaux <i>Cuchillo para lobulos</i> Coltello per stacci			Raspatorium <i>Raspatory</i> Rugine <i>Raspatorio</i> Raspatorie	Raspatorium <i>Raspatory</i> Rugine <i>Raspatorio</i> Raspatorie
		45°		1 mm	1 mm
		3.0 mm Ø	160 mm – 6¼"		
		2.6 mm Ø	tk 50552-01		
		2.0 mm Ø	tk 50552-03		
		1.5 mm Ø	tk 50552-04		
		1.0 mm Ø	tk 50552-05		
			tk 50552-07		

Rundschnittmesser
Circular cutting knife
Couteau rond
Cuchillo redondo
Coltello rotondo

Mikro-Ohrinstrumente
Instruments for micro ear-surgery

Instruments pour la micro-chirurgie auriculaire
Instrumentos para la micro-cirugía auricular
 Strumenti per micro-chirurgia auricolare



1:1



1:1



1:1

Z Ö L L N E R

90°

tk 50540-01

Rundschnittmesser, nach oben gebogen
Round knife, angled up

Couteau rond, coudé en haut
Cuchillo redondo, angulado arriba
 Coltello rotondo, angolato in alto

90°

tk 50540-02

Rundschnittmesser, nach unten gebogen
Round knife, angled down

Couteau rond, coudé en bas
Cuchillo redondo, angulado a bajo
 Coltello rotondo, angolato in basso

tk 50540-03

Sichelmesser, nach oben gebogen
Sickle knife, angled up

Couteau faucille, courbe vers le haut
Cuchillo de hoz, angulado arriba
 Coltello a forma di falce, angolato in alto



1:1



1:1



1:1

tk 50540-04

Sichelmesser, nach unten gebogen
Sickle knife, angled down

Couteau faucille, courbe vers le bas
Cuchillo de hoz, angulado a bajo
 Coltello a forma di falce, curvato in basso

tk 50540-05

Lanzennmesser, links gebogen
Lancet knife, curved to left

Couteau lancéolaire, courbe à gauche
Cuchillo lanceolado, angulado a la izquierda
 Coltello lanceolato, curvato a sinistra

tk 50540-06

Lanzennmesser, rechts gebogen
Lancet knife, curved to right

Couteau lancéolaire, courbe à droite
Cuchillo lanceolado, angulado a la derecha
 Coltello lanceolato, curvato a destra



1:1



1:1



1:1

tk 50540-07

Raspatorium, links gebogen
Raspatory, curved to left

Décolleur, courbe à gauche
Raspatorio, angulado a la izquierda
 Raspatorie, curvato a sinistra

tk 50540-08

Raspatorium, rechts gebogen
Raspatory, curved to right

Décolleur, courbe à droite
Raspatorio, angulado a la derecha
 Raspatorie, curvato a destra

tk 50540-09

Führungsgabel
Wire guide

Fourchette d'introduction
Tenedor guía
 Forchetta guida

Mikro-Ohrinstrumente
Instruments for micro ear-surgery

Instruments pour la micro-chirurgie auriculaire
Instrumentos para la micro-cirugía auricular
Strumenti per micro-chirurgia auricolare





ZÖLLNER

	0.5 mm - 45°	0.5 mm - 45°
tk 50541-01	tk 50541-02	tk 50541-03
Nadel fein, gerade, spitz <i>Needle fine, straight, sharp</i> Aiguille fine, droite, pointue <i>Aguja fina, recta, aguda</i> Ago fino, retto, acuto	Häkchen, nach oben gebogen <i>Hook, angled up</i> Crochet, coudé en haut <i>Gancho, curvado arriba</i> Uncino, curvato in alto	Häkchen, nach unten gebogen <i>Hook, angled down</i> Crochet, coudé en bas <i>Gancho, curvado a bajo</i> Uncino, curvato in basso
		
0.5 mm - 90°	0.5 mm - 90°	1.0 mm - 45°
tk 50541-04	tk 50541-05	tk 50541-06
Häkchen, nach oben gebogen <i>Hook, angled up</i> Crochet, coudé en haut <i>Gancho, curvado arriba</i> Uncino, curvato in alto	Häkchen, nach unten gebogen <i>Hook, angled down</i> Crochet, coudé en bas <i>Gancho, curvado a bajo</i> Uncino, curvato in basso	Häkchen, nach oben gebogen <i>Hook, angled up</i> Crochet, coudé en haut <i>Gancho, curvado arriba</i> Uncino, curvato in alto
		
1.0 mm - 45°	1.0 mm	1.0 mm
tk 50541-07	tk 50541-08	tk 50541-09
Häkchen, nach unten gebogen <i>Hook, angled down</i> Crochet, coudé en bas <i>Gancho, curvado a bajo</i> Uncino, curvato in basso	Häkchen, rund nach oben gebogen <i>Hook, curved up</i> Crochet, courbure rond vers le haut <i>Gancho, redondo, curvado arriba</i> Uncino, rotondo, curvato in alto	Häkchen, rund nach unten gebogen <i>Hook, curved down</i> Crochet, courbure rond ver le bas <i>Gancho, redondo, curvado a bajo</i> Uncino, rotondo, curvato in basso

Mikro-Ohrnadeln und Häkchen
Micro ear-needles and hooks

Micro-aiguilles et crochets auriculaires
Micro-agujas y ganchos auriculares
Micro-uncini ed aghi auricolari

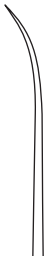

		
160 mm - 6 1/4"	160 mm - 6 1/4"	160 mm - 6 1/4"
tk 50543-01	tk 50543-02	tk 50543-03

Nadel fein, gerade, spitz
Needle fine, straight, sharp





Aiguille fine, droite, pointu
Aguja fina, recta, aguda
Ago fino, retto, acuto

Nadel, leicht gebogen, spitz
Needle, slightly curved, sharp

Aiguille, légèrement courbe, pointue
Aguja, ligeramente curva, aguda
Ago, legeremente curvato, acuto

Nadel, stark gebogen, spitz
Needle, strong curved, sharp

Aiguille, très courbe, pointue
Aguja, muy curvada, aguda
Ago, fortemente curvato, acuto

SHAMBAUGH				
	160 mm - 6 1/4"	160 mm - 6 1/4"	160 mm - 6 1/4"	0.6 mm
	45°	90°		160 mm - 6 1/4"
	0.4 mm	tk 50544-04	tk 50545-04	tk 50546-10
	0.6 mm	tk 50544-06	tk 50545-06	tk 50546-25

Häkchen, abgewinkelt
Hook, angled

Crochet, coudé
Gancho, acodado
Uncino, angolato

Häkchen, retrograd gebogen
Hook, retrograd

Crochet, courbe retrograde
Gancho, acodado, retrogrado
Uncino, curvato reterogrado

Häkchen, retrograd gebogen
Hook, retrograd

Crochet, courbe retrograde
Gancho, acodado, retrogrado
Uncino, curvato reterogrado

PLESTER	
	0.4 mm - 90°
	tk 50548-01



Fussplattenhäkchen, abgewinkelt, stumpf
Foot plate hook, angled, blunt

Crochet pour la platine de l'étrier, mousse
Gancho para placa de oído, romo
Uncino per placca di piede, smusso

PLESTER	
	0.4 mm - 45°
	tk 50549-01

Antrum Häkchen, aufgewinkelt, stumpf
Antrum hook, angled, blunt

Crochet pour l'antrum, coudé, mousse
Gancho para el antrum, acodado, romo
Uncino per antrum, angolato in alto, smusso

BARBARA			
	tk 50553-01	tk 50553-02	tk 50553-04
	spitz/gerade sharp/straight	stumpf/gewinkelt blunt/angled	spitz/gebogen sharp/curved
pointue/droite aguda/recta acuto/retta	mousse/coudée roma/angulada smusso/angolato	pointue/courbe aguda/curva acuto/curve	

Mikro-Ohrnadeln und Häkchen
Micro ear-needles and hooks

Micro-aiguilles et crochets auriculaires
Micro-agujas y ganchos auriculares
Micro-uncini ed aghi auricolari

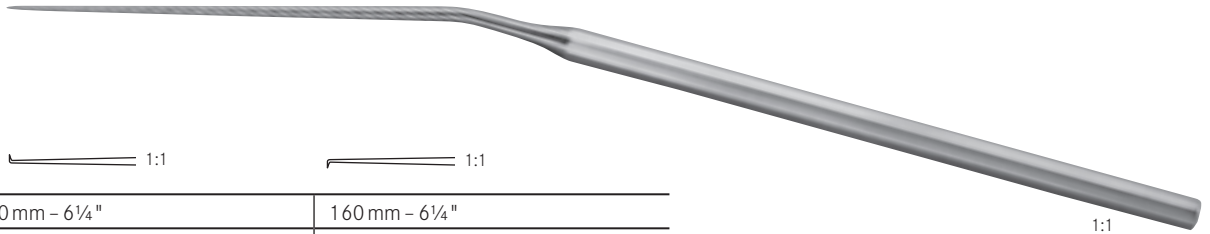

SHAMBAUGH

	160 mm - 6¼"	160 mm - 6¼"
	90°	90°
0.3 mm	tk 50558-03	tk 50559-03
0.6 mm	tk 50558-06	tk 50559-06
1.0 mm	tk 50558-10	tk 50559-10

Häkchen, nach oben gebogen
Hook, curved up
Crochet, coudé en haut
Gancho, curvado arriba
Uncino, curvato in alto

Häkchen, nach unten gebogen
Hook, curved down
Crochet, coudé en bas
Gancho, curvado a bajo
Uncino, curvato in basso

MCGEE

	160 mm - 6¼"	160 mm - 6¼"
0.5 mm	tk 50560-05	tk 50561-05
1.0 mm	tk 50560-10	tk 50561-10

Häkchen, rund, nach oben gebogen
Hook, round, curved up
Crochet, courbé ronde, vers le haut
Gancho, redondo, curvado arriba
Uncino, rotondo, curvato in alto

Häkchen, rund, nach unten gebogen
Hook, round, curved down
Crochet, courbé ronde vers le bas
Gancho, redondo, curvado arriba
Uncino, rotondo, curvato in basso

BARBARA

	0.5 mm
155 mm - 6"	tk 50562-01

ROSEN

	0.5 mm
160 mm - 6¼"	tk 50562-04

Nadel, leicht gebogen
Needle, slightly curved
Aiguille, légèrement courbée
Aguja, ligeramente, curvado
Ago, legermente curvato

MCGEE

	160 mm - 6¼"	160 mm - 6¼"	160 mm - 6¼"	160 mm - 6¼"
	25°	25°	45°	45°
0.3 mm	tk 50563-03	tk 50564-03	tk 50565-03	tk 50566-03
0.6 mm	tk 50563-06	tk 50564-06	tk 50565-06	tk 50566-06
1.0 mm	tk 50563-10	tk 50564-10	tk 50565-10	tk 50566-10

Häkchen, nach oben gebogen
Hook, curved up
Crochet, coudé en haut
Gancho, curvado arriba
Uncino, curvato in alto

Häkchen, nach unten gebogen
Hook, curved down
Crochet, coudé en bas
Gancho, curvado a bajo
Uncino, curvato in basso

Häkchen, nach oben gebogen
Hook, curved up
Crochet, coudé en haut
Gancho, curvado arriba
Uncino, curvato in alto

Häkchen, nach unten gebogen
Hook, curved down
Crochet, coudé en bas
Gancho, curvado a bajo
Uncino, curvato in basso

Mikro-Ohrraspatorien
Micro ear-raspatories

Micro-raspateurs auriculaires
Micro-raspatorias auriculares
Micro-raspatori auricolari



<p>1:1</p>	<p>1:1</p>	<p>1:1</p>	<p>1:1</p>
FISCH			
155 mm - 6"	155 mm - 6"	155 mm - 6"	155 mm - 6"
tk 50568-01	tk 50568-02	tk 50569-01	tk 50569-02

rechts abgewinkelt
angled to the right
coudé à droite
angulado por la derecha
angolato a destra

links abgewinkelt
angled to the left
coudé à gauche
angulado por la izquierda
angolato a sinistra

rechts abgewinkelt
angled to the right
coudé à droite
angulado por la derecha
angolato a destra

links abgewinkelt
angled to the left
coudé à gauche
angulado por la izquierda
angolato a sinistra

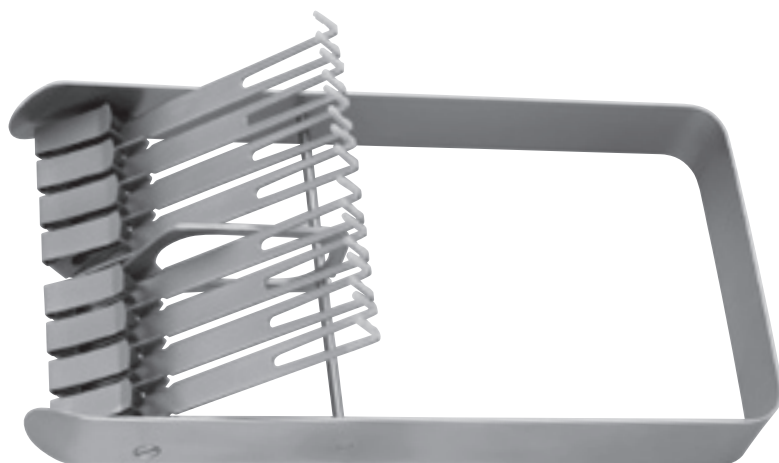

tk 50590-00

Rack für 8 Mikro-Ohr-Instrumente mit Sechs- oder Achtkantgriff
Rack for 8 each micro ear instruments with hexagonal or octagonal handle
Etagère pour 8 micro-instruments avec manches hexagonales o octogonales
Soporte para 8 micro-instrumentos con mangos hexagonales o octogonales
Supporto per 8 micro strumenti on manico esagonale e ottagonale

Mikro-Ohrlöffel
Micro ear-spoons

Micro-curettes auriculaires
Micro-curetas auriculares
Micro-cucchiai auricolari



1:1



1:1



1:1

SHEA

	1.5 mm x 2.5 mm	1.5 mm x 2.5 mm
160 mm - 6 1/4"	tk 50572-01	tk 50572-02

gerade
straight
droits
recta
retto

gebogen
curved
courbe
curva
curvo

HOUSE

170 mm - 6 3/4" **tk 50573-02**

Löffel, leicht gebogen
Spoon, slightly curved

Curette, légèrement coudée
Cureta, ligeramente curvada
Cucchiaio, leggermente curvato

170 mm - 6 3/4" **tk 50573-01**

Löffel, stark gebogen
Spoon, strong curved

Curette, fortement coudée
Cureta, muy curvada
Cucchiaio, fortemente curvato

Mikro-Ohrlöffel
Micro ear-spoons

Micro-curettes auriculaires
Micro-curetas auriculares
Micro-cucchiai auricolari

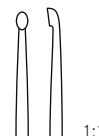
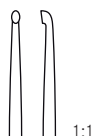

HOUSE

	1.0 mm Ø und 1.2 mm Ø	1.5 mm Ø und 1.8 mm Ø
150 mm - 6"	tk 50574-01	tk 50574-02

Löffel, leicht gebogen
Spoon, slightly curved

Curette, légèrement coudée
Cureta, ligeramente curvada
Cucchaio, leggermente curvato

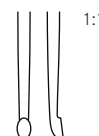

HOUSE

	1.0 mm Ø und 1.2 mm Ø	1.5 mm Ø und 1.8 mm Ø
150 mm - 6"	tk 50575-01	tk 50575-02

Löffel stark gebogen
Spoon strong curved

Curette fortement coudée
Cureta, muy curvada
Cucchaio, fortemente curvato

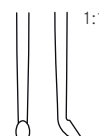
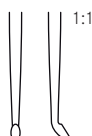

Mikro-Ohrmeißel und Hämmer
Micro ear-chisels and hammers

Micro burins auriculaires et marteaux
Micro cinceles auriculares y martillos
 Micro scalpelli per orecchio e martelli

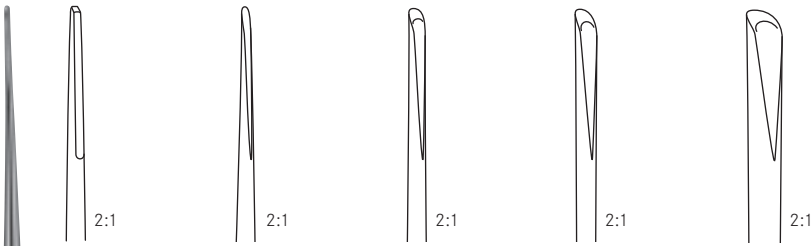

HEERMANN

0.7 mm	0.7 mm	1.0 mm	1.5 mm	3.0 mm
tk 50579-01	tk 50579-02	tk 50579-03	tk 50579-04	tk 50579-05

Flachmeißel <i>Chisel</i>	Hohlmeißel <i>Gouge</i>	Hohlmeißel <i>Gouge</i>	Hohlmeißel <i>Gouge</i>	Hohlmeißel <i>Gouge</i>
Ciseaux <i>Escoplo</i>	Gouge <i>Gubia</i>	Gouge <i>Gubia</i>	Gouge <i>Gubia</i>	Gouge <i>Gubia</i>
Scalpello	Sgorbia	Sgorbia	Sgorbia	Sgorbia

1:1



HEERMANN

tk 50580-10

Handgriff für Meißel (tk 50579-01 – tk 50579-05)
Handle for chisels (tk 50579-01 – tk 50579-05)

Manche pour ciseaux (tk 50579-01 – tk 50579-05)
Mango para escoplos (tk 50579-01 – tk 50579-05)

Manico per scalpelli/sgorbie (tk 50579-01 – tk 50579-05)



1:2

HEERMANN

195 mm – 7¾" **tk 50581-00**

Hammer, Metall
Metal hammer

Maillet en métal
Martillo, de metal
 Martello, acciaio



1:2

COTTLE

250 g
 190 mm – 7½" **tk 50581-19**

Hammer, Metall
Metal hammer

Maillet en métal
Martillo, de metal
 Martello, acciaio

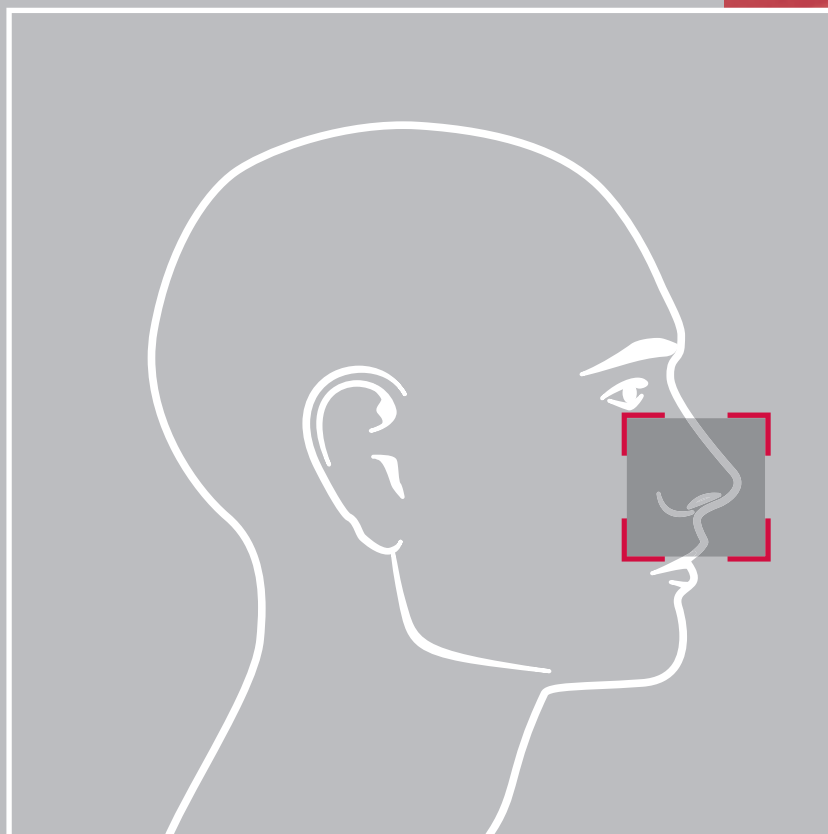

Rhinologie
Rhinology

Rhinologie
Rinología
Rinologia



Nasenspekula | Spéculums nasaux
Nasal specula | *Especulos nasales*
 Specoli nasali

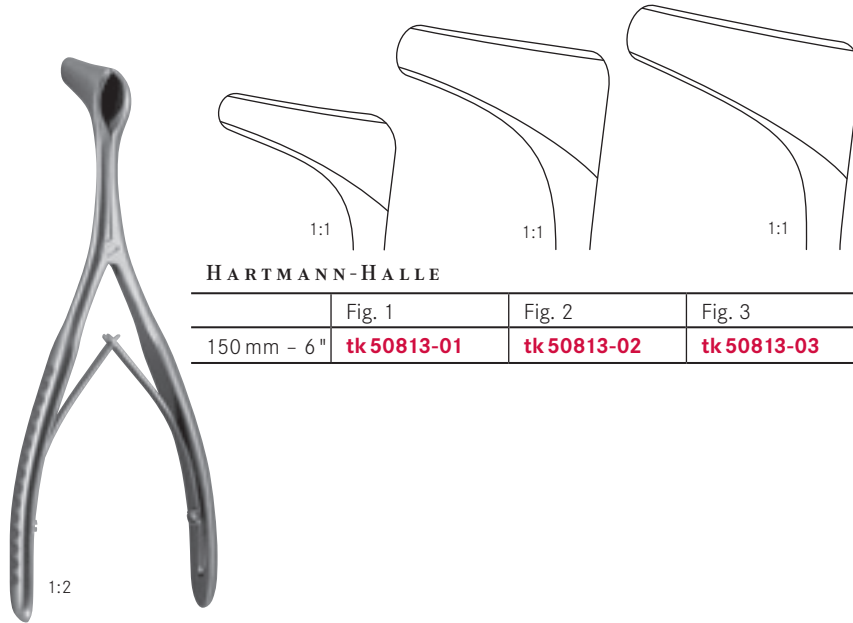

HARTMANN-HALLE

	Fig. 1	Fig. 2	Fig. 3
150 mm - 6"	tk 50813-01	tk 50813-02	tk 50813-03



TIECK-HALLE

135 mm - 5¼"	tk 50822-13	tk 50823-13
--------------	--------------------	--------------------

für Säuglinge
for babies

pour nourrissons
para lactantes
 per lattanti

für Kleinkinder
for infants

pour petits enfants
para niños pequeños
 per bambini



Alle Nasenspekula sind optional auch mit Feststellschraube erhältlich
All nasal specula are also available with locking screw
 Tous les spéculums nasaux sont aussi disponible avec une vis de fixation
Todos los especulos nasales son también disponibles con un tornillo de fijación
 Tutti gli speculi nasali sono disponibili anche con vite di fassaggio



Nasenspekula | Spéculums nasaux
 Nasal specula | Especulos nasales
 Specoli nasali

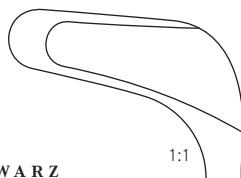
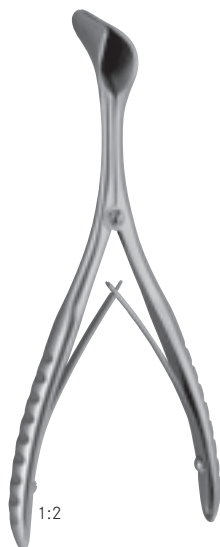

SCHWARZ
 140 mm - 5½" tk 50811-14

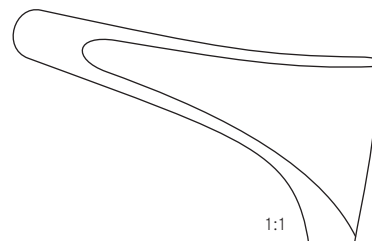
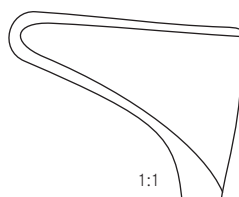
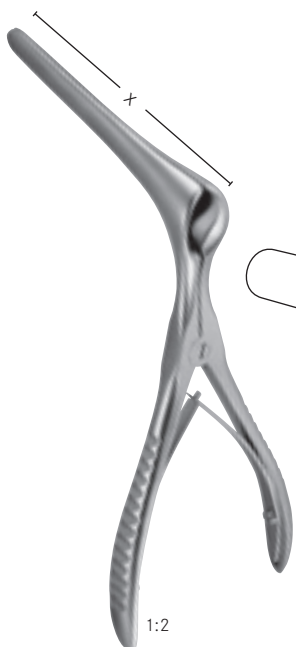

KILLIAN	
	Fig. 1
	x = 35 mm
130 mm - 5"	tk 50828-01
	Fig. 2
	x = 50 mm
	tk 50828-02

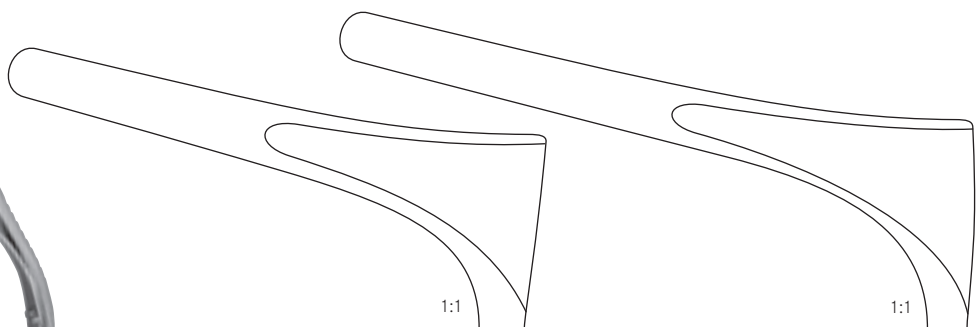

	Fig. 3
	x = 75 mm
130 mm - 5"	tk 50828-03
	Fig. 4
	x = 90 mm
	tk 50828-04



Alle Nasenspekula sind optional auch mit Feststellschraube erhältlich
 All nasal specula are also available with locking screw
 Tous les spéculums nasaux sont aussi disponible avec une vis de fixation
 Todos los espejuelos nasales son también disponibles con un tornillo de fijación
 Tutti gli specoli nasali sono disponibili anche con vite di fissaggio



Nasenspekula | Spéculums nasaux
Nasal specula | *Especulos nasales*
 Specoli nasali

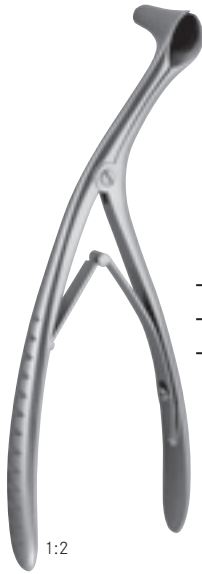

BECKMANN			
	Fig. 1	Fig. 2	Fig. 3
150 mm - 6"	tk 50830-01	tk 50830-02	tk 50830-03

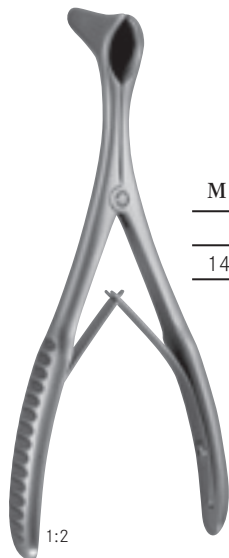

MOD. WIEN			
	Fig. 1	Fig. 2	Fig. 3
145 mm - 5¾"	tk 50834-01	tk 50834-02	tk 50834-03



Alle Nasenspekula sind optional auch mit Feststellschraube erhältlich
All nasal specula are also available with locking screw
 Tous les spéculums nasaux sont aussi disponible avec une vis de fixation
Todos los especulos nasales son también disponibles con un tornillo de fijación
 Tutti gli speculi nasali sono disponibili anche con vite di fissaggio



Nasenspekula | Spéculums nasaux
Nasal specula | *Especulos nasales*
 Specoli nasali



	Fig. 1	Fig. 2
	x = 35 mm	x = 50 mm
150 mm - 6"	tk 50836-35	tk 50836-50

	Fig. 3	Fig. 4
	x = 75 mm	x = 90 mm
150 mm - 6"	tk 50836-75	tk 50836-90



	x = 45 mm	x = 75 mm
140 mm - 5 1/2"	tk 50840-45	tk 50840-75

Nasenseptumspekulum, schwarz verchromt
Nasal septum speculum, black, chrome plated
 Spéculum pour la cloison nasale, chromé en noir
Especulo para el septo nasal, cromado en negro
 Specolo per il setto nasale, cromato nero



Alle Nasenspekula sind optional auch mit Feststellschraube erhältlich
All nasal specula are also available with locking screw
 Tous les spéculums nasaux sont aussi disponible avec une vis de fixation
Todos los especulos nasales son también disponibles con un tornillo de fijación
 Tutti gli specoli nasali sono disponibili anche con vite di fissaggio



Nasenspekula | Spéculums nasaux
Nasal specula | *Especulos nasales*
 Specoli nasali



VOLTOLINI			
	Fig. 1	Fig. 2	Fig. 3
75 mm - 3"	tk 50810-01	tk 50810-02	tk 50810-03

Ohr- und Nasenpinzetten | Pincés auriculaires et nasaux
Ear and nose dressing forceps | *Pinzas auriculares y nasales*
 Pinze auricolari e nasali

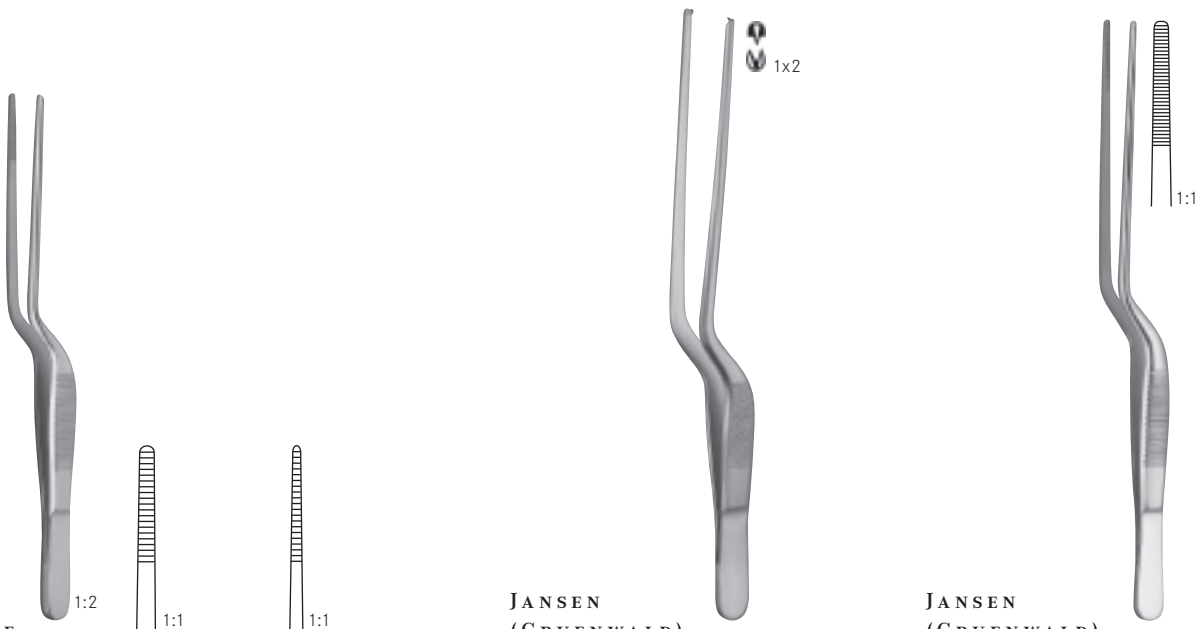

LUCAE		
140 mm - 5½"	tk 11605-14	tk 11606-14

JANSEN (GRUENWALD)	
160 mm - 6¼"	tk 11609-16
200 mm - 8"	tk 11609-20

JANSEN (GRUENWALD)	
160 mm - 6¼"	tk 11607-16
200 mm - 8"	tk 11607-20

Ohr- und Nasenpinzetten
Ear and nose dressing forceps

Pinces auriculaires et nasaux
Pinzas auriculares y nasales
Pinze auricolari e nasali

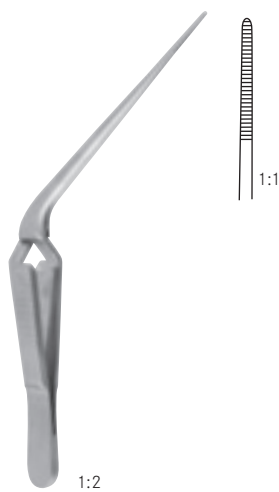
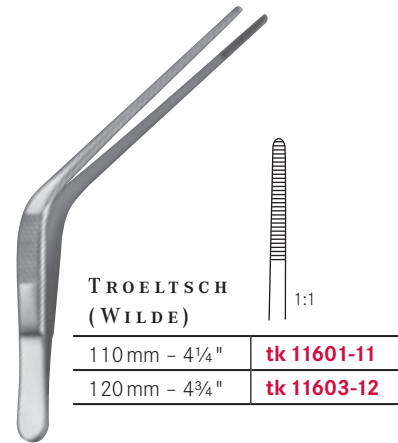
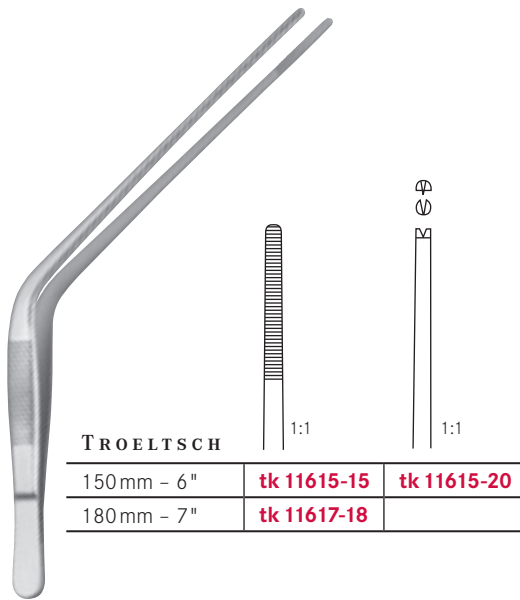

gekreuzt
cross
croisée
cruzado
crociato

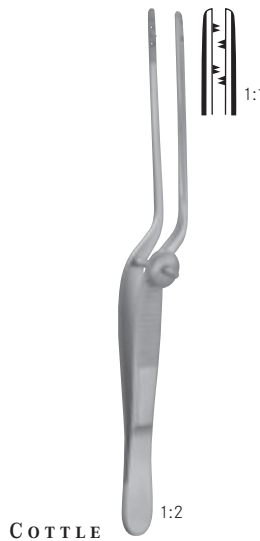

Columella Pinzette
Columella forceps
Pince à columella
Pinza para columella
Pinza per columella

Nasenscheren
Nasal scissors

Ciseaux nasaux
Tijeras nasales
Forbici nasali



SAILER

170 mm - 6 3/4"

tk 9132-17



HEYMANN

180 mm - 7"

tk 9137-18



FOMON

130 mm - 5"

tk 9152-13



COTTLE

160 mm - 6 1/4"

tk 9157-16

Nasenschere | Ciseaux nasales
 Nasal scissors | Tijera nasal
 Forbice nasale

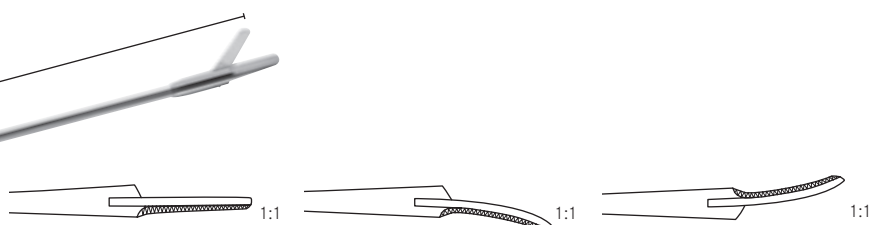
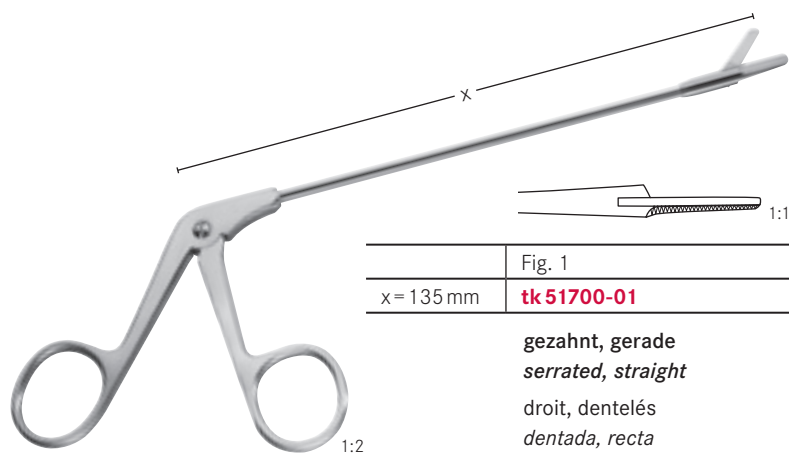

	Fig. 1	Fig. 2	Fig. 3
x = 135 mm	tk 51700-01	tk 51700-02	tk 51700-03
	gezahnt, gerade serrated, straight droit, dentelés dentada, recta dentata, retta	gezahnt, rechts serrated, right dentelés, droites dentada, derecha dentata, destra	gezahnt, links serrated, left dentelés, gauche dentada, izquierda dentata, sinistra

Nasenpolypenzangen – Septumzangen | Pincas à polypes et la cloison nasale
 Nasal polypus and septum forceps | Pinzas para pólipos y el tabique nasal
 Pinze per polipi e setto nasale



WESTMACOTT
 200 mm - 8" | **tk 51065-20**



LUBET-BARBON
 200 mm - 8" | **tk 51066-20**



HARTMANN
 160 mm - 6¼" | **tk 51067-16**
 200 mm - 8" | **tk 51071-20**

Nasenpolypenzangen – Septumzangen
Nasal polypus and septum forceps

Pinces à polypes et la cloison nasale
Pinzas para pólipos y el tabique nasal
Pinze per polipi e setto nasale

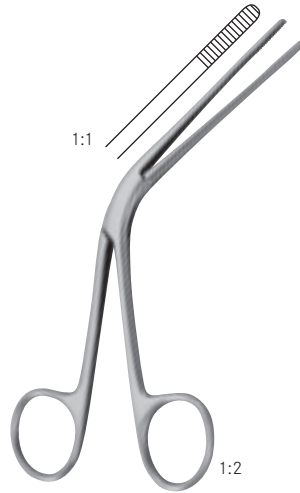

TILLEY

140mm - 5½"

tk51068-14

Nasentamponzange
Nasal dressing forceps

Pince à pansement pour le nez
Pinza para tampones nasales
Pinza per tamponamento nasale

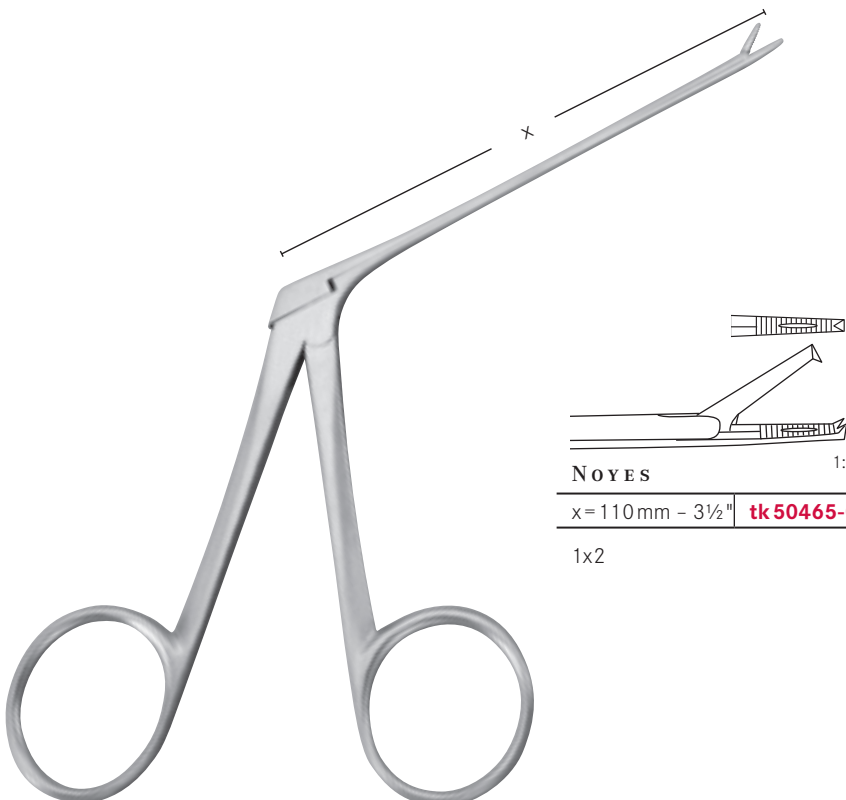

NOYES

x = 110mm - 3½"

tk50465-09

1x2

Nasenpolypenzangen – Septumzangen | Pincers à polypes et la cloison nasale
Nasal polypus and septum forceps | Pinzas para pólipos y el tabique nasal
 Pinze per polipi e setto nasale



HEYMANN-KNIGHT
 180 mm - 7" | **tk 51069-18**



CRAIG
 180 mm - 7" | **tk 51116-18**



KNIGHT
 180 mm - 7" | **tk 51099-18**



HEYMANN
 180 mm - 7" | **tk 51095-01** | **tk 51095-02** | **tk 51095-03**

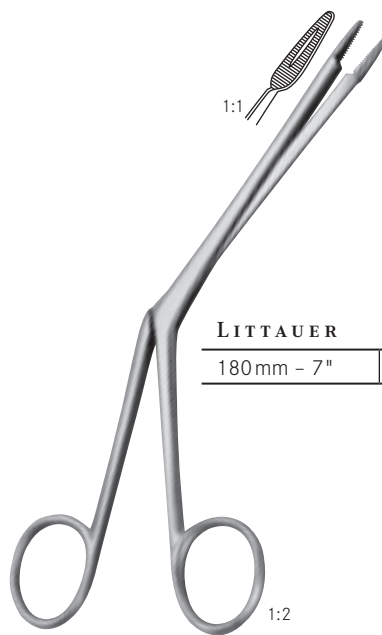

LITTAUER
 180 mm - 7" | **tk 51079-18**

Septumzangen
Septum forceps

Pinces pour la cloison nasale
Pinzas para el tabique nasal
Pinze per il setto nasale

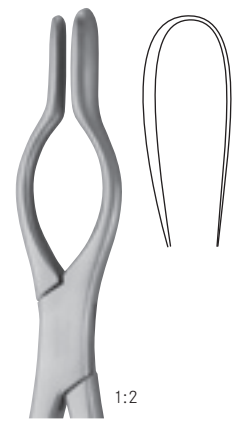
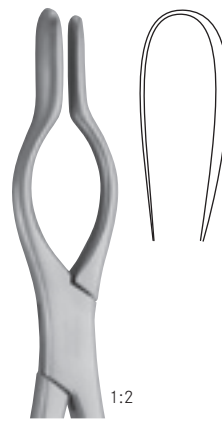

COTTLE-WALSHAM

230 mm - 9"

tk 51695-01

tk 51695-02

tk 51695-03

gerade
straight
droit
recta
rette

links
left
à gauche
izquierda
a sinistra

rechts
right
à droite
derecha
a destra

Scharfe Nasenzangen
Nasal cutting forceps

Pinces coupantes pour le nez
Pinzas nasales cortantes
Pinze taglianti per naso

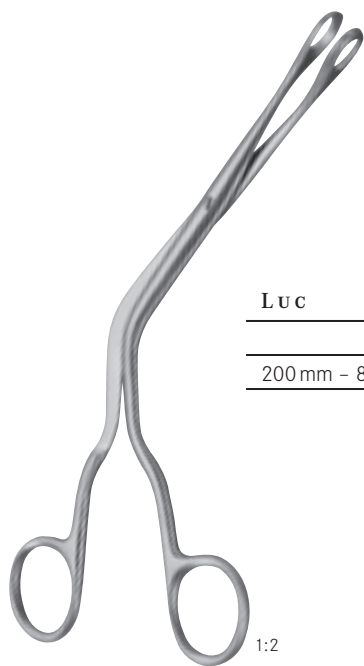

L u c	1:1		1:1	
	Fig. 1	Fig. 2	Fig. 1	Fig. 2
200 mm - 8"	tk 51121-01	tk 51121-02	tk 51120-01	tk 51120-02

gefenstert
fenestrated
fenêtré
fenestrado
finestrato

voll
full
pleine
lleno
pieno

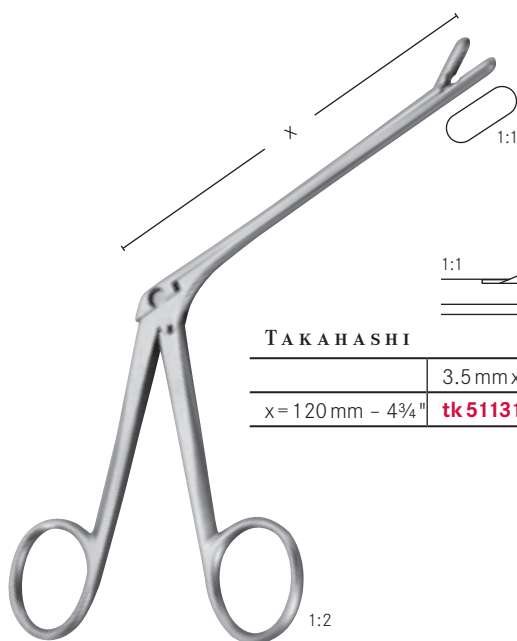

TAKAHASHI		
	3.5 mm x 10 mm	3.5 mm x 10 mm
x = 120 mm - 4¾"	tk 51131-12	tk 51133-12

Scharfe Nasenzangen
Nasal cutting forceps

Pincès coupantes pour le nez
Pinzas nasales cortantes
Pinze taglianti per naso

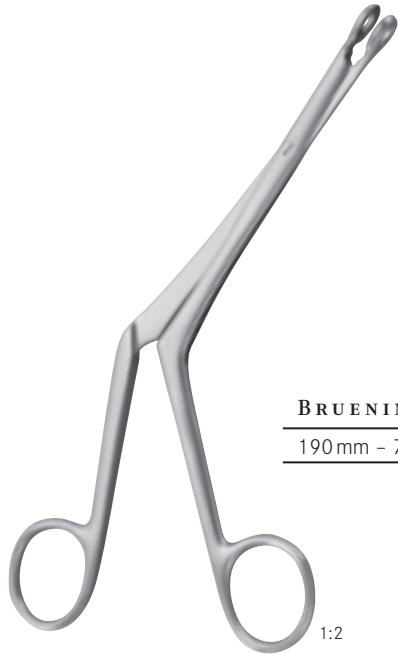

BRUENINGS

190 mm - 7½"



1:1



1:1



1:1



1:1

tk 51123-01

tk 51123-02

tk 51123-03

tk 51123-04

1:2

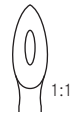
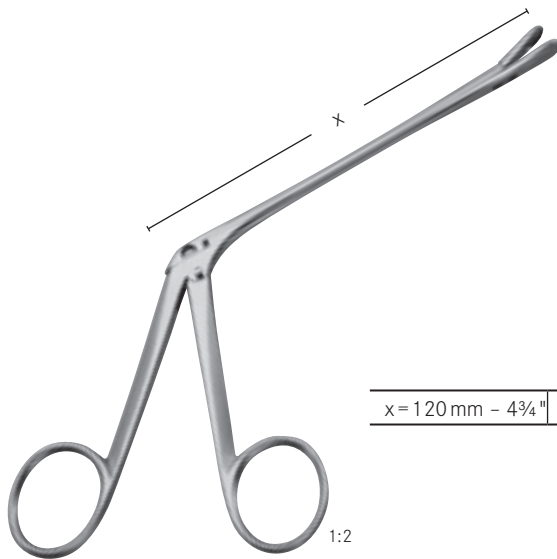

1:1

WEIL



1:1

WATSON-WILLIAMS



1:1

x = 120 mm - 4¾"

tk 51147-12

tk 51141-10

tk 51143-12

1:2

Scharfe Nasenzangen
Nasal cutting forceps

Pinces coupantes pour le nez
Pinzas nasales cortantes
 Pinze taglianti per naso

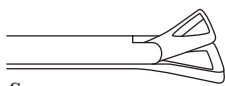

SCHMEDEN

x = 120 mm - 4 3/4"



1:1

tk51171-11

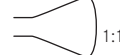

1:1

tk51171-12

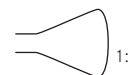

1:1

tk51171-13

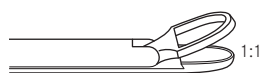

1:1

TOMATI

x = 120 mm - 4 3/4"

tk51173-12



1:1

STRUYCKEN

x = 120 mm - 4 3/4"

0.9 mm

1.2 mm

tk51174-01

tk51174-02

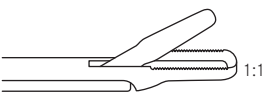

1:1

HENKE

x = 120 mm - 4 3/4"

tk51176-01

Scharfe Nasenzangen
Nasal cutting forceps

Pincès coupantes pour le nez
Pinzas nasales cortantes
Pinze taglienti per naso



Fig. 10

Fig. 11

x = 115 mm - 4½'''

tk 51729-00

tk 51729-01

gerade
straight
droit
recta
retta



Fig. 12

Fig. 13

Fig. 14

1:1

x = 115 mm - 4½'''

tk 51729-02

tk 51729-03

tk 51729-04

aufgewinkelt
angeled up
angulée
angulada
angulata



Fig. 1

Fig. 2

x = 140 mm - 5½'''

tk 51729-05

tk 51729-06

feines Modell, gerade
delicate model, straight
modèle délicat, droit
modelo fino, recta
modelo fino, retta

Scharfe Nasenzangen
Nasal cutting forceps

Pincas coupantes pour le nez
Pinzas nasales cortantes
 Pinze taglianti per naso

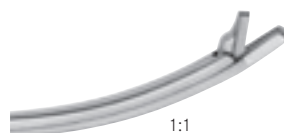

	Fig. 8
x = 140 mm - 5 1/2'''	tk 51735-00

	Fig.3
	tk 51735-01

aufgebogen
curved up
 courbe vers le haut
curve arriba
 curva in alto

feines Modell, aufgebogen
delicate model, curved up
 modèle délicat, courbe vers le haut
modelo fino, curve arriba
 modelo fino, curva in alto

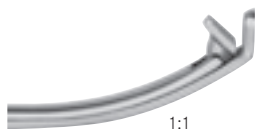

	Fig. 15
x = 140 mm - 5 1/2'''	tk 51735-02

feines Modell, aufgebogen und gewinkelt
delicate model, curved up and angled
 modèle délicat, courbe vers le haut et angulée
modelo fino, curve arriba y angulada
 modelo fino, curva in alto e angulata

Scharfe Nasenzangen
Nasal cutting forceps

Pincès coupantes pour le nez
Pinzas nasales cortantes
Pinze taglianti per naso

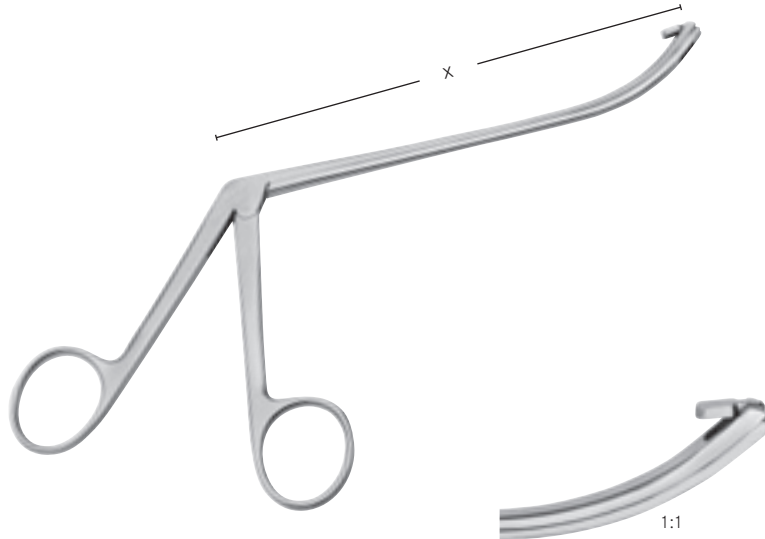

	Fig. 7
x = 140 mm - 5½'''	tk 51736-00

rückwärts schneidend, aufgebogen
backward cutting, curved up
coupe retrograde, courbe vers le haut
corte retrogrado, curva arriba
corte indietro, curva in alto

Scharfe Nasenzangen
Nasal cutting forceps

Pincas coupantes pour le nez
Pinzas nasales cortantes
Pinze taglianti per naso



	Fig. 4	Fig. 5
x = 140 mm - 5½'''	tk 51737-00	tk 51737-01

feines Modell
delicate model
modèle délicat,
modelo fino,
modelo fino,

gerade
straight
droit
recta
retta

aufgewinkelt
angled
angulée
angulada
angulata

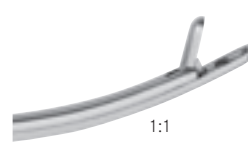
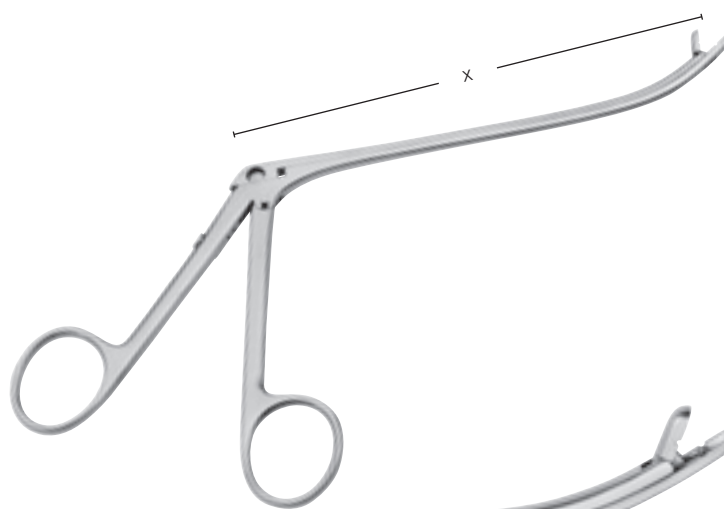

	Fig. 9	Fig. 6
x = 140 mm - 5½'''	tk 51737-02	tk 51737-03





Standard, aufgebogen
standard model, upcurved
modèle standard, angulée
modelo estandar, angulada
modelo standsrd, angulata

feines Modell, aufgebogen
delicate model, upcurved
modèle délicat, courbe vers le haut
modelo fino, curve arriba
modelo fino, curva in alto

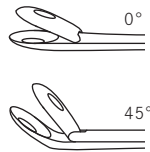
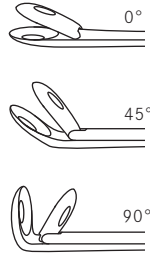
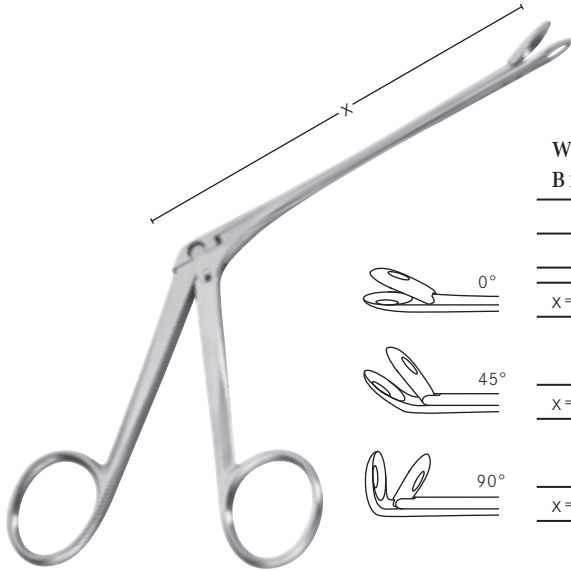
Scharfe Nasenzangen
Nasal cutting forceps

Pincès coupantes pour le nez
Pinzas nasales cortantes
Pinze taglianti per naso



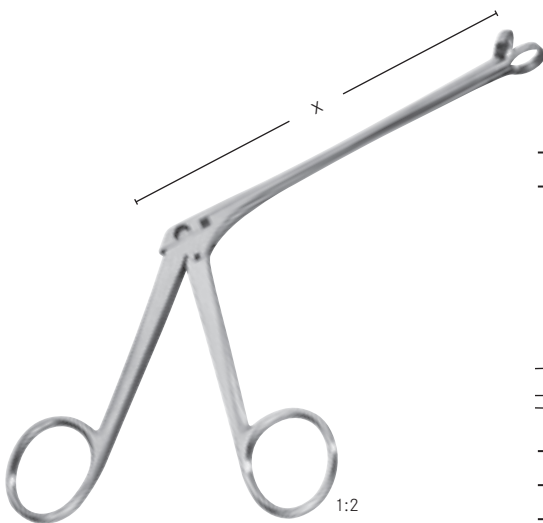

		WEIL- BLAKESLEY				
		 1:1	 1:1	 1:1	 1:1	 1:1
		Fig. 1	Fig. 2	Fig. 3	Fig. 4	Fig. 5
		a = 3.0 mm	a = 3.5 mm	a = 4.5 mm	a = 5.0 mm	a = 5.5 mm
x = 120 mm - 4¾"		tk 51155-01	tk 51155-02	tk 51155-03	tk 51155-04	tk 51155-05
x = 120 mm - 4¾"		tk 51158-01	tk 51158-02	tk 51158-03	tk 51158-04	
x = 120 mm - 4¾"		tk 51159-01	tk 51159-02	tk 51159-03		
		Fig. 1	Fig. 2	Fig. 3	Fig. 4	Fig. 5
		a = 3.0 mm	a = 3.5 mm	a = 4.5 mm	a = 5.0 mm	a = 5.5 mm
x = 180 mm - 7"		tk 51160-01	tk 51160-02	tk 51160-03	tk 51160-04	tk 51160-05
x = 180 mm - 7"		tk 51161-01	tk 51161-02	tk 51161-03	tk 51161-04	

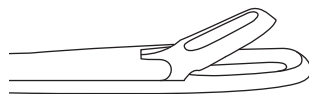

		HARTMANN			
		 1:1	 1:1	 1:1	 1:1
x = 120 mm - 4¾"		tk 51165-01	tk 51165-02	tk 51165-03	tk 51165-04



		MYLES		
		 1:1	 1:1	 1:1
		Fig. 1	Fig. 2	Fig. 3
		2.0x10.0 mm	2.5x12.0 mm	3.0x14.0 mm
x = 120 mm - 4¾"		tk 51162-01	tk 51162-02	tk 51162-03

Durchschneidende Nasenzangen
Nasal through cutting forceps

Pinces coupantes pour le nez
Pinzas nasales cortantes
 Pinze taglianti per naso



	x=130 mm	x=130 mm	x=130 mm	x=130 mm
a = 2.5 mm	tk 51156-01	tk 51156-21	tk 51156-04	tk 51156-24
a = 3.5 mm	tk 51156-02	tk 51156-22	tk 51156-05	tk 51156-25
a = 4.0 mm	tk 51156-03	tk 51156-23	tk 51156-06	tk 51156-26

Maul	gerade	gerade, gezahnt	45° aufwärts	45° aufwärts, gezahnt
Jaw	straight	straight, serrated	45° upwards	45° upwards, serrated
Mors	droit	droit, dentelé	45° vers le haut	45° vers le haut, dentelé
Boca	recta	recta, dentada	45° arriba	45° arriba, dentada
Morso	retta	retta, dentata	45° verso l'alto	45° verso l'alto, dentata

Nasenmesser | **Bistouris pour nez**
Nasal knives | **Cuchillos nasales**
Bisturi per naso

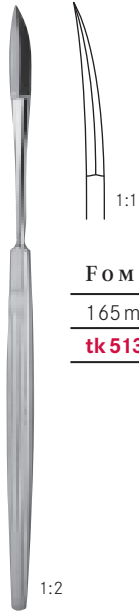

FOMON

165 mm - 6½"

tk 51300-16



JOSEPH

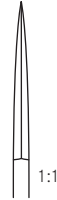

1:1

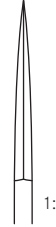

1:1



1:1



1:1

	Fig. 1	Fig. 2	Fig. 1	Fig. 2
160 mm - 6¼"	tk 51302-01	tk 51302-02	tk 51303-01	tk 51303-02

scharf/spitz gerade
sharp/sharp straight
tranchant/pointu droit
cortante/agudo recta
acuto retto

gebogen
curved
courbe
curva
curvo



JOSEPH

140 mm - 5½"

tk 51306-15



COTTLE

150 mm - 6"

tk 51308-15



JOSEPH

175 mm - 7"

tk 51335-03



BRUENINGS

165 mm - 6½"

tk 51310-00

tk 51310-01

Ersatzklinge
Spare blade

Lame de rechange
Hoja de recambio
Lama di ricambio

Nasenmesser
Nasal knives

Bistouris pour nez
Cuchillos nasales
Bisturi per naso



1:2

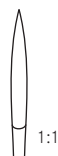

1:1

GERZOG

160mm - 6 1/4"

tk 50712-16



1:1

BUCK

160mm - 6 1/4"

tk 50714-16



1:2

CONVERSE

160mm - 6 1/4"

tk 51355-01



1:2



1:2

FREER

190mm - 6 1/2"

tk 51350-01

tk 51350-02



1:2

FREER

150mm - 6"

tk 51342-12



1:2

FREER

150mm - 6"

tk 51344-15



1:2

FREER

150mm - 6"

tk 51346-15

Nasenhäkchen
Nasal hooks

Crochets nasales
Ganchitos nasales
Uncini nasali

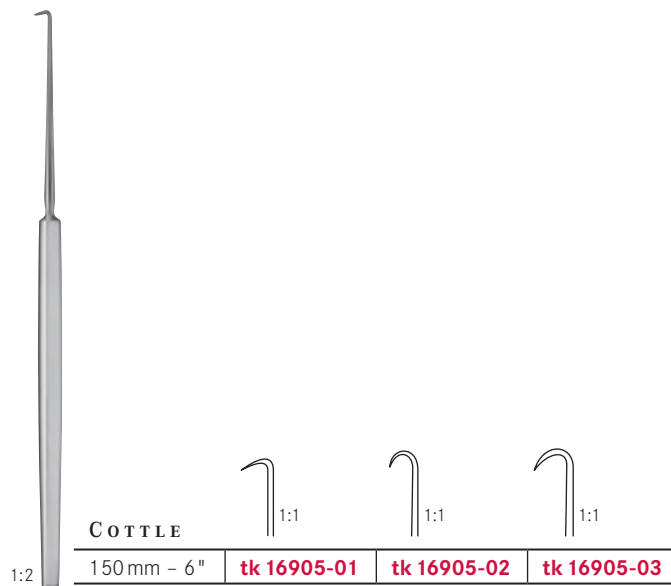
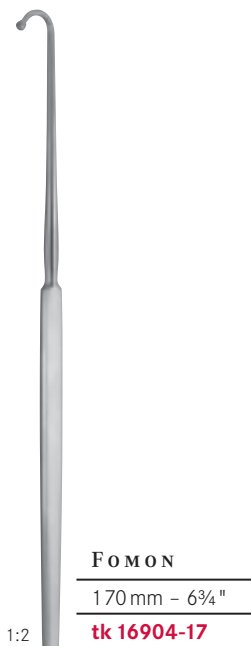
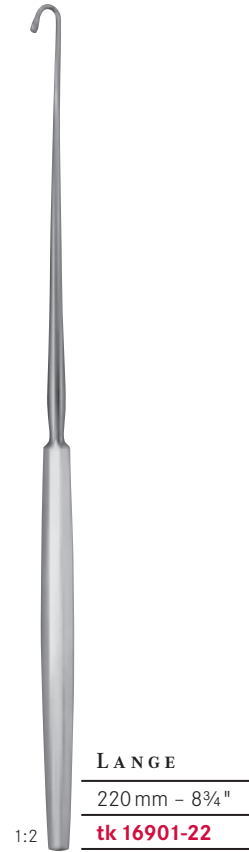



Nasenhäkchen
Nasal hooks

Crochets nasales
Ganchitos nasales
Uncini nasali





1:2

ITERSON		
160 mm - 6¼"	 1:1 tk 16920-16	 1:1 tk 16922-16
	scharf sharp pointu agudo acuto	stumpf blunt mousse romo smusso







1:2

GILLIES		
	 1:1 Fig. 1	 1:1 Fig. 2
180 mm - 7"	tk 48130-01	tk 48130-02



1:2

JOSEPH					
	 1:1	 1:1	 1:1	 1:1	
	2 mm	5 mm	7 mm	10 mm	
160 mm - 6¼"	tk 16910-02	tk 16910-05	tk 16910-07	tk 16910-10	

Nasenhäkchen | **Crochets nasales**
Nasal hooks | **Ganchitos nasales**
| **Uncini nasali**



**COTTLE-
NEIVERT**

200 mm - 8"

tk 16912-20

1:2



FOMON

160 mm - 6¼"

tk 16914-16

1:2



COTTLE

150 mm - 6"



1:1

tk 16915-01

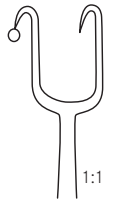

1:1

tk 16915-02



1:1

tk 16915-03

1:2



NEIVERT

160 mm - 6¼"

tk 16916-16

1:2

Nasen- und Trachealhäkchen
Trachea and nose retractors

Ecarteurs nasales et tracheales
Separadores traqueales y nasales
Uncini tracheali e nasali



COTTLE

150 mm - 6"

tk 16917-15

tk 16918-15

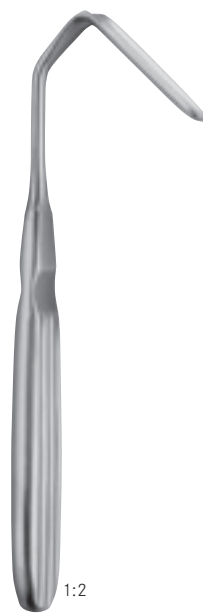

AUFRICHT

190 mm - 6 1/4"

tk 16906-19



KILNER

100 mm - 4"

tk 16907-10



CONVERSE

120 mm - 4 3/4"

tk 16908-12



LUKENS

170 mm - 6 2/5"

tk 16933-17

stumpf
blunt

mousse
romo
smusso

1:2



JACKSON

150 mm - 6"

tk 16930-15

1:2



AUFRICHT

tk 17919-13

Nasenhaken
Nasal hook

Crochet pour le nez
Gancho para la nariz
Uncino nasale



COTTLE

tk 17750-00

Daumenhaken
Thumb hook

Crochet pour le doigt
Gancho para el dedo
Uncino da fissare sul pollice

Ringmesser
Adenoid curettes

Couteaux à végétations adénoïdes
Cuchillos para vegetaciones adenoides
Adenotomi

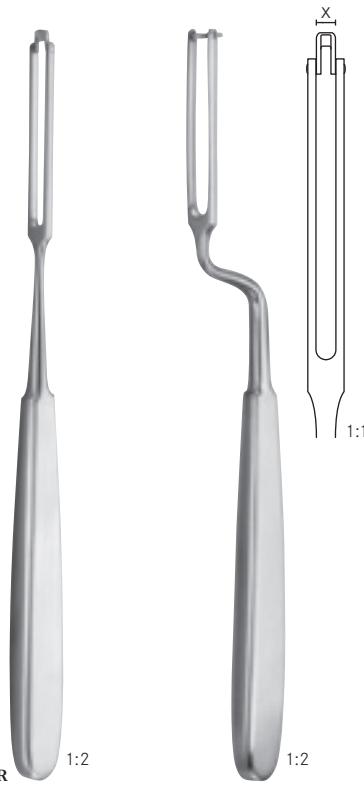

BALLENGER

	200 mm - 8"	200 mm - 8"
x = 3 mm	tk 51410-03	tk 51411-03
x = 4 mm	tk 51410-04	tk 51411-04
x = 5 mm	tk 51410-05	tk 51411-05

gerade
straight
droit
recto
rette

bajonett
bayonet
baionette
bayoneta
baionetta

Nasenpolypenschnürer
Nasal polypus snares

Serre noeuds pour polypes
Polipótomos nasales
 Serranodi nasali



0.3 mm Ø x 100 mm **tk 50320-30**

in Bündeln mit 12 Stück
in bundles of 12 pieces

en paquets de 12 pièces
en liós de 12 piezas
 pacchetto di 12 pezzi



KRAUSE

260 mm - 10¼" **tk 50323-26**



KRAUSE-VOSS

260 mm - 10¼" **tk 50325-26**

mit 2 Aufsätzen
with 2 inserts

avec 2 guide-anses
con 2 guias
 con 2 guide ansa



LANGE-WILDE

240 mm - 9½" **tk 50328-24**

Flexibler Spannarm
Flexible tension arm

Bras flexible
Brazo flejible
Braccio flessibile

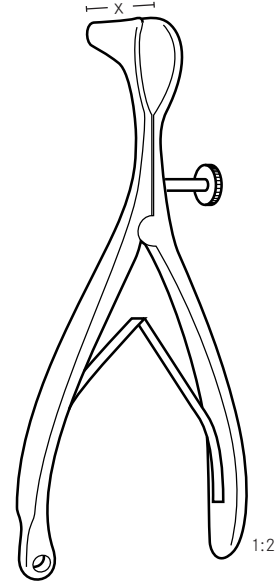

COTTLE-MASING

	140 mm - 5½"
x = 35 mm	tk 50837-35
x = 50 mm	tk 50837-50
x = 75 mm	tk 50837-75
x = 90 mm	tk 50837-90

Nasenseptumspekulum mit Stellschraube für flexibler Spannarm
Nasal septum speculum, With Set Screw for flexible tension arm

Spéculum pour la cloison nasale, pour tendeur flexible
Especulo para el septo nasal, para brazo flejible
Specolo per il setto nasale, per braccio flessibile

tk 50029-00

Flexibler Spannarm mit Befestigungsstange für OP-Tische
Flexible tension arm with holding rod for OP-tables

Tendeur flexible avec tige pour tables d'opérations
Brazo flejible con tija para mesas de operaciones
Braccio flessibile con morsetto per tavoli operatore

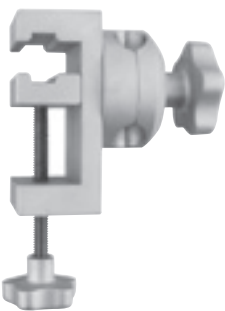

tk 50029-01

Drehbare Halterung für flexiblen Spannarm
Rotatable holder for flexible tension arm

Support rotatif pour tendeur flexible
Soporte giratorio para brazo flejible
Supporto rotante per braccio flessibile



tk 50029-03

Endoskophalterung
Endoscope holder

Support pour optiques
Soporte para opticas
Supporto per ottiche

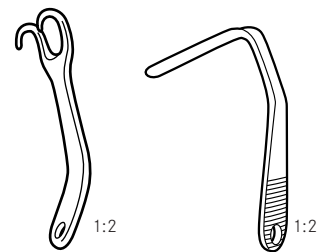

AUFRICHT

62 mm - 2½"	59 mm - 2¼"
tk 16906-01	tk 16906-02

Haken für flexiblen Spannarm
Hooks for flexible tension arm

Crochets pour tendeur flexible
Ganchos para brazo flejible
Uncini per braccio flessibile

Nasenspiegel
Nasal mirror

Miroir nasal
Espejo nasal
Specchio nasale

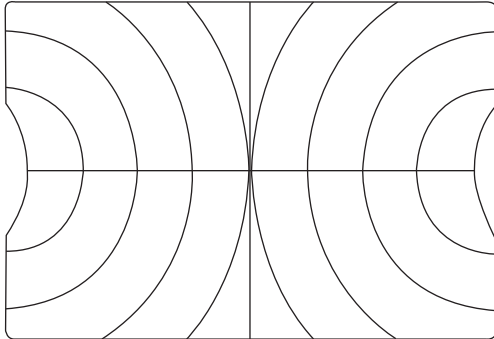

GLATZEL

200 x 130 mm

tk 50870-00

Nasenspiegel

Nasal mirror

Miroir nasal

Espejo nasal

Specchio nasale

Pulverbläser
Atomizer

Pulvérisateur
Pulverizador
Soffiatori



UNIVERSAL

tk 50924-00

Pulverbläser, komplett mit beweglicher Düse, Flasche 30 ccm

Atomizer, complete with movable tube, bottle 30 ccm

Pulvérisateur, complet avec tuyère mobile, flacon 30 ccm

Pulverizador, completo con tubo móvil, botella 30 ccm

Soffiatore, completo con ugello mobile, bottiglia 30 ccm

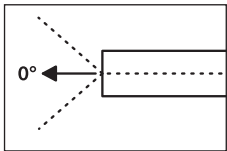
Naso-Pharyngoskope
Naso-pharyngoscopes
Nasopharyngoscopes
Nasofaringoscopios flexibles
Nasofaringoscopio flessibile

Konventionelles Bildbündel, mit 2-fach Abwinkelung (160°), Einhandbedienung, einlegbar und gassterilisierbar
Conventional bundle, 2-way deflection (160°), one-hand control, soakable, gas-sterilization.

Localisation conventionelle, dirigable en 2 directions (160°). Commande avec 1 main, sterilisable à froide ou à gaz
Transmisión a fibra optica, dirigible en 2 direcciones (160°), manejable con 1 mano, sumergible, esterilizable a gas
 Fascio di fibre convenzionale, doppia angolazione (160°), controllabile con una sola mano, sterilizzabile a gas, immergibile

Ø 3.2 mm – 300 mm	20 mm	3 mm – 60 mm	8000	tk 700-269
Ø, Arbeitslänge	Länge d. abwinkelbaren Spitze	Tiefenschärfe	Pixel	
Ø, Working length	Length of movable tip section	Depth of focus	Pixel	
Ø, Longueur de travail	Longueur du tip mobil	Profondeur de champ	Pixel	
Ø, Longitud de trabajo	Longitud de la punta movil	Profundidad de campo	Pixel	
Ø, Lunghezza operativa	Lunghezza della punta mobile	Profondità di campo	Pixel	

Konventionelles Bildbündel, Abwinkelung (140°), Instrumentenkanal, Einhandbedienung, einlegbar und gassterilisierbar
Conventional bundle, deflection (140°), instrument channel, one-hand control, soakable, gas-sterilization.

Localisation conventionelle, dirigable (140°). canal d'instrument, commande avec 1 main, sterilisable à froide ou à gaz
Transmisión a fibra optica, dirigible (140°), canal para instrumentos, manejable con 1 mano, sumergible, esterilizable a gas
 Fascio di fibre convenzionale, angolazione (140°), canale operativo, controllabile con una sola mano, sterilizzabile a gas, immergibile

Ø 4.3 mm – 400 mm	Ø 1.4 mm	3 mm – ∞	7800	tk 700-267
Ø, Arbeitslänge	Instrumentenkanal	Tiefenschärfe	Pixel	
Ø, Working length	Instrument channel	Depth of focus	Pixel	
Ø, Longueur de travail	Canal d'instrument	Profondeur de champ	Pixel	
Ø, Longitud de trabajo	Canal para instrumentos	Profundidad de campo	Pixel	
Ø, Lunghezza operativa	Canale operativo	Profondità di campo	Pixel	



Auf Wunsch ist das Naso-Pharyngoskop mit einer Linkshänderbedienung erhältlich.
If required, the naso-pharyngoscope is available for left-hand use.
 Sur demande, également disponible pour gauchers
Para zurdos disponible sobre demanda
 Su richiesta il nasofaringoscopio è disponibile per mancini



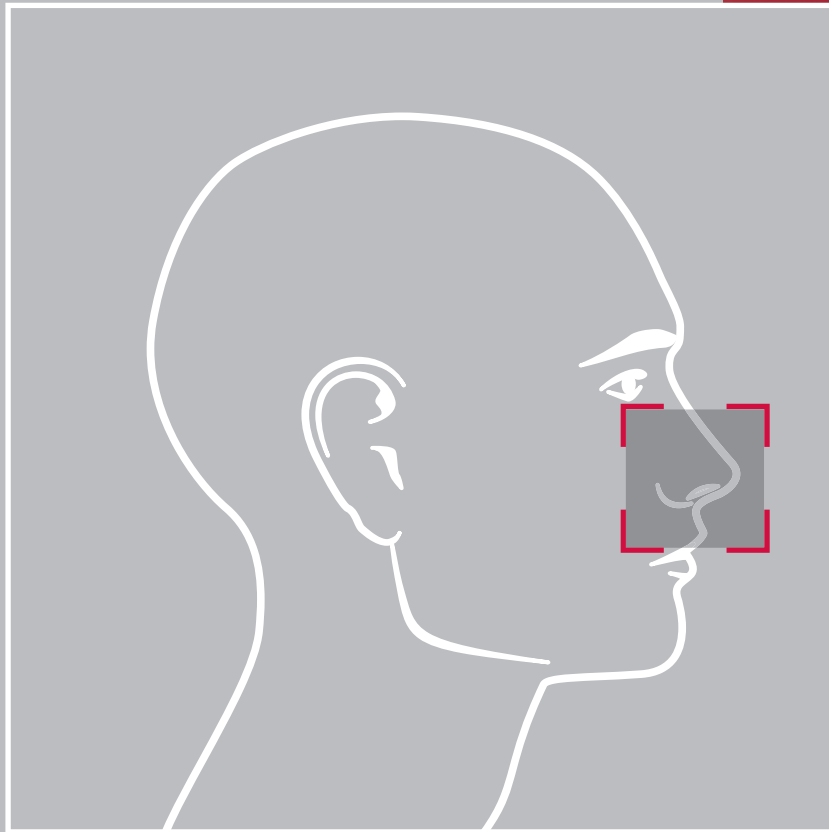

Rhinoplastik | Rhinoplastique
Rhinoplasty | *Rinoplastica*
Rinoplastica



Nasensägen | Scies nasales
Nasal saws | *Sierras nasales*
Seghe nasali



JOSEPH
190 mm - 7½" | 190 mm - 7½"
tk 51661-01 | **tk 51661-02**



JOSEPH
190 mm - 7½"
tk 51661-03

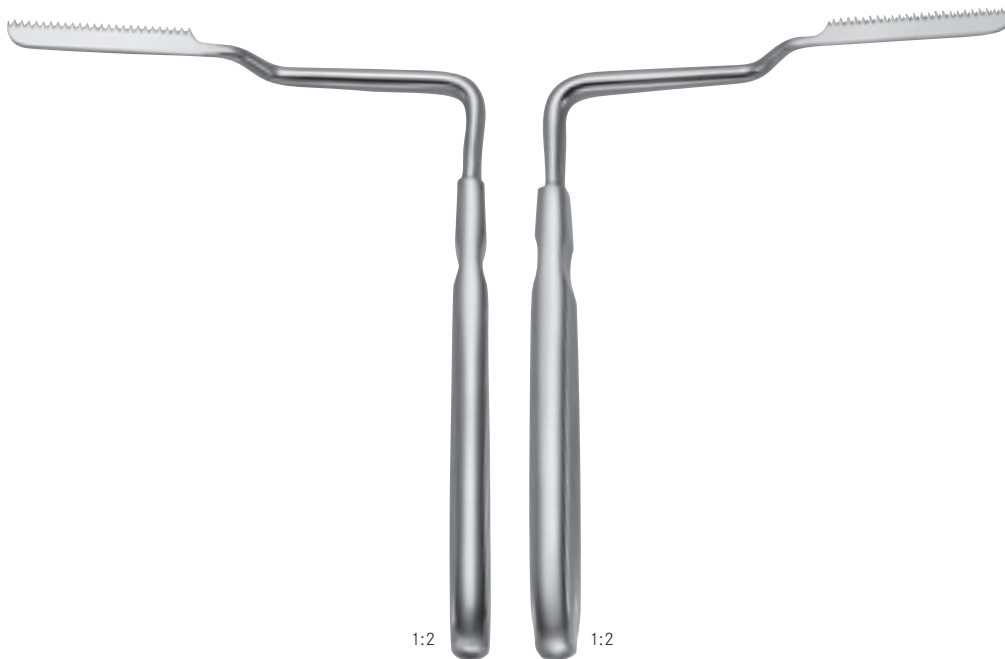

JOSEPH
170 mm - 6¾" | 170 mm - 6¾"
tk 51655-20 | **tk 51657-20**

Nasenraspeln
Nasal rasps

Râpes nasales
Limas nasales
Raspe nasali

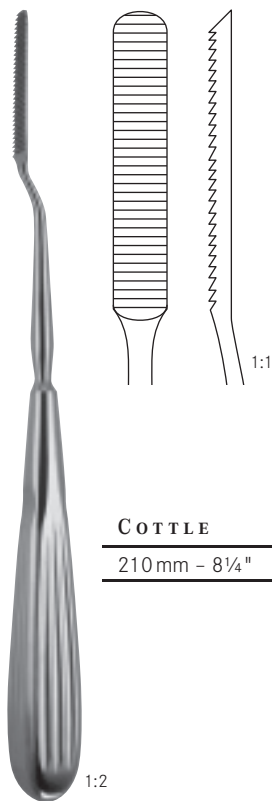

COTTLE

210 mm - 8¼"	tk 51665-21
--------------	--------------------

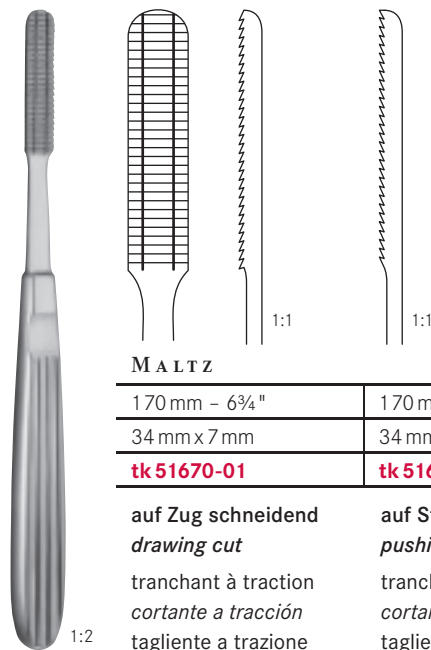

MALTZ

170 mm - 6¾"	170 mm - 6¾"
34 mm x 7 mm	34 mm x 7 mm
tk 51670-01	tk 51670-02

auf Zug schneidend
drawing cut
tranchant à traction
cortante a tracción
tagliente a trazione

auf Stoss schneidend
pushing cut
tranchant en poussant
cortante a empuje
tagliente a urto



AUFRICHT

210 mm - 8¼"	tk 51672-21
--------------	--------------------

auf Zug und auf Stoss schneidend
drawing and pushing cut
tranchant à traction et en poussant
cortante a tracción y empuje
tagliente a trazione e a urto

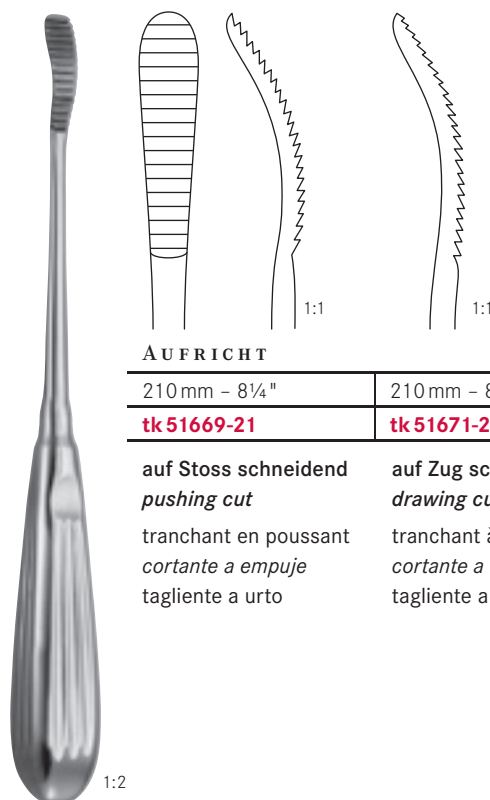

AUFRICHT

210 mm - 8¼"	210 mm - 8¼"
tk 51669-21	tk 51671-21

auf Stoss schneidend
pushing cut
tranchant en poussant
cortante a empuje
tagliente a urto

auf Zug schneidend
drawing cut
tranchant à traction
cortante a tracción
tagliente a trazione

Nasenraspeln
Nasal rasps

Râpes nasales
Limas nasales
Raspe nasali

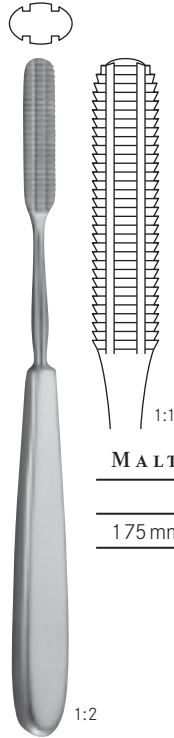

MALTZ

	40 mm x 9 mm
175 mm - 7"	tk 51663-18



WIENER

	Ø 3.5 mm	Ø 3.5 mm
180 mm - 7"	tk 51675-18	tk 51677-18

Antrum Raspeln
Antrum rasps

Râpes pour le fosse nasale
Limas para el antrum
Raspe per antrum

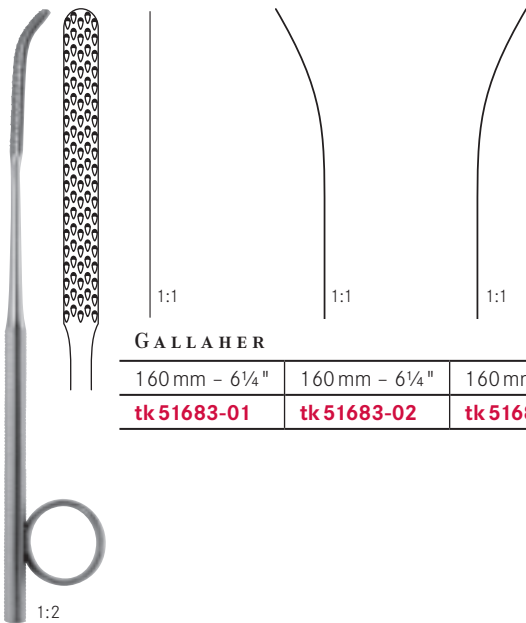

GALLAHER

160 mm - 6¼"	160 mm - 6¼"	160 mm - 6¼"
tk 51683-01	tk 51683-02	tk 51683-03

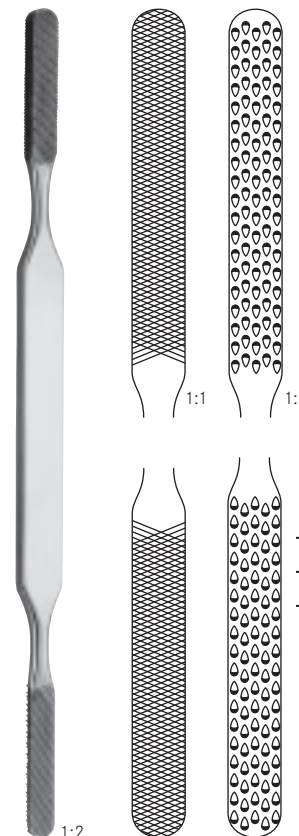

FOMON

210 mm - 8¼"
tk 51685-21

Raspeln mit Hartmetall
Rasps with tungsten carbide

Râpes avec inserts de carbure de tungstène
Limas con carburo de tungsteno
Raspe con tungsteno

TUCAR^{TK}

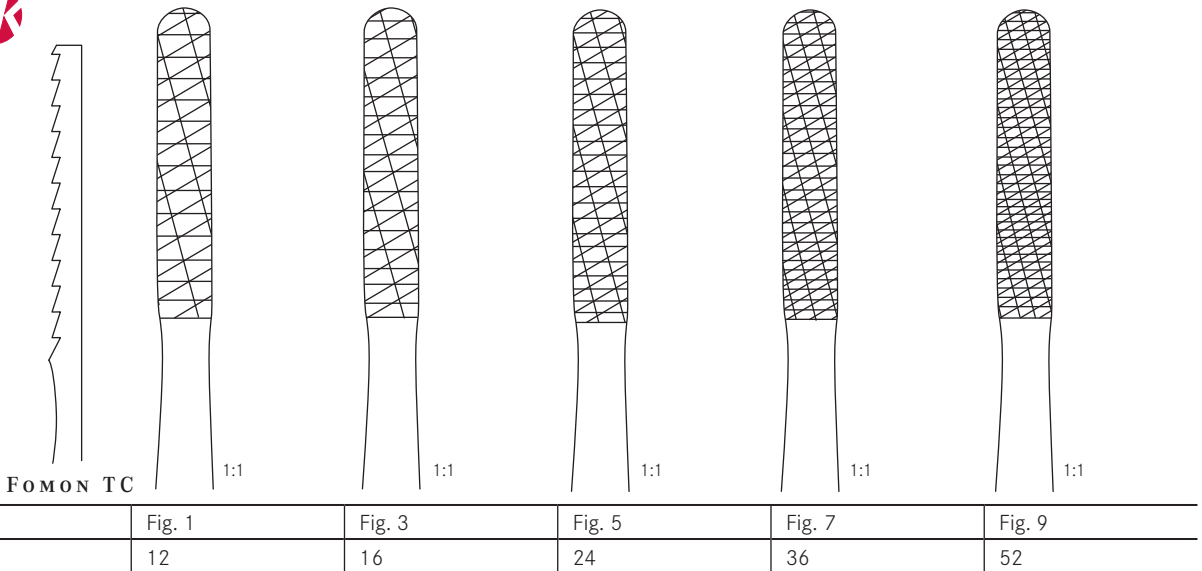

Zähne
Teeth
Dentes
Dientes
Denti

200 mm - 8"	tk 51686-01 TC	tk 51686-03 TC	tk 51686-05 TC	tk 51686-07 TC	tk 51686-09 TC
-------------	----------------	----------------	----------------	----------------	----------------

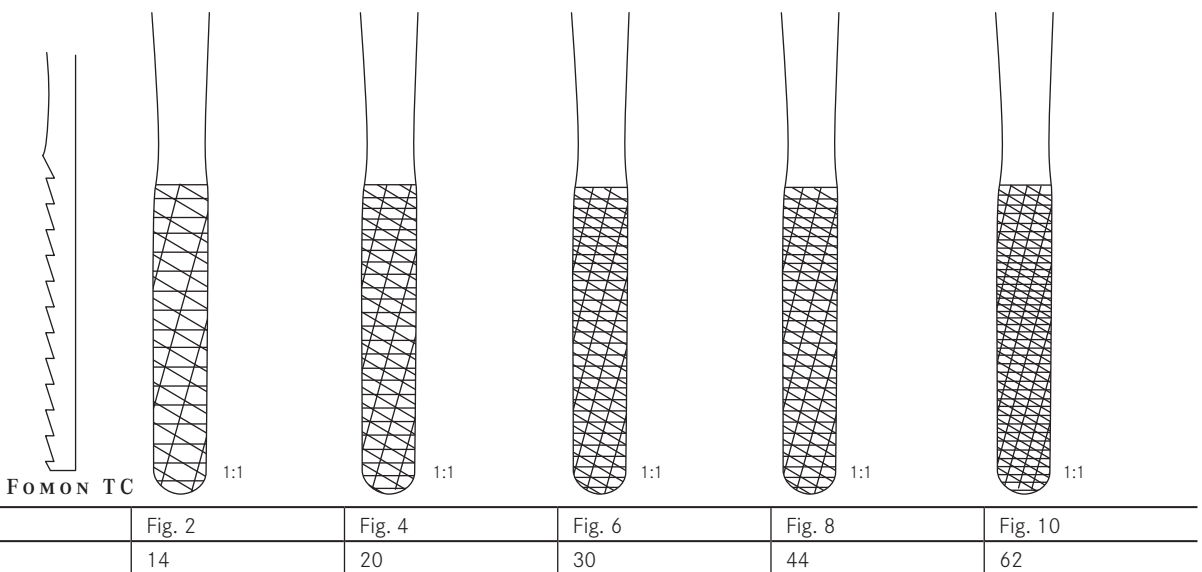

Zähne
Teeth
Dentes
Dientes
Denti

1:1

Septuminstrumente
Septum instruments

Instruments pour la cloison nasal
Instrumentos para el tabique nasal
Strumenti per il setto nasale



1:2

BRUENINGS-BRUNK

190 mm - 7½"	tk 16955-19
--------------	--------------------

Kieferhöhlenhaken, gezahnt
Antrum retractor, serrated

Ecarteur pour sinus maxillaire, dentelé
Separador para sinus, dentado
Retrattore mascellare, dentato



1:2

RITTER-HALLE

	160 mm - 6¼"
2.5 mm Ø	tk 6376-25
3.0 mm Ø	tk 6376-30
4.0 mm Ø	tk 6376-40

Stirnhöhlen-Dilatatore
Frontal sinus bougies

Dilatateurs pour le sinus frontal
Dilatadores para el sinus frontal
Dilatatore per il seno frontale

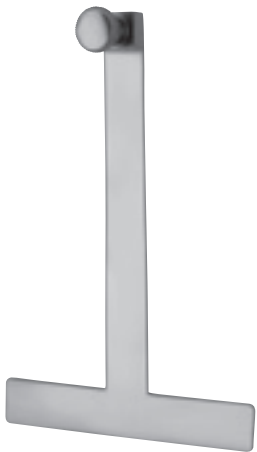

1:2

COTTLE

120 mm - 4¾"	tk 51647-01
--------------	--------------------

Griff
Handle
Manche
Mango
Manico



1:2

COTTLE

7 mm	tk 51647-02
------	--------------------

Führungshilfe für Osteotome
Guide support for osteotomes
Support conducteur pour ostéotomes
Soporte de guía para osteótomos
Supporto di guida per osteotomi



1:2

COTTLE

65 mm x 30 mm x 30 mm	tk 51648-00
-----------------------	--------------------

Knorpelquetsche
Cartilage crusher
Pincers-gouge à cartilage
Machacadora
Torchio per cartilagine



1:2

	tk 51648-00
--	--------------------

Septumzangen
Septum forceps

Pinces pour la cloison nasale
Pinzas para el tabique nasal
Pinze per il setto nasale

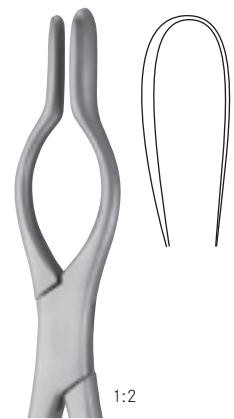
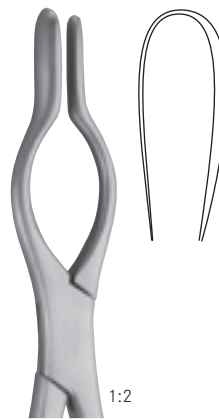

COTTLE-WALSHAM

230mm - 9"

tk 51695-01

tk 51695-02

tk 51695-03

gerade
straight

droit
recta
rette

links
left

à gauche
izquierda
a sinistra

rechts
right

à droite
derecha
a destra

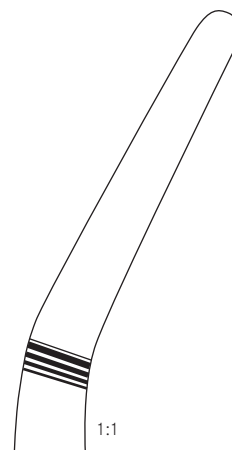

ASCH

230mm - 9"

tk 51697-23

Septumzangen
Septum forceps

Pinces pour la cloison nasale
Pinzas para el tabique nasal
Pinze per il setto nasale



1:1

MIDDLETON-JANSEN

190 mm - 7½"

tk51180-19

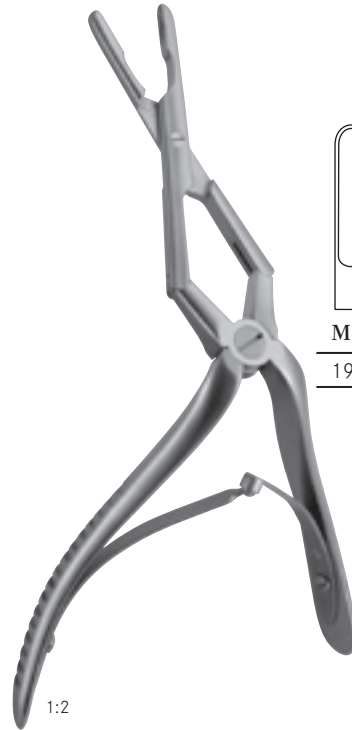

1:1

MIDDLETON-JANSEN

190 mm - 7½"

tk51182-19

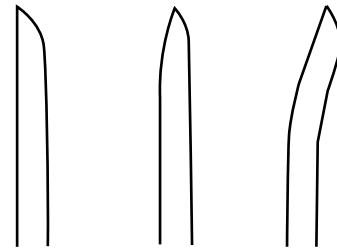

OBWEGESER

230 mm - 8¼"

tk51264-01

tk51264-02

tk51264-03

Nasenrückenschere, gezahnt
Nasal bridge scissors, serrated

Ciseaux pour le dos nasal, dentelé
Tijera para dorso nasal, dentada
Forbice per dorso nasale, dentellate

Septumzangen
Septum forceps

Pinces pour la cloison nasale
Pinzas para el tabique nasal
Pinze per il setto nasale

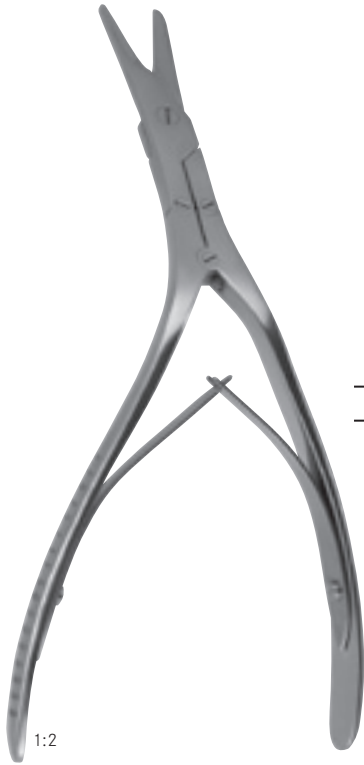

1:2

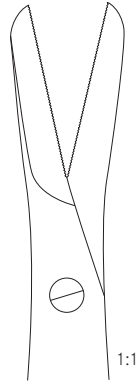

1:1

CAPLAN

200mm - 8"

tk51184-20

gezahnt
toothed
dentelée
dentado
dentato



1:2

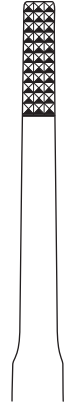

1:1

RUBIN

210mm - 8 1/4"

tk51188-21



tk51188-01

Schutzkappe
Protection Cap
Capuchon protecteur
Caperuza protectora
Calotta protettiva



1:2

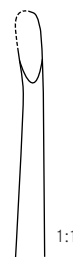

1:1



1:1



1:1

OBWEGESER

220mm - 8 3/4"

tk51179-04

tk51179-06

tk51179-08

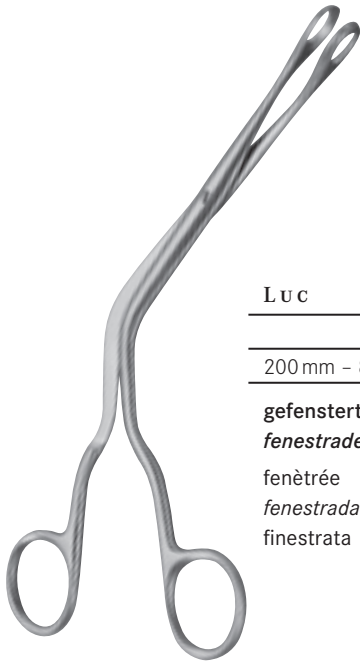

Scharfe Nasenzangen
Nasal cutting forceps

Pincès coupantes pour le nez
Pinzas nasales cortantes
Pinze taglianti per naso

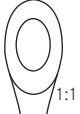
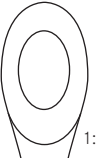





L u c	 1:1	 1:1
	Fig. 1	Fig. 2
200 mm - 8"	tk 51121-01	tk 51121-02

gefenstert
fenestrated
fenêtrée
fenestrada
finestrata

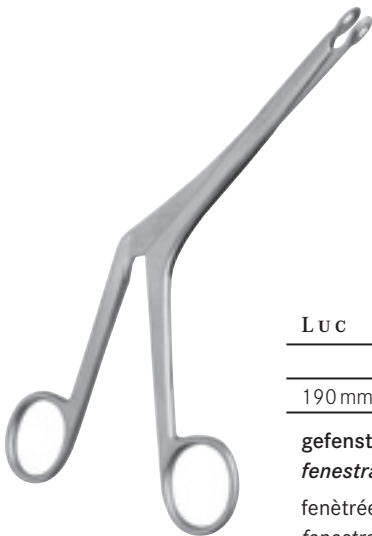
L u c	 1:1	 1:1
	Fig. 1	Fig. 2
200 mm - 8"	tk 51120-01	tk 51120-02

voll
full
pleine
lleno
pieno



L u c	 1:1	 1:1	 1:1
	Fig. 1	Fig. 2	Fig. 3
190 mm - 7½"	tk 51124-01	tk 51124-02	tk 51124-03

gefenstert
fenestrated
fenêtrée
fenestrada
finestrata

Antrumküretten
Antrum curettes

Curettes d'antrum
Curetas para el antrum
Curette per antrum



1:2



1:1

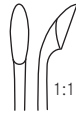

1:1

200 mm - 8"	200 mm - 8"
tk 50621-04	tk 50621-05



1:2



1:1

200 mm - 8"
7 mm x 11 mm
tk 50621-01



1:2



1:1

PRATT

210 mm - 8¼"
tk 50621-22



1:2



1:1

FAULKNER

210 mm - 8¼"
tk 51364-21



1:2



1:1

COAKLEY

200 mm - 8"
tk 51368-12



1:2

COAKLEY



1:1



1:1



1:1



1:1



1:1



1:1

	Fig. 1	Fig. 2	Fig. 3	Fig. 4	Fig. 5	Fig. 6
170 mm - 6¾"	tk 51366-01	tk 51366-02	tk 51366-03	tk 51366-04	tk 51366-05	tk 51366-06
tk 51366-00	x	x	x	x	x	x

Satz
Set
Jeu
Juego
Serie

Septumlevatorien – Raspatorien
Septum elevators – raspatories

Elevateurs – rugines pour la cloison nasale
Elevadores – legras para el tabique nasal
Elevatori – periostotomi per setto

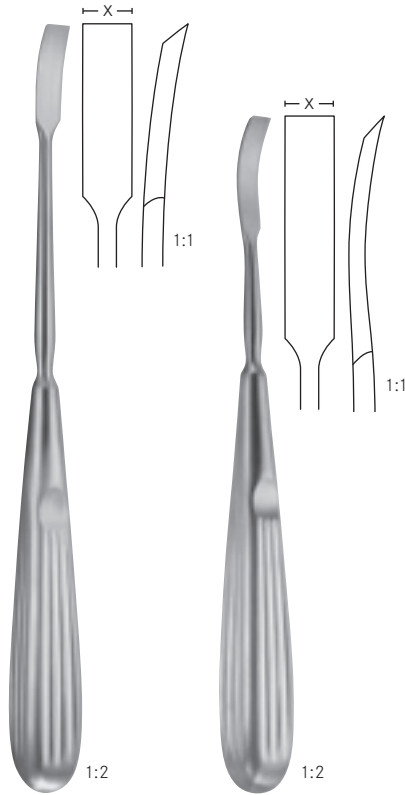

LEMPERT

	205 mm – 8"	180 mm – 7"
x = 6 mm	tk 50787-20	tk 50789-17



FREER

	x = 4 mm
160 mm – 6¼"	tk 50770-16

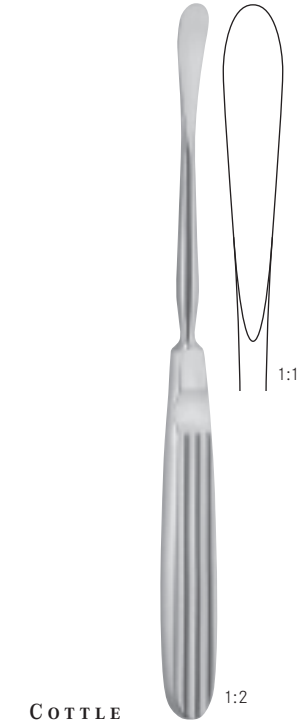

COTTLE

	x = 8 mm
190 mm – 7½"	tk 51607-19

scharf
sharp
tranchant
cortante
acuta

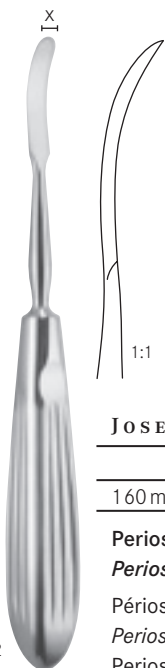

JOSEPH

	x = 5 mm
160 mm – 6¼"	tk 51613-16

Periost Elevatorien
Periostal elevators
Périostotome
Periostotomo
Periostotomo



SEWALL

200 mm – 8"	tk 51610-20
-------------	--------------------

Antrum Elevatorium
Antrum elevator
Élévateur pour le fosse nasale
Elevador para el antro
Elevatore per antro



HALLE

160 mm – 6¼"	tk 51617-16
--------------	--------------------

Septumelevatorien – Raspatorien
Septum elevators – raspatories

Elevateurs – rugines pour la cloison nasale
Elevadores – legras para el tabique nasal
 Elevatori – periostotomi per setto

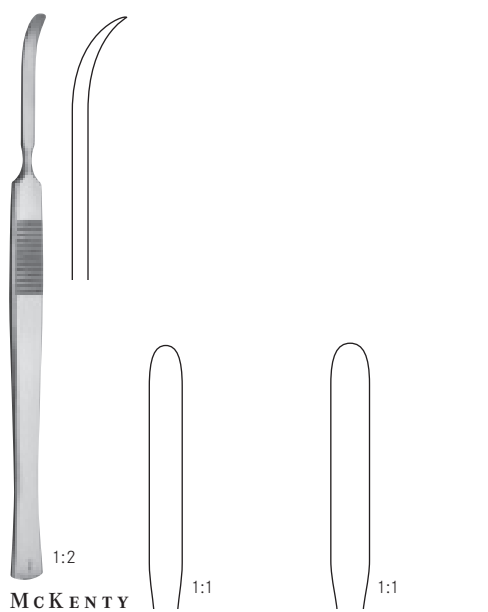

MCKENTY	4 mm	5 mm
150 mm – 6"	tk 51619-04	tk 51619-05

scharf
sharp
 tranchant
cortante
 acuta



COTTLE	x = 5 mm
235 mm – 9¼"	tk 51620-23

scharf
sharp
 tranchant
cortante
 acuta



MCKENTY	x = 4 mm
205 mm – 8"	tk 51621-22

scharf
sharp
 tranchant
cortante
 acuta

Septumlevatorien – Raspatorien
Septum elevators – raspatories

Elevateurs – rugines pour la cloison nasale
Elevadores – leguas para el tabique nasal
 Elevatori – periostotomi per setto



KILIAN

1:2

1:1

x = 4 mm

180 mm – 7"

tk 51622-18

scharf/stumpf
sharp/blunt

tranchant/mousse
cortante/romo
 acuta/smussa



KILIAN

1:2

1:1

x = 4.5 mm

230 mm – 9"

tk 51623-22

scharf/stumpf
sharp/blunt

tranchant/mousse
cortante/romo
 acuta/smussa



FREER

1:2

1:1

190 mm – 7½"

tk 51625-19

stumpf
blunt

mousse
romo
 smussa

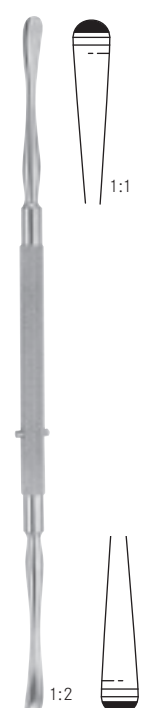

FREER

1:2

1:1

180 mm – 7"

tk 51627-18

scharf/stumpf
sharp/blunt

tranchant/mousse
cortante/romo
 acuta/smussa

Septumelevatorien – Raspatorien
Septum elevators – raspatories

Elevateurs – rugines pour la cloison nasale
Elevadores – leguas para el tabique nasal
 Elevatori – periostotomi per setto



FREER

205 mm – 8"

tk51631-20

scharf/stumpf
sharp/blunt
 tranchant/mousse
cortante/romo
 acuta/smussa



PENNINGTON

215 mm – 8½"

tk51629-21

stumpf
blunt
 mousse
romo
 smussa



JOSEPH-MASING

215 mm – 8½"

tk51634-22

scharf
sharp
 tranchant
cortante
 acuta

Periostelevatorien
Periosteal elevators

Elevateurs pour la périoste
Legras para periostio
 Elevatori per il periosto



MASING

200 mm - 8"	tk 51636-21
-------------	--------------------

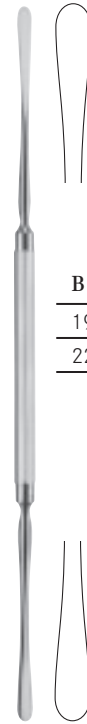

BALLENGER-HAJEK

190 mm - 7¼"	tk 51637-19
220 mm - 8¾"	tk 51637-22

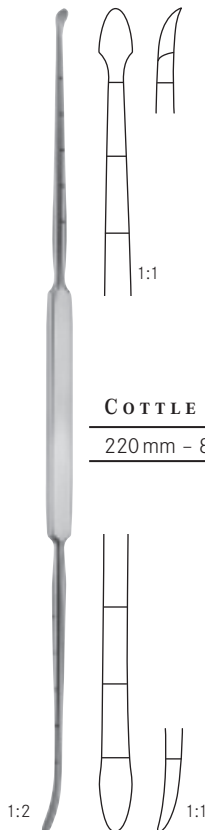

COTTLE

220 mm - 8¾"	tk 51643-22
--------------	--------------------

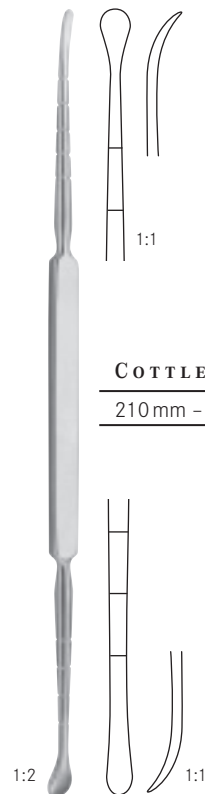

COTTLE

210 mm - 8¼"	tk 51644-21
--------------	--------------------

Hämmer
Mallets

Maillets
Martillos
Martelli



PARTSCH

	22 mm Ø - 200 g
180 mm - 7"	tk 24053-18

1:2



	20 mm Ø - 140 g
165 mm - 6½"	tk 24055-16

1:2



	25 mm Ø - 205 g
190 mm - 7½"	tk 24056-19

Stahl massiv, mit Kunststoffbacken
steel solid, with plastic faces
acier solide, avec plaques en plastic
acero solido, con placas en plastica
acciaio massiccio, con placche di plastica

1:2

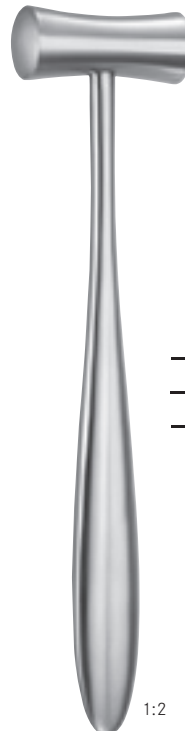

LUCAE

	19 mm Ø - 230 g	25 mm Ø - 260 g
190 mm - 7½"	tk 24057-01	tk 24057-02

Stahl massiv
steel solid
acier solide
acero solido
acciaio massiccio

1:2

Knochenmeißel
Bone chisels and gouges

Ciseaux-burins, gouges
Cinceles, gubias
Scalpelli, sgorbie



MINI-LAMBOTTE

	125 mm - 5"	170 mm - 6¾"
3 mm	tk 24094-03	tk 24095-03
4 mm	tk 24094-04	tk 24095-04
6 mm	tk 24094-06	tk 24095-06
8 mm	tk 24094-08	tk 24095-08
10 mm	tk 24094-10	tk 24095-10
12 mm	tk 24094-12	tk 24095-12
15 mm	tk 24094-15	tk 24095-15



MINI-LEXER

	180 mm - 7"	180 mm - 7"
4 mm	tk 24086-04	tk 24087-04
6 mm	tk 24086-06	tk 24087-06
8 mm	tk 24086-08	tk 24087-08
10 mm	tk 24086-10	tk 24087-10
12 mm	tk 24086-12	tk 24087-12

Ferrozellgriff

Ferrozell handle

Manche en Ferrozell

Mango en Ferrozell

Manico di Ferrozell

Knochenmeißel
Bone chisels and gouges

Ciseaux-burins, gouges
Cinceles, gubias
Scalpelli, sgorbie

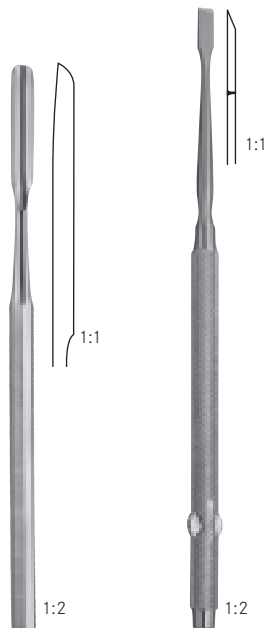

FREER		BALLENGER	
	150 mm - 6"		160 mm - 6¼"
6 mm	tk 24251-15		
4 mm			tk 24252-16

Hohlmeißel	Flachmeißel
<i>Gouge</i>	<i>Chisel</i>
Gouge	Ciseau-burin
<i>Gubia</i>	<i>Cinzel</i>
Sgorbia	Scalpello

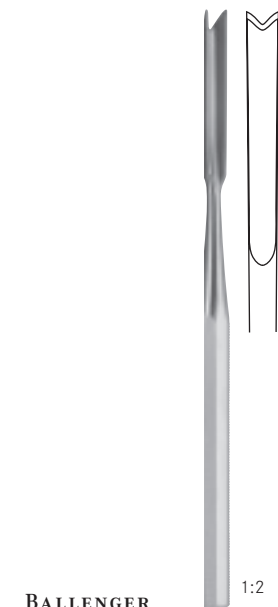

BALLENGER	
	160 mm - 6¼"
4 mm	tk 24255-04
6 mm	tk 24255-06
8 mm	tk 24255-08











MANNERFELT MODIF.		
	155 mm - 6"	155 mm - 6"
3 mm		tk 24254-03
4 mm	tk 24253-04	
6 mm	tk 24253-06	
8 mm	tk 24253-08	

Osteotome	Hohlmeißel
<i>Osteotomes</i>	<i>Gouge</i>
Ostéotomes	Gouge
<i>Osteótomos</i>	<i>Gubia</i>
Osteotomi	Sgorbia

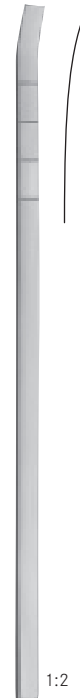
Osteotome und Flachmeißel
Chisels, osteotomes for rhinoplasty

Ostéotomes, ciseaux-burins pour rhinoplastique
Cinceles para rinoplastica
ScalPELLI per plastica nasale

 <p>KILIAN 160 mm - 6¼" 5 mm tk 24261-16</p>	 <p>KILIAN-CLAUS 160 mm - 6¼" 5 mm tk 24263-16</p>	 <p>COTTLE 150 mm - 6" 7 mm tk 24270-07 12 mm tk 24270-12</p>	 <p>COTTLE 190 mm - 7½" 4 mm tk 24272-19 6 mm</p>	 <p>180 mm - 7" tk 24277-06</p>
--	--	--	---	--

 <p>FOMON 170 mm - 6¾"</p>	 <p>4 mm tk 24278-04</p>	 <p>5 mm tk 24278-05</p>	 <p>6 mm tk 24278-06</p>	 <p>7 mm tk 24278-07</p>	 <p>8 mm tk 24278-08</p>
--	--	--	---	--	--

Osteotome und Flachmeißel
Chisels, osteotomes for rhinoplasty

Ostéotomes, ciseaux-burins pour rhinoplastique
Cinceles para rinoplastica
Scalpelli per plastica nasale





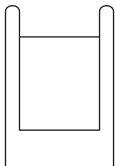
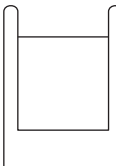
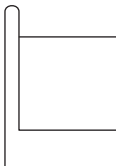
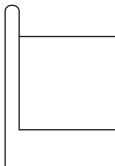

1:2

CINELLI	 1:1	 1:1	 1:1	 1:1
	10 mm	12 mm	14 mm	16 mm
180 mm - 7"	tk 24279-10	tk 24279-12	tk 24279-14	tk 24279-16





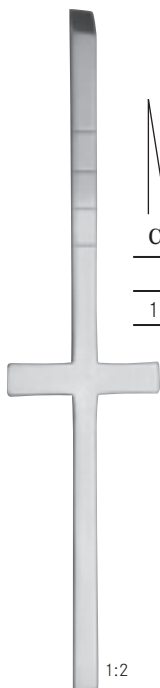

1:2

COTTLE	 1:1	 1:1	 1:1	 1:1
	4 mm	7 mm	9 mm	12 mm
180 mm - 7"	tk 24280-04	tk 24280-07	tk 24280-09	tk 24280-12



1:2

COTTLE	 1:1	 1:1	 1:1	 1:1
	4 mm	7 mm	9 mm	12 mm
180 mm - 7"	tk 24281-04	tk 24281-07	tk 24281-09	tk 24281-12

Osteotome und Flachmeißel
Chisels, osteotomes for rhinoplasty



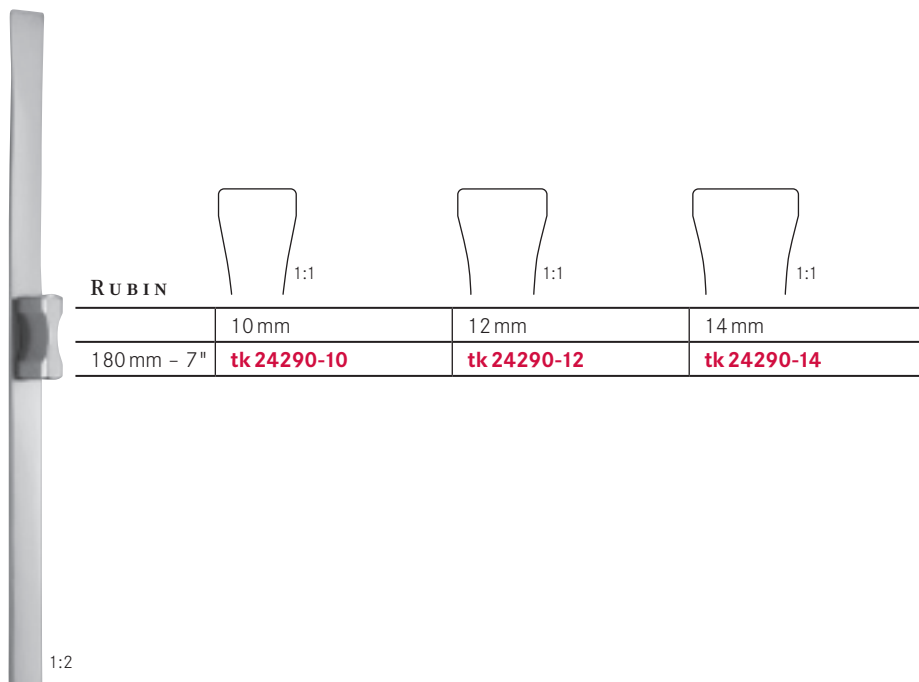
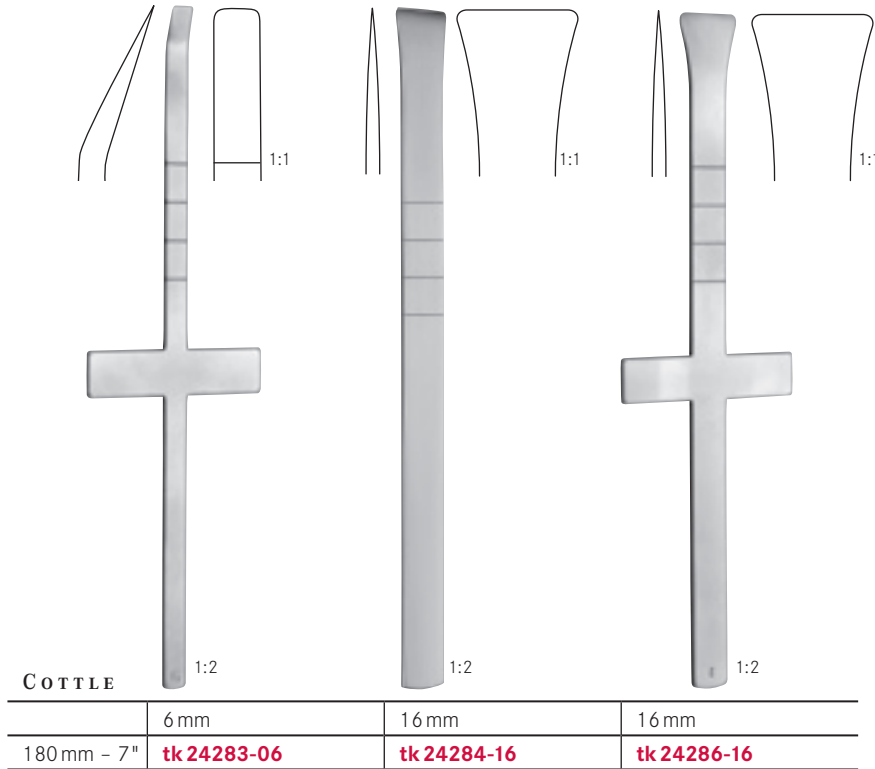

Ostéotomes, ciseaux-burins pour rhinoplastique
Cinceles para rinoplastica
Scalpelli per plastica nasale





Osteotome und Flachmeißel
Chisels, osteotomes for rhinoplasty

Ostéotomes, ciseaux-burins pour rhinoplastique
Cinceles para rinoplastica
Scalpelli per plastica nasale



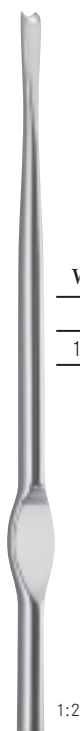



COTTLE	 1:1	 1:1	 1:1	 1:1
	200 mm - 8"	4 mm tk 24287-04	7 mm tk 24287-07	9 mm tk 24287-09



WALTER	 1:1	 1:1
	190 mm - 7½"	3 mm tk 24292-03

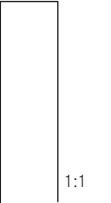

SHEEHAN	 1:1	 1:1	 1:1	 1:1
	160 mm - 6¼"	2 mm tk 24295-02	4 mm tk 24295-04	6 mm tk 24295-06

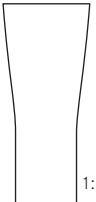
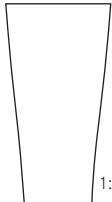
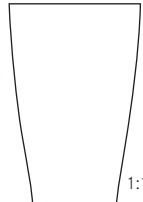
 1:1	 1:1	 1:1	 1:1
10 mm tk 24295-10	12 mm tk 24295-12	15 mm tk 24295-15	18 mm tk 24295-18

Osteotome und Flachmeißel
Chisels, osteotomes for rhinoplasty

Ostéotomes, ciseaux-burins pour rhinoplastique
Cinceles para rinoplastica
ScalPELLI per plastica nasale



1:2

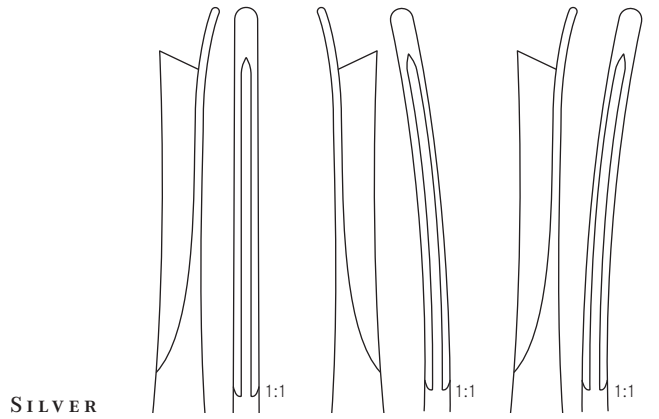

SILVER

180 mm - 7"

tk 24296-01

tk 24296-02

tk 24296-03

gerade
straight

droit
recta
retta

rechts
right

droite
derecha
destra

links
left

gauche
izquierda
sinistra



1:2

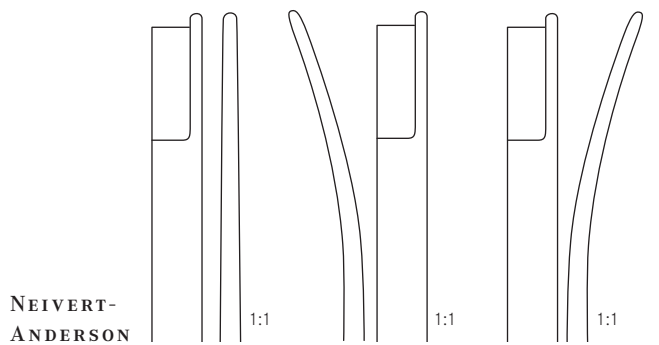

NEIVERT-ANDERSON

200 mm - 8"

tk 24298-01

tk 24298-02

tk 24298-03

gerade
straight

droit
recta
retta

rechts
right

droite
derecha
destra

links
left

gauche
izquierda
sinistra

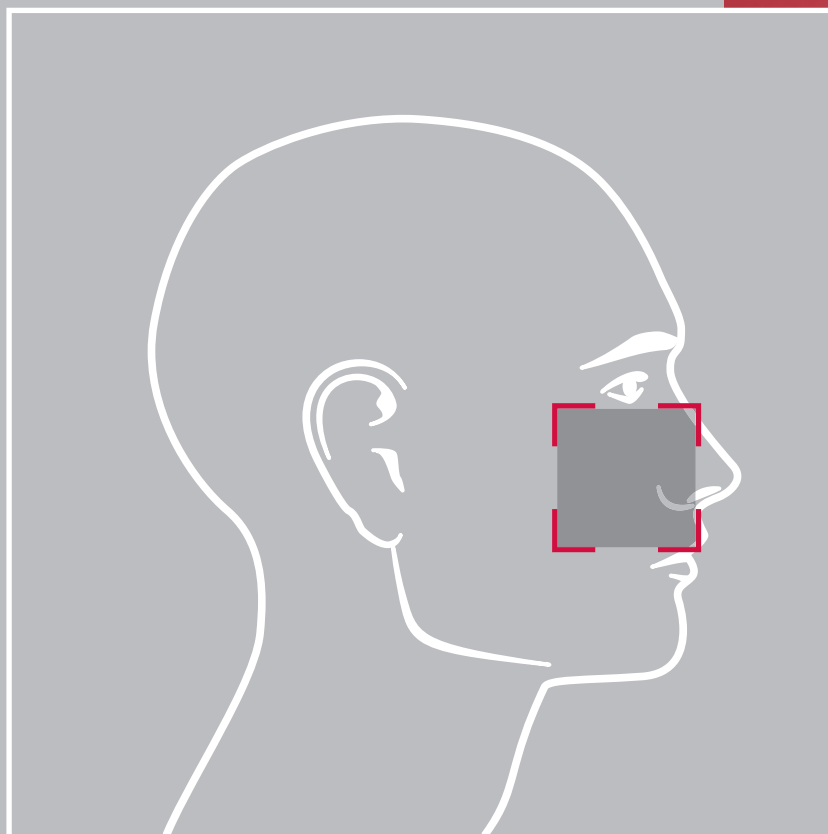

Sinuskopie
Sinuscopy

Sinuscopie
Sinuscopía
Sinuscopia



**Optiken
Scopes**
**Optiques
Ópticas
Ottiche**
Spezielle Eigenschaften

Aufgrund unserer langjährigen Erfahrung erfüllen unsere Optiken alle Voraussetzungen für ein qualitativ hochwertiges Produkt:

- **Kompakt-Objektive**
Die in unseren Endoskopen verwendete neue Generation von Kompakt-Objektiven bietet die Gewähr für volle Autoklavierbarkeit, auch über einen langen Zeitraum hinweg und gibt damit dem Anwender die Sicherheit für eine lange Lebensdauer des Produktes.
- **Stablinsen-System**
Neuberechnete Stablinsen-Systeme garantieren eine nicht zu übertreffende Bildhelligkeit.
- **Großbildoptik**
Eine hohe Vergrößerung garantiert dem Anwender ein angenehmes Arbeiten, auch wenn sich der Monitor nicht direkt am Operationsfeld befindet.
- **Distal und proximal Saphirgläser**
- **Anwendungsbezogene Blickwinkel bei allen Optiken**
- **Exzellente Brillanz und Auflösung**
- **Natürliche Farbwiedergabe bei gleichmäßiger Bildschärfe**
- **Optimale Tiefenschärfe, ebenfalls ausgerichtet an den Erfordernissen des Einsatzgebietes**

Qualités particulières

A cause de notre longue expérience, nos optiques répondent à toutes exigences pour des produits de haute gamme

- **objectif compact**
la nouvelle génération des objectifs utilisés dans nos endoscopes garantie que les produits peuvent être autoclavés, même pendant une très longue période, et donne à l'utilisateur la sécurité pour une longue vie du produit.
- **système des lentilles en tiges**
ce système, nouvellement évalué, garantit la meilleure clarté de l'image
- **grandeur de l'image**
le grossissement le plus grand possible garantit un travail agréable pour l'utilisateur, surtout quand l'écran ne se trouve pas à coté de l'opérateur.
- **différents angles, selon les besoins du travail**
- **illumination brillante et très haute résolution**
- **reproduction des couleurs naturelles en netteté constante de l'image**
- **profondeur de champ optimale, selon les nécessités de l'opération**

Particular attributes

Due to our long experience, our scopes meet all technical requirements of a first class product:

- **compact objectives**
the new generation of compact objectives used in our endoscopes provides the guarantee of full autoclavability even for a long period and gives the user the security of a long life of the product.
- **rod lens system**
the new evaluated rod lens systems guarantees an illumination which really is second to none.
- **large image size**
a high enlargement guarantees a comfortable working, even if the monitor is not so close to the operation field.
- **distal and proximal saphire windows**
- **comfortable direction of view on all scopes according to the necessity of the operation**
- **brilliant illumination and crystal clear resolution**
- **true colour reflection and regular focus on the whole image**
- **optimal depth of field, also according to the necessity of the operation**

Características particulares

En base a nuestra larga eperiencia, nuestras ópticas satisfacen todas las normas de los productos de alta calidad.

- **objetivos compactos**
la nueva generación de objetivos, incorporados en nuestras ópticas, ofrece la garantía de esterilización por autoclave durante un largo periodo de tiempo y da de durabilidad al producto.
- **sistema de lentes a varillas**
este sistema, nuevamente evaluado garantiza la mejor luminosidad de la imagen.
- **dimensión de la imagen**
el aumento de la dimensión da la imagen, garantiza un trabajo agradable, aunque el monitor está posicionado lejos de la mesa.
- **diferentes ángulos visuales según las necesidades de trabajo**
- **iluminación brillante y una resolución muy alta**
- **reproducción de los colores naturales a una nitidez constante de la imagen**
- **profundidad del campo según las necesidades de trabajo**



Kompakt-Objektiv
Compact objective
Objectif compact
Objetivo compacto
Obiettivo compatto

Optiken
Scopes

Optiques
Ópticas
Ottiche

Caratteristiche particolari

Grazie alla nostra lunga esperienza, i nostri endoscopi presentano tutte le caratteristiche dei prodotti di alto livello:

- obiettivi compatti: la nuova generazione di obiettivi compatti usata nei nostri endoscopi garantisce la totale autoclavabilità anche per un lungo periodo e da all'utente la certezza di una lunga durata del prodotto
- sistema rod lens: la nuova generazione del sistema di rod lens assicura una illuminazione che non è seconda a nessun altro prodotto
- immagine di grandi dimensioni: un elevato fattore di ingrandimento permette un lavoro confortabile, anche se il monitor non è vicino all'operatore
- leni prossimali e distali in zaffiro
- angolo di visione perfetto, specifico per ogni campo di utilizzo
- illuminazione brillante e risoluzione cristallina
- trasmissione dei colori reale, e immagine perfettamente a fuoco su tutto il campo
- profondità di campo ottimale, studiata per le necessità dei diversi campi di utilizzo

Kompatibilität
Compatibility

Compatibilité
Compatibilidad
Compatibilità

Ergänzend zu unserem umfassenden Optikenprogramm fertigen wir auf Anfrage kompatible Endoskope zu nachfolgenden Fremdmarken.

In addition to our extensive program of endoscopes, we can manufacture endoscopes compatible to the following brands on demand.

Complémentaire à notre programme vaste d'endoscopes, nous pouvons produire des endoscopes compatibles aux marques suivantes sur demande.

Adicional a nuestro programa amplio de endoscopios, podemos producir endoscopios compatibles a las marcas siguientes a petición.

In aggiunta al nostro vasto programma di ottiche endoscopiche standard, possiamo anche produrre su richiesta endoscopi compatibili con le seguenti marche.

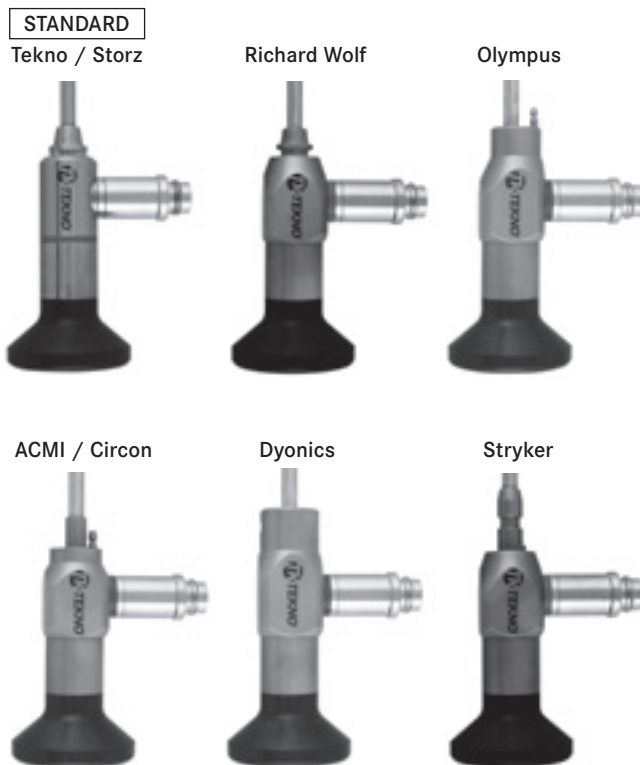

Kompatibilität
Compatibility

Compatibilité
Compatibilidad
Compatibilità

Tekno
Storz
Olympus

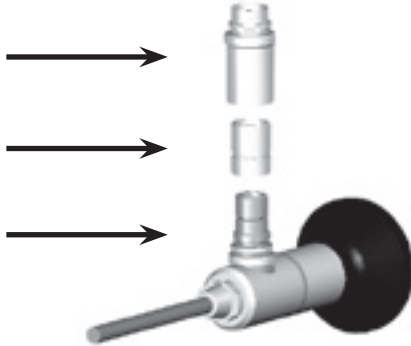

Wolf

ACMI

Kompatibler Lichtleiteranschluss
Compatible light guide connection

Connecteur de lumière froide compatible
Conexión de luz fría compatible
Connettore compatibile cavo luce

Anweisung zum Autoklavieren
Instructions for autoclaving

Instructions importantes pour l'autoclavage
Instrucciones importantes
Istruzioni per autoclavare

1. Alle autoklavierbaren Optiken sind mit der Ätzung "autoclave 134°C/273°F 18 min" gekennzeichnet.
2. Die Optiken sollten nur bei 134°C/273°F (±5°) über die max. Dauer von 18 Minuten autoklaviert werden. Nichteinhaltung dieser Dauer kann Ihre Optik zerstören.
3. Die Optiken sollten nicht bei 120°C/248°F autoklaviert werden, da durch die längere Sterilisationszeit die Optiken erheblich mehr belastet werden.
4. Die Optiken müssen vor dem Autoklavieren sorgfältig gereinigt werden. Zur Beseitigung von äußerlichen Verschmutzungen dürfen auf keinen Fall harte Gegenstände verwendet werden. Zur Reinigung der optischen Endfläche (distal und proximal) empfehlen wir mit Alkohol angefeuchtete Wattetupfer. Auf keinen Fall dürfen die Optiken im Ultraschallbad gereinigt werden! Dies führt ebenfalls zur Zerstörung der Optik. Schlecht gereinigte Endflächen beeinträchtigen die Bildqualität; es kommt zu einer Trübung der Optik.
5. Die vorgereinigten Optiken werden in geeignete Sterilisationsbehälter oder Sterilisationstücher eingelegt. Dabei ist zu beachten, daß keine Hitzebrücke zwischen der Optik und dem Sterilisationsbehälter entsteht.
6. Nach Abschluß der Sterilisation müssen die Optiken im Sterilisator langsam auf Raumtemperatur abgekühlt werden. Eine schockartige Abkühlung zerstört die Optik!
7. Bitte beachten Sie desweiteren die Bedienungsanleitung Ihres Sterilisators und lassen Sie diesen von Zeit zu Zeit überprüfen.

1. All autoclavable scopes are etched "autoclave 134°C/273°F 18 min".
2. All scopes may only be autoclaved at 134°C/273°F (±5°) for a maximum of 18 minutes. Failure to follow these parameters may destroy the scope.
3. Scopes should not be autoclaved at 120°C/248°F, as the prolonged sterilization time may damage the scopes.
4. The endoscopes must be thoroughly cleaned before autoclaving. Under no circumstances a hard object should be used for this purpose. We recommend the use of alcohol and cotton pads for the cleaning of optical surfaces (distal and proximal). Under no circumstances scopes may be cleaned with ultrasonic waves as this may also destroy them! Poorly cleaned surfaces lead to significant impairment and to dimming of the lenses.
5. The pre-cleaned scopes are placed in sterilization trays and containers or sterilization clothes specially designed for this purpose. Make sure to avoid any thermal bridge between the scopes and the sterilization container.
6. After the sterilization the scopes should cool slowly to room temperature while staying in the autoclave. Rapid cooling will destroy the scopes.
7. Please follow the instruction manual of the sterilization equipment and keep it controlled from time to time.

Anweisung zum Autoklavieren
Instructions for autoclaving

Instructions importantes pour l'autoclavage
Instrucciones importantes
 Istruzioni per autoclavare

1. Toutes les optiques autoclavables sont marquées "autoclavable 134°C/273°F 18 min"
2. Les optiques doivent être autoclavées seulement à 134°C / 273°F pendant 18min max. Une prolongation de ce temps peut endommager l'optique.
3. Les optiques ne doivent pas être autoclavées à 120°C / 248°F, la prolongation du temps de stérilisation peut causer des dégats aux optiques.
4. Les optiques doivent être nettoyées soigneusement avant d'être autoclavées. Le nettoyage ne doit pas être fait avec des objets durs. Pour le nettoyage des surfaces optiques proximal et distal, il est conseillé d'utiliser des tampons d'ouate, trempés dans l'alcool. Ne jamais nettoyer des optiques dans un bain d'ultra-son! Cela mène à la détruite de l'optique. Un nettoyage insuffisant des surfaces optiques nuit à la qualité de l'image, l'optique sera troublée.
5. Les optiques nettoyées doivent être positionnées dans des contenaires appropriés. Vérifier que les optiques ne soient pas en contact avec le métal pendant la stérilisation.
6. Après la stérilisation laisser refroidir les optiques lentement à la température ambiante. Un refroidissement trop rapide endommage l'optique.
7. Respecter les modes d'emploi du fabricant des stérilisateur et laisser les contrôler régulièrement.

1. Todas las ópticas autoclavables llevan la marcación "autoclavable 134°C / 273°F 18 min"
2. Las ópticas tienen que ser esterilizadas solamente a 134°C /273°F durante un máximo tiempo de 18min. Una prolongación de este tiempo daña las ópticas.
3. Las ópticas no pueden ser esterilizadas a 120° / 248°F. Este método de esterilización daña las ópticas.
4. Las ópticas han de ser limpiadas cuidadosamente antes de meterlas en el autoclave. Nunca limpiar una óptica con un objeto duro. El uso de una valleta de algodón impregnada en alcohol esta recomendado para limpiar los cristales opticos proximales y distales. En ningún caso limpiar una óptica en un baño ultrasónico, este puede destruir la óptica. Una limpieza insuficiente de los cristales ópticos conduce a una reducción de la calidad de la imagen y a un deslucimiento de las lentes.
5. Poner las ópticas pre-limpiadas en un contenedor apropiado. Observar que las ópticas no esten en contacto con otras piezas metálicas.
6. Despues de la esterilización, las ópticas tienen que enfriarse paulatinamente a la temperatura ambiente. Una refrigeración rapida destruye la óptica.
7. Leer atentamente las instrucciones del fabricante del los esterilizadores y controlar le regularmente.

1. Tutti gli endoscopi autoclavabili sono marchiati: "134°C/273°F 18 min"
2. Tutti gli endoscopi possono solamente essere autoclavati a 134°C/273°F (+/- 5°C) per un massimo di 18 minuti (di esposizione a tale temperatura), o a 137°C per 3 minuti. Errori nel seguire questi parametri potrebbero distruggere gli endoscopi
3. Gli endoscopi non devono essere autoclavati a 121 °C/248°F , poiché il tempo prolungato di sterilizzazione potrebbe danneggiarli
4. Tutti gli endoscopi devono essere accuratamente puliti prima di venire autoclavati. In nessun caso deve essere utilizzato uno strumento metallico per questo scopo. Noi raccomandiamo l'utilizzo di alcool e pezzi di cotone per la pulizia delle superfici ottiche (distali e prossimali). Gli endoscopi non devono mai essere puliti con macchine ad ultrasuoni, poiché questo potrebbe distruggerli. Superfici scarsamente pulite causano una progressiva diminuzione della brillantezza delle lenti.
5. Gli endoscopi pre-puliti devono essere sistemati negli appositi container di sterilizzazione o nella speciale carta di sterilizzazione. Assicurarsi di evitare qualsiasi poste termico tra le ottiche ed il container.
6. Dopo la sterilizzazione gli endoscopi devono essere lasciati raffreddare lentamente alla temperatura ambiente rimanendo in autoclave. Un rapido raffreddamento può distruggere gli endoscopi
7. Per favore seguire il manuale di istruzioni della sterilizzatrice e controllarla di tanto in tanto
8. Una volta alla settimana gli endoscopi dovrebbero venire lavati con acqua distillata per rimuovere i sali minerali

autoklavierbar / autoclavable
 134°C / 273°F - 18 min.

Alle mit diesem Zeichen versehenen Produkte sind garantiert autoklavierbar. Wir garantieren 24 Monate volle Autoklavierbarkeit für diese Optiken. (Siehe Anweisung zum Autoklavieren)

Compatible light guide All products with this sign are fully autoclavable. We guarantee 24 months of full autoclavability for these scopes. (See instructions for autoclaving)

Connecteur de lumière froide Tous les produits portant ce marquage sont garantis autoclavables. Nous garantissons ce fait pour une période de 24 mois.(Voir les instructions pour l'autoclavage)

Conexión de luz fría Todos los productos con esta marcación están garantizados para la esterilización en autoclave. Garantizamos eso para un tiempo de 24 meses.(Ver las directivas)

Tutti i nostri prodotto con questo marchio sono totalmente autoclavabili. Noi garantiamo per 24 mesi i nostri prodotti contro i danni derivanti dall'autoclave (Leggere le istruzioni prima di autoclavare)

TEKNO-FLEX

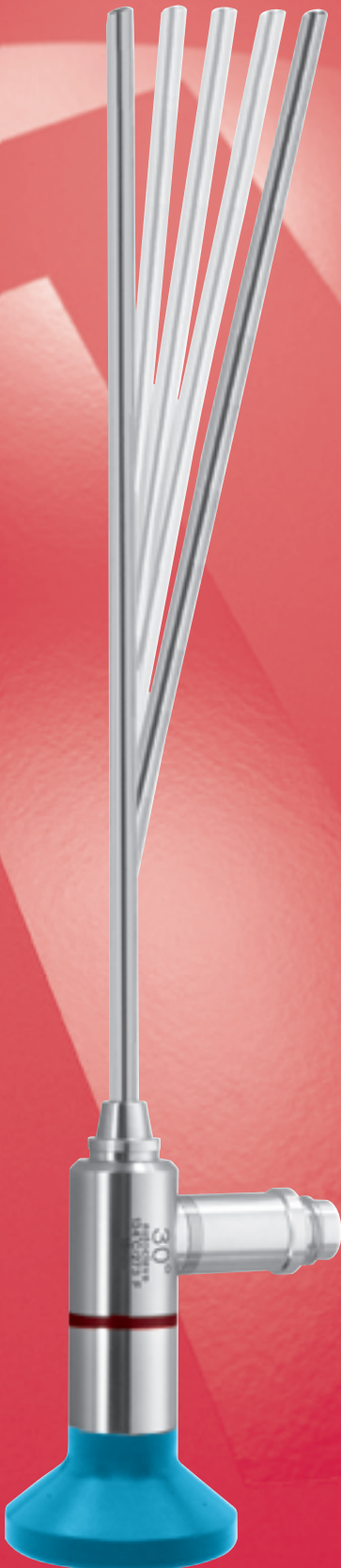

Die Vorteile von Tekno-Flex Endoskope (patentiert):

- weniger anfällig gegen äußere mechanische Einwirkungen, wie Verbiegen
- höhere Flexibilität im Vergleich zu Standard Endoskopen
- höhere Widerstandsfähigkeit (70% aller Reparaturen basieren auf gebrochenen Stablinsen, verursacht durch gebogene Schäfte)
- kratzsicheres Saphirglas am distalen Ende und am Okular
- korrekte Farbwiedergabe und gleichmäßige Bildschärfe
- 1 Jahr Garantie auf gebrochene Stablinsen
- Tekno-Flex Optiken sind durch den Zusatz "SF" gekennzeichnet

The advantages of Tekno-Flex endoscopes (patented):

- *the optical system is less sensitive to bending*
- *higher flexibility compared to standard rigid endoscopes*
- *higher robustness (70% of all repairing is due to broken rod-lenses caused by bent tubes)*
- *scratch-proof sapphire glass on the distal end and ocular side*
- *high resolution and contrast reproduction*
- *1 year warranty against broken rod-lenses*
- *Tekno-Flex scopes can be recognized by the suffix "SF"*

Les avantages des endoscopes Tekno-Flex (brevetés):

- haute résistance contre influences mécaniques
- meilleure souplesse comparé avec des endoscopes rigides
- meilleure résistance (70% de toutes réparations sont provoquées par des ruptures des lentilles cylindriques)
- verres distales et proximales en saphir
- reproduction parfaite des couleurs et profondeur de champ exceptionnel
- 1 an de garantie sur ruptures des lentilles cylindriques
- les optiques Teko-Flex peuvent être reconnues par l'annexe "SF"

Las ventajas de los endoscopios Tekno-Flex (patentados):

- *gran resistencia al estrés mecánico*
- *mayor flexibilidad en comparación a ópticas tradicionales*
- *mayor resistencia (70% de todas las reparaciones son debidas a roturas de lentes cilíndricas)*
- *las lentes distales y proximales son de zafiro de alta resistencia*
- *perfecta reproducción de color y extraordinaria profundidad de campo*
- *1 año de garantía sobre roturas de lentes cilíndricas*
- *las ópticas Tekno-Flex son reconocidos por el anexo "SF"*

I vantaggi degli endoscopi Tekno-Flex (brevettato):

- maggiore resistenza contro stress meccanico
- accetta una grande flessione rispetto ad ottiche tradizionali
- elevata robustezza (70% di tutte le riparazioni é dovuto a rotture delle rod-lenses)
- lenti distale e prossimale in zaffiro ad alta resistenza
- perfetta riproduzione dei colori e immagine a fuoco a tutto campo
- 1 anno di garanzia su rottura delle rod-lens
- le ottiche Tekno-Flex hanno un numero d'articolo con "SF" aggiunto

Sinuskope
Sinusscopes
Sinuscopios
Sinuscopi

autoklavierbar / autoclavable
134°C / 273°F - 18 min.

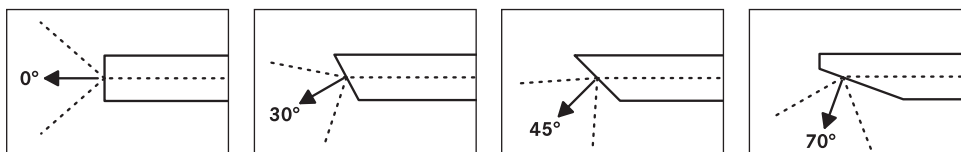
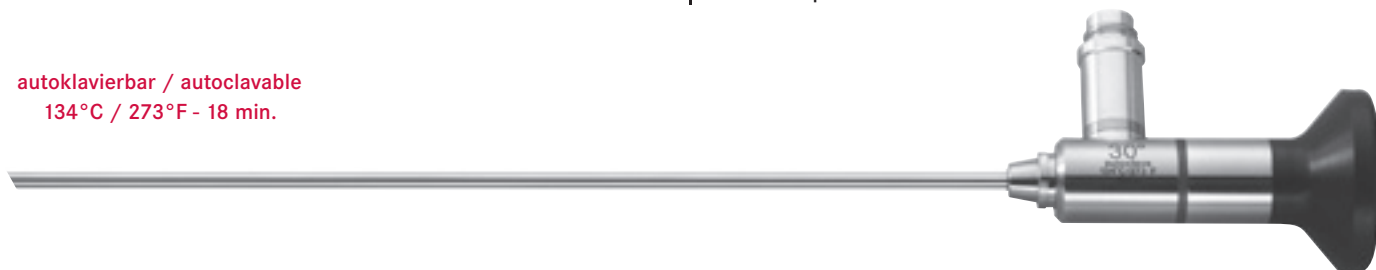

Ø 2.4 mm - 98 mm	tk 700-098	tk 700-099		
Ø 2.7 mm - 110 mm	tk 700-100	tk 700-103		tk 700-107
Ø 2.7 mm - 141 mm	tk 700-101	tk 700-105		
Ø 2.7 mm - 175 mm	tk 700-110	tk 700-113		tk 700-117
Ø 2.7 mm - 187.5 mm	tk 700-120	tk 700-123		tk 700-127
Ø 4.0 mm - 175 mm	tk 700-130	tk 700-133	tk 700-134	tk 700-137
Ø 2.7 mm - 110 mm	tk 700-100SF	tk 700-103SF		
Ø 2.7 mm - 175 mm	tk 700-110SF	tk 700-113SF		
Ø 2.7 mm - 187.5 mm	tk 700-120SF	tk 700-123SF		
Ø 4.0 mm - 175 mm	tk 700-130SF	tk 700-133SF	tk 700-134SF	tk 700-137SF

Ø, Arbeitslänge
Ø, Working length
Ø, Longueur de travail
Ø, Longitud de trabajo
Ø, Lunghezza operativa

autoklavierbar / autoclavable
134°C / 273°F - 18 min.

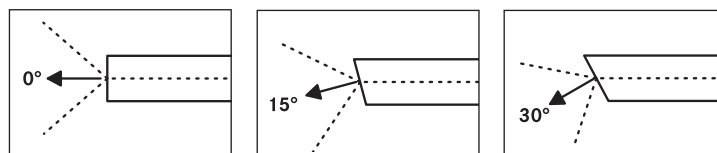

Ø 1.7 mm - 58 mm	tk 700-160	tk 700-165	
Ø 1.7 mm - 104 mm	tk 700-170	tk 700-175	
Ø 1.9 mm - 69 mm	tk 700-196		tk 700-198
Ø 1.9 mm - 102 mm	tk 700-197		tk 700-199
Ø 2.0 mm - 58 mm	tk 700-180	tk 700-185	
Ø 2.0 mm - 104 mm	tk 700-190	tk 700-195	

Ø, Arbeitslänge
Ø, Working length
Ø, Longueur de travail
Ø, Longitud de trabajo
Ø, Lunghezza operativa

Griffe für Sinuskope
Handles for sinusscopes

Poignées pour sinusscopes
Mangos para sinuscopios
Manici per sinuscopi



Ø 2.7 mm	111 mm	tk 700-994
Ø 4.0 mm	110 mm	tk 700-996

Für Optiken 0° - 70° Länge
For scopes 0° - 70° Length
Pour optiques 0° - 70° Longueur
Para ópticas 0° - 70° Longitud
Per ottiche 0° - 70° Lunghezza

Trokare
Trocars

Trocarts
Trócares
Trequarti

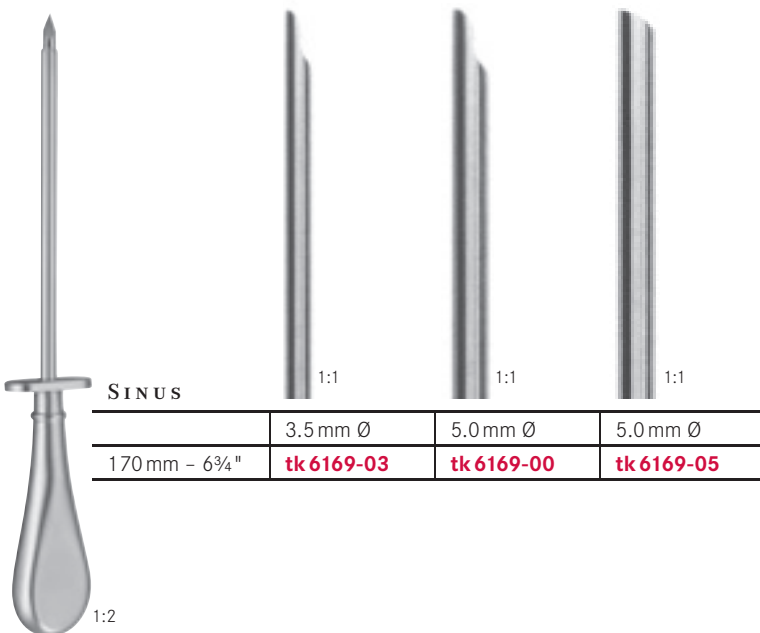

SINUS	3.5 mm Ø	5.0 mm Ø	5.0 mm Ø
170 mm - 6¾"	tk 6169-03	tk 6169-00	tk 6169-05

Ohrkatheter | Sondes auriculaires
Eustachian catheters | *Sondas auriculares*
 Sonde auricolari



KILLIAN	○ 1:1	● 1:1
		2.5 mm Ø
160 mm - 6"	tk 6371-16	tk 6372-16

ovale Öffnung
oval opening
 ouverture ovale
apertura oval
 apertura ovale

Septum - Elevatorien | Elevateurs pour la cloison nasale
Septum elevators | *Elevadores para el tabique nasal*
 Elevatori per setto



200 mm - 8"	tk 51645-20
-------------	--------------------

Saug-Raspatorium - biegsam, scharf
suction raspatory - malleable, sharp
 rugine aspirante - flexible, tranchant
legra aspiradora - maleable y agudo
 elevatore-aspiratore - flessibile, tagliente

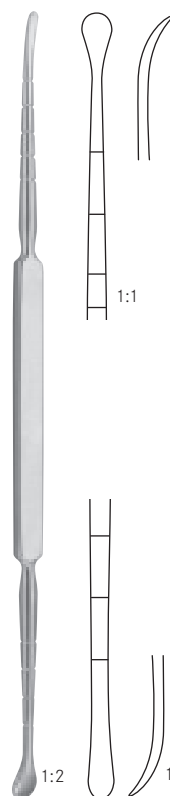

COTTLE
tk 51644-21
210 mm - 8¼"

Septum - Elevatorien
Septum elevators

Elevateurs pour la cloison nasale
Elevadores para el tabique nasal
Elevatori per setto



FREER

tk 51631-20

205 mm - 8"

scharf/stumpf
sharp/blunt

tranchant/mousse
aguda/roma
acuta/smussa

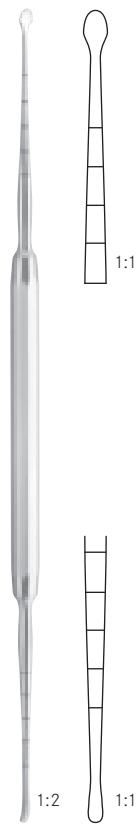

MASING

tk 51636-21

200 mm - 8



COTTLE

tk 51643-22

220 mm - 8¾"



tk 51642-20

195 mm - 8¾"

Ø 2.3 / 2.6 mm

Scharfe Nasenzangen
Nasal cutting forceps

Pincas coupantes pour le nez
Pinzas nasales cortantes
Pinze taglianti per naso



SCHMEDEN

x = 120 mm - 4¾"

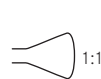

1:1

tk51171-11



1:1

tk51171-12



1:1

tk51171-13

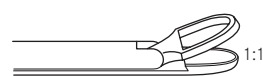

TOMATI

x = 120 mm - 4¾" tk51173-12



STRUYCKEN

	0.9 mm	1.2 mm
x = 120 mm - 4¾"	tk51174-01	tk51174-02

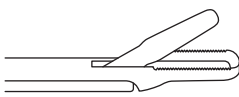

HENKE

x = 120 mm - 4¾" tk51176-01

Nasenscheren
Nasal scissors

Ciseaux nasales
Tijera nasal
Forbice nasale

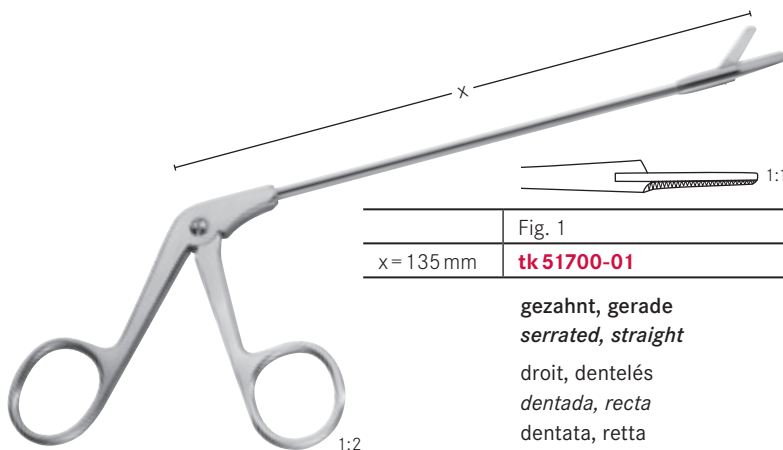

Fig. 1

x = 135 mm

gezahnt, gerade
serrated, straight
droit, dentelés
dentada, recta
dentata, retta



Fig. 2

gezahnt, rechts
serrated, right
dentelés, droites
dentada, derecha
dentata, destra

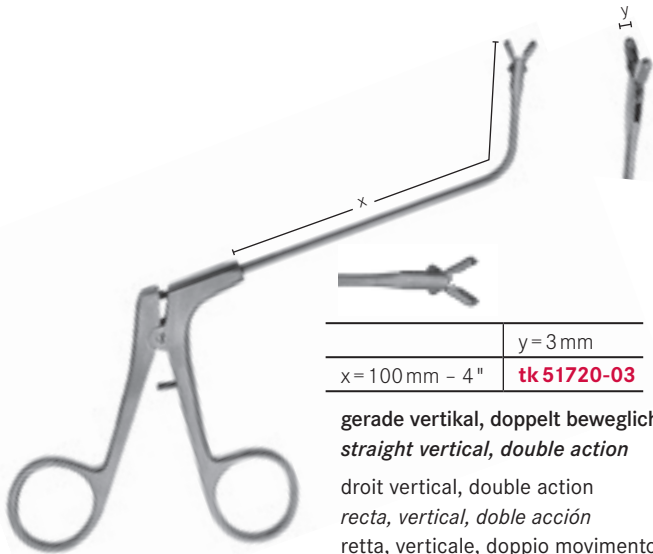

Fig. 3

gezahnt, links
serrated, left
dentelés, gauche
dentada, izquierda
dentata, sinistra

Scharfe Nasenzangen
Nasal cutting forceps

Pincés coupantes pour le nez
Pinzas nasales cortantes
 Pinze taglienti per naso



	y = 3 mm
x = 100 mm - 4"	tk 51720-03

gerade vertikal, doppelt beweglich
straight vertical, double action
 droit vertical, double action
recta, vertical, doble acción
 retta, verticale, doppio movimento

	y = 3 mm
x = 100 mm - 4"	tk 51722-03

gerade hor., doppelt beweglich
straight hor., double action
 droit horizontal, double action
recta, horizontal, doble acción
 retta oriz., doppio movimento

	y = 3 mm
x = 100 mm - 4"	tk 51723-03

gerade hor., einfach beweglich, kurz
straight hor., single action, short
 droit hor., action simple, court
recta, hor., acción simple, corto
 retta, oriz., movimento sing., corto

	y = 3 mm
x = 100 mm - 4"	tk 51724-03

45° vertikal, doppelt beweglich
45° vertical, double action
 45° vertical, double action
45° vertical, doble acción
 45° verticale, doppio movimento

	y = 3 mm
x = 100 mm - 4"	tk 51727-03

45° hor., doppelt beweglich
45° hor., double action
 45° hor., double action
45° hor., doble acción
 45° oriz., doppio movimento

	y = 3 mm
x = 100 mm - 4"	tk 51726-03

45° vert., einfach beweglich, kurz
45° vert., single action, short
 45° vert., action simple, court
45° vert., acción simple, corto
 45° vert., movimento sing., corto

	y = 3 mm
x = 100 mm - 4"	tk 51730-03

70° vertikal, doppelt beweglich
70° vertical, double action
 70° vertical, double action
70° vertical, doble acción
 70° verticale, doppio movimento

	y = 3 mm
x = 100 mm - 4"	tk 51732-03

70° hor., doppelt beweglich
70° hor., double action
 70° hor., double action
70° hor., doble acción
 70° oriz., doppio movimento

	y = 3 mm
x = 100 mm - 4"	tk 51740-03

110° hor., doppelt beweglich
110° hor., double action
 110° hor., double action
110° hor., doble acción
 110° oriz., doppio movimento

	y = 3 mm
x = 100 mm - 4"	tk 51731-03

70° vert., einfach beweglich, kurz
70° vert., single action, short
 70° vert., action simple, court
70° vert., acción simple, corto
 70° vert., movimento sing., corto

	y = 3 mm
x = 100 mm - 4"	tk 51734-03

70° hor., einfach beweglich
70° hor., single action
 70° hor., action simple, court
70° hor., acción simple, corto
 70° oriz., movimento sing., corto

Scharfe Nasenzangen
Nasal cutting forceps

Pinces coupantes pour le nez
Pinzas nasales cortantes
 Pinze taglianti per naso

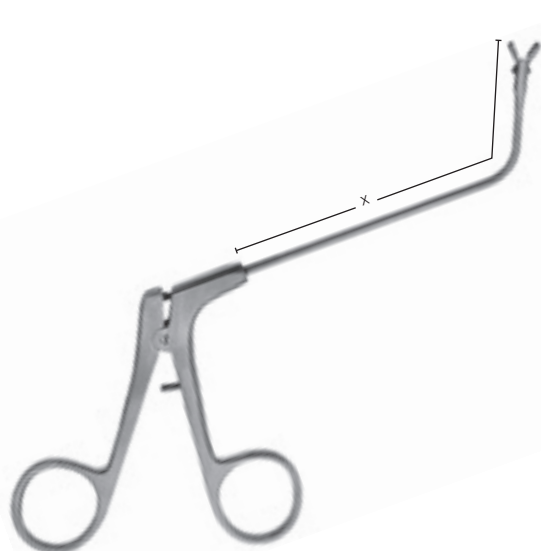

	y = 4 mm
x = 100 mm - 4"	tk 51725-04

45° vertikal, doppelt beweglich
 45° vertical, double action
 45° vertical, double action
 45° vertical, doble acción
 45° verticale, doppio movimento



	y = 4 mm
x = 100 mm - 4"	tk 51728-04

45° hor., doppelt beweglich, kurz
 45° hor., double action, short
 45° hor., double action, court
 45° hor., acción doble, corto
 45° oriz., movimento, corta

	y = 4 mm
x = 100 mm - 4"	tk 51726-04

45° vertikal, einfach beweglich, kurz
 45° vertical, single action, short short
 45° vertical, action simple, court
 45° vertical, acción simple, corto
 45° verticale, movimento singolo, corta



	y = 4 mm
x = 100 mm - 4"	tk 51730-04

70° vertikal, doppelt beweglich
 70° vertical, double action
 70° vertical, double action
 70° vertical, doble acción
 70° verticale, doppio movimento



	y = 4 mm
x = 100 mm - 4"	tk 51733-04

70° hor., doppelt beweglich, kurz
 70° hor., double action, short
 70° hor., double action, court
 70° hor., acción doble, corto
 70° oriz., movimento, corta

	y = 4 mm
x = 100 mm - 4"	tk 51731-04

70° vertikal, einfach beweglich, kurz
 70° vertical, single action, short short
 70° vertical, action simple, court
 70° vertical, acción simple, corto
 70° verticale, movimento singolo, corta

Zirkular Stanze
Circular forceps

Pince circulaire
Pinza circular
Pinza a taglio circolare

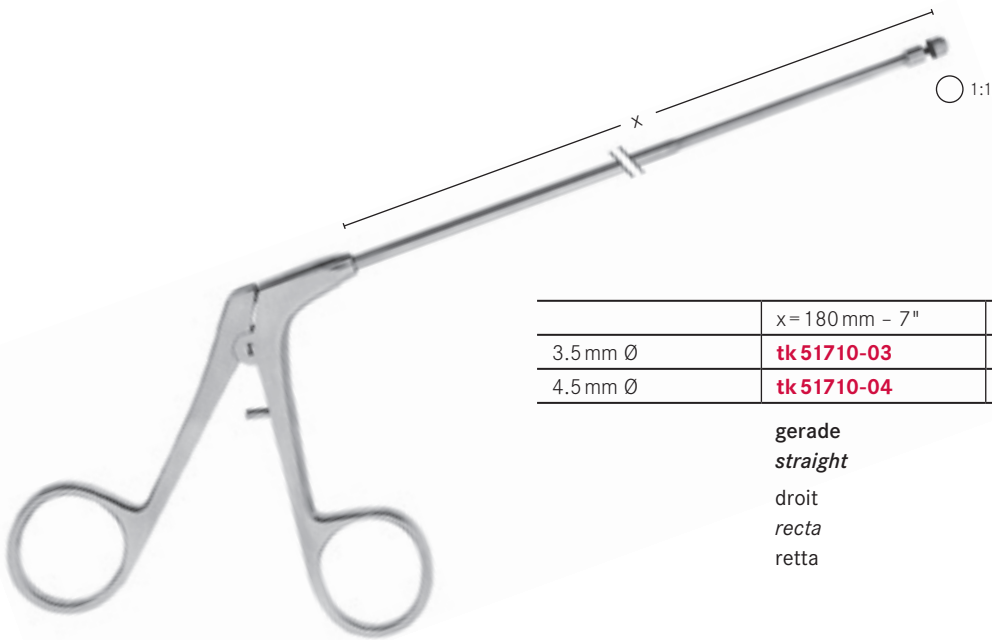

	x = 180 mm - 7"	x = 180 mm - 7"
3.5 mm Ø	tk 51710-03	tk 51711-03
4.5 mm Ø	tk 51710-04	tk 51711-04

gerade
straight

droit
recta
retta

aufgebogen
curved upwards

coudé en haut
curvada arriba
curvata in alto

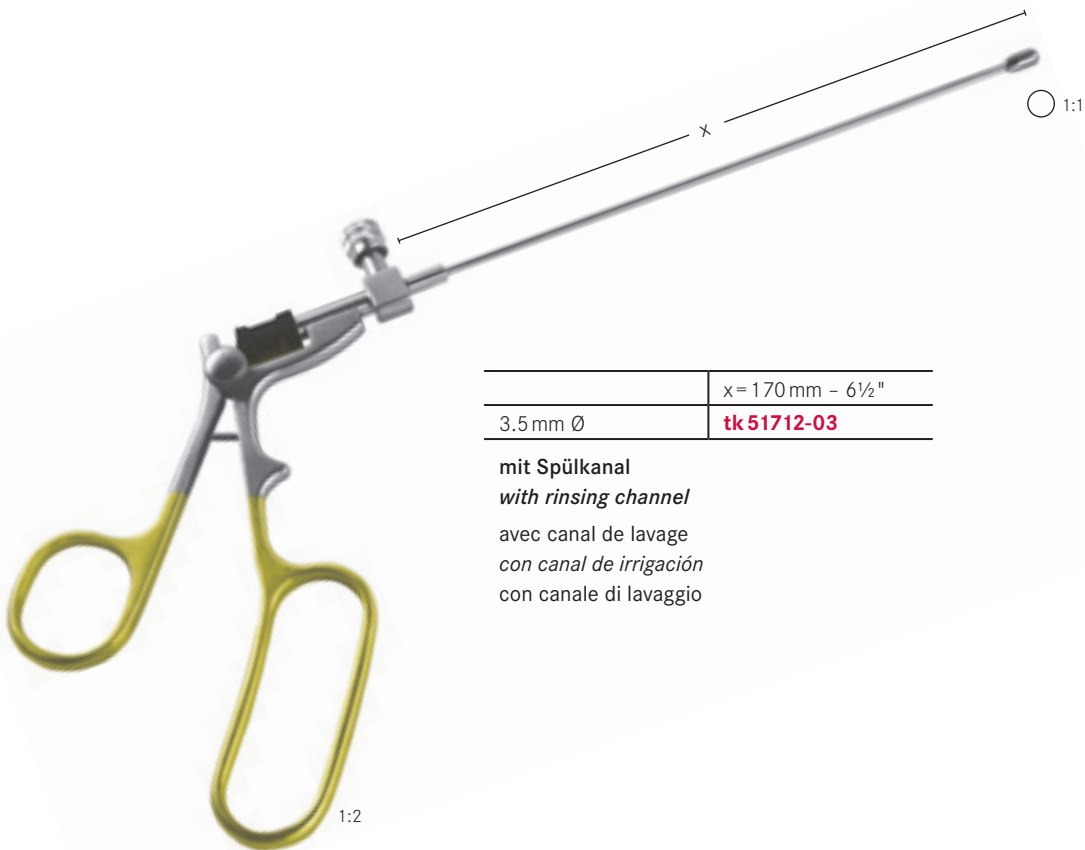

	x = 170 mm - 6½"
3.5 mm Ø	tk 51712-03

mit Spülkanal
with rinsing channel

avec canal de lavage
con canal de irrigación
con canale di lavaggio

Antrumstanzen
Antrum punches

Pinces pour l'antrum
Pinzas antrum
Pinze antrum

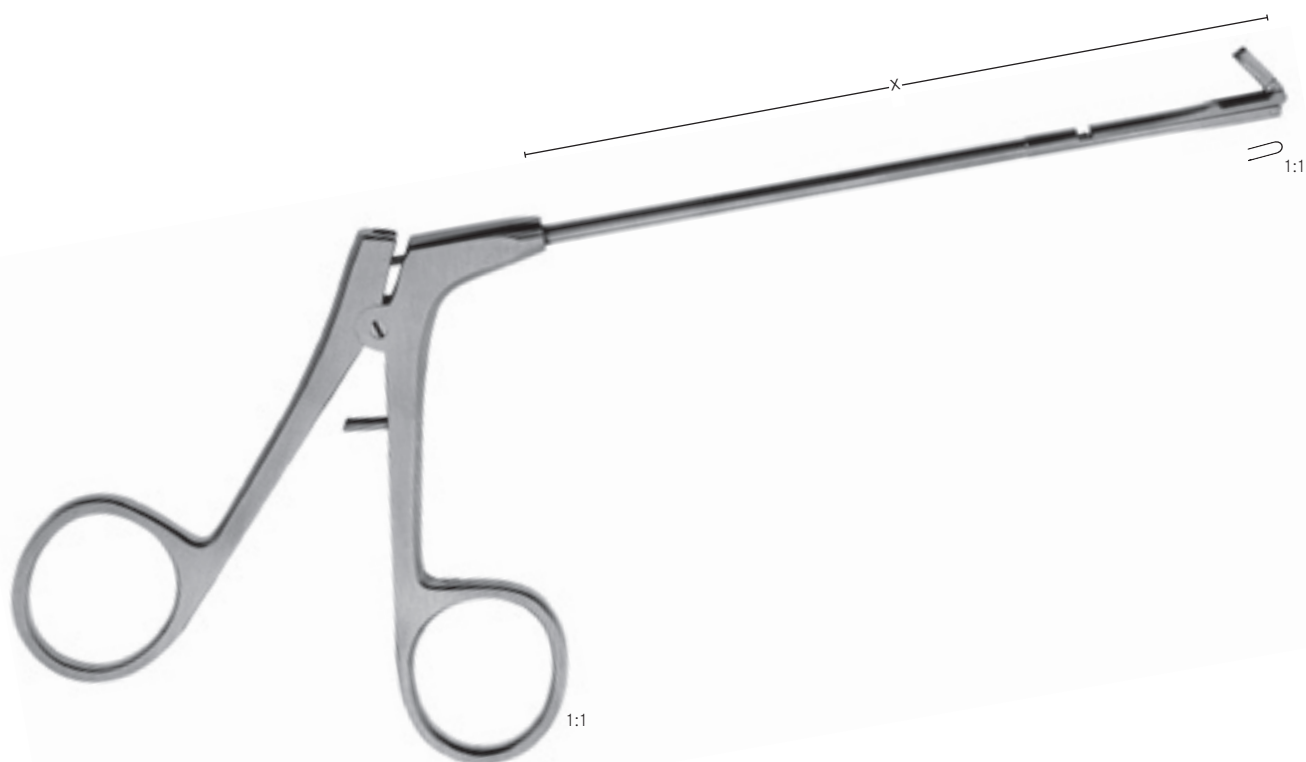

x = 100 mm	Fig. 1	Fig. 2	Fig. 3
1.5 mm x 4.5 mm	tk 51175-01	tk 51175-02	tk 51175-03
	rückwärts nach oben schneidend <i>backward, up-cutting</i> retrograde coupe en haut <i>retrograda corte arriba</i> retrograda tagliente in alto	rückwärts nach rechts schneidend <i>backward, cut to the right</i> retrograde coupe à droite <i>retrograda corte a la derecha</i> retrograda tagliente a destra	rückwärts nach links schneidend <i>backward, cut to the left</i> retrograde coupe à gauche <i>retrograda corte a la izquierda</i> retrograda tagliente a sinistra

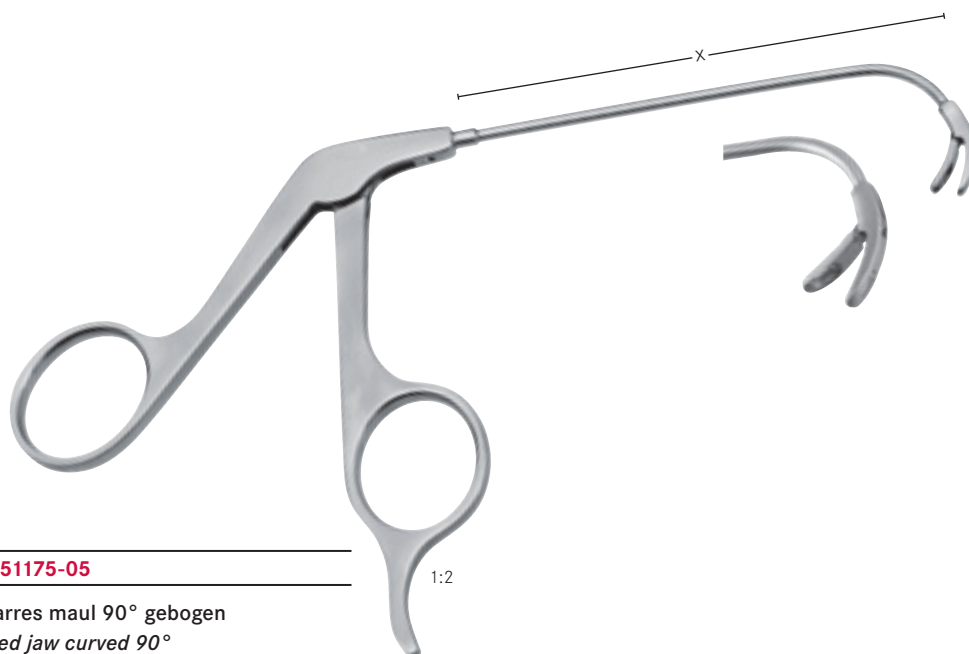

HEUWIESER

x = 100 mm



tk 51175-05

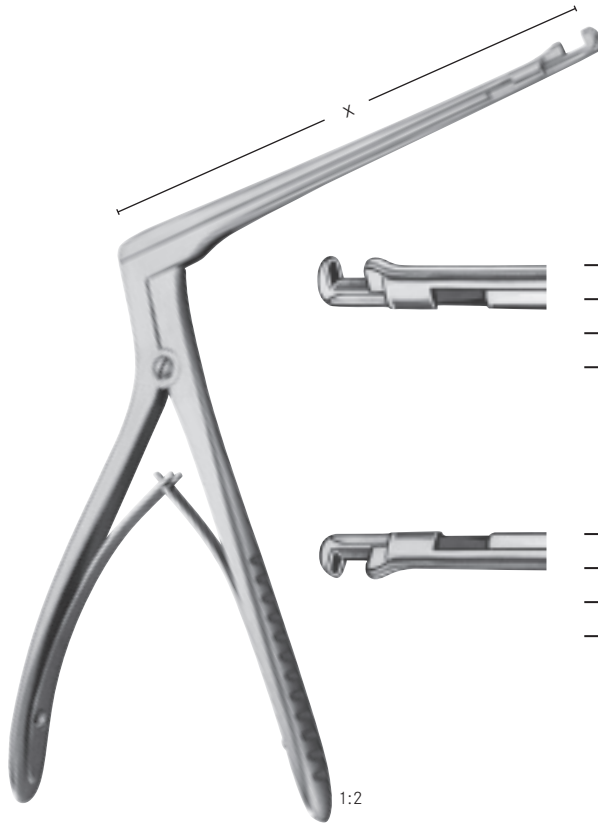

starres maul 90° gebogen
fixed jaw curved 90°
morso fix, courbe de 90°
boca fija, curva de 90°
morsi fissi curvi 90°

Keilbeinstanzen
Sphenoid bone punches

Pinces pour le sinus sphénoïdal
Pinzas para esfenoides
Pinze sfenoidali taglianti



 1:1 HAJEK	 1:1 HAJEK-KOFLER
x = 140 mm - 5½"	x = 140 mm - 5½"
4.0 mm x 4.0 mm	3.5 mm x 3.5 mm
tk 51194-13	tk 51196-12

 1:1 HAJEK	 1:1 HAJEK-KOFLER
x = 140 mm - 5½"	x = 140 mm - 5½"
4.0 mm x 4.0 mm	3.5 mm x 3.5 mm
tk 51195-13	tk 51197-12

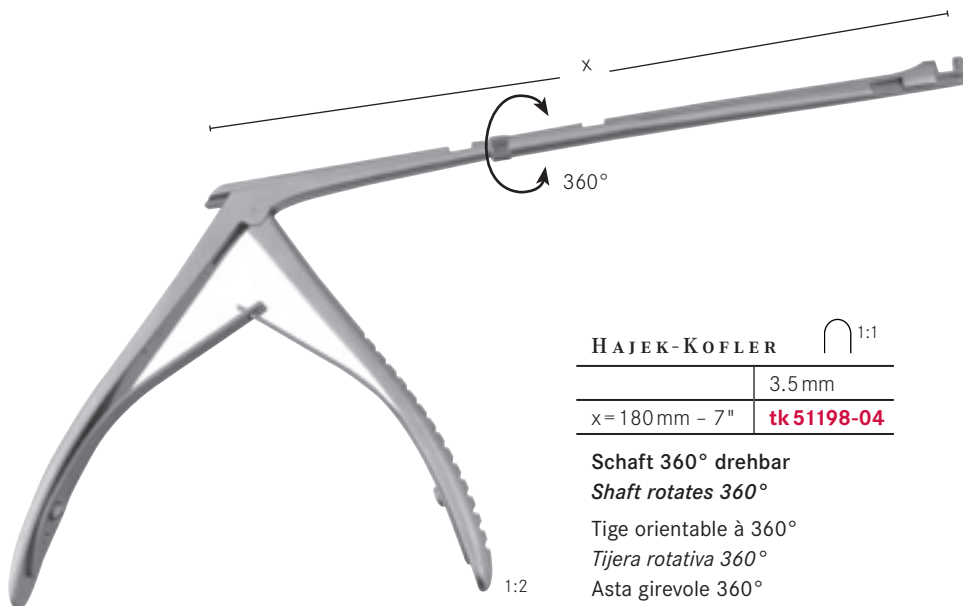

HAJEK-KOFLER  1:1	
	3.5 mm
x = 180 mm - 7"	tk 51198-04

Schaft 360° drehbar
Shaft rotates 360°
Tige orientable à 360°
Tijera rotativa 360°
Asta girevole 360°



Keilbeinstanzen
Punches sphenoid bone

Pinces pour sinus sphénoïdal
Pinzas para esfenoides
Pinze sfenoidali taglienti





HAJEK-CLAUS
200 mm - 8"
tk 51245-20



CITELLI	 1:1	 1:1
170 mm - 6¾"	2.2 mm	3.0 mm
x = 60 mm	tk 50491-02	tk 50491-03





KERRISON



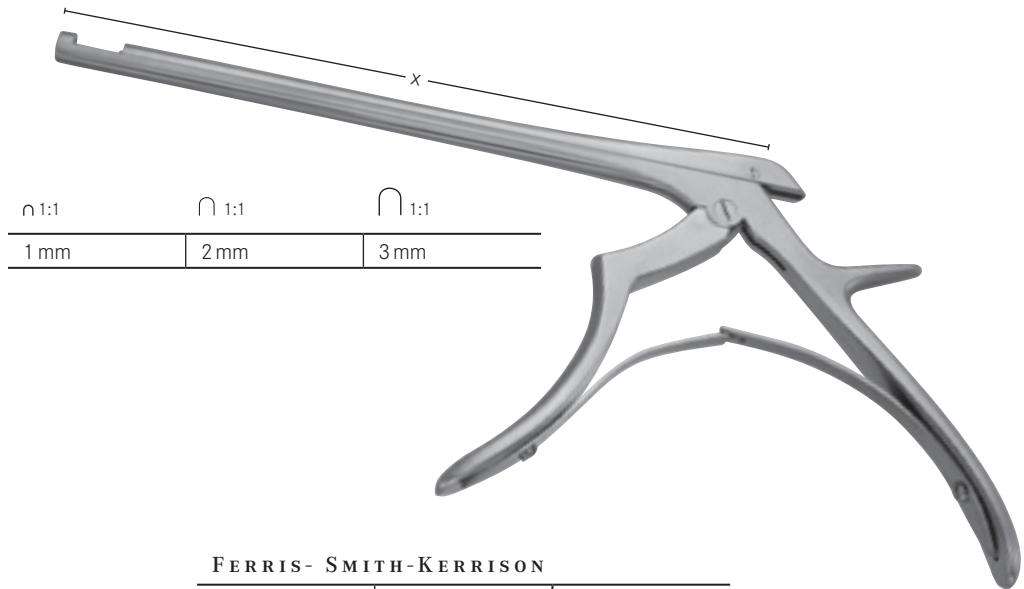



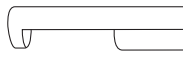

	 1:1	 1:1	 1:1
x = 90 mm - 3½"	4 mm x 4 mm	5 mm x 5 mm	6 mm x 6 mm
200 mm - 8"	tk 51251-01	tk 51251-02	tk 51251-03

Stanzen | Pincas
 Punches | Pinzas
 Pinze

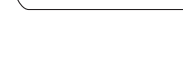

 1:1	 1:1	 1:1
1 mm	2 mm	3 mm

FERRIS- SMITH-KERRISON

	x = 150 mm - 6"	x = 180 mm - 7"
	1 mm tk 28001-01	tk 28002-01
	2 mm tk 28001-02	tk 28002-02
	3 mm tk 28001-03	tk 28002-03
	1 mm tk 28005-01	tk 28006-01
	2 mm tk 28005-02	tk 28006-02
	3 mm tk 28005-03	tk 28006-03
	1 mm tk 28010-01	tk 28011-01
	2 mm tk 28010-02	tk 28011-02
	3 mm tk 28010-03	tk 28011-03

FERRIS- SMITH-KERRISON

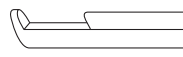
	x = 180 mm - 7"
	1 mm tk 28090-01
	2 mm tk 28090-02
	3 mm tk 28090-03

Dünne Fußplatte

Thin footplate

Plaque de coupe étroite

Lámina de punzonar estrecha

Battente sottile

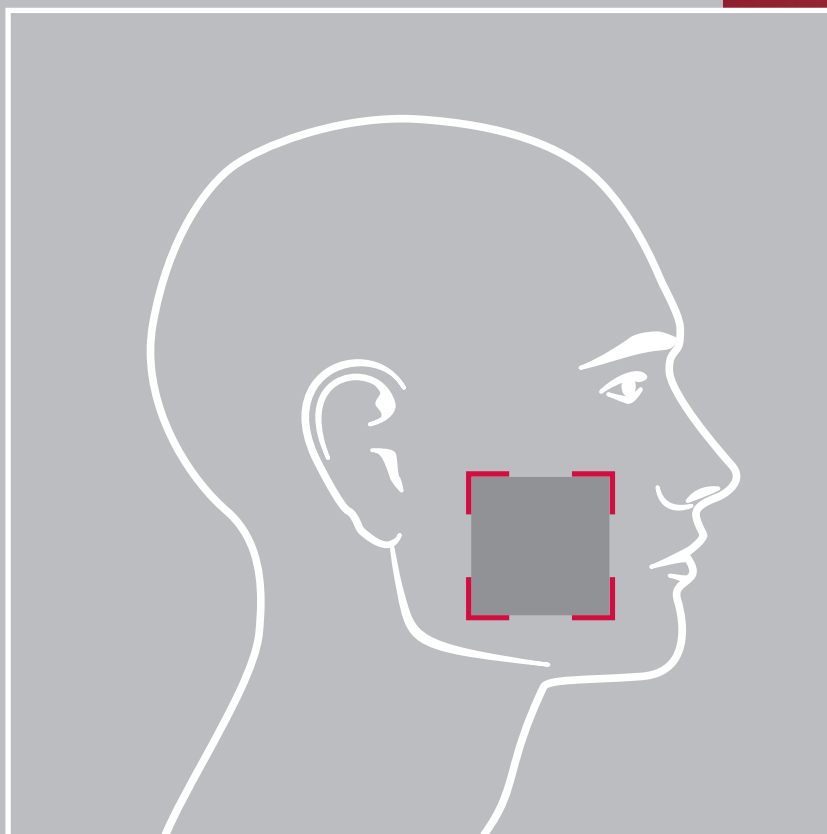

Adenotomie - Tonsillektomie
Adenotomy - Tonsillectomy

Adénotomie - Amygdalectomie
Adenotomía - Tonsilectomia
Adenotomia - Tonsillectomia



Tonsilleninstrumente
Tonsil instruments

Instruments pour amygdales
Instrumentos para amigdalas
Strumenti per tonsille

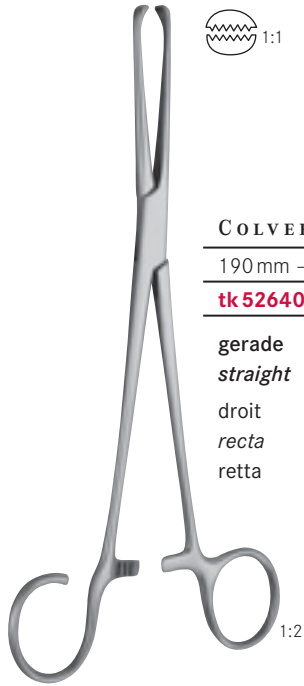

COLVER

190 mm - 7½"	190 mm - 7½"
tk 52640-18	tk 52641-18

gerade <i>straight</i>	gebogen <i>curved</i>
droit <i>recta</i>	courbe <i>curva</i>
retta	curva

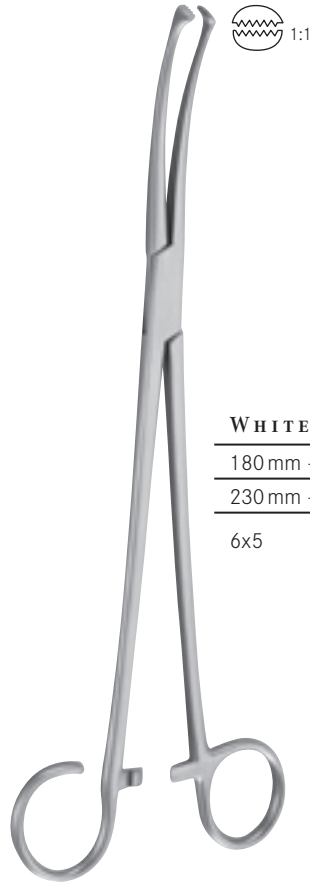

WHITE

180 mm - 7"	tk 52659-18
230 mm - 9"	tk 52659-23

6x5

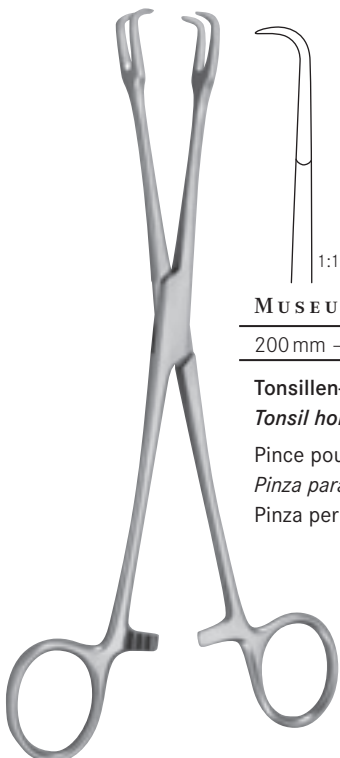

MUSEUX

200 mm - 8"	tk 52664-20
-------------	--------------------

Tonsillen-Fasszange
Tonsil holding forceps
Pince pour amygdales
Pinza para amigdalas
Pinza per tonsille



JACKSON

220 mm - 8¾"	tk 52594-22
--------------	--------------------

Kehlkopfpinzette
Laryngeal forceps
Pince laryngienne
Pinza laringea
Pinza laringea

Tonsillieninstrumente
Tonsil instruments

Instruments pour amygdales
Instrumentos para amígdalas
Strumenti per tonsille



LEWIS

195 mm - 7¾" tk 52612-20

Tonsillenschraube
Tonsil screw

Tire amygdales
Tira amígdalas
Fissa tonsille

1:2



1:1

MARSCHIK

220 mm - 8¾" tk 52622-22

Tonsillen-Fasspinzette
Tonsil seizing forceps

Pince pour saisir les amygdales
Pinza prensora de amígdalas
Pinza da presa tonsille

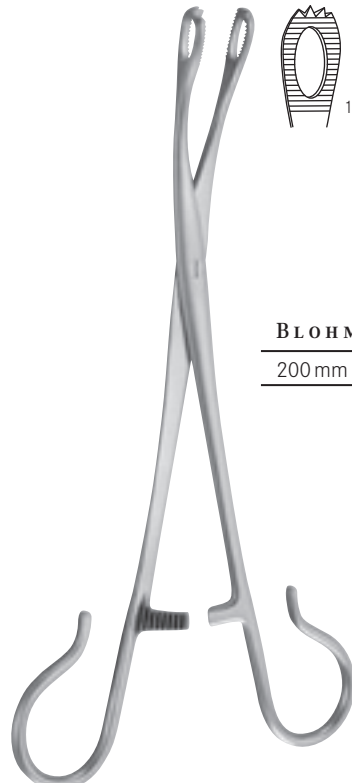

1:1

BLOHMKE

200 mm - 8" tk 52627-20

Tonsilleninstrumente
Tonsil instruments

Instruments pour amygdales
Instrumentos para amigdalas
Strumenti per tonsille



HARTMANN

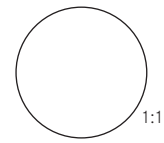
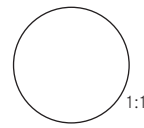
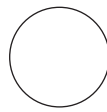

	13 mm Ø	15 mm Ø	17 mm Ø
x = 120 mm	tk 52665-13	tk 52665-15	tk 52665-17

Tonsillotom
Tonsillectome
Amygdalatome
Amigdalótomo
Tonsillotomo



JURASZ

190 mm - 5½"

Nasenrachenzange
Naso-pharyngeal forceps
Pincès rhino-pharyngienne
Pinza naso-faringea
Pinza naso-faringea

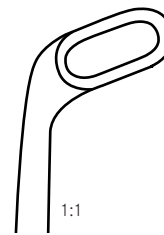

tk 51416-00

scharf
sharp
trenchante
cortante
tagliante

Tonsilleninstrumente
Tonsil instruments

Instruments pour amygdales
Instrumentos para amígdalas
Strumenti per tonsille

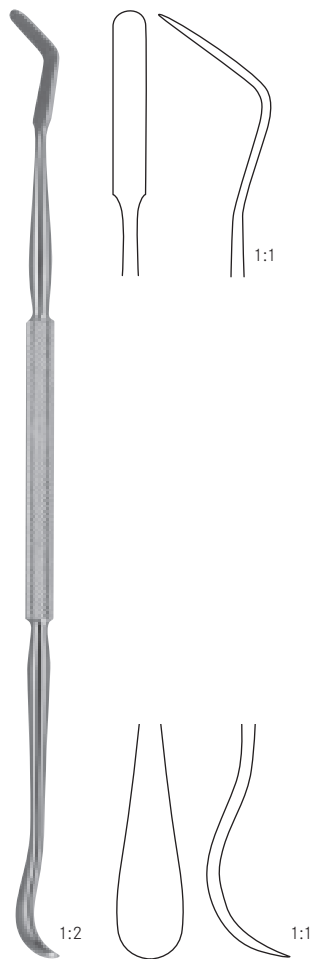

CARPENTER

250 mm - 9 3/4" | **tk 52607-25**

Enucleator
Enucleator

Enucleateur pour amygdales
Enucleador para amígdalas
Enucleatore



LUNIATSCHEK

180 mm - 7" | **tk 52610-19**

Tonsillen-Tamponstopfer
Tonsil tampon plugger

Porte coton
Porta algodones
Porta tamponi

Tonsillinstrumente
Tonsil instruments

Instruments pour amygdales
Instrumentos para amígdalas
Strumenti per tonsille

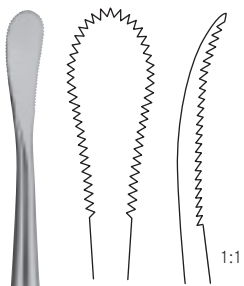

1:1

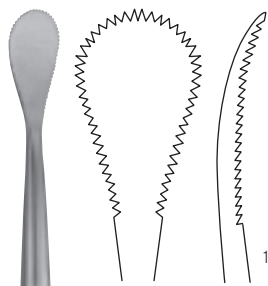

1:1

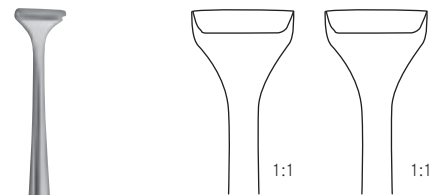

1:1

1:1

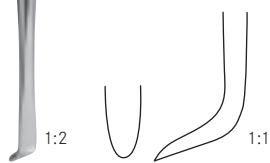

1:2

1:1

HENKE

230 mm - 9"

tk 52601-23

Tonsillendissektor
Tonsil dissector

Dissecteur à amygdales
Disector para amígdalas
Dissettore tonsillare



1:2

1:1

HENKE

230 mm - 9"

tk 52603-23

Tonsillendissektor
Tonsil dissector

Dissecteur à amygdales
Disector para amígdalas
Dissettore tonsillare

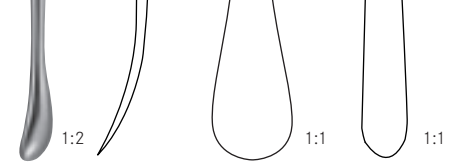

1:2

1:1

1:1

HURD

225 mm - 8¾"

tk 52605-22

tk 52131-13

Tonsillendissektor
Tonsil dissector

Dissecteur à amygdales
Disector para amígdalas
Dissettore tonsillare

Tonsillenmesser
Tonsil knives

Couteaux à tonsils
Bisturis para amigdales
Bisturi per tonsille



FREER

210 mm - 8¼"

tk51361-01

tk51361-02



200 mm - 8"

tk51330-11

Sichelmesser
Sickle knife

Couteau à faucille
Cuchillo falciforme
Coltello a forma di falce



BRUENINGS

230 mm - 9"

tk51315-23

1:2



ABRAHAM

220 mm - 8¾"

tk51317-22

1:2



FISCHER

230 mm - 9"

tk51323-23

1:2

Ringmesser
Adenoid curettes

Couteaux à végétations adénoïdes
Cuchillos para vegetaciones adenoideas
Adenotomi



1:2

ST. CLAIR-
THOMSON

210mm - 8¼"



1:1

tk 51405-01



1:1

tk 51405-02



1:1

tk 51405-03

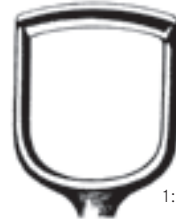

1:1

tk 51405-04



1:2

BARNHILL

220mm - 8¾"



1:1

Fig. 1

tk 51415-01



1:1

Fig. 2

tk 51415-02



1:1

Fig. 3

tk 51415-03



1:1

Fig. 4

tk 51415-04

Ringmesser
Adenoid curettes

Couteaux à végétations adénoïdes
Cuchillos para vegetaciones adenoideas
Adenotomi



BECKMANN



220 mm - 8 3/4 "

tk 51412-01

tk 51412-02

tk 51412-03

gerade
straight
droit
recto
rette

220 mm - 8 3/4 "

tk 51413-01

tk 51413-02

tk 51413-03

gebogen
curved
courbe
curvo
curve



220 mm - 8 3/4 "

tk 51412-04

tk 51412-05

tk 51412-06

gerade
straight
droit
recto
rette

220 mm - 8 3/4 "

tk 51413-04

tk 51413-05

tk 51413-06

gebogen
curved
courbe
curvo
curve

Ringmesser
Adenoid currettes

Couteaux à végétations adénoïdes
Cuchillos para vegetaciones adenoïdes
Adenotomi



1:2

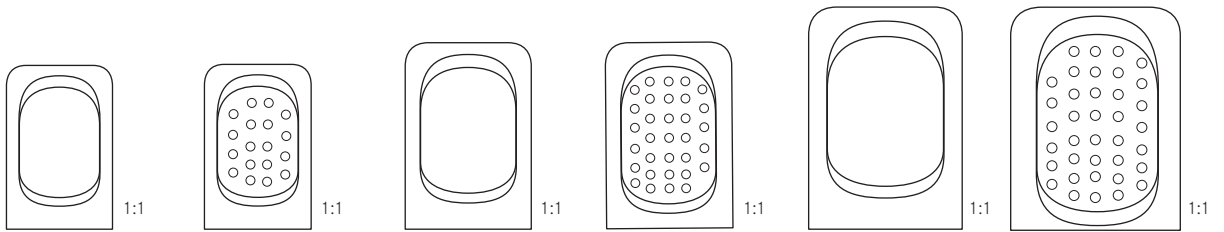

LA FORCE

Fig. 1 250 mm - 7"		Fig. 2 250 mm - 7"		Fig. 3 250 mm - 7"	
tk 51511-01	tk 51513-01	tk 51511-02	tk 51513-02	tk 51511-03	tk 51513-03

tk 51521-01	tk 51522-01	tk 51521-02	tk 51522-02	tk 51521-03	tk 51522-03
--------------------	--------------------	--------------------	--------------------	--------------------	--------------------

Ersatzklingen
Spare blades
Lames de rechange
Hojas de cambio
Lame di ricambio

Tonsillenschnürer
Tonsil snares

Serre noeuds pour amygdales
Cierra-nudos para amigdales
Serranodi per tonsille

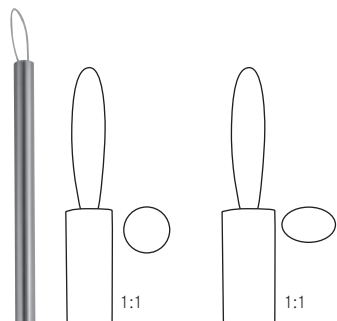

E V E S

280 mm - 11 "	280 mm - 11 "
tk 50336-28	tk 50338-28

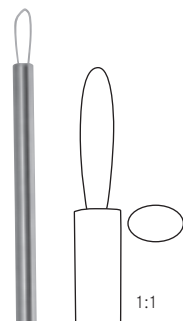

E V E S

280 mm - 11 "
tk 50340-28

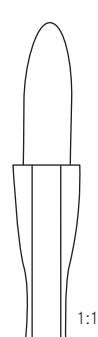

B R U E N I N G S

280 mm - 11 "
tk 50342-28



	10 m - 33 ft.
0.3 mm Ø	tk 50319-30
0.4 mm Ø	tk 50319-40

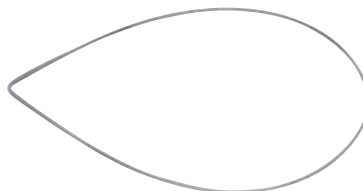

40 mm	tk 50345-40
50 mm	tk 50345-50

Packung mit 100 Stück
Package of 100 pieces

Paquet de 100 pièces
Paquete de 100 piezas
Pacchetto da 100 pezzi

Tonsillenschnürer
Tonsil snares

Serre noeuds pour amygdales
Cierra-nudos para amigdales
Serranodi per tonsille

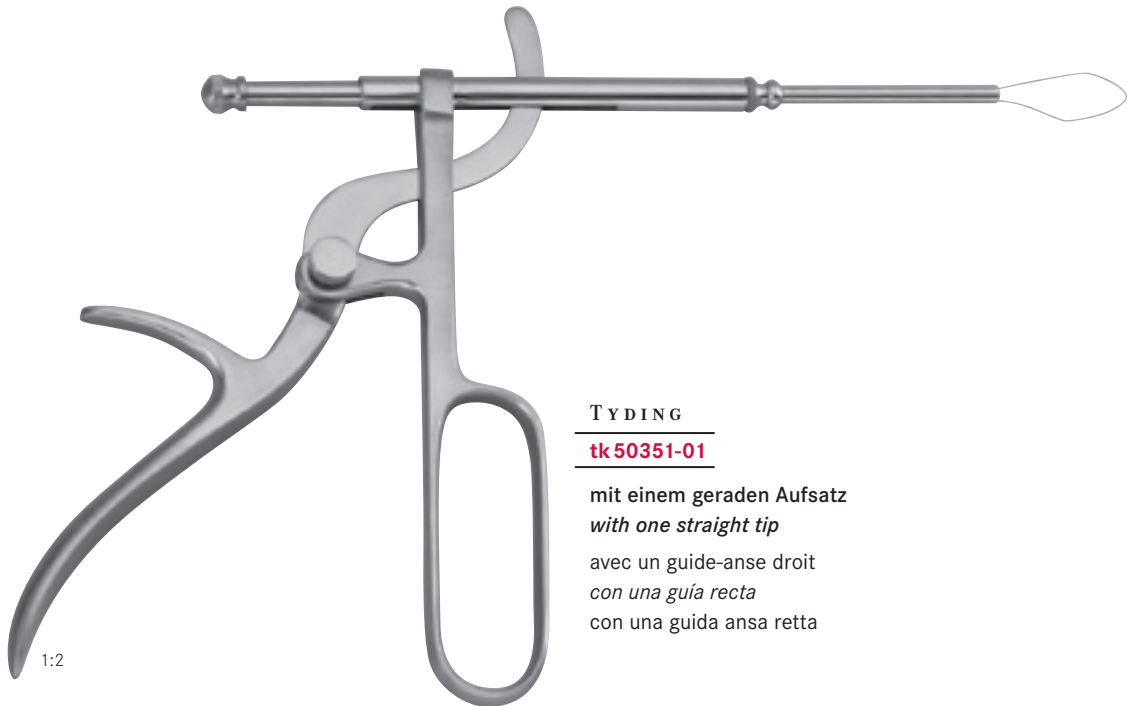

TYDING

tk 50351-01

mit einem geraden Aufsatz
with one straight tip
avec un guide-anse droit
con una guía recta
con una guida ansa retta



0.4 mm Ø x 10 cm

tk 50347-02

Packung mit 100 Stück
Package of 100 pieces

Paquet de 100 pièces
Paquete de 100 piezas
Pacchetto da 100 pezzi

Tonsillotome
Tonsillectomes

Amygdalatomes
Amigdalótomos
Tonsillotomi



1:2

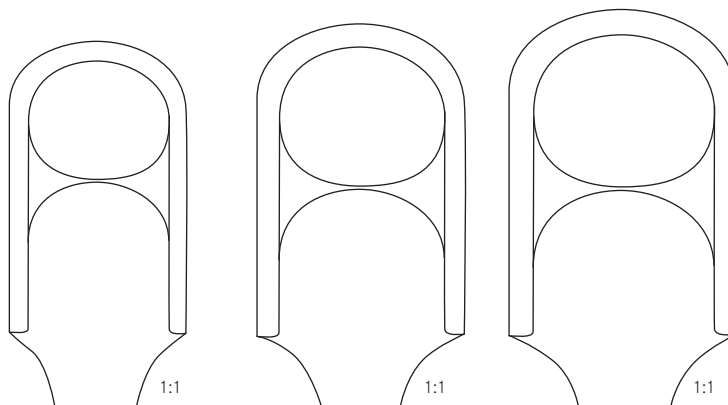

SLUDER-BALLENGER

	Fig. 1	Fig. 2	Fig. 3	
	tk 52671-01	tk 52671-02	tk 52671-03	tk 52671-10

Griff
Handle
Manche
Mango
Manico

tk 52671-00	x	x	x	x
--------------------	---	---	---	---

komplett
complete
complet
completa
completa

Tonsillenscheren
Tonsil scissors

Ciseaux pour amygdales
Tijeras para amigdales
Forbici per tonsille



BOETTCHER

180mm - 7"

tk 8832-18

1:2



PRINCE

175mm - 7"

tk 8837-17

1:2



DEAN

170cm - 6¾"

tk 8852-17

tk 8857-17

gebogen
curved

courbes
curva

curve

gebogen, gezahnt
curved, saw edge

courbes, dentelés
curva, dentada

curve, dentate

1:2



GOOD

190mm - 7½"

tk 8867-19

1:2

Arterienklemmen
Haemostatic forceps

Pinces hémostatiques
Pinzas hemostáticas
Pinze emostatiche



BIRKET

190 mm - 7½"

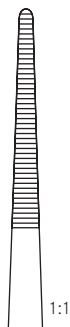

1:1

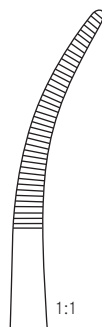

1:1

tk 12094-19

tk 12095-19



BAINBRIDGE

150 mm - 6"

185 mm - 7¼"



tk 12120-15

tk 12121-15

tk 12120-18

tk 12121-18

Arterienklemmen
Haemostatic forceps

Pinces hémostatiques
Pinzas hemostáticas
Pinze emostatiche



SCHNIDT

190 mm - 7½"



1:1

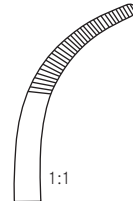

1:1

tk 12241-19

tk 12243-19



TOENNIS

210 mm - 8¼"

260 mm - 10¼"

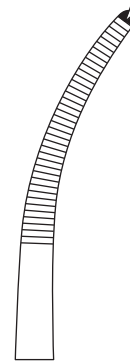
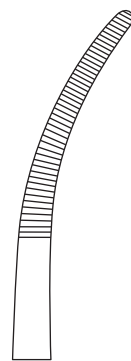

tk 12250-21

tk 12251-21

tk 12252-21

tk 12253-21

tk 12250-26

tk 12251-26

tk 12252-26

tk 12253-26

1x2

1x2

Arterienklemmen
Haemostatic forceps

Pinces hémostatiques
Pinzas hemostáticas
Pinze emostatiche

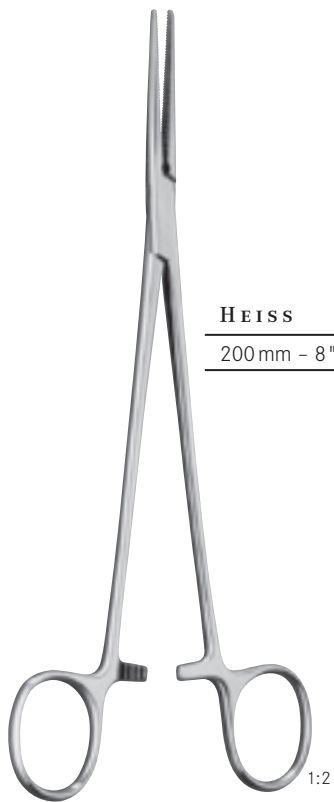

HEISS

200 mm - 8"

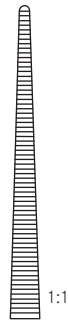

1:1

tk 12230-20

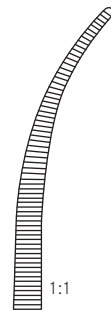

1:1

tk 12231-20

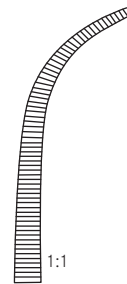

1:1

tk 12233-20

Präparier- und Ligaturklemmen
Dissecting and ligature forceps

Pinces à disséquer et à sutures
Pinzas para preparación y suturas
Pinze per preparazioni e suture

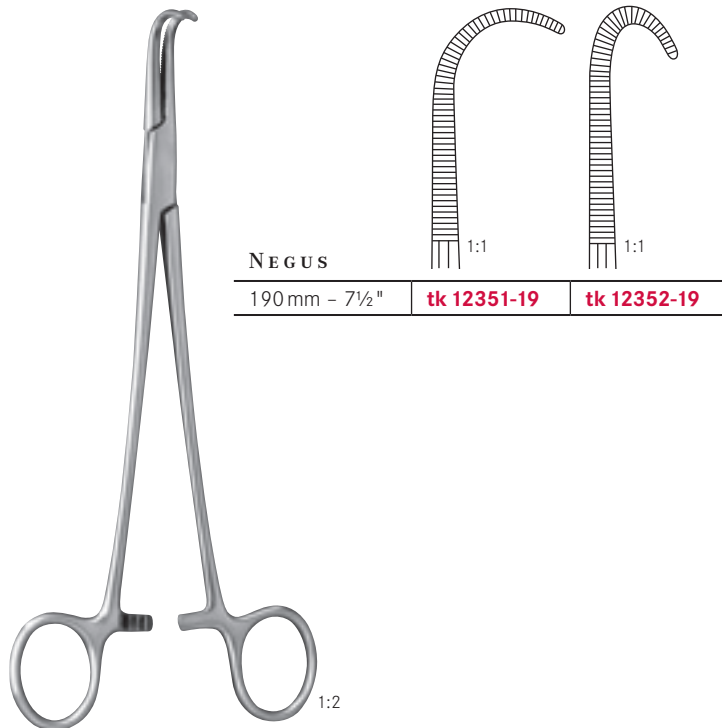

Nahtinstrumente
Suture instruments

Instruments à suture
Instrumentos para sutura
Strumenti per sutura



HURD

210 mm - 8¼"

tk 21232-21

tk 21233-21

für die rechte Hand
for the right hand

für die linke Hand
for the left hand

pour la main droite
para la mano derecha
per la mano destra

pour la main gauche
para la mano izquierda
per la mano sinistra

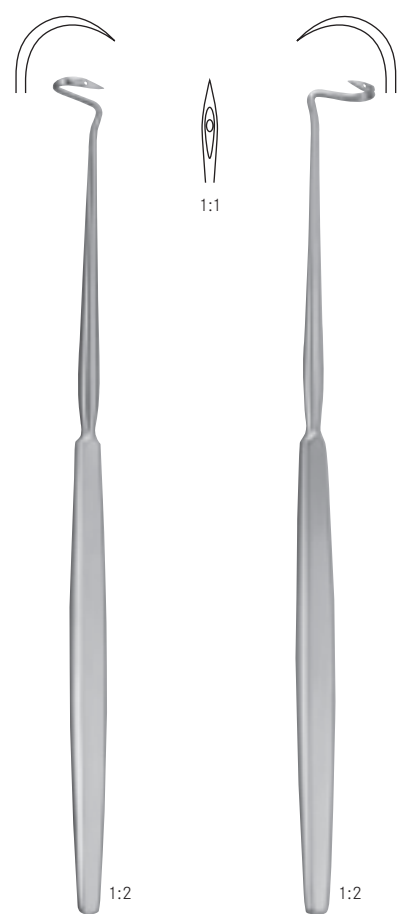

DUPUY-WEISS

220 mm - 8¾"

tk 21226-22

tk 21227-22

für die rechte Hand
for the right hand

für die linke Hand
for the left hand

pour la main droite
para la mano derecha
per la mano destra

pour la main gauche
para la mano izquierda
per la mano sinistra

Nahtinstrumente
Suture instruments

Instruments à suture
Instrumentos para sutura
Strumenti per sutura



ROTTER

260 mm - 10 1/4"



tk 21220-01

für die rechte Hand
for the right hand
pour la main droite
para la mano derecha
per la mano destra



tk 21221-01

für die linke Hand
for the left hand
pour la main gauche
para la mano izquierda
per la mano sinistra

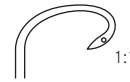

tk 21220-02

für die rechte Hand
for the right hand
pour la main droite
para la mano derecha
per la mano destra



tk 21221-02

für die linke Hand
for the left hand
pour la main gauche
para la mano izquierda
per la mano sinistra



SCHMIEDEN

210 mm - 8 1/4"

tk 21217-22



CLAUS-
EICKEN

230 mm - 9"

tk 21218-23



CLAUS

230 mm - 9"

tk 21219-23

Unterbindungsnadeln | Aiguilles à suture
Ligature needles | *Agujas para sutura*
 Aghi per sutura

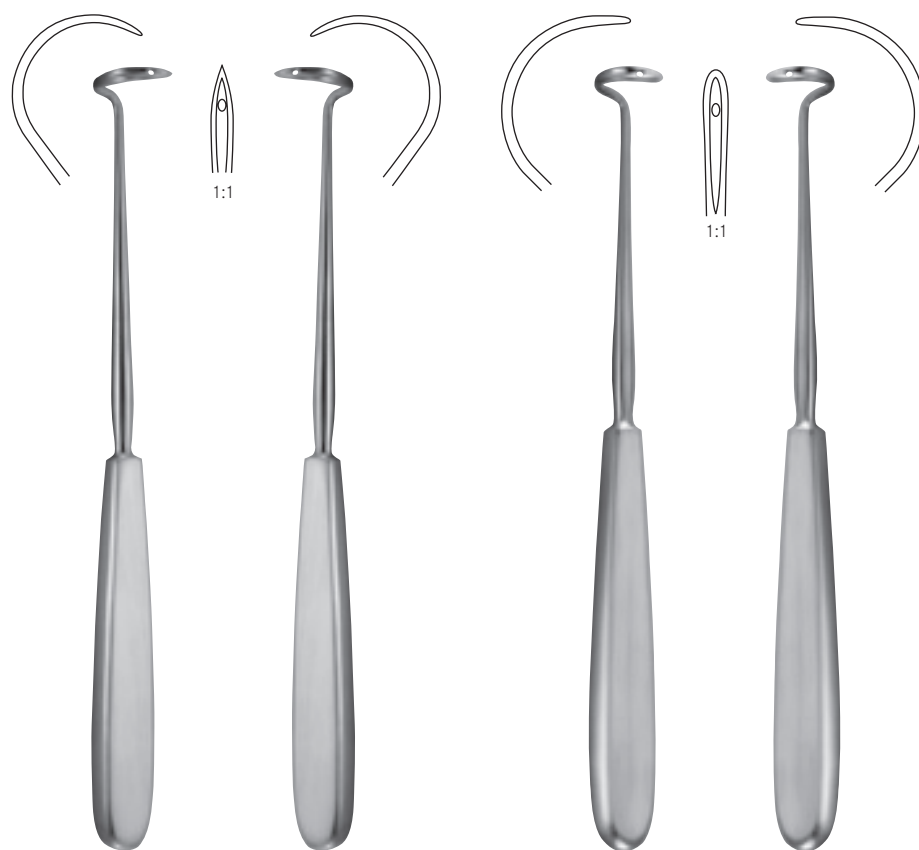

DESCHAMPS

200 mm - 8"	tk 21210-20	tk 21212-20	tk 21214-20	tk 21216-20
210 mm - 8¼"	tk 21210-21	tk 21212-21	tk 21214-21	tk 21216-21
270 mm - 10¾"	tk 21210-27	tk 21212-27	tk 21214-27	tk 21216-27

scharf
sharp
 pointue
aguda
acuta

für die rechte Hand
for the right hand

pour la main droite
para la mano derecha
 per la mano destra

scharf
sharp
 pointue
aguda
acuta

für die linke Hand
for the left hand

pour la main gauche
para la mano izquierda
 per la mano sinistra

stumpf
blunt
 mousse
roma
smussa

für die rechte Hand
for the right hand

pour la main droite
para la mano derecha
 per la mano destra

stumpf
blunt
 mousse
roma
smussa

für die linke Hand
for the left hand

pour la main gauche
para la mano izquierda
 per la mano sinistra

Saug- und Spülkanülen
Suction and irrigation cannulas

Canules pour aspiration et lavage
Canulas para aspiracion y lavado
Cannule per aspirazione e lavaggio

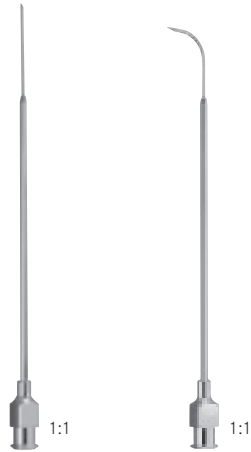

0.8 mm Ø	tk 6388-01	tk 6388-03
Tonsillenkanüle <i>Tonsil needle</i>	gerade <i>straight</i>	gebogen <i>curved</i>
Aiguille pour amygdales <i>Aguja para amigdales</i>	droite <i>recta</i>	courbe <i>curva</i>
Cannule per tonsille	retta	curva



0.8 mm Ø	tk 6388-04	tk 6388-02
Septumkanüle <i>Septum needle</i>	bajonettförmig <i>bayonet</i>	abgewinkelt <i>angled on flat</i>
Aiguille pour le cloison nasal <i>Aguja para el tabique nasal</i>	baïonette <i>bayoneta</i>	coudé sur le plat <i>angulado</i>
Ago per setto nasale	baionetta	angolato



LUER-LOCK

1 ml	tk 6710-01	tk 6711-01
2 ml	tk 6710-02	tk 6711-02
5 ml	tk 6710-05	tk 6711-05
10 ml	tk 6710-10	tk 6711-10
20 ml	tk 6710-20	tk 6711-20
50 ml	tk 6710-50	tk 6711-50

Spritze, komplett Zylinder
Syringe, complete Barrel
Seringue, complète Cylindre
Jeringa, completa Cilindro
Siringa, completa Cilindro

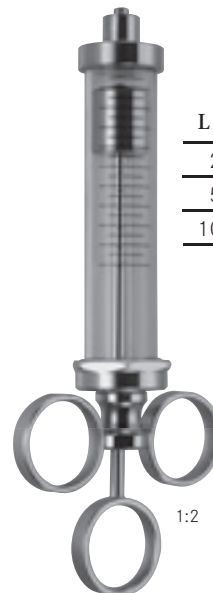

LUER-LOCK

2 ml	tk 6780-02	tk 6781-02
5 ml	tk 6780-05	tk 6781-05
10 ml	tk 6780-10	tk 6781-10

Spritze, komplett Zylinder
Syringe, complete Barrel
Seringue, complète Cylindre
Jeringa, completa Cilindro
Siringa, completa Cilindro

tk 6782-02

Luer Lock Anschluß
Luer Lock attachment

Raccord Luer Lock
Connector Luer Lock
Raccordo Luer Lock



Ersatzteile und Zubehör auf Anfrage
Spare parts and accessories upon request

Pièces de rechange et accessoires sur demande
Piezas de cambio y accesorios según demanda
Pezzi di ricambio ed accessori a richiesta

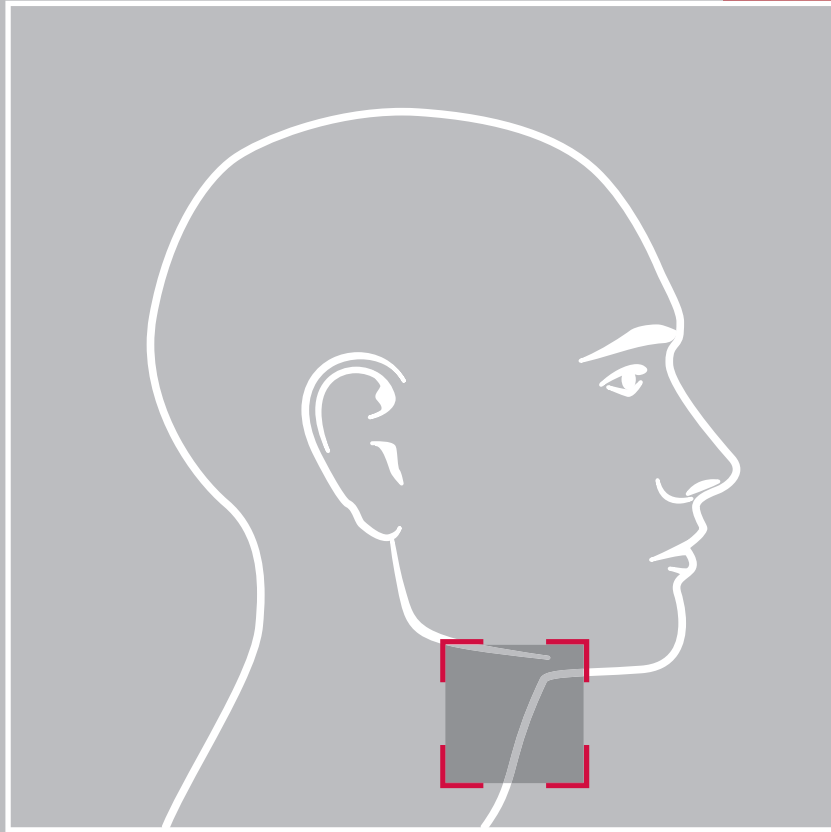

Laryngologie | Laryngologie
Laryngology | *Laringología*
Laringologia



Laryngoskope
Laryngoscopes
Laryngoscopes
Laringoscopios
Laringoscopi

autoklavierbar / autoclavable
134°C / 273°F - 18 min.

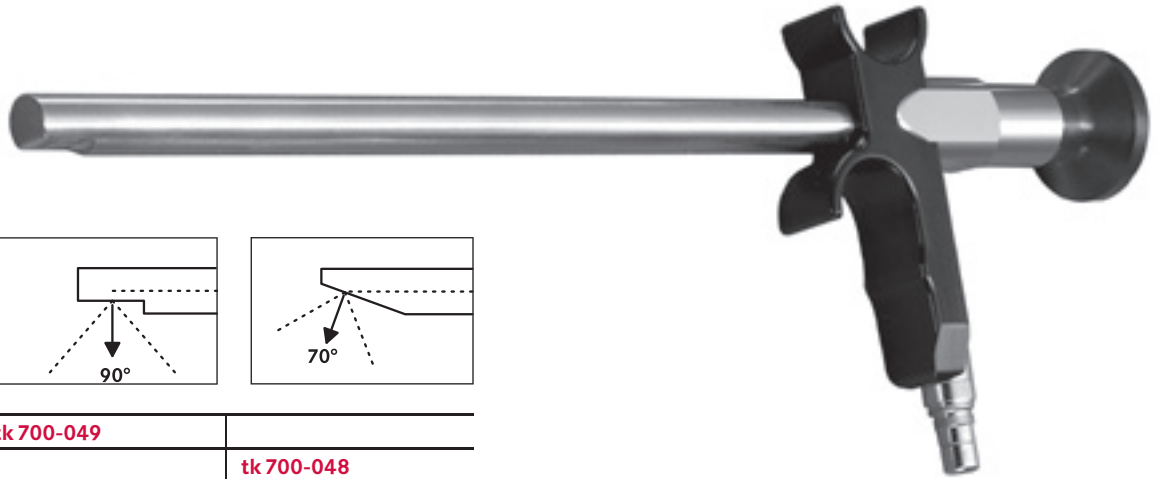

Ø, Arbeitslänge
Ø, Working length
Ø, Longueur de travail
Ø, Longitud de trabajo
Ø, Lunghezza operativa

autoklavierbar / autoclavable
134°C / 273°F - 18 min.

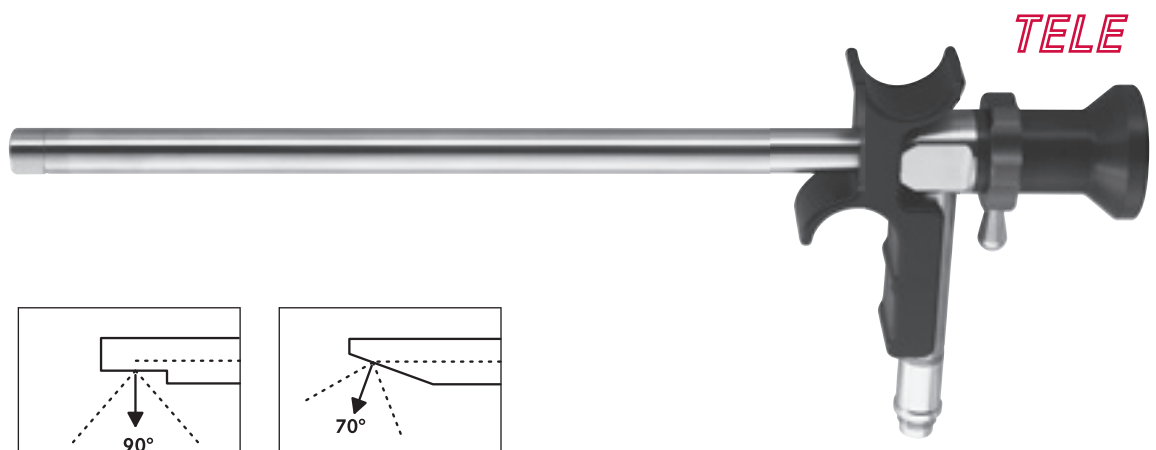

Ø, Arbeitslänge
Ø, Working length
Ø, Longueur de travail
Ø, Longitud de trabajo
Ø, Lunghezza operativa

TELE

Mikro-Laryngoskope
Micro laryngoscopes

Micro laryngoscopes
Micro laringoscpios
 Micro laringoscopi

autoklavierbar / autoclavable
 134°C / 273°F - 18 min.

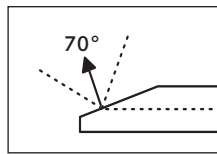
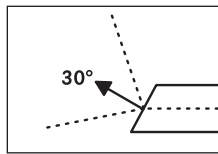

Ø 4.0 mm - 175 mm		tk 700-055
Ø 5.0 mm - 240 mm	tk 700-057	tk 700-058
Ø 5.8 mm - 175 mm		tk 700-056

Ø, Arbeitslänge

Ø, *Working length*

Ø, Longueur de travail

Ø, *Longitud de trabajo*

Ø, Lunghezza operativa

Laryngoskope
Laryngoscopes

Laryngoscopes
Laringoscopios
Laringoscopi

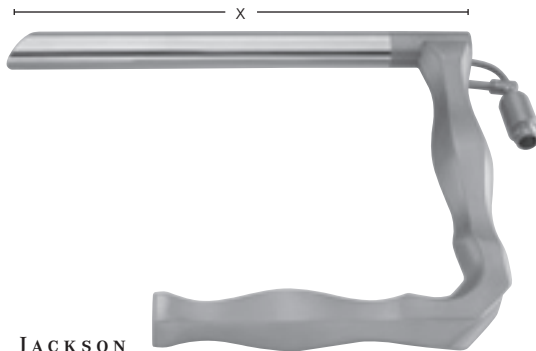

JACKSON

	x = 120 mm	x = 170 mm	x = 180 mm
	tk 5190-01	tk 5190-02	tk 5190-03
Jackson mit Lichtträger, rostfrei <i>Jackson with light carrier, stainless steel</i>	für Säuglinge <i>for babys</i>	für Kinder <i>for children</i>	für Erwachsene <i>for adults</i>
Jackson avec porte de lumière, inoxydable <i>Jackson con porta fibras, inoxidable</i>	pour nourissons <i>para lactantes</i>	pour enfants <i>para niños</i>	pour adultes <i>para adultos</i>
Jackson con porta luce, inossidabile	per lattanti	per bambini	per adulti

	x = 120 mm	x = 170 mm	x = 180 mm
	tk 5191-01	tk 5191-02	tk 5191-03
Lichtträger, allein, für Jackson <i>Light carrier, only, for Jackson</i>	für Säuglinge <i>for babys</i>	für Kinder <i>for children</i>	für Erwachsene <i>for adults</i>
Porte de lumière, seul, pour Jackson <i>Porta fibras, sola, para Jackson</i>	pour nourissons <i>para lactantes</i>	pour enfants <i>para niños</i>	pour adultes <i>para adultos</i>
Porta luce, sola, per Jackson	per lattanti	per bambini	per adulti

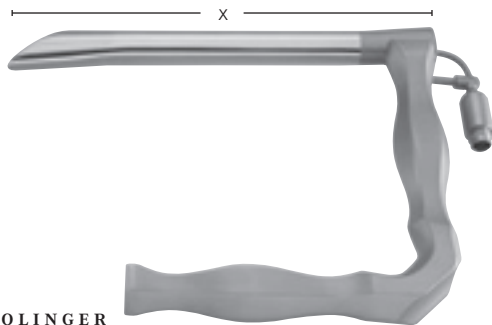

HOLINGER

	x = 171 mm	x = 180 mm
	tk 5195-01	tk 5195-02
Holinger mit Lichtträger, rostfrei <i>Holinger with light carrier, stainless steel</i>		
Holinger avec porte de lumière, inoxydable <i>Holinger con porta fibras, inoxidable</i>		
Holinger con porta luce, inossidabile		

	x = 171 mm	x = 180 mm
	tk 5196-01	tk 5196-02
Lichtträger, allein, für Holinger <i>Light carrier, only, for Holinger</i>		
Porte de lumière, seul, pour Holinger <i>Porta fibras, sola, para Holinger</i>		
Porta luce, solo, per Holinger		

Operationslaryngoskope
Operation laryngoscopes

Laryngoscopes pour interventions chirurgicales
Laringoscopios para operaciones
Laringoscopi per intervento chirurgico

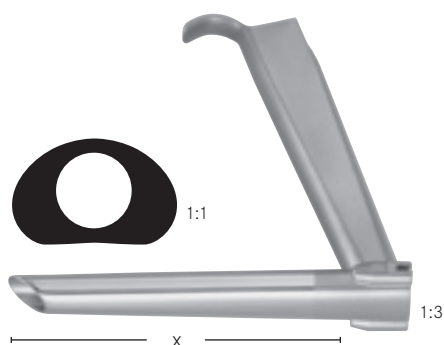

Fig. 1

x = 135 mm	tk 5250-01
------------	-------------------

Rostfreier Edelstahl
Stainless steel
Acier inoxydable
Acero inoxidable
Acciaio inossidabile



Fig. 2

x = 152 mm	tk 5250-02
------------	-------------------

Rostfreier Edelstahl
Stainless steel
Acier inoxydable
Acero inoxidable
Acciaio inossidabile

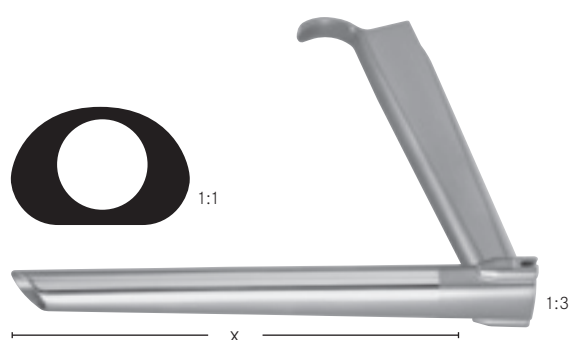

Fig. 3

x = 182 mm	tk 5250-03
------------	-------------------

Rostfreier Edelstahl
Stainless steel
Acier inoxydable
Acero inoxidable
Acciaio inossidabile



Fig. 4

x = 172 mm	tk 5250-04
------------	-------------------

Rostfreier Edelstahl
Stainless steel
Acier inoxydable
Acero inoxidable
Acciaio inossidabile



1:2

Ø 15 mm - 280 mm	tk 5259-00
Ø 30 mm - 270 mm	tk 5259-01

Reinigungsbürste
Cleaning brush
Brosse de nettoyage
Cepillo de limpieza
Spazzolini

10 Stück
10 pieces
10 pièces
10 piezas
10 pezzi

Operationslaryngoskope
Operation laryngoscopes

Laryngoscopes pour interventions chirurgicales
Laringoscopios para operaciones
Laringoscopi per intervento chirurgico

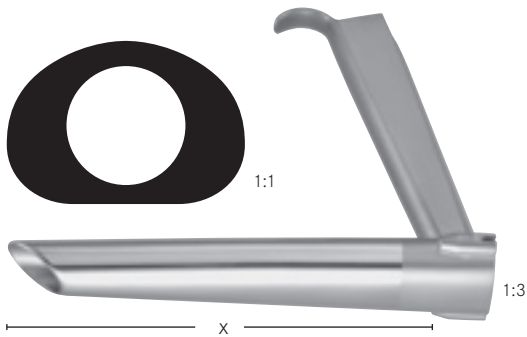

Fig. 5

x = 172 mm **tk 5250-05**

Rostfreier Edelstahl
Stainless steel

Acier inoxydable
Acero inoxidable
Acciaio inossidabile

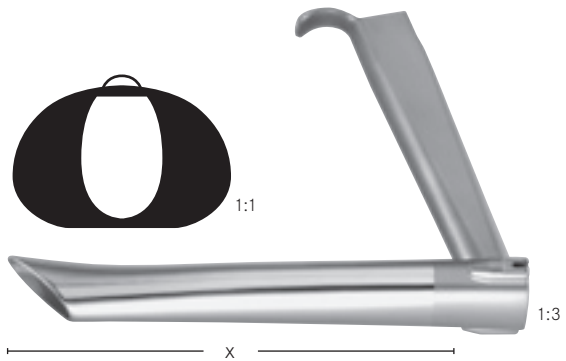

Fig. 6

x = 182 mm **tk 5250-06**

Rostfreier Edelstahl
Stainless steel

Acier inoxydable
Acero inoxidable
Acciaio inossidabile

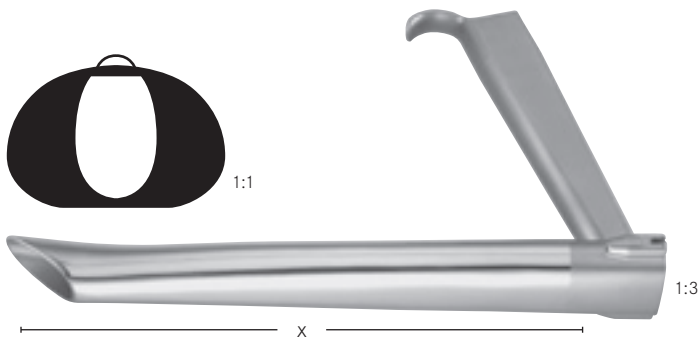

Fig. 7

x = 222 mm **tk 5250-07**

Rostfreier Edelstahl
Stainless steel

Acier inoxydable
Acero inoxidable
Acciaio inossidabile



340 mm - 13" **tk 5251-00**

Bruststütze mit Stützstange für Erwachsene
Chest-support with support-rod for adults

Appui-poitrine avec tige pour adultes
Soporte de pecho con vara para adultos
Supporto per petto con asta per adulti

240 mm - 9" **tk 5251-50**

Stützstange für Kinder
Support-rod for children

Tige pour enfants
Vara para niños
Asta per bambini

Fiberglas-Lichtträger
Fiberglas light-guides

Portes lumière-froide
Porta fibras
Porta luce con fibra ottica



tk 5252-00

für Laryngoskope tk 5250-01 – tk 5250-02
for laryngoscopes tk 5250-01 – tk 5250-02
pour laryngoscopes tk 5250-01 – tk 5250-02
para laringoscopios tk 5250-01 – tk 5250-02
per laringoscopi tk 5250-01 – tk 5250-02



tk 5260-00

Rauchabsaugrohr für Laryngoskope tk 5250-03 – tk 5250-07
Suction tube for laryngoscopes tk 5250-03 – tk 5250-07
Tube d'aspiration pour laryngoscopes tk 5250-03 – tk 5250-07
Tubo de aspiración para laringoscopios tk 5250-03 – tk 5250-07
Tubo d'aspirazione per laringoscopi tk 5250-03 – tk 5250-07



tk 5254-00

für Laryngoskope tk 5250-03 – tk 5250-06
for laryngoscopes tk 5250-03 – tk 5250-06
pour laryngoscopes tk 5250-03 – tk 5250-06
para laringoscopios tk 5250-03 – tk 5250-06
per laringoscopi tk 5250-03 – tk 5250-06



tk 5258-00

Injektionskanüle für Laryngoskope tk 5250-01 – tk 5250-07
Injections drain tube for laryngoscopes tk 5250-01 – tk 5250-07
Canule à injection pour laryngoscopes tk 5250-01 – tk 5250-07
Canula de inyección para laringoscopios tk 5250-01 – tk 5250-07
Cannula d'iniezione per laringoscopi tk 5250-01 – tk 5250-07



tk 5256-00

für Laryngoskop tk 5250-07
for laryngoscope tk 5250-07
pour laryngoscope tk 5250-07
para laringoscopio tk 5250-07
per laringoscopio tk 5250-07

Kehlkopf Instrumente
Laryngeal instruments

Instruments pour la laryngologie
Instrumentos para la laringología
Strumenti per laringologia

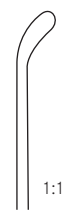
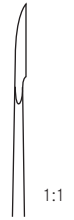
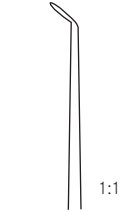
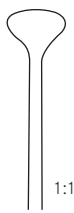

230 mm - 9"

tk 53584-01

tk 53584-02

tk 53584-03

tk 53584-04

tk 53584-05

tk 53584-06

Messer

Knifes

Couteaux

Cuchillos

Bisturi

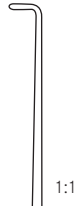
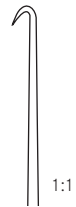
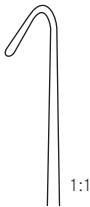

230 mm - 9"

tk 53585-01

tk 53585-02

tk 53585-03

Haken

Hooks

Crochets

Ganchos

Uncini

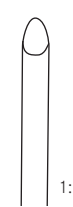

230 mm - 10"

tk 53585-04

Saugraspatorium

Suction raspatory

Rugine aspirante

Legra aspiradora

Elevatore-aspiratore

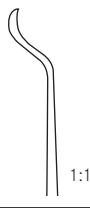

230 mm - 9"

tk 53585-06

tk 53585-05

Nadeln

Needles

Aiguilles

Agujas

Aghi

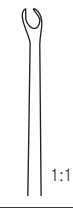

230 mm - 10"

tk 53585-07

Knotenführer

Knot guide

Pousse-noeuds

Guía de ligaduraas

Spingi-nodo

Kehlkopf Instrumente
Laryngeal instruments

Instruments pour la laryngologie
Instrumentos para la laringología
Strumenti per laringologia



110 mm - 4¼"	tk 53584-00
--------------	--------------------

Handgriff
Handle

Manche
Mango
Manico



	2.5 mm Ø
280 mm - 11"	tk 19470-28

1:2

Watteträger
Cotton carrier

Porte-cotons
Porta- algodones
Portacotone

Saugrohre
Suction tubes

Canules de suction
Canulas de succión
Cannule di aspirazione

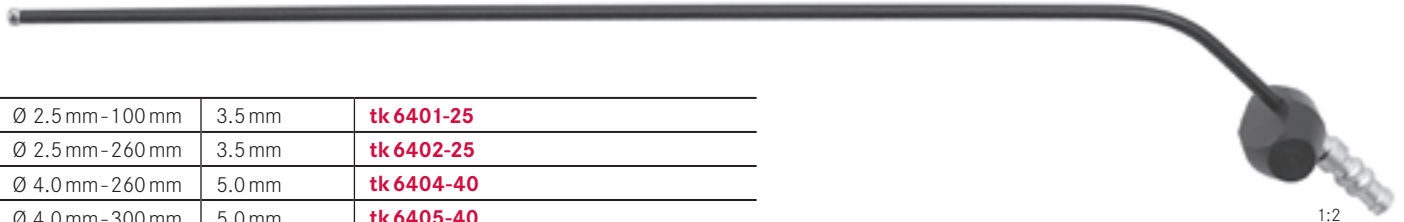

Ø 2.5 mm - 100 mm	3.5 mm	tk 6401-25
Ø 2.5 mm - 260 mm	3.5 mm	tk 6402-25
Ø 4.0 mm - 260 mm	5.0 mm	tk 6404-40
Ø 4.0 mm - 300 mm	5.0 mm	tk 6405-40

Ø, Nutzlänge	Kugel Ø	Koagulations-Saugrohre, gerade
Ø, Length	Ball Ø	Coagulation suction tubes, straight
Ø, Longueur	Boule Ø	Canules de suction et coagulation, droits
Ø, Longitud	Bola Ø	Canulas de succión et coagulación, rectas
Ø, Lunghezza operativa	Sfera Ø	Cannule di aspirazione e coagulazione, rette



Ø 2.0 mm - 250 mm	tk 25224-01
Ø 2.5 mm - 250 mm	tk 25224-02
Ø 3.0 mm - 250 mm	tk 25224-03

Ø, Nutzlänge
Ø, Length
Ø, Longueur
Ø, Longitud
Ø, Lunghezza operativa

1:2

Mikro-Instrumente für Laryngologie
Micro-instruments for laryngology

Micro-instruments pour la laryngologie
Micro-instrumentos para la laringología
 Micro-strumenti per laringologia

250 mm - 10"

	250 mm - 10"
Ø 2.0-3.0mm	tk 52679-00

Schaft	Nadelhalter gerieft mit Sperre
Shaft	<i>Nedleholder serrated with ratchet</i>
Gaine	Porte-aiguilles strié, avec cremaillère
Vaina	<i>Porta-agujas estriado, con cremallera</i>
Asta	Porta-ghi, scanalato, con cremagliera

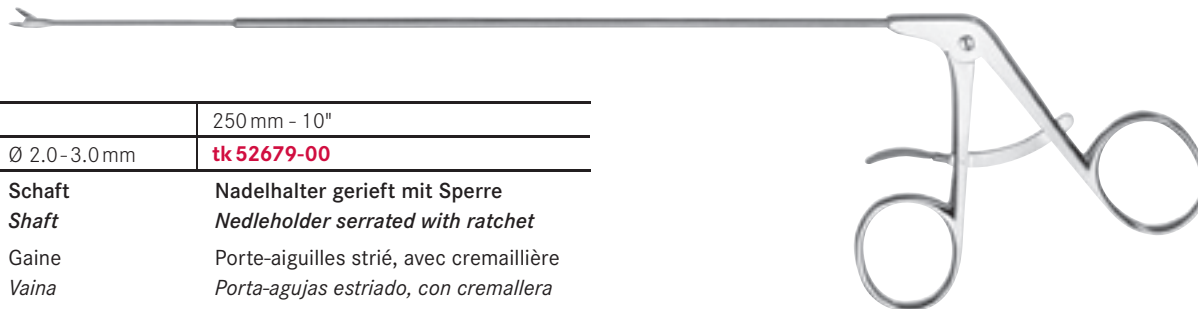

250 mm - 10"

	250 mm - 10"
Ø 2.0-3.0mm	tk 51751-00

Schaft	Stimmbandspreizer mit Sperre
Shaft	<i>Retractor for vocal cords</i>
Gaine	Ecarteur pour cordes vocales
Vaina	<i>Separador para cuerdas vocales</i>
Asta	Divaricatore per cordi vocali

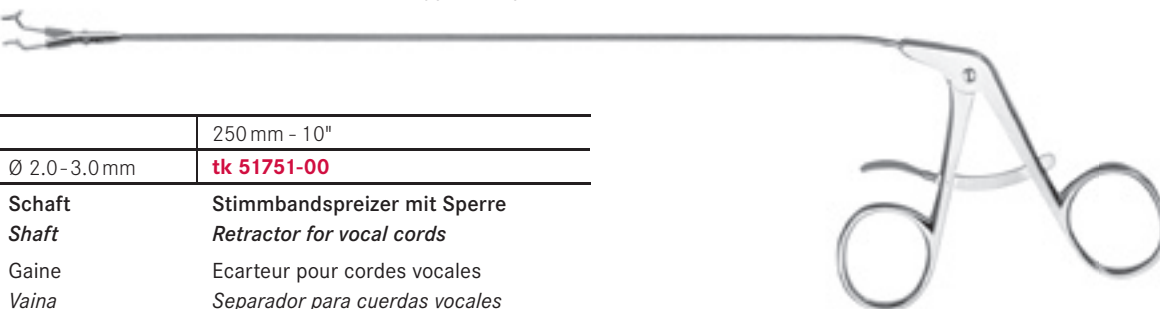

Mikro-Instrumente für Laryngologie
Micro-instruments for laryngology

Micro-instruments pour la laryngologie
Micro-instrumentos para la laringología
Micro-strumenti per laringologia

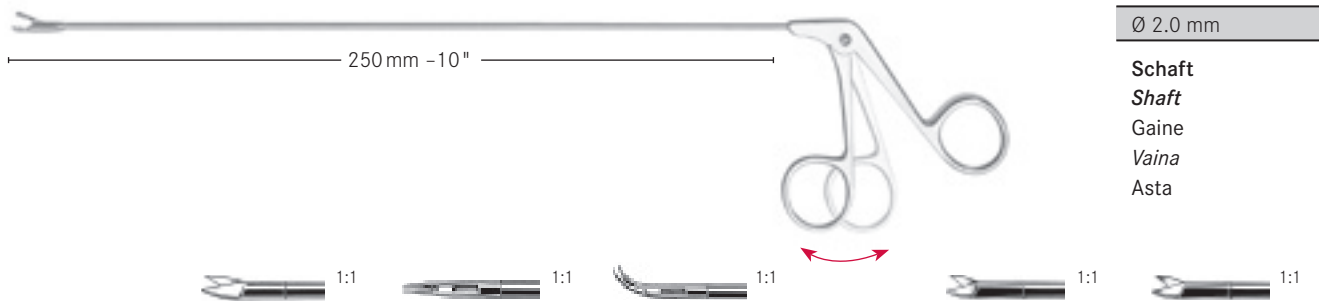

	tk 52673-01	tk 52673-02	tk 52673-04	tk 52673-05	tk 52673-06
Scheren Scissors Ciseaux Tijeras Forbice	gerade <i>straight</i> droit <i>recta</i> retta	gerade horizontal <i>straight horizontal</i> droit horizontal <i>recta horizontal</i> retta orizzontale	aufgebogen horizontal <i>angled up horizontal</i> coudé en haut coupe horizontal <i>curvada arriba horizontal</i> curvata in alto orizzontale	rechts gebogen <i>curved right</i> courbe à droite <i>curvada a derecha</i> curva a destra	links gebogen <i>curved left</i> courbe à gauche <i>curvada a izquierda</i> curva a sinistra



tk 52673-03	tk 52673-07
aufgebogen <i>angled up</i> coudé en haut <i>curvada arriba</i> curvata in alto	15° aufgebogen <i>15° angled up</i> 15° coudé en haut <i>15° curvada arriba</i> 15° curvata in alto



	tk 52674-01	tk 52674-02	tk 52674-04	tk 52674-05	tk 52674-06
Alligatorzangen <i>Alligator forceps</i> Pincés crocodile <i>Pinzas cocodrilo</i> Pinze cocodrillo	gerade <i>straight</i> droit <i>recta</i> retta	gerade horizontal <i>straight horizontal</i> droit horizontal <i>recta horizontal</i> retta orizzontale	aufgebogen horizontal <i>angled up horizontal</i> coudé en haut coupe horizontal <i>curvada arriba horizontal</i> curvata in alto orizzontale	rechts gebogen <i>curved right</i> courbe à droite <i>curvada a derecha</i> curva a destra	links gebogen <i>curved left</i> courbe à gauche <i>curvada a izquierda</i> curva a sinistra





tk 52674-07	tk 52672-01	tk 52672-02	tk 52672-03
aufgebogen <i>angled up</i> coudé en haut <i>hacia arriba</i> curvata in alto	Herzform, gerade <i>heart shape, straight</i> mors ajouré, droite <i>forma corazón, recta</i> forma cuore, retta	Herzform, rechtsgebogen <i>heart shape, curved right</i> mors ajouré, courbe à droite <i>forma corazón, hacia la derecha</i> forma cuore, curva a destra	Herzform, linksgebogen <i>heart shape, curved left</i> mors ajouré, courbe à gauche <i>forma corazón, hacia la izquierda</i> forma cuore, curva a sinistra





tk 52672-04	tk 52672-05	tk 52672-06
Herzform aufgebogen <i>heart shape angled upward</i> mors ajouré coubre vers le haut <i>forma corazón, hacia arriba</i> <i>forma cuore, in alto</i>	Herzform aufgebogen, 45° rechts <i>heart shape angled upward, 45° right</i> mors ajouré coubre vers le haut, 45° à droite <i>forma corazón, 45° hacia la derecha</i> forma cuore, 45° verso destra	Herzform aufgebogen, 45° links <i>heart shape angled upward, 45° left</i> mors ajouré coubre vers le haut, 45° à gauche <i>forma corazón, 45° hacia la izquierda</i> forma cuore, 45° verso sinistra

Mikro-Instrumente für Laryngologie | Micro-instruments pour la laryngologie
Micro-instrumentos para la laringología
 Micro-strumenti per laringologia

	 1:1	 1:1	 1:1	 1:1	 1:1
○ 2.5 mm	tk 52675-01	tk 52675-02	tk 52675-03	tk 52675-04	tk 52675-05
Löffelzangen <i>Cup shaped forc.</i>	gerade <i>straight</i>	aufgebogen <i>angled up</i>	aufgebogen horizontal <i>angled up horizontal</i>	rechts gebogen <i>curved right</i>	links gebogen <i>curved left</i>
Pinces curettes <i>Pinzas cureta</i> Pinze a cucchaio	droit <i>recta</i> retta	coudé en haut <i>curvada arriba</i> curvata in alto	coudé en haut coupe horizontal <i>curvada arriba horizontal</i> curvata in alto orizzontale	courbe à droite <i>curvada a derecha</i> curva a destra	courbe à gauche <i>curvada a izquierda</i> curva a sinistra

 1:1	 1:1
tk 52675-07	tk 52675-08
aufgebogen, 45° rechts <i>angled upward, 45° right</i> courbe vers le haut, 45° à droite curva hacia arriba, 45° a la derecha <i>curvata in alto, 45° a destra</i>	aufgebogen, 45° links <i>angled upward, 45° left</i> courbe vers le haut, 45° à gauche curva hacia arriba, 45° a la izquierda <i>curvata in alto, 45° a sinistra</i>

	 1:1	 1:1	 1:1	 1:1
○ 2.5 x 4 mm	tk 52675-06	tk 52675-09	tk 52675-10	tk 52675-11
Löffelzangen <i>Cup shaped forc.</i>	gerade <i>straight</i>	aufgebogen 45° <i>angled upward 45°</i>	rechts gebogen <i>curved right</i>	links gebogen <i>curved left</i>
Pinces curettes <i>Pinzas cureta</i> Pinze a cucchaio	droit <i>recta</i> retta	coudé en haut <i>curvada arriba</i> curvata in alto	courbe à droite <i>curvada a derecha</i> curva a destra	courbe à gauche <i>curvada a izquierda</i> curva a sinistra

 1:1	 1:1	 1:1
tk 52675-12	tk 52675-13	tk 52675-14
spitz, aufgebogen 45° <i>pointed, angled upward 45°</i> pointu, courbe 45° vers le haut <i>aguda, curvada 45° hacia arriba</i> <i>acuta, curvata 45° in alto</i>	spitz, aufgebogen, rechts öffnend <i>pointed, angled upward, opened to right</i> pointu, courbe vers le haut, ouvrant à droite <i>aguda, curvada, abertura derecha</i> <i>acuta, curvata apertura destra</i>	spitz, aufgebogen, links öffnend <i>pointed, angled upward, opened to left</i> pointu, courbe vers le haut, ouvrant à gauche <i>aguda, curvada, abertura izquierda</i> <i>acuta, curvata, apertura sinistra</i>



tk 52675-90

Ansteckbare Saugkanüle
Attachable suction cannula
 Attachable canule d'aspiration
Cánula de aspiración fijable
 Cannula per aspirazione

Mikro-Instrumente für Laryngologie
Micro-instruments for laryngology

Micro-instruments pour la laryngologie
Micro-instrumentos para la laringología
Micro-strumenti per laringologia

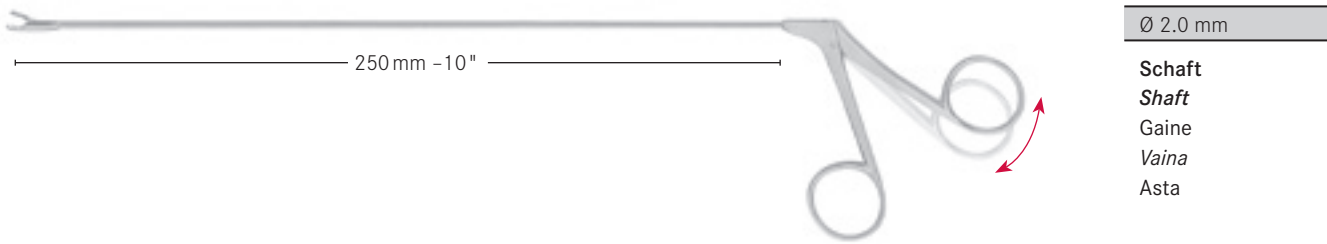

Ø 2.0 mm

Schaft
Shaft
Gaine
Vaina
Asta

 1:1	 1:1	 1:1	 1:1	 1:1
tk 52676-01	tk 52676-02	tk 52676-04	tk 52676-05	tk 52676-06

Scheren Scissors Ciseaux Tijeras Forbice	gerade <i>straight</i> droit <i>recta</i> retta	gerade horizontal <i>straight horizontal</i> droit horizontal <i>recta horizontal</i> retta orizzontale	aufgebogen horizontal <i>angled up horizontal</i> coudé en haut coupe horizontal <i>curvada arriba horizontal</i> curvata in alto orizzontale	rechts gebogen <i>curved right</i> courbe à droite <i>curvada a derecha</i> curva a destra	links gebogen <i>curved left</i> courbe à gauche <i>curvada a izquierda</i> curva a sinistra
--	---	---	---	--	--

 1:1	 1:1	 1:1	 1:1
tk 52676-03	tk 52676-07	tk 52676-08	tk 52676-09

aufgebogen <i>angled up</i> coudé en haut <i>curvada arriba</i> curvata in alto	15° aufgebogen <i>15° curved upward</i> 15° vers le haut <i>15° curva hacia arriba</i> 15° curvata in alto	spitz, aufgebogen <i>pointed, curved upward</i> pointu, courbe vers le haut <i>aguda, curvada hacia arriba</i> acuta, curvata in alto	stumpf, aufgebogen <i>blunt, curved upward</i> obtus, courbe vers le haut <i>romo, curvada hacia arriba</i> smussa, curvata in alto
---	--	---	---

 1:1	 1:1	 1:1	 1:1	 1:1
tk 52677-01	tk 52677-02	tk 52677-04	tk 52677-05	tk 52677-06

Alligatorzangen <i>Alligator forceps</i> Pinces crocodile <i>Pinzas cocodrilo</i> Pinze coccodrillo	gerade <i>straight</i> droit <i>recta</i> retta	gerade horizontal <i>straight horizontal</i> droit horizontal <i>recta horizontal</i> retta orizzontale	aufgebogen horizontal <i>angled up horizontal</i> coudé en haut coupe horizontal <i>curvada arriba horizontal</i> curvata in alto orizzontale	rechts gebogen <i>curved right</i> courbe à droite <i>curvada a derecha</i> curva a destra	links gebogen <i>curved left</i> courbe à gauche <i>curvada a izquierda</i> curva a sinistra
---	---	---	---	--	--



 1:1	 1:1	 1:1	 1:1
tk 52677-07	tk 52672-07	tk 52672-08	tk 52672-09



aufgebogen <i>angled up</i> coudé en haut <i>hacia arriba</i> curvata in alto	Herzform, gerade <i>heart shape, straight</i> mors ajouré, droite <i>forma corazón, recta</i> forma cuore, retta	Herzform, rechtsgebogen <i>heart shape, curved right</i> mors ajouré, courbe à droite <i>forma corazón, hacia la derecha</i> forma cuore, curva a destra	Herzform, linksgebogen <i>heart shape, curved left</i> mors ajouré, courbe à gauche <i>forma corazón, hacia la izquierda</i> forma cuore, curva a sinistra
---	--	--	--



 1:1	 1:1	 1:1
tk 52672-10	tk 52672-11	tk 52672-12



Herzform aufgebogen <i>heart shape angled upward</i> mors ajouré coudre vers le haut <i>forma corazón, hacia arriba</i> <i>forma cuore, in alto</i>	Herzform aufgebogen, 45° rechts <i>heart shape angled upward, 45° right</i> mors ajouré coudre vers le haut, 45° à droite <i>forma corazón, 45° hacia la derecha</i> <i>forma cuore, 45° verso destra</i>	Herzform aufgebogen, 45° links <i>heart shape angled upward, 45° left</i> mors ajouré coudre vers le haut, 45° à gauche <i>forma corazón, 45° hacia la izquierda</i> <i>forma cuore, 45° verso sinistra</i>
---	---	---

Mikro-Instrumente für Laryngologie | Micro-instruments pour la laryngologie
 Micro-instrumentos para la laringología
 Micro-strumenti per laringologia

	 1:1	 1:1	 1:1	 1:1	 1:1
○ 2.5 mm	tk 52678-01	tk 52678-02	tk 52678-03	tk 52678-04	tk 52678-05
Löffelzangen <i>Cup shaped forc.</i>	gerade <i>straight</i>	aufgebogen <i>angled up</i>	aufgebogen horizontal <i>angled up horizontal</i>	rechts gebogen <i>curved right</i>	links gebogen <i>curved left</i>
Pinces curettes <i>Pinzas cureta</i> Pinze a cucchaio	droit <i>recta</i> <i>retta</i>	coudé en haut <i>curvada arriba</i> <i>curvata in alto</i>	coudé en haut coupe horizontal <i>curvada arriba horizontal</i> <i>curvata in alto orizzontale</i>	courbe à droite <i>curvada a derecha</i> <i>curva a destra</i>	courbe à gauche <i>curvada a izquierda</i> <i>curva a sinistra</i>

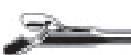
 1:1	 1:1	 1:1
tk 52678-07	tk 52678-08	○ 2.5 x 5 mm tk 52678-15
aufgebogen, 45° rechts <i>angled upward, 45° right</i> courbe vers le haut, 45° à droite curva hacia arriba, 45° a la derecha <i>curvata in alto, 45° a destra</i>	aufgebogen, 45° links <i>angled upward, 45° left</i> courbe vers le haut, 45° à gauche curva hacia arriba, 45° a la izquierda <i>curvata in alto, 45° a sinistra</i>	Löffelzange <i>Cup shaped forc.</i> mit Fenster aufgebogen <i>with window curved upward</i> Pince curette <i>Pinza cureta</i> Pinza a cucchaio avec fenêtre courbe vers le haut <i>con vertana, curvada hacia arriba</i> con finestra, curvata in alto

 1:1	 1:1	 1:1	 1:1	
○ 2.5 x 4 mm tk 52678-06	tk 52678-09	tk 52678-10	tk 52678-11	
Löffelzangen <i>Cup shaped forc.</i>	gerade <i>straight</i>	aufgebogen 45° <i>angled upward 45°</i>	rechts gebogen <i>curved right</i>	links gebogen <i>curved left</i>
Pinces curettes <i>Pinzas cureta</i> Pinze a cucchaio	droit <i>recta</i> <i>retta</i>	coudé en haut <i>curvada arriba</i> <i>curvata in alto</i>	courbe à droite <i>curvada a derecha</i> <i>curva a destra</i>	courbe à gauche <i>curvada a izquierda</i> <i>curva a sinistra</i>

 1:1	 1:1	 1:1
tk 52678-12	tk 52678-13	tk 52678-14
spitz, aufgebogen 45° <i>pointed, angled upward 45°</i> pointu, courbe 45° vers le haut <i>aguda, curvada 45° hacia arriba</i> <i>acuta, curvata 45° in alto</i>	spitz, aufgebogen, rechts öffnend <i>pointed, angled upward, opened to right</i> pointu, courbe vers le haut, ouvrant à droite <i>aguda, curvada, abertura derecha</i> <i>acuta, curvata apertura destra</i>	spitz, aufgebogen, links öffnend <i>pointed, angled upward, opened to left</i> pointu, courbe vers le haut, ouvrant à gauche <i>aguda, curvada, abertura izquierda</i> <i>acuta, curvata, apertura sinistra</i>



tk 52678-90
 Ansteckbare Saugkanüle
Attachable suction cannula
 Attachable canule d'aspiration
Cánula de aspiración fijable
 Cannula per aspirazione

Mikro-Instrumente für Laryngologie
Micro-instruments for laryngology

Micro-instruments pour la laryngologie
Micro-instrumentos para la laringología
Micro-strumenti per laringologia

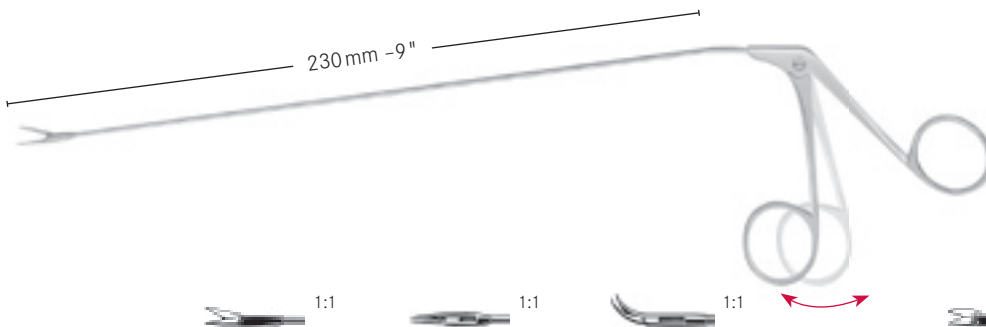

Ø 1.0-2.0 mm

Konischer Schaft
Conical shaft
Tige conique
Tija conica
Camicia conica

	1:1	1:1	1:1	1:1	1:1
	tk 52681-01	tk 52681-02	tk 52681-03	tk 52681-04	tk 52681-05
Scheren Scissors Ciseaux Tijeras Forbice	gerade <i>straight</i> droit <i>recta</i> retta	gerade horizontal <i>straight horizontal</i> droit horizontal <i>recta horizontal</i> retta orizzontale	aufgebogen horizontal <i>angled up horizontal</i> coudé en haut coupe horizontal <i>curvada arriba horizontal</i> curvata in alto orizzontale	rechts gebogen <i>curved right</i> courbe à droite <i>curvada a derecha</i> curva a destra	links gebogen <i>curved left</i> courbe à gauche <i>curvada a izquierda</i> curva a sinistra



tk 52681-06

aufgebogen
angled up
coudé en haut
curvada arriba
curvata in alto

	1:1	1:1	1:1	1:1
	tk 52683-01	tk 52683-02	tk 52683-03	tk 52683-04
Greifzangen <i>Grasping forceps</i> Pincès à mors <i>Pinzas</i> Pinze	gerade, gerieft <i>straight, serrated</i> droit, strié <i>recta, estriada</i> retta, zigrinata	aufgebogen, gerieft <i>angled upward, serrated</i> courbe vers le haut, strié <i>curvada hacia arriba, estriada</i> curvata in alto, zigrinata	rechts gebogen, gerieft <i>curved right, serrated</i> courbe à droite, strié <i>curvada a derecha, estriada</i> curva a destra, zigrinata	links gebogen, gerieft <i>curved left, serrated</i> courbe à gauche, strié <i>curvada a izquierda, estriada</i> curva a sinistra, zigrinata



	1:1	1:1	1:1	1:1
	tk 52683-05	tk 52683-06	tk 52683-07	tk 52683-08
Alligatorzangen <i>Alligator forceps</i> Pincès crocodile <i>Pinzas cocodrilo</i> Pinze cocodrillo	gerade <i>straight</i> droit <i>recta</i> retta	aufgebogen <i>angled upward</i> courbe vers le haut <i>curvada hacia arriba</i> curvata in alto	rechtsgebogen <i>curved right</i> courbe à droite <i>curvada a derecha</i> curva a destra	linksgebogen <i>curved left</i> courbe à gauche <i>curvada a izquierda</i> curva a sinistra



tk 52683-09





Herzform aufgebogen, 45° rechts
heart shape angled upward, 45° right
mors ajouré coubre vers le haut, 45° à droit
forma corazón , 45° hacia la derecha
forma cuore, 45° verso destra









tk 52683-10

Herzform aufgebogen, 45° links
heart shape angled upward, 45° left
mors ajouré coubre vers le haut, 45° à gauche
forma corazón , 45° hacia la izquierda
forma cuore, 45° verso sinistra

Mikro-Instrumente für Laryngologie | Micro-instruments pour la laryngologie
Micro-instrumentos para la laringología
 Micro-strumenti per laringologia

	 1:1	 1:1	 1:1	 1:1
○ 1.0mm	tk 52685-01	tk 52685-02	tk 52685-03	tk 52685-04
Löffelzangen <i>Cup shaped forc.</i>	gerade <i>straight</i>	aufgebogen <i>angled up</i>	rechts gebogen <i>curved right</i>	links gebogen <i>curved left</i>
Pincés curettes <i>Pinzas cureta</i>	droit <i>recta</i>	coudé en haut <i>curvada arriba</i>	courbe à droite <i>curvada a derecha</i>	courbe à gauche <i>curvada a izquierda</i>
Pinze a cucchaio	retta	curvata in alto	curva a destra	curva a sinistra

 1:1	 1:1
tk 52685-05	tk 52685-06
aufgebogen, 45° rechts <i>angled upward, 45° right</i> courbe vers le haut, 45° à droite <i>curvada hacia arriba, 45° a la derecha</i> <i>curvata in alto, 45° a destra</i>	aufgebogen, 45° links <i>angled upward, 45° left</i> courbe vers le haut, 45° à gauche <i>curvada hacia arriba, 45° a la izquierda</i> <i>curvata in alto, 45° a sinistra</i>

	 1:1	 1:1	 1:1	 1:1
○ 1.0mm	tk 52685-07	tk 52685-08	tk 52685-09	tk 52685-10
Löffelzangen <i>Cup shaped forc.</i>	gerade <i>straight</i>	aufgebogen 45° <i>angled upward 45°</i>	rechts gebogen <i>curved right</i>	links gebogen <i>curved left</i>
Pincés curettes <i>Pinzas cureta</i>	droit <i>recta</i>	coudé en haut <i>curvada arriba</i>	courbe à droite <i>curvada a derecha</i>	courbe à gauche <i>curvada a izquierda</i>
Pinze a cucchaio	retta	curvata in alto	curva a destra	curva a sinistra



tk 52685-90
 Ansteckbare Saugkanüle
Attachable suction cannula
 Attachable canule d'aspiration
Cánula de aspiración fijable
 Cannula per aspirazione





Mikro-Instrumente für Laryngologie
Micro-instruments for laryngology

Micro-instruments pour la laryngologie
Micro-instrumentos para la laringología
Micro-strumenti per laringologia



Ø 1.0-2.0 mm





Konischer Schaft
Conical shaft
Tige conique
Tija conica
Camicia conica





	 1:1	 1:1	 1:1	 1:1	 1:1
	tk 52687-01	tk 52687-02	tk 52687-03	tk 52687-04	tk 52687-05
Scheren	gerade	gerade horizontal	aufgebogen horizontal	rechts gebogen	links gebogen
Scissors	straight	straight horizontal	angled up horizontal	curved right	curved left
Ciseaux	droit	droit horizontal	coudé en haut coupe horizontal	courbe à droite	courbe à gauche
Tijeras	recta	recta horizontal	curvada arriba horizontal	curvada a derecha	curvada a izquierda
Forbice	retta	retta orizzontale	curvata in alto orizzontale	curva a destra	curva a sinistra



tk 52687-06

aufgebogen
angled up
coudé en haut
curvada arriba
curvata in alto

	 1:1	 1:1	 1:1	 1:1
	tk 52688-01	tk 52688-02	tk 52688-03	tk 52688-04
Greifzangen	gerade, gerieft	aufgebogen, gerieft	rechts gebogen, gerieft	links gebogen, gerieft
Grasping forceps	straight, serrated	angled upward, serrated	curved right, serrated	curved left, serrated
Pinces à mors	droit, strié	courbe vers le haut, strié	courbe à droite, strié	courbe à gauche, strié
Pinzas	recta, estriada	curvada hacia arriba, estriada	curvada a derecha, estriada	curvada a izquierda, estriada
Pinze	retta, zigrinata	curvata in alto, zigrinata	curva a destra, zigrinata	curva a sinistra, zigrinata

	 1:1	 1:1	 1:1	 1:1
	tk 52688-05	tk 52688-06	tk 52688-07	tk 52688-08

Alligatorzangen	gerade	aufgebogen	rechtsgebogen	linksgebogen
Alligator forceps	straight	angled upward	curved right	curved left
Pinces crocodile	droit	courbe vers le haut	courbe à droite	courbe à gauche
Pinzas cocodrilo	recta	curvada hacia arriba	curvada a derecha	curvada a izquierda
Pinze coccodrillo	retta	curvata in alto	curva a destra	curva a sinistra



tk 52688-09

Herzform aufgebogen, 45° rechts
heart shape angled upward, 45° right
forme de coeur coubre vers le haut, 45° à droit
forma corazón, 45° hacia la derecha
forma cuore, 45° verso destra



tk 52688-10

Herzform aufgebogen, 45° links
heart shape angled upward, 45° left
forme de coeur coubre vers le haut, 45° à gauche
forma corazón, 45° hacia la izquierda
forma cuore, 45° verso sinistra





tk 52688-11

ø 1.5 mm Hechtmaul, doppelbeweglich
ø 1.5 mm Alligator, double action jaws
ø 1.5 mm Stries, mouvement double
ø 1.5 mm, cocodrilo, doble acción
ø 1.5 mm, coccodrillo, doppia azione

Mikro-Instrumente für Laryngologie
Micro-instruments for laryngology

Micro-instruments pour la laryngologie
Micro-instrumentos para la laringología
 Micro-strumenti per laringologia

	 1:1	 1:1	 1:1	 1:1
○ 1.0 mm	tk 52689-01	tk 52689-02	tk 52689-03	tk 52689-04
Löffelzangen <i>Cup shaped forc.</i>	gerade <i>straight</i>	aufgebogen <i>angled up</i>	rechts gebogen <i>curved right</i>	links gebogen <i>curved left</i>
Pinces cures <i>Pinzas cureta</i>	droit <i>recta</i>	coudé en haut <i>curvada arriba</i>	courbe à droite <i>curvada a derecha</i>	courbe à gauche <i>curvada a izquierda</i>
Pinze a cucchaio	retta	curvata in alto	curva a destra	curva a sinistra

 1:1	 1:1
tk 52689-05	tk 52689-06
aufgebogen, 45° rechts <i>angled upward, 45° right</i> courbe vers le haut, 45° à droite <i>curvada hacia arriba, 45° a la derecha</i> <i>curvata in alto, 45° a destra</i>	aufgebogen, 45° links <i>angled upward, 45° left</i> courbe vers le haut, 45° à gauche <i>curvada hacia arriba, 45° a la izquierda</i> <i>curvata in alto, 45° a sinistra</i>

	 1:1	 1:1	 1:1	 1:1
○ 1.0 mm	tk 52689-07	tk 52689-08	tk 52689-09	tk 52689-10
Löffelzangen <i>Cup shaped forc.</i>	gerade <i>straight</i>	aufgebogen 45° <i>angled upward 45°</i>	rechts gebogen <i>curved right</i>	links gebogen <i>curved left</i>
Pinces cures <i>Pinzas cureta</i>	droit <i>recta</i>	coudé en haut <i>curvada arriba</i>	courbe à droite <i>curvada a derecha</i>	courbe à gauche <i>curvada a izquierda</i>
Pinze a cucchaio	retta	curvata in alto	curva a destra	curva a sinistra



tk 52689-90
 Ansteckbare Saugkanüle
Attachable suction cannula
 Attachable canule d'aspiration
Cánula de aspiración fijable
 Cannula per aspirazione

Kehlkopfspiegel
Laryngeal mirrors

Miroirs laryngiens
Espejos laringeos
Specchi laringei

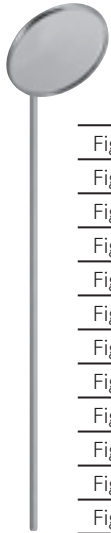
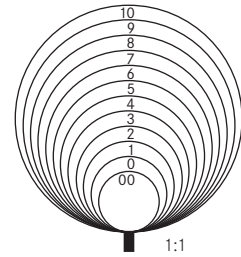

Fig. 00	8 mm Ø	tk 53515-08
Fig. 0	10 mm Ø	tk 53515-10
Fig. 1	12 mm Ø	tk 53515-12
Fig. 2	14 mm Ø	tk 53515-14
Fig. 3	16 mm Ø	tk 53515-16
Fig. 4	18 mm Ø	tk 53515-18
Fig. 5	20 mm Ø	tk 53515-20
Fig. 6	22 mm Ø	tk 53515-22
Fig. 7	24 mm Ø	tk 53515-24
Fig. 8	26 mm Ø	tk 53515-26
Fig. 9	28 mm Ø	tk 53515-28
Fig. 10	30 mm Ø	tk 53515-30



1:2

100 mm - 4"
tk 53504-10

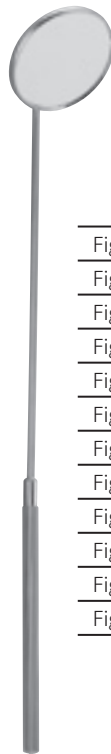
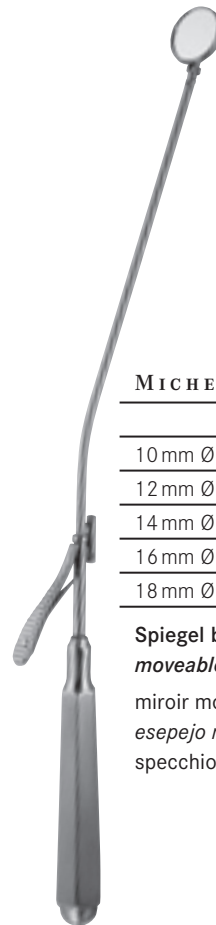

Fig. 00	8 mm Ø	tk 53525-08
Fig. 0	10 mm Ø	tk 53525-10
Fig. 1	12 mm Ø	tk 53525-12
Fig. 2	14 mm Ø	tk 53525-14
Fig. 3	16 mm Ø	tk 53525-16
Fig. 4	18 mm Ø	tk 53525-18
Fig. 5	20 mm Ø	tk 53525-20
Fig. 6	22 mm Ø	tk 53525-22
Fig. 7	24 mm Ø	tk 53525-24
Fig. 8	26 mm Ø	tk 53525-26
Fig. 9	28 mm Ø	tk 53525-28
Fig. 10	30 mm Ø	tk 53525-30



MICHEL

	250 mm - 9¾"
10 mm Ø	tk 53541-10
12 mm Ø	tk 53541-12
14 mm Ø	tk 53541-14
16 mm Ø	tk 53541-16
18 mm Ø	tk 53541-18

Spiegel beweglich
moveable mirror
miroir mobile
espejo movable
specchio mobile

Kehlkopfinstrumente
Laryngeal instruments

Instruments laryngiens
Instrumentos laringeos
Strumenti laringei



REICHERT

230 mm - 9"

tk 52598-24

1:2

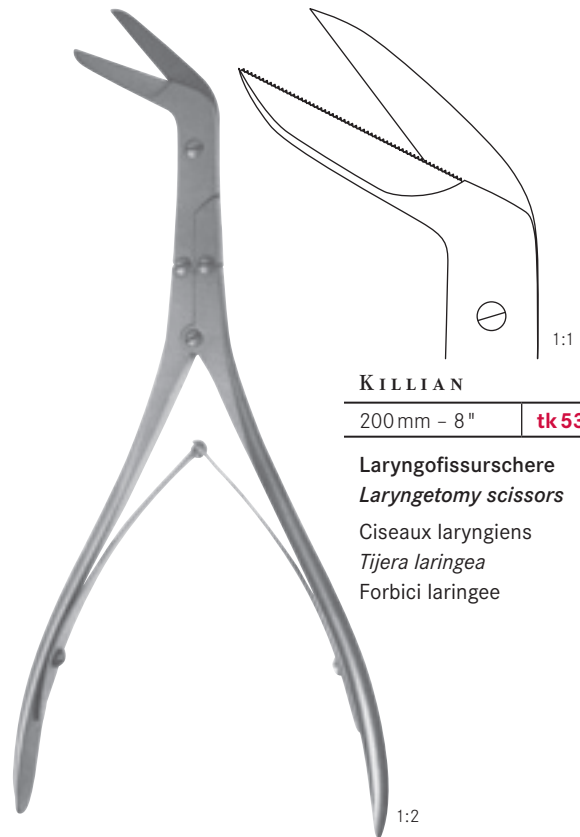

KILLIAN

200 mm - 8"

tk 53550-20

Laryngofissurschere
Laryngotomy scissors

Ciseaux laryngiens

Tijera laringea

Forbici laringee

1:2

Kehlkopfpolypenzangen
Laryngeal polypus forceps

Pinces à polypes laryngiens
Pinzas para pólipos laringeos
Pinze per polipi laringei

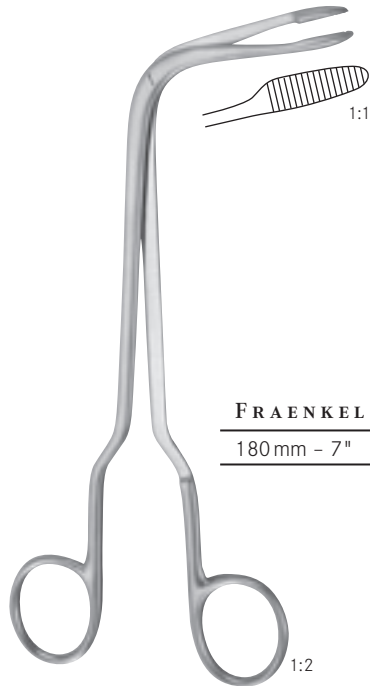

FRAENKEL

180 mm – 7"

tk 53561-18

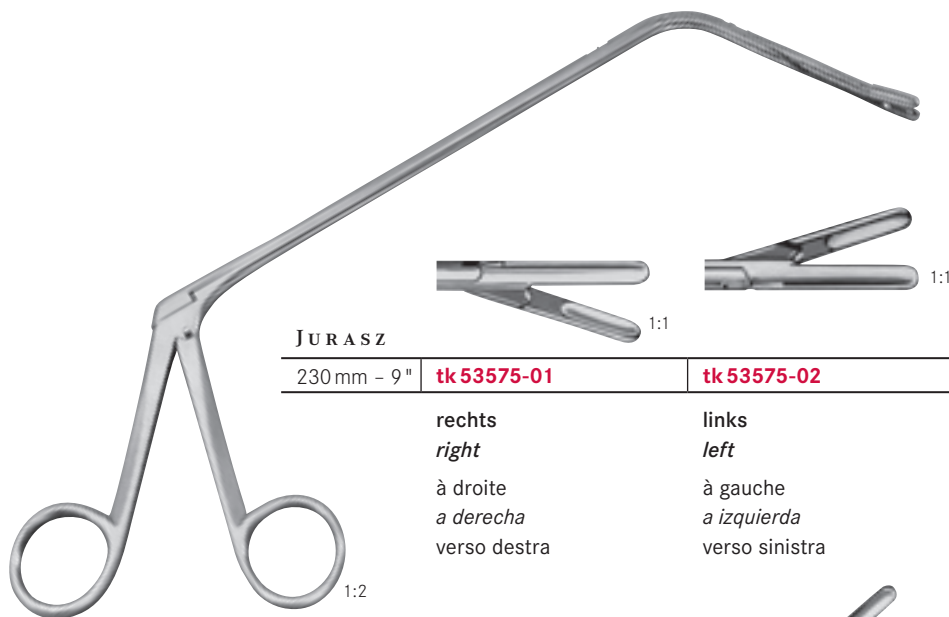

JURASZ

230 mm – 9"

tk 53575-01

tk 53575-02

rechts

right

à droite

a derecha

verso destra

links

left

à gauche

a izquierda

verso sinistra



tk 53575-03

nach unten
downwards

vers le bas
hacia abajo

verso basso



tk 53575-04

nach oben
upwards

vers le haut
hacia arriba

verso alto

Kehlkopfpolypenzangen
Laryngeal polypus forceps

Pinces à polypes laryngiens
Pinzas para pólipos laringeos
Pinze per polipi laringei

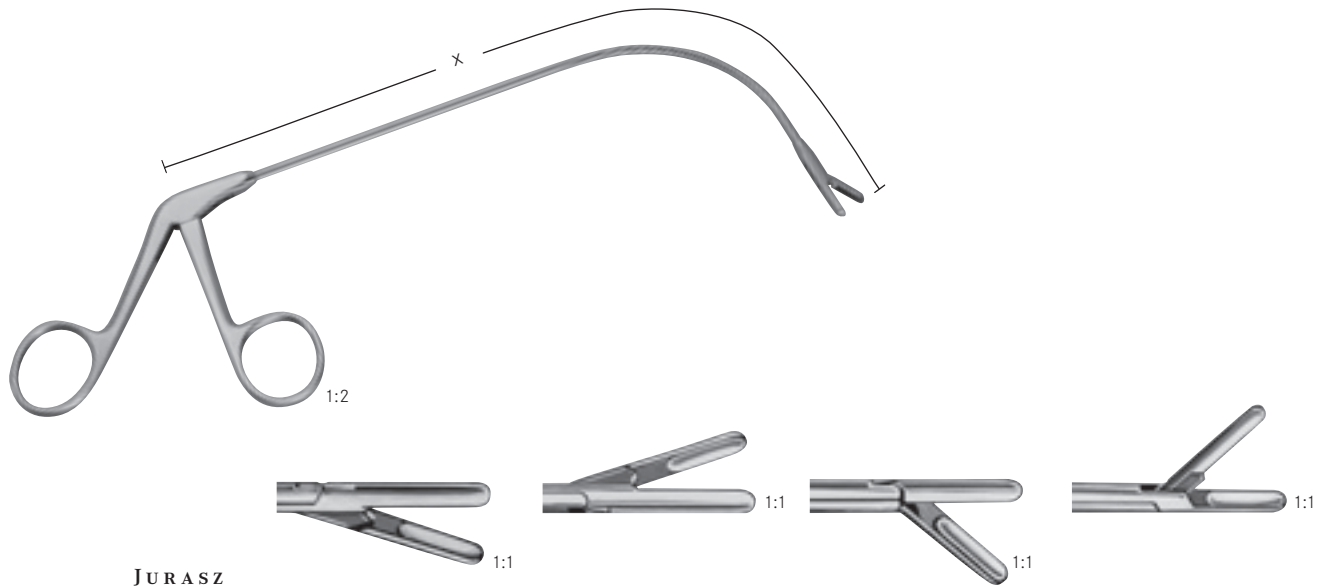

JURASZ

230 mm - 9"	tk 53580-01	tk 53580-02	tk 53580-03	tk 53580-04
rechts <i>right</i> à droite <i>a derecha</i> verso destra	links <i>left</i> à gauche <i>a izquierda</i> verso sinistra	nach unten <i>downwards</i> vers le bas <i>hacia abajo</i> verso basso	nach oben <i>upwards</i> vers le haut <i>hacia arriba</i> verso alto	

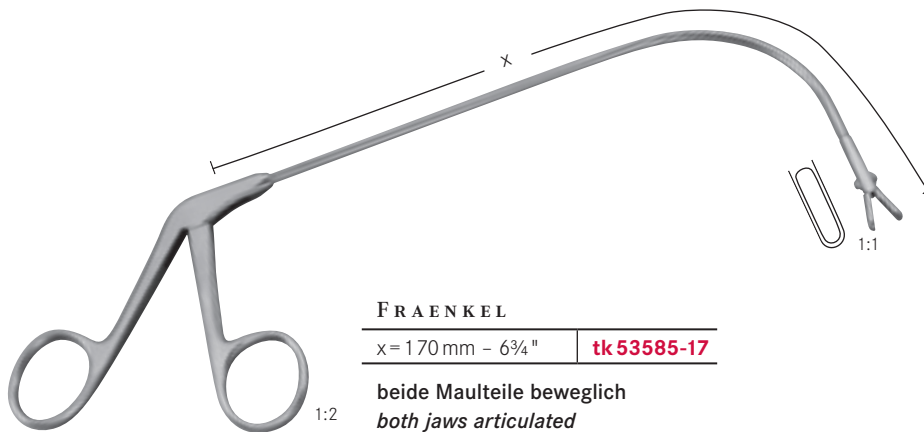

FRAENKEL

x = 170 mm - 6¾" **tk 53585-17**

beide Maulteile beweglich
both jaws articulated
les deux mâchoires mobiles
las dos mandíbulas móviles
ambedue i morsi mobili

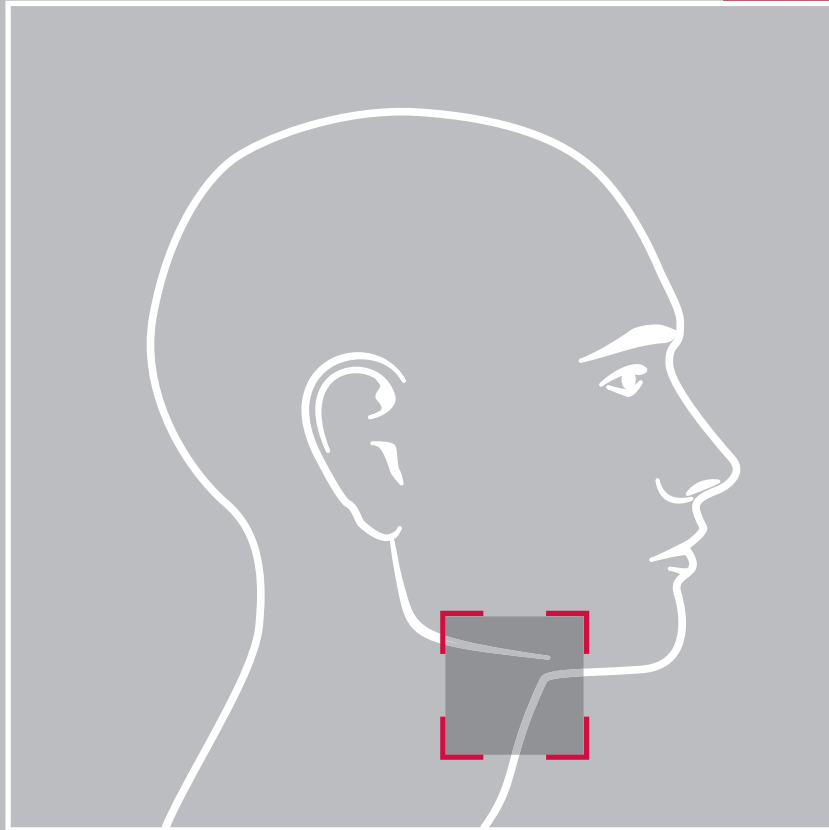

Tracheotomie | Trachéotomie
Tracheotomy | *Traqueotomía*
Tracheotomia



Trachealdilatatoren
Trachea dilators

Dilatateurs pour la trachéotomie
Dilatadores para la tráqueotomía
Dilatatori tracheali



LABORDE

120 mm - 5"	tk 29950-12	
140 mm - 5½"		tk 29950-14

für Kinder
for children
pour enfants
para niños
per bambini

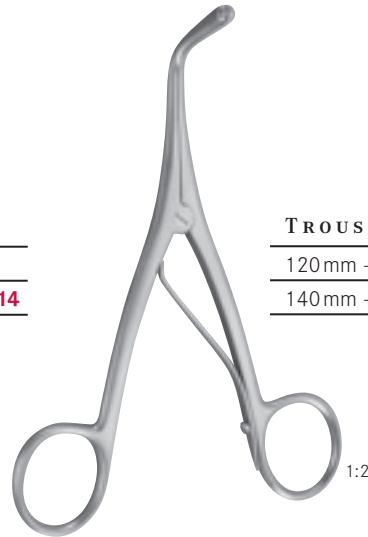

TROUSSEAU

120 mm - 5"	tk 29952-12	
140 mm - 5½"		tk 29952-14

für Kinder
for children
pour enfants
para niños
per bambini

Trachealhäkchen
Trachea retractors

Ecarteurs tracheales
Separadores traqueales
Uncini tracheali



JACKSON

170 mm - 6⅔"	
tk 16935-17	

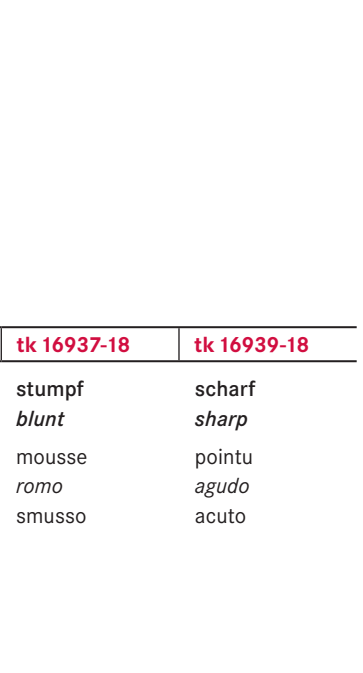

JACKSON

180 mm - 7"	tk 16937-18	tk 16939-18
-------------	--------------------	--------------------

stumpf <i>blunt</i>	scharf <i>sharp</i>
mousse <i>romo</i>	pointu <i>agudo</i>
smusso	acuto

Trachealkanülen
Trachea tubes

Canules pour la trachéotomie
Cánulas para la tráquea
Cannule tracheali



LUER STANDARD

Fig. 0	4 mm Ø	tk 29960-00
Fig. 1	5 mm Ø	tk 29960-01
Fig. 2	6 mm Ø	tk 29960-02
Fig. 3	7 mm Ø	tk 29960-03
Fig. 4	8 mm Ø	tk 29960-04
Fig. 5	9 mm Ø	tk 29960-05
Fig. 6	10 mm Ø	tk 29960-06
Fig. 7	11 mm Ø	tk 29960-07
Fig. 8	12 mm Ø	tk 29960-08
Fig. 9	13 mm Ø	tk 29960-09

Neusilber
German silver
Maillechort
Plata alemana
Argentone

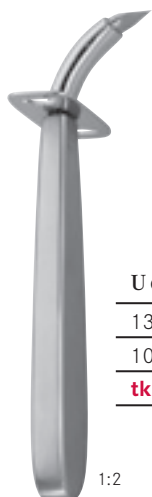

1:2

UCKERMANN

130 mm - 5"

10 mm Ø

tk 6163-13

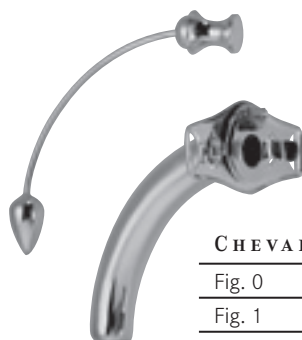

CHEVALIER-JACKSON

Fig. 0	4 mm Ø	tk 29990-00
Fig. 1	5 mm Ø	tk 29990-01
Fig. 2	6 mm Ø	tk 29990-02
Fig. 3	7 mm Ø	tk 29990-03
Fig. 4	8 mm Ø	tk 29990-04
Fig. 5	9 mm Ø	tk 29990-05
Fig. 6	10 mm Ø	tk 29990-06
Fig. 7	11 mm Ø	tk 29990-07
Fig. 8	12 mm Ø	tk 29990-08
Fig. 9	13 mm Ø	tk 29990-09

Neusilber
German silver
Maillechort
Plata alemana
Argentone

**Tracheotomiebesteck
Tracheotomy set**
**Trousse pour la trachéotomie
Estuche para la traqueotomía
Astuccio per tracheotomia**

200 mm x 105 mm x 30 mm

tk 29997-00

Tracheotomiebesteck, in Metall-Etui, bestehend aus:

- 1 Griff, tk 7100-04/1 Klinge, Fig. 20, tk 7210-20 T
- 1 Griff, tk 7100-04/1 Klinge, Fig. 23, tk 7210-23 T
- 1 anatomische Pinzette, 130 mm, tk 10000-13
- 2 chirurgische Pinzetten, 1 x 2 Zähne, 130 mm, tk 11000-13
- 2 Rochester-Péan Klemmen, 130 mm, tk 12059-13
- 1 Hohlsonde, 130 mm, tk 18110-13
- 1 Bose Trachealdilatator, tk 17395-07
- 2 Iterson Trachealhäkchen, stumpf, tk 16922-16
- 1 Bose Trachealhäkchen, 160 mm, scharf, rechts, tk 16956-16
- 1 Bose Trachealhäkchen, 160 mm, scharf, links, tk 16957-16
- 1 Luer Trachealkanüle, Standard, 7 mm Ø, Neusilber, tk 29960-03
- 1 Luer Trachealkanüle, Standard, 8 mm Ø, Neusilber, tk 29960-04
- 1 Reinigungsbürste, tk 29999-26

Tracheotomy set, in metal case, consisting of:

- 1 Handle, tk 7100-04/1 blade, Fig. 20, tk 7210-20 T
- 1 Handle, tk 7100-04/1 blade, Fig. 23, tk 7210-23 T
- 1 Dressing forceps, 130 mm, tk 10000-13
- 2 Tissue forceps, 1 x 2 teeth, 130 mm, tk 11000-13
- 2 Rochester-Péan hemostatic forceps, 130 mm, tk 12059-13
- 1 Grooved director, 130 mm, tk 18110-13
- 1 Bose trachea dilator, tk 17395-07
- 2 Iterson trachea retractors, blunt, tk 16922-16
- 1 Bose trachea retractor, 160 mm, sharp, right, tk 16956-16
- 1 Bose trachea retractor, 160 mm, sharp, left, tk 16957-16
- 1 Luer trachea tube, standard, 7 mm Ø, german silver, tk 29960-03
- 1 Luer trachea tube, Standard, 8 mm Ø, german silver, tk 29960-04
- 1 Cleaning brush, tk 29999-26

Trousse pour la trachéotomie, en étui de métal, se composant de:

- 1 Manche, tk 7100-04/1 lame, Fig. 20, tk 7210-20 T
- 1 Manche, tk 7100-04/1 lame, Fig. 23, tk 7210-23 T
- 1 Pince à disséquer, 130 mm, tk 10000-13
- 2 Pinces à griffes, 1 x 2 griffes, 130 mm, tk 11000-13
- 2 Pinces hémostatiques de Rochester-Péan, 130 mm, tk 12059-13
- 1 Sonde cannelée, 130 mm, tk 18110-13
- 1 Dilatateur trachéal de Bose, tk 17395-07
- 2 Crochets trachéaux de Iterson, mousses, tk 16922-16
- 1 Crochet trachéal de Bose, 160 mm, pointu, à droite, tk 16956-16
- 1 Crochet trachéal de Bose, 160 mm, pointu, à gauche, tk 16957-16
- 1 Canule trachéale de Luer, modèle standard, 7 mm Ø, en maillechort, tk 29960-03
- 1 Canule trachéale de Luer, modèle standard, 8 mm Ø, en maillechort, tk 29960-04
- 1 Ecouvillon, tk 29999-26

Estuche para la traqueotomía, en estuche de metal, compuesto de:

- 1 Mango, tk 7100-04/1 hoja, Fig. 20, tk 7210-20 T
- 1 Mango, tk 7100-04/1 hoja, Fig. 23, tk 7210-23 T
- 1 Pinza de disección, 130 mm, tk 10000-13
- 2 Pinzas quirúrgicas, 1 x 2 dientes, 130 mm, tk 11000-13
- 2 Pinzas hemostáticas de Rochester-Péan, 130 mm, tk 12059-13
- 1 Sonda acanalada, 130 mm, tk 18110-13
- 1 Dilatador traqueal de Bose, tk 17395-07
- 2 Separadores traqueales de Iterson, romos, tk 16922-16
- 1 Separador traqueal de Bose, 160 mm, agudo, a la derecha, tk 16956-16
- 1 Separador traqueal de Bose, 160 mm, agudo, a la izquierda, tk 16957-16
- 1 Cánula traqueal de Luer, modelo standard, 7 mm Ø, plata alemana, tk 29960-03
- 1 Cánula traqueal de Luer, modelo standard, 8 mm Ø, plata alemana, tk 29960-04
- 1 Cepillo de limpieza, tk 29999-26

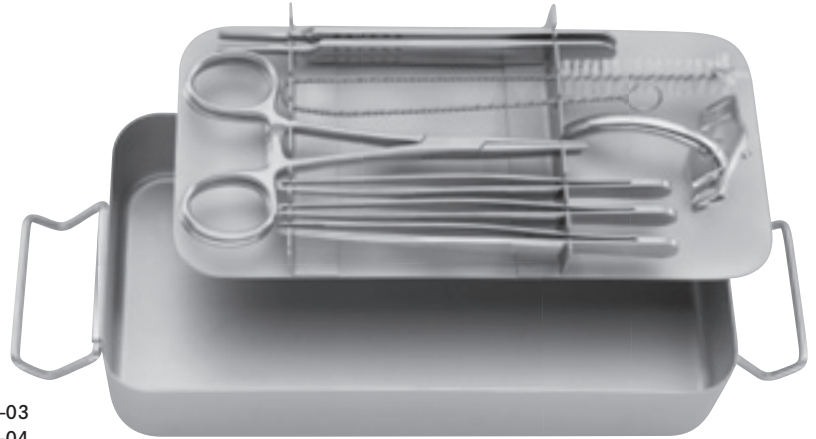

Astuccio per tracheotomia, contenente

- 1 Manico, tk 7100-04/1 lama, Fig. 20, tk 7210-20 T
- 1 Manico, tk 7100-04/1 lama, Fig. 23, tk 7210-23 T
- 1 Pinza anatomica, 130 mm, tk 10000-13
- 2 Pinze chirurgiche, 1 x 2 denti, 130 mm, tk 11000-13
- 2 Pinze Rochester-Péan, 130 mm, tk 12059-13
- 1 Sonda scanalata, 130 mm, tk 18110-13
- 1 Uncino di Bose, tk 17395-07
- 2 Uncini Iterson, smussa, tk 16922-16
- 1 Uncino Bose, 160 mm, acuta, a destra, tk 16956-16
- 1 Uncino Bose, 160 mm, acuta, a sinistra, tk 16957-16
- 1 Canula tracheale Luer, modello standard, 7 mm Ø, argenteo, tk 29960-03
- 1 Canula tracheale Luer, modello standard, 8 mm Ø, argenteo, tk 29960-04
- 1 Spazzolina per pulire, tk 29999-26

Kropffasszangen – Kropfsonden
 Goitre grasping forceps – Goitre enucleator

Pinces à goitre – Spatules à goitre
 Pinzas para coger el bocio – Sondas para el bocio
 Pinze per gozzo – Sonde per gozzo



MASTIN
 170 mm – 6½" **tk49905-17**

1:2

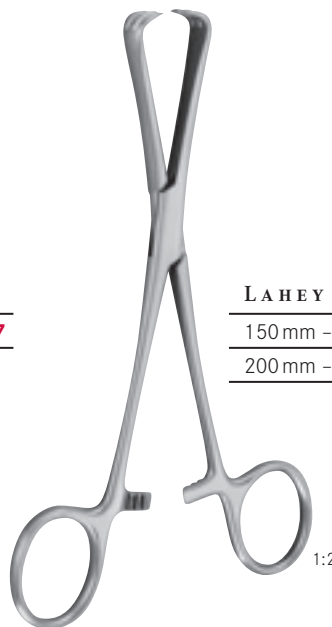

LAHEY
 150 mm – 6" **tk49900-15**
 200 mm – 8" **tk49900-20**

1:2



1:1



1:1

KOCHER
 150 cm – 6" **tk49925-15** **tk49927-15**
 160 mm – 6¼" **tk49925-16** **tk49927-16**

mit Loch
 with hole
 avec trou
 con orificio
 con foro

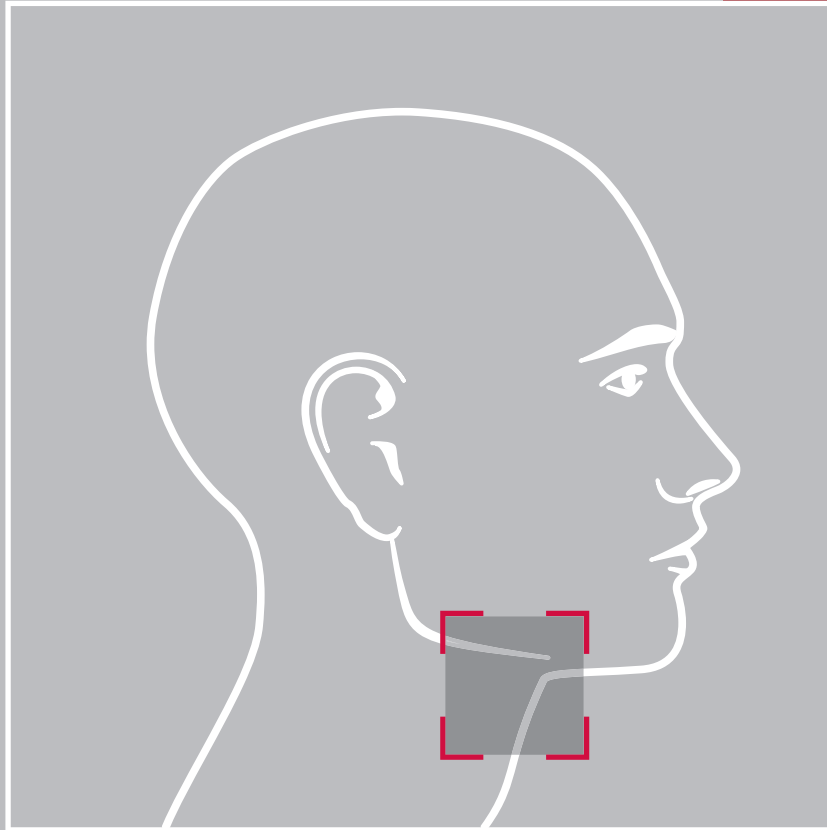

Broncho-Oesophagoskopie
Broncho-oesophagoscopy

Broncho-oesophagoskopie
Bronco-esofagoscopia
Bronco-esofagoscopia



Bronchoskope | Bronchoscopes
Bronchoscopes | *Broncoscopios*
 Broncoscopi

autoklavierbar / autoclavable
 134°C / 273°F - 18 min.

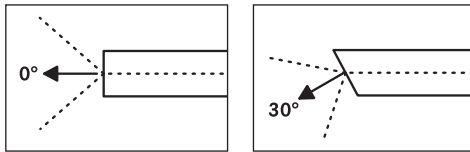

Ø 2.9 mm - 365 mm	tk 700-157	tk 700-158
Ø 4.0 mm - 490 mm	tk 700-155	
Ø 5.5 mm - 505 mm	tk 700-150	tk 700-153

Ø, Arbeitslänge
 Ø, Working length
 Ø, Longueur de travail
 Ø, Longitud de trabajo
 Ø, Lunghezza operativa

Oesophagoskop | Oesophagoscope
Oesophagoscope | *Esofagoscopio*
 Esofagoscopio

autoklavierbar / autoclavable
 134°C / 273°F - 18 min.

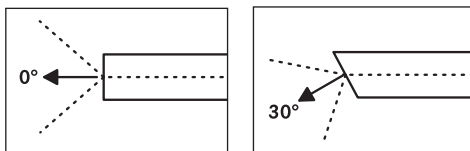

Ø 5.5 mm - 530 mm	tk 700-140	tk 700-143
-------------------	-------------------	-------------------

Ø, Arbeitslänge
 Ø, Working length
 Ø, Longueur de travail
 Ø, Longitud de trabajo
 Ø, Lunghezza operativa

Broncho-Oesophagoskopiezangen
Broncho-oesophagoscopia forceps

Pinces pour broncho-oesophagoscopie
Pinzas para bronco-esofagoscopia
 Pinze per bronco-esofagoscopia



BRUENINGS

200 mm - 8"	tk 53391-20
300 mm - 12"	tk 53391-30
400 mm - 16"	tk 53391-40
500 mm - 20"	tk 53391-50
600 mm - 23½"	tk 53391-60

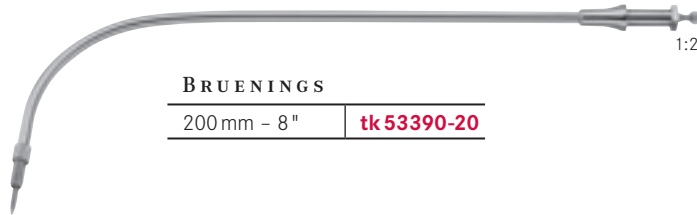

BRUENINGS

200 mm - 8"	tk 53390-20
-------------	--------------------



HUBER

tk 53375-01

Broncho-Oesophagoskopiezangen
Broncho-oesophagoscopia forceps

Pinces pour broncho-oesophagoscopie
Pinzas para bronco-esofagoscopia
Pinze per bronco-esofagoscopia

Auswechselbare Zangenaufsätze
Exchangeable tips

Embouts interchangeable
Bocas intercambiables
Punte intercambiabili



SEIFFERT

tk 53410-01



BRUENINGS

tk 53410-02

tk 53410-03

tk 53410-04



LANGE

tk 53410-05



SCHEINMANN

tk 53410-06



FRAENKEL

tk 53410-16



FRAENKEL

tk 53410-07



KRAUSE

tk 53410-12



tk 53410-08

tk 53410-09



tk 53410-10

tk 53410-11



CORDES

tk 53410-13

tk 53410-14

Broncho-Oesophagoskopiezangen
Broncho-oesophagoscopy forceps

Pinces pour broncho-oesophagoscopie
Pinzas para bronco-esofagoscopia
 Pinze per bronco-esofagoscopia

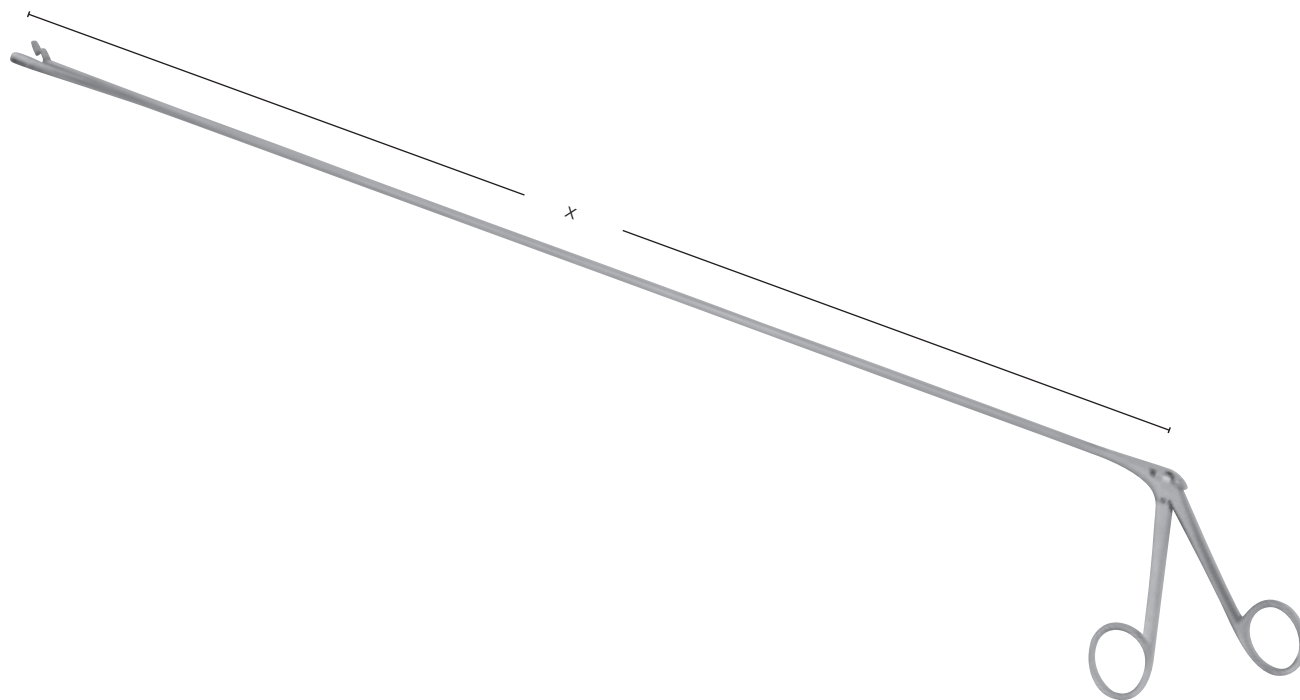

CHEVALIER-JACKSON



x = 300 mm - 12"	tk 53361-30	tk 53362-30	tk 53363-30	tk 53364-30
x = 400 mm - 16"	tk 53361-40	tk 53362-40	tk 53363-40	tk 53364-40
x = 500 mm - 20"	tk 53361-50	tk 53362-50	tk 53363-50	tk 53364-50
x = 600 mm - 23½"	tk 53361-60	tk 53362-60	tk 53363-60	tk 53364-60



x = 300 mm - 12"	tk 53365-30	tk 53366-30	tk 53367-30
x = 400 mm - 16"	tk 53365-40	tk 53366-40	tk 53367-40
x = 500 mm - 20"	tk 53365-50	tk 53366-50	tk 53367-50
x = 600 mm - 23½"	tk 53365-60	tk 53366-60	tk 53367-60

Mikro-Instrumente für Laryngo-Broncho-Oesophagoskopie
Micro-instruments for laryngo-broncho-oesophagoscopy

Micro-instruments pour laryngo-broncho-oesophagoscopie
Micro-instrumental para laringo-bronco-esofagoscopia
 Micro-strumenti per laringo-bronco-esofagoscopia

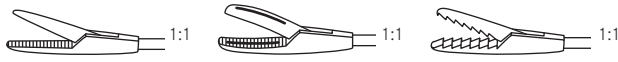
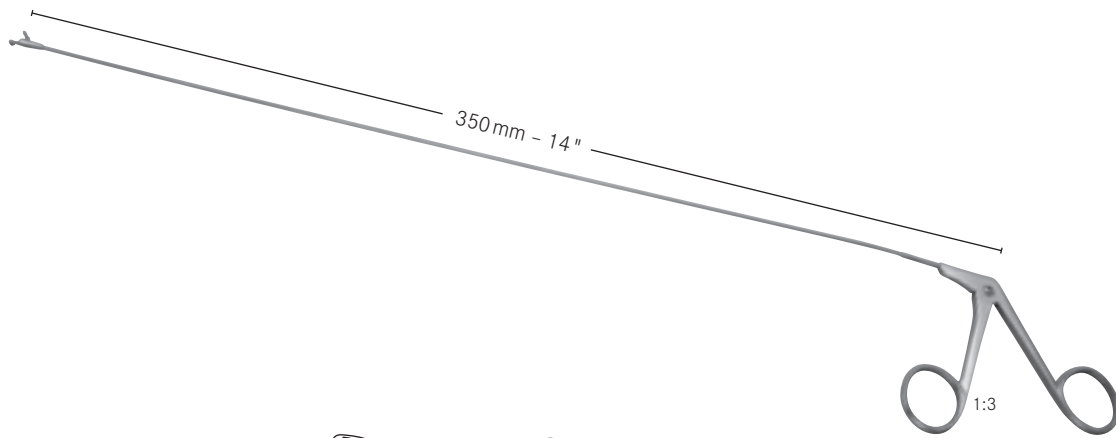

	tk 52680-01	tk 52680-02	tk 52680-03
Fasszange <i>Grasping forceps</i>	gerade, gerieft <i>straight, serrated</i>	gerade, gefenstert <i>straight, fenestrated</i>	gerade <i>straight</i>
Pince à saisir <i>Pinza agarre</i> <i>Pinza da presa</i>	droit, striée <i>recta, estriada</i> <i>retta, zigrinata</i>	droit, fenêtrée <i>recta, fenestrada</i> <i>retta, fenestrata</i>	droits <i>recta</i> <i>retta</i>

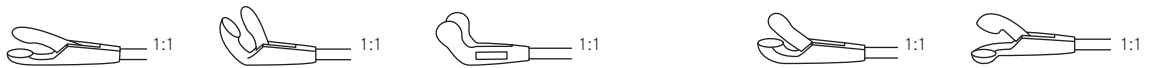

○ 3 mm	tk 52680-04	tk 52680-05	tk 52680-06	tk 52680-07	tk 52680-08
Löffelzangen <i>Cup shaped forc.</i>	gerade <i>straight</i>	aufgebogen <i>angled up</i>	aufgebogen horizontal <i>angled up horizontal</i>	rechts gebogen <i>curved right</i>	links gebogen <i>curved left</i>
Pinces cures <i>Pinzas cureta</i> <i>Pinze a cucchaio</i>	droit <i>recta</i> <i>retta</i>	coudée en haut <i>curvada arriba</i> <i>curvata in alto</i>	coudée en haut coupe horizontalement <i>curvada arriba horizontal</i> <i>curvata in alto orizzontale</i>	courbe à droite <i>curvada a derecha</i> <i>curva a destra</i>	courbe à droite <i>curvada a izquierda</i> <i>curva a sinistra</i>



	tk 52680-09	tk 52680-10		tk 52680-11
Löffelzangen <i>Cup shaped forc.</i>	2 mm x 5 mm	3 mm x 5 mm		
Pinces cures <i>Pinzas cureta</i> <i>Pinze a cucchaio</i>	tk 52680-09	tk 52680-10		tk 52680-11
Löffelzangen <i>Cup shaped forc.</i>	gerade <i>straight</i>	gerade <i>straight</i>	Universalzange <i>Universal forceps</i>	gerade <i>straight</i>
Pinces cures <i>Pinzas cureta</i> <i>Pinze a cucchaio</i>	droit <i>recta</i> <i>retta</i>	droit <i>recta</i> <i>retta</i>	Pince universelle <i>Pinza universal</i> <i>Pinza universale</i>	droit <i>recta</i> <i>retta</i>

Mikro-Instrumente für Laryngo-Broncho-Oesophagoskopie
Micro-instruments for laryngo-broncho-oesophagoscopy

Micro-instruments pour laryngo-broncho-oesophagoscopie
Micro-instrumental para laringo-bronco-esofagoscopia
 Micro-strumenti per laringo-bronco-esofagoscopia

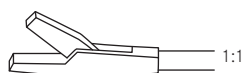
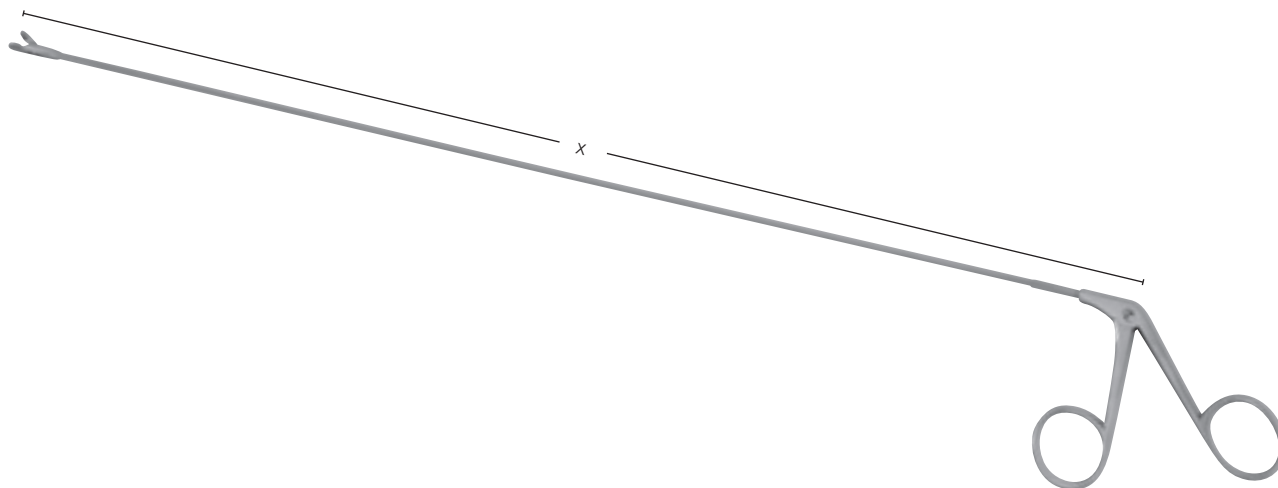

x = 400 mm - 16"	tk 52682-01
x = 500 mm - 20"	tk 52684-01
x = 600 mm - 23½"	tk 52686-01

Tumorzange, gerade

Punch forceps, straight

Pince pour tumeurs, droit

Pinza para tumores, recta

Pinza per tumori, retta

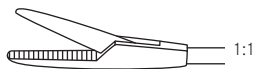

x = 400 mm - 16"	tk 52682-02	tk 52682-03	tk 52682-04
x = 500 mm - 20"	tk 52684-02	tk 52684-03	tk 52684-04
x = 600 mm - 23½"	tk 52686-02	tk 52686-03	tk 52686-04

Fasszangen

Grasping forceps

Pinces à saisir

Pinzas agarre

Pinze da presa

gerade, gerieft

straight, serrated

droit, striée

recta, estriada

retta, zigrinata

gerade, gefenstert

straight, fenestrated

droit, fenêtrée

recta, fenestrada

retta, finestra

gerade

straight

droit

recta

retta

Mikro-Instrumente für Laryngo-Broncho-Oesophagoskopie
Micro-instruments for laryngo-broncho-oesophagoscopy

Micro-instruments pour laryngo-broncho-oesophagoscopie
Micro-instrumental para laryngo-bronco-esofagoscopia
 Micro-strumenti per laryngo-bronco-esofagoscopia

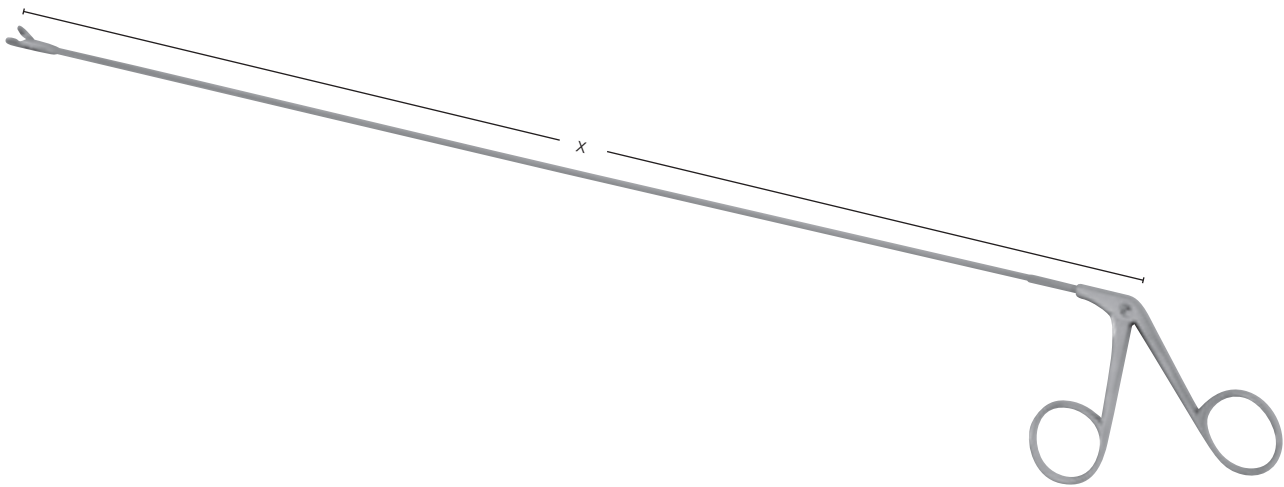

	4 mm	4 mm	4 mm	4 mm
x = 400 mm - 16"	tk 52682-05	tk 52682-06	tk 52682-07	tk 52682-08
x = 500 mm - 20"	tk 52684-05	tk 52684-06	tk 52684-07	tk 52684-08
x = 600 mm - 23½"	tk 52686-05	tk 52686-06	tk 52686-07	tk 52686-08

Löffelzangen <i>Cup shaped forceps</i>	gerade <i>straight</i>	aufgebogen <i>angled up</i>	aufgebogen horizontal <i>angled up horizontal</i>	rechts gebogen <i>curved right</i>
Pincès à curette	droit	coudée en haut	coudée en haut coupe horizontalement	courbe à droite
<i>Pinzas cureta</i>	<i>recta</i>	<i>curvada arriba</i>	<i>curvada arriba horizontal</i>	<i>curvada a derecha</i>
Pinze a cucchaio	retta	curvata in alto	curvata orizzontalmente	curva a destra

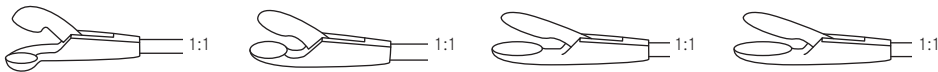

	4 mm	3 mm x 4 mm	4 mm x 6 mm	4 mm x 8 mm
x = 400 mm - 16"	tk 52682-09	tk 52682-10	tk 52682-11	tk 52682-12
x = 500 mm - 20"	tk 52684-09	tk 52684-10	tk 52684-11	tk 52684-12
x = 600 mm - 23½"	tk 52686-09	tk 52686-10	tk 52686-11	tk 52686-12

Löffelzangen <i>Cup shaped forceps</i>	links gebogen <i>curved left</i>	gerade <i>straight</i>	gerade <i>straight</i>	gerade <i>straight</i>
Pincès mors curettes	courbe à gauche	droit	droit	droit
<i>Pinzas cureta</i>	<i>curvada a izquierda</i>	<i>recta</i>	<i>recta</i>	<i>recta</i>
Pinze a cucchaio	curva a sinistra	retta	retta	retta



x = 400 mm - 16"	tk 52682-13
x = 500 mm - 20"	tk 52684-13
x = 600 mm - 23½"	tk 52686-13

Universalzange <i>Universal forceps</i>	gerade <i>straight</i>
Pince universelle	droit
<i>Pinza universal</i>	<i>recta</i>
Pinza universale	retta

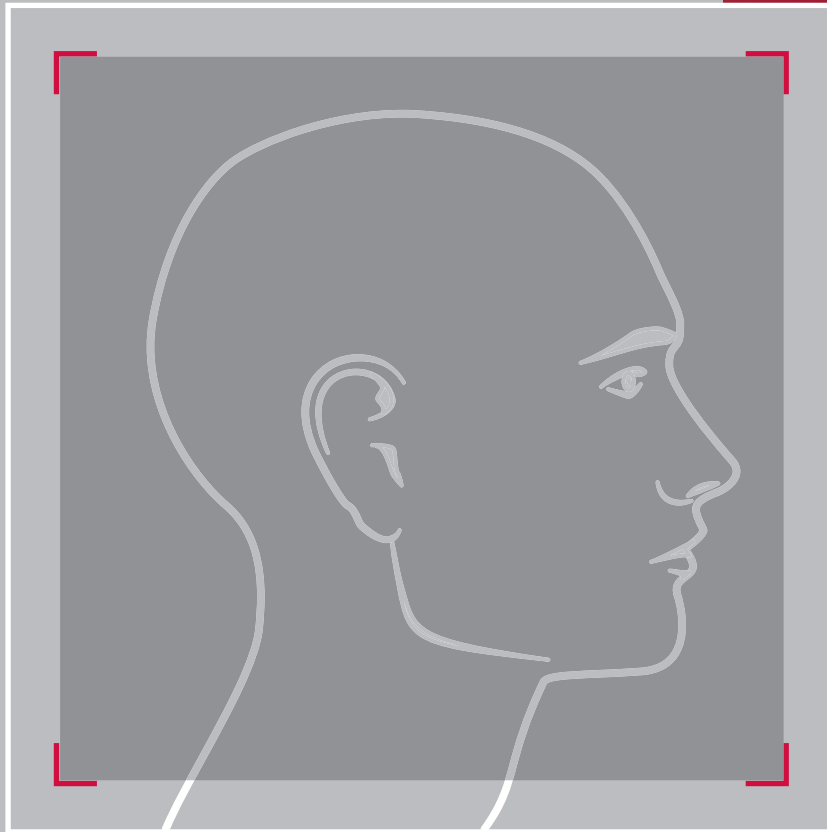

Allgemeines Instrumentarium
General surgical instruments

Instrumentes généraux
Instrumental general
 Strumentario generale



Diagnostik-Bestecke
Diagnostic sets

Trousse à diagnose
Juegos para diagnóstica
Set diagnostici

tk 4434-00

Otoskop-Besteck
Otoscope set

Trousse à otoscopie
Otoscopio
Otoscopio



tk 4432-00

Kombinations-Besteck
Combination set

Trousse combinée
Estuche combinado
Set combinato



tk 4430-00

Universal-Besteck
Universal set

Trousse universelle
Estuche universal
Set universale



Stirnspiegel | Miroirs frontaux
 Head mirrors | Espejos frontales
 | Specchi frontali



ZIEGLER

90 mm Ø

tk 4550-00

Stirnspiegel mit schwarzem Plastikband
 Head mirror with black plastic head band

Miroir frontal avec ruban en plastique noir
 Espejo frontal con banda de plastica negra
 Specchio frontale con fascia di plastica nera

ZIEGLER

90 mm Ø

tk 4520-09

Reflexspiegel allein, mit Gummifassung
 Head mirror only, with rubber coating

Miroir frontal seul, avec monture en caoutchouc
 Espejo frontal solo, con guarnición de goma
 Solo specchio frontale, con guarnizione di gomma

90 mm Ø

tk 4552-00

Stirnspiegel mit weissem Plastikband
 Head mirror with white plastic head band

Miroir frontal avec ruban en plastique blanc
 Espejo frontal con banda de plastica blanca
 Specchio frontale con fascia di plastica bianca

tk 4510-00

Plastikband, schwarz
 Black plastic head band

Ruban en plastique noir
 Banda de plastica, negra
 Fascia di plastica, nera

tk 4511-00

Plastikband, weiss
 White plastic head band

Ruban en plastique blanc
 Banda de plastica, blanca
 Fascia di plastica, bianca

Stirnlampen
Head lamps

Eclaireurs frontaux
Lámparas frontales
Lampade frontali



CLAR

100 mm Ø, 6V	tk 4555-06
--------------	-------------------

Stirnlampe komplett
Head light complete

Eclaireur frontal complet
Lámpara frontal, completa
Lampada frontale, completa

100 mm Ø, 6V	tk 4556-06
--------------	-------------------

Stirnlampe mit Kabel, Fassung und Spiegel, ohne Stirnreifen
Head light with cable, frame and mirror, without head band

Eclaireur frontal avec cable, douille et miroir, sans ruban
Lámpara frontal, con cable, armadura y espejo, sin banda
Lampada frontale con cavo, supporto e specchio, senza fascia



MINI-CLAR

50 mm Ø, 6V	tk 4560-06
-------------	-------------------

komplett
complete
complet
completa
completa

CLAR

50 mm Ø	tk 4560-07
100 mm Ø	tk 4555-07

Spiegel aus Glas, ohne Fassung
Head mirror glass, without frame
Miroir frontal en vitre, sans douille
Espejo frontal de cristal, sin armadura
Vetro specchio, senza supporto

CLAR

tk 4557-01

Spezial-Gelenkverbindung
Special socket joint
Assemblage articulé spécial
Conexión
Giunto di connessione speciale

CLAR

tk 4557-07

Stirnreifen allein
Head band only
Ruban seul
Banda sola
Solo fascia frontale

6V	tk 4557-06
----	-------------------

Glühbirne
Bulb
Ampoule
Bombilla
Lampadina



Input 220V / 50Hz ~

Output 0-10V / 3W =

tk 4585-01

Transformator – stufenlos einstellbar
Transformer – stepless adjustable

Transformateur – à réglage continue
Transformador – regulación continua
Trasformatore – regolabile in continuità

Stirnlampen
Head lamps

Eclaireurs frontaux
Lámparas frontales
Lampade frontali



CLAR

55 mm Ø

tk4559-30

LED Ausführung inkl. Batteriebehälter

LED execution incl. battery box

Exécution LED avec conteneur des piles

Ejecución LED con contenedor de pilas

Modello a led con porta batterie



POWER LED

tk4559-50

tk4559-51

Inkl. Batteriebehälter

Incl. battery box

Avec conteneur des piles

Con contenedor de pilas

Con porta batterie

Inkl. Akkubox

Incl. box for rechargeable batteries

Avec conteneur pour accumulateur

Con contenedor de acumulador

Con porta accumulatori

Leistungsstarke, fokussierbare Stirnleuchte mit weißer LED
Focusable high performance headlight with white LED lamp

Eclaireur frontal, de haute performance, ajustable, lampe LED blanche

Lámpara frontal de alta rendimiento, ajustable, con LED blanco

Lampada frontale ad alto rendimento, regolabile, con led bianco



tk4559-53

Wie tk 4559-50 jedoch mit Batteriebehälter am Reif

Same as tk 4559-50 but with battery box on the headband

Comme tk 4559-50, mais avec conteneur de piles au ruban

Como tk 4559-50, pero con contenedor de pilas a la banda de plastica

Come tk 4559-50 ma con porta batterie sulla banda frontale

Stirnlampen
Head lamps

Eclaireurs frontaux
Lámparas frontales
Lampade frontali



MICRO LED

tk 4559-55

Einfaches LED Ausführung mit Batteriebehälter am Reif

Basic LED execution incl. battery box on the headband

Exécution LED de base avec conteneur de piles au ruban

Ejecución LED de base con contenedor de pilas a la banda de plastica

Modello base con led con portapile sulla fascia frontale



XENON

tk 4561-50

Xenon Hochleistungslampe 6000Cd mit integrierter Batteriebehälter

Xenon high performance lamp 6000Cd with integrated battery box

Lampe de haute performance xenon 60000Cd avec conteneur des piles incorporé

Boritsilla economica de alta rendimiento Xenon 6000Cd con contenedor de pilas incorporado

Lampada xenon ad alta efficienza 6000Cd con porta batterie integrato

Kaltlicht-Stirnlampe
Cold-light head lamp

Eclaireur frontal de lumière froide
Lámpara frontal de luz fría
Lampada frontale a luce fredda

BINNER

tk 4559-00

Kaltlicht-Stirnlampe mit verstellbarer Fokussierlinse,
Arbeitsabstand 300 mm, Leuchtfeldgröße 70 – 120 mm Ø

*Head light, cold-light, adjustable focus,
working distance 300 mm, field of illumination 70 – 120 mm Ø*

Eclaireur frontal, lumière froide, focus ajustable,
distance de travail 300 mm, champ d'illumination 70 – 120 mm Ø

*Lámpara frontal, luz fría, focus ajustable,
distancia de trabajo 300 mm, campo de iluminación 70 – 120 mm Ø*

Lampada frontale, luce fredda, con lente a focale variabile,
distanza di lavoro 300 mm, campo d'illuminazione 70 – 120 mm Ø



Nystagmusbrillen
Spectacles Nystagmus

Lunettes pour l'examen du Nystagme
Gafas iluminadas para el Nistagmus
Occhiali per Nistagmo

FRENZEL

tk 4569-00

Nystagmusbrille, +18 Dioptrien mit Beleuchtung, Anschlusskabel 1,40m
Nystagmus spectacles, +18 diopters with illumination, connecting cable 1.40m
Lunettes pour l'examen du Nystagme, +18 dioptries avec éclairage, câble de raccordement 1.40m
Gafas para el Nistagmus, +18 dioptría con iluminación, cable conexión 1,40m
Occhiali per Nistagmo, +18 diottrie con illuminazione, cavo di raccordo 1,40m



FRENZEL

tk 4570-00

Nystagmusbrille, +18 Dioptrien mit Beleuchtung und aufklappbaren Gläsern, Anschlusskabel 1,40m
Nystagmus spectacles, +18 diopters with illumination and swivel loupes, connecting cable 1.40m
Lunettes pour l'examen du Nystagme, +18 dioptries avec éclairage et verres relevables, câble de raccordement 1,40m
Gafas para el Nistagmus, +18 dioptría con iluminación y vidrios rebatibles, lentes biconvexas, cable conexión 1,40m
Occhiali per Nistagmo, +18 diottrie con illuminazione e vetri decappotabili, lenti biconvesse, cavo di raccordo 1,40m



220V / 50Hz ~ **tk 4570-01**

Transformator – regelbar
Transformer – adjustable
Transformateur – à réglage
Transformador – regulación
Trasformatore – regolabile



tk 5187-04

Halogen Ersatzlampe
Halogen spare lamp
Halogéne lampe de rechange
Halogeno bombilla de cambio
Lampadina di ricambio alogena

Binokularlupe | Loupe binoculaire
Binocular magnifying lens | *Lupa binocular*
 | Lente binoculare

**tk 4596-00**

2.5 fache Vergrößerung, 340 mm Arbeitsabstand, Sichtfeld > 90 mm Ø, komplett.
 Pupillenabstand einstellbar von 48 mm – 77 mm. Neigungswinkel individuell justierbar.
 Gewicht der Optik 42 g.

2.5 times enlargement, 340 mm working distance, field of vision > 90 mm Ø, complete.
Pupillary distance adjustable from 48 mm – 77 mm. Individual adjustable angle of inclination.
Weight of the optic 42 g.

2.5 fois grossissement, distance de travail 340 mm, champ de vision > 90 mm Ø, complèt.
 Ecart interpupillaire ajustable de 48 mm – 77 mm. Angle d'inclinaison ajustable individuellement.
 Poids de l'optique 42 g.

2.5 veces aumento, distancia de trabajo 340 mm, campo de visión > 90 mm Ø, completo.
Distancia interpupilar ajustable de 48 mm – 77 mm. Angulo de inclinación ajustable individual.
Peso de la optica 42 g.

Ingrandimento: 2.5 volte, distanza di lavoro 340 mm, campo di visione > 90 mm Ø, completo.
 Distanza interpupillare regolabile da 48 mm – 77 mm. Angolo di inclinazione regolabile individualmente.
 Peso dell'ottica 42 g.

tk 4596-01

Kopfband
Head band

Ruban
 Banda
 Fascia



Andere Arbeitsabstände und Sichtfelder auf Anfrage.
Other working distances and fields of vision upon request.

Autres distances de travail et champs de vision sur demande.
Otras distancias de trabajo y campos de visión según demanda.
 Su richiesta disponibili altre distanze di lavoro e campi di visione.

Zungenspatel
Tongue depressors

Abaisse-langues
Espatulas bucales
Abbassalingua



1:2

160 mm - 6¼" **tk 5482-16**

Holz
Wood
Bois
Madera
Legno



1:2

145 mm - 5¾" **tk 5483-14**



1:2

KROENIG
150 mm - 6" **tk 5485-15**



1:2

MAYO
170 mm - 6¾" **tk 5486-17**



1:2

BRUENINGS
190 mm - 7½" **tk 5487-19**



1:2

FRENZEL
165 mm - 6½" **tk 5489-16**

Zungendrucker
Tongue depressors

Abaisse-langues
Baja lenguas
Abbassalingua



1:2



1:2

WIEDER

150 mm - 6"

tk 5479-01

140 mm - 5½"

tk 5479-02



1:2

BOSWOTH

145 mm - 5¾"

tk 5475-14



1:2

TOBOLD

145 mm - 5¾"

tk 5477-14



1:2

HARTMANN

150 mm - 6"

tk 5480-15



1:2

ANDREW

110 mm - 4¾"

tk 5481-11

Zungenzangen
Tongue holding forceps

Pinces tire langue
Pinzas tiralengua
Pinze tiralingua



YOUNG

170 mm - 6¾"

tk 5410-17

1:2

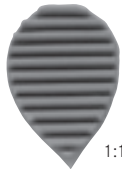

1:1



1:1

tk 5410-90

1 Paar Ersatz Gummi-Einsätze
1 Pair rubber-inserts
1 Paire des inserts en caoutchouc
1 Juego de insertos de goma
1 Paio d'inserti di gomma



COLLIN

160 mm - 6¼"

tk 5430-16

170 mm - 6¾"

tk 5430-17

190 mm - 7½"

tk 5430-19

Laryngoskope | Laryngoscopes
 Laryngoscopes | Laringoscopios
 Laringoscopi

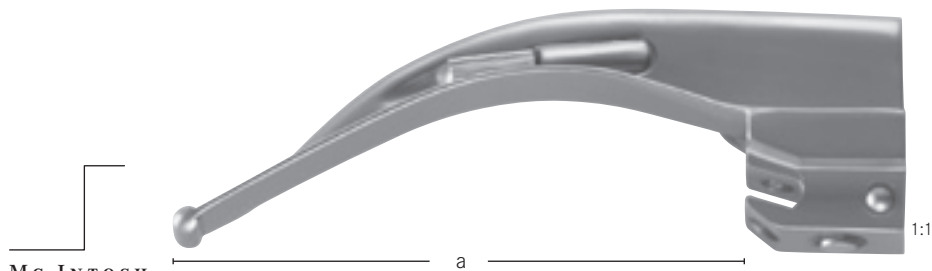

Fig. 0	Fig. 1	Fig. 2	Fig. 3	Fig. 4	Fig. 5
a = 55 mm	a = 70 mm	a = 90 mm	a = 110 mm	a = 130 mm	a = 150 mm
tk 5100-00	tk 5100-01	tk 5100-02	tk 5100-03	tk 5100-04	tk 5100-05

rostfrei
 stainless steel
 inoxydable
 inoxidable
 inossidabile



Fig. 0	Fig. 1	Fig. 2	Fig. 3	Fig. 4	Fig. 5
tk 5145-02	tk 5145-02	tk 5145-01	tk 5145-01	tk 5145-01	tk 5145-01

Ersatzlampe
 Spare lamp
 Lampe de rechange
 Bombilla de sustitución
 Lampadina di ricambio



	Fig. 0	Fig. 1	Fig. 2	Fig. 3	Fig. 4
	a = 55 mm	a = 70 mm	a = 90 mm	a = 110 mm	a = 130 mm
tk 5110-03			x	x	x
tk 5110-04		x	x	x	x
tk 5110-05	x	x	x	x	x

Satz im Etui mit Griff rostfrei (Griff: tk 5143-07, Seite 21)
 Set in case with handle stainless steel (handle: tk 5143-07, page 21)
 Trousse à laryngoscopie en boîte avec manche inoxydable (manche: tk 5143-07, page 21)
 Juego de laringoscopia, en caja, con mango inoxidable (mango: tk 5143-07, pagina 21)
 Astuccio da laringoscopia, in cassetta, manico inossidabile (manico: tk 5143-07, pagina 21)

	tk 5110-11	tk 5110-12	tk 5110-13
Etui für Mc Intosh, leer Case for Mc Intosh, empty	für 3 Spatel for 3 blades	für 4 Spatel for 4 blades	für 5 Spatel for 5 blades
Etui pour Mc Intosh, vide Estuche para Mc Intosh, vacío	pour 3 spatules para 3 espátulas	pour 4 spatules para 4 espátulas	pour 5 spatules para 5 espátulas
Astuccio per Mc Intosh, vuoto	per 3 spatole	per 4 spatole	per 5 spatole

Laryngoskope
Laryngoscopes

Laryngoscopes
Laringoscopios
Laringoscopi

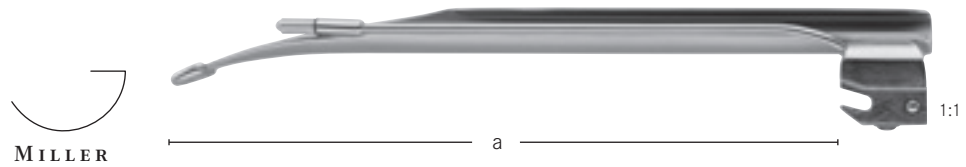

Fig. 0	Fig. 1	Fig. 2	Fig. 3	Fig. 4
a = 55 mm	a = 80 mm	a = 130 mm	a = 170 mm	a = 180 mm
tk 5120-00	tk 5120-01	tk 5120-02	tk 5120-03	tk 5120-04

rostfrei
stainless steel
inoxydable
inoxidable
inossidabile



Fig. 0	Fig. 1	Fig. 2	Fig. 3	Fig. 4
tk 5145-02	tk 5145-02	tk 5145-01	tk 5145-01	tk 5145-01

Ersatzlampe
Spare lamp
Lampe de rechange
Bombilla de sustitución
Lampadina di ricambio



	Fig. 0	Fig. 1	Fig. 2	Fig. 3	Fig. 4
	a = 55 mm	a = 80 mm	a = 130 mm	a = 170 mm	a = 180 mm
tk 5121-03		x	x	x	
tk 5121-04		x	x	x	x
tk 5121-05	x	x	x	x	x

Satz im Etui mit Griff rostfrei (Griff: tk 5143-07, Seite 21)
Set in case with handle stainless steel (handle: tk 5143-07, page 21)
Trousse à laryngoscopie en boîte avec manche inoxydable (manche: tk 5143-07, page 21)
Juego de laringoscopia, en caja, con mango inoxidable (mango: tk 5143-07, pagina 21)
Astuccio da laringoscopia, in cassetta, manico inossidabile (manico: tk 5143-07, pagina 21)

	tk 5121-11	tk 5121-12	tk 5121-13
Etui für Miller, leer Case for Miller, empty	für 3 Spatel for 3 blades	für 4 Spatel for 4 blades	für 5 Spatel for 5 blades
Etui pour Miller, vide Estuche para Miller, vacío	pour 3 spatules para 3 espátulas	pour 4 spatules para 4 espátulas	pour 5 spatules para 5 espátulas
Astuccio per Miller, vuoto	per 3 spatole	per 4 spatole	per 5 spatole

Laryngoskop-Griffe
Laryngoscope handles

Manches pour laryngoscopes
Mangos de laringoscopios
Manici per laringoscopi



tk 5140-07

verchromt
chrome plated

chromé
cromado
cromato

tk 5142-07

rostfrei
stainless steel

inoxydable
inoxidable
inossidabile

1:1



tk 5141-07

verchromt
chrome plated

chromé
cromado
cromato

tk 5143-07

rostfrei
stainless steel

inoxydable
inoxidable
inossidabile

1:1



Alle Griffe sind nur in Gas sterilisierbar oder in einer Lösung zu desinfizieren. Keine Sterilisation in Autoklaven und Heissluft. In jedem Fall vorher den Akkumulator oder den Batteriecontainer entnehmen.

All handles are only sterilizable in a gassterilizer or can be cleaned in a disinfection solution. Not autoclavable and no sterilisation in hot-air. Accumulator or battery housing must be taken off before.

Toutes les manches peuvent être stérilisées à gaz ou dans une solution désinfectante. Aucune stérilisation dans l'autoclave et à l'air chaud. Accumulateur ou contenair des piles doit être enlevé.

Todos los mangos son solamente esterilizables en gas o en una solución de desinfección. No esterilización en el autoclave o con aire caliente. En todo caso, quitar el acumulador o el contenedor de las pilas.

Tutti i manici sono soltanto immergibili oppure sterilizzabili in gas. Nessuna sterilizzazione in autoclave o aria calda. In tutti i casi dovette prima rimuovere l'accumulatore o il contenitore di batterie.

Laryngoskope – Kaltlicht
Laryngoscopes – Cold light

Laryngoscopes – lumière froide
Laringoscopios – luz fría
Laringoscopi – luce fredda

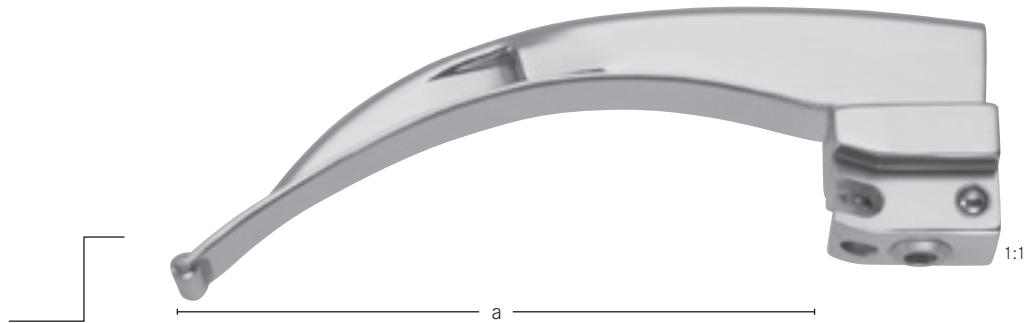

MC INTOSH

Fig. 0	Fig. 1	Fig. 2	Fig. 3	Fig. 4	Fig. 5
a = 55 mm	a = 70 mm	a = 90 mm	a = 110 mm	a = 130 mm	a = 150 mm
tk 5150-00	tk 5150-01	tk 5150-02	tk 5150-03	tk 5150-04	tk 5150-05

rostfrei
stainless steel
inoxydable
inoxidable
inossidabile



	Fig. 0	Fig. 1	Fig. 2	Fig. 3	Fig. 4
	a = 55 mm	a = 70 mm	a = 90 mm	a = 110 mm	a = 130 mm
tk 5151-03			x	x	x
tk 5151-04		x	x	x	x
tk 5151-05	x	x	x	x	x

Satz im Etui mit Griff rostfrei (Griff: tk 5176-09, Seite 24)

Set in case with handle stainless steel (handle: tk 5176-09, page 24)

Trousse à laryngoscopie en boîte avec manche inoxydable (manche: tk 5176-09, page 24)

Juego de laringoscopia, en caja, con mango inoxidable (mango: tk 5176-09, pagina 24)

Astuccio da laringoscopia, in cassetta, manico inossidabile (manico: tk 5176-09, pagina 24)



Sterilisier-Information: Alle Spatel können bis 134 °C im Autoklaven sterilisiert werden.

Sterilizing information: All blades are autoclavable up to 134 °C.

Information pour la stérilisation: Toutes les spatules peuvent être stérilisées jusqu'à 134 °C dans l'autoclave.

Información para la esterilización: Todas las espátulas pueden ser esterilizadas en el autoclave a 134 °C.

Informazione per la sterilizzazione: Tutte le spatole possono essere sterilizzate nell'autoclave fino a 134 °C.

Laryngoskope – Kaltlicht
Laryngoscopes – Cold light

Laryngoscopes – lumière froide
Laringoscopios – luz fría
Laringoscopi – luce fredda

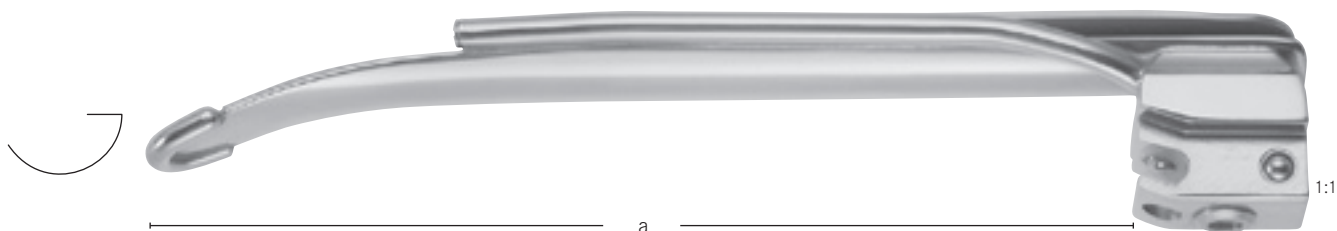

MILLER

Fig. 0	Fig. 1	Fig. 2	Fig. 3	Fig. 4
a = 55 mm	a = 80 mm	a = 130 mm	a = 170 mm	a = 180 mm
tk 5160-00	tk 5160-01	tk 5160-02	tk 5160-03	tk 5160-04

rostfrei
stainless steel
inoxydable
inoxidable
inossidabile



	Fig. 0	Fig. 1	Fig. 2	Fig. 3	Fig. 4
	a = 55 mm	a = 80 mm	a = 130 mm	a = 170 mm	a = 180 mm
tk 5161-03		x	x	x	
tk 5161-04		x	x	x	x
tk 5161-05	x	x	x	x	x

Satz im Etui mit Griff rostfrei (Griff: tk 5176-09, Seite 24)

Set in case with handle stainless steel (handle: tk 5176-09, page 24)

Trousse à laryngoscopie en boîte avec manche inoxydable (manche: tk 5176-09, page 24)

Juego de laringoscopia, en caja, con mango inoxidable (mango: tk 5176-09, pagina 24)

Astuccio da laringoscopia, in cassetta, manico inossidabile (manico: tk 5176-09, pagina 24)



Sterilisier-Information: Alle Spatel können bis 134 °C im Autoklaven sterilisiert werden.
Sterilizing information: All blades are autoclavable up to 134 °C.

Information pour la stérilisation: Toutes les spatules peuvent être stérilisées jusqu'à 134 °C dans l'autoclave.

Información para la esterilización: Todas las espátulas pueden ser esterilizadas en el autoclave a 134 °C.

Informazione per la sterilizzazione: Tutte le spatole possono essere sterilizzate nell'autoclave fino a 134 °C.

Laryngoskop-Griffe – Kaltlicht
Laryngoscope handles – Cold light

Manche pour laryngoscopes – lumière froide
Mangos de laringoscopios – luz fría
Manici per laringoscopi – luce fredda



tk 5175-09

Griff mit Batteriecontainer und Halogen-Lampe
Handle with battery container and halogen lamp
Manche avec conteneur à pile et lampe halogène
Mango con contenedor para pilas, luz halogeno
Manico con contenitore per pila, lampada alogena



tk 5176-09

Griff mit Batteriecontainer und Xenon-Lampe
Handle with battery container and xenon lamp
Manche avec conteneur à pile et lampe xenon
Mango con contenedor para pilas, luz xenon
Manico con contenitore per pila, luce xenon

Akkumulatoren und Batteriecontainer
Accumulators and battery containers

Accumulateurs et conteneurs de piles
Accumuladores y contenedores para pilas
Accumulatori e contenitori per pila



1:2

tk 5183-05

Batteriecontainer für tk 5176-09
Battery container for tk 5176-09

Conteneur à pile pour tk 5176-09
Contenedor para pilas, para tk 5176-09
Contentitore per pile, per tk 5176-09



1:2

tk 5184-05

Batteriencontainer für tk 5175-09
Battery container for tk 5175-09

Conteneur à pile pour tk 5175-09
Contenedor para pilas, para tk 5175-09
Contentitore per pile, per tk 5175-09



1:1

2,5V

tk 5186-04

für Batteriehandgriffe
for battery
pour de piles
para de pilas
per manici a pila

Xenon Ersatzlampen, 1 Packung à 6 Stück
Xenon spare lamps, pack of 6 pieces

Xenon lampe de rechange, jeu de 6 pièces
Xenon bombilla de cambio, juego de 6 piezas

Lampadina di ricambio Xenon, confezione da 6 pezzi

3,6V

tk 5186-06

für Akkuhandgriffe
for accumulator handles
pour poignées d'accumulateurs
para mangos de acumuladores
per manici d'accumulatore



1:1

tk 5187-04

Halogen Ersatzlampe
Halogen spare lamp

Halogéne lampe de rechange
Halogeno bombilla de cambio
Lampadina di ricambio alogena

Mundsperrer
Mouth gags

Ouvre-bouches
Abrebocas
Apribocca

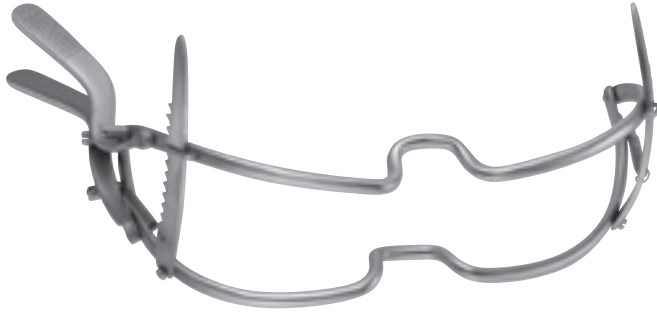

WHITEHEAD

110 mm - 4 1/4"	tk 52031-11
130 mm - 5"	tk 52031-13
150 mm - 6"	tk 52031-15

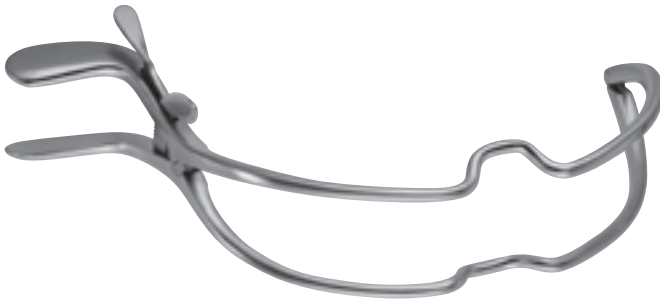

JENNINGS

190 mm - 3 1/2"	tk 52041-09
110 mm - 4 1/4"	tk 52041-11
130 mm - 5"	tk 52041-13
150 mm - 6"	tk 52041-15



MAUNDER

	4 mm Ø
100 mm - 4"	tk 52300-00

Holz
Wood
Bois
Madera
Legno

1:2



HEISTER

130 mm - 5"	tk 52110-13
-------------	-------------

1:2

Mundsperrer
Mouth gags

Ouvre-bouches
Abrebocas
Apribocca

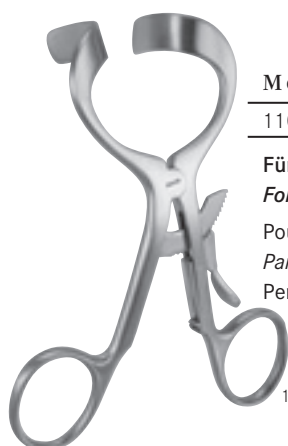

MOLT
110 mm - 4¼" **tk 52131-11**

Für Kinder
For children
Pour enfants
Para niños
Per bambini

1:2



MOLT
140 mm - 5½" **tk 52131-14**

Für Erwachsene
For adults
Pour adultes
Para adultos
Per adulti

1:2



DENHART
120 mm - 4¾" **tk 52141-12**

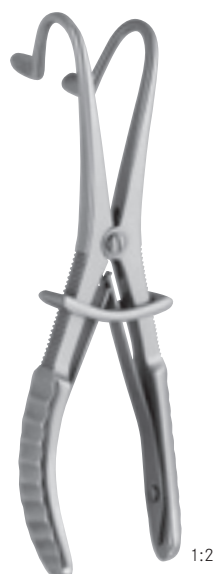

FERGUSON-ACKLAND
145 mm - 5¾" **tk 52142-14**

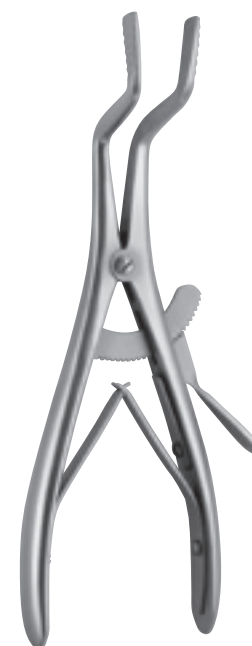

ROSER-KÖNIG
160 mm - 6¼" **tk 52149-16**
190 mm - 7½" **tk 52149-19**

Mundsperrer
Mouth gags

Ouvre-bouches
Abrebocas
Apribocca



1:2

LOVE

	150 mm - 6"
x = 18 mm	tk 52616-18
x = 20 mm	tk 52616-20
x = 22 mm	tk 52616-22

Uvula Haken

Uvula retractors

Ecarteurs uvulaires
Separadores uvulares
Divaricatori per ughola



1:2

NAGER

220 mm - 8¾"	tk 52620-23
--------------	--------------------

Gaumensegelhaken

Soft palate retractors

Releveurs du voile du palais
Separadores del velo palatino
Retrattori per velo palatino



1:1



STERNBERG

120 mm - 4¾"	tk 5471-12
140 mm - 5½"	tk 5471-14
160 mm - 6¼"	tk 5471-16

Wangenhalter

Cheek retractors

Ecarteur des joues
Separador de mejillas
Divaricatori per guancia



1:2

Ø 17 - 22 mm	tk 52004-01
Ø 19 - 24 mm	tk 52004-02
Ø 21 - 26 mm	tk 52004-03

Fingerschutz

Finger guard

Doigt articulé
Dedaleras
Proteggì dita

Mundsperrer
Mouth gags

Ouvre-bouches
Abrebocas
Apribocca

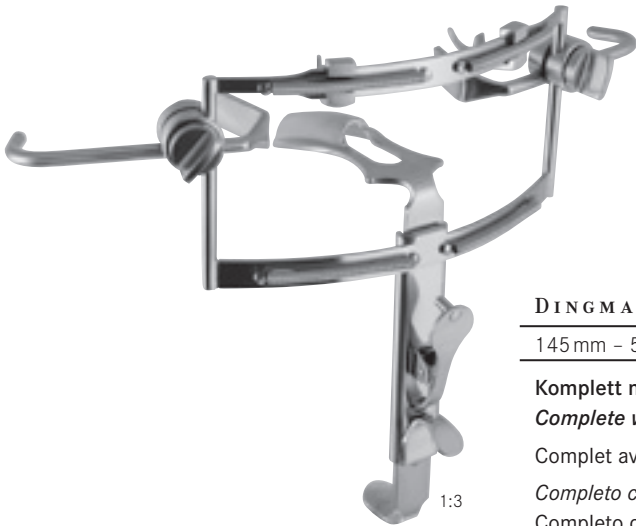

DINGMANN

145 mm - 5¾"

tk 52240-00

Komplett mit Rahmen, 3 Zungenspateln und 2 beweglichen Seitenvalven
Complete with frame, 3 tongue depressors and 2 adjustable lateral blades

Complet avec cadre, 3 abaisse-langues et 2 valves latérales réglables

Completo con bastidor, 3 bajalenguas y 2 valvas laterales ajustables

Completo con telaio, 3 abbassalingua e 2 valve laterali movibili



55 x 25 mm

tk 52240-01



60 x 27 mm

tk 52240-02



70 x 30 mm

tk 52240-03

Mundsperrer
Mouth gags

Ouvre-bouches
Abrebocas
Apribocca



KILNER-DOUGHTY

	Fig. 1	Fig. 2	Fig. 3	
	28 mm x 65 mm	32 mm x 75 mm	37 mm x 80 mm	
	tk 52250-01	tk 52250-02	tk 52250-03	tk 52250-10

Griff
Handle
Manche
Mango
Manico

tk 52250-00	x	x	x	x
--------------------	---	---	---	---

komplett
complete
compl
completa
completa

Mundsperrer
Mouth gags

Ouvre-bouches
Abrebocas
Apribocca



NEGUS	Fig. 1	Fig. 2	Fig. 3	
	20 mm x 70 mm	30 mm x 80 mm	33 mm x 95 mm	
	tk 52260-01	tk 52260-02	tk 52260-03	tk 52260-10

Griff
Handle
Manche
Mango
Manico

tk 52260-00	x	x	x	x
--------------------	---	---	---	---

komplett
complete
compl
completa
completa

Mundsperrer
Mouth gags

Ouvre-bouches
Abrebocas
Apribocca



DAVIS-BOYLE

	Fig. 1	Fig. 2	Fig. 3	Fig. 4	Fig. 5	
	21 mm x 26 mm	23 mm x 65 mm	24 mm x 80 mm	25 mm x 93 mm	26 mm x 108 mm	
	tk 52270-01	tk 52270-02	tk 52270-03	tk 52270-04	tk 52270-05	tk 52270-10

Griff
Handle
Manche
Mango
Manico

tk 52270-00	x	x	x	x	x	
--------------------	---	---	---	---	---	--

komplett
complete
complet
completa
completa

Mundsperrer
Mouth gags

Ouvre-bouches
Abrebocas
Apribocca

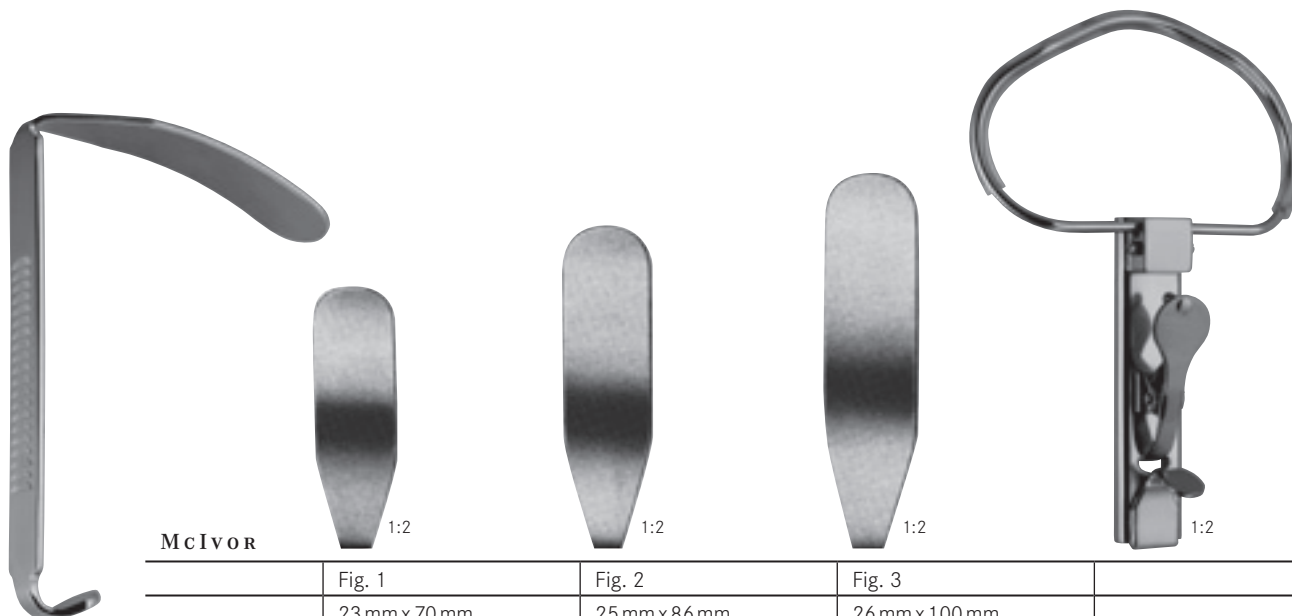

McIVOR	1:2	1:2	1:2	1:2
	Fig. 1	Fig. 2	Fig. 3	
	23 mm x 70 mm	25 mm x 86 mm	26 mm x 100 mm	
	tk 52280-01	tk 52280-02	tk 52280-03	tk 52280-10

Griff
Handle
Manche
Mango
Manico

tk 52280-00	x	x	x	x
--------------------	---	---	---	---

komplett
complete
complet
completa
completa



NEGUS

tk 52228-00

Bruststütze für alle Narkose-Mundsperrer
Chest support for all anesthesia mouth gags

Support de poitrine pour tous les ouvre-bouche pour anesthésie
Soporte de pecho para todos los abre bocas de anestesia
Supporto sternale per tutti gli apribocca da narcosi

Kropffasszangen – Kropffsonden
Goitre grasping forceps – Goitre enucleator

Pincès à goitre – Spatules à goitre
Pinzas para coger el bocio – Sonde para bocio
Pinze per gozzo – Sonde per gozzo



MASTIN

170 mm – 6½"	tk49905-17
--------------	-------------------

1:2

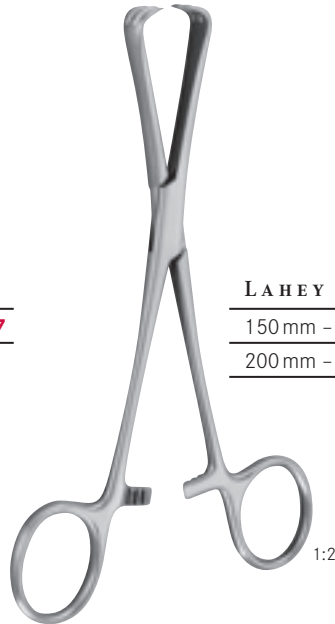

LAHEY

150 mm – 6"	tk49900-15
200 mm – 8"	tk49900-20

1:2



KOCHER

150 mm – 6"	tk49925-15	tk49927-15
160 mm – 6¼"	tk49925-16	tk49927-16

mit Loch
with hole
 avec trou
con orificio
 con foro

Katheterzangen
Catheter forceps

Pinces pour cathéters
Pinzas para catéteres
Pinze per catetere

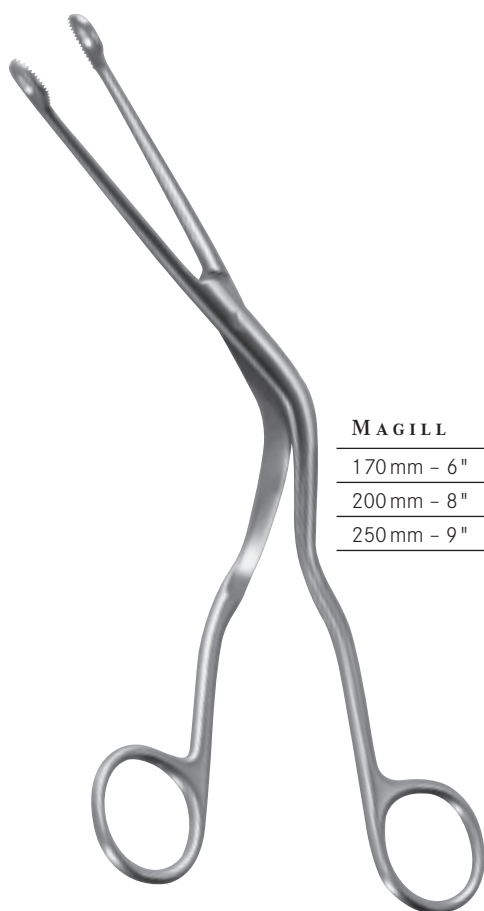

MAGILL	1:1	1:1	1:1
170 mm - 6"	tk 5240-17		
200 mm - 8"		tk 5230-20	
250 mm - 9"			tk 5220-25

Trokare
Trocars

Trocarts
Trócares
Trequarti



LANDAU

1:2

	2 mm Ø
160 mm - 6¼"	tk 6210-16



PIERCE

1:2

	170 mm - 6¾"
3 mm Ø	tk 6225-03
4 mm Ø	tk 6225-04
5 mm Ø	tk 6225-05



KRAUSE

1:2

	5.5 mm Ø
150 mm - 6"	tk 6230-15



COAKLEY

1:2

	2.25 mm Ø
160 mm - 6¼"	tk 6235-16

Saug- und Spülkanülen
Suction and irrigation cannulas

Canules pour aspiration et lavage
Canulas para aspiracion y lavado
Cannule per aspirazione e lavaggio



YANKAUER

270 mm - 10 3/4"

tk 6350-27



1:3

tk 6350-02



EICKEN

2.5 mm Ø

tk 6383-01

tk 6383-02

3.0 mm Ø

tk 6383-04

tk 6383-05

leicht gebogen

stark gebogen

slightly curved

strongly curved

légèrement courbé

très courbé

ligeramente curvada

muy curvada

leggermente curva

fortemente curva



LUER-
LOCK

3.0 mm Ø

tk 6381-00



LUER-
LOCK

2.5 mm Ø

tk 6381-01

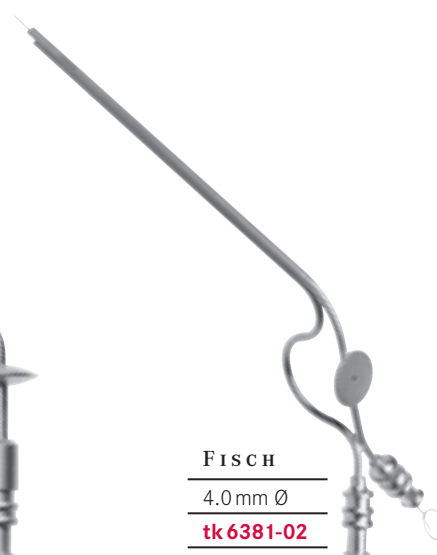

FISCH

4.0 mm Ø

tk 6381-02

Saug- und Spülkanülen
Suction and irrigation cannulas

Canules pour aspiration et lavage
Canulas para aspiracion y lavado
Cannule per aspirazione e lavaggio



1:2

PLESTER

		170 mm - 6¾"
2 mm Ø	6 Charr./Fr.	tk 25229-06
2½ mm Ø	7 Charr./Fr.	tk 25229-07
2⅔ mm Ø	8 Charr./Fr.	tk 25229-08
3 mm Ø	9 Charr./Fr.	tk 25229-09
3½ mm Ø	10 Charr./Fr.	tk 25229-10
3⅔ mm Ø	11 Charr./Fr.	tk 25229-11
4 mm Ø	12 Charr./Fr.	tk 25229-12
5 mm Ø	15 Charr./Fr.	tk 25229-15

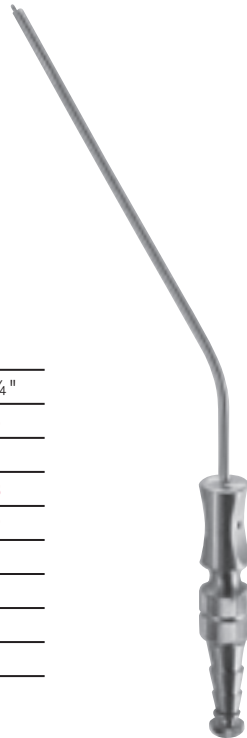

1:2

FRAZIER

		170 mm - 6¾"
2 mm Ø	6 Charr./Fr.	tk 25230-06
2½ mm Ø	7 Charr./Fr.	tk 25230-07
2⅔ mm Ø	8 Charr./Fr.	tk 25230-08
3 mm Ø	9 Charr./Fr.	tk 25230-09
3½ mm Ø	10 Charr./Fr.	tk 25230-10
4 mm Ø	12 Charr./Fr.	tk 25230-12
5 mm Ø	15 Charr./Fr.	tk 25230-15



1:2

ADSON

		210 mm - 8¼"
4 mm Ø	12 Charr./Fr.	tk 25235-04
5 mm Ø	15 Charr./Fr.	tk 25235-05



1:2

200 mm - 8" **tk 51645-20**

Saug-Raspatorium - biegsam, scharf
Suction raspatory - malleable, sharp

Rugine aspirante - flexible, tranchant
Legra aspiradora - maleable y agudo
Elevatore-aspiratore - flessibile, tagliente

Watteträger
Cotton applicators

Porte-cotons
Porta-algodones
Portacotoni

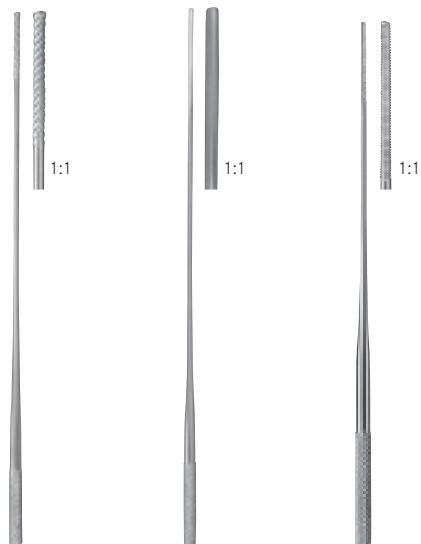

FARRELL-LATHBURY

120 mm - 4¾"	0.9 mm Ø	tk 19009-12	tk 19109-12	tk 19209-12
140 mm - 5½"	0.9 mm Ø	tk 19009-14	tk 19109-14	tk 19209-14
165 mm - 6¼"	1.1 mm Ø	tk 19009-16	tk 19109-16	tk 19209-16
180 mm - 7"	1.2 mm Ø	tk 19009-18	tk 19109-18	tk 19209-18
230 mm - 9"	1.3 mm Ø	tk 19009-23	tk 19109-23	tk 19209-23

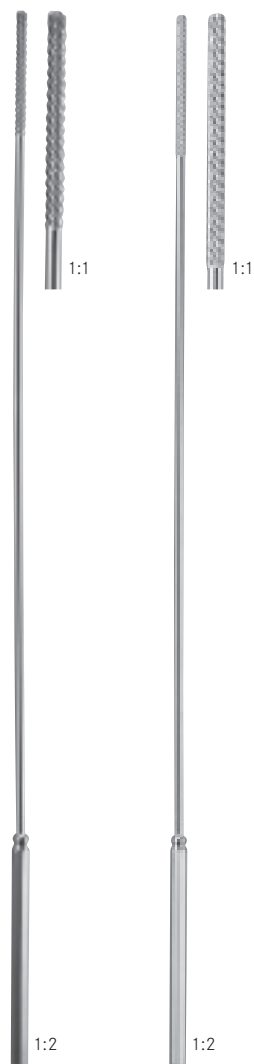

MOD. MARTIN

	1.2 mm Ø	1.5 mm Ø	1.5 mm Ø
120 mm - 4¾"	tk 19312-12	tk 19315-12	tk 19415-12
140 mm - 5½"	tk 19312-14	tk 19315-14	tk 19415-14
160 mm - 6¼"	tk 19312-16	tk 19315-16	tk 19415-16
180 mm - 7"	tk 19312-18	tk 19315-18	tk 19415-18

	2.5 mm Ø	2.5 mm Ø
280 mm - 11"	tk 19460-28	tk 19470-28

Watteträger
Cotton applicators

Porte-cotons
Porta- algodones
Portacotoni

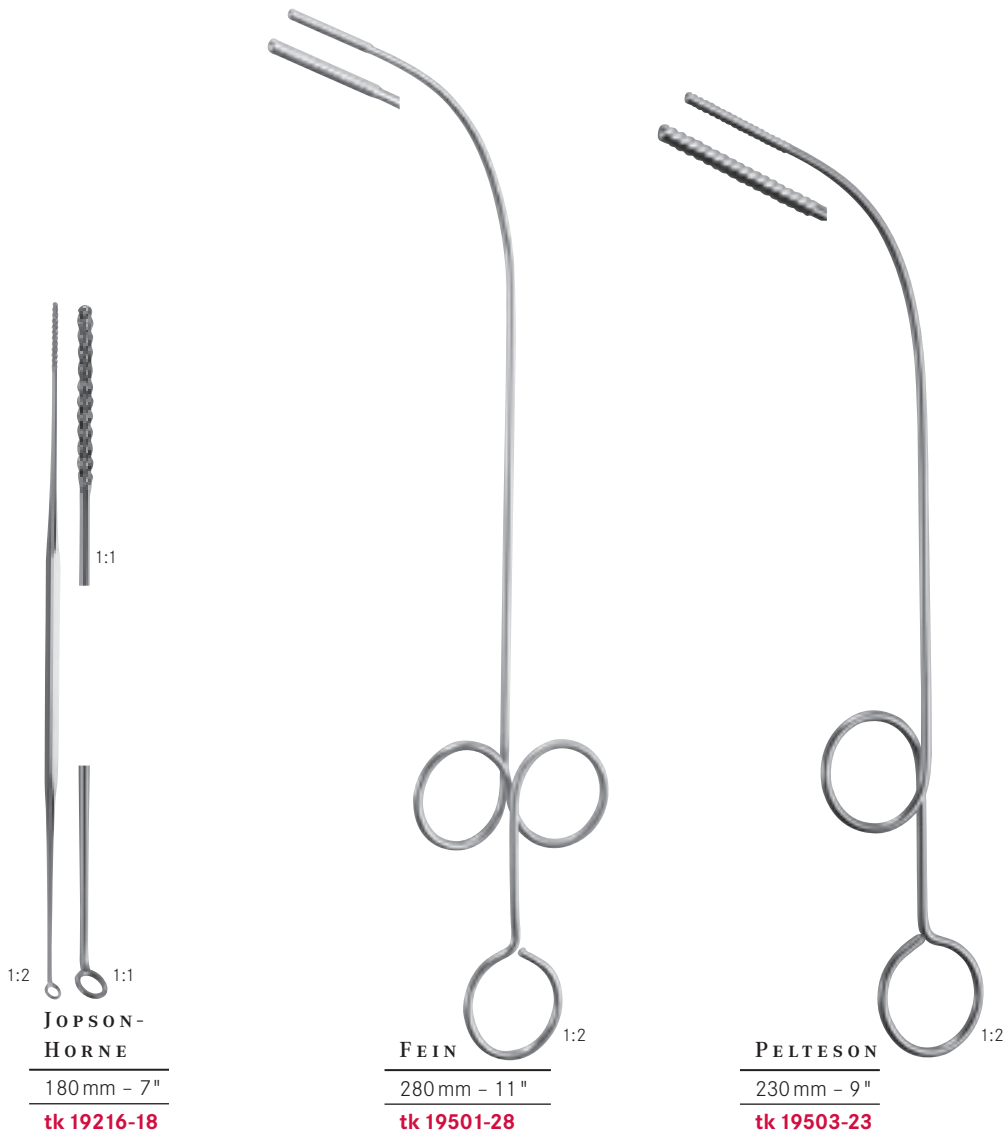

Skalpelli
Scalpel handles

Manches pour bistouri
Mangos de bisturí
Manici per bisturi



Für Klagen Fig. 18 - 25
For blades Fig. 18 - 25
Pour lames Fig. 18 - 25
Para hojas Fig. 18 - 25
Per lame Fig. 18 - 25



STANDARD

Fig. 4

tk 7100-04

Fig. 4 L

tk 7101-04

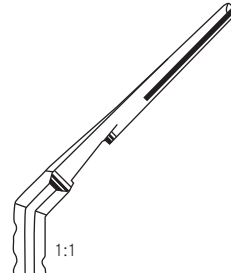

Fig. 4 L

tk 7102-04

abgewinkelt
angled on flat
coudé sur le plat
angulado
angolato



COLLIN

Fig. 8

tk 7105-08

hohl
hollow
creux
hueco
cavo

Skalpellgriffe
Scalpel handles

Manches pour bistouri
Mangos de bisturí
Manici per bisturi

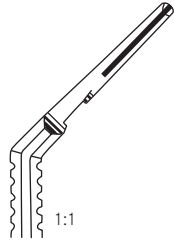

Fig. 3 L

tk 7112-03

abgewinkelt
angled on flat
coudé sur le plat
angulado
angolato



Für Klängen Fig. 10 - 15
For blades Fig. 10 - 15
Pour lames Fig. 10 - 15
Para hojas Fig. 10 - 15
Per lame Fig. 10 - 15



Fig. 3
tk 7110-03



Fig. 3 L
tk 7111-03



Fig. 7K
tk 7110-71



Fig. 7
tk 7110-07



Fig. 3 grad.
tk 7113-05

graduirt
graduated
gradu e
graduado
graduato



Fig. 3 R
tk 7115-03



Fig. 3 RG
tk 7116-03

Skalpellsklingen | Lames de bistouris
 Scalpel blades | Hojas de bisturí
 Lame per bisturi



Packung mit 100 Stück
 Package of 100 pieces
 Paquet de 100 pièces
 Paquetes de 100 piezas
 Confezione da 100 pezzi

! Die abgebildeten Klingen sind steril
 The blades on this page are sterile
 Les lames de cette page sont stériles
 Las hojas de esta página son estériles
 Le lame illustrate sono sterili

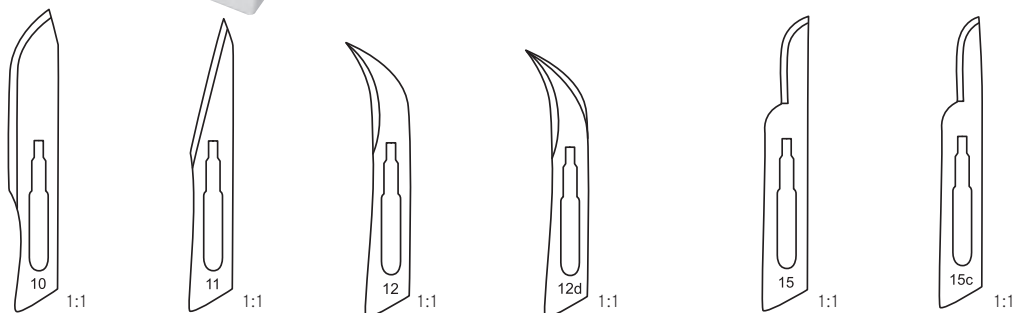

Fig. 10	Fig. 11	Fig. 12	Fig. 12d	Fig. 15	Fig. 15c
tk 7210-10T	tk 7210-11T	tk 7210-12T	tk 7210-12DT	tk 7210-15T	tk 7210-15CT

doppelschneidend
 double cutting edge
 double tranchante
 corta doble
 a doppio taglio

passend für Griffe: tk 7110-03, tk 7111-03, tk 7110-07, tk 7110-71, tk 7112-03, tk 7113-03, tk 7115-03, tk 7116-03
 for handles: tk 7110-03, tk 7111-03, tk 7110-07, tk 7110-71, tk 7112-03, tk 7113-03, tk 7115-03, tk 7116-03
 pour manches: tk 7110-03, tk 7111-03, tk 7110-07, tk 7110-71, tk 7112-03, tk 7113-03, tk 7115-03, tk 7116-03
 para mangos: tk 7110-03, tk 7111-03, tk 7110-07, tk 7110-71, tk 7112-03, tk 7113-03, tk 7115-03, tk 7116-03
 per manici: tk 7110-03, tk 7111-03, tk 7110-07, tk 7110-71, tk 7112-03, tk 7113-03, tk 7115-03, tk 7116-03

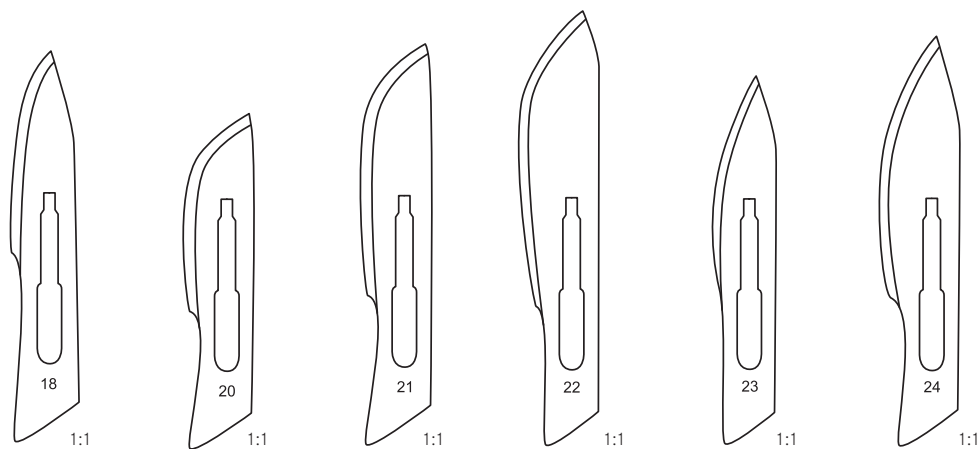

Fig. 18	Fig. 20	Fig. 21	Fig. 22	Fig. 23	Fig. 24
tk 7210-18T	tk 7210-20T	tk 7210-21T	tk 7210-22T	tk 7210-23T	tk 7210-24T

passend für Griffe: tk 7100-04, tk 7101-04, tk 7102-04, tk 7105-08
 for handles: tk 7100-04, tk 7101-04, tk 7102-04, tk 7105-08
 pour manches: tk 7100-04, tk 7101-04, tk 7102-04, tk 7105-08
 para mangos: tk 7100-04, tk 7101-04, tk 7102-04, tk 7105-08
 per manici: tk 7100-04, tk 7101-04, tk 7102-04, tk 7105-08

Mikro-Klingenhalter – Mikro-Klingen
Micro-blade holder – Micro-blades

Porte micro-lames – Micro-lames
Porta para micro-hojas – Micro-hojas
 Porta micro-lame – Micro-lame



1:1

135 mm – 5¼"

tk 7120-13

Titan
Titanium
 Titan
Titaneo
 Titanio



1:1

Fig. 3

tk 7121-03



1:1

Fig. 4

tk 7121-04



1:1

Fig. 7

tk 7121-07



1:1

Fig. 9

tk 7121-09

Mikro-Klingen – Packung mit 25 Stück
Micro-blades – package of 25 pieces

Micro-lames – paquet de 25 pièces

Micro-hojas – paquete de 25 piezas

Micro-lame – confezione da 25 pezzi



Die abgebildeten Klingen sind steril.
The blades on this page are sterile.

Les lames de cette page sont stériles.
Las hojas de esta página son estériles.
 Le lame illustrate sono sterili.

Dermatome – Transplantationsmesser | **Dermatomes – Bistouries pour transplantation**
Dermatomes – Transplantation knives | **Dermatomos – Cuchillos para transplantaciones**
Dermatomi – Coltello per trapianto



THIERSCH

1:2

200 mm – 8"

tk 7890-20



SCHINK

1:2

300 mm – 12"

tk 7900-00

Komplett mit 1 Klinge und 2 Spannhaltern

Complete with 1 blade and 2 plates

Complet avec 1 lame et 2 plaques

Completo con 1 hoja y 2 placas

Completo con 1 lama e 2 placche



1:2

tk 7901-00

Klinge

Spare blade

Lame de rechange

Hoja de cambio

Lama di ricambio



1:2

tk 7902-00

Spannplatte

Skin fixing plate

Plaque pour tendre la peau

Placa para extender la piel

Placca per stendere la pelle



Die abgebildeten Klagen werden nicht steril ausgeliefert.
 The blades on this page are not sterile.

Les lames de cette page ne sont pas stériles.

Las hojas de esta página no son estériles.

Le lame illustrate non sono sterili.



Elektrische Dermatome auf Anfrage lieferbar.
 Electrical dermatomes upon request.

Dermatomes électriques sur demande.

Dermatomos electricos según demanda.

Dermatomi elettrici possono essere forniti a richiesta.

Dermatome
Dermatomes

Dermatomes
Dermatomos
Dermatomi



tk 7908-00

Ersatzklinge für tk 7905-00, tk 7907-00 – Packung mit 10 Stück
spare blade for tk 7905-00, tk 7907-00 – package of 10 pieces

lame de rechange pour tk 7905-00, tk 7907-00 – paquet de 10 pièces
hoja de cambio para tk 7905-00, tk 7907-00 – paquete de 10 piezas
lama di ricambio per tk 7905-00, tk 7907-00 – confezione da 10 pezzi

HUMBY

310 mm – 12¼"

tk 7905-00

komplett mit 1 Klinge
complete with 1 blade

complet avec 1 lame
completo con 1 hoja
completo con 1 lama

1:2



WATSON

300 mm – 12"

tk 7907-00

komplett mit 1 Klinge, Stange starr
complete with 1 blade, fixed bar

complet avec 1 lame, tige fix
completo con 1 hoja, barra fijada
completo con 1 lama, barra fissa

1:2



SILVER

190 mm – 7½"

tk 7904-00

1:2



Die abgebildeten Klingen werden nicht steril ausgeliefert.

The blades on this page are not sterile.

Les lames de cette page ne sont pas stériles.

Las hojas de esta página no son estériles.

Le lame illustrate non sono sterili.



Elektrische Dermatome auf Anfrage lieferbar.

Electrical dermatomes upon request.

Dermatomes électriques sur demande.

Dermatomos eléctricos según demanda.

Dermatomi elettrici possono essere forniti a richiesta.

Chirurgische Scheren
Operating scissors

Ciseaux à chirurgie
Tijeras para cirugía
Forbici per chirurgia



STANDARD	Fig. 1	Fig. 2	Fig. 3
105 mm - 4 1/4"	tk 8023-10	tk 8024-10	tk 8025-10
115 mm - 4 1/2"	tk 8023-11	tk 8024-11	tk 8025-11
130 mm - 5"	tk 8023-13	tk 8024-13	tk 8025-13
145 mm - 5 3/4"	tk 8023-14	tk 8024-14	tk 8025-14
155 mm - 6"	tk 8023-15	tk 8024-15	tk 8025-15
165 mm - 6 1/2"	tk 8023-16	tk 8024-16	tk 8025-16
175 mm - 7"	tk 8023-17	tk 8024-17	tk 8025-17
185 mm - 7 1/4"	tk 8023-18	tk 8024-18	tk 8025-18
200 mm - 8"	tk 8023-20	tk 8024-20	tk 8025-20



STANDARD	Fig. 1	Fig. 2	Fig. 3
115 mm - 4 1/2"	tk 8033-11	tk 8034-11	tk 8035-11
130 mm - 5"	tk 8033-13	tk 8034-13	tk 8035-13
145 mm - 5 3/4"	tk 8033-14	tk 8034-14	tk 8035-14
155 mm - 6"	tk 8033-15	tk 8034-15	tk 8035-15
165 mm - 6 1/2"	tk 8033-16	tk 8034-16	tk 8035-16
175 mm - 7"	tk 8033-17	tk 8034-17	tk 8035-17
185 mm - 7 1/4"	tk 8033-18	tk 8034-18	tk 8035-18
200 mm - 8"	tk 8033-20	tk 8034-20	tk 8035-20

Chirurgische Scheren
Operating scissors

Ciseaux à chirurgie
Tijeras para cirugía
Forbici per chirurgia



GRAZIL

	Fig. 1	Fig. 2	Fig. 3
130 mm - 5"	tk 8043-13	tk 8044-13	tk 8045-13
145 mm - 5¾"	tk 8043-14	tk 8044-14	tk 8045-14



GRAZIL



	Fig. 1	Fig. 2	Fig. 3
130 mm - 5"	tk 8053-13	tk 8054-13	tk 8055-13
145 mm - 5¾"	tk 8053-14	tk 8054-14	tk 8055-14





Chirurgische Scheren – Präparierscheren
 Operating scissors – Dissecting scissors

Ciseaux à chirurgie – Ciseaux à dissection
 Tijeras para cirugía – Tijeras de disección
 Forbici per chirurgia – Forbici per dissezione



METZENBAUM			
	Fig. 1	Fig. 2	Fig. 3
115 mm - 4½"	tk 8323-11		
145 mm - 5¾"	tk 8323-14	tk 8324-14	tk 8325-14



METZENBAUM			
	Fig. 1	Fig. 2	Fig. 3
115 mm - 4½"	tk 8333-11		
145 mm - 5¾"	tk 8333-14	tk 8334-14	tk 8335-14

Chirurgische Scheren – Präparierscheren
Operating scissors – Dissecting scissors

Ciseaux à chirurgie – Ciseaux à dissection
Tijeras para cirugía – Tijeras de disección
 Forbici per chirurgia – Forbici per dissezione



METZENBAUM-
NELSON

	Fig. 1	Fig. 2	Fig. 3
180 mm – 7"	tk 8343-18	tk 8344-18	tk 8345-18
200 mm – 8"	tk 8343-20	tk 8344-20	tk 8345-20
230 mm – 9"	tk 8343-23	tk 8344-23	tk 8345-23
250 mm – 9¾"	tk 8343-25	tk 8344-25	tk 8345-25
280 mm – 11"	tk 8343-28	tk 8344-28	tk 8345-28
300 mm – 12"	tk 8343-30	tk 8344-30	tk 8345-30



METZENBAUM-
NELSON

	Fig. 1	Fig. 2	Fig. 3
180 mm – 7"	tk 8353-18	tk 8354-18	tk 8356-18
200 mm – 8"	tk 8353-20	tk 8354-20	tk 8356-20
230 mm – 9"	tk 8353-23	tk 8354-23	tk 8356-23
250 mm – 9¾"	tk 8353-25	tk 8354-25	tk 8356-25
280 mm – 11"	tk 8353-28	tk 8354-28	tk 8356-28
300 mm – 12"	tk 8353-30	tk 8354-30	tk 8356-30

Chirurgische Scheren – Präparierscheren
Operating scissors – Dissecting scissors

Ciseaux à chirurgie – Ciseaux à dissection
Tijeras para cirugía – Tijeras de disección
 Forbici per chirurgia – Forbici per dissezione



METZENBAUM-FINO



1:2



1:2



1:2



1:2

	Fig. 1	Fig. 3	Fig. 1	Fig. 3
145 mm - 5 3/4"	tk 8372-14	tk 8374-14	tk 8373-14	tk 8375-14



METZENBAUM-FINO





180 mm - 7"	tk 8380-18	tk 8381-18	tk 8385-18
220 mm - 8"	tk 8380-20	tk 8381-20	tk 8385-20
230 mm - 9"	tk 8380-23	tk 8381-23	tk 8385-23

S-förmig gebogen
S-curved
 courbes en S
curva en S
 curve a forma di S

Feine Scheren
Fine scissors

Ciseaux fins
Tijeras finas
Forbici fini



		
90 mm - 3½"	tk 8652-09	tk 8653-09
100 mm - 4"	tk 8652-10	tk 8653-10
115 mm - 4½"	tk 8652-11	tk 8653-11







		
SANVENERO		
145 mm - 5¾"	tk 8662-14	tk 8663-14



CONVERSE	
100 mm - 3¾"	tk 9203-10

aufgewinkelt
angled
courbé vers le haut
angulado
angulato



				
LEXER-BABY				
100 mm - 4"	tk 8672-10	tk 8682-10	tk 8673-10	tk 8683-10

gerade
straight
droits
recta
rette

gerade, gezahnt
straight, saw edge
droits, dentelés
recta, dentada
rette, dentate

gebogen
curved
courbes
curva
curve

gebogen, gezahnt
curved, saw edge
courbes, dentelés
curva, dentad
curve, dentate

Fistelscheren
Fistula scissors

Ciseaux pour fistules
Tijeras para fistulas
Forbici per fistole

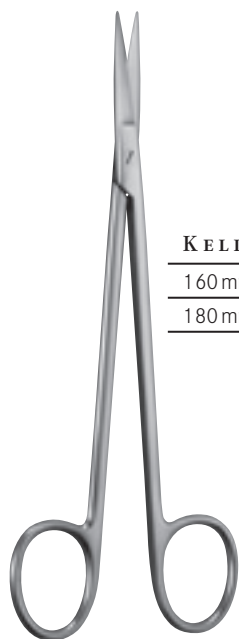

KELLY

160 mm - 6¼"	tk 8462-16	tk 8463-16
180 mm - 7"	tk 8462-18	tk 8463-18

Enukleationsscheren
Enucleation scissors

Ciseaux à énucléation
Tijeras para enucleación
Forbici per enucleazione

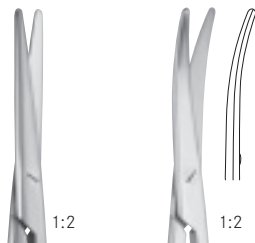

LANDOLDT

125 mm - 5"	tk 8612-12	tk 8614-12
-------------	-------------------	-------------------



1:2

110 mm - 4¼"	tk 9485-11
--------------	-------------------

1:2



1:2

CHADWICK

110 mm - 4¼"	tk 9492-11
--------------	-------------------

1:2

Tonsillenscheren
Tonsil scissors

Ciseaux pour amygdales
Tijeras para amigdales
Forbici per tonsille

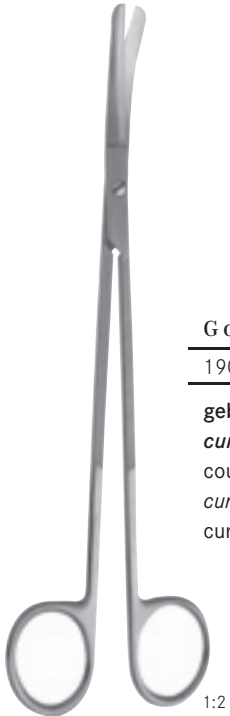

GOOD

190 mm - 7½" **tk 8867-19**

gebogen
curved
courbes
curva
curve

1:2

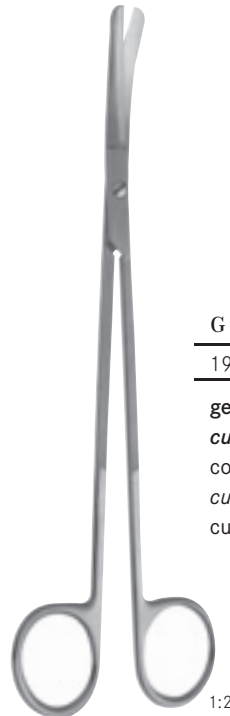

GOOD-SCHWECKENDICK

190 mm - 7½" **tk 8872-19**

gebogen, gezahnt
curved, saw edge
courbes, dentelés
curva, dentad
curve, dentate

1:2



BOETCHER

180 mm - 7" **tk 8832-18**

1:2



SURGERY



Bitte fordern Sie unseren Katalog der Plastischen Chirurgie an.
Please ask for our plastic surgery catalogue.

Veuillez demander pour notre catalogue chirurgie plastique.

Por favor preguntan para el catalogo cirugía plastica.

Per favore domandate per il nostro catalogo chirurgia plastica.

Anatomische Pinzetten - Chirurgische Pinzetten
Dressing forceps - Dissecting forceps

Pinces à dissection - Pinces à dissection à griffes
Pinzas de disección - Pinzas de disección con dientes
 Pinze per dissezione - Pinze per dissezione con denti



SEMKEN

125 mm - 5"	tk 10300-12	tk 11300-12
150 mm - 6"	tk 10300-15	tk 11300-15

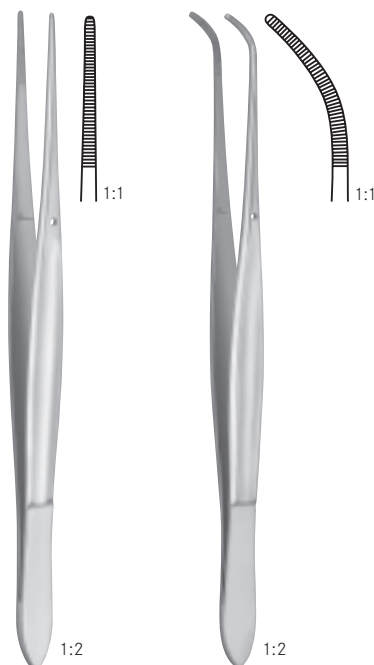

CUSHING

175 mm - 7"	tk 10400-17	tk 10401-17
175 mm - 7"	tk 10402-17 TC	



MC INDOE

150 mm - 6"	tk 10550-15
150 mm - 6"	tk 11640-15 TC

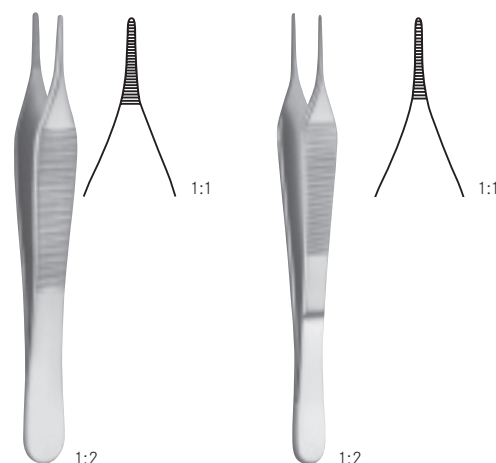

ADSON

120 mm - 4¾"	tk 10500-12
150 mm - 6"	tk 10500-15
120 mm - 4¾"	tk 10502-12 TC
150 mm - 6"	tk 10502-15 TC

MICRO-ADSON

tk 10503-12
tk 10503-15

Anatomische Pinzetten - Chirurgische Pinzetten
Dressing forceps - Dissecting forceps

Pinces à dissection - Pinces à dissection à griffes
Pinzas de disección - Pinzas de disección con dientes
Pinze per dissezione - Pinze per dissezione con denti



TAYLOR

175mm - 7"

tk 10310-17

tk 10312-17

tk 10313-17



GERALD

180mm - 7"

tk 10324-18

tk 10325-18

tk 10326-19

Anatomische Pinzetten - Chirurgische Pinzetten
Dressing forceps - Dissecting forceps

Pinces à dissection - Pinces à dissection à griffes
Pinzas de disección - Pinzas de disección con dientes
 Pinze per dissezione - Pinze per dissezione con denti

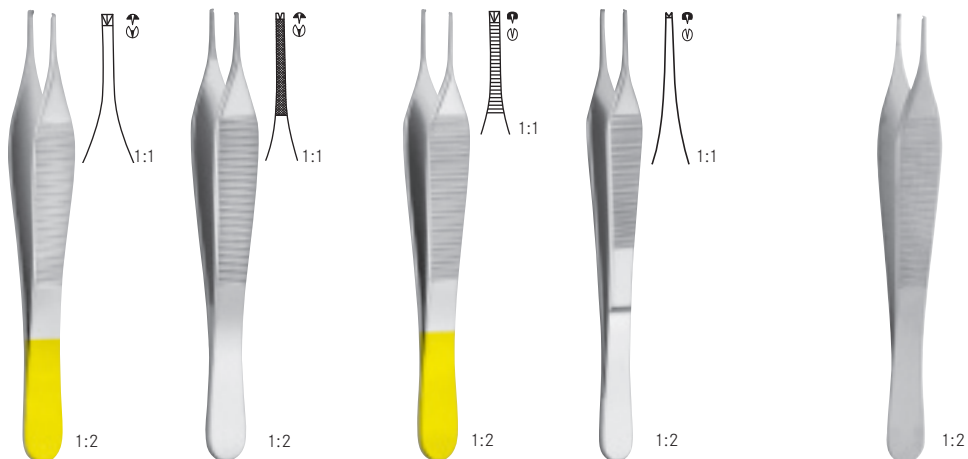

ADSON

120 mm - 4¾"	tk 11200-12	tk 11204-12
150 mm - 6"	tk 11200-15	

ADSON-MICRO

tk 11202-12	tk 11206-12
tk 11202-15	tk 11206-15

ADSON

tk 11206-13
120 mm - 4¾"

mit Fadenplatte 1 mm
with tying platform 1 mm

avec plateforme pour sutures 1 mm
con plataforma para suturas 1 mm
 con piattaforma per sutura 1 mm

120 mm - 4¾"	tk 10504-12 TC	
150 mm - 6"	tk 10504-15 TC	

tk 10506-12 TC	
tk 10506-15 TC	



ADSON BROWN

120 mm - 4¾"	tk 11210-12
120 mm - 4¾"	tk 10508-12 TC



ADSON-GRAEFE

tk 11212-12
120 mm - 4¾"



WANGENSTEEN

150 mm - 6"	tk 10608-15
230 mm - 9"	tk 10608-23



WAUGH

150 mm - 6"	tk 10616-15
200 mm - 8"	tk 10616-20
250 mm - 9¾"	tk 10616-25

Anatomische Pinzetten - Chirurgische Pinzetten
Dressing forceps - Dissecting forceps

Pinces à dissection - Pinces à dissection à griffes
Pinzas de disección - Pinzas de disección con dientes
 Pinze per dissezione - Pinze per dissezione con denti



POTTS-SMITH

180 mm - 7"	tk 11150-18	tk 11151-18
210 mm - 8¼"	tk 11150-21	tk 11151-21
250 mm - 9¾"	tk 11150-25	tk 11151-25



GILLIES

tk 11250-15
150 mm - 6"



BROPHY

200 mm - 8"	tk 11100-20	tk 11101-20
-------------	--------------------	--------------------

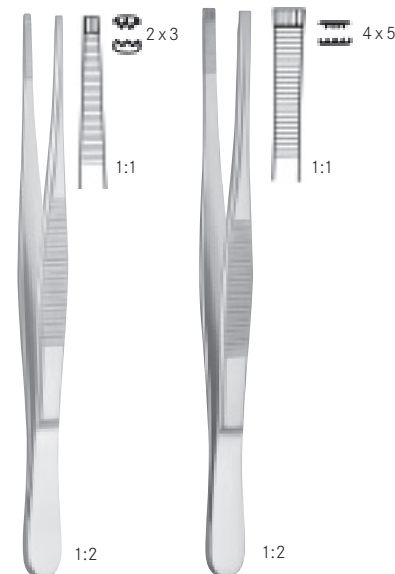

ADLERKREUTZ

150 mm - 6"	tk 11086-15	tk 11087-15
200 mm - 8"	tk 11086-20	tk 11087-20
250 mm - 9¾"		tk 11087-25

Container
Containers
Contenaires
Contenedores
Container



Container und Zubehör, siehe unseren Spezial Katalog
Containers and accessories, see our special catalogue
Contenaires et accessoires, voir notre catalogue special
Contenedores y accesorios, ver nuestro catálogo especial
Container ed accessori riferirsi al nostro specifico catalogo

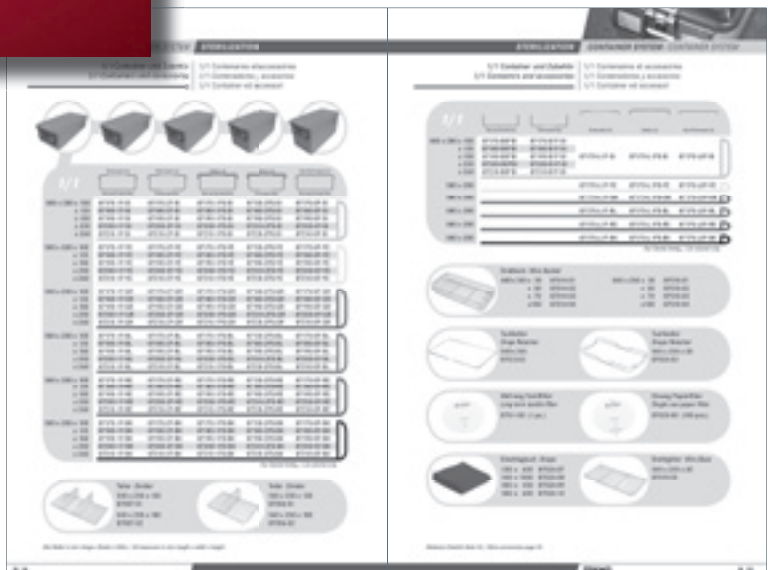
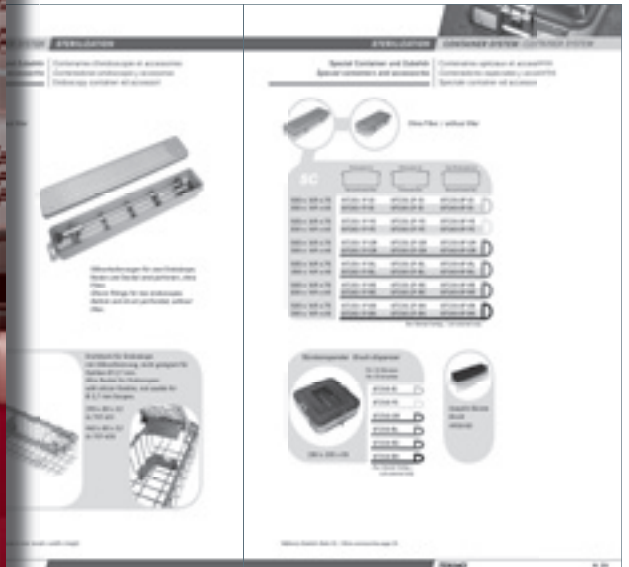

Anatomische Pinzetten
Dressing forceps

Pinces à dissection
Pinzas de disección
Pinze anatomiche



BROPHY

200 mm - 8"

tk 10600-20

tk 10601-20



DUEHRSEN

200 mm - 8"

tk 10604-20

Atraumatische Pinzetten
Atraumatic tissue forceps

Pinces atraumatiques
Pinzas de disección atraumáticas
Pinze per dissezione atraumatiche

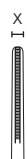

DE BAKEY

	x = 1.5 mm	x = 2.0 mm	x = 2.7 mm	x = 3.5 mm
120 mm - 4¾"	tk 11960-12			
145 mm - 5¾"	tk 11960-14	tk 11964-14		
160 mm - 6¼"	tk 11960-16	tk 11964-16	tk 11966-16	tk 11965-16
200 mm - 8"	tk 11960-20	tk 11964-20	tk 11966-20	tk 11965-20
240 mm - 9½"	tk 11960-24	tk 11964-24	tk 11966-24	tk 11965-24
300 mm - 12"		tk 11964-30	tk 11966-30	tk 11965-30
350 mm - 14"				tk 11965-35

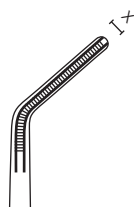
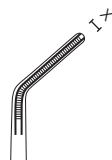

	x = 1.5 mm	x = 2.0 mm
145 mm - 5¾"	tk 11967-14	
160 mm - 6¼"		tk 11967-16
200 mm - 8"		tk 11967-20
240 mm - 9½"		tk 11967-24
300 mm - 12"		tk 11967-30

Atraumatische Pinzetten
Atraumatic tissue forceps

Pinces atraumatiques
Pinzas de disección atraumáticas
Pinze per dissezione atraumatiche

TITAN TK

ATRAUM TK



DE BAK EY	x = 1.2 mm	x = 1.5 mm	x = 1.8 mm	x = 2.0 mm	x = 2.8 mm
160 mm - 6¼"	tk 11970-16	tk 11971-16	tk 11972-16	tk 11975-16	tk 11976-16
200 mm - 8"	tk 11970-20	tk 11971-20	tk 11972-20	tk 11975-20	tk 11976-20
240 mm - 9½"	tk 11970-24	tk 11971-24	tk 11972-24	tk 11975-24	tk 11976-24

Gefäßklemmen
Haemostatic forceps

Serre-fines
Serrafinas
Serrafine



DIEFFENBACH

35 mm - 1½"	tk 11930-03	tk 11931-03
50 mm - 2"	tk 11930-05	tk 11931-05
60 mm - 2¼"	tk 11930-06	tk 11931-06



JOHNS HOPKINS

50 mm - 2"	tk 11935-05
65 mm - 2½"	tk 11935-06
75 mm - 3"	tk 11935-07



DIETRICH

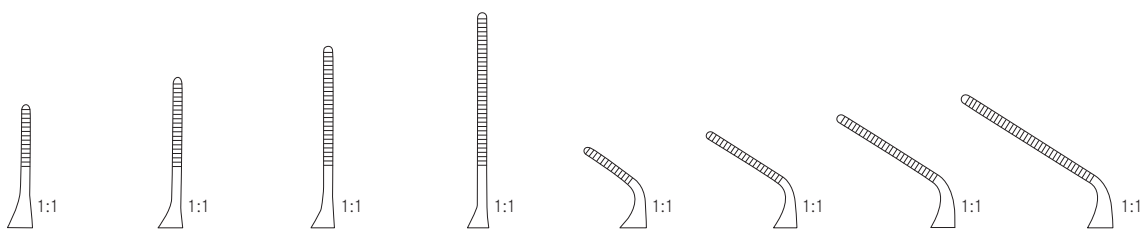

x =	50 mm - 2"	50 mm - 2"	50 mm - 2"	60 mm - 2¼"	50 mm - 2"	50 mm - 2"	50 mm - 2"	60 mm - 2¼"
y =	8 mm	12 mm	16 mm	20 mm	8 mm	12 mm	16 mm	20 mm
	tk 11940-08	tk 11940-12	tk 11940-16	tk 11940-20	tk 11941-08	tk 11941-12	tk 11941-16	tk 11941-20

x = Länge y = geriefte Maullänge
 Length serrated jaw part
 Longueur partie striée du mors
 Longitud parte estriada de la boca
 Lunghezza morso zigrinato



Atraumatische Klemmen sind abgebildet von Seite 383 bis 418

Atraumatic forceps, please see the pages 383 to 418

Pinces atraumatiques, voire pages 383 à 418





Pinzas atraumáticas, ver paginas 383 a 418

Pinze atraumatiche, vedete pagina 383 a 418

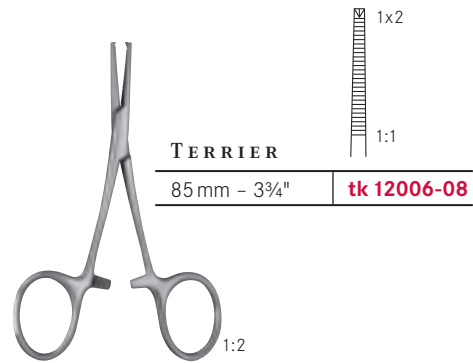
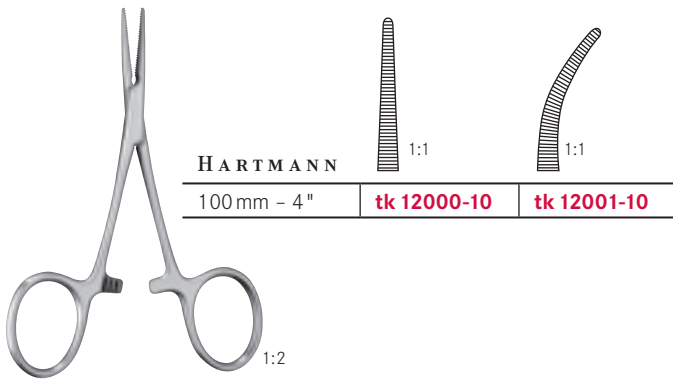
Arterienklemmen
Haemostatic forceps

Pinces hémostatiques
Pinzas hemostáticas
Pinze emostatiche



HALSTED-MOSQUITO				
	125 mm - 5"	tk 12010-12	tk 12011-12	tk 12012-12
140 mm - 5½"	tk 12010-14	tk 12011-14	tk 12012-14	tk 12013-14

1x2

1x2

125 mm - 5"	tk 12110-12	tk 12111-12	tk 12112-12	tk 12113-12
-------------	--------------------	--------------------	--------------------	--------------------

Titan
Titanium
Titane
Titanio
Titanio

1x2

1x2



Arterienklemmen
Haemostatic forceps

Pinces hémostatiques
Pinzas hemostáticas
Pinze emostatiche

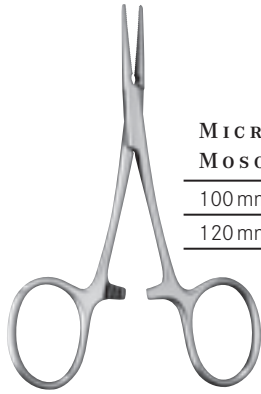

MICRO-
MOSQUITO

100 mm - 4"	tk 12020-10	tk 12021-10	tk 12022-10	tk 12023-10
120 mm - 4¾"	tk 12020-12	tk 12021-12	tk 12022-12	tk 12023-12

1x2

1x2



PROVIDENCE-
HOSPITAL

140 mm - 5½"	tk 12020-14	tk 12021-14
--------------	-------------	-------------

1:2

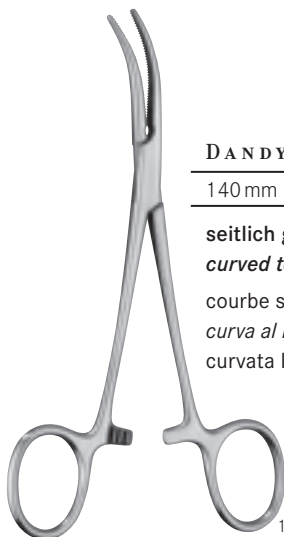

DANDY

140 mm - 5½"	tk 12030-14	tk 12032-14
--------------	-------------	-------------

seitlich gebogen
curved to the side
courbe sur le plat
curva al lado
curvata lateralmente

1x2

1:2

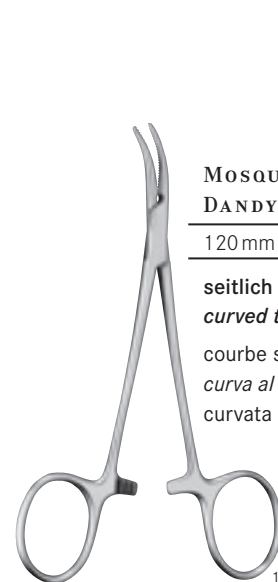

MOSQUITO-
DANDY

120 mm - 4¾"	tk 12031-12
--------------	-------------

seitlich gebogen
curved to the side
courbe sur le plat
curva al lado
curvata lateralmente

1:2

Arterienklemmen
Haemostatic forceps

Pinces hémostatiques
Pinzas hemostáticas
Pinze emostatiche

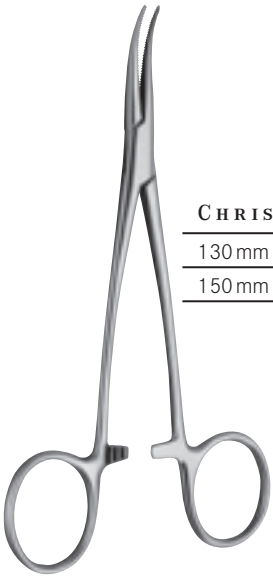

CHRISTOPHE

130 mm - 4"	tk 12039-13
150 mm - 6"	tk 12039-15

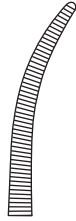

LOVELACE

155 mm - 6"	tk 12195-15	tk 12196-15
-------------	-------------	-------------

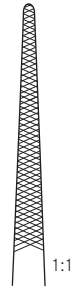
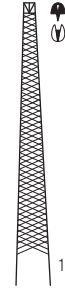

1x2

1:2

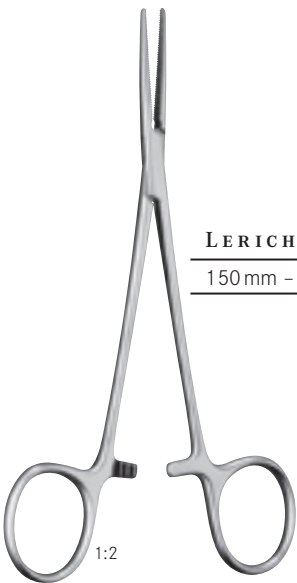

LERICHE

150 mm - 6"	tk 12034-15	tk 12035-15
-------------	-------------	-------------

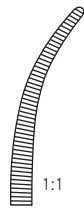
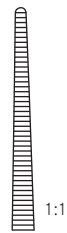

1:1

1:1

1:2



LERICHE

150 mm - 6"	tk 12036-15	tk 12037-15
-------------	-------------	-------------

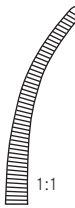
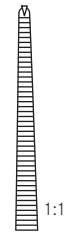

1:1

1:1

1x2

1x2

1:2

Arterienklemmen
Haemostatic forceps

Pinces hémostatiques
Pinzas hemostáticas
Pinze emostatiche

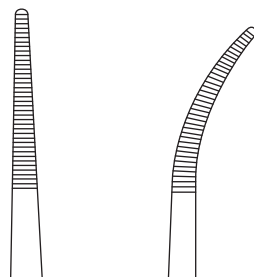

KELLY

140 mm - 5½"	tk 12040-14	tk 12041-14
--------------	-------------	-------------

KELLY-RANKIN

160 mm - 6¼"	tk 12040-16	tk 12041-16
--------------	-------------	-------------

KELLY

140 mm - 5½"	tk 12140-14	tk 12141-14
--------------	-------------	-------------

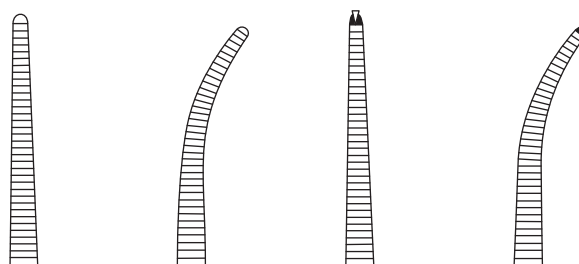

CRILE

140 mm - 5½"	tk 12050-14	tk 12051-14	tk 12052-14	tk 12053-14
--------------	-------------	-------------	-------------	-------------

1x2

1x2

CRILE-RANKIN

160 mm - 6¼"	tk 12050-16	tk 12051-16	tk 12054-16	tk 12055-16
--------------	-------------	-------------	-------------	-------------

1x2

1x2

CRILE

140 mm - 5½"	tk 12250-14	tk 12251-14
--------------	-------------	-------------



Arterienklemmen
Haemostatic forceps

Pinces hémostatiques
Pinzas hemostáticas
Pinze emostatiche

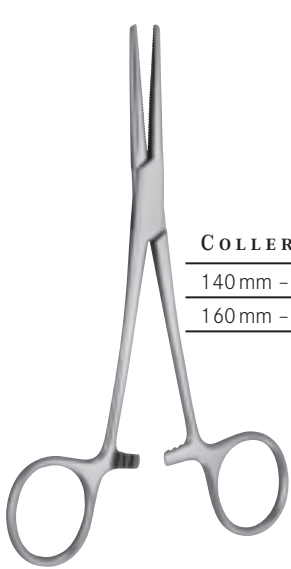

COLLER

140 mm - 5½"	tk 12056-14	tk 12057-14
160 mm - 6¼"	tk 12056-16	tk 12057-16

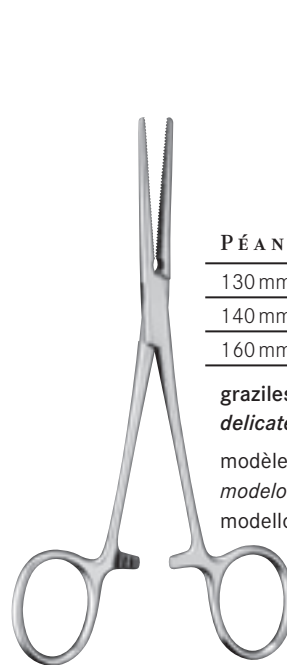
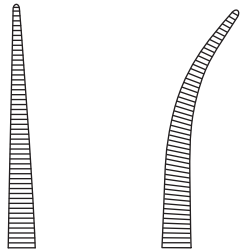

PÉAN

130 mm - 5"	tk 12058-13	tk 12059-13
140 mm - 5½"	tk 12058-14	tk 12059-14
160 mm - 6¼"	tk 12058-16	tk 12059-16

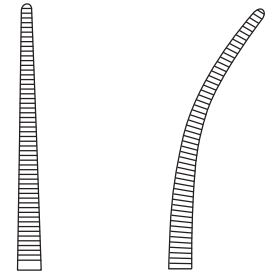

graziles Modell
delicate pattern
modèle délicat
modelo delicado
modello delicato



DUNHILL

125 mm - 5"	tk 12268-12
-------------	--------------------

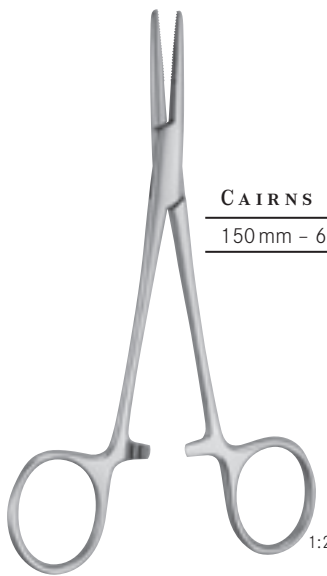
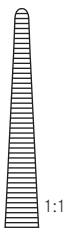

CAIRNS

150 mm - 6"	tk 12269-01	tk 12269-02
-------------	--------------------	--------------------

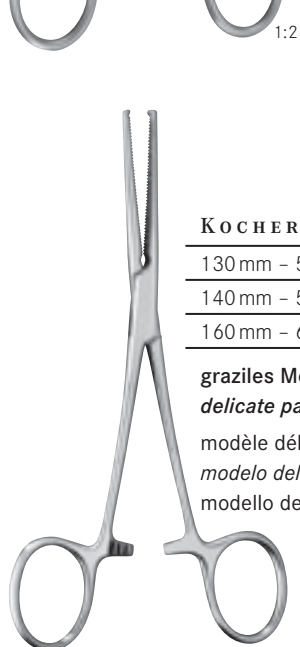
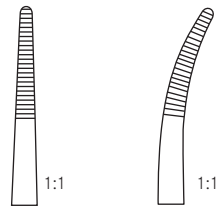

KOCHER

130 mm - 5"	tk 12078-13	tk 12079-13
140 mm - 5½"	tk 12078-14	tk 12079-14
160 mm - 6¼"	tk 12078-16	tk 12079-16

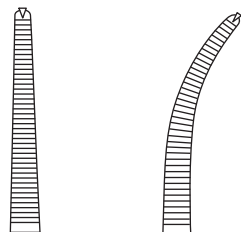

graziles Modell
delicate pattern
modèle délicat
modelo delicado
modello delicato

1x2 1x2

Präparier- und Ligaturklemmen
Dissecting and ligature forceps

Pinces à disséquer et à sutures
Pinzas para preparación y suturas
Pinze per preparazioni e suture

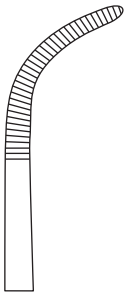
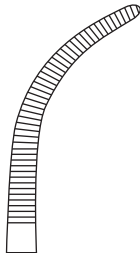
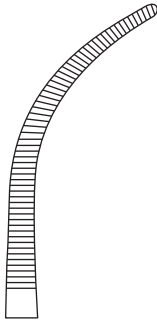
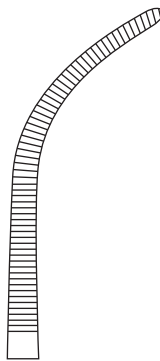

OVERHOLT-
GEISSENDOERFER

				
	Fig. 0	Fig. 1	Fig. 2	Fig. 3
210 mm - 8¼"	tk 12280-21	tk 12281-21	tk 12282-21	tk 12283-21
270 mm - 10¾"	tk 12280-27	tk 12281-27	tk 12282-27	tk 12283-27

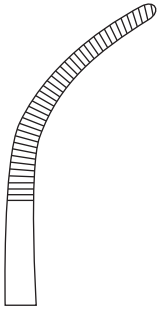
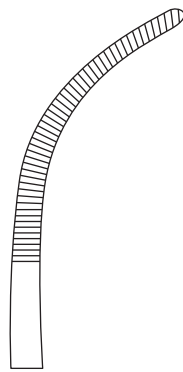
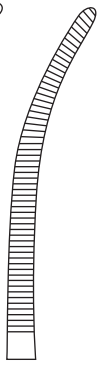
			
	Fig. 4	Fig. 5	Fig. 6
210 mm - 8¼"	tk 12284-21	tk 12285-21	tk 12286-21
270 mm - 10¾"	tk 12284-27	tk 12285-27	tk 12286-27

Präparier- und Ligaturklemmen
Dissecting and ligature forceps

Pincès à disséquer et à sutures
Pinzas para preparación y suturas
Pinze per preparazioni e suture



GEMINI

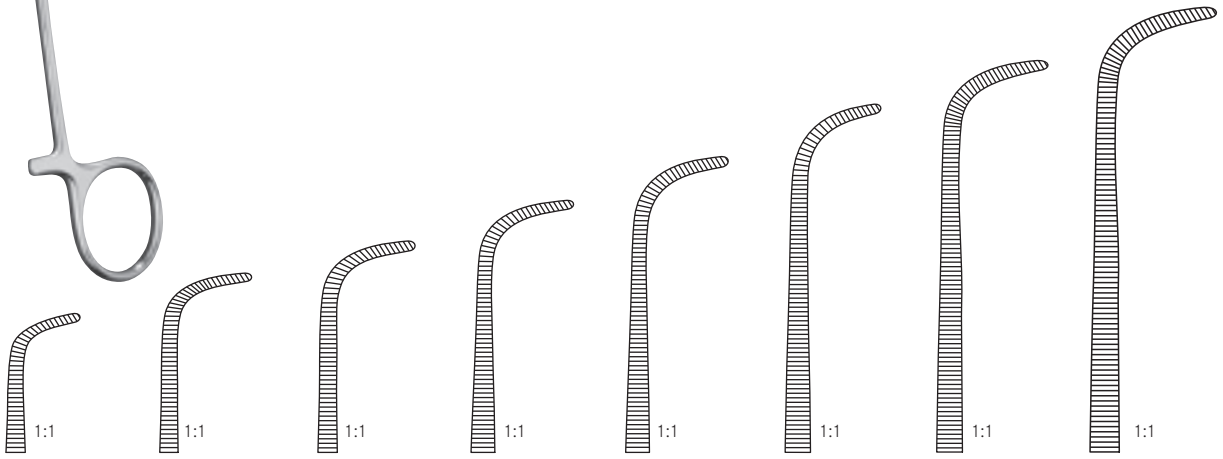

130 mm - 5"	160 mm - 6¼"	180 mm - 7"	200 mm - 8"	230 mm - 9"	250 mm - 9¾"	280 mm - 11"	350 mm - 14"
tk 12290-13	tk 12290-16	tk 12290-18	tk 12290-20	tk 12290-23	tk 12290-25	tk 12290-28	tk 12290-35



MINI-GEMINI

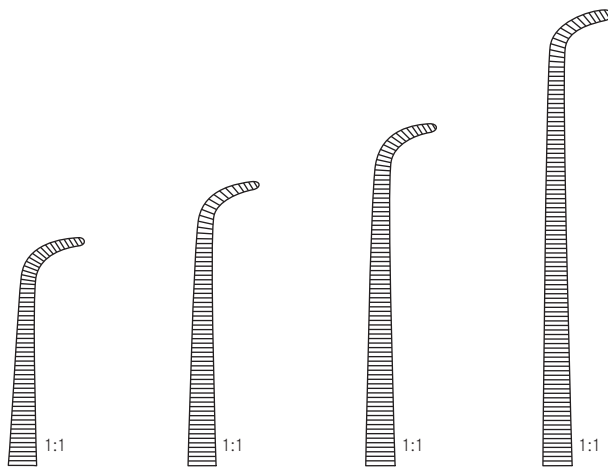

180 mm - 7"	220 mm - 8¾"	250 mm - 9¾"	280 mm - 11"
tk 12291-18	tk 12291-22	tk 12291-25	tk 12291-28

Gewebe- und Darmfasszangen
Tissue and intestinal holding forceps

Pinces intestinales et de tissue
Pinzas para tejidos y intestinos
Pinze per tessuti ed intestinali

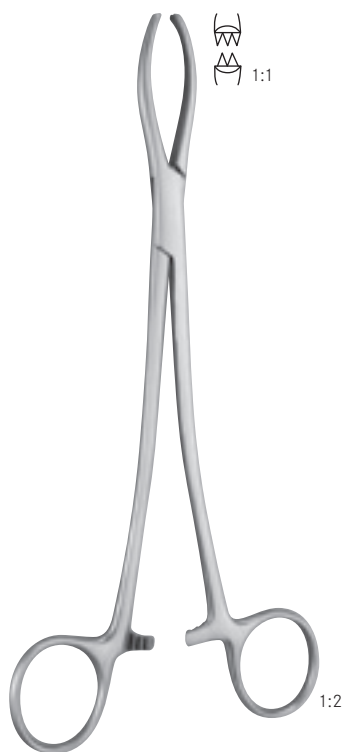

LITTLEWOOD

190mm - 7½" tk 11955-19

Zähne 2x3
Teeth

Dents
Dientes
Denti



BOYS-ALLIS

150mm - 6" tk 28210-15

Zähne 5x6
Teeth

Dents
Dientes
Denti



JUDD-ALLIS

150mm - 6" tk 28250-15

190mm - 7½" tk 28250-19

Zähne 3x4
Teeth

Dents
Dientes
Denti



BABCOCK

160mm - 6¼"	200mm - 8"
tk 28285-16	tk 28285-20

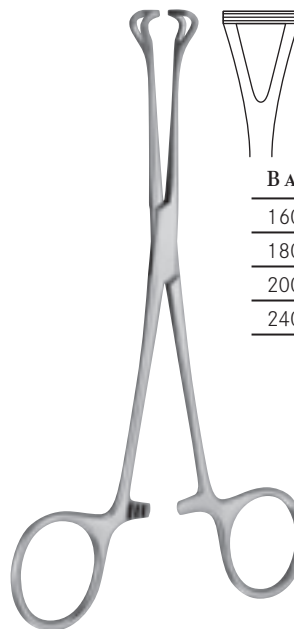

BABCOCK

160mm - 6¼"	tk 28280-16
180mm - 7"	tk 28280-18
200mm - 8"	tk 28280-20
240mm - 9½"	tk 28280-24

Gewebe- und Darmfazzangen
Tissue and intestinal holding forceps

Pinces intestinales et de tissue
Pinzas para tejidos y intestinos
Pinze per tessuti ed intestinali



ALLIS-BABY

130 mm - 5" **tk 28100-14**

Zähne 4x5
Teeth

Dents
Dientes
Denti



ALLIS

150 mm - 6"	tk 28140-15	tk 28160-15
190 mm - 7½"		tk 28160-19
250 mm - 9¾"		tk 28160-25

Zähne 4x5 5x6
Teeth
Dents
Dientes
Denti



ALLIS-ADAIR

155 mm - 6" **tk 28167-15**

Zähne 10x11
Teeth

Dents
Dientes
Denti



THOMS-ALLIS

200 mm - 8" **tk 28180-20**

6x7



LOCKWOOD

200 mm - 8" **tk 28190-20**



WILLIAMS

160 mm - 6¼" **tk 28192-16**

Tuchklemmen
Towel forceps

Pinces à champs
Pinzas de campo
Pinze fissateli

**BERNHARD**

100 mm - 4"	tk 12800-10
120 mm - 4¾"	tk 12800-12
140 mm - 5½"	tk 12800-14
165 mm - 6½"	tk 12800-16
180 mm - 7"	tk 12800-18

**BACKHAUS**

90 mm - 3½"	tk 12805-09
110 mm - 4¼"	tk 12805-11
130 mm - 5"	tk 12805-13
150 mm - 6"	tk 12805-15

**ROEDER**

130 mm - 5"	tk 12802-13
150 mm - 6"	tk 12802-15



110 mm - 4"	tk 12807-11
-------------	--------------------

mit Schlauchhalter
with clip for tube
avec porte-tuyeau
con soporte de tubo
con supporto per tubo

Tuchklemmen
Towel forceps

Pinces à champs
Pinzas de campo
Pinze fissateli



ROBIN

135 mm - 5¼" tk 12809-13

mit Schlauchhalter bis 5 mm Ø
with clip for tube up to 5 mm Ø

avec porte-tuyeau à 5 mm Ø
con soporte de tubo hasta 5 mm Ø
con supporto per tubo fino a 5 mm Ø



JONES

50 mm - 2" tk 12810-05
90 mm - 3½" tk 12810-09



SCHAEDEL

90 mm - 3½" tk 12820-09



DOYEN

180 mm - 7" tk 12825-18

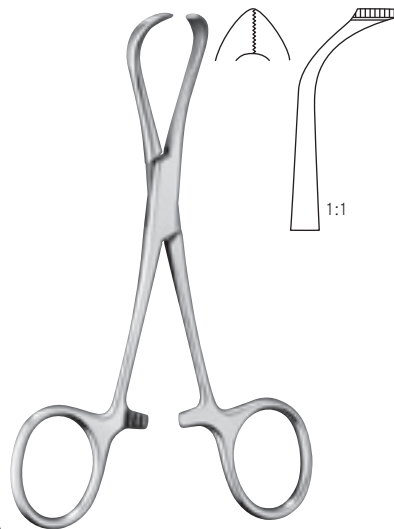

LORNA

100 mm - 4" tk 12830-10
130 mm - 5" tk 12830-13

Tuchklemmen
Towel forceps
Pincés à champs
Pinzas de campo
Pinze fissateli



LANE

130 mm - 5"	tk 12840-13
150 mm - 6"	tk 12840-15
200 mm - 8"	tk 12840-20

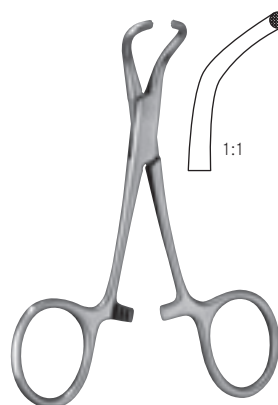

TOHOKU-JAPAN

100 mm - 4"	tk 12845-10
130 mm - 5"	tk 12845-13



PEERS-BERTRAM

145 mm - 5¾"	tk 12847-14
--------------	-------------



90 mm - 3½"	tk 12801-09
115 mm - 4½"	tk 12850-11
130 mm - 5"	tk 12850-13

für Papierabdeckung
for paper clothes

pour couvertures en papier
para paños de papel
per copertura di carta

Kornzangen
Polypus and dressing forceps

Pinces à polypes et à pansements
Pinzas para pólipos y vendajes
Pinze per medicazione e polipi

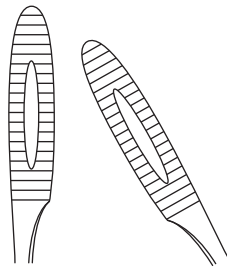
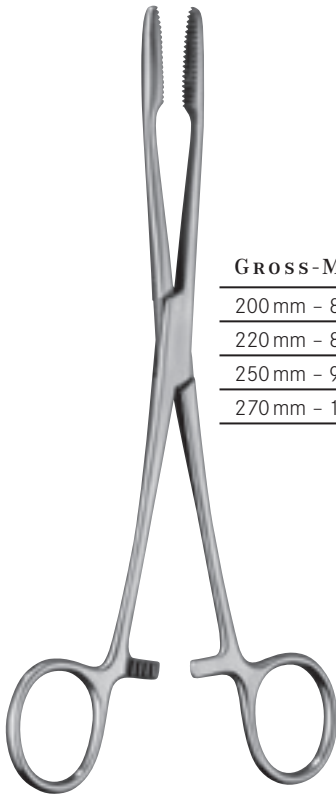

GROSS-MAIER

200 mm - 8"	tk 15110-20	tk 15111-20
220 mm - 8¾"	tk 15110-22	tk 15111-22
250 mm - 9¾"	tk 15100-25	tk 15101-25
270 mm - 10¾"	tk 15100-27	tk 15101-27

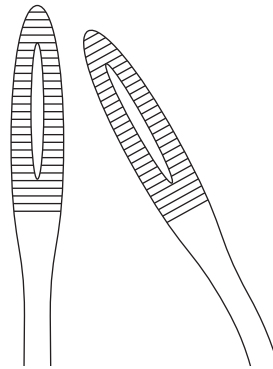

MAIER

200 mm - 8"	tk 15112-20	tk 15113-20
250 mm - 9¾"	tk 15102-25	tk 15103-25

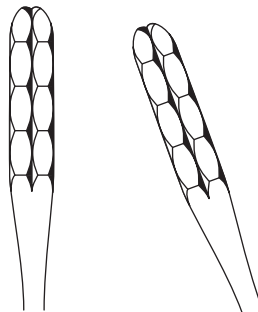

ULRICH

220 mm - 8¾"	tk 15120-22	tk 15121-22
250 mm - 9¾"	tk 15120-25	tk 15121-25
270 mm - 10¾"	tk 15120-27	tk 15121-27
350 mm - 14"	tk 15120-35	tk 15121-35

Schwammzangen
Sponge holding forceps

Pinces à éponges
Pinzas para esponjas
Pinze per tamponi



FOERSTER
(BALENGER)

180 mm - 7"	tk 15180-18	tk 15182-18	tk 15183-18	tk 15185-18
200 mm - 8"		tk 15182-20		tk 15185-20
250 mm - 9¾"	tk 15180-25	tk 15182-25	tk 15183-25	tk 15185-25
300 mm - 12"		tk 15182-30		
350 mm - 14"		tk 15182-35		
400 mm - 16"		tk 15182-40		

Trachealhäkchen
Trachea retractors

Ecarteurs tracheales
Separadores traqueales
Uncini tracheali

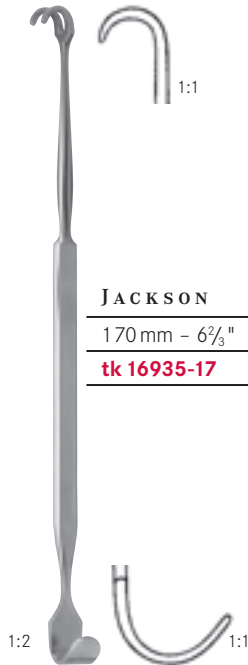

JACKSON

170 mm - 6 $\frac{2}{3}$ "

tk 16935-17



JACKSON

180 mm - 7"

tk 16937-18

tk 16939-18

stumpf

scharf

blunt

sharp

mousse

pointu

romo

agudo

smusso

acuto

Wundhaken
Retractors

Ecarteurs
Separadores
Divaricatori

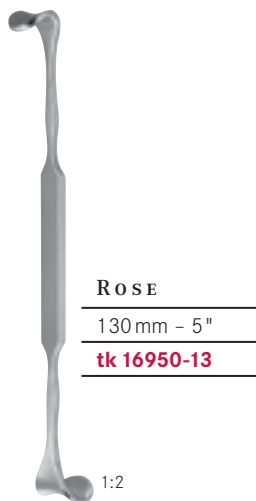

ROSE

130 mm - 5"

tk 16950-13



LUER

110 mm - 4 $\frac{1}{4}$ "

tk 16952-11







SCHOENBORN

210 mm - 8 $\frac{1}{4}$ "





tk 16955-21





Wundhaken | Ecarteurs
 Retractors | Separadores
 Divaricatori



EMMET	 1:1	 1:1	 1:1	 1:1	 1:1
	Fig. 1	Fig. 2	Fig. 3	Fig. 4	Fig. 5
	220 mm - 8 3/4"	tk 16958-01	tk 16958-02	tk 16958-03	tk 16958-04



scharf sharp pointu agudo acuto	 1:1	 1:1	 1:1	 1:1	
	160 mm - 6 1/4"	tk 17001-16	tk 17002-16	tk 17003-16	tk 17004-16

stumpf blunt mousse romo smusso	 1:1	 1:1	 1:1	 1:1	
	160 mm - 6 1/4"	tk 17011-16	tk 17012-16	tk 17013-16	tk 17014-16

Wundhaken
Retractors

Ecarteurs
Separadores
Divaricatori



1:2



160 mm - 6 1/4"	tk 17021-16	tk 17022-16	tk 17024-16
-----------------	--------------------	--------------------	--------------------

flexibel, scharf
flexible, sharp
flexible, pointu
flexible, agudo
flessibile, acuto



160 mm - 6 1/4"	tk 17031-16	tk 17032-16	tk 17034-16
-----------------	--------------------	--------------------	--------------------

flexibel, stumpf
flexible, blunt
flexible, mousse
flexible, romo
flessibile, smusso



1:1

DESMARRES



	x = 8 mm	x = 10 mm	x = 12 mm
160 mm - 6 1/4"	tk 17038-08	tk 17038-10	tk 17038-12



	x = 14 mm	x = 16 mm	x = 18 mm
160 mm - 6 1/4"	tk 17038-14	tk 17038-16	tk 17038-18

1:2



1:1

1:2

KNAPP
(ROLLET)

160 mm - 6 1/4"
tk 17025-16

flexibel, scharf
flexible, sharp
flexible, pointu
flexible, agudo
flessibile, acuto

Wundhaken
Retractors

Ecarteurs
Separadores
Divaricatori



MINI-LANGENBECK

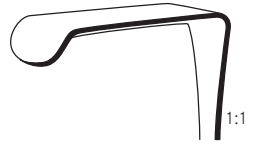
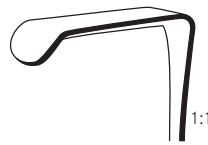

	10 mm x 6 mm	17 mm x 5 mm	20 mm x 6 mm	22 mm x 8 mm
160 mm - 6 1/4"	tk 17039-10	tk 17039-17	tk 17039-20	tk 17039-22



KOCHER

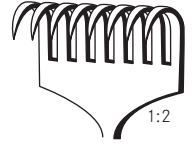
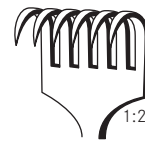

220 mm - 8 3/4"	tk 17041-22	tk 17042-22	tk 17043-22	tk 17044-22	tk 17046-22	tk 17048-22
-----------------	-------------	-------------	-------------	-------------	-------------	-------------

scharf
sharp
pointu
agudo
acuto

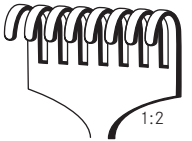
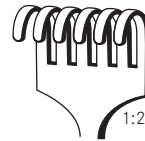
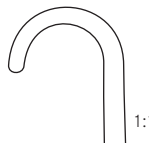

220 mm - 8 3/4"	tk 17051-22	tk 17052-22	tk 17053-22	tk 17054-22	tk 17056-22	tk 17058-22
-----------------	-------------	-------------	-------------	-------------	-------------	-------------

stumpf
blunt
mousse
romo
smusso

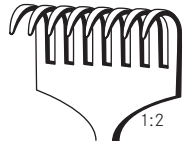
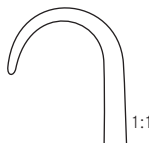

220 mm - 8 3/4"	tk 17059-01	tk 17059-02	tk 17059-03	tk 17059-04	tk 17059-06	tk 17059-08
-----------------	-------------	-------------	-------------	-------------	-------------	-------------

halbscharf
semi-sharp
semi-pointu
semi-agudo
semi-acuto

Wundhaken
Retractors

Ecarteurs
Separadores
Divaricatori



VOLKMANN

215 mm - 8½ "

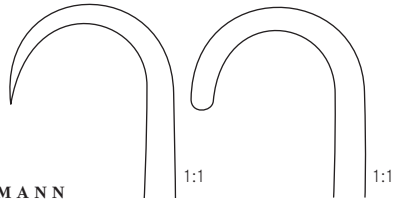

tk 17040-01

tk 17040-02

scharf

sharp

pointu

agudo

acuto

stumpf

blunt

mousse

romo

smusso



SENN-MILLER

160 mm - 6¼ "

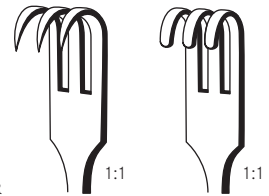

tk 17080-16

tk 17081-16

scharf

sharp

pointu

agudo

acuto

stumpf

blunt

mousse

romo

smusso



13 mm x 5 mm

KILNER

155 mm - 6 "

tk 17082-15

1:2



1:1

Wundhaken
Retractors

Ecarteurs
Separadores
Divaricatori



STRANDELL-
STILLE

	20 mm x 6 mm	20 mm x 6 mm
190 mm - 7½"	tk 17079-01	tk 17079-02

gezahnt
saw edge
dentelé
dentado
dentato

1:2



SENN-GREEN

	20 mm x 6 mm	10 mm x 6 mm
150 mm - 6"	tk 17083-01	tk 17083-02

1:2



RAGNELL-
DAVIS

140 mm - 5½"	tk 17084-14
--------------	--------------------

15 mm x 5,5 mm

1:2

1:1



COTTLE

150 mm - 6"	tk 17085-15
-------------	--------------------

1:2

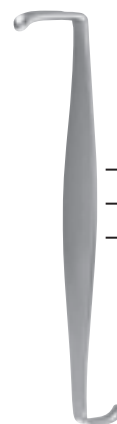

CRILE

110 mm - 4¼"	tk 17088-11
--------------	--------------------



1:2



Wundhaken
Retractors

Ecarteurs
Separadores
Divaricatori







LANGENBECK



	 1:1	 1:1	 1:1
	Fig. 1	Fig. 2	Fig. 3
	30 mm x 11 mm	30 mm x 14 mm	30 mm x 16 mm
210 mm - 8¼"	tk 17112-01	tk 17112-02	tk 17112-03



	 1:1	 1:1
	Fig. 4	Fig. 5
	40 mm x 11 mm	50 mm x 11 mm
210 mm - 8¼"	tk 17112-04	tk 17112-05



KOCHER-LANGENBECK
(OBWEGESER)

	 1:2	 1:2	 1:2	 1:2
	25 mm x 7 mm	35 mm x 8 mm	35 mm x 11 mm	35 mm x 15 mm
215 mm - 8½"	tk 17114-01	tk 17114-02	tk 17114-03	tk 17114-04

	 1:2	 1:2	 1:2
	42 mm x 10 mm	55 mm x 12 mm	70 mm x 14 mm
215 mm - 8½"	tk 17114-05	tk 17114-06	tk 17114-07

	 1:2	 1:2
	80 mm x 12 mm	80 mm x 16 mm
215 mm - 8½"	tk 17114-08	tk 17114-09

Wundsperrer
Self-retaining retractors

Ecarteurs autostatiques
Separadores autoestáticos
Divaricatori autostatici

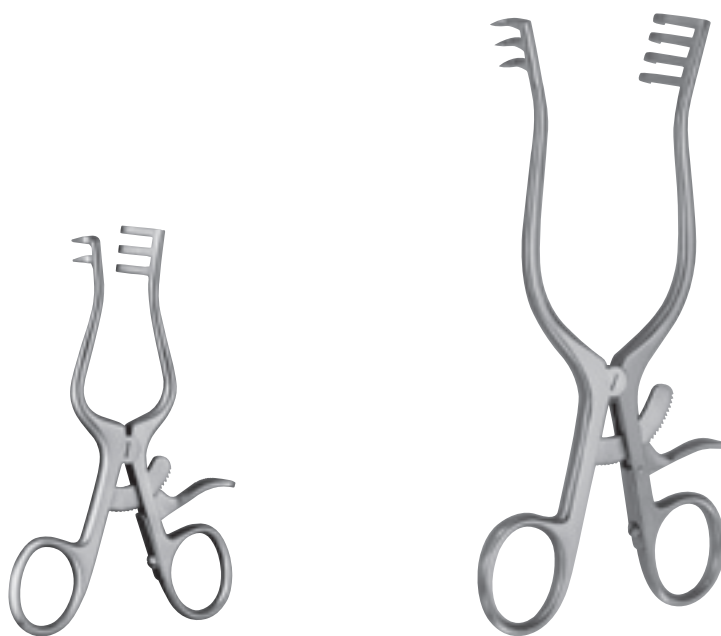
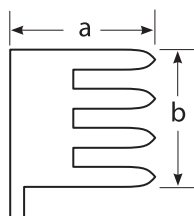

WEITLANER-LOKTITE

105 mm - 4¼"	a=17 mm - b=13 mm	tk 17400-10	tk 17400-20	tk 17401-10			
130 mm - 5"	a=17 mm - b=17 mm				tk 17402-13	tk 17402-23	tk 17403-13
165 mm - 6½"	a=17 mm - b=17 mm				tk 17402-16	tk 17402-26	tk 17403-16
200 mm - 8"	a=20 mm - b=19 mm				tk 17404-20	tk 17404-30	tk 17405-20
260 mm - 10¼"	a=26 mm - b=21 mm				tk 17404-26	tk 17404-36	tk 17405-26
		2 x 3 scharf sharp pointu agudo acuto	2 x 3 halbscharf semi sharp semi pointu semi agudo semi acuto	2 x 3 stumpf blunt mousse romo smusso	3 x 4 scharf sharp pointu agudo acuto	3 x 4 halbscharf semi sharp semi pointu semi agudo semi acuto	3 x 4 stumpf blunt mousse romo smusso

Wundsperrer
Self-retaining retractors

Ecarteurs autostatiques
Separadores autoestáticos
Divaricatori autostatici



ALM

70 mm - 2¾"	tk 17330-07	tk 17330-17	tk 17331-07
100 mm - 4"	tk 17330-10	tk 17330-20	tk 17331-10

scharf <i>sharp</i>	halbscharf <i>semi sharp</i>	stumpf <i>blunt</i>
pointu <i>agudo</i>	semi pointu <i>semi agudo</i>	mousse <i>romo</i>
acuto	semi acuto	smusso



HOLTZHEIMER

100 mm - 4"	tk 17336-10	tk 17337-10
-------------	--------------------	--------------------

scharf <i>sharp</i>	stumpf <i>blunt</i>
pointu <i>agudo</i>	mousse <i>romo</i>
acuto	smusso



BOSE

70 mm - 2¾"
tk 17395-07



JANSEN

100 mm - 4"	tk 17480-01	tk 17480-02
110 mm - 4¼"		tk 17482-11

scharf <i>sharp</i>	stumpf <i>blunt</i>
pointu <i>agudo</i>	mousse <i>romo</i>
acuto	smusso

Tränenkanal-Dilatatoren
Lacrimal Dilators

Dilatateurs pour le canal lacrymal
Dilatadores para el canal lacrimal
Dilatatori lacrimali



BOWMAN

Tränenkanal-Dilatator
Lacrimal Dilators

Dilatateurs pour le canal lacrymal
Dilatadores para el canal lacrimal
Dilatatori lacrimali

Fig. 000 / 00	Fig. 00 / 0	Fig. 0 / 1	Fig. 1 / 2	Fig. 2 / 3
tk 40099-00	tk 40100-00	tk 40100-01	tk 40100-12	tk 40100-23
0.4 / 0.6 mm Ø	0.7 / 0.8 mm Ø	0.8 / 0.9 mm Ø	0.9 / 1.1 mm Ø	1.1 / 1.3 mm Ø

geknöpft
probe

boutonné
botonado
botonuti

Fig. 3 / 4	Fig. 4 / 5	Fig. 5 / 6	Fig. 6 / 7	Fig. 7 / 8
tk 40100-34	tk 40100-45	tk 40100-56	tk 40100-67	tk 40100-78
1.3 / 1.4 mm Ø	1.4 / 1.5 mm Ø	1.5 / 1.6 mm Ø	1.6 / 1.8 mm Ø	1.8 / 1.9 mm Ø

geknöpft
probe

boutonnés
botonado
botonuti

Fig. 000 / 00	Fig. 00 / 0	Fig. 0 / 1	Fig. 1 / 2	Fig. 2 / 3
tk 40101-00	tk 40102-00	tk 40102-01	tk 40102-12	tk 40102-23
0.4 / 0.6 mm Ø	0.7 / 0.8 mm Ø	0.8 / 0.9 mm Ø	0.9 / 1.1 mm Ø	1.1 / 1.3 mm Ø

zylindrisch

cylindrical
cylindriques
cilindrico
cilindrico

Fig. 3 / 4	Fig. 4 / 5	Fig. 5 / 6	Fig. 6 / 7	Fig. 7 / 8
tk 40102-34	tk 40102-45	tk 40102-56	tk 40102-67	tk 40102-78
1.3 / 1.4 mm Ø	1.4 / 1.5 mm Ø	1.5 / 1.6 mm Ø	1.6 / 1.8 mm Ø	1.8 / 1.9 mm Ø

zylindrisch

cylindrical
cylindriques
cilindrico
cilindrico

Nadelhalter mit Hartmetalleinsätzen im Maulbereich Needle holders with tungsten-carbide inserts in the jaws

Porte-aiguilles avec des inserts de carbure de tungstène dans les mors
Porte-agujas con insertos de carburo tungsteno en las bocas
Port'aghi con inserti in carburo di tungsteno



Alle Nadelhalter mit „tucar“ Hartmetalleinsätzen bieten einen sicheren, festen Halt der Nadel und verhindern deren Verdrehen. Zur Kennzeichnung sind alle Hartmetall-Nadelhalter an den Ringgriffen bzw. den Branchen vergoldet.

All the needle holders with “tucar” tungsten-carbide inserts offer a safe and secure grip of the needle and prevent the twisting of the same. Needle holders with tungsten-carbide inserts are identified by gold-plated rings or handles.

Tous les porte-aiguilles avec des inserts «tucar» de carbure de tungstène garantissent que les aiguilles sont tenues sûres et fortes et qu'elles ne peuvent pas se tordre. Les portes aiguilles avec des inserts de tungstène de carbure peuvent être reconnus à leurs bagues ou manches dorées.

Todas las porta-agujas “tucar” con los insertos de carburo tungsteno aseguran la sujeción firme y seguro de las agujas que evita la torsión de las cuales. Porta-agujas con insertos de carburo de tungsteno se reconocen por los anillos o mangos dorados.

Tutti i port'aghi con inserti in carburo di tungsteno “tucar” (tungsten-carbide) assicurano una presa dell'ago sicura e forte, che previene la torsione dall'ago stesso. I port'aghi con inserto in carburo di tungsteno sono riconoscibili per la doratura del manico o degli anelli.

0.5 mm

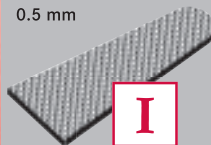

I

Normal für Nadeln und Nahtmaterial bis Stärke 4-0
Regular for use with needles and sutures up to size 4-0

Normale pour aiguilles et matériel à suture jusqu'à l'épaisseur de 4-0
Normal para agujas y material de suturar hasta el espesor de 4-0
Normale per aghi e materiale per sutura fino ad uno spessore di 4-0

0.4 mm

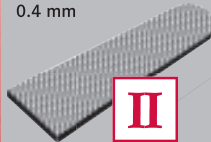

II

Fein für feine Nadeln und Nahtmaterial Stärke 5-0 + 6-0
Fine for delicate needles and sutures sizes 5-0 + 6-0

Fino pour aiguilles fines et matériel à suture à l'épaisseur 5-0 + 6-0
Fine para agujas finas y material de suturar espesores 5-0 + 6-0
Fine per aghi fini e materiale per sutura con spessore 5-0 + 6-0

0.3 mm

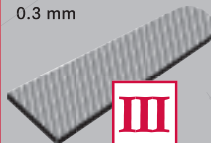

III

Extrafein für Mikro-Nadeln und Nahtmaterial Stärke 7-0 bis 10-0
Extrafine for use with micro-needles and sutures size 7-0 and 10-0

Extrafino pour micro-aiguilles et matériel à suture à l'épaisseur 7-0 à 10-0
Extrafine para micro-agujas y material de suturas espesor 7-0 y 10-0
Extrafine per micro-aghi e materiale per sutura 7-0 e 10-0

Glatt für feine Nadeln und Nahtmaterial Stärke 7-0 bis 12-0
Smooth for delicate needles and sutures sizes 7-0 and 12-0

Liso pour aiguilles fines et matériel à suture à l'épaisseur 7-0 à 12-0
Lisse para agujas finas y material de suturas espesor 7-0 y 12-0
Liscia per aghi fini e materiale per sutura 7-0 e 12-0

IV

Nadelhalter
Needle holders

Porte-aiguilles
Porta-agujas
Porta-ghi

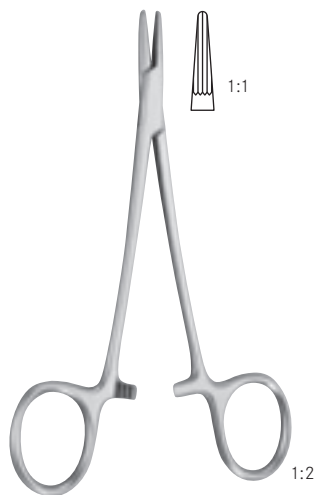

DERF
tk 20308-12
125 mm - 5"

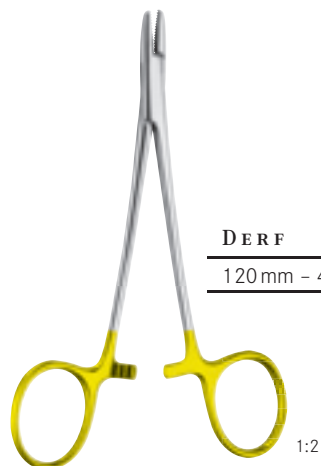

DERF		
120 mm - 4¾"	tk 20008-12	tk 20508-12 TC

ein Maul gefenstert
one fenestrated jaw
une coté du mors fenestré
un lado de la boca fenestrada
una parte del morso finestrado



CRILE-MURRAY
tk 20001-15
150 mm - 6"



CRILE-WOOD		
150 mm - 6"	tk 20002-15	tk 20502-15 TC
180 mm - 7"	tk 20002-18	tk 20502-18 TC
200 mm - 8"	tk 20002-20	tk 20502-20 TC

Nadelhalter
Needle holders

Porte-aiguilles
Porta-agujas
Porta-ghi

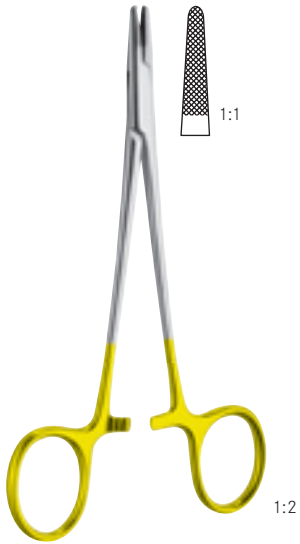

HEGAR-BAUMGARTNER

140 mm - 5 3/4"	tk 20003-14
140 mm - 5 3/4"	tk 20503-14 TC



BABY-CRILE-WOOD

tk 20504-15 TC
150 mm - 6"

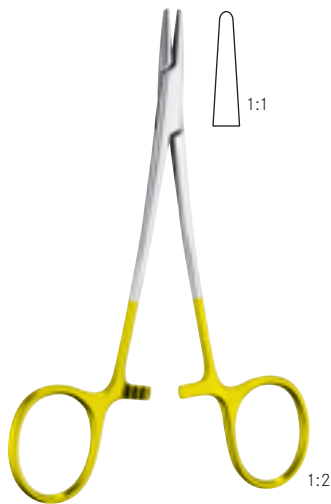

WEBSTER

130 mm - 5"	tk 20009-13
130 mm - 5"	tk 20509-13 TC

glatt
smooth
lisse
liso
liscio





MATHIEU-OLSEN

140 mm - 5 1/2"	tk 20106-14	tk 20516-14 TC
170 mm - 6 3/4"	tk 20106-17	tk 20516-17 TC
200 mm - 8"	tk 20106-20	tk 20516-20 TC



Nadelhalter
Needle holders

Porte-aiguilles
Porta-agujas
Porta-aghi



HALSEY	 1:1	 1:1
	130 mm - 5"	tk 20010-13
130 mm - 5"	tk 20510-13 TC	tk 20511-13 TC
	glatt <i>smooth</i>	gerieft <i>serrated</i>
	lisse <i>liso</i>	strié <i>estriada</i>
	liscio	zigrinato



OLSEN-HEGAR	 1:2	 1:2
	120 mm - 4¾"	tk 20036-12
140 mm - 5½"	tk 20036-14	tk 20536-14 TC
170 mm - 6¾"	tk 20036-17	tk 20536-17 TC
190 mm - 7½"	tk 20036-19	tk 20536-19 TC

Nadelhalter
Needle holders

Porte-aiguilles
Porta-agujas
Porta-ghi



MAYO-HEGAR

tk 20012-14	tk 20012-16	tk 20012-18	tk 20012-20	tk 20012-24	tk 20012-26	tk 20012-30
140 mm - 5½"	160 mm - 6¼"	180 mm - 7"	200 mm - 8"	240 mm - 9½"	260 mm - 10¼"	300 mm - 12"

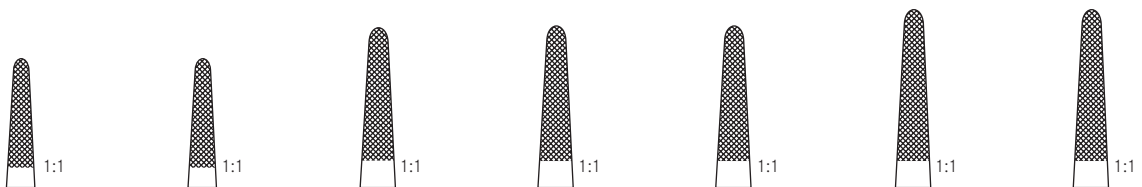

MAYO-HEGAR

tk 20512-14 TC	tk 20512-16 TC	tk 20512-18 TC	tk 20512-20 TC	tk 20512-24 TC	tk 20512-26 TC	tk 20512-30 TC
140 mm - 5½"	160 mm - 6¼"	180 mm - 7"	200 mm - 8"	240 mm - 9½"	260 mm - 10¼"	300 mm - 12"

Nadelhalter
Needle holders
Porte-aiguilles
Porta-agujas
Porta-ghi



1:2

GILLIES

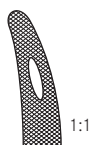

1:1



1:1

160 mm - 6 1/4"

tk 20035-16

tk 20535-16 TC



1:2



1:2

GILLIES



1:1



1:1

145 mm - 5 3/4"

tk 20035-14

tk 20535-14 TC



1:2

FOSTER-GILLIES



1:2



1:2



1:2



1:2

120 mm - 4 3/4"

tk 20546-12 TC

tk 20547-12 TC

tk 20548-12 TC

tk 20549-12 TC

gerade, gerieft
straight, serrated
droit, strié
recta, estriada
rette, zigrinato

gerade, glatt
straight, smooth
droit, lisse
recta, lisa
rette, liscio

gebogen, gerieft
curved, serrated
courbe, strié
curva, estriada
curve, zigrinato

gebogen, glatt
curved, smooth
courbe, lisse
curva, lisa
curve, liscio

Nadelhalter
Needle holders

Porte-aiguilles
Porta-agujas
Porta-aghi

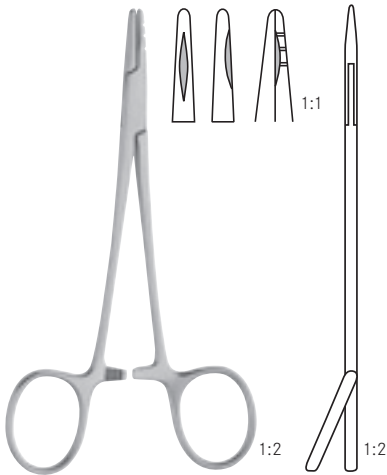

NEIVERT

tk 20304-13

125 mm - 5"

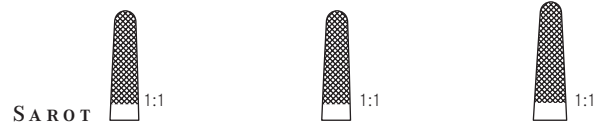

tk 20524-18 TC	tk 20524-20 TC	tk 20524-26 TC
180 mm - 7"	200 mm - 8"	260 mm - 10¼"

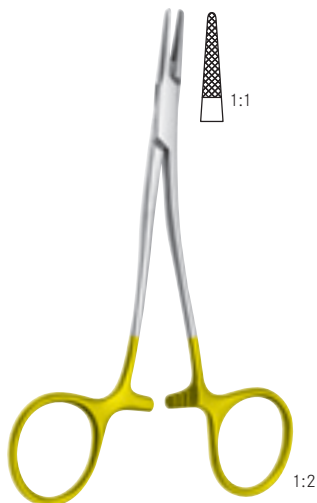

KILNER

tk 20533-13 TC

135 mm - 5¼"

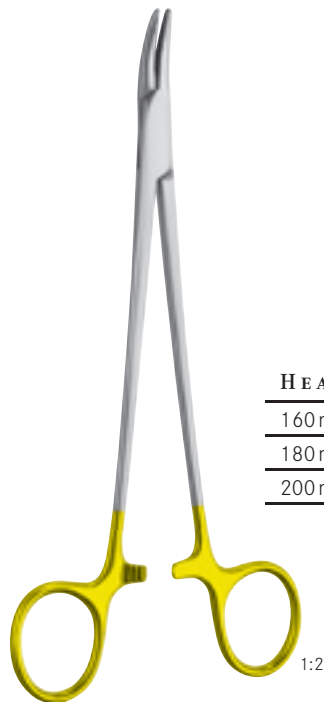

HEANEY

160 mm - 6¼"	tk 20515-16 TC
180 mm - 7"	tk 20515-18 TC
200 mm - 8"	tk 20515-20 TC

Nadelhalter
Needle holders

Porte-aiguilles
Porta-agujas
Porta-agma

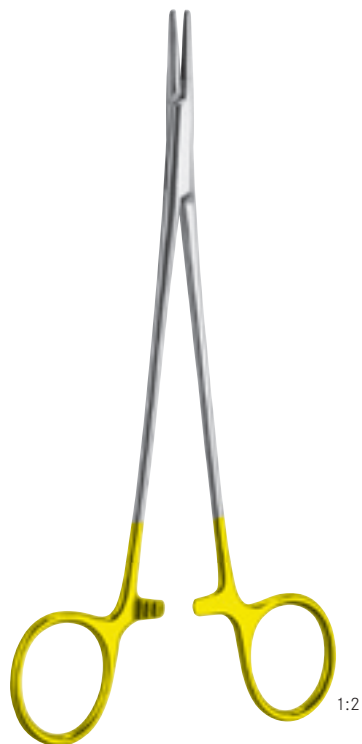

DE BAKEY

tk 20522-18 TC	tk 20522-20 TC	tk 20522-23 TC	tk 20522-26 TC
180 mm - 7"	170 mm - 6¾"	200 mm - 8"	240 mm - 9½"

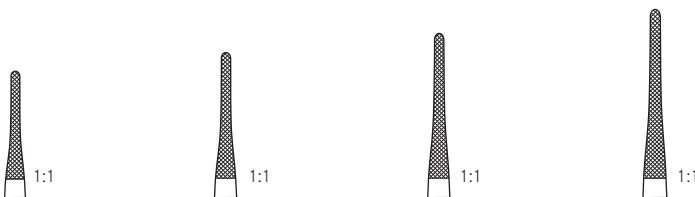

VASCULAR

tk 20525-14 TC	tk 20525-18 TC	tk 20525-20 TC	tk 20525-23 TC
140 mm - 5½"	180 mm - 7"	200 mm - 8"	230 mm - 9"

Nadelhalter
Needle holders

Porte-aiguilles
Porta-agujas
Porta-agma



tk 20570-13	tk 20570-15	tk 20570-17
130 mm - 5"	150 mm - 5¾"	170 mm - 6¾"

mit Spezialbeschichtung im Maul
with special coated jaw

mors avec couche special
boca con capa especial
morso "diamant dust"

tk 20570-18	tk 20570-20	tk 20570-23
180 mm - 7"	200 mm - 8"	230 mm - 9"

mit Spezialbeschichtung im Maul
with special coated jaw

mors avec couche special
boca con capa especial
morso "diamant dust"



RYDER			
	1:1	1:1	MINI-RYDER 1:1
130 mm - 5"	tk 20540-13 TC	tk 20541-13	tk 20542-13 TC
150 mm - 6"	tk 20540-15 TC	tk 20541-15	tk 20542-15 TC
180 mm - 7"	tk 20540-18 TC	tk 20541-18	tk 20542-18 TC
200 mm - 8"	tk 20540-20 TC	tk 20541-20	tk 20542-20 TC
230 mm - 9"	tk 20540-23 TC	tk 20541-23	tk 20542-23 TC
260 mm - 10¼"	tk 20540-26 TC		tk 20542-26 TC

mit Spezialbeschichtung im Maul
with special coated jaw

Mors avec couche special
Boca con capa especial
Morso "diamant dust"

Nadelhalter
Needle holders
Porte-aiguilles
Porta-agujas
Porta-ago



CASTROVIEJO-
JACOBSON



140 mm - 5½"			tk 20210-14	tk 20710-14 TC
150 mm - 6"	tk 20204-15	tk 20704-15 TC	tk 20210-15	tk 20710-15 TC
180 mm - 7"	tk 20204-18	tk 20704-18 TC	tk 20210-18	tk 20710-18 TC
210 mm - 8¼"	tk 20204-21	tk 20704-21 TC	tk 20210-21	tk 20710-21 TC

glattes Maul
smooth jaws

mors lisse

boca lisa

morso liscio

gerade, ohne Sperre
straight, without ratchet

droit, sans crémaillère

recta, sin cremallera

retto, senza cremagliera

gerade, mit Sperre
straight, with ratchet

droit, avec crémaillère

recta, con cremallera

retto, con cremagliera

1:2



140 mm - 5½"			tk 20211-14	tk 20711-14 TC
150 mm - 6"	tk 20205-15	tk 20705-15 TC	tk 20211-15	tk 20711-15 TC
180 mm - 7"	tk 20205-18	tk 20705-18 TC	tk 20211-18	tk 20711-18 TC
210 mm - 8¼"	tk 20205-21	tk 20705-21 TC	tk 20211-21	tk 20711-21 TC

glattes Maul
smooth jaws

mors lisse

boca lisa

morso liscio

gebogen, ohne Sperre
curved, without ratchet

courbe, sans crémaillère

curva, sin cremallera

curvo, senza cremagliera

gebogen, mit Sperre
curved, with ratchet

courbe, avec crémaillère

curva, con cremallera

curvo, con cremagliera

BARRAQUER



145 mm - 5¾"	tk 20200-14	tk 20201-14
--------------	-------------	-------------

gerade
straight

droit

recta

retto

gebogen
curved

courbe

curva

curvo



1:2

Nadelhalter
Needle holders

Porte-aiguilles
Porta-agujas
Porta-ghi

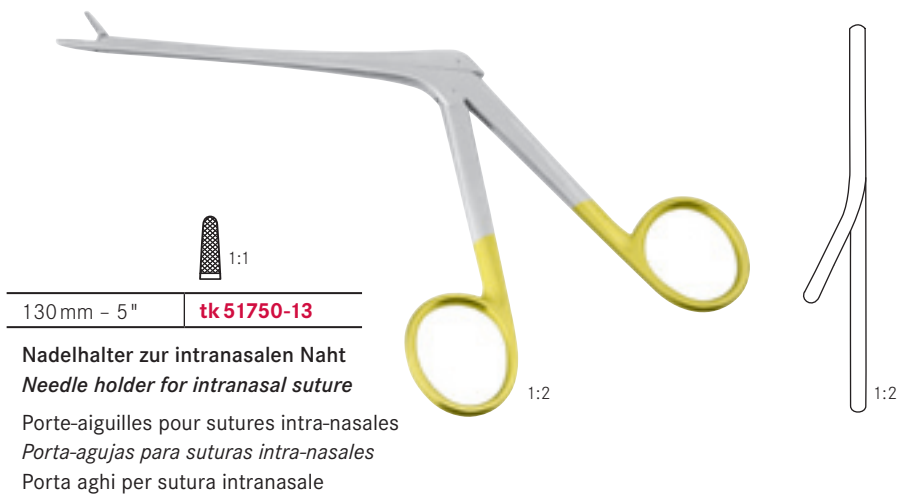

Nahtinstrumente
Suture instruments

Instruments à suture
Instrumental para sutura
Strumenti per sutura



MOD. WIEN

235 mm - 9¼"

tk 21375-23

Fadenfänger
Ligature catcher

Porte-ligature
Captador de hilos
Portalegature



BOZEMANN

210 mm - 8¼"

tk 21380-21

Schlingendreher
Knot tier

Tords-fil
Tuerce-lazos
Torcifilo



230 mm - 9"

tk 21385-23

Fadengabel
Ligature adjuster

Pousse-fil
Horquilla de hilos
Forchetta da sutura

Hämmer
Mallets

Maillets
Martillos
Martelli



1:2

H A J E K

	27 mm Ø - 140 g
215 mm - 8½"	tk 24047-21

Stahl massiv
steel solid
acier solide
acero solido
acciaio massiccio



1:2

C O L L I N

	30 mm Ø - 220 g
200 mm - 8"	tk 24051-20

Stahl massiv
steel solid
acier solide
acero solido
acciaio massiccio

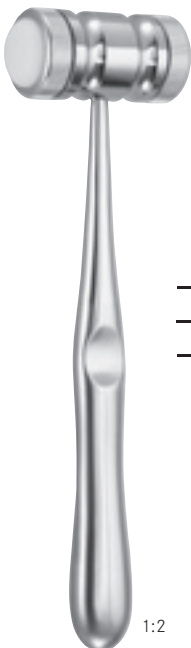

1:2

M E A D

	26 mm Ø - 320 g	26 mm Ø - 320 g
170 mm - 6¾"	tk 24050-17	tk 24050-90

Stahl massiv, mit Ferrozellbacken
steel solid, with Ferrozell faces

acier solide, avec plaques en Ferrozell
acero solido, con placas en Ferrozell
acciaio massiccio, con punte di Ferrozell

Ersatzbacken, 1 Paar
spare faces, 1 pair

plaques de rechange, 1 paire
placas de cambio, 1 par
placche di ricambio, 1 paia

Scharfe Doppellöffel
Bone currettes, double-ended

Curettes doubles
Cucharillas de doble extremo
 Curette doppia

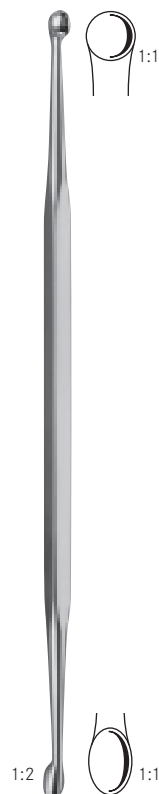
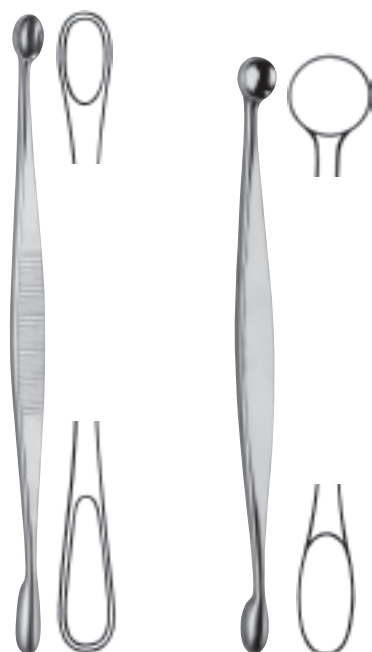

VOLKMANN

130 mm - 5"	tk 24400-13	tk 24410-13
140 mm - 5½"	tk 24400-14	
160 mm - 6¼"		tk 24410-16
170 mm - 6¾"	tk 24400-17	
200 mm - 8"		tk 24410-20

oval / oval
oval / oval
 ovale / ovale
ovalada / ovalada
 ovale / ovale

rund / oval
round / oval
 ronde / ovale
redonda / ovalada
 rotondo / ovale

210 mm - 8¼"
tk 24412-21
 rund / oval
round / oval
 ronde / ovale
redonda / ovalada
 rotondo / ovale

Raspatorien – Elevatorien
Periosteal raspatories – Elevators

Rugines – Elevateurs
Raspatorios – Elevadores
Periostotomi – Elevatori

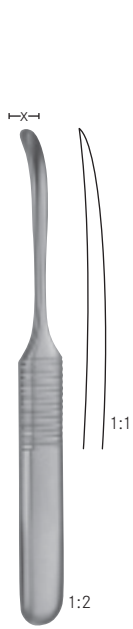

WILLIGER

1:2

x = 5 mm

130 mm – 5"

tk 24525-13



WILLIGER

1:2

160 mm – 6¼"

x = 4 mm

tk 24525-16

x = 6 mm

tk 24526-16



WILLIGER

1:2

x = 5 mm

160 mm – 6¼"

tk 24532-16



1:2

x = 6.5 mm

tk 24533-17

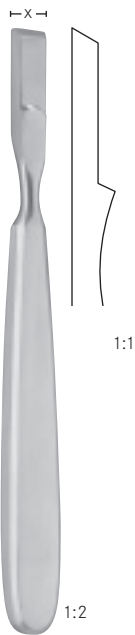

FARABEUF-
COLLIN

1:2

x = 11 mm

160 mm – 6¼"

tk 24528-01



1:2

x = 11 mm

tk 24528-02

Raspatorien – Elevatorien
Periosteal raspatories – Elevators

Rugines – Elevateurs
Raspatorios – Elevadores
 Periostotomi – Elevatori

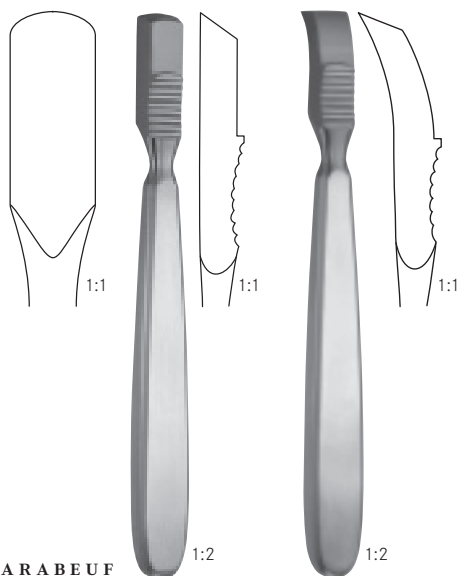

FARABEU F	
150 mm - 6"	tk 24520-15 tk 24521-15
gerade <i>straight</i>	gebogen <i>curved</i>
droit <i>recta</i>	courbe <i>curva</i>
retto	curvo

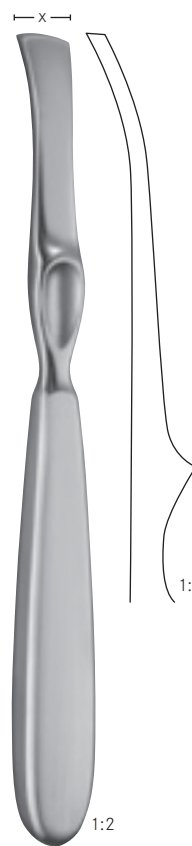

LAMBOTTE	
	210 mm - 8¼"
x = 5 mm	tk 24523-05
x = 10 mm	tk 24523-10
x = 15 mm	tk 24523-15
x = 20 mm	tk 24523-20
x = 25 mm	tk 24523-25

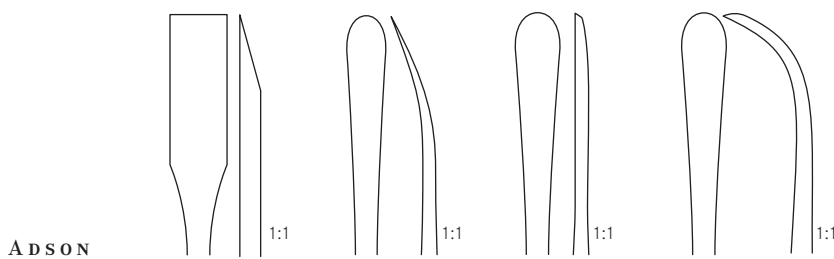

ADSON	
	Fig. 1 Fig. 2 Fig. 3 Fig. 4
170 mm - 6¾"	tk 24535-01 tk 24535-02 tk 24535-03 tk 24535-04

Septum - Elevatorien
Septum elevators

Elevateurs pour la cloison nasale
Elevadores para el tabique nasal
Elevatori per setto



COTTLE

tk 51607-19

190 mm - 7½"

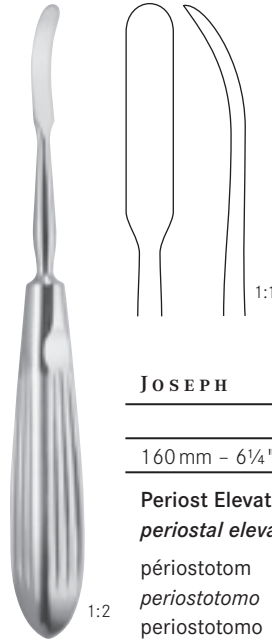

JOSEPH

4 mm

160 mm - 6¼"

tk 51613-16

Periost Elevatorien
periostal elevators

périostotom
periostotomo
periostotomo



HALLE

tk 51617-16

160 mm - 6¼"

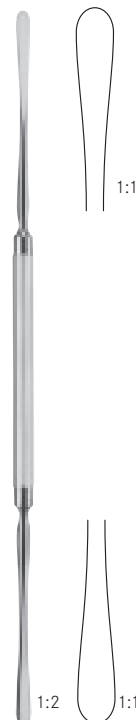

BALLENGER-HAJEK

190 mm - 7½"

tk 51637-19

220 mm - 8¾"

tk 51637-22

Septum - Elevatorien
Septum elevators

Elevateurs pour la cloison nasale
Elevadores para el tabique nasal
Elevatori per setto



FREER

tk 51625-19

190 mm - 7½"

stumpf
blunt

mousse
roma
smussa

1:2

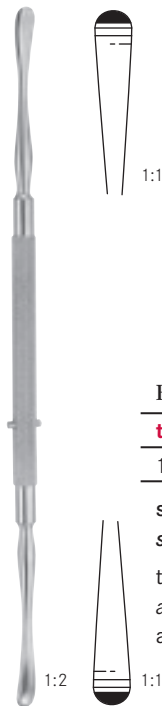

FREER

tk 51627-18

180 mm - 7"

scharf/stumpf
sharp/blunt

tranchant/mousse
aguda/roma
acuta/smussa

1:2

1:1



COTTLE



1:1

2.5 mm

160 mm - 6¼"



tk 51646-02

1:2

Bohrer
Burrs



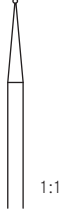
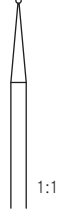
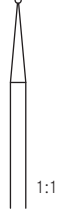
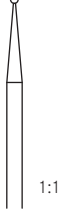
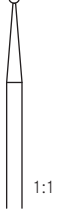
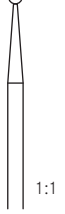

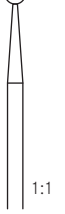
Fraises
Brocas
Frese







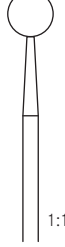
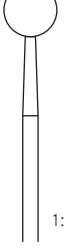

DIAMANT-BOHRER	 1:1	 1:1	 1:1	 1:1	 1:1	 1:1	 1:1	 1:1
	0.6 mm Ø	0.7 mm Ø	0.8 mm Ø	1.0 mm Ø	1.5 mm Ø	1.8 mm Ø	2.3 mm Ø	2.7 mm Ø
70 mm - 2¾"	tk 52810-06	tk 52810-07	tk 52810-08	tk 52810-10	tk 52810-15	tk 52810-18	tk 52810-23	tk 52810-27

Diamantbohrer, 70 mm lang, Schaft-Ø 2.35 mm
 Diamond dust polishing burrs, 70 mm long, shank diameter 2.35 mm

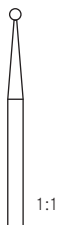
Fraises à polir, diamantées, 70 mm de long, Ø de tige 2.35 mm
 Brocas diamantadas, largo 70 mm, vástago-Ø 2.35 mm
 Frese diamantate, 70 mm lungo, asta Ø 2.35 mm

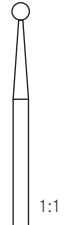
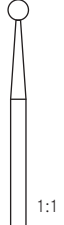

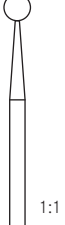
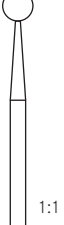
	 1:1	 1:1	 1:1	 1:1	 1:1	 1:1	 1:1
	3.0 mm Ø	3.5 mm Ø	4.0 mm Ø	4.5 mm Ø	5.0 mm Ø	6.0 mm Ø	7.0 mm Ø
70 mm - 2¾"	tk 52810-30	tk 52810-35	tk 52810-40	tk 52810-45	tk 52810-50	tk 52810-60	tk 52810-70



DIAMANT-BOHRER	 1:1	 1:1	 1:1	 1:1	 1:1	 1:1	 1:1	 1:1
	1.5 mm Ø	1.8 mm Ø	2.3 mm Ø	2.7 mm Ø	3.0 mm Ø	3.5 mm Ø	4.0 mm Ø	4.5 mm Ø
95 mm - 3¾"	tk 52812-15	tk 52812-18	tk 52812-23	tk 52812-27	tk 52812-30	tk 52812-35	tk 52812-40	tk 52812-45

Diamantbohrer, 95 mm lang, Schaft-Ø 2.35 mm
 Diamond dust polishing burrs, 95 mm long, shank diameter 2.35 mm

Fraises à polir, diamantées, 95 mm de long, Ø de tige 2.35 mm
 Brocas diamantadas, largo 95 mm, vástago-Ø 2.35 mm
 Frese diamantate, 95 mm lungo, asta Ø 2.35 mm

	 1:1	 1:1	 1:1
	5.0 mm Ø	6.0 mm Ø	7.0 mm Ø
95 mm - 3¾"	tk 52812-50	tk 52812-60	tk 52812-70

Bohrer | Fraises
 Burrs | Brocas
 Frese



„ROSEN“- BOHRER	1:1	1:1	1:1	1:1	1:1	1:1	1:1	1:1
	0.6 mm Ø	0.7 mm Ø	0.8 mm Ø	1.0 mm Ø	1.4 mm Ø	1.8 mm Ø	2.3 mm Ø	2.7 mm Ø
70 mm - 2¾"	tk 52814-06	tk 52814-07	tk 52814-08	tk 52814-10	tk 52814-14	tk 52814-18	tk 52814-23	tk 52814-27

„Rosen“-Bohrer, 70 mm lang, Schaft-Ø 2.35 mm, rostfrei
 „Rosen“ burrs, 70 mm long, shank diameter 2.35 mm, stainless
 Fraises de «Rosen», 70 mm de long, Ø de tige 2.35 mm, inoxydables
 Brocas «Rosen», largo 70 mm, vástago-Ø 2.35 mm, inoxidable
 Frese «Rosen», 70 mm lungo, asta Ø 2.35 mm, inossidabile

	1:1	1:1	1:1	1:1	1:1	1:1	1:1
	3.1 mm Ø	3.5 mm Ø	4.0 mm Ø	4.5 mm Ø	5.0 mm Ø	6.0 mm Ø	7.0 mm Ø
70 mm - 2¾"	tk 52814-31	tk 52814-35	tk 52814-40	tk 52814-45	tk 52814-50	tk 52814-60	tk 52814-70



„ROSEN“- BOHRER	1:1	1:1	1:1	1:1	1:1	1:1	1:1	1:1
	1.5 mm Ø	1.8 mm Ø	2.3 mm Ø	2.7 mm Ø	3.0 mm Ø	3.5 mm Ø	4.0 mm Ø	4.5 mm Ø
95 mm - 3¾"	tk 52816-14	tk 52816-18	tk 52816-23	tk 52816-27	tk 52816-31	tk 52816-35	tk 52816-40	tk 52816-45

„Rosen“-Bohrer, 95 mm lang, Schaft-Ø 2.35 mm, rostfrei
 „Rosen“ burrs, 95 mm long, shank diameter 2.35 mm, stainless
 Fraises de «Rosen», 95 mm de long, Ø de tige 2.35 mm, inoxydables
 Brocas «Rosen», largo 95 mm, vástago-Ø 2.35 mm, inoxidable
 Frese «Rosen», 95 mm lungo, asta Ø 2.35 mm, inossidabile

	1:1	1:1	1:1
	5.0 mm Ø	6.0 mm Ø	7.0 mm Ø
95 mm - 3¾"	tk 52816-50	tk 52816-60	tk 52816-70

Bohrer
Burrs

Fraises
Brocas
Frese



„ROSEN“- BOHRER TC	1:1	1:1	1:1	1:1	1:1	1:1	1:1
	0.6 mm Ø	0.8 mm Ø	1.0 mm Ø	1.4 mm Ø	1.8 mm Ø	2.3 mm Ø	2.7 mm Ø
70 mm - 2¾"	tk 49965-06	tk 49965-08	tk 49965-10	tk 49965-14	tk 49965-18	tk 49965-23	tk 49965-27

„Rosen“-Bohrer, 70 mm lang, Schaft-Ø 2.35 mm, TC
 “Rosen” burrs, 70 mm long, shank diameter 2.35 mm, TC
 Fraises de «Rosen», 70 mm de long, Ø de tige 2.35 mm, TC
 Brocas “Rosen”, largo 70 mm, vástago-Ø 2.35 mm, TC
 Frese “Rosen”, 70 mm lungo, asta Ø 2.35 mm, TC

	1:1	1:1	1:1	1:1	1:1	1:1	1:1
	3.1 mm Ø	3.5 mm Ø	4.0 mm Ø	4.5 mm Ø	5.0 mm Ø	6.0 mm Ø	7.0 mm Ø
70 mm - 2¾"	tk 49965-31	tk 49965-35	tk 49965-40	tk 49965-45	tk 49965-50	tk 49965-60	tk 49965-70



Andere Modelle und Längen sowie Imperatorbohrer auf Anfrage erhältlich

Other models and lengths as well as imperator drills on request

Autres modèles et longueurs ainsi que des fraises “imperator” sont disponibles sur demande

Otros modelos y longitudes y brocas “imperator” son disponibles según demanda

Altri modelli e lunghezze così come modell “imperatore” disponibili su richiesta



tk 56795-00

Bohrständer für 24 Bohrer
Drillcarrier for 24 drills

Support pour 24 mèches

Soporte para 24 brocas

Supporto per zu punte

Hohlmeißelzangen
Bone rongeurs

Pince gouges
Pinzas gubias
Pinze sgorbie



1:2

MINI-
FRIEDMAN

tk 24605-12
120 mm - 4¾"



1:2

FRIEDMAN

tk 24605-14
140 mm - 5½"

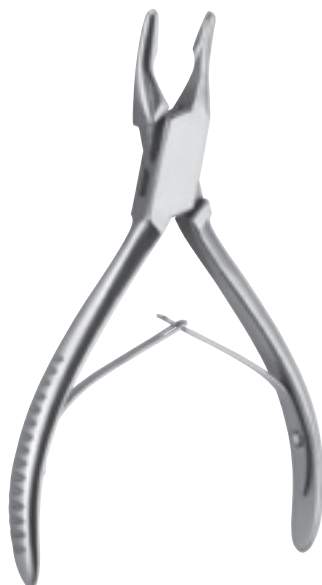

1:2

BLUMENTHAL



1:1

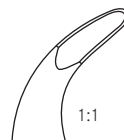

1:1



1:1

	Fig. 1	Fig. 2	Fig. 3
155 mm - 6"	tk 24606-01	tk 24606-02	tk 24606-03

Hohlmeißelzangen
Bone rongeurs

Pince gouges
Pinzas gubias
Pinze sgorbie



BÖHLER		
150 mm - 6"	tk 24613-00	tk 24613-02

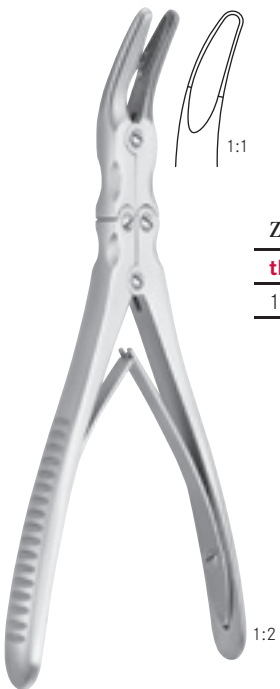
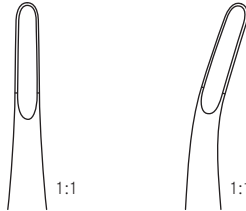

ZAUFAL-JANSEN	
tk 24614-18	
180 mm - 7"	

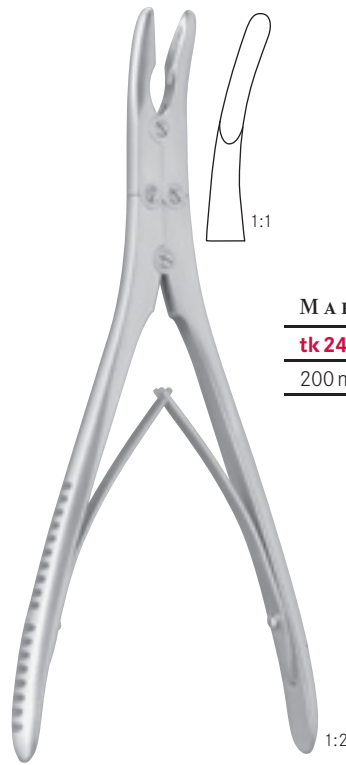

MARQUARDT	
tk 24614-20	
200 mm - 8"	



Hohlmeißelzangen
Bone rongeurs

Pince gouges
Pinzas gubias
 Pinze sgorbie



BEYER

tk 24615-18

180mm - 7"



RUSKIN

180mm - 7"

tk 24616-05

tk 24616-04

Knochensplitterzangen
Bone cutting forceps

Pinces coupantes à os
Pinzas cortantes para huesos
Cesoie per ossa

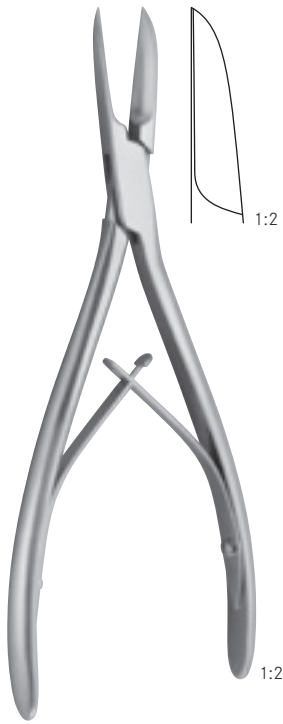

COTTLE-
KAZANJIAN

tk 24649-19

190mm - 7½"



BÖHLER

150mm - 6"



1:1

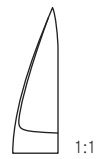

1:1

gerade
straight
droit
recta
rette

gebogen
curved
courbe
curva
curve

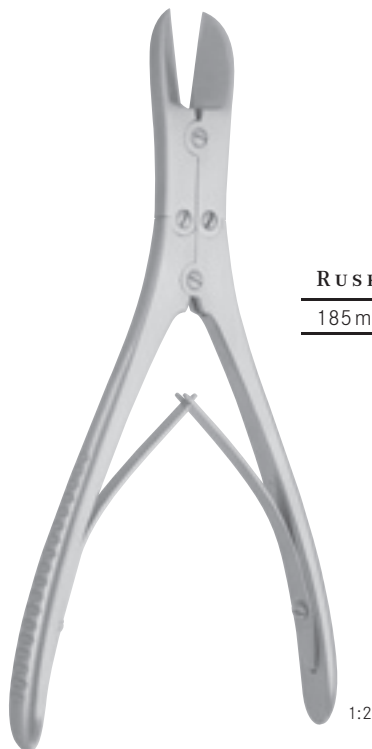

RUSKIN-LISTON

185mm - 7¼"

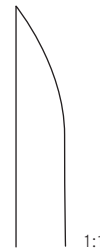

1:1



1:1

gerade
straight
droit
recta
rette

gebogen
curved
courbe
curva
curve

Mikro-Präparierscheren
Micro dissecting scissors

Micro ciseaux à dissection
Micro tijeras de disección
Forbici per micro chirurgia

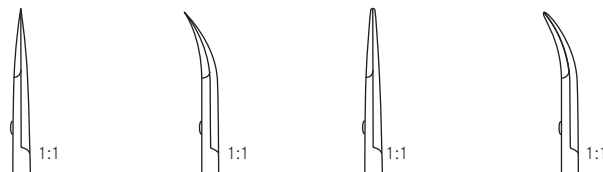

145 mm - 5¾"	tk 25602-01	tk 25603-01	tk 25602-02	tk 25603-02
180 mm - 7"	tk 25610-01	tk 25611-01	tk 25610-02	tk 25611-02

kurze Schneide 8 mm, glatt
short blades 8 mm, smooth
lames courtes 8 mm, lisses
hojas cortas 8 mm, lisos
lama corta 8 mm, liscia

gerade, spitz
straight, sharp
droites, pointues
rectas, agudas
retta, acuta

gebogen, spitz
curved, sharp
courbes, pointues
curvas, agudas
curva, acuta

gerade, stumpf
straight, blunt
droites, mousSES
rectas, romas
retta, smussa

gebogen, stumpf
curved, blunt
courbes, mousSES
curvas, romas
curva, smussa

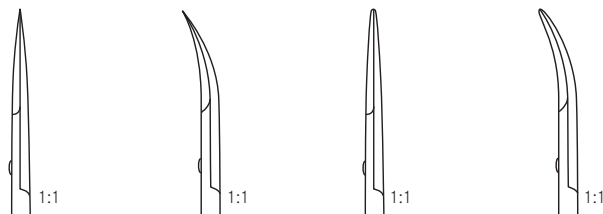

145 mm - 5¾"	tk 25602-03	tk 25603-03	tk 25602-04	tk 25603-04
180 mm - 7"	tk 25610-03	tk 25611-03	tk 25610-04	tk 25611-04

lange Schneide 14 mm, glatt
long blades 14 mm, smooth
lames longues 14 mm, lisses
hojas largas 14 mm, lisos
lama lunga 14 mm, liscia

gerade, spitz
straight, sharp
droites, pointues
rectas, agudas
retta, acuta

gebogen, spitz
curved, sharp
courbes, pointues
curvas, agudas
curva, acuta

gerade, stumpf
straight, blunt
droites, mousSES
rectas, romas
retta, smussa

gebogen, stumpf
curved, blunt
courbes, mousSES
curvas, romas
curva, smussa

Mikropinzetten
Micro forceps

Micro pincers
Micro pinzas
Pinze per microchirurgia

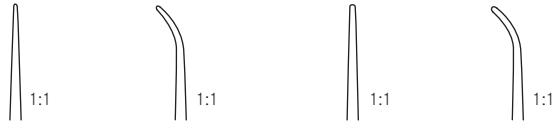

8 mm Ø	0.3 mm	0.3 mm	0.7 mm	0.7 mm
150 mm - 6"	tk 25686-01	tk 25686-02	tk 25686-03	tk 25686-04
180 mm - 7"	tk 25687-01	tk 25687-02	tk 25687-03	tk 25687-04
210 mm - 8¼"	tk 25688-01	tk 25688-02	tk 25688-03	tk 25688-04
230 mm - 9"	tk 25689-01	tk 25689-02	tk 25689-03	tk 25689-04

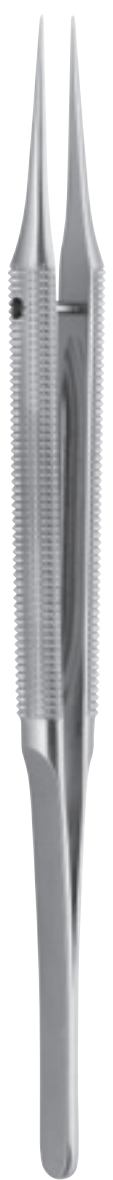

Maul glatt
Jaw smooth
Mors lisse
Boca lisa
Morso liscio

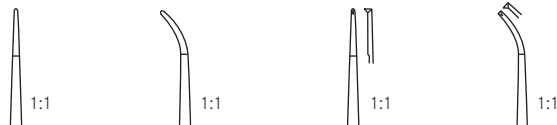

8 mm Ø	0.3 mm	0.3 mm	0.7 mm	0.7 mm
150 mm - 6"	tk 25686-05	tk 25686-06	tk 25686-09	tk 25686-10
180 mm - 7"	tk 25687-05	tk 25687-06	tk 25687-09	tk 25687-10
210 mm - 8¼"	tk 25688-05	tk 25688-06	tk 25688-09	tk 25688-10
230 mm - 9"	tk 25689-05	tk 25689-06	tk 25689-09	tk 25689-10

Fadenplatte 6,0 mm x 0,3 mm, glatt
Tying platform 6.0 mm x 0.3 mm, smooth
Plate-forme 6.0 mm x 0.3 mm, lisse
Plataforma 6.0 mm x 0.3 mm, lisa
Piano per sutura 6.0 mm x 0.3 mm, liscio

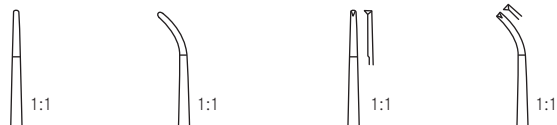

8 mm Ø	0.3 mm	0.3 mm	0.7 mm	0.7 mm
150 mm - 6"	tk 25686-07	tk 25686-08	tk 25686-11	tk 25686-12
180 mm - 7"	tk 25687-07	tk 25687-08	tk 25687-11	tk 25687-12
210 mm - 8¼"	tk 25688-07	tk 25688-08	tk 25688-11	tk 25688-12
230 mm - 9"	tk 25689-07	tk 25689-08	tk 25689-11	tk 25689-12

Fadenplatte 6,0 mm x 0,7 mm, glatt
Tying platform 6.0 mm x 0.7 mm, smooth
Plate-forme 6.0 mm x 0.7 mm, lisse
Plataforma 6.0 mm x 0.7 mm, lisa
Piano per sutura 6.0 mm x 0.7 mm, liscio

Mikronadelhalter mit Rundgriff
Micro needle holders with round handle

Micro porte aiguilles avec manche ronde
Micro porta agujas con mango redondo
 Micro porta aghi con manico rotondo



110 mm - 4 1/4"	8 mm Ø	tk 25637-11	tk 25638-11
125 mm - 5"	7 mm Ø	tk 25654-12	tk 25655-12
130 mm - 5"	8 mm Ø	tk 25658-13	tk 25659-13
130 mm - 5"	10 mm Ø	tk 25652-13	tk 25653-13
150 mm - 6"	8 mm Ø	tk 25640-15	tk 25641-15
180 mm - 7"	8 mm Ø	tk 25664-18	tk 25665-18
180 mm - 7"	10 mm Ø	tk 25668-18	tk 25669-18

ohne Sperre
without ratchet

sans crémaillère
sin cremallera
 senza cremagliera

gerade
straight

droit
recta
 retto

gebogen
curved

courbe
curva
 curvo

110 mm - 4 1/4"	8 mm Ø	tk 25635-11	tk 25636-11
125 mm - 5"	7 mm Ø	tk 25656-12	tk 25657-12
130 mm - 5"	8 mm Ø	tk 25662-13	tk 25663-13
130 mm - 5"	10 mm Ø	tk 25645-13	tk 25646-13
150 mm - 6"	8 mm Ø	tk 25642-15	tk 25643-15
180 mm - 7"	8 mm Ø	tk 25666-18	tk 25667-18
180 mm - 7"	10 mm Ø	tk 25670-18	tk 25671-18

mit Sperre
with ratchet

avec crémaillère
con cremallera
 con cremagliera

gerade
straight

droit
recta
 retto

gebogen
curved

courbe
curva
 curvo

Mikro-Federscheren
Micro-scissors

Micro ciseaux à ressorts
Micro tijeras con resorte
Forbici per microchirurgia

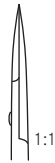
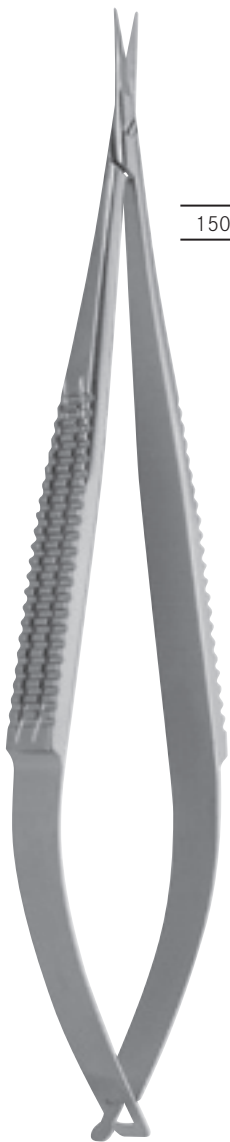

150 mm - 6"

tk 25670-15

gerade, kurze Schneide
straight, short blades
droites, lames courtes
recta, hojas cortas
retta, lama corta



tk 25671-15

gebogen, kurze Schneide
curved, short blades
courbes, lames courtes
curva, hojas cortas
curva, lama corta

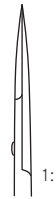

tk 25672-15

gerade, lange Schneide
straight, long blades
droites, lames longues
recta, hojas largas
retta, lama lunga

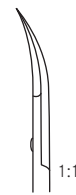

tk 25673-15

gebogen, lange Schneide
curved, long blades
courbes, lames longues
curva, hojas largas
curva, lama lunga

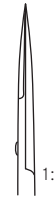

150 mm - 6"

tk 25678-15

gerade, gezahnt
straight, saw edge
droites, dentelés
recta, dentadas
retta, dentata

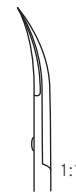

tk 25679-15

gebogen, gezahnt
curved, saw edge
courbes, dentelés
curva, dentadas
curva, dentata

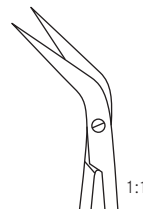

150 mm - 6"

tk 25675-15

180 mm - 7"

tk 25677-18

kniegebogen, 45°
angled on flat, 45°
angulaires, 45°
acodada, 45°
angolata, 45°

Mikro-Knüpfpinzetten
Micro suture tying forceps

Micro pinces pour sutures
Micro pinzas para suturas
 Pinze per micro-suture



1:1

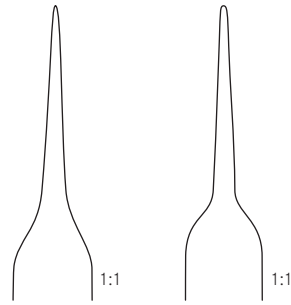





LAZAR		
	0.5 mm	0.8 mm
155 mm - 6"	tk 26016-01	tk 26016-02

Mikronadelhalter
Micro needle holders

Micro porte aiguilles
Micro porta agujas
Micro porta aghi



JACOBSON	 1:1	 1:1	 1:1	 1:1
	x = 1 mm	x = 1 mm	x = 1 mm	x = 1 mm
180 mm - 7"	tk 25740-01	tk 25740-02	tk 25740-13	tk 25740-14
ohne Sperre without ratchet	gerade straight	gebogen curved	gerade, diamantiert straight, diamond coated	gebogen, diamantiert curved, diamond coated
sans crémaillère sin cremallera senza cremagliera	droit recta retto	courbe curva curvo	droit, diamanté recta, diamantada retto, diamantato	courbe, diamanté curva, diamantada curvo, diamantato
	x = 1 mm	x = 1 mm	x = 1 mm	x = 1 mm
180 mm - 7"	tk 25740-03	tk 25740-04	tk 25740-15	tk 25740-16
mit Sperre with ratchet	gerade straight	gebogen curved	gerade, diamantiert straight, diamond coated	gebogen, diamantiert curved, diamond coated
avec crémaillère con cremallera con cremagliera	droit recta retto	courbe curva curvo	droit, diamanté recta, diamantada retto, diamantato	courbe, diamanté curva, diamantada curvo, diamantato
	x = 1 mm	x = 1 mm	x = 1 mm	x = 1 mm
180 mm - 7"	tk 25740-05 tucar	tk 25740-06 tucar	tk 25740-09 tucar	tk 25740-10 tucar
ohne Sperre without ratchet	gerade, glatt straight, smooth	gebogen, glatt curved, smooth	gerade, gerieft straight, serrated	gebogen, gerieft curved, serrated
sans crémaillère sin cremallera senza cremagliera	droit, lisse recta, liso retto, liscio	courbe, lisse curva, lisa curvo, liscio	droit, strié recta, estriada retto, zigrinato	courbe, strié curva, estriada curvo, zigrinato
	x = 1 mm	x = 1 mm	x = 1 mm	x = 1 mm
180 mm - 7"	tk 25740-07 tucar	tk 25740-08 tucar	tk 25740-11 tucar	tk 25740-12 tucar
mit Sperre with ratchet	gerade, glatt straight, smooth	gebogen, glatt curved, smooth	gerade, gerieft straight, serrated	gebogen, gerieft curved, serrated
avec crémaillère con cremallera con cremagliera	droit, lisse recta, liso retto, liscio	courbe, lisse curva, lisa curvo, liscio	droit, strié recta, estriada retto, zigrinato	courbe, strié curva, estriada curvo, zigrinato



1:1

Instrumenten-Kassetten aus Edelstahl
Instrument trays made of stainless steel

Contenaires d'instruments en acier inox
Caja para instrumental en acero inox
Scatole per sterilizzazione di acciaio inossidabile

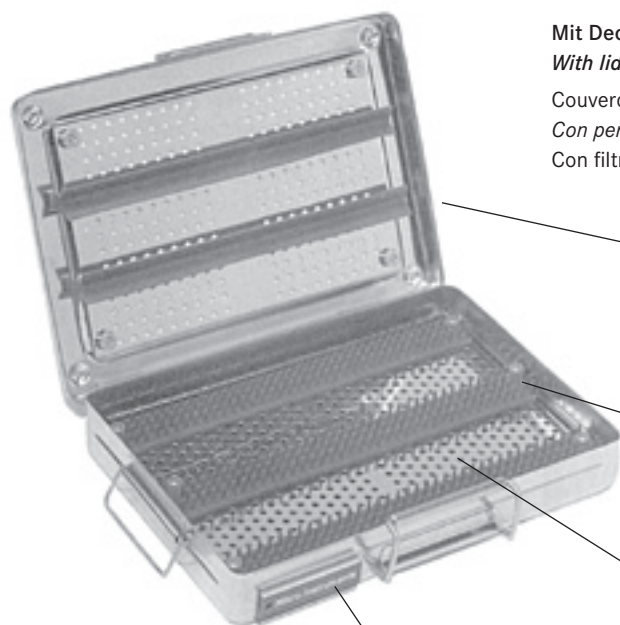

Mit Deckel- und Bodenlochung mit Textil-Langzeitfiltern für Dampfsterilisation
With lid and bottom perforation with textil "Longterm" filters for steam sterilisation
Couvercle et boîtier perforé avec filtre en textile pour stérilisation à vapeur
Con perforación en tapa y fondo, con filtros en tejido para esterilización a vapor
Con filtri tessili, per la sterilizzazione a vapore

Silikon-Andrückleisten zum Fixieren der Instrumente
Silicone protective strips for fixation of instruments

Tapis en silicone pour fixer les instruments
Tiras de silicon para fijar los instrumentos
Strisce di silicone per fissare gli strumenti

Silikon-Noppenstreifen zur schonenden Auflage der Instrumente
Silicon strips for a soft and protective storage of the instruments

Tapis en silicone pour la protection des instruments
Matas de silicon para proteger los instrumentos
Stuoie di silicone per proteggere gli strumenti

1 herausnehmbare Siebplatte
1 removable tray insert

1 tableau pour sortir
1 placa para sacar
1 cestello

Kennzeichnungsschilder nach Wahl (Farbe und Text)
Marking plate for selection: colour and description

Plaquette d'identification (texte et couleur selon demande)
Placas de identificación a opción (color y texto)
Placche d'identificazione (colore a scelta)

280x195x55 mm	265x255x55 mm	380x260x55 mm	200x140x55 mm	470x250x55 mm
tk 85100-01	tk 85101-01	tk 85102-01	tk 85103-01	tk 85104-01

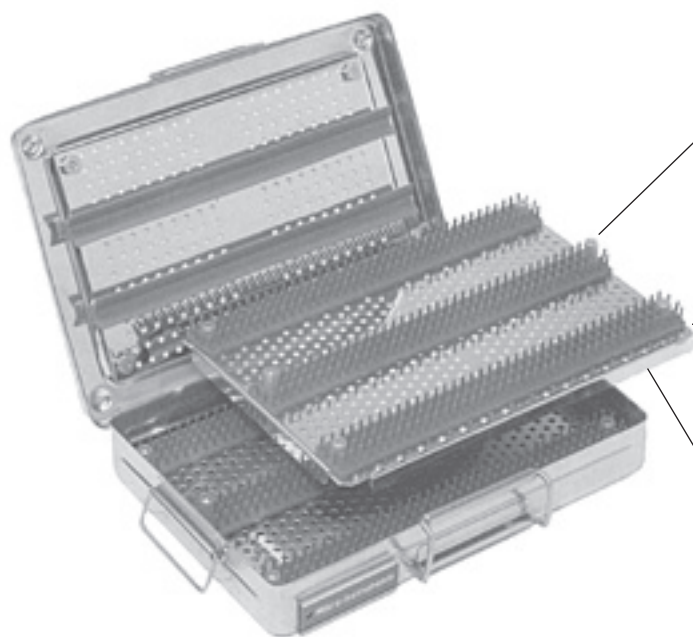

wärmeisolierende Halteknöpfe zum Herausheben
heatisolated handles

pins isolés pour sortir des tableaux
pernos aislados para sacar las placas
maniglia a forma di botone

2 herausnehmbare Siebplatten
2 removable tray inserts

2 tableaux detachables
2 placas para sacar
2 cestelli

Silikon-Andrückleisten an der Unterseite des Siebes
Silicone protective strips at the lower side of the tray

Tapis de silicone à la partie inférieure des tableaux
Tiras de silicon a bajo de las placas
Strisce di silicone sulla parte inferiore dell'inserto

280x195x65 mm	265x255x65 mm	380x260x65 mm	200x140x65 mm	470x250x65 mm
tk 85100-03	tk 85101-03	tk 85102-03	tk 85103-03	tk 85104-03

Verschiedene Behälter
Different containers

 Boîtes diverses
 Contenedores varios
 Vassoi diversi

30 mm Ø x 90 mm	tk 83142-08
50 mm Ø x 100 mm	tk 83142-11
50 mm Ø x 130 mm	tk 83142-12
50 mm Ø x 175 mm	tk 83142-16
75 mm Ø x 100 mm	tk 83143-14
75 mm Ø x 130 mm	tk 83143-17
75 mm Ø x 200 mm	tk 83143-20

18/8 rostfrei, Standgefäße, ohne Deckel
 18/8 stainless steel, mugs, without cover
 18/8 inoxydable, boîtiers, sans couvercle
 18/8 inoxidable, cilindros sin tapa
 18/8 inossidabile, recipienti cilindrici



95 mm Ø x 60 mm	tk 83160-90
-----------------	--------------------

Sputumbecher, matt, 18/8 rostfrei
 Sputum mugs, tarnished, 18/8 stainless steel
 Coupoles, depoli, 18/8 inoxydable
 Escupideras, mate, 18/8 inoxidable
 Sputacchiera, 18/8 inossidabile



0,05l	50 mm Ø x 50 mm	tk 83155-50
-------	-----------------	--------------------

Medizinbecher, graduert, matt, 18/8 rostfrei
 Medicine cup, graduated, tarnished, 18/8 stainless steel
 Timbale, graduée, depolie, 18/8 inoxydable
 Vaso, graduado, mate, 18/8 inoxidable
 Recipiente, graduato, 18/8 inossidabile



95 mm Ø x 60 mm	tk 83153-09
105 mm Ø x 60 mm	tk 83153-10
120 mm Ø x 120 mm	tk 83153-12
160 mm Ø x 140 mm	tk 83153-15

Wattedosen mit Knopfdeckel, 18/8 rostfrei
 Dressing jars with cover, 18/8 stainless steel
 Boîtes à pansements avec couvercle, 18/8 inoxydable
 Dispensadores de algodón, 18/8 inoxidable
 Dispensori di cotone, 18/8 inossidabile

Verschiedene Behälter
Different containers

Boîtes diverses
Contentedores varios
Vassoi diversi



0.75l	165 mm Ø x 60 mm	tk 83105-15
1.00l	175 mm Ø x 70 mm	tk 83105-17
2.00l	220 mm Ø x 80 mm	tk 83105-18
3.00l	240 mm Ø x 110 mm	tk 83105-26
4.50l	275 mm Ø x 115 mm	tk 83105-28
6.00l	290 mm Ø x 125 mm	tk 83105-30
6.00l	310 mm Ø x 120 mm	tk 83105-32
8.50l	345 mm Ø x 125 mm	tk 83105-36
11.00l	380 mm Ø x 130 mm	tk 83105-39

Schüsseln und Laborschalen, matt, 18/8 rostfrei
Bowls, tarnished, 18/8 stainless steel

Coupoles, depoli, 18/8 inoxydable
Palanganas, 18/8 inoxidable
Scodelle, inossidabile 18/8



0.05l	40 mm Ø x 19 mm	tk 83110-02
0.07l	61 mm Ø x 30 mm	tk 83110-05
0.14l	80 mm Ø x 40 mm	tk 83110-09
0.35l	116 mm Ø x 50 mm	tk 83110-13
0.45l	128 mm Ø x 55 mm	tk 83110-15
0.70l	147 mm Ø x 65 mm	tk 83110-20



170 mm x 95 mm x 25 mm	tk 83165-17
200 mm x 95 mm x 30 mm	tk 83165-20
250 mm x 125 mm x 35 mm	tk 83165-25
275 mm x 140 mm x 40 mm	tk 83165-27

Nierenschalen, matt, 18/8 rostfrei
Kidney bowls, tarnished, 18/8 stainless steel

Haricots, depoli, 18/8 inoxydable
Riñoneras, 18/8 inoxidable
Baccinella reniforme, 18/8 inossidabile



Bitte fordern Sie unseren Spezialkatalog an.
Please ask for our special catalogue.

Veuillez demander pour notre catalogue spécial.
Por favor preguntan para el catalogo especial.
Per favore domandate per il nostro catalogo speciale.

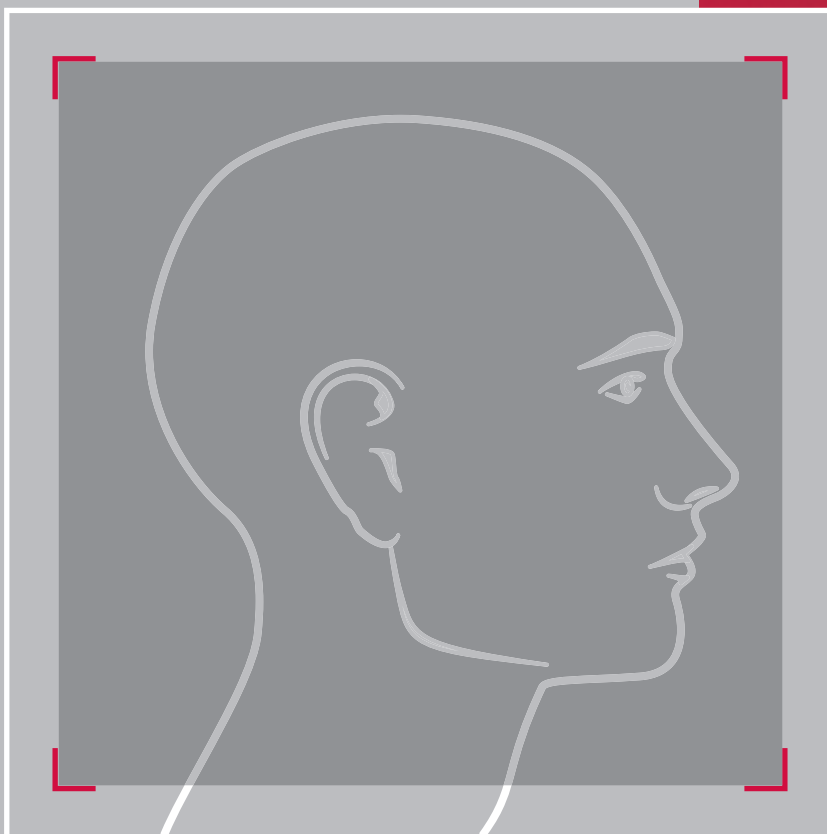

Endoskopie
Endoscopy

Endoscopie
Endoscopia
Endoscopia



Technische Merkmale *Technical features*

Caractéristiques techniques *Características técnicas* Caratteristiche tecniche

Spezielle Eigenschaften

Aufgrund unserer langjährigen Erfahrung erfüllen unsere Optiken alle Voraussetzungen für ein qualitativ hochwertiges Produkt:

- **Kompakt-Objektive**
Die in unseren Endoskopen verwendete neue Generation von Kompakt-Objektiven bietet die Gewähr für volle Autoklavierbarkeit, auch über einen langen Zeitraum hinweg und gibt damit dem Anwender die Sicherheit für eine lange Lebensdauer des Produktes.
- **Stablinnen-System**
Neuberechnete Stablinnen-Systeme garantieren eine nicht zu übertreffende Bildhelligkeit.
- **Großbildoptik**
Eine hohe Vergrößerung garantiert dem Anwender ein angenehmes Arbeiten, auch wenn sich der Monitor nicht direkt am Operationsfeld befindet.
- **Distal und proximal Saphirgläser**
- **Anwendungsbezogene Blickwinkel bei allen Optiken**
- **Exzellente Brillanz und Auflösung**
- **Natürliche Farbwiedergabe bei gleichmäßiger Bildschärfe**
- **Optimale Tiefenschärfe, ebenfalls ausgerichtet an den Erfordernissen des Einsatzgebietes**

Qualités particulières

A cause de notre longue expérience, nos optiques répondent à toutes exigences pour des produits de haute gamme

- **objectif compact**
la nouvelle génération des objectifs utilisés dans nos endoscopes garantie que les produits peuvent être autoclavés, même pendant une très longue période, et donne à l'utilisateur la sécurité pour une longue vie du produit.
- **système des lentilles en tiges**
ce système, nouvellement évalué, garantit la meilleure clarté de l'image
- **grandeur de l'image**
le grossissement le plus grand possible garantit un travail agréable pour l'utilisateur, surtout quand l'écran ne se trouve pas à coté de l'opérateur.
- **différents angles, selon les besoins du travail**
- **illumination brillante et très haute résolution**
- **reproduction des couleurs naturelles en netteté constante de l'image**
- **profondeur de champ optimale, selon les nécessités de l'opération**

Particular attributes

Due to our long experience, our scopes meet all technical requirements of a first class product:

- **compact objectives**
the new generation of compact objectives used in our endoscopes provides the guarantee of full autoclavability even for a long period and gives the user the security of a long life of the product.
- **rod lens system**
the new evaluated rod lens systems guarantees an illumination which really is second to none.
- **large image size**
a high enlargement guarantees a comfortable working, even if the monitor is not so close to the operation field.
- **distal and proximal saphire windows**
- **comfortable direction of view on all scopes according to the necessity of the operation**
- **brilliant illumination and crystal clear resolution**
- **true colour reflection and regular focus on the whole image**
- **optimal depth of field, also according to the necessity of the operation**

Características particulares

En base a nuestra larga eperiencia, nuestras ópticas satisfacen todas las normas de los productos de alta calidad.

- **objetivos compactos**
la nueva generación de objetivos, incorporados en nuestras ópticas, ofrece la garantía de esterilización por autoclave durante un largo periodo de tiempo y da de durabilidad al producto.
- **sistema de lentes a varillas**
este nuevo sistema garantiza la mejor luminosidad de la imagen.
- **dimensión de la imagen**
el aumento de la dimensión da la imagen, garantiza un trabajo agradable, aunque el monitor está posicionado lejos de la mesa.
- **diferentes ángulos visuales según las necesidades de trabajo**
- **iluminación brillante y una resolución muy alta**
- **reproducción de los colores naturales a una nitidez constante de la imagen**
- **profundidad del campo según las necesidades de trabajo**



Kompakt-Objektiv
Compact objective
Objectif compact
Objetivo compacto
Obiettivo compatto

Technische Merkmale *Technical features*

Caractéristiques techniques
Características técnicas
Caratteristiche tecniche

Caratteristiche particolari

Grazie alla nostra lunga esperienza, i nostri endoscopi presentano tutte le caratteristiche dei prodotti di alto livello:

- obiettivi compatti: la nuova generazione di obiettivi compatti usata nei nostri endoscopi garantisce la totale autoclavabilità anche per un lungo periodo e da all'utilizzatore la certezza di una lunga durata del prodotto
- sistema rod lens: la nuova generazione del sistema di rod lens assicura una illuminazione che non è seconda a nessun altro prodotto
- immagine di grandi dimensioni: un elevato fattore di ingrandimento permette un lavoro confortabile, anche se il monitor non è vicino all'operatore
- leni prossimali e distali in zaffiro
- angolo di visione perfetto, specifico per ogni campo di utilizzo
- illuminazione brillante e risoluzione cristallina
- trasmissione dei colori reale, e immagine perfettamente a fuoco su tutto il campo
- profondità di campo ottimale, studiata per le necessità dei diversi campi di utilizzo

Kompatibilität *Compatibility*

Compatibilité
Compatibilidad
Compatibilità

Ergänzend zu unserem umfassenden Optikenprogramm fertigen wir auf Anfrage kompatible Endoskope zu nachfolgenden Fremdmarken.

In addition to our extensive program of endoscopes, we can manufacture endoscopes compatible to the following brands on demand.

Complémentaire à notre programme vaste d'endoscopes, nous pouvons produire des endoscopes compatibles aux marques suivantes sur demande.

Adicional a nuestro programa amplio de endoscopios, podemos producir endoscopios compatibles a las marcas siguientes a petición.

Adicional a nuestro programa amplio de endoscopios, podemos producir endoscopios compatibles a las marcas siguientes a petición.

STANDARD

Storz / Tekno



Richard Wolf



Olympus



ACMI / Circon



Dyonics



Stryker



Kompatibilität
Compatibility

Compatibilité
Compatibilidad
Compatibilità

Tekno
Storz
Olympus

Wolf

ACMI

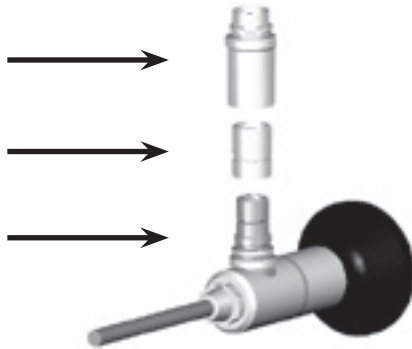

Kompatibler Lichtleiteranschluss

Compatible light guide connection

Connecteur de lumière froide compatible

Conexión de luz fría compatible

Connettore compatibile cavo luce

Anweisung zum Autoklavieren
Instructions for autoclaving

Instructions importantes pour l'autoclavage

Instrucciones importantes

Istruzioni per autoclavare

1. Alle autoklavierbaren Optiken sind mit der Ätzung "autoclave 134°C/273°F 18 min" gekennzeichnet.
2. Die Optiken sollten nur bei 134°C/273°F (±5°) über die max. Dauer von 18 Minuten autoklaviert werden. Nichteinhaltung dieser Dauer kann Ihre Optik zerstören.
3. Die Optiken sollten nicht bei 120°C/248°F autoklaviert werden, da durch die längere Sterilisationszeit die Optiken erheblich mehr belastet werden.
4. Die Optiken müssen vor dem Autoklavieren sorgfältig gereinigt werden. Zur Beseitigung von äußerlichen Verschmutzungen dürfen auf keinen Fall harte Gegenstände verwendet werden. Zur Reinigung der optischen Endfläche (distal und proximal) empfehlen wir mit Alkohol angefeuchtete Wattetupfer. Auf keinen Fall dürfen die Optiken im Ultraschallbad gereinigt werden! Dies führt ebenfalls zur Zerstörung der Optik. Schlecht gereinigte Endflächen beeinträchtigen die Bildqualität; es kommt zu einer Trübung der Optik.
5. Die vorgereinigten Optiken werden in geeignete Sterilisationsbehälter oder Sterilisationstücher eingelegt. Dabei ist zu beachten, daß keine Hitzebrücke zwischen der Optik und dem Sterilisationsbehälter entsteht.
6. Nach Abschluß der Sterilisation müssen die Optiken im Sterilisator langsam auf Raumtemperatur abgekühlt werden. Eine schockartige Abkühlung zerstört die Optik!
7. Bitte beachten Sie desweiteren die Bedienungsanleitung Ihres Sterilisators und lassen Sie diesen von Zeit zu Zeit überprüfen.

1. All autoclavable scopes are etched "autoclave 134°C/273°F 18 min".
2. All scopes may only be autoclaved at 134°C/273°F (±5°) for a maximum of 18 minutes. Failure to follow these parameters may destroy the scope.
3. Scopes should not be autoclaved at 120°C/248°F, as the prolonged sterilization time may damage the scopes.
4. The endoscopes must be thoroughly cleaned before autoclaving. Under no circumstances a hard object should be used for this purpose. We recommend the use of alcohol and cotton pads for the cleaning of optical surfaces (distal and proximal). Under no circumstances scopes may be cleaned with ultrasonic waves as this may also destroy them! Poorly cleaned surfaces lead to significant impairment and to dimming of the lenses.
5. The pre-cleaned scopes are placed in sterilization trays and containers or sterilization clothes specially designed for this purpose. Make sure to avoid any thermal bridge between the scopes and the sterilization container.
6. After the sterilization the scopes should cool slowly to room temperature while staying in the autoclave. Rapid cooling will destroy the scopes.
7. Please follow the instruction manual of the sterilization equipment and keep it controlled from time to time.

Anweisung zum Autoklavieren
Instructions for autoclaving

Instructions importantes pour l'autoclavage
Instrucciones importantes
Istruzioni per autoclavare

1. Toutes les optiques autoclavables sont marquées "autoclavable 134°C/273°F 18 min"
2. Les optiques doivent être autoclavées seulement à 134°C / 273°F pendant 18min max. Une prolongation de ce temps peut endommager l'optique.
3. Les optiques ne doivent pas être autoclavées à 120°C / 248°F, la prolongation du temps de stérilisation peut causer des dégats aux optiques.
4. Les optiques doivent être nettoyées soigneusement avant d'être autoclavées. Le nettoyage ne doit pas être fait avec des objets durs. Pour le nettoyage des surfaces optiques proximal et distal, il est conseillé d'utiliser des tampons d'ouate, trempés dans l'alcool. Ne jamais nettoyer des optiques dans un bain d'ultra-son! Cela mène à la détruite de l'optique. Un nettoyage insuffisant des surfaces optiques nuit à la qualité de l'image, l'optique sera troublée.
5. Les optiques nettoyées doivent être positionnées dans des contenaires appropriés. Vérifier que les optiques ne soient pas en contact avec le métal pendant la stérilisation.
6. Après la stérilisation laisser refroidir les optiques lentement à la température ambiante. Un refroidissement trop rapide endommage l'optique.
7. Respecter les modes d'emploi du fabricant des stérilisateur et laisser les contrôler régulièrement.

1. Todas las ópticas autoclavables llevan la marcación "autoclavable 134°C / 273°F 18 min"
2. Las ópticas tienen que ser esterilizadas solamente a 134°C / 273°F durante un máximo tiempo de 18min. Una prolongación de este tiempo daña las ópticas.
3. Las ópticas no pueden ser esterilizadas a 120° / 248°F. Este método de esterilización daña las ópticas.
4. Las ópticas han de ser limpiadas cuidadosamente antes de meterlas en el autoclave. Nunca limpiar una óptica con un objeto duro. El uso de una valleta de algodón impregnada en alcohol esta recomendado para limpiar los cristales ópticos proximales y distales. En ningún caso limpiar una óptica en un baño ultrasónico, este puede destruir la óptica. Una limpieza insuficiente de los cristales ópticos conduce a una reducción de la calidad de la imagen y a un deslucimiento de las lentes.
5. Poner las ópticas pre-limpiadas en un contenedor apropiado. Observar que las ópticas no esten en contacto con otras piezas metálicas.
6. Después de la esterilización, las ópticas tienen que enfriarse paulatinamente a la temperatura ambiente. Una refrigeración rápida destruye la óptica.
7. Leer atentamente las instrucciones del fabricante del los esterilizadores y controlar le regularmente.

1. Tutti gli endoscopi autoclavabili sono marchiati: "134°C/273°F 18 min"
2. Tutti gli endoscopi possono solamente essere autoclavati a 134°C/273°F (+/- 5°C) per un massimo di 18 minuti (di esposizione a tale temperatura), o a 137°C per 3 minuti. Errori nel seguire questi parametri potrebbero distruggere gli endoscopi
3. Gli endoscopi non devono essere autoclavati a 121 °C/248°F , poiché il tempo prolungato di sterilizzazione potrebbe danneggiarli
4. Tutti gli endoscopi devono essere accuratamente puliti prima di venire autoclavati. In nessun caso deve essere utilizzato uno strumento metallico per questo scopo. Noi raccomandiamo l'utilizzo di alcool e pezzi di cotone per la pulizia delle superfici ottiche (distali e prossimali). Gli endoscopi non devono mai essere puliti con macchine ad ultrasuoni, poiché questo potrebbe distruggerli. Superfici scarsamente pulite causano una progressiva diminuzione della brillantezza delle lenti.
5. Gli endoscopi pre-puliti devono essere sistemati negli appositi container di sterilizzazione o nella speciale carta di sterilizzazione. Assicurarsi di evitare qualsiasi poste termico tra le ottiche ed il container.
6. Dopo la sterilizzazione gli endoscopi devono essere lasciati raffreddare lentamente alla temperatura ambiente rimanendo in autoclave. Un rapido raffreddamento può distruggere gli endoscopi
7. Per favore seguire il manuale di istruzioni della sterilizzatrice e controllarla di tanto in tanto
8. Una volta alla settimana gli endoscopi dovrebbero venire lavati con acqua distillata per rimuovere i sali minerali

autoklavierbar / autoclavable
134°C / 273°F - 18 min.

Alle mit diesem Zeichen versehenen Produkte sind garantiert autoklavierbar. Wir garantieren 24 Monate volle Autoklavierbarkeit für diese Optiken. (Siehe Anweisung zum Autoklavieren)

Compatible light guide All products with this sign are fully autoclavable. We guarantee 24 months of full autoclavability for these scopes. (See instructions for autoclaving)

Connecteur de lumière froide Tous les produits portant ce marquage sont garantis autoclavables. Nous garantissons ce fait pour une période de 24 mois.(Voir les instructions pour l'autoclavage)

Conexión de luz fría Todos los productos con esta marcación están garantizados para la esterilización en autoclave. Garantizamos eso para un tiempo de 24 meses.(Ver las directivas)

Tutti i nostri prodotto con questo marchio sono totalmente autoclavabili. Noi garantiamo per 24 mesi i nostri prodotti contro i danni derivanti dall'autoclave (Leggere le istruzioni prima di autoclavare)

TEKNO-FLEX

Die Vorteile von Tekno-Flex Endoskope (patentiert):

- weniger anfällig gegen äußere mechanische Einwirkungen, wie Verbiegen
- höhere Flexibilität im Vergleich zu Standard Endoskopen
- höhere Widerstandsfähigkeit (70% aller Reparaturen basieren auf gebrochenen Stablinsen, verursacht durch gebogene Schäfte)
- kratzsicheres Saphirglas am distalen Ende und am Okular
- korrekte Farbwiedergabe und gleichmäßige Bildschärfe
- 1 Jahr Garantie auf gebrochene Stablinsen
- Tekno-Flex Optiken sind durch den Zusatz "SF" gekennzeichnet

The advantages of Tekno-Flex endoscopes (patented):

- *the optical system is less sensitive to bending*
- *higher flexibility compared to standard rigid endoscopes*
- *higher robustness (70% of all repairing is due to broken rod-lenses caused by bent tubes)*
- *scratch-proof sapphire glass on the distal end and ocular side*
- *high resolution and contrast reproduction*
- *1 year warranty against broken rod-lenses*
- *Tekno-Flex scopes can be recognized by the suffix "SF"*

Les avantages des endoscopes Tekno-Flex (brevetés):

- haute résistance contre influences mécaniques
- meilleure souplesse comparé avec des endoscopes rigides
- meilleure résistance (70% de toutes réparations sont provoquées par des ruptures des lentilles cylindriques)
- verres distales et proximales en saphir
- reproduction parfaite des couleurs et profondeur de champ exceptionnel
- 1 an de garantie sur ruptures des lentilles cylindriques
- les optiques Teko-Flex peuvent être reconnues par l'annexe "SF"

Las ventajas de los endoscopios Tekno-Flex (patentados):

- *gran resistencia al estrés mecánico*
- *mayor flexibilidad en comparación a ópticas tradicionales*
- *mayor resistencia (70% de todas las reparaciones son debidas a roturas de lentes cilíndricas)*
- *las lentes distales y proximales son de zafiro de alta resistencia*
- *perfecta reproducción de color y extraordinaria profundidad de campo*
- *1 año de garantía sobre roturas de lentes cilíndricas*
- *las opticas Tekno-Flex son reconocidos por el anexo "SF"*

I vantaggi degli endoscopi Tekno-Flex (brevettato):

- maggiore resistenza contro stress meccanico
- accetta una grande flessione rispetto ad ottiche tradizionali
- elevata robustezza (70% di tutte le riparazioni é dovuto a rotture delle rod-lenses)
- lenti distale e prossimale in zaffiro ad alta resistenza
- perfetta riproduzione dei colori e immagine a fuoco a tutto campo
- 1 anno di garanzia su rottura delle rod-lens
- le ottiche Tekno-Flex hanno un numero d'articolo con "SF" aggiunto

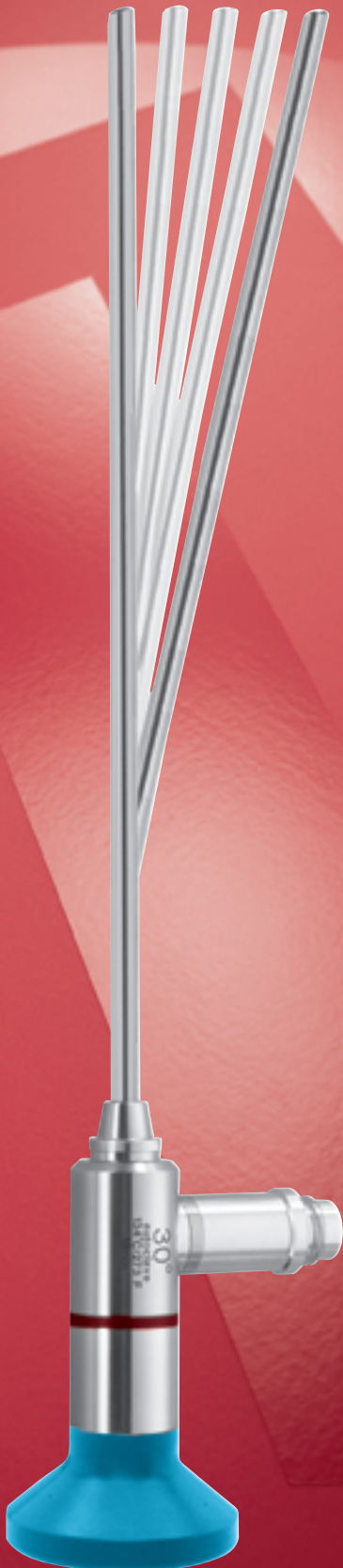

Sinuskope
Sinusscopes

Sinusscopes
Sinuscopios
Sinuscopi

autoklavierbar / autoclavable
134°C / 273°F - 18 min.

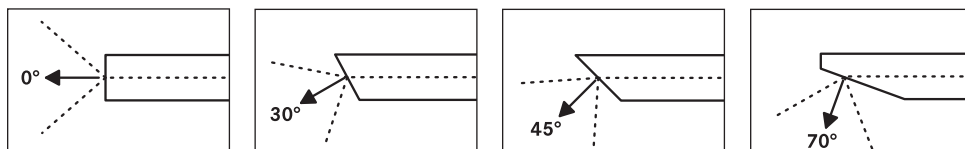

Ø 2.4 mm - 98 mm	tk 700-098	tk 700-099		
Ø 2.7 mm - 110 mm	tk 700-100	tk 700-103		tk 700-107
Ø 2.7 mm - 141 mm	tk 700-101	tk 700-105		
Ø 2.7 mm - 175 mm	tk 700-110	tk 700-113		tk 700-117
Ø 2.7 mm - 187.5 mm	tk 700-120	tk 700-123		tk 700-127
Ø 4.0 mm - 175 mm	tk 700-130	tk 700-133	tk 700-134	tk 700-137
Ø 2.7 mm - 110 mm	tk 700-100SF	tk 700-103SF		
Ø 2.7 mm - 175 mm	tk 700-110SF	tk 700-113SF		
Ø 2.7 mm - 187.5 mm	tk 700-120SF	tk 700-123SF		
Ø 4.0 mm - 175 mm	tk 700-130SF	tk 700-133SF	tk 700-134SF	tk 700-137SF

Ø, Arbeitslänge
Ø, Working length
Ø, Longueur de travail
Ø, Longitud de trabajo
Ø, Lunghezza operativa

SF = Tekno-Flex

Mini-Optiken
Mini scopes

Mini optiques
Mini opticás
Mini ottiche

autoklavierbar / autoclavable
134°C / 273°F - 18 min.

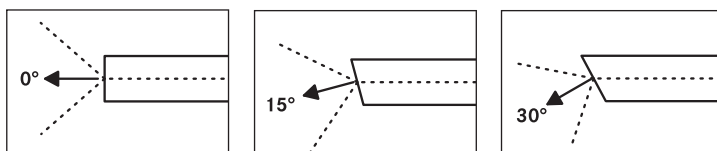

Ø 1.7 mm - 58 mm	tk 700-160	tk 700-165		
Ø 1.7 mm - 104 mm	tk 700-170	tk 700-175		
Ø 1.9 mm - 69 mm	tk 700-196			tk 700-198
Ø 1.9 mm - 102 mm	tk 700-197			tk 700-199
Ø 2.0 mm - 58 mm	tk 700-180	tk 700-185		
Ø 2.0 mm - 104 mm	tk 700-190	tk 700-195		

Ø, Arbeitslänge
Ø, Working length
Ø, Longueur de travail
Ø, Longitud de trabajo
Ø, Lunghezza operativa

Otoskope
Otoscopies
Otoscopios
Otoscopi

autoklavierbar / autoclavable
134°C / 273°F - 18 min.

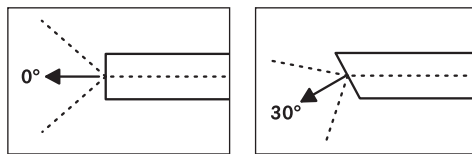

Ø 2.7 mm - 50 mm	tk 700-080	tk 700-083
Ø 4.0 mm - 50 mm	tk 700-090	tk 700-093

Ø, Arbeitslänge
Ø, Working length
Ø, Longueur de travail
Ø, Longitud de trabajo
Ø, Lunghezza operativa

autoklavierbar / autoclavable
134°C / 273°F - 18 min.

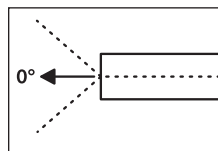
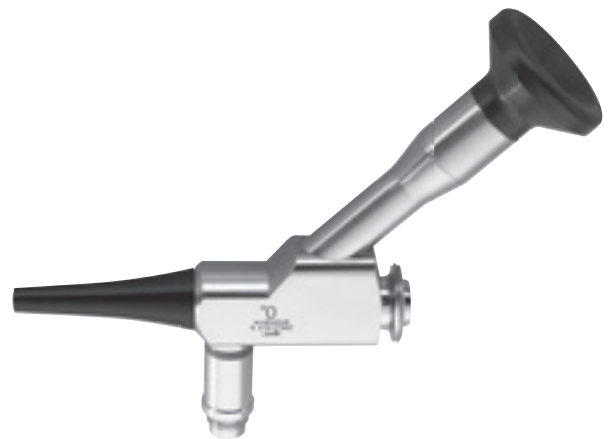

Ø 4.3 mm - 40 mm	Ø 1.8 mm	tk 700-094
------------------	----------	-------------------

Ø, Arbeitslänge
Ø, Working length
Ø, Longueur de travail
Ø, Longitud de trabajo
Ø, Lunghezza operativa

Instrumentenkanal
Instrument channel
Canal d'instrument
Canal para instrumentos
Canale operativo

Laryngoskope
Laryngoscopes

Laryngoscopes
Laringoscopios
Laringoscopi

autoklavierbar / autoclavable
134°C / 273°F - 18 min.

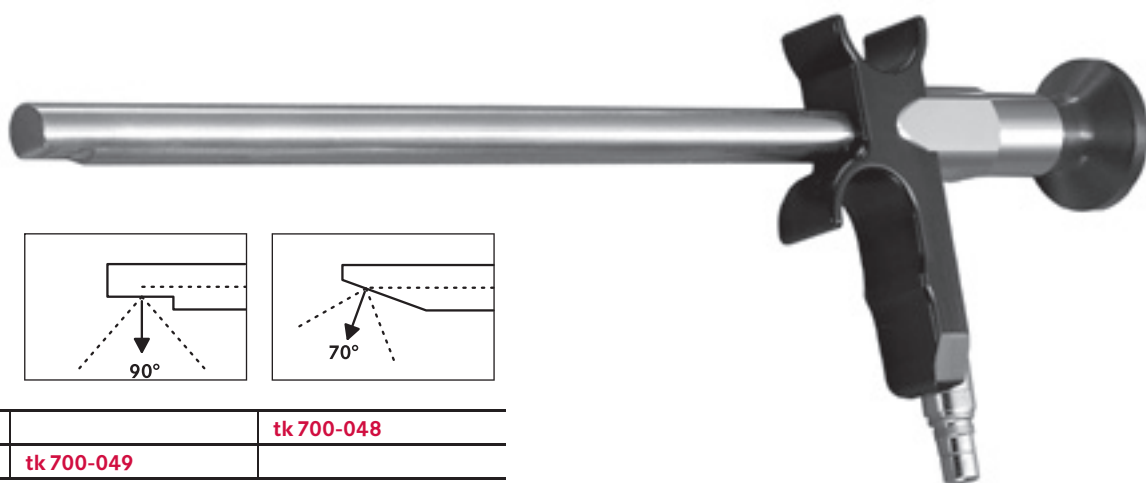

Ø 8.0 mm - 190 mm		tk 700-048
Ø 10.0 mm - 190 mm	tk 700-049	

Ø, Arbeitslänge
Ø, Working length
Ø, Longueur de travail
Ø, Longitud de trabajo
Ø, Lunghezza operativa

autoklavierbar / autoclavable
134°C / 273°F - 18 min.

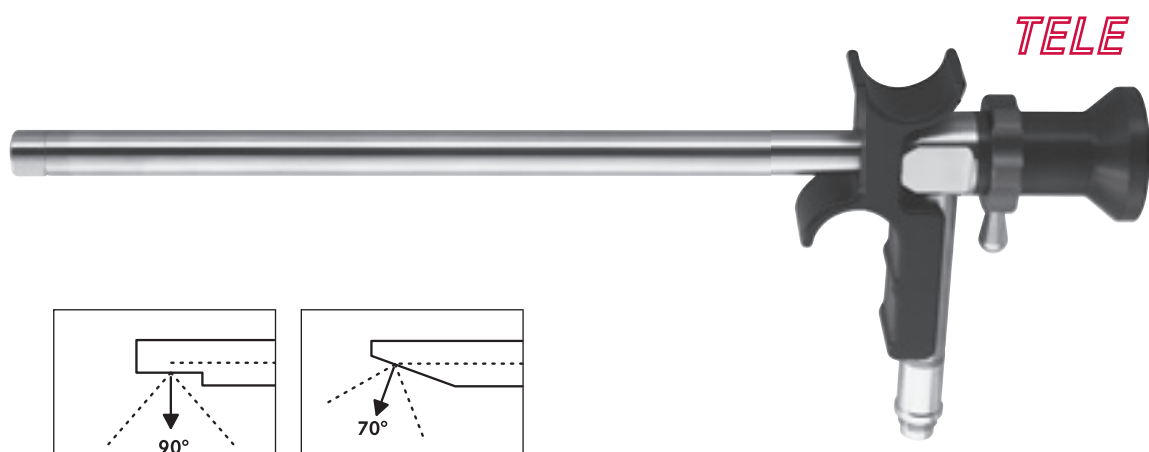

Ø 11.0 mm - 200 mm	tk 700-051	tk 700-054
--------------------	------------	------------

Ø, Arbeitslänge
Ø, Working length
Ø, Longueur de travail
Ø, Longitud de trabajo
Ø, Lunghezza operativa

Mikro-Laryngoskope
Micro laryngoscopes

Micro laryngoscopes
Micro laringoscopios
 Micro laringoscopi

autoklavierbar / autoclavable
 134°C / 273°F - 18 min.

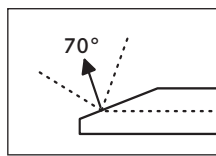
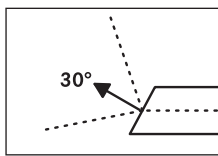

Ø 4.0 mm - 175 mm		tk 700-055
Ø 5.0 mm - 240 mm	tk 700-057	tk 700-058
Ø 5.8 mm - 175 mm		tk 700-056

Ø, Arbeitslänge
 Ø, *Working length*
 Ø, Longueur de travail
 Ø, *Longitud de trabajo*
 Ø, Lunghezza operativa

Bronchoskope | Bronchoscopes
Bronchoscopes
 Broncoscopios
 Broncoscopi

autoklavierbar / autoclavable
 134°C / 273°F - 18 min.

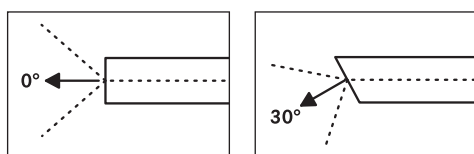
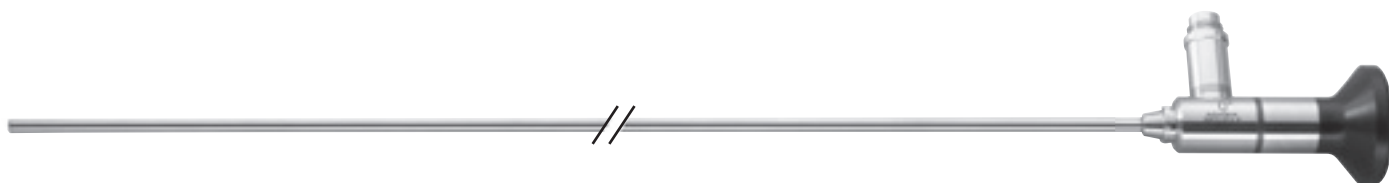

Ø 2.9 mm - 365 mm	tk 700-157	tk 700-158
Ø 4.0 mm - 490 mm	tk 700-155	
Ø 5.5 mm - 505 mm	tk 700-150	tk 700-153

- Ø, Arbeitslänge
- Ø, Working length
- Ø, Longueur de travail
- Ø, Longitud de trabajo
- Ø, Lunghezza operativa

Oesophagoskop | Oesophagoscope
Oesophagoscope
 Esofagoscopio
 Esofagoscopio

autoklavierbar / autoclavable
 134°C / 273°F - 18 min.

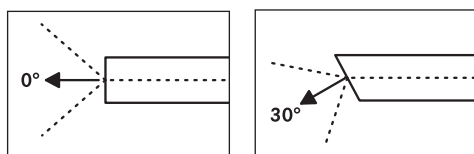
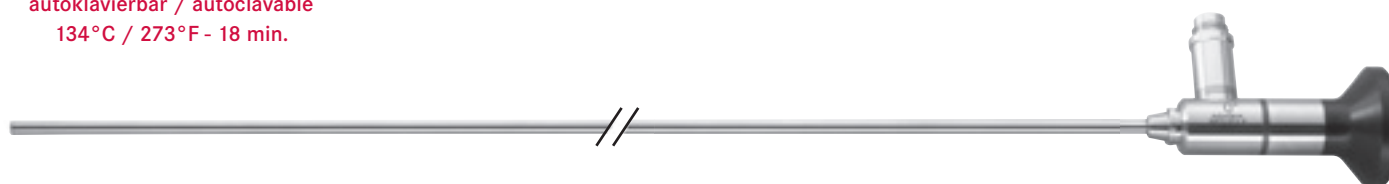

Ø 5.5 mm - 530 mm	tk 700-140	tk 700-143
-------------------	-------------------	-------------------

- Ø, Arbeitslänge
- Ø, Working length
- Ø, Longueur de travail
- Ø, Longitud de trabajo
- Ø, Lunghezza operativa

Naso-Pharyngoskope
Naso-pharyngoscopes

Nasopharyngoscopes
Nasofaringoscopios flexibles
Nasofaringoscopio flessibile

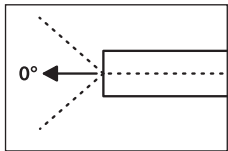

Konventionelles Bildbündel, mit 2-fach Abwinkelung (160°), Einhandbedienung, einlegbar und gassterilisierbar
Conventional bundle, 2-way deflection (160°), one-hand control, soakable, gas-sterilization.

Localisation conventionelle, dirigable en 2 directions (160°). Commande avec 1 main, sterilisable à froide ou à gaz
Transmisión a fibra optica, dirigible en 2 direcciones (160°), manejable con 1 mano, sumergible, esterilizable a gas
Fascio di fibre convenzionale, doppia angolazione (160°), controllabile con una sola mano, sterilizzabile a gas, immergibile

Ø 3.2 mm – 300 mm	20 mm	3 mm – 60 mm	8000	tk 700-269
Ø, Arbeitslänge	Länge d. abwinkelbaren Spitze	Tiefenschärfe	Pixel	
Ø, Working length	Length of movable tip section	Depth of focus	Pixels	
Ø, Longueur de travail	Longueur du tip mobil	Profondeur de champ	Pixel	
Ø, Longitud de trabajo	Longitud de la punta movil	Profundidad de campo	Pixel	
Ø, Lunghezza operativa	Lunghezza della punta mobile	Profondità di campo	Pixels	

Konventionelles Bildbündel, Abwinkelung (140°), Instrumentenkanal, Einhandbedienung, einlegbar und gassterilisierbar
Conventional bundle, deflection (140°), instrument channel, one-hand control, soakable, gas-sterilization.

Localisation conventionelle, dirigable (140°). canal d'instrument, commande avec 1 main, sterilisable à froide ou à gaz
Transmisión a fibra optica, dirigible (140°), canal para instrumentos, manejable con 1 mano, sumergible, esterilizable a gas
Fascio di fibre convenzionale, angolazione (140°), canale operativo, controllabile con una sola mano, sterilizzabile a gas, immergibile

Ø 4.3 mm – 400 mm	Ø 1.4 mm	3 mm – ∞	7800	tk 700-267
Ø, Arbeitslänge	Instrumentenkanal	Tiefenschärfe	Pixel	
Ø, Working length	Instrument channel	Depth of focus	Pixels	
Ø, Longueur de travail	Canal d'instrument	Profondeur de champ	Pixel	
Ø, Longitud de trabajo	Canal para instrumentos	Profundidad de campo	Pixel	
Ø, Lunghezza operativa	Canale operativo	Profondità di campo	Pixels	



Auf Wunsch ist das Naso-Pharyngoskop mit einer Linkshänderbedienung erhältlich.
If required, the naso-pharyngoscope is available for left-hand use.
Sur demande, également disponible pour gauchers
Para zurdos disponible sobre demanda
Su richiesta il nasofaringoscopio è disponibile per mancini

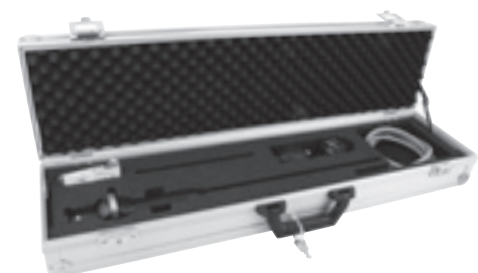



**Kamera Komplettsystem
Camera system complete**
**Système de caméra complet
Sistema de cámara completo
Sistema da camera completa**

TEKNO CU 30

PAL	tk 754-3330	tk 754-3332	tk 754-3334
NTSC	tk 754-3331	tk 754-3333	tk 754-3335

TEKNO CU 50

PAL	tk 754-3350	tk 754-3352	tk 754-3354
NTSC	tk 754-3351	tk 754-3353	tk 754-3355

ohne Objektiv <i>without objective</i>	mit Archivierung und Bildschirm <i>with archiving and monitor</i>	ohne Archivierung, mit Bildschirm <i>without archiving, with monitor</i>	ohne Archivierung, ohne Bildschirm <i>without archiving, without monitor</i>
sans objectif <i>sin objetivo</i>	avec archivage et moniteur <i>con archivamiento y monitor</i>	sans archivage et avec moniteur <i>sin archivamiento y con monitor</i>	sans archivage et sans moniteur <i>sin archivamiento y sin monitor</i>
senza obiettivo	con archiviazione e monitore	senza archiviazione e con monitore	senza archiviazione e senza monitore

Technische Daten

Kamera	
• Sensor:	1x 1/3" high sensivity CCD
• Bildpunkte:	752 x 582 pixel (PAL) 768 x 494 pixel (NTSC)
• TV-Auflösung:	470 Linien
• Bildformat:	4:3
• Lichtempfindlichkeit:	0,9 Lux
• Signal-Rauschabstand:	46 dB
• Shutterbereich:	1/50 - 1/100.000 sek
• Video Ausgänge:	1x Y/C; 1x BNC
• Automatischer Weiss-Abgleich	
• Fenstergröße einstellbar	
• Anti-Moiré	
• Boost Funktion	
• Gewicht Kamerakopf:	65 g
Lichtquelle	
• Lampe:	CU 30: Xenon 24 Watt CU 50: Xenon 50 Watt
• Farbtemperatur:	5.500°K
Archivierungssystem:	USB-Stick
Monitor	
• Sichtbares Bild:	10,4" / 26,5 cm
• Auflösung:	800 x 600 Linien
• Stromversorgung:	90 - 260 VAC (50-60 Hz)
• Abmessungen (BxTxH)/Gewicht:	294 x 95 x 250 mm/6 kg
• Klasse:	1
• Hergestellt und geprüft nach:	93/42/CEE, IEC 601-1/IEC 60601-1/CE

Technical data

Camera	
• Sensor:	1 x 1/3" high sensivity CCD
• Resolution:	752 x 582 pixel (PAL) 768 x 494 pixel (NTSC)
• Video resolution:	470 lines
• Aspect ratio:	4:3
• Light sensitivity:	0.9 Lux
• Signal - Noise ratio:	46 dB
• Electronic shutter:	1/50 to 1/100.000 sec
• Video outputs:	1x Y/C; 1x BNC
• Automatic white balance	
• Window sizes adjustable	
• Anti-Moiré	
• Boost function	
• Weight camerahead:	65 g
Light source	
• Lamp:	CU 30: Xenon 24 Watt CU 50: Xenon 50 Watt
• Colour temperature:	5.500°K
Data storage:	USB-Stick
Monitor	
• Visual image:	10.4" / 26.5 cm
• Resolution:	800 x 600 lines
• Power supply:	90 - 260 VAC (50-60 Hz)
• Size (WxDxH)/Weight:	294 x 95 x 250 mm/6 kg
• Class:	1
• Manufactured and tested acc.:	93/42/ECC, IEC 601-1/EN 60601-1/CE

Kamera Komplettsystem
Camera system complete

Système de caméra complet
Sistema de cámara completo
Sistema da camera completa

Dates techniques

Caméra	
• Senseur:	1x 1/3" high sensitivity CCD
• Pixel:	752 x 582 pixel (PAL) 768 x 494 pixel (NTSC)
• Resolution:	470 lignes
• Format:	4:3
• Sensibilité:	0.9 lux
• Rapport signal / bruit :	46 dB
• Ouverture	1/50 à 1/100.000 sec
• Sorties video:	1x Y/C; 1x BNC
• Balance des blancs automatique	
• Taille du "window" réglable	
• Anti-Moiré	
• Fonction Boost	
• Poids tête:	65 g
Source de lumière	
• Ampoule:	CU 30: Xenon 24 Watt CU 50: Xenon 50 Watt
• Température de couleur:	5.500°K
Système de documentation	USB-Stick
Moniteurs	
• Image visible:	10.4" / 26.5 cm
• Resolution:	800 x 600 lines
• Alimentation:	90 - 260 VAC (50-60 Hz)
• Dimensions (L x P x H)/Poids:	294 x 95 x 250 mm / 6 kg
• Classe:	1
• Produit et testé selon:	93/42/CEE, IEC 601-1/EN 60601-1/CE

Datos técnicos

Caméra	
• Sensor de CCD:	1x 1/3" de alta sensibilidad
• Numero de pixel, efectivos:	752 x 582 pixel (PAL) 768 x 494 pixel (NTSC)
• Resolución:	470 lineas
• Formato:	4:3
• Sensibilidad:	0.9 lux
• Relación señal a ruido:	46 dB
• Shutter electrónico:	1/50 hasta 1/100.000 seg.
• Video salidas:	1x Y/C; 1x BNC
• Balance de blanco automático	
• Tamaño del "window" ajustable	
• Anti-Moiré	
• Función Boost	
• Peso cabezal:	65 g
Fuente de luz	
• Bombilla:	CU 30: Xenon 24 Watt CU 50: Xenon 50 Watt
• Temperatura de color:	5.500°K
Sistema de documentation	USB-Stick
Monitor	
• Imagen visible:	10.4" / 26.5 cm
• Resolución:	800 x 600 lines
• Alimentación:	90 - 260 VAC (50-60 Hz)
• Dimensiones (L x P x A)/Peso:	294 x 95 x 250 mm / 6 kg
• Clase:	1
• Según la marca de	93/42/CEE, IEC 601-1/EN 60601-1/CE

Dati tecnici

Telecamera	
• CCD alta sensibilità da:	1x 1/3 di pollice
• Risoluzione:	752 x 582 pixel (PAL) 768 x 494 pixel (NTSC)
• Risoluzione:	470 linee
• Sensibilità:	0.9 lux
• Rapporto segnale/disturbo:	46 dB
• Autoshtutter elettronico:	1/50 a 1/100.000 sec
• Uscite video:	1x Y/C; 1x BNC
• Bilanciamento automatico del bianco	
• Estensione del "window" regolabile	
• Anti-Moiré	
• Funzione Boost	
• Peso testa:	65 g
Fonte di luce	
• Lampada:	CU 30: Xenon 24 Watt CU 50: Xenon 50 Watt
• Temperatura colore:	5.500°K
Sistema per documentazione	USB-Stick
Monitor	
• Immagine visualizzata:	10.4" / 26.5 cm
• Risoluzione:	800 x 600 linee
• Alimentazione nominale:	90 - 260 VAC (50-60 Hz)
• Dimensioni (W x D x H)/ Peso:	294 x 95 x 250 mm / 6 kg
• Classe:	1
• Prodotto e testata in accordo:	93/42/CEE, IEC 601-1/EN 60601-1/CE

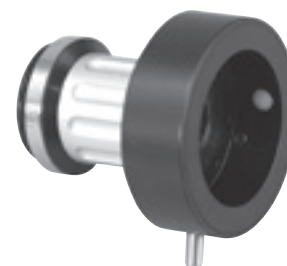

21 mm	tk 754-3900-21
Objektive	
Objectives	
Objectifs	
Objetivos	
Obiettivi	

Kameras
Cameras

Caméras
Cámaras
Telecamera



TEKNO CAM 1500 S

PAL	tk 754-2100S	tk 754-2100 USB
NTSC	tk 754-2101S	tk 754-2101 USB

ohne Objektiv
without objective

sans objectif
sin objetivo
senza obiettivo

mit USB Ausgang, ohne Objektiv
with USB output, without objective

avec sortie USB, sans objectif
con salida USB, sin objetivo
con uscita USB, senza obiettivo

22 mm	tk 754-3912
-------	--------------------

Objektiv C-Mount
Objective C-Mount

Objectif C-Mount
Objetivo C-Mount
Obiettivo C-Mount

Technische Daten

- 1/3" high sensitivity CCD
- Bildpunkte: 752 x 582 Pixel (PAL)
768 x 494 Pixel (NTSC)
- TV-Auflösung: > 500 Linien
- Lichtempfindlichkeit: 0,9 lux
- Signal-Rauschabstand: 52 dB
- Shutterbereich: 1/50 bis 1/100.000 sek
- 3 Windowgrößen
- Elektronischer Anti-Moirée filter
- Speicherung der letzten Benutzereinstellung beim Abschalten
- Menü in 5 Sprachen verfügbar
- Automatischer Weiss-Abgleich
- Abmessungen: B = 300; T = 300; H = 66 mm
- Kamerakopf: L = 50 mm; Ø = 28 mm
- Gewicht: 900 g; Kamerakopf: 37 g
- 1 Y/C Ausgang
- 1 composite Video Ausgang
- Stromversorgung: 115-230V
- Leistungsaufnahme: 25 VA
- C-Mount Kamerakopf
- Kamerakopfkabel: 3,25 m
- In Übereinstimmung mit: 93/42/CEE

Der optionale USB Ausgang erlaubt das Verbinden der Kamera mit einem PC. Bilder oder Videosequenzen können mittels einer geeigneten Software auf dem Computer aufgezeichnet werden. (z.B. Windows Movie Maker® - nicht im Lieferumfang enthalten)

Technical data

- 1/3" high sensitivity CCD
- Resolution: 752 x 582 pixel (PAL)
768 x 494 pixel (NTSC)
- Resolution: > 500 lines
- Sensitivity: 0.9 lux
- Signal / Noise ratio: 52 dB
- Electronic shutter: 1/50 to 1/100.000 sec
- 3 window sizes
- Electronic anti-moirée filter
- Last used configuration saved when switched off
- Menu in 5 languages available
- Automatic white balance
- Size of the control unit: W = 300; D = 300; H = 66 mm
- Size of the camerahead: L = 50 mm; Ø = 28 mm
- Weight: 900 g; camerahead: 37 g
- 1 Y/C Video output
- 1 composite Video output
- Power supply: 115-230V
- Power consumption: 25 VA
- C-Mount camerahead
- Camerahead cable: 3.25 meters
- Complies with the European Directive 93/42/CEE

The optional USB output allows the connection between the camera and a PC. Images or movies can be stored to your computer by using an adequate software. (e.g. Windows Movie Maker® - not included in delivery)

Kameras
Cameras
Caméras
Telecamera

Dates techniques

- 1/3" CCD de haute sensibilité
- Pixel: 752 x 582 (PAL)
768 x 494 (NTSC)
- Resolution: >500 lignes
- Sensibilité: 0.9 lux
- Rapport signal / bruit: 52 dB
- Ouverture: 1/50 à 1/100.000 sec
- 3 tailles du „window“
- Filtre anti-moirée électronique
- Mémorisation automatique du dernier réglage
- Menu en 5 langues
- Balance des blancs automatique
- Dimensions: L = 300; P = 300; H = 66 mm
- Tête de caméra: L = 50 mm; Ø = 28 mm
- Poids unité: 900 g; Poids tête: 37 g
- 1 sortie Y/C video
- 1 sortie composite video
- Alimentation: 115-230V
- Puissance absorbée: 25VA
- Tête de caméra C-mount
- Cable de la tête de caméra: 3.25 m
- En accord avec 93/42/CEE

La sortie optionnelle USB permet de connecter la caméra à un ordinateur. Photos ou vidéos peuvent être enregistrés sur l'ordinateur à l'aide d'un logiciel adéquate (par ex. Windows Movie Maker® - non inclus dans la livraison)

Dati tecnici

- CCD 1/3 " ad alta sensibilità
- Risoluzione: 752 x 582 (PAL)
768 x 494 (NTSC)
- Definizione: > 500 linee
- Sensibilità: 0.9 lux
- Rapporto segnale/disturbo: 52 dB
- Shutter elettronico: 1/50 to 1/100.000 sec
- 3 dimensioni del window
- Filtro anti-moirée elettronico
- Salvataggio automatico in memoria dell'ultima configurazione usata
- Menù in cinque lingue differenti selezionabili
- Bilanciamento automatico del bianco
- Dimensioni della centralina: W = 300; D = 300; H = 66 mm
- Dimensioni della testa della telecamera: L = 50 mm; Ø = 28 mm
- Peso: 900 g; Peso testa telecamera: 37 g
- 1 uscita video Y/C
- 1 uscita video composito
- Alimentazione: 115-230V
- Assorbimento: 25 VA
- Connessione testa telecamera passo C
- Cavo telecamera: 3.25 meters
- In accordo alle direttive europee 93/42/CEE

L'uscita USB permette di connettere la telecamera ad un PC. Questo permette di registrare fotografie e filmati usando un software adeguato (p.e. Windows Movie Maker® - non incluso nella fornitura)

Datos técnicos

- 1/3 CCD de alta sensibilidad
- Numero de pixel, efectivos: 752 x 582 (PAL)
768 x 494 (NTSC)
- Resolución: >500 líneas
- Sensibilidad: 0.9 lux
- Relación señal a ruido: 52dB
- Shutter electrónico: 1/50 hasta 1/100.000 seg
- 3 tamaños de „window“
- Filtro anti-moirée electrónico
- Memoria automática de la última programación
- Menu en 5 idiomas
- Balance de blanco automático
- Dimensiones: L = 300; P = 300; A = 66 mm
- Cabezal de cámara : L = 50 mm; Ø = 28 mm
- Peso unidad: 900 g; Peso cabezal: 37 g
- 1 salida Video Y/C
- 1 salida de video, compuesto video
- Alimentación: 115-230V
- Consumo eléctrico: 25VA
- Cabezal de cámara C-mount
- Cable del cabezal de cámara: 3.25 m
- Corresponde a 93/42/CEE

La salida opcional de USB permite de conectar la cámara a un ordenador. Photos y videos pueden ser registrados con ayuda de un programa adecuado (por ejemplo Windows Movie Maker® - no incluido en la entrega)



weitere Kamera-Modelle, siehe unseren Spezial Katalog for other cameras, see our special catalogue

pour plus des caméras, voir notre catalogue special para mas cámaras, ver nuestro catálogo especial per alltri modelli di telecamera riferirsi al nostro specifico catalogo

Kameras
Cameras

Caméras
Cámaras
Telecamera

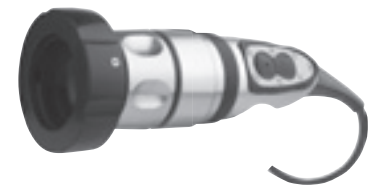

TEKNO CAM 2000 S PRO

PAL	tk 754-2150S	tk 754-2152 D
NTSC	tk 754-2151S	tk 754-2153 D

ohne Objektiv
without objective

sans objectif
sin objetivo

senza obiettivo

mit digitalem Ausgang (IEEE 1394), ohne Objektiv
with digital output (IEEE 1394), without objective

avec sortie digitale (IEEE 1394), sans objectif
con salida digital (IEEE 1394), sin objetivo

con uscita digitale (IEEE 1394), senza obiettivo

22 mm	tk 754-3912
-------	--------------------

Objektiv C-Mount
Objective C-Mount

Objectif C-Mount

Objetivo C-Mount

Obiettivo C-Mount

Technische Daten

- 1/3" high sensitivity CCD
- Bildpunkte: 752 x 582 Pixel (PAL)
768 x 494 Pixel (NTSC)
- TV-Auflösung: > 500 Linien
- Lichtempfindlichkeit: 0,9 lux
- Signal-Rauschabstand: 52 dB
- Shutterbereich: 1/50 bis 1/100.000 sek
- 5 Windowgrößen
- Bis zu 10 Benutzereinstellungen speicherbar
- Hintergrundbeleuchtung
- Speicherung der letzten Benutzereinstellungen beim Abschalten
- "On Screen"-Menü in fünf Sprachen verfügbar
- Automatischer Weiss-Abgleich
- Belegbarer Fernbedienungsknopf am Kamerakopf
- Abmessungen: B = 300; T = 300; H = 66 mm
- Kamerakopf: L = 80 mm; Ø = 32 mm
- Gewicht: 2,5 kg; Kamerakopf: 200 g
- 2 Y/C Video Ausgänge
- 2 Composite Video Ausgänge
- 2 remote control Ausgang (Klinke mono 3,5mm und 2,5mm)
- Stromversorgung: 115-230V
- Leistungsaufnahme: 25 VA
- C-Mount Kamerakopf einlegbar
- Kamerakopfkabel: 3,60 m, Silikon
- Kamerakopfkabel austauschbar
(nur bei autoklavierbarem Kamerakopf)
- BF Produkt
- In Übereinstimmung mit: 93/42/CEE
- 1 digitaler Ausgang (nur tk 754-2152 D / tk 754-2153 D)

Technical data

- 1/3" high sensitivity CCD
- Resolution: 752 x 582 pixel (PAL)
768 x 494 pixel (NTSC)
- Resolution: > 500 lines
- Sensitivity: 0.9 lux
- Signal - noise ratio: 52 dB
- Electronic shutter: 1/50 to 1/100.000 sec
- 5 window sizes
- Up to 10 user profiles in memory
- Backlight function
- Last used configuration saved when switched off
- On screen menu in five languages available
- Automatic white balance
- Preselectable remote button on camerahead
- Size of the control unit: W = 300; D = 300; H = 66 mm
- Size of the camerahead: L = 80 mm; Ø = 32 mm
- Weight: 2.5 kg; camerahead: 200 g
- 2 Y/C video outputs
- 2 composite video outputs
- 2 remote control outputs (jack mono 3.5mm and 2.5mm)
- Power supply: 115-230V
- Power consumption: 25 VA
- C-Mount camerahead soakable
- Camerahead cable: 3.60 m, silicone
- Interchangeable camerahead cable
(only with autoclavable camerahead)
- BF product
- Complies with the European Directive 93/42/CEE
- 1 digital output (only tk 754-2152 D / tk 754-2153 D)

Kameras
Cameras
Telecamera

Caméras
Cámaras
Telecamera

Dates techniques

- 1/3" high sensitivity CCD
- Pixels: 752 x 582 (PAL)
768 x 494 (NTSC)
- Resolution: > 500 lignes
- Sensibilité: 0.9 lux
- Rapport signal / bruit: 52 dB
- Ouverture: 1/50 à 1/100.000 sec
- 5 tailles du „window“
- 10 réglages en mémoire
- Illumination du fond
- Mémorisation automatique du dernier réglage
- Menu en 5 langues
- Balance des blancs automatique
- Bouton de telecommande selectionable sur la tête de caméra
- Dimensions: L = 300 ; P = 300 ; H = 66 mm
- Tête de caméra L = 80 mm, Ø 32 mm
- Poids unité: 2.5 kg; Peso tête: 200 g
- 2 sorties Y/C Video
- 2 sorties composite video
- 2 sorties pour telecommande (mono 3.5mm et 2.5mm)
- Alimentation: 115-230V
- Puissance absorbée: 25 VA
- Tête de caméra c-mount, immerisible
- Cable tête de caméra: 3.60 m, silicone
- Cable de caméra changeable
(seulement pour tête de caméra autoclavable)
- Classe: BF
- En accordance avec 93/42 CEE
- 1 Sortie digitale (seulement tk 754-2152 D / tk 754-2153 D)

Datos técnicos

- Sensor de CCD: 1/3" de alta sensibilidad
- Numero de pixel, efectivos: 752 x 582 (PAL)
768 x 494 (NTSC)
- Resolución horizontal: > 500 líneas TV
- Sensibilidad: 0.9 Lux
- Relación señal a ruido sin compensación: 52 dB
- Shutter electrónico: 1/50 a 1/100.000 seg
- 5 tamaños de "window"
- Almacenaje de hasta 10 programaciones individuales
- Iluminación de fondo
- Memoria automatica de la ultima programación
- Menu en 5 idiomas
- Balance de blanco automático
- Botone programable en el cabezal de cámara
- Dimensiones del dispositivo de control L = 300; P = 300; A = 66 mm
- Cabezal de cámara: L = 80 mm, Ø = 32 mm
- Peso unidad: 2.5 kg; Peso cabezal de cámara: 200 g
- 2 salidas de video Y/C
- 2 salidas de video, compuesto video
- 2 salidas remote (jack mono 3.5 mm y 2.5mm)
- Alimentación eléctrica: 115 - 230V
- Consumo eléctrico: 25 VA
- Cabezal sumergible
- Longitud cable del cabezal: 3.60 m, silicona
- Cable de cabezal intercambiable
(solo para cabezal de cámara autoclavable)
- Clase de protección: BF
- Conforme a la directiva europea 93/42/CEE
- 1 Salida digital (solamente tk 754-2152 D / tk 754-2153 D)

Dati tecnici

- CCD alta sensibilità da 1/3 di pollice
- Risoluzione: 752 x 582 (PAL)
768 x 494 (NTSC)
- Risoluzione: > 500 linee
- Sensibilità: 0.9 lux
- Rapporto segnale/disturbo: 52 db
- Autosshutter elettronico: 1/50 a 1/100.000 sec
- 5 dimensioni selezionabili dell'area di lavoro (window)
- Fino a 10 profili di lavoro memorizzabili
- Funzione luce di background
- Salvataggio automatico in memoria dell'ultima configurazione usata
- Menù su schermo (OSD) in cinque lingue differenti selezionabili
- Bilanciamento automatico del bianco
- Pulsante di comando remoto sulla testa preselezionabile
- Dimensioni della centralina: W = 300; D = 300; H = 66 mm
- Dimensioni della testa: L = 80 mm, Ø 32 mm
- Peso centralina: 2.5 kg; Peso testa: 200 grammi
- 2 uscite video Y/C
- 2 uscite video composito
- 2 uscite per controllo remoto (jack mono 3.5 mm e 2.5mm)
- Alimentazione: 115/230V
- Assorbimento: 25 VA
- Testa telecamera immergibile con connessione passo C
- Lunghezza cavo telecamera: 3.60 metri
- Cavo testa telecamera sostituibile
(solamente per testa di camera autoclavabile)
- Prodotto BF
- In accordo alla direttiva europea 93/42/CEE
- 1 Uscita digitale (soltanto tk 754-2152 D / tk 754-2153 D)



PAL	tk 754-2150SA
NTSC	tk 754-2151SA

mit autoklavierbarem Kamerakopf und Objektiv
with autoclavable camera head and objective
avec tête de caméra autoclavable et objectif
con cabezal de cámara autoclavable y objetivo
con testa di camera autoclavabile e obiettiv



weitere Kamera-Modelle, siehe unseren Spezial Katalog
for other cameras, see our special catalogue
pour plus des caméras, voir notre catalogue special
para mas cámaras, ver nuestro catálogo especial
per altri modelli di telecamera riferirsi al nostro specifico catalogo

Kaltlichtquellen
Cold light sources

Sources de lumière froide
 Fuentes de luz
 Fonte di luce fredda



TEKNO LIGHT H250	250	1	tk 754-H250
TEKNO LIGHT H252	250	2	tk 754-H252

zuschaltbare Ersatzlampe <i>switchable spare bulb</i>	Watt <i>Watt</i>	Lampenausgänge <i>Light outputs</i>
ampoule de secours à enclencher <i>una segunda bombilla conmutable</i>	Watt <i>Vatio</i>	Sorties de lumière <i>Salidas de luz</i>
seconda lampada d'aggiungere	Watt	Uscite luce

Technische Daten

• Lampe	Halogen 250 Watt
• Lebensdauer	50 h
• Farbtemperatur	3.600°K
• Netzspannung	115 / 230 VAC
• Frequenz	50 / 60 Hz
• Klassifizierung	BF
• Leistungsaufnahme	260 W
• Lichtintensitätsregelung	stufenlos, mechanische Blende
• Lichtleiteranschluss	TEKNO / Storz
• Gewicht	8 kg
• Abmessung (B x T x H)	355 mm x 347 mm x 110 mm
• Hergestellt und geprüft nach	IEC 60601-1 / CE
• Betriebstemperatur	+10° - +40°C

Die Geräte werden standardmäßig mit TEKNO/Storz-Adapter geliefert. Optional sind alle Geräte auch mit folgenden Adaptern lieferbar: Olympus, Wolf, ACMI und Circon

Technical data

• Lamp	Halogen 250 Watt
• Operating Life	50 h
• Colour temperature	3.600°K
• Line voltage	115 / 230 VAC
• Frequency	50 / 60 Hz
• Type	BF
• Power consumption	260 W
• Brightness control	stepless, mechanical shutter
• Light exit	TEKNO / Storz
• Weight	8 kg
• Dimensions (W x D x H)	355 mm x 347 mm x 110 mm
• Produced and tested acc	IEC 60601-1 / CE
• Working temperature	+10° - +40°C

All Tekno light sources have a standard adapter for TEKNO/Storz light guides. Optional are these devices also available with an adapter for Olympus, Wolf, ACMI and Circon



Bei Bestellungen bitte Netzspannung / Lichtleitersystem angeben!
 When ordering, please specify line voltage and light guide system!

En cas de commande merci d'indiquer l'alimentation et le système des cables!
 Gracias de indicar con el pedido el voltaje y el sistema de los cables!

Al momento dell'ordine si prega di specificare la tensione di alimentazione e la connessione del cavo luce!

Kaltlichtquellen
Cold light sources

Sources de lumière froide
Fuentes de luz
Fonte di luce fredda

Dates techniques

• Ampoule	Halogène 250 Watt
• Durée de vie	50 h
• Température de couleur	3.600°K
• Alimentation	115 / 230 VAC
• Fréquence	50 / 60 Hz
• Classe	BF
• Puissance absorbée	260 W
• Réglage de luminosité	continue, diaphragme mécanique
• Sortie de lumière	TEKNO / Storz
• Poids	8 kg
• Dimensions (L x P x H)	355 mm x 347 mm x 110 mm
• Produit et testé selon	IEC 60601-1 / CE
• Température de travail	+10° - +40°C

Les appareils sont livrés avec une sortie de lumière TEKNO/Storz. Des sorties Olympus, Wolf, ACMI et Circon sont disponibles sur demande.

Datos técnicos

• Bombilla	Halógena 250 Watt
• Duración aprox	50 h
• Temperatura de color	3.600°K
• Alimentación eléctrica	115 / 230 VAC
• Frecuencia	50 / 60 Hz
• Tipo de protección	BF
• Consumo de potencia	260 W
• Diafragma	regulador de diafragma mecánico
• Adaptor de conducción de luz	TEKNO / Storz
• Peso	8 kg
• Dimensiones (L x P x A)	355 mm x 347 mm x 110 mm
• Según la marca de	IEC 60601-1 / CE
• Temperatura de funcionamiento	+10° - +40°C

Las fuentes de luz vienen despachadas con la conexión TEKNO/Storz. Conexiones para Olympus, Wolf, ACMI y Circon disponible sobre demanda.

Dati tecnici

• Lampada	Alogena 250 Watt
• Durata della lampada	50 h
• Temperatura colore	3.600°K
• Alimentazione	115 / 230 VAC
• Frequenza	50 / 60 Hz
• Classificazione	BF
• Assorbimento	260 W
• Controllo di luminosità	otturatore meccanico senza soluzione di continuità
• Connessione cavo luce	TEKNO / Storz
• Peso	8 kg
• Dimensioni (W x D x H)	355 mm x 347 mm x 110 mm
• Prodotta e testata in accordo	IEC 60601-1 / CE
• Temperatura di lavoro	+10° - +40°C

Tutte le fonti di luce Tekno hanno un adattatore standard per cavi luce TEKNO/Storz. Su richiesta le fonti di luci sono disponibili con adattatore per cavi luce Olympus, Wolf, ACMI e Circon.



tk 754-0250

Ersatzlampe für tk 754-H250 / tk 754-H252
Spare bulb for tk 754-H250 / tk 754-H252
Lampe de rechange pour tk 754-H250 / tk 754-H252
Bombilla de cambio para tk 754-H250 / tk 754-H252
Lampadina di ricambio per tk 754-H250 / tk 754-H252



weitere Lichtquellen, siehe unseren Spezial Katalog
for other light sources, see our special catalogue

pour plus des sources de lumière, voir notre catalogue special
para mas fuentes de luz, ver nuestro catálogo especial
per altri modelli di fonte di luce riferirsi al nostro specifico catalogo

Kaltlichtquellen
Cold light sources

 Sources de lumière froide
 Fuentes de luz
 Fonte di luce fredda

TEKNO LIGHT XM 180	180	manual	tk 754-XM180
TEKNO LIGHT XA 180	180	automatic	tk 754-XA180

Watt Helligkeitsregelung
 Watt *intensity control*
 Watt réglage de luminosité
 Vatio *ajuste de luminosidad*
 Watt controllo della intensità di luce

Technische Daten

• Lampe	Xenon 180 Watt
• Lebensdauer	500 h
• Farbtemperatur	5.600°K
• Netzspannung	115 / 230 VAC
• Frequenz	50 / 60 Hz
• Klassifizierung	BF
• Leistungsaufnahme	280 W
• Lichtintensitätsregelung	elektronisch, mechanische Blende
• Lichtleiteranschluss	TEKNO / Storz
• Gewicht	11,5 kg
• Abmessung (B x T x H)	355 mm x 347 mm x 110 mm
• Hergestellt und geprüft nach	IEC 60601-1 / CE
• Betriebstemperatur	+10° - +40°C
• elektronische Lebensdaueranzeige	

Im Lieferumfang enthalten

- BNC und Y/C Videokabel (nur tk 754-XA180)

Die Geräte werden standardmäßig mit TEKNO/Storz-Adapter geliefert. Optional sind alle Geräte auch mit folgenden Adaptern lieferbar: Olympus, Wolf, ACMI und Circon

Technical data

• Lamp	Xenon 180 Watt
• Operating Life	500 h
• Colour temperature	5.600°K
• Line voltage	115 / 230 VAC
• Frequency	50 / 60 Hz
• Type	BF
• Power consumption	280 W
• Brightness control	electronical, mechanical shutter
• Light exit	TEKNO / Storz
• Weight	11.5 kg
• Dimensions (W x D x H)	355 mm x 347 mm x 110 mm
• Produced and tested acc	IEC 60601-1 / CE
• Working temperature	+10° - +40°C
• electronical life time indicator	

Included in delivery

- BNC and Y/C video cable (only tk 754-XA180)

All Tekno light sources have a standard adapter for TEKNO/Storz light guides. Optional are these devices also available with an adapter for Olympus, Wolf, ACMI and Circon



Bei Bestellungen bitte Netzspannung / Lichtleitersystem angeben!
 When ordering, please specify line voltage and light guide system!

En cas de commande merci d'indiquer l'alimentation et le système des cables!
 Gracias de indicar con el pedido el voltaje y el sistema de los cables!

Al momento dell'ordine si prega di specificare la tensione di alimentazione e la connessione del cavo luce!

Kaltlichtquellen
Cold light sources

Sources de lumière froide
Fuentes de luz
Fonte di luce fredda

Dates techniques

• Ampoule	Xenon 180 Watt
• Durée de vie	500 h
• Température de couleur	5.600°K
• Alimentation	115 / 230 VAC
• Fréquence	50 / 60 Hz
• Classe	BF
• Puissance absorbée	280 W
• Réglage de luminosité	diaphragme mécanique, électronique
• Sortie de lumière	TEKNO / Storz
• Poids	11.5 kg
• Dimensions (L x P x H)	355 mm x 347 mm x 110 mm
• Produit et testé selon	IEC 60601-1 / CE
• Température de travail	+10° - +40°C
• Affichage électronique	

Inclus dans la livraison

- Câble de video BNC et Y/C (seulement tk 754-XA180)

Les appareils sont livrés avec une sortie de lumière TEKNO/Storz. Des sorties Olympus, Wolf, ACMI et Circon sont disponibles sur demande.

Datos técnicos

• Bombilla	Xenon 180 Watt
• Duración aprox	500 h
• Temperatura de color	5.600°K
• Alimentación eléctrica	115 / 230 VAC
• Frecuencia	50 / 60 Hz
• Tipo de protección	BF
• Consumo de potencia	280 W
• Diafragma	regulador de diafragma mecánico
• Adaptor de conducción de luz	TEKNO / Storz
• Peso	11.5 kg
• Dimensiones (L x P x A)	355 mm x 347 mm x 110 mm
• Según la marca de	IEC 60601-1 / CE
• Temperatura de funcionamiento	+10° - +40°C
• Indicador electrónico de la duración de vida de la bombilla	

Incluido en el envío

- Cable de video BNC y Y/C (solamente tk 754-XA180)

Las fuentes de luz vienen despachadas con la conexión TEKNO/Storz. Conexiones para Olympus, Wolf, ACMI y Circon disponible sobre demanda.

Dati tecnici

• Lampada	Xenon 180 Watt
• Durata della lampada	500 h
• Temperatura colore	5.600°K
• Alimentazione	115 / 230 VAC
• Frequenza	50 / 60 Hz
• Classificazione	BF
• Assorbimento	280 W
• Controllo di luminosità	otturatore meccanico senza soluzione di continuità
• Connessione cavo luce	TEKNO / Storz
• Peso	11.5 kg
• Dimensioni (W x D x H)	355 mm x 347 mm x 110 mm
• Prodotta e testata in accordo	IEC 60601-1 / CE
• Temperatura di lavoro	+10° - +40°C
• Indicatore elettronico di vita della lampada	

Incluso nella fornitura

- Cavo video BNC e Y/C (soltanto tk 754-XA180)

Tutte le fonti di luce Tekno hanno un adattatore standard per cavi luce TEKNO/Storz. Su richiesta le fonti di luci sono disponibili con adattatore per cavi luce Olympus, Wolf, ACMI e Circon.



tk 754-R180

Ersatzlampe für tk 754-XM180 / tk 754-XA180
Spare bulb for tk 754-XM180 / tk 754-XA180

Lampe de rechange pour tk 754-XM180 / tk 754-XA180
Bombilla de cambio para tk 754-XM180 / tk 754-XA180
Lampadina di ricambio per tk 754-XM180 / tk 754-XA180



weitere Lichtquellen, siehe unseren Spezial Katalog
for other light sources, see our special catalogue

pour plus des sources de lumière, voir notre catalogue special
para mas fuentes de luz, ver nuestro catálogo especial
per altri modelli di fonte di luce riferirsi al nostro specifico catalogo

Kaltlichtquellen
Cold light sources

Sources de lumière froide
Fuentes de luz
Fonte di luce fredda



270 x 220 mm	tk 758-1300
400 x 350 mm	tk 758-1301

Geräteträger mit Haken für Stirnleuchten
Mobile stand with hook for headlights

Table mobil avec crochet pour lampe frontal
Carro con supporto para lampara frontal
Corello con supporto per lampada frontale

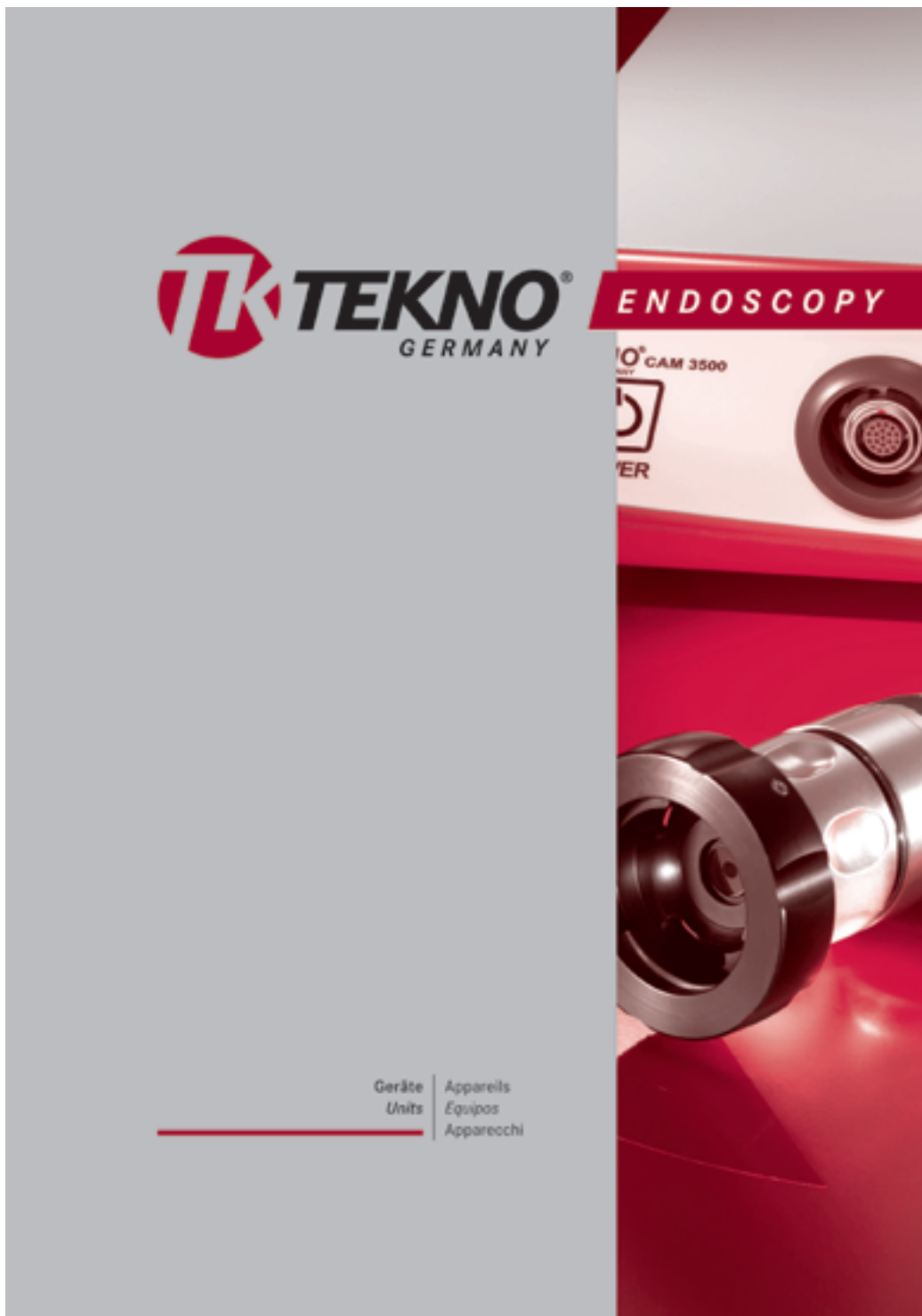

Bitte fordern Sie unseren Spezialkatalog an.
Please ask for our special catalogue.

Veuillez demander pour notre catalogue spécial.
Por favor preguntan para el catálogo especial.

Per favore domandate per il nostro catalogo speciale.

Glasfaser-Kaltlichtkabel
Fiberoptic cables
Cables de lumière froide
Cables de fibra óptica
Cavi luce in fibra ottica
autoklavierbar / autoclavable
134°C / 273°F

< Ø 5mm	Ø 3.5 mm	1800 mm	tk 39520-18	tk 39530-18
	Ø 3.5 mm	2300 mm	tk 39520-23	tk 39530-23
	Ø 3.5 mm	3000 mm	tk 39520-30	tk 39530-30
	Ø 3.5 mm	4000 mm	tk 39520-40	tk 39530-40
≥ Ø 5mm	Ø 4.9 mm	1800 mm	tk 39521-18	tk 39531-18
	Ø 4.9 mm	2300 mm	tk 39521-23	tk 39531-23
	Ø 4.9 mm	2500 mm	tk 39521-25	tk 39531-25
	Ø 4.9 mm	3000 mm	tk 39521-30	tk 39531-30
	Ø 4.9 mm	4000 mm	tk 39521-40	tk 39531-40
	Ø 4.9 mm	5000 mm	tk 39521-50	tk 39531-50

für Optiken <i>for scopes</i>	Faserbündel <i>Fiber bundle</i>	Länge <i>Length</i>	Kabel ohne Adapter <i>Cable without adapters</i>	komplett mit 2 Adaptern: TEKNO / Storz <i>complete with 2 adapters: TEKNO / Storz</i>
pour optiques <i>para ópticas</i> per ottiche	Fibres <i>Fibras</i> Cavo luce	Longueur <i>Longitud</i> Lunghezza	Cable sans adaptateurs <i>Cable sin adaptadores</i> Cavo senza adattatori	complet avec 2 adaptateurs : TEKNO / Storz <i>completo con 2 adaptadores : TEKNO / Storz</i> completo di 2 adattatori: TEKNO / Storz

- adaptierbar an alle gängigen Systeme mittels Adapter
- *suitable for all common systems with adapters*
- compatibles avec tous systèmes commun avec adaptateurs
- *compatibles con todos equipos corrientes con adaptadores*
- adatto per i sistemi più comuni con appositi adattatori

Nicht für 300W Xenon-Lichtquellen geeignet
Not for use with 300W Xenon light sources

 Ne pas utiliser avec des sources de lumière 300W Xenon
 No para usar con fuentes de luz 300W Xenon
 Non usare insieme alle fonti di luce Xenon 300W

Glasfaser-Kaltlichtkabel
Fiberoptic cables
 Cables de lumière froide
Cables de fibra óptica
 Cavi luce in fibra ottica

autoklavierbar / autoclavable
 134°C / 273°F



< Ø 5mm	Ø 3.5 mm	1800 mm	tk 39522-18	tk 39532-18
	Ø 3.5 mm	2300 mm	tk 39522-23	tk 39532-23
	Ø 3.5 mm	3000 mm	tk 39522-30	tk 39532-30
≥ Ø 5mm	Ø 4.8 mm	1800 mm	tk 39523-18	tk 39533-18
	Ø 4.8 mm	2300 mm	tk 39523-23	tk 39533-23
	Ø 4.8 mm	3000 mm	tk 39523-30	tk 39533-30

für Optiken <i>for scopes</i>	Faserbündel <i>Fiber bundle</i>	Länge <i>Length</i>	Kabel ohne Adapter <i>Cable without adapters</i>	komplett mit 2 Adaptern: TEKNO / Storz <i>complete with 2 adapters: TEKNO / Storz</i>
pour optiques	Fibres	Longueur	Cable sans adaptateurs	complet avec 2 adaptateurs : TEKNO / Storz
para ópticas	Fibras	Longitud	Cable sin adaptadores	completo con 2 adaptadores : TEKNO / Storz
per ottiche	Cavo luce	Lunghezza	Cavo senza adattatori	completo di 2 adattatori: TEKNO / Storz

- **Speziell für XENON-Lichtquellen**
 Unsere Hochleistungs-Kaltlichtkabel werden durch ein Spezialverfahren am Lichteintritt komprimiert und können so mehr Licht transportieren. Sie sind speziell für hochenergetische Xenon-Lichtquellen geeignet!
- **adaptierbar an alle gängigen Systeme mittels Adapter**
- **Especially for XENON light sources**
Our high density fiber optic cables are specially prepared at the light entrance for transporting more light. They are suited for high energy XENON light sources.
- **suitable for all common systems with adapter**
- **Spécialement pour sources de lumière de XENON.**
 Les cables de haute performance sont préparés spécialement à l'entrée de la lumière pour pouvoir transporter plus de lumière. Ils sont appropriés pour les sources énergétiques de Xenon.
- **compatibles avec tous systèmes commun avec adaptateurs**
- **Particularmente para fuentes de luz XENON.**
Nuestros cables de fibra óptica de alto rendimiento disponen de un tratamiento especial en la punta proximal para una mayor transmisión de luz. Estos cables son especialmente recomendados para el uso con fuentes de luzes Xenon.
- **compatibles con todos equipos corrientes con adaptador**
- **Speciale per fonti di luce allo XENON**
 I nostri cavi luce ad alta densità sono preparati in modo speciale nella connessione con la fonte per trasportare maggior quantità di luce. Essi sono costruiti per le fonti di luce XENON ad alta potenza!
- **fornibili per tutti i sistemi più comuni con adattatori**

Adapter
Adapters

Adaptateurs
Adaptadores
Adattatori

Projektor-Seite
Projector-side
Coté projecteur
Fuente de luz
Lato fonte luce



tk 39525-00	tk 39528-00	tk 39527-00	tk 39530-00
Tekno Storz Aesculap	Wolf HSW Dyonics Medicon Comeg Linvatec	Olympus	ACMI Stryker

Endoskop-Seite
Endoscope-side
Coté endoscope
Endoscopio
Lato endoscopio



tk 39525-10	tk 39528-20	tk 39530-10
Tekno Storz Aesculap Olympus	Wolf HSW Dyonics Medicon Comeg Stryker	ACMI Linvatec



Weitere Adapter auf Anfrage erhältlich
Further adapters available on request

Autres adaptateurs sont disponibles sur demande
Otros adaptadores son disponibles según demanda
Altri adattatori a richiesta

Reinigungs- und Sterilisationszubehör
Cleaning and sterilizing accessories

Accessoires pour nettoyage et stérilisation
Accesorios para limpieza y esterilización
 Accessori per pulizia e sterilizzazione



Perforierter Boden und Deckel, ohne Filter.
 Silikonhalterungen für zwei Endoscope.

*Perforated bottom and lid, without filter.
 Silicon fittings for two endoscopes.*

Couvercle et fond perforés, sans filtres.
 Pièces en silicone pour 2 optiques.

*Tapa y fondo perforados, sin filtros.
 Piezas en silicona para 2 ópticas.*

Coperchio e fondo perforato, senza filtri.
 Sostegno di silicone per 2 ottiche.

250 x 60 x 50 mm		tk 87280-2F-SI
250 x 60 x 50 mm		tk 87280-2F-YE
250 x 60 x 50 mm		tk 87280-2F-GR
250 x 60 x 50 mm		tk 87280-2F-BL
250 x 60 x 50 mm		tk 87280-2F-RE
250 x 60 x 50 mm		tk 87280-2F-BK

Deckelfarbe
Lid colour

Couleur du couvercle
Color de la tapa
 Colore del coperchio

450 x 70 x 70 mm		tk 87290-2F-SI
450 x 70 x 70 mm		tk 87290-2F-YE
450 x 70 x 70 mm		tk 87290-2F-GR
450 x 70 x 70 mm		tk 87290-2F-BL
450 x 70 x 70 mm		tk 87290-2F-RE
450 x 70 x 70 mm		tk 87290-2F-BK

Deckelfarbe
Lid colour

Couleur du couvercle
Color de la tapa
 Colore del coperchio



460 x 80 x 52 mm	tk 707-650
290 x 80 x 52 mm	tk 707-651

Siebkorb für Optiken > ø 2,7mm

Wire basket for endoscopes > ø 2,7 mm

Panier pour optiques > ø 2,7 mm

Cesta para ópticas > ø 2,7 mm

Cestello per endoscopi con diametro > ø 2,7 mm



tk 700-999

Autoklavierbare Schutzhülse für Endoskope bis Ø 5 mm, durch Zusammenstecken von 2 Hülsen erweiterbar für Urologie / Gynäkologie - Optiken
Autoclavable protection tube for endoscopes up to Ø 5 mm, assembling of two tubes will allow a protection for Urology / Gynaecology scopes

Gaines de protection autoclavables pour optiques jusqu'au 5mm Ø. En combinant deux gaines, élargable pour des optiques d'urologie et gynécologie.

Vainas de protección autoclavables para ópticas fino a Ø 5mm. Conectando dos vainas se pueden utilizar también para ópticas de Urología / Ginecología

Tubi di protezione autoclavabili per ottiche fino a 5 mm di diametro. L'assemblaggio di due tubi consentirà la protezione di ottiche per urologia / ginecologia

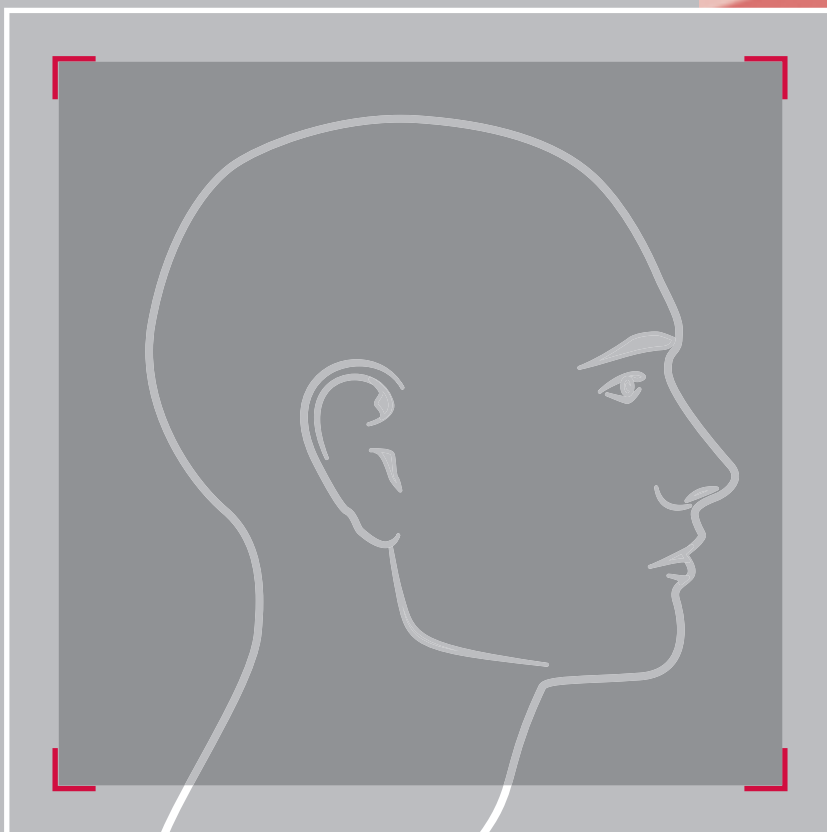

Electro Chirurgie
Electro surgery

Eléctrochirurgie
Electro-Cirugía
Eletrobisturi



Technische Merkmale
Technical features

Caractéristiques techniques
Características técnicas
Caratteristiche tecniche

**Technische Eigenschaften**

Umfassende, permanente Kontrolle durch Mikroprozessoren zusammen mit Analog/Digital Hochgeschwindigkeitskonvertern zur Überprüfung der Messergebnisse. Kontrolle der Ausgangsleistung mit automatischer und dynamischer Regulierung durch ein, über Mikroprozessor gesteuertes System (ADC) mit Abgleich der Werte zwischen Gerät und Patientengewebe 7000 mal pro Sekunde.

Der korrekte Anschluss der Neutralelektrode wird über Mikroprozessoren kontrolliert. Visueller und akustischer Alarm, bis hin zur Unterbrechung der Ausgangsleistung bei ungenügendem oder fehlendem Kontakt zwischen der Neutralelektrode und dem Patienten.

Wahlweise Anschluss eines monopolaren Elektroden-Handgriffs oder einer Bipolar-Elektrode, die über einen Fußschalter gesteuert werden können. Funktionswahl am Geräteschalter. Kein Display

Die automatische und dynamische Regulierung der Ausgangsleistung wird über eine eigene Software für einen optimierten Verlauf und den permanenten Abgleich der Werte zwischen Gerät und Patientengewebe gesteuert. Die Anpassung der Ausgangsleistung erfolgt automatisch in Abhängigkeit des Widerstands des Patientengewebes, der verwendeten Elektrode oder der Arbeitsgeschwindigkeit.

Technical features

Complete and permanent control by microprocessor, interfaced with highspeed analogue/digital converters for checking controls. Output control with automatic and dynamic adjustment by a microprocessor-controlled, specific circuit (ADC system), with feedback unit/patient tissue (7000 times/sec.)

Neutral electrode safety controlled by a microprocessor. Specific circuit with alarm (red signal and highpitched intermittent sound) and output stop if the absence of connection or a bad contact between the electrode and the tissue should be detected.

Single footswitch control for the use with a monopolar pencil or a bipolar electrode. One output selection button. No display.

Automatic and dynamic output adjustment with an optimized function, controlled by a specific circuit software, able to perform continuous feedback between the HF-unit and the patient's tissue. Independent of the impedance (type of tissue), the electrode in use, or the process speed.

Technische Merkmale *Technical features*

Caractéristiques techniques *Características técnicas* Caratteristiche tecniche

Dates techniques

Contrôle complete et permanente par microprocesseurs avec des convertisseurs analogue/digital de haute vitesse pour la verification des mesures. Contrôle et réglage automatique et dynamique de la puissance de sortie par un système dirigé par des microprocesseurs (ADC) en comparant les valeurs entre appareil et tissu du patient 7000 fois par sec.

La connection correcte de l'électrode neutre est contrôlée par des microprocesseurs. Alarme visuelle et acoustique jusqu'à la coupure totale de la puissance de sortie en cas d'un contact insuffisant ou manquant entre l'électrode neutre et le patient.

Au choix utilisation d'un manche monopolaire ou d'une électrode bipolaire. Sélection des modes par bouton. Pas de display.

Réglage automatique et dynamique de la puissance de sortie. Commandé par un programme spécifique pour un déroulement optimisé et une équilibrage permanente entre l'appareil et le tissu du patient. La puissance de sortie est réglée automatiquement selon l'impédance du tissu du patient, l'électrode utilisée ou la vitesse de travaille.

Data tecnici

Controllo completo e permanente con microprocessore, interfacciato a convertitori analogico/digitali ad alta velocità per i controlli di sicurezza. Controllo della potenza di uscita con regolazione automatica e dinamica controllata da microprocessore, circuizione specifica (ADC System), con feedback unità/tessuto paziente (7.000 volte/secondo)

Sicurezza piastra paziente controllata da microprocessore. Circuito specifico con allarme (lampada rossa e suono acuto intermittente) e interruzione dell'output se viene segnalata assenza di connessione o contatto imperfetto tra tessuto ed elettrodo.

Controllo con pedale singolo per utilizzo con manipolo monopolare od elettrodo bipolare. Pulsane unico di selezione output. Nessun display

Regolazione output automatica e dinamica con funzioni ottimizzate, controllata da uno specifico software, in grado di controllare in continuo il feedback tra l'elettrobisturi ed il tessuto del paziente, in accordo con l'impedenza (o il tipo) del tessuto, l'elettrodo in uso la velocità di esecuzione.

Datos técnicos

Controla completa y permanente por microprocesadores, con convertidores análogo/digital de alta velocidad para la verificación de los valores de medición. Controla y regulación automática y dinámica por un programa específica, reglado por microprocesador, (ADC) comparando los valores entre el tejido del paciente y el aparato 7000 veces por segundo.

La conexión corecta del electrodo neutro es controlada por microprocesadores. Alarma visual y acústica hasta la interrupción total de la potencia de salida en caso de un contacto insuficiente o faltante entre el electrodo neutro y el paciente.

Opcional utilización de un mango monopolar o de un electrodo bipolar. Un botón de reglaje. No display

Regulación automática y dinámica de la potencia de salida Mandado por un programa específico por un desarrollo optimizado y un equilibrio permanente de los valores entre el aparato y el tejido del paciente. La potencia de salida esta reglada automaticamente según la impedancia del tejido del paciente, el electrodo utilizado y la rapidez del trabajo.

HF-Geräte | Appareils HF
 HF-units | Aparados HF
 Apparecchi AF

TOM 141 DPS

240 V	tk 90005-00
110 V	tk 90005-01

ACCESSORY SET
tk 90005-50

Monopolar cutting

	PURE	BLEND
Max. output power	140 W	120 W
Rated load	450 Ω	450 Ω
V _{pp}	1180	1430
Crest factor	1.65	2.7

PURE - Pure cut without coagulating effect
BLEND - Cut blended with a medium coagulating effect
Bipolar coagulation

	COAG
Max. output power	100 W
Rated load	100 Ω
V _{pp}	400
Crest factor	1.4

COAG - Contact, low voltage coagulation
Monopolar coagulation

	FULG	SOFT
Max. output power	120 W	60 W
Rated load	450 Ω	200 Ω
V _{pp}	2700	1400
Crest factor	6.7	2.7

FULG - Contact free high voltage coagulation
SOFT - Contact, low voltage coagulation
Technical data

Power supply	230/115 VAC ± 10%; 50/60 Hz
Power consumption	245 VA
Nominal frequency of HF currents	470 kHz
Main fuses	2, situated on the rear side
Equipotential connection	DIN connector
Cooling	by convection
Outputs	1x monopolar, 1x bipolar
EC approval and classification	IIb according to EC-93/42 EEC
Safety class	Class 1 according to CEI EN 60601-2-2
Type	CF according to IEC 60601-1 (Leakages less than 10 microA)
Dimensions (WxDxH)	300 x 255 x 120 mm
Weight	5 kg

HF-Geräte | Appareils HF
 HF-units | Aparados HF
 Apparecchi AF



TOM 141

240 V	tk 90004-00
110 V	tk 90004-01

ACCESSORY SET

tk 90004-50



Monopolar cutting

	PURE	BLEND
		
Max. output power	140 W	120 W
Rated load	450 Ω	450 Ω
Vpp	1180	1430
Crest factor	1.65	2.7

PURE - Pure cut without coagulating effect

BLEND - Cut blended with a medium coagulating effect

Bipolar coagulation

	COAG
	
Max. output power	100 W
Rated load	100 Ω
Vpp	400
Crest factor	1.4

COAG - Contact, low voltage coagulation

Monopolar coagulation

	FULG	SOFT
		
Max. output power	120 W	60 W
Rated load	450 Ω	200 Ω
Vpp	2700	1400
Crest factor	6.7	2.7

FULG - Contact free high voltage coagulation

SOFT - Contact, low voltage coagulation

Technical data

Power supply	230/115 VAC ± 10%; 50/60 Hz
Power consumption	245 VA
Nominal frequency of HF currents	470 kHz
Main fuses	2, situated on the rear side
Equipotential connection	DIN connector
Cooling	by convection
Outputs	1x monopolar, 1x bipolar
EC approval and classification	IIb according to EC-93/42 EEC
Safety class	Class 1 according to CEI EN 60601-2-2
Type	CF according to IEC 60601-1 (Leakages less than 10 microA)
Dimensions (WxDxH)	280 x 255 x 120 mm
Weight	4.7 kg

HF-Geräte | Appareils HF
 HF-units | Aparados HF
 | Apparecchi AF



weitere Modelle und Zubehör, siehe unseren Spezial Katalog
for further units and accessories, see our special catalogue
 pour d'autres modèles et accessoires, voir notre catalogue special
para otros modelos y accesorios, ver nuestro catálogo especial
 per altri modelli ed accessori riferirsi al nostro specifico catalogo



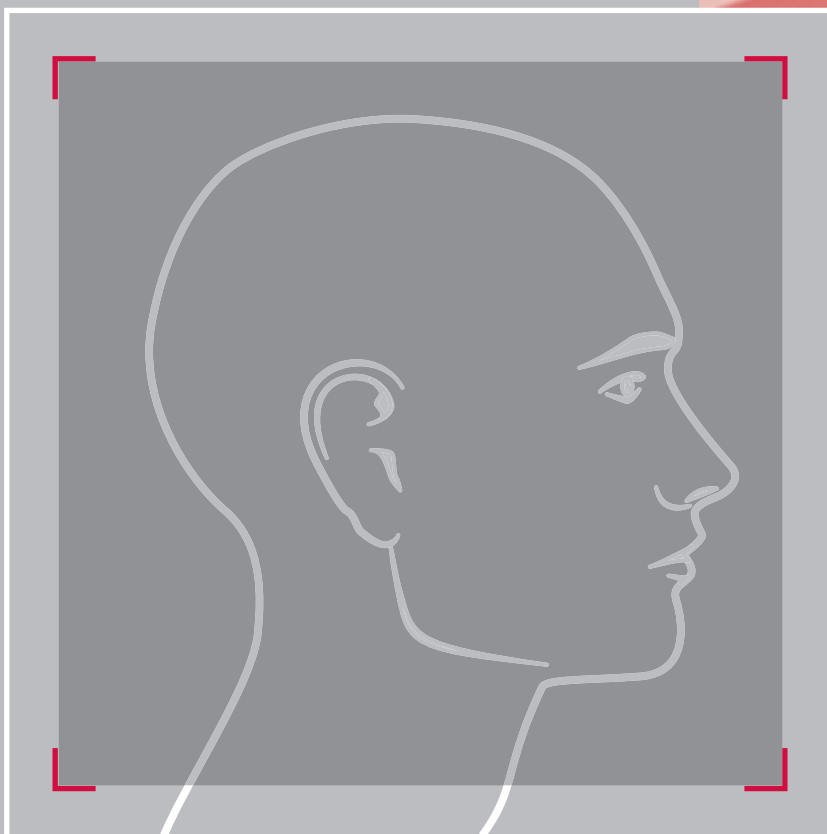



















Instrumentensätze
Instrument sets















Jeux d'instruments
Juegos de instrumentos
Set di strumenti

Endoskopische endonasale Nasennebenhöhlenchirurgie
Endoscopic Sinus Surgery
Chirurgie endoscopique du sinus
Cirugía endoscópica del sinus
Chirurgia endoscopica del seno
ESS-SET
tk56000-02

[pos 01]	<i>Modular sheath system for 4mm scope 0-30°</i>			tk 39155-00	
[pos 02]	<i>Modular sheath system for 4mm scope 70°</i>			tk 39156-00	
KILLIAN [pos 03]	<i>Nasal speculum, 90mm</i>		130 mm	tk 50828-04	→ R 65
COTTLE [pos 04]	<i>nasal speculum, 50mm</i>		150 mm	tk 50836-50	→ R 67
PLESTER [pos 05]	<i>Maxillary sinus suction tube CVD, 2.5mm</i>		170 mm	tk 25229-92	
PLESTER [pos 06]	<i>Maxillary sinus suction tube CVD, 3.2mm</i>		170 mm	tk 25229-93	
PLESTER [pos 07]	<i>Maxillary sinus suction tube CVD, 4.0mm</i>		170 mm	tk 25229-94	
FERGUSSON [pos 08]	<i>Suction cannula, 10 Charr.</i>		170 mm	tk 25228-10	→ R 40
FERGUSSON [pos 09]	<i>Suction cannula, 12 Charr.</i>		170 mm	tk 25228-12	→ R 40
RITTER-HALLE [pos 10]	<i>Sinus bougie, 3 mm</i>		160 mm	tk 6376-30	→ R 100
RITTER-HALLE [pos 11]	<i>Sinus bougie, 4 mm</i>		160 mm	tk 6376-40	→ R 100
RITTER-HALLE [pos 12]	<i>Sinus bougie, 5 mm</i>		160 mm	tk 6376-50	
[pos 13]	<i>Sinuscope, Ø 4 mm, 30°, TEKNO-Flex</i>		175 mm	tk700-133 SF	→ R 125, R 319
[pos 14]	<i>Sinuscope, Ø 4 mm, 70°, TEKNO-Flex</i>		175 mm	tk 700-137 SF	→ R 125, R 319
WEIL-BLAKESLEY [pos 15]	<i>Nasal cutting forcep, fig.1</i>			tk 51155-01	→ R 82
WEIL-BLAKESLEY [pos 16]	<i>Nasal cutting forcep, fig.2</i>			tk 51155-02	→ R 82
WEIL-BLAKESLEY [pos 17]	<i>Nasal cutting forcep, fig.1, curved up 45°</i>			tk 51158-01	→ R 82
WEIL-BLAKESLEY [pos 18]	<i>Nasal cutting forcep, fig.2, curved up 45°</i>			tk 51158-02	→ R 82

Endoskopische endonasale Nasennebenhöhlenchirurgie
Endoscopic Sinus Surgery

 Chirurgie endoscopique du sinus
Cirugía endoscópica del sinus
 Chirurgia endoscopica del seno

WEIL- BLAKESLEY [pos 19]	<i>Nasal cutting forcep, fig.1, curved up 90°</i>			tk 51159-01	→ R 82
[pos 20]	<i>Bipol forcep, insulated, blunt, bay.</i>		200mm	tk 90185-20	
HALLE [pos 21]	<i>Curette, double ended</i>		230mm	tk 50629-23	
WEIL- BLAKESLEY [pos 22]	<i>Nasal cutting forcep, fig.2, curved up 90°</i>			tk 51159-02	→ R 82
HENKE- GRÜN WALD [pos 23]	<i>Punch</i>			tk 51176-11	
[pos 24]	<i>Biopsy forceps, double action, 3 mm, 70°, horizontal</i>			tk 51732-03	→ R 130
[pos 25]	<i>Biopsy forceps, double action, 3mm, 110°, vertical</i>			tk 51740-03	→ R 130
[pos 26]	<i>Nasal scissor, serrated, straight, 135mm shaft</i>			tk 51700-01	→ R 71, R 129
[pos 27]	<i>Ostrum punch 1.5 mm x 4.5 mm, backward upcutting</i>			tk 51175-01	→ R 133
[pos 28]	<i>Circular punch, straight, 4.5 mm</i>			tk 51710-04	→ R 132
HAJEK- KOFLEK [pos 29]	<i>Punch, 360° rotating, 3.5 mm x 3.5 mm</i>			tk 51198-04	→ R 134
HAJEK- KOFLEK [pos 30]	<i>Punch, upwards, 3.5 mm x 3.5 mm</i>			tk 51196-12	→ R 134
HAJEK- KOFLEK [pos 31]	<i>Punch, upwards, 4.3 mm x 4.3 mm</i>			tk 51194-13	→ R 134
[pos 32]	<i>sterilization container (1/1, 580 x 280 x 150mm)</i>			tk 87190-1F-SI	
[pos 33]	<i>wire basket (480 x 250 x 70mm)</i>			tk 87014-03	

 Abbildungen ähnlich
 Illustrations similar



















 Illustrations similaires
 Ilustraciones similares

Altri adattatori a richiesta

Septorhinoplastik | *Septorhinoplastique*
Septorhinoplasty | *Septorhino plastica*
 Settorino plastica

SRP-SET



















tk56000-01

COTTLE [pos 01]	<i>Nasal Speculum, 50 mm</i>		150 mm	tk50836-50	→ R 67
COTTLE [pos 02]	<i>Nasal Speculum, 90 mm</i>		150 mm	tk50836-90	→ R 67
[pos 03]	<i>Iris scissor curved, super cut</i>		115 mm	tk9434-11SU	
JOSEPH [pos 04]	<i>Scissor curved, super cut</i>		140 mm	tk8693-14SU	
HALSTED- MOSQUITO [pos 05]	<i>Haemostatic forcep, curved</i>		125 mm	tk12011-12	→ R 254
HEYMANN [pos 06]	<i>Nasal scissor</i>		180 mm	tk9137-18	→ R 70
MICRO- ADSON [pos 07]	<i>Tissue forcep, 1x2 teeth</i>		120 mm	tk11202-12	→ R 247
ADSON- BROWN [pos 08]	<i>Tissue forcep</i>		120 mm	tk11210-12	→ R 247
ADSON [pos 09]	<i>Tissue forcep, 1x2 teeth</i>		120 mm	tk11200-12	→ R 247
JANSEN (GRUENWALD) [pos 10]	<i>Nose forcep, bayonet</i>		160 mm	tk11607-16	→ R 23, R 68
COTTLE [pos 11]	<i>Nose forcep</i>		145 mm	tk11629-14	→ R 22, R 69
[pos 12]	<i>Scalpel handle, No.3</i>			tk7110-03	→ R 232
[pos 13]	<i>Scalpel handle, round, No.3</i>			tk7100-04	→ R 231
ROWLAND- MEYER [pos 14]	<i>Bone cutting forcep, curved</i>		200 mm	tk51250-20	
RUBIN [pos 15]	<i>Septum crushing forceps</i>		210 mm	tk51188-21	→ R 103
BACKHAUS [pos 16]	<i>Towel forcep</i>		90 mm	tk12805-09	→ R 263
WEIL- BLAKESLEY [pos 17]	<i>Nasal cutting forcep, fig.1</i>			tk51155-01	→ R 82
[pos 18]	<i>Needle holder for intra nasal suture</i>			tk51750-13	→ R 169, R 288













13

Septorhinoplastik
Septorhinoplasty

Septorhinoplastique
Septorhino plastica
Settorino plastica

FERGUSSON [pos 19]	Suction cannula, 12 Charr.		170 mm	tk 25228-12	→ R 40
FERGUSSON [pos 20]	Suction cannula, 10 Charr.		170 mm	tk 25228-10	→ R 40
MASING [pos 21]	Cartilage slitting knife, head curved		130 mm	tk 51313-13	
MAYO-HEGAR [pos 22]	Needle holder, TC		140 mm	tk 20512-14 TC	→ R 282
COTTLE [pos 23]	Mallet, convex/flat, 250 gr		190 mm	tk 50581-19	→ R 62
RUBIN [pos 24]	Osteotome, 14 mm		180 mm	tk 24290-14	→ R 116
RUBIN [pos 25]	Osteotome, 16 mm		180 mm	tk 24290-16	
WALTER [pos 26]	Osteotome, 12 mm		190 mm	tk 24294-12	
WALTER [pos 27]	Osteotome, 3 mm		190 mm	tk 24294-03	
WALTER [pos 28]	Bone chisel, swallowtail, 3 mm		190 mm	tk 24292-03	→ R 117
SILVER [pos 29]	Osteotome, straight		180 mm	tk 24296-01	→ R 118
COTTLE [pos 30]	Chisel, 4 mm		180 mm	tk 24280-04	→ R 115
AUFRICHT [pos 31]	Glabella rasp		210 mm	tk 51669-21	→ R 97
[pos 32]	Diamond nasal rasp, straight		190 mm	tk 51751-15	
FOMON [pos 33]	Rasp, TC, fig. 3/4		200 mm	tk 51686-03	→ R 98
FOMON [pos 34]	Rasp, TC, fig. 9/10		200 mm	tk 51686-09	→ R 98
COTTLE [pos 35]	Septum knife, 7 mm		140 mm	tk 51647-10	
MASING [pos 36]	Periosteal elevator		200 mm	tk 51636-21	→ R 110
[pos 37]	Suction raspatory, sharp		200 mm	tk 51645-20	→ R 127, R 228
COTTLE [pos 38]	(2x) Hooklet, fig.2		150 mm	tk 16905-02 (2x)	→ R 86

Septorhinoplastik | *Septorhinoplastique*
Septorhinoplasty | *Septorhino plastica*
Settorino plastica

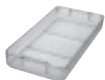
NEIVERT [pos 39]	<i>Retractor, double ended</i>		200 mm	tk 16916-16	→ R 88
AUFRICHT [pos 40]	<i>Nasal retractor</i>		135 mm	tk 16519-13	
COTTLE [pos 41]	<i>Thumb hook</i>			tk 17750-00	→ R 89
COTTLE [pos 42]	<i>Bone crusher with clamp</i>			tk 51648-00	→ R 100
[pos 43]	<i>Cartilage holder</i>			tk 51755-00	
[pos 44]	<i>Bipolar forcep, insulated, blunt, bajonet</i>		180 mm	tk 90185-18	
KRAUSE [pos 45]	<i>Nasal polypus snare</i>		260 mm	tk 50323-26	→ R 91
[pos 46]	<i>Steel wire loops, 0.3mm, 12pcs</i>		100 mm	tk 50320-30	→ R 32, R 91
[pos 47]	<i>Bowl, stainless, 0.063 l</i>		61 mm x 30 mm	tk 83110-05	→ R 311
[pos 48]	<i>Bowl, stainless, 0.16 l</i>		83 mm x 41 mm	tk 83110-09	→ R 311
[pos 49]	<i>Bowl, stainless, 0.25 l</i>		120 mm x 35 mm	tk 83110-25	
[pos 50]	<i>Oil stone</i>			tk 51880-00	
[pos 51]	<i>sterilization container (1/1, 580 x 280 x 150mm)</i>			tk 87190-1F-SI	
[pos 52]	<i>wire basket (480 x 250 x 70mm)</i>			tk 87014-03	





















Abbildungen ähnlich
Illustrations similar
 Illustrations similaires
Ilustraciones similares
 Altri adattatori a richiesta





















Tympanoplastik | Tympanoplastique
 Tympanoplasty | Tympanoplastica
 Tympanoplastica

TPS-SET

tk 56000-04

HARTMANN- HALLE [pos 01]	Nasal Speculum, fig.2		150 mm	tk 50813-02	→ R 64
HARTMANN [pos 02]	Ear speculum, fig.3		Ø 6.5 mm	tk 50022-13	→ R 15
HARTMANN [pos 03]	Ear speculum, fig.2		Ø 5.5 mm	tk 50022-12	→ R 15
HARTMANN [pos 04]	Ear speculum, fig.1		Ø 4.5 mm	tk 50022-11	→ R 15
HARTMANN [pos 05]	Ear speculum for children, fig.0		Ø 3.0 mm	tk 50020-10	→ R 15
PLESTER [pos 06]	Retractor, 2 prongs on both sides, sharp		130 mm	tk 17451-13	→ R 37
WULLSTEIN [pos 07]	Retractor, 3 prongs on both sides, sharp		100 mm	tk 17408-01	→ R 35
PLESTER [pos 08]	Retractor, 2 prongs, right valve		110 mm	tk 17453-11	→ R 37
PLESTER [pos 09]	Retractor, 2 prongs, left valve		110 mm	tk 17452-11	→ R 37
WIGAND [pos 10]	Retractor, flap for the left ear		110 mm	tk 17445-11	
WIGAND [pos 11]	Retractor, flap for the right ear		110 mm	tk 17445-12	
WILLIGER [pos 12]	Retractor, 3-prongs		130 mm	tk 56775-13	→ R38
KNAPP (ROLLET) [pos 13]	Retractor, flexible		160 mm	tk 17025-16	→ R 270
[pos 14]	Scalpel handle, No.3			tk 7110-03	→ R 232
JOSEPH [pos 15]	Scissors, curved		140 mm	tk 8693-14	
GRAZIL [pos 16]	Standard scissors, curved, fig.2		140 mm	tk 8054-13	→ R 238
ADSON- BROWN [pos 17]	tissue forceps		120 mm	tk 11210-12	→ R 247
[pos 18]	Jeweller forceps, without serration, straight		135 mm	tk 26006-13	

Tympanoplastik | *Tympanoplastique*
Tympanoplasty | *Timpanoplastica*
Timpanoplastica

[pos 19]	<i>Dressing forceps</i>		145 mm	tk 10102-14	
BABY CRILE-WOOD [pos 20]	<i>Needle holder, TC</i>		150 mm	tk 20504-15 TC	→ R 280
BACKHAUS [pos 21]	<i>towel forceps</i>		110 mm	tk 12805-11	→ R 263
MICRO-MOSQUITO [pos 22]	<i>haemostatic forceps, curved</i>		120 mm	tk 12021-12	→ R 255
ERLANGER [pos 23]	<i>Raspatory</i>		195 mm	tk 24517-19	
[pos 24]	<i>Bipolar forceps, pointed, 0.3 mm</i>		170 mm	tk 90776-17	
[pos 25]	<i>Outer case, non perforated, Ø65 mm</i>			tk 55250-65	
[pos 26]	<i>Preparing plate, autoclavable, 80 mm x 40 mm x 10 mm</i>			tk 51880-05	
[pos 27]	<i>(2x) Bowl, stainless, 0.063 l</i>		61 mm x 30 mm	tk 83110-05 (2x)	→ R 311
[pos 28]	<i>Bowl, stainless, 0.16 l</i>		83 mm x 41 mm	tk 83110-09	→ R 311
JACOBSON [pos 29]	<i>Buttomed probe</i>		190 mm	tk 25400-21	
HOUSE [pos 30]	<i>Spoon, slightly curved, 1.0/1.2 mm</i>		150 mm	tk 50574-01	→ R 61
HOUSE [pos 31]	<i>Spoon, slightly curved, 1.5/1.8 mm</i>		150 mm	tk 50574-02	→ R 61
STACKE [pos 32]	<i>Probe and director, 1 mm</i>		105 mm	tk 18106-10	
WULLSTEIN [pos 33]	<i>Aspiration handle, luer lock</i>			tk 6381-90	
[pos 34]	<i>(2x) Suction tube, Ø1.0mm</i>		90 mm	tk 25261-10 (2x)	
[pos 35]	<i>(2x) Suction tube, Ø1.5mm</i>		90 mm	tk 25261-15 (2x)	
[pos 36]	<i>(2x) Suction tube, Ø2.0mm</i>		90 mm	tk 25261-20 (2x)	
ROSEN [pos 37]	<i>(2x) Suction tube, angled, 0.70 mm</i>		65 mm	tk 25244-01 (2x)	→ R 41
ROSEN [pos 38]	<i>(2x) Suction tube, angled, 0.90 mm</i>		65 mm	tk 25244-02 (2x)	→ R 41

13

Tympanoplastik | Tympanoplastique
 Tympanoplasty | Tympanoplastica
 Tympanoplastica

[pos 39]	<i>Micro needle, slightly curved, pointed</i> 	160 mm	tk 50543-02	→ R 57
[pos 40]	<i>Micro needle, strongly curved, pointed</i> 	160 mm	tk 50543-03	→ R 57
SHAMBAUGH [pos 41]	<i>Hook, 45°, 0.4 mm</i> 	160 mm	tk 50544-04	→ R 57
SHAMBAUGH [pos 42]	<i>Hook, 45°, 1.0 mm</i> 	160 mm	tk 50544-10	→ R 57
SHAMBAUGH [pos 43]	<i>Hook, 90°, 0.2 mm</i> 	160 mm	tk 50545-02	→ R 57
SHAMBAUGH [pos 44]	<i>Hook, 90°, 0.6 mm</i> 	160 mm	tk 50545-06	→ R 57
SHAMBAUGH [pos 45]	<i>Hook, 90°, 1.0 mm</i> 	160 mm	tk 50545-10	→ R 57
SHAMBAUGH [pos 46]	<i>Hook, 90°, 1.5 mm</i> 	160 mm	tk 50545-15	
SHAMBAUGH [pos 47]	<i>Hook, 90°, 3.0 mm</i> 	160 mm	tk 50545-30	
[pos 48]	<i>Circular cutting knife, 25°, 1.0 mm</i> 	160 mm	tk 50551-07	
[pos 49]	<i>Circular cutting knife, 25°, 1.5 mm</i> 	160 mm	tk 50551-05	
[pos 50]	<i>Circular cutting knife, 25°, 2.5 mm</i> 	160 mm	tk 50551-03	
[pos 51]	<i>Circular cutting knife, 25°, 4.0 mm</i> 	160 mm	tk 50551-09	
[pos 52]	<i>Circular cutting knife, 45°, 1.5 mm</i> 	160 mm	tk 50552-05	→ R 54
[pos 53]	<i>Circular cutting knife, 45°, 2.6 mm</i> 	160 mm	tk 50552-03	→ R 54
[pos 54]	<i>Circular cutting knife, 45°, 3.5 mm</i> 	160 mm	tk 50552-08	
PLESTER [pos 55]	<i>Flap knife, 2.4 mm x3.0 mm</i> 	160 mm	tk 50550-06	→ R 54
[pos 56]	<i>Circular cutting knife, 90°, 2.5 mm</i> 		tk 50552-53	
ROSEN [pos 57]	<i>Lancet knife</i> 	160 mm	tk 50539-03	→ R 54
[pos 58]	<i>(2x) Sickle knife, slightly curved</i> 	160 mm	tk 50550-03 (2x)	→ R 54

**Tympanoplastik
Tympanoplasty**
**Tympanoplastique
Tímpanoplastica
Timpanoplastica**

[pos 59]	<i>Micro ear forceps, straight, serrated, 4.0 mm x 0.8 mm</i>		75 mm	tk 50420-02	→ R 48
HOUSE-DIETER [pos 60]	<i>Malleus nipper upwards</i>		80 mm	tk 50432-01	→ R 47
HARTMANN-WULLSTEIN [pos 61]	<i>Polypus forceps, 1 mm</i>		85 mm	tk 50457-08	→ R 46
[pos 62]	<i>Micro spoon forceps, straight, 1.25 mm x 0.9 mm</i>		75 mm	tk 50424-10	→ R 49
BELUCCI [pos 63]	<i>Micro ear scissors, straight, pointed, 4 mm</i>		75 mm	tk 50426-07	→ R 51
BELUCCI [pos 64]	<i>Micro ear scissors, left curved, pointed, 4 mm</i>		75 mm	tk 50426-06	→ R 51
BELUCCI [pos 65]	<i>Micro ear scissors, right curved, pointed, 4 mm</i>		75 mm	tk 50426-05	→ R 51
[pos 66]	<i>sterilization container (1/1, 580 x 280 x 150mm)</i>			tk 87190-1F-SI	
[pos 67]	<i>wire basket (480 x 250 x 70mm)</i>			tk 87014-03	



Abbildungen ähnlich
Illustrations similar

Illustrations similaires
Ilustraciones similares











Altri adattatori a richiesta

Tympanoplastik und Steigbügel
Tympanoplasty and stapes

Tympanoplastique y étriers
Tímpanoplastica y estribos
Timpanoplastica e staffan

STAPES-SET

tk 56000-05

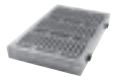
FISCH [pos 01]	Perforator, 0.3 mm 	160 mm	tk 50766-03	
FISCH [pos 02]	Perforator, 0.4 mm 	160 mm	tk 50766-04	
FISCH [pos 03]	Perforator, 0.5 mm 	160 mm	tk 50766-05	
FISCH [pos 04]	Perforator, 0.6 mm 	160 mm	tk 50766-06	
FISCH [pos 05]	Footplate hook, tip angled upwards, 90°, 0.2 mm 	160 mm	tk 50780-16	
FISCH [pos 06]	Footplate hook, tip angled downwards, 90°, 0.2 mm 	160 mm	tk 50779-16	
FISCH [pos 07]	Caliper, 0.6mm 	165 mm	tk 51783-16	
FISCH [pos 08]	Caliper, 0.4mm 	165 mm	tk 51782-16	
FISCH [pos 09]	Caliper 	165 mm	tk 51781-16	
MC GEE [pos 10]	Wire closure forceps, 0.8x3.5mm 	165 mm	tk 50430-00	→ R 47
[pos 11]	Container for micro instruments 		tk 55794-00	



Abbildungen ähnlich
Illustrations similar

Illustrations similaires
Ilustraciones similares

Altri adattatori a richiesta

Nummernverzeichnis
Numerical index

Index des numéros de référence
Indice numerico
Indice dei numeri d'articolo

**Nummernverzeichnis
Numerical Index**
**Index numériques
Indice numerico
Indice dei numeri d'articolo**
tk 700-

tk 700-048 160, 321
tk 700-049 160, 321
tk 700-051 160, 321
tk 700-054 160, 321
tk 700-055 161, 322
tk 700-056 161, 322
tk 700-057 161, 322
tk 700-058 161, 322
tk 700-080 8, 320
tk 700-083 8, 320
tk 700-090 8, 320
tk 700-093 8, 320
tk 700-094 8, 320
tk 700-098 125, 319
tk 700-099 125, 319
tk 700-100 125, 319
tk 700-100SF ... 125, 319
tk 700-101 125, 319
tk 700-103 125, 319
tk 700-103SF ... 125, 319
tk 700-105 125, 319
tk 700-107 125, 319
tk 700-110 125, 319
tk 700-110SF ... 125, 319
tk 700-113 125, 319
tk 700-113SF ... 125, 319
tk 700-117 125, 319
tk 700-120 125, 319
tk 700-120SF ... 125, 319
tk 700-123 125, 319
tk 700-123SF ... 125, 319
tk 700-127 125, 319
tk 700-130 125, 319
tk 700-130SF ... 125, 319
tk 700-133 125, 319
tk 700-133SF ... 125, 319
tk 700-134 125, 319
tk 700-134SF ... 125, 319
tk 700-137 125, 319
tk 700-137SF ... 125, 319
tk 700-140 190, 323
tk 700-143 190, 323
tk 700-150 190, 323
tk 700-153 190, 323
tk 700-155 190, 323
tk 700-157 190, 323
tk 700-158 190, 323
tk 700-160 125, 319
tk 700-165 125, 319

tk 700-170 125, 319
tk 700-175 125, 319
tk 700-180 125, 319
tk 700-185 125, 319
tk 700-190 125, 319
tk 700-195 125, 319
tk 700-196 125, 319
tk 700-197 125, 319
tk 700-198 125, 319
tk 700-199 125, 319
tk 700-267 .. 94, 324
tk 700-269 .. 94, 324
tk 700-994 126
tk 700-996 126
tk 700-999 341
tk 707-650 341
tk 707-651 341
tk 754-0250 333
tk 754-2100S 328
tk 754-2100 USB
..... 328
tk 754-2101S 328
tk 754-2101 USB
..... 328
tk 754-2150S 330
tk 754-2150SA.. 331
tk 754-2151S 330
tk 754-2151SA.. 331
tk 754-2152 D... 330
tk 754-2153 D... 330
tk 754-3330 326
tk 754-3331 326
tk 754-3332 326
tk 754-3333 326
tk 754-3334 326
tk 754-3335 326
tk 754-3350 326
tk 754-3351 326
tk 754-3352 326
tk 754-3353 326
tk 754-3354 326
tk 754-3355 326
tk 754-3900-21. 327
tk 754-3912 328, 330
tk 754-H250 332
tk 754-H252 332
tk 754-R180 335
tk 754-XA180 334
tk 754-XM180 ... 334
tk 758-1300 336
tk 758-1301 336

tk 4000-

tk 4430-00 198
tk 4432-00 198
tk 4434-00 8, 198
tk 4510-00 199
tk 4511-00 199
tk 4520-09 199

tk 4550-00 199
tk 4552-00 199
tk 4555-06 200
tk 4555-07 200
tk 4556-06 200
tk 4557-01 200
tk 4557-06 200
tk 4557-07 200
tk 4559-00 203
tk 4559-30 201
tk 4559-50 201
tk 4559-51 201
tk 4559-53 201
tk 4559-55 202
tk 4560-06 200
tk 4560-07 200
tk 4561-50 202
tk 4569-00 204
tk 4570-00 204
tk 4570-01 204
tk 4585-01 200
tk 4596-00 205
tk 4596-01 205

tk 5000-

tk 5100-00 209
tk 5100-01 209
tk 5100-02 209
tk 5100-03 209
tk 5100-04 209
tk 5100-05 209
tk 5110-03 209
tk 5110-04 209
tk 5110-05 209
tk 5110-11 209
tk 5110-12 209
tk 5110-13 209
tk 5120-00 210
tk 5120-01 210
tk 5120-02 210
tk 5120-03 210
tk 5120-04 210
tk 5121-03 210
tk 5121-04 210
tk 5121-05 210
tk 5121-11 210
tk 5121-12 210
tk 5121-13 210
tk 5140-07 211
tk 5141-07 211
tk 5142-07 211
tk 5143-07 211
tk 5145-01 209
tk 5145-02 209, 210
tk 5150-00 212
tk 5150-01 212
tk 5150-02 212
tk 5150-03 212
tk 5150-04 212
tk 5150-05 212

tk 5151-03 212
tk 5151-04 212
tk 5151-05 212
tk 5160-00 213
tk 5160-01 213
tk 5160-02 213
tk 5160-03 213
tk 5160-04 213
tk 5161-03 213
tk 5161-04 213
tk 5161-05 213
tk 5175-09 214
tk 5176-09 214
tk 5183-05 215
tk 5184-05 215
tk 5186-04 215
tk 5186-06 215
tk 5187-04 204, 215
tk 5190-01 162
tk 5190-02 162
tk 5190-03 162
tk 5191-01 162
tk 5191-02 162
tk 5191-03 162
tk 5195-01 162
tk 5195-02 162
tk 5196-01 162
tk 5196-02 162
tk 5220-25 225
tk 5230-20 225
tk 5240-17 225
tk 5250-01 163
tk 5250-02 163
tk 5250-03 163
tk 5250-04 163
tk 5250-05 164
tk 5250-06 164
tk 5250-07 164
tk 5251-00 164
tk 5251-50 164
tk 5252-00 165
tk 5254-00 165
tk 5256-00 165
tk 5258-00 165
tk 5259-00 163
tk 5259-01 163
tk 5260-00 165
tk 5410-17 208
tk 5410-90 208
tk 5430-16 208
tk 5430-17 208
tk 5430-19 208
tk 5471-12 218
tk 5471-14 218
tk 5471-16 218
tk 5475-14 207
tk 5477-14 207
tk 5479-01 207
tk 5479-02 207
tk 5480-15 207

tk 5481-11 207
tk 5482-16 206
tk 5483-14 206
tk 5485-15 206
tk 5486-17 206
tk 5487-19 206
tk 5489-16 206

tk 6000-

tk 6163-13 185
tk 6169-00 126
tk 6169-03 126
tk 6169-05 126
tk 6210-16 226
tk 6225-03 226
tk 6225-04 226
tk 6225-05 226
tk 6230-15 226
tk 6235-16 226
tk 6350-02 227
tk 6350-27 227
tk 6361-20 18
tk 6361-25 18
tk 6361-30 18
tk 6363-20 18
tk 6363-25 18
tk 6363-30 18
tk 6371-16 127
tk 6372-16 127
tk 6375-00 19
tk 6375-10 19
tk 6376-25 100
tk 6376-30 100
tk 6376-40 100
tk 6380-00 18
tk 6380-01 18
tk 6380-02 18
tk 6380-03 18
tk 6380-04 18
tk 6380-05 18
tk 6381-00 227
tk 6381-01 227
tk 6381-02 44
tk 6381-02 227
tk 6382-01 19
tk 6382-02 19
tk 6382-03 19
tk 6382-04 19
tk 6382-05 19
tk 6383-01 227
tk 6383-02 227
tk 6383-04 227
tk 6383-05 227
tk 6385-00 19
tk 6388-01 158
tk 6388-02 158
tk 6388-03 158
tk 6388-04 158
tk 6401-25 .. 45, 168
tk 6402-25 .. 45, 168

tk 6404-40 .. 45, 168
tk 6405-40 .. 45, 168
tk 6710-01 158
tk 6710-02 158
tk 6710-05 158
tk 6710-10 158
tk 6710-20 158
tk 6710-50 158
tk 6711-01 158
tk 6711-02 158
tk 6711-05 158
tk 6711-10 158
tk 6711-20 158
tk 6711-50 158
tk 6780-02 158
tk 6780-05 158
tk 6780-10 158
tk 6781-02 158
tk 6781-05 158
tk 6781-10 158
tk 6782-02 158

tk 7000-

tk 7100-04 231
tk 7101-04 231
tk 7102-04 231
tk 7105-08 231
tk 7110-03 232
tk 7110-07 232
tk 7110-71 232
tk 7111-03 232
tk 7112-03 232
tk 7113-05 232
tk 7115-03 232
tk 7116-03 232
tk 7120-13 234
tk 7121-03 234
tk 7121-04 234
tk 7121-07 234
tk 7121-09 234
tk 7210-10T 233
tk 7210-11T 233
tk 7210-12DT 233
tk 7210-12T 233
tk 7210-15CT 233
tk 7210-15T 233
tk 7210-18T 233
tk 7210-20T 233
tk 7210-21T 233
tk 7210-22T 233
tk 7210-23T 233
tk 7210-24T 233
tk 7890-20 235
tk 7900-00 235
tk 7901-00 235
tk 7902-00 235
tk 7904-00 236
tk 7905-00 236
tk 7907-00 236
tk 7908-00 236

Nummernverzeichnis
Numerical Index
Index numériques
Indice numerico
Indice dei numeri d'articolo

tk 8000-	tk 8053-14 238	tk 8385-20 241	tk 10503-12 245	tk 11930-06 253	tk 12011-12 254
tk 8023-10 237	tk 8054-13 238	tk 8385-23 241	tk 10503-15 245	tk 11931-03 253	tk 12011-14 254
tk 8023-11 237	tk 8054-14 238	tk 8462-16 243	tk 10504-12 TC. 247	tk 11931-05 253	tk 12012-12 254
tk 8023-13 237	tk 8055-13 238	tk 8462-18 243	tk 10504-15 TC. 247	tk 11931-06 253	tk 12012-14 254
tk 8023-14 237	tk 8055-14 238	tk 8463-16 243	tk 10506-12 TC. 247	tk 11935-05 253	tk 12013-12 254
tk 8023-15 237	tk 8323-11 239	tk 8463-18 243	tk 10506-15 TC. 247	tk 11935-06 253	tk 12013-14 254
tk 8023-16 237	tk 8323-14 239	tk 8612-12 243	tk 10508-12 TC. 247	tk 11935-07 253	tk 12020-10 255
tk 8023-17 237	tk 8324-14 239	tk 8614-12 243	tk 10550-15 245,	tk 11940-08 253	tk 12020-12 255
tk 8023-18 237	tk 8325-14 239	tk 8652-09 242	250	tk 11940-12 253	tk 12020-14 255
tk 8023-20 237	tk 8333-11 239	tk 8652-10 242	tk 10600-20 250	tk 11940-16 253	tk 12021-10 255
tk 8024-10 237	tk 8333-14 239	tk 8652-11 242	tk 10601-20 250	tk 11940-20 253	tk 12021-12 255
tk 8024-11 237	tk 8334-14 239	tk 8653-09 242	tk 10604-20 250	tk 11941-08 253	tk 12021-14 255
tk 8024-13 237	tk 8335-14 239	tk 8653-10 242	tk 10608-15 247	tk 11941-12 253	tk 12022-10 255
tk 8024-14 237	tk 8343-18 240	tk 8653-11 242	tk 10608-23 247	tk 11941-16 253	tk 12022-12 255
tk 8024-15 237	tk 8343-20 240	tk 8662-14 242	tk 10616-15 247	tk 11941-20 253	tk 12023-10 255
tk 8024-16 237	tk 8343-23 240	tk 8663-14 242	tk 10616-20 247	tk 11955-19 261	tk 12023-12 255
tk 8024-17 237	tk 8343-25 240	tk 8672-10 242	tk 10616-25 247	tk 11960-12 251	tk 12030-14 255
tk 8024-18 237	tk 8343-28 240	tk 8673-10 242	tk 11086-15 248	tk 11960-14 251	tk 12031-12 255
tk 8024-20 237	tk 8343-30 240	tk 8682-10 242	tk 11086-20 248	tk 11960-16 251	tk 12032-14 255
tk 8025-10 237	tk 8344-18 240	tk 8683-10 242	tk 11087-15 248	tk 11960-20 251	tk 12034-15 256
tk 8025-11 237	tk 8344-20 240	tk 8832-18 150, 244	tk 11087-20 248	tk 11960-24 251	tk 12035-15 256
tk 8025-13 237	tk 8344-23 240	tk 8837-17 150	tk 11087-25 248	tk 11964-14 251	tk 12036-15 256
tk 8025-14 237	tk 8344-25 240	tk 8852-17 150	tk 11100-20 248	tk 11964-16 251	tk 12037-15 256
tk 8025-15 237	tk 8344-28 240	tk 8857-17 150	tk 11101-20 248	tk 11964-20 251	tk 12039-13 256
tk 8025-16 237	tk 8344-30 240	tk 8867-19 150, 244	tk 11150-18 248	tk 11964-24 251	tk 12039-15 256
tk 8025-17 237	tk 8345-18 240	tk 8872-19 244	tk 11150-21 248	tk 11964-30 251	tk 12040-14 257
tk 8025-18 237	tk 8345-20 240		tk 11150-25 248	tk 11965-16 251	tk 12040-16 257
tk 8025-20 237	tk 8345-23 240	tk 9000-	tk 11151-18 248	tk 11965-20 251	tk 12041-14 257
tk 8033-11 237	tk 8345-25 240	tk 9132-17 70	tk 11151-21 248	tk 11965-24 251	tk 12041-16 257
tk 8033-13 237	tk 8345-28 240	tk 9137-18 70	tk 11151-25 248	tk 11965-30 251	tk 12050-14 257
tk 8033-14 237	tk 8345-30 240	tk 9152-13 70	tk 11200-12 247	tk 11965-35 251	tk 12050-16 257
tk 8033-15 237	tk 8353-18 240	tk 9157-16 70	tk 11200-15 247	tk 11966-16 251	tk 12051-14 257
tk 8033-16 237	tk 8353-20 240	tk 9203-10 242	tk 11202-12 247	tk 11966-20 251	tk 12051-16 257
tk 8033-17 237	tk 8353-23 240	tk 9485-11 243	tk 11202-15 247	tk 11966-24 251	tk 12052-14 257
tk 8033-18 237	tk 8353-25 240	tk 9492-11 243	tk 11204-12 247	tk 11966-30 251	tk 12053-14 257
tk 8033-20 237	tk 8353-28 240		tk 11206-12 247	tk 11967-14 251	tk 12054-16 257
tk 8034-11 237	tk 8353-30 240	tk 10000-	tk 11206-13 247	tk 11967-16 251	tk 12055-16 257
tk 8034-13 237	tk 8354-18 240	tk 10300-12 245	tk 11206-15 247	tk 11967-20 251	tk 12056-14 258
tk 8034-14 237	tk 8354-20 240	tk 10300-15 245	tk 11210-12 247	tk 11967-24 251	tk 12056-16 258
tk 8034-15 237	tk 8354-23 240	tk 10310-17 246,	tk 11212-12 247	tk 11967-30 251	tk 12057-14 258
tk 8034-16 237	tk 8354-25 240	249	tk 11250-15 248	tk 11970-16 252	tk 12057-16 258
tk 8034-17 237	tk 8354-28 240	tk 10312-17 246,	tk 11300-12 245	tk 11970-20 252	tk 12058-13 258
tk 8034-18 237	tk 8354-30 240	249	tk 11300-15 245	tk 11970-24 252	tk 12058-14 258
tk 8034-20 237	tk 8356-18 240	tk 10313-17 246,	tk 11601-11 .. 22, 69	tk 11971-16 252	tk 12058-16 258
tk 8035-11 237	tk 8356-20 240	249	tk 11603-12 .. 22, 69	tk 11971-20 252	tk 12059-13 258
tk 8035-13 237	tk 8356-23 240	tk 10324-18 246,	tk 11605-14 .. 23, 68	tk 11971-24 252	tk 12059-14 258
tk 8035-14 237	tk 8356-25 240	249	tk 11606-14 .. 23, 68	tk 11972-16 252	tk 12059-16 258
tk 8035-15 237	tk 8356-28 240	tk 10325-18 246,	tk 11607-16 .. 23, 68	tk 11972-20 252	tk 12078-13 258
tk 8035-16 237	tk 8356-30 240	249	tk 11607-20 .. 23, 68	tk 11972-24 252	tk 12078-14 258
tk 8035-17 237	tk 8372-14 241	tk 10326-19 246,	tk 11608-13 .. 22, 69	tk 11975-16 252	tk 12078-16 258
tk 8035-18 237	tk 8373-14 241	249	tk 11609-16 .. 23, 68	tk 11975-20 252	tk 12079-13 258
tk 8035-20 237	tk 8374-14 241	tk 10400-17 245,	tk 11609-20 .. 23, 68	tk 11975-24 252	tk 12079-14 258
tk 8043-13 238	tk 8375-14 241	250	tk 11615-15 .. 22, 69	tk 11976-16 252	tk 12079-16 258
tk 8043-14 238	tk 8380-18 241	tk 10401-17 245,	tk 11615-20 69	tk 11976-20 252	tk 12094-19 151
tk 8044-13 238	tk 8380-20 241	250	tk 11617-18 .. 22, 69	tk 11976-24 252	tk 12095-19 151
tk 8044-14 238	tk 8380-23 241	tk 10402-17 TC. 245	tk 11629-14 .. 22, 69	tk 12000-10 254	tk 12110-12 254
tk 8045-13 238	tk 8381-18 241	tk 10500-12 245	tk 11635-10 .. 22, 69	tk 12001-10 254	tk 12111-12 254
tk 8045-14 238	tk 8381-20 241	tk 10500-15 245	tk 11640-15 TC. 245	tk 12006-08 254	tk 12112-12 254
tk 8053-13 238	tk 8381-23 241	tk 10502-12 TC. 245	tk 11930-03 253	tk 12010-12 254	tk 12113-12 254
	tk 8385-18 241	tk 10502-15 TC. 245	tk 11930-05 253	tk 12010-14 254	tk 12120-15 151

Nummernverzeichnis
Numerical Index
Index numériques
Indice numerico
Indice dei numeri d'articolo

tk 12120-18 151	tk 12802-13 263	tk 16905-02 86	tk 17039-17 271	tk 17402-16 275	tk 19460-28 229
tk 12121-15 151	tk 12802-15 263	tk 16905-03 86	tk 17039-20 271	tk 17402-23 275	tk 19470-28 167
tk 12121-18 151	tk 12805-09 263	tk 16906-01 92	tk 17039-22 271	tk 17402-26 275	tk 19470-28 229
tk 12140-14 257	tk 12805-11 263	tk 16906-02 92	tk 17040-01 272	tk 17403-13 275	tk 19501-28 230
tk 12141-14 257	tk 12805-13 263	tk 16906-19 89	tk 17040-02 272	tk 17403-16 275	tk 19503-23 230
tk 12195-15 256	tk 12805-15 263	tk 16907-10 89	tk 17041-22 271	tk 17404-20 275	
tk 12196-15 256	tk 12807-11 263	tk 16908-12 89	tk 17042-22 271	tk 17404-26 275	
tk 12230-20 153	tk 12809-13 264	tk 16910-02 87	tk 17043-22 271	tk 17404-30 275	tk 20000-
tk 12231-20 153	tk 12810-05 264	tk 16910-05 87	tk 17044-22 271	tk 17404-36 275	tk 20001-15 279
tk 12233-20 153	tk 12810-09 264	tk 16910-07 87	tk 17046-22 271	tk 17405-20 275	tk 20002-15 279
tk 12241-19 152	tk 12820-09 264	tk 16910-10 87	tk 17048-22 271	tk 17405-26 275	tk 20002-20 279
tk 12243-19 152	tk 12825-18 264	tk 16912-20 88	tk 17051-22 271	tk 17406-01 35	tk 20003-14 280
tk 12250-14 257	tk 12830-10 264	tk 16914-16 88	tk 17052-22 271	tk 17406-02 35	tk 20008-12 279
tk 12250-21 152	tk 12830-13 264	tk 16915-01 88	tk 17053-22 271	tk 17408-01 35	tk 20009-13 280
tk 12250-26 152	tk 12840-13 265	tk 16915-02 88	tk 17054-22 271	tk 17408-02 35	tk 20010-13 281
tk 12251-14 257	tk 12840-15 265	tk 16915-03 88	tk 17056-22 271	tk 17408-13 35	tk 20011-13 281
tk 12251-21 152	tk 12840-20 265	tk 16916-16 88	tk 17058-22 271	tk 17408-14 35	tk 20012-14 282
tk 12251-26 152	tk 12845-10 265	tk 16917-15 89	tk 17059-01 271	tk 17409-13 35	tk 20012-16 282
tk 12252-21 152	tk 12845-13 265	tk 16918-15 89	tk 17059-02 271	tk 17410-11 36	tk 20012-18 282
tk 12252-26 152	tk 12847-14 265	tk 16920-16 87	tk 17059-03 271	tk 17410-13 36	tk 20012-20 282
tk 12253-21 152	tk 12850-11 265	tk 16922-16 87	tk 17059-04 271	tk 17411-11 36	tk 20012-24 282
tk 12253-26 152	tk 12850-13 265	tk 16930-15 89	tk 17059-06 271	tk 17411-13 36	tk 20012-26 282
tk 12268-12 258	tk 15100-25 266	tk 16933-17 89	tk 17059-08 271	tk 17419-15 36	tk 20012-30 282
tk 12269-01 258	tk 15100-27 266	tk 16935-17 184,	tk 17079-01 273	tk 17450-13 37	tk 20035-14 283
tk 12269-02 258	tk 15101-25 266	268	tk 17079-02 273	tk 17451-13 37	tk 20035-16 283
tk 12280-21 259	tk 15101-27 266	tk 16937-18 184,	tk 17080-16 272	tk 17452-11 37	tk 20036-12 281
tk 12280-27 259	tk 15102-25 266	268	tk 17081-16 272	tk 17453-11 37	tk 20036-14 281
tk 12281-21 259	tk 15103-25 266	tk 16939-18 184,	tk 17082-15 272	tk 17480-01 276	tk 20036-17 281
tk 12281-27 259	tk 15110-20 266	268	tk 17083-01 273	tk 17480-02 276	tk 20036-19 281
tk 12282-21 259	tk 15110-22 266	tk 16950-13 268	tk 17083-02 273	tk 17482-11 276	tk 20106-14 280
tk 12282-27 259	tk 15111-20 266	tk 16952-11 268	tk 17084-14 273	tk 17750-00 89	tk 20106-17 280
tk 12283-21 259	tk 15111-22 266	tk 16955-19 100	tk 17085-15 273	tk 17919-13 89	tk 20106-20 280
tk 12283-27 259	tk 15112-20 266	tk 16955-21 268	tk 17088-11 273	tk 19009-12 229	tk 20200-14 287
tk 12284-21 259	tk 15113-20 266	tk 16958-01 269	tk 17112-01 274	tk 19009-14 229	tk 20201-14 287
tk 12284-27 259	tk 15120-22 266	tk 16958-02 269	tk 17112-02 274	tk 19009-16 229	tk 20204-15 287
tk 12285-21 259	tk 15120-25 266	tk 16958-03 269	tk 17112-03 274	tk 19009-18 229	tk 20204-18 287
tk 12285-27 259	tk 15120-27 266	tk 16958-04 269	tk 17112-04 274	tk 19009-23 229	tk 20204-21 287
tk 12286-21 259	tk 15120-35 266	tk 16958-05 269	tk 17112-05 274	tk 19109-12 229	tk 20205-15 287
tk 12286-27 259	tk 15121-22 266	tk 17001-16 269	tk 17114-01 274	tk 19109-14 229	tk 20205-18 287
tk 12290-13 260	tk 15121-25 266	tk 17002-16 269	tk 17114-02 274	tk 19109-16 229	tk 20205-21 287
tk 12290-16 260	tk 15121-27 266	tk 17003-16 269	tk 17114-03 274	tk 19109-18 229	tk 20210-14 287
tk 12290-18 260	tk 15121-35 266	tk 17004-16 269	tk 17114-04 274	tk 19109-23 229	tk 20210-15 287
tk 12290-20 260	tk 15180-18 267	tk 17011-16 269	tk 17114-05 274	tk 19209-12 229	tk 20210-18 287
tk 12290-23 260	tk 15180-25 267	tk 17012-16 269	tk 17114-06 274	tk 19209-14 229	tk 20210-21 287
tk 12290-25 260	tk 15182-18 267	tk 17013-16 269	tk 17114-07 274	tk 19209-16 229	tk 20211-14 287
tk 12290-28 260	tk 15182-20 267	tk 17014-16 269	tk 17114-08 274	tk 19209-18 229	tk 20211-15 287
tk 12290-35 260	tk 15182-25 267	tk 17021-16 270	tk 17114-09 274	tk 19209-23 229	tk 20211-18 287
tk 12291-18 260	tk 15182-30 267	tk 17022-16 270	tk 17330-07 276	tk 19216-18 230	tk 20211-21 287
tk 12291-22 260	tk 15182-35 267	tk 17024-16 270	tk 17330-10 276	tk 19312-12 229	tk 20304-13 284
tk 12291-25 260	tk 15182-40 267	tk 17025-16 270	tk 17330-17 276	tk 19312-14 229	tk 20308-12 279
tk 12291-28 260	tk 15183-18 267	tk 17031-16 270	tk 17330-20 276	tk 19312-16 229	tk 20502-15 TC. 279
tk 12351-19 154	tk 15183-25 267	tk 17032-16 270	tk 17331-07 276	tk 19312-18 229	tk 20502-18 TC. 279
tk 12352-19 154	tk 15185-18 267	tk 17034-16 270	tk 17331-10 276	tk 19315-12 229	tk 20502-20 TC. 279
tk 12355-18 154	tk 15185-20 267	tk 17038-08 270	tk 17336-10 276	tk 19315-14 229	tk 20503-14 TC. 280
tk 12800-10 263	tk 15185-25 267	tk 17038-10 270	tk 17337-10 276	tk 19315-16 229	tk 20504-15 TC. 280
tk 12800-12 263	tk 16900-15 86	tk 17038-12 270	tk 17395-07 276	tk 19315-18 229	tk 20508-12 TC. 279
tk 12800-14 263	tk 16901-22 86	tk 17038-14 270	tk 17400-10 275	tk 19415-12 229	tk 20509-13 TC. 280
tk 12800-16 263	tk 16902-16 86	tk 17038-16 270	tk 17400-20 275	tk 19415-14 229	tk 20510-13 TC. 281
tk 12800-18 263	tk 16904-17 86	tk 17038-18 270	tk 17401-10 275	tk 19415-16 229	tk 20511-13 TC. 281
tk 12801-09 265	tk 16905-01 86	tk 17039-10 271	tk 17402-13 275	tk 19415-18 229	tk 20512-14 TC. 282

Nummernverzeichnis
Numerical Index
Index numériques
Indice numerico
Indice dei numeri d'articolo

tk 205 12-16 TC. 282	tk 20705-15 TC. 287	tk 24094-10 112	tk 24295-15 117	tk 25221-00 41	tk 25229-10 228
tk 205 12-18 TC. 282	tk 20705-18 TC. 287	tk 24094-12 112	tk 24295-18 117	tk 25221-01 41	tk 25229-11 228
tk 205 12-20 TC. 282	tk 20705-21 TC. 287	tk 24094-15 112	tk 24296-01 118	tk 25221-05 41	tk 25229-12 228
tk 205 12-24 TC. 282	tk 207 10-14 TC. 287	tk 24095-03 112	tk 24296-02 118	tk 25221-07 41	tk 25229-15 228
tk 205 12-26 TC. 282	tk 207 10-15 TC. 287	tk 24095-04 112	tk 24296-03 118	tk 25221-10 41	tk 25230-01 42
tk 205 12-30 TC. 282	tk 207 10-18 TC. 287	tk 24095-06 112	tk 24298-01 118	tk 25221-12 41	tk 25230-02 42
tk 205 15-16 TC. 284	tk 207 10-21 TC. 287	tk 24095-08 112	tk 24298-02 118	tk 25223-16 41	tk 25230-06 43, 228
tk 205 15-18 TC. 284	tk 207 11-14 TC. 287	tk 24095-10 112	tk 24298-03 118	tk 25224-01 168	tk 25230-07 43, 228
tk 205 15-20 TC. 284	tk 207 11-15 TC. 287	tk 24095-12 112	tk 24400-13 291	tk 25224-02 168	tk 25230-08 43, 228
tk 205 16-14 TC. 280	tk 207 11-18 TC. 287	tk 24095-15 112	tk 24400-14 291	tk 25224-03 168	tk 25230-09 43, 228
tk 205 16-17 TC. 280	tk 207 11-21 TC. 287	tk 24251-15 113	tk 24400-17 291	tk 25225-01 41	tk 25230-10 43, 228
tk 205 16-20 TC. 280	tk 2 12 10-20 157	tk 24252-16 113	tk 244 10-13 291	tk 25225-02 41	tk 25230-12 43, 228
tk 20522-18 TC. 285	tk 2 12 10-21 157	tk 24253-04 113	tk 244 10-16 291	tk 25225-03 41	tk 25230-15 43, 228
tk 20522-20 TC. 285	tk 2 12 10-27 157	tk 24253-06 113	tk 244 10-20 291	tk 25226-03 40	tk 25230-20 43
tk 20522-23 TC. 285	tk 2 12 12-20 157	tk 24253-08 113	tk 244 12-21 291	tk 25226-05 40	tk 25230-21 43
tk 20522-26 TC. 285	tk 2 12 12-21 157	tk 24254-03 113	tk 24520-15 293	tk 25226-07 40	tk 25230-22 43
tk 20524-18 TC. 284	tk 2 12 12-27 157	tk 24255-04 113	tk 24521-15 293	tk 25226-53 40	tk 25230-23 43
tk 20524-20 TC. 284	tk 2 12 14-20 157	tk 24255-06 113	tk 24523-05 293	tk 25226-55 40	tk 25234-01 42
tk 20524-26 TC. 284	tk 2 12 14-21 157	tk 24255-08 113	tk 24523-10 293	tk 25226-57 40	tk 25234-02 42
tk 20525-14 TC. 285	tk 2 12 14-27 157	tk 24261-16 114	tk 24523-15 293	tk 25227-01 42	tk 25234-03 42
tk 20525-18 TC. 285	tk 2 12 16-20 157	tk 24263-16 114	tk 24523-20 293	tk 25227-03 40	tk 25234-04 42
tk 20525-20 TC. 285	tk 2 12 16-21 157	tk 24270-07 114	tk 24523-25 293	tk 25227-05 40	tk 25235-04 228
tk 20525-23 TC. 285	tk 2 12 16-27 157	tk 24270-12 114	tk 24525-13 292	tk 25227-07 40	tk 25235-05 228
tk 20533-13 TC. 284	tk 2 12 17-22 156	tk 24272-19 114	tk 24525-16 292	tk 25227-08 40	tk 25243-01 41
tk 20535-14 TC. 283	tk 2 12 18-23 156	tk 24277-06 114	tk 24526-16 292	tk 25227-10 40	tk 25243-02 41
tk 20535-16 TC. 283	tk 2 12 19-23 156	tk 24278-04 114	tk 24528-01 292	tk 25227-12 40	tk 25243-03 41
tk 20536-12 TC. 281	tk 2 1220-01 156	tk 24278-05 114	tk 24528-02 292	tk 25227-14 40	tk 25244-01 41
tk 20536-14 TC. 281	tk 2 1220-02 156	tk 24278-06 114	tk 24532-16 292	tk 25227-20 42	tk 25244-02 41
tk 20536-17 TC. 281	tk 2 1221-01 156	tk 24278-07 114	tk 24533-17 292	tk 25227-21 42	tk 25244-03 41
tk 20536-19 TC. 281	tk 2 1221-02 156	tk 24278-08 114	tk 24535-01 293	tk 25227-22 42	tk 25602-01 303
tk 20540-13 TC. 286	tk 2 1226-22 155	tk 24279-10 115	tk 24535-02 293	tk 25227-23 42	tk 25602-02 303
tk 20540-15 TC. 286	tk 2 1227-22 155	tk 24279-12 115	tk 24535-03 293	tk 25227-24 42	tk 25602-03 303
tk 20540-18 TC. 286	tk 2 1232-21 155	tk 24279-14 115	tk 24535-04 293	tk 25227-25 42	tk 25602-04 303
tk 20540-20 TC. 286	tk 2 1233-21 155	tk 24279-16 115	tk 24605-12 299	tk 25227-26 42	tk 25603-01 303
tk 20540-23 TC. 286	tk 2 1375-23 289	tk 24280-04 115	tk 24605-14 299	tk 25227-27 42	tk 25603-02 303
tk 20540-26 TC. 286	tk 2 1380-21 289	tk 24280-07 115	tk 24606-01 299	tk 25227-28 42	tk 25603-03 303
tk 20541-13 286	tk 2 1385-23 289	tk 24280-09 115	tk 24606-02 299	tk 25227-29 42	tk 25603-04 303
tk 20541-15 286	tk 24047-21 290	tk 24280-12 115	tk 24606-03 299	tk 25227-53 40	tk 25610-01 303
tk 20541-18 286	tk 24050-17 290	tk 24281-04 115	tk 24613-00 300	tk 25227-55 40	tk 25610-02 303
tk 20541-20 286	tk 24050-90 290	tk 24281-07 115	tk 24613-02 300	tk 25227-57 40	tk 25610-03 303
tk 20541-23 286	tk 24051-20 290	tk 24281-09 115	tk 24614-18 300	tk 25227-58 40	tk 25610-04 303
tk 20542-13 TC. 286	tk 24053-18 111	tk 24281-12 115	tk 24614-20 300	tk 25227-60 40	tk 25611-01 303
tk 20542-15 TC. 286	tk 24055-16 111	tk 24283-06 116	tk 24615-18 301	tk 25227-62 40	tk 25611-02 303
tk 20542-18 TC. 286	tk 24056-19 111	tk 24284-16 116	tk 24616-04 301	tk 25227-64 40	tk 25611-03 303
tk 20542-20 TC. 286	tk 24057-01 111	tk 24286-16 116	tk 24616-05 301	tk 25228-01 42	tk 25611-04 303
tk 20542-23 TC. 286	tk 24057-02 111	tk 24287-04 117	tk 24649-19 302	tk 25228-02 42	tk 25635-11 305
tk 20542-26 TC. 286	tk 24086-04 112	tk 24287-07 117	tk 24654-15 302	tk 25228-03 42	tk 25636-11 305
tk 20546-12 TC. 283	tk 24086-06 112	tk 24287-09 117	tk 24655-15 302	tk 25228-04 42	tk 25637-11 305
tk 20547-12 TC. 283	tk 24086-08 112	tk 24287-12 117	tk 24660-18 302	tk 25228-05 42	tk 25638-11 305
tk 20548-12 TC. 283	tk 24086-10 112	tk 24290-10 116	tk 24661-18 302	tk 25228-06 40	tk 25640-15 305
tk 20549-12 TC. 283	tk 24086-12 112	tk 24290-12 116	tk 25220-01 43	tk 25228-07 40	tk 25641-15 305
tk 20570-13 286	tk 24087-04 112	tk 24290-14 116	tk 25220-02 43	tk 25228-08 40	tk 25642-15 305
tk 20570-15 286	tk 24087-06 112	tk 24292-03 117	tk 25220-03 43	tk 25228-09 40	tk 25643-15 305
tk 20570-17 286	tk 24087-08 112	tk 24292-04 117	tk 25220-04 43	tk 25228-10 40	tk 25645-13 305
tk 20570-18 286	tk 24087-10 112	tk 24295-02 117	tk 25220-05 43	tk 25228-12 40	tk 25646-13 305
tk 20570-20 286	tk 24087-12 112	tk 24295-04 117	tk 25220-06 43	tk 25228-15 40	tk 25652-13 305
tk 20570-23 286	tk 24094-03 112	tk 24295-06 117	tk 25220-07 43	tk 25229-06 228	tk 25653-13 305
tk 20704-15 TC. 287	tk 24094-04 112	tk 24295-08 117	tk 25220-08 43	tk 25229-07 228	tk 25654-12 305
tk 20704-18 TC. 287	tk 24094-06 112	tk 24295-10 117	tk 25220-09 44	tk 25229-08 228	tk 25655-12 305
tk 20704-21 TC. 287	tk 24094-08 112	tk 24295-12 117	tk 25220-10 44	tk 25229-09 228	tk 25656-12 305

**Nummernverzeichnis
Numerical Index**
**Index numériques
Indice numerico
Indice dei numeri d'articolo**

tk 25657-12 305	tk 25689-03 304	tk 28160-19 262	tk 39527-00 340	tk 49965-06 298	tk 50023-04 15
tk 25658-13 305	tk 25689-04 304	tk 28160-25 262	tk 39528-00 340	tk 49965-08 298	tk 50023-11 15
tk 25659-13 305	tk 25689-05 304	tk 28167-15 262	tk 39528-20 340	tk 49965-10 298	tk 50023-12 15
tk 25662-13 305	tk 25689-06 304	tk 28180-20 262	tk 39530-00 340	tk 49965-14 298	tk 50023-13 15
tk 25663-13 305	tk 25689-07 304	tk 28190-20 262	tk 39530-10 340	tk 49965-18 298	tk 50023-14 15
tk 25664-18 305	tk 25689-08 304	tk 28192-16 262	tk 39530-18 338	tk 49965-23 298	tk 50023-15 15
tk 25665-18 305	tk 25689-09 304	tk 28210-15 261	tk 39530-23 338	tk 49965-27 298	tk 50025-00 16
tk 25666-18 305	tk 25689-10 304	tk 28250-15 261	tk 39530-30 338	tk 49965-31 298	tk 50025-01 16
tk 25667-18 305	tk 25689-11 304	tk 28250-19 261	tk 39530-40 338	tk 49965-35 298	tk 50025-02 16
tk 25668-18 305	tk 25689-12 304	tk 28280-16 261	tk 39531-18 338	tk 49965-40 298	tk 50025-03 16
tk 25669-18 305	tk 25740-01 308	tk 28280-18 261	tk 39531-23 338	tk 49965-45 298	tk 50025-10 16
tk 25670-15 306	tk 25740-02 308	tk 28280-20 261	tk 39531-25 338	tk 49965-50 298	tk 50026-00 16
tk 25670-18 305	tk 25740-03 308	tk 28280-24 261	tk 39531-30 338	tk 49965-60 298	tk 50026-01 16
tk 25671-15 306	tk 25740-04 308	tk 28285-16 261	tk 39531-40 338	tk 49965-70 298	tk 50026-02 16
tk 25671-18 305	tk 25740-05 tucar	tk 28285-20 261	tk 39531-50 338		tk 50026-03 16
tk 25672-15 306 308	tk 29950-12 184	tk 39532-18 339	tk 50000-	tk 50026-04 16
tk 25673-15 306	tk 25740-06 tucar	tk 29950-14 184	tk 39532-23 339	tk 50010-03 13	tk 50026-07 16
tk 25675-15 306 308	tk 29952-12 184	tk 39532-30 339	tk 50010-04 13	tk 50026-07 16
tk 25677-18 306	tk 25740-07 tucar	tk 29952-14 184	tk 39533-18 339	tk 50010-11 13	tk 50026-10 16
tk 25678-15 306 308	tk 29960-00 185	tk 39533-23 339	tk 50010-12 13	tk 50027-00 13
tk 25679-15 306	tk 25740-08 tucar	tk 29960-01 185	tk 39533-30 339	tk 50010-13 13	tk 50029-00 .. 17, 92
tk 25686-01 304 308	tk 29960-02 185		tk 50010-14 13	tk 50029-01 .. 17, 92
tk 25686-02 304	tk 25740-09 tucar	tk 29960-03 185	tk 40000-	tk 50012-03 14	tk 50029-02 17
tk 25686-03 304 308	tk 29960-04 185	tk 40099-00 277	tk 50012-11 14	tk 50029-03 17
tk 25686-04 304	tk 25740-10 tucar	tk 29960-05 185	tk 40100-00 277	tk 50012-12 14	tk 50029-03 92
tk 25686-05 304 308	tk 29960-06 185	tk 40100-01 277	tk 50012-13 14	tk 50030-00 13
tk 25686-06 304	tk 25740-11 tucar	tk 29960-07 185	tk 40100-12 277	tk 50012-14 14	tk 50030-01 13
tk 25686-07 304 308	tk 29960-08 185	tk 40100-23 277	tk 50013-03 14	tk 50030-02 13
tk 25686-08 304	tk 25740-12 tucar	tk 29960-09 185	tk 40100-34 277	tk 50013-11 14	tk 50030-03 13
tk 25686-09 304 308	tk 29990-00 185	tk 40100-45 277	tk 50013-12 14	tk 50035-10 10
tk 25686-10 304	tk 25740-13 308	tk 29990-01 185	tk 40100-56 277	tk 50013-13 14	tk 50036-11 10
tk 25686-11 304	tk 25740-14 308	tk 29990-02 185	tk 40100-67 277	tk 50013-14 14	tk 50040-07 10
tk 25686-12 304	tk 25740-15 308	tk 29990-03 185	tk 40100-78 277	tk 50015-00 14	tk 50042-08 10
tk 25687-01 304	tk 25740-16 308	tk 29990-04 185	tk 40101-00 277	tk 50015-01 14	tk 50044-09 11
tk 25687-02 304	tk 26016-01 307	tk 29990-05 185	tk 40102-00 277	tk 50015-02 14	tk 50045-10 11
tk 25687-03 304	tk 26016-02 307	tk 29990-06 185	tk 40102-01 277	tk 50015-03 14	tk 50047-11 11
tk 25687-04 304	tk 28001-01 136	tk 29990-07 185	tk 40102-12 277	tk 50015-04 14	tk 50050-00 9
tk 25687-05 304	tk 28001-02 136	tk 29990-08 185	tk 40102-23 277	tk 50015-05 14	tk 50050-10 9
tk 25687-06 304	tk 28001-03 136	tk 29990-09 185	tk 40102-34 277	tk 50015-06 14	tk 50052-11 9
tk 25687-07 304	tk 28002-01 136	tk 29997-00 186	tk 40102-45 277	tk 50018-03 14	tk 50053-10 9
tk 25687-08 304	tk 28002-02 136		tk 40102-56 277	tk 50018-04 14	tk 50054-12 9
tk 25687-09 304	tk 28002-03 136	tk 30000-	tk 40102-67 277	tk 50018-11 14	tk 50056-13 9
tk 25687-10 304	tk 28005-01 136	tk 39520-18 338	tk 40102-78 277	tk 50018-12 14	tk 50058-14 9
tk 25687-11 304	tk 28005-02 136	tk 39520-23 338	tk 48128-15 86	tk 50018-13 14	tk 50078-09 11
tk 25687-12 304	tk 28005-03 136	tk 39520-30 338	tk 48130-01 87	tk 50018-14 14	tk 50250-00 12
tk 25688-01 304	tk 28006-01 136	tk 39520-40 338	tk 48130-02 87	tk 50019-04 15	tk 50250-01 12
tk 25688-02 304	tk 28006-02 136	tk 39521-18 338	tk 49900-15 187	tk 50019-11 15	tk 50250-02 12
tk 25688-03 176	tk 28006-03 136	tk 39521-23 338	tk 49900-15 224	tk 50019-12 15	tk 50250-03 12
tk 25688-03 304	tk 28010-01 136	tk 39521-25 338	tk 49900-20 187	tk 50019-13 15	tk 50250-04 12
tk 25688-04 304	tk 28010-02 136	tk 39521-30 338	tk 49900-20 224	tk 50019-14 15	tk 50250-05 12
tk 25688-05 304	tk 28010-03 136	tk 39521-40 338	tk 49905-17 187	tk 50020-03 15	tk 50300-00 11
tk 25688-06 304	tk 28011-01 136	tk 39521-50 338	tk 49905-17 224	tk 50020-10 15	tk 50311-16 32
tk 25688-07 304	tk 28011-02 136	tk 39522-18 339	tk 49925-15 187	tk 50020-11 15	tk 50313-16 32
tk 25688-08 304	tk 28011-03 136	tk 39522-23 339	tk 49925-15 224	tk 50020-12 15	tk 50315-17 32
tk 25688-09 304	tk 28090-01 136	tk 39522-30 339	tk 49925-16 187	tk 50022-03 15	tk 50319-30 32, 147
tk 25688-10 304	tk 28090-02 136	tk 39523-18 339	tk 49925-16 224	tk 50022-04 15	tk 50319-40 32, 147
tk 25688-11 304	tk 28090-03 136	tk 39523-23 339	tk 49927-15 187	tk 50022-11 15	tk 50320-20 32
tk 25688-12 304	tk 28100-14 262	tk 39523-30 339	tk 49927-15 224	tk 50022-12 15	tk 50320-30 32
tk 25689-01 304	tk 28140-15 262	tk 39525-00 340	tk 49927-16 187	tk 50022-13 15	tk 50320-30 91
tk 25689-02 304	tk 28160-15 262	tk 39525-10 340	tk 49927-16 224	tk 50022-14 15	tk 50323-26 91

Nummernverzeichnis
Numerical Index
Index numériques
Indice numerico
Indice dei numeri d'articolo

tk 50325-26 91	tk 50461-08 46	tk 50547-01 57	tk 50579-01 62	tk 50661-05 26	tk 50930-04 20
tk 50328-24 91	tk 50461-14 46	tk 50548-01 57	tk 50579-02 62	tk 50661-06 26	tk 50930-15 20
tk 50336-28 147	tk 50463-09 46	tk 50549-01 57	tk 50579-03 62	tk 50661-07 26	tk 50930-17 20
tk 50338-28 147	tk 50465-09 72	tk 50550-01 54	tk 50579-04 62	tk 50665-01 25	tk 50930-22 20
tk 50340-28 147	tk 50467-08 46	tk 50550-02 54	tk 50579-05 62	tk 50665-02 25	tk 50930-50 20
tk 50342-28 147	tk 50469-01 46	tk 50550-03 54	tk 50580-10 62	tk 50690-13 25	tk 51065-20 71
tk 50345-40 147	tk 50469-02 46	tk 50550-04 54	tk 50581-00 62	tk 50705-17 25	tk 51066-20 71
tk 50345-50 147	tk 50469-03 46	tk 50550-06 54	tk 50581-19 62	tk 50710-15 30	tk 51067-16 71
tk 50347-02 148	tk 50472-08 46	tk 50552-01 54	tk 50590-00 59	tk 50712-16 .. 30, 85	tk 51068-14 72
tk 50351-01 148	tk 50472-45 46	tk 50552-03 54	tk 50610-01 27	tk 50714-16 .. 30, 85	tk 51069-18 73
tk 50403-12 24	tk 50472-90 46	tk 50552-04 54	tk 50610-02 27	tk 50753-16 30	tk 51071-20 71
tk 50405-12 24	tk 50491-02 34	tk 50552-05 54	tk 50610-10 27	tk 50755-16 30	tk 51079-18 73
tk 50407-14 24	tk 50491-02 135	tk 50552-07 54	tk 50610-11 27	tk 50757-16 30	tk 51095-01 73
tk 50417-11 24	tk 50491-03 34	tk 50553-01 57	tk 50610-12 27	tk 50761-18 30	tk 51095-02 73
tk 50419-10 24	tk 50491-03 135	tk 50553-02 57	tk 50610-13 27	tk 50763-18 30	tk 51095-03 73
tk 50420-01 48	tk 50493-19 33	tk 50553-04 57	tk 50610-14 27	tk 50765-19 30	tk 51099-18 73
tk 50420-02 48	tk 50494-14 33	tk 50558-03 58	tk 50610-15 27	tk 50770-16 106	tk 51116-18 73
tk 50420-03 48	tk 50530-00 53	tk 50558-06 58	tk 50611-01 27	tk 50781-00 31	tk 51120-01 75
tk 50420-04 48	tk 50531-00 53	tk 50558-10 58	tk 50611-02 27	tk 50783-00 31	tk 51120-01 75, 104
tk 50420-05 48	tk 50532-00 53	tk 50559-03 58	tk 50611-10 27	tk 50784-02 31	tk 51120-02 75, 104
tk 50420-06 48	tk 50533-00 53	tk 50559-06 58	tk 50611-11 27	tk 50787-20 106	tk 51121-01 75, 104
tk 50421-01 48	tk 50534-00 53	tk 50559-10 58	tk 50611-12 27	tk 50789-17 106	tk 51121-02 75, 104
tk 50421-02 48	tk 50535-00 53	tk 50560-05 58	tk 50611-13 27	tk 50810-01 68	tk 51123-01 76
tk 50421-03 48	tk 50536-00 53	tk 50560-10 58	tk 50611-14 27	tk 50810-02 68	tk 51123-02 76
tk 50421-04 48	tk 50537-00 53	tk 50561-05 58	tk 50611-15 27	tk 50810-03 68	tk 51123-03 76
tk 50421-05 48	tk 50538-00 54	tk 50561-10 58	tk 50614-01 28	tk 50811-14 65	tk 51123-04 76
tk 50421-06 48	tk 50539-01 54	tk 50562-01 58	tk 50614-02 28	tk 50813-01 64	tk 51124-01 104
tk 50424-01 50	tk 50539-02 54	tk 50562-04 58	tk 50614-10 28	tk 50813-02 64	tk 51124-02 104
tk 50424-02 50	tk 50539-03 54	tk 50563-03 58	tk 50614-11 28	tk 50813-03 64	tk 51124-03 104
tk 50424-03 50	tk 50540-01 55	tk 50563-06 58	tk 50614-12 28	tk 50822-13 64	tk 51131-12 75
tk 50424-04 50	tk 50540-02 55	tk 50563-10 58	tk 50614-13 28	tk 50823-13 64	tk 51133-12 75
tk 50424-10 49	tk 50540-03 55	tk 50564-03 58	tk 50614-14 28	tk 50828-01 65	tk 51141-10 76
tk 50424-11 49	tk 50540-04 55	tk 50564-06 58	tk 50614-15 28	tk 50828-02 65	tk 51143-12 76
tk 50424-12 49	tk 50540-05 55	tk 50564-10 58	tk 50615-01 28	tk 50828-03 65	tk 51147-12 76
tk 50424-13 49	tk 50540-06 55	tk 50565-03 58	tk 50615-02 28	tk 50828-04 65	tk 51155-01 82
tk 50424-14 49	tk 50540-07 55	tk 50565-06 58	tk 50615-10 28	tk 50830-01 66	tk 51155-02 82
tk 50425-01 50	tk 50540-08 55	tk 50565-10 58	tk 50615-11 28	tk 50830-02 66	tk 51155-03 82
tk 50425-02 50	tk 50540-09 55	tk 50566-03 58	tk 50615-12 28	tk 50830-03 66	tk 51155-04 82
tk 50425-03 50	tk 50541-01 56	tk 50566-06 58	tk 50615-13 28	tk 50834-01 66	tk 51155-05 82
tk 50425-04 50	tk 50541-02 56	tk 50566-10 58	tk 50615-14 28	tk 50834-02 66	tk 51156-01 83
tk 50426-02 51	tk 50541-03 56	tk 50567-01 54	tk 50615-15 28	tk 50834-03 66	tk 51156-02 83
tk 50426-05 51	tk 50541-04 56	tk 50568-01 59	tk 50620-13 29	tk 50836-35 67	tk 51156-03 83
tk 50426-06 51	tk 50541-05 56	tk 50568-02 59	tk 50621-01 105	tk 50836-50 67	tk 51156-04 83
tk 50426-07 51	tk 50541-06 56	tk 50569-01 59	tk 50621-04 105	tk 50836-75 67	tk 51156-05 83
tk 50426-08 51	tk 50541-07 56	tk 50569-02 59	tk 50621-05 105	tk 50836-90 67	tk 51156-06 83
tk 50427-01 52	tk 50541-08 56	tk 50571-01 53	tk 50621-22 105	tk 50837-35 92	tk 51156-21 83
tk 50427-02 52	tk 50541-09 56	tk 50571-02 53	tk 50622-17 29	tk 50837-50 92	tk 51156-22 83
tk 50427-03 52	tk 50543-01 57	tk 50571-03 53	tk 50623-12 29	tk 50837-75 92	tk 51156-23 83
tk 50427-04 52	tk 50543-02 57	tk 50571-04 53	tk 50624-12 29	tk 50837-90 92	tk 51156-24 83
tk 50430-00 47	tk 50543-03 57	tk 50572-01 60	tk 50628-16 29	tk 50840-45 67	tk 51156-25 83
tk 50432-01 47	tk 50544-04 57	tk 50572-02 60	tk 50634-01 26	tk 50840-75 67	tk 51156-26 83
tk 50432-02 47	tk 50544-06 57	tk 50573-01 60	tk 50634-02 26	tk 50870-00 93	tk 51158-01 82
tk 50433-01 47	tk 50544-08 57	tk 50573-02 60	tk 50634-03 26	tk 50920-00 21	tk 51158-02 82
tk 50433-02 47	tk 50544-10 57	tk 50574-01 61	tk 50644-01 26	tk 50920-01 21	tk 51158-03 82
tk 50434-01 47	tk 50545-04 57	tk 50574-02 61	tk 50644-02 26	tk 50920-08 21	tk 51158-04 82
tk 50455-08 46	tk 50545-06 57	tk 50575-01 61	tk 50644-03 26	tk 50920-11 21	tk 51159-01 82
tk 50457-08 46	tk 50545-08 57	tk 50575-02 61	tk 50661-01 26	tk 50920-13 21	tk 51159-02 82
tk 50459-08 46	tk 50545-10 57	tk 50577-01 54	tk 50661-02 26	tk 50920-50 21	tk 51159-03 82
tk 50459-14 46	tk 50546-10 57	tk 50578-01 31	tk 50661-03 26	tk 50924-00 93	tk 51160-01 82
tk 50459-16 46	tk 50546-25 57	tk 50578-02 31	tk 50661-04 26	tk 50930-00 20	tk 51160-02 82

Nummernverzeichnis
Numerical Index
Index numériques
Indice numerico
Indice dei numeri d'articolo

tk 51160-03 82	tk 51342-12 85	294	tk 51697-23 101	tk 52149-19 217	tk 52672-05 170
tk 51160-04 82	tk 51344-15 85	tk 51617-16 106,	tk 51700-01 71, 129	tk 52228-00 223	tk 52672-06 170
tk 51160-05 82	tk 51346-15 85	294	tk 51700-02 71, 129	tk 52240-00 219	tk 52672-07 172
tk 51161-01 82	tk 51350-01 85	tk 51619-04 107	tk 51700-03 71, 129	tk 52240-01 219	tk 52672-08 172
tk 51161-02 82	tk 51350-02 85	tk 51619-05 107	tk 51710-03 132	tk 52240-02 219	tk 52672-09 172
tk 51161-03 82	tk 51355-01 85	tk 51620-23 107	tk 51710-04 132	tk 52240-03 219	tk 52672-10 172
tk 51161-04 82	tk 51361-01 143	tk 51621-22 107	tk 51711-03 132	tk 52250-00 220	tk 52672-11 172
tk 51162-01 82	tk 51361-02 143	tk 51622-18 108	tk 51711-04 132	tk 52250-01 220	tk 52672-12 172
tk 51162-02 82	tk 51364-21 105	tk 51623-22 108	tk 51712-03 132	tk 52250-02 220	tk 52673-01 170
tk 51162-03 82	tk 51366-00 105	tk 51625-19 108,	tk 51720-03 130	tk 52250-03 220	tk 52673-02 170
tk 51165-01 82	tk 51366-01 105	295	tk 51722-03 130	tk 52250-10 220	tk 52673-03 170
tk 51165-02 82	tk 51366-02 105	tk 51627-18 108,	tk 51723-03 130	tk 52260-00 221	tk 52673-04 170
tk 51165-03 82	tk 51366-03 105	295	tk 51724-03 130	tk 52260-01 221	tk 52673-05 170
tk 51165-04 82	tk 51366-04 105	tk 51629-21 109	tk 51725-04 131	tk 52260-02 221	tk 52673-06 170
tk 51171-11 77, 129	tk 51366-05 105	tk 51631-20 109,	tk 51726-03 130	tk 52260-03 221	tk 52673-07 170
tk 51171-12 77, 129	tk 51366-06 105	128	tk 51726-04 131	tk 52260-10 221	tk 52674-01 170
tk 51171-13 77, 129	tk 51368-12 105	tk 51634-22 109	tk 51727-03 130	tk 52270-00 222	tk 52674-02 170
tk 51173-12 77, 129	tk 51405-01 144	tk 51636-21 110,	tk 51728-04 131	tk 52270-01 222	tk 52674-04 170
tk 51174-01 77, 129	tk 51405-02 144	128	tk 51729-00 78	tk 52270-02 222	tk 52674-05 170
tk 51174-02 77, 129	tk 51405-03 144	tk 51637-19 110,	tk 51729-01 78	tk 52270-03 222	tk 52674-06 170
tk 51175-01 133	tk 51405-04 144	294	tk 51729-02 78	tk 52270-04 222	tk 52674-07 170
tk 51175-02 133	tk 51410-03 90	tk 51637-22 110,	tk 51729-03 78	tk 52270-05 222	tk 52675-01 171
tk 51175-03 133	tk 51410-04 90	294	tk 51729-04 78	tk 52270-10 222	tk 52675-02 171
tk 51175-05 133	tk 51410-05 90	tk 51642-20 128	tk 51729-05 78	tk 52280-00 223	tk 52675-03 171
tk 51176-01 77, 129	tk 51411-03 90	tk 51643-22 110,	tk 51729-06 78	tk 52280-01 223	tk 52675-04 171
tk 51179-04 103	tk 51411-04 90	128	tk 51730-03 130	tk 52280-02 223	tk 52675-05 171
tk 51179-06 103	tk 51411-05 90	tk 51644-21 110,	tk 51730-04 131	tk 52280-03 223	tk 52675-06 171
tk 51179-08 103	tk 51412-01 145	127	tk 51731-03 130	tk 52280-10 223	tk 52675-07 171
tk 51180-19 102	tk 51412-02 145	tk 51645-20 127,	tk 51731-04 131	tk 52300-00 216	tk 52675-08 171
tk 51182-19 102	tk 51412-03 145	228	tk 51732-03 130	tk 52594-22 138	tk 52675-09 171
tk 51184-20 103	tk 51412-04 145	tk 51646-02 295	tk 51733-04 131	tk 52598-24 179	tk 52675-10 171
tk 51188-01 103	tk 51412-05 145	tk 51647-01 100	tk 51734-03 130	tk 52601-23 142	tk 52675-11 171
tk 51188-21 103	tk 51412-06 145	tk 51647-02 100	tk 51735-00 79	tk 52603-23 142	tk 52675-12 171
tk 51194-13 134	tk 51413-01 145	tk 51648-00 100	tk 51735-01 79	tk 52605-22 142	tk 52675-13 171
tk 51195-13 134	tk 51413-02 145	tk 51655-20 96	tk 51735-02 79	tk 52607-25 141	tk 52675-14 171
tk 51196-12 134	tk 51413-03 145	tk 51657-20 96	tk 51736-00 80	tk 52610-19 141	tk 52675-90 171
tk 51197-12 134	tk 51413-04 145	tk 51661-01 96	tk 51737-00 81	tk 52612-20 139	tk 52676-01 172
tk 51198-04 134	tk 51413-05 145	tk 51661-02 96	tk 51737-01 81	tk 52616-18 218	tk 52676-02 172
tk 51245-20 135	tk 51413-06 145	tk 51661-03 96	tk 51737-02 81	tk 52616-20 218	tk 52676-03 172
tk 51251-00 34	tk 51415-01 144	tk 51663-18 98	tk 51737-03 81	tk 52616-22 218	tk 52676-04 172
tk 51251-01 34, 135	tk 51415-02 144	tk 51665-21 97	tk 51740-03 130	tk 52620-23 218	tk 52676-05 172
tk 51251-02 34, 135	tk 51415-03 144	tk 51669-21 97	tk 51750-13 288	tk 52622-22 139	tk 52676-06 172
tk 51251-03 34, 135	tk 51415-04 144	tk 51670-01 97	tk 51751-00 169	tk 52627-20 139	tk 52676-07 172
tk 51264-01 102	tk 51416-00 140	tk 51670-02 97	tk 52004-01 218	tk 52640-18 138	tk 52676-08 172
tk 51264-02 102	tk 51511-01 146	tk 51671-21 97	tk 52004-02 218	tk 52641-18 138	tk 52676-09 172
tk 51264-03 102	tk 51511-02 146	tk 51672-21 97	tk 52004-03 218	tk 52659-18 138	tk 52677-01 172
tk 51300-16 84	tk 51511-03 146	tk 51675-18 98	tk 52031-11 216	tk 52659-23 138	tk 52677-02 172
tk 51302-01 84	tk 51513-01 146	tk 51677-18 98	tk 52031-13 216	tk 52664-20 138	tk 52677-04 172
tk 51302-02 84	tk 51513-02 146	tk 51683-01 98	tk 52031-15 216	tk 52665-13 140	tk 52677-05 172
tk 51303-01 84	tk 51513-03 146	tk 51683-02 98	tk 52041-09 216	tk 52665-15 140	tk 52677-06 172
tk 51303-02 84	tk 51521-01 146	tk 51683-03 98	tk 52041-11 216	tk 52665-17 140	tk 52677-07 172
tk 51306-15 84	tk 51521-02 146	tk 51685-21 98	tk 52041-13 216	tk 52671-00 149	tk 52678-01 173
tk 51308-15 84	tk 51521-03 146	tk 51686-01 TC... 99	tk 52041-15 216	tk 52671-01 149	tk 52678-02 173
tk 51310-00 84	tk 51522-01 146	tk 51686-03 TC... 99	tk 52110-13 216	tk 52671-02 149	tk 52678-03 173
tk 51310-01 84	tk 51522-02 146	tk 51686-05 TC... 99	tk 52131-11 217	tk 52671-03 149	tk 52678-04 173
tk 51315-23 143	tk 51522-03 146	tk 51686-07 TC... 99	tk 52131-13 142	tk 52671-10 149	tk 52678-05 173
tk 51317-22 143	tk 51607-19 106,	tk 51686-09 TC... 99	tk 52131-14 217	tk 52672-01 170	tk 52678-06 173
tk 51323-23 143	294	tk 51695-01 74, 101	tk 52141-12 217	tk 52672-02 170	tk 52678-07 173
tk 51330-11 143	tk 51610-20 106	tk 51695-02 74, 101	tk 52142-14 217	tk 52672-03 170	tk 52678-08 173
tk 51335-03 84	tk 51613-16 106,	tk 51695-03 74, 101	tk 52149-16 217	tk 52672-04 170	tk 52678-09 173

Nummernverzeichnis
Numerical Index

Index numériques

Indice numerico

Indice dei numeri d'articolo

tk 52678-10 173	tk 52684-12 196	tk 52810-27 296	tk 53364-60 193	tk 53541-10 178	tk 83110-20 311
tk 52678-11 173	tk 52684-13 196	tk 52810-30 296	tk 53365-30 193	tk 53541-12 178	tk 83142-08 310
tk 52678-12 173	tk 52685-01 175	tk 52810-35 296	tk 53365-40 193	tk 53541-14 178	tk 83142-11 310
tk 52678-13 173	tk 52685-02 175	tk 52810-40 296	tk 53365-50 193	tk 53541-16 178	tk 83142-12 310
tk 52678-14 173	tk 52685-03 175	tk 52810-45 296	tk 53365-60 193	tk 53541-18 178	tk 83142-16 310
tk 52678-15 173	tk 52685-04 175	tk 52810-50 296	tk 53366-30 193	tk 53550-20 179	tk 83143-14 310
tk 52678-90 173	tk 52685-05 175	tk 52810-60 296	tk 53366-40 193	tk 53561-18 180	tk 83143-17 310
tk 52679-00 169, 288	tk 52685-06 175	tk 52810-70 296	tk 53366-50 193	tk 53575-01 180	tk 83143-20 310
tk 52680-01 194	tk 52685-07 175	tk 52812-15 296	tk 53366-60 193	tk 53575-02 180	tk 83153-09 310
tk 52680-02 194	tk 52685-08 175	tk 52812-18 296	tk 53367-30 193	tk 53575-03 180	tk 83153-10 310
tk 52680-03 194	tk 52685-09 175	tk 52812-23 296	tk 53367-40 193	tk 53575-04 180	tk 83153-12 310
tk 52680-04 194	tk 52685-10 175	tk 52812-27 296	tk 53367-50 193	tk 53580-01 181	tk 83153-15 310
tk 52680-05 194	tk 52685-90 175	tk 52812-30 296	tk 53367-60 193	tk 53580-02 181	tk 83155-50 310
tk 52680-06 194	tk 52686-01 195	tk 52812-35 296	tk 53375-01 191	tk 53580-03 181	tk 83160-90 310
tk 52680-07 194	tk 52686-02 195	tk 52812-40 296	tk 53390-20 191	tk 53580-04 181	tk 83165-17 311
tk 52680-08 194	tk 52686-03 195	tk 52812-45 296	tk 53391-20 191	tk 53584-00 167	tk 83165-20 311
tk 52680-09 194	tk 52686-04 195	tk 52812-50 296	tk 53391-30 191	tk 53584-01 166	tk 83165-25 311
tk 52680-10 194	tk 52686-05 196	tk 52812-60 296	tk 53391-40 191	tk 53584-02 166	tk 83165-27 311
tk 52680-11 194	tk 52686-06 196	tk 52812-70 296	tk 53391-50 191	tk 53584-03 166	tk 85100-01 309
tk 52681-01 174	tk 52686-07 196	tk 52814-06 297	tk 53391-60 191	tk 53584-04 166	tk 85100-03 309
tk 52681-02 174	tk 52686-08 196	tk 52814-07 297	tk 53410-01 192	tk 53584-05 166	tk 85101-01 309
tk 52681-03 174	tk 52686-09 196	tk 52814-08 297	tk 53410-02 192	tk 53584-06 166	tk 85101-03 309
tk 52681-04 174	tk 52686-10 196	tk 52814-10 297	tk 53410-03 192	tk 53585-01 166	tk 85102-01 309
tk 52681-05 174	tk 52686-11 196	tk 52814-14 297	tk 53410-04 192	tk 53585-02 166	tk 85102-03 309
tk 52681-06 174	tk 52686-12 196	tk 52814-18 297	tk 53410-05 192	tk 53585-03 166	tk 85103-01 309
tk 52682-01 195	tk 52686-13 196	tk 52814-23 297	tk 53410-06 192	tk 53585-04 166	tk 85103-03 309
tk 52682-02 195	tk 52687-01 176	tk 52814-27 297	tk 53410-07 192	tk 53585-05 166	tk 85104-01 309
tk 52682-03 195	tk 52687-02 176	tk 52814-31 297	tk 53410-08 192	tk 53585-06 166	tk 85104-03 309
tk 52682-04 195	tk 52687-03 176	tk 52814-35 297	tk 53410-09 192	tk 53585-07 166	tk 87280-2F-BK.. 341
tk 52682-05 196	tk 52687-04 176	tk 52814-40 297	tk 53410-10 192	tk 53585-17 181	tk 87280-2F-BL.. 341
tk 52682-06 196	tk 52687-05 176	tk 52814-45 297	tk 53410-11 192	tk 56000-01 352	tk 87280-2F-GR.. 341
tk 52682-07 196	tk 52687-06 176	tk 52814-50 297	tk 53410-12 192	tk 56000-02 350	tk 87280-2F-RE.. 341
tk 52682-08 196	tk 52688-01 176	tk 52814-60 297	tk 53410-13 192	tk 56000-04 355	tk 87280-2F-SI.. 341
tk 52682-09 196	tk 52688-02 176	tk 52814-70 297	tk 53410-14 192	tk 56000-05 359	tk 87280-2F-YE.. 341
tk 52682-10 196	tk 52688-04 176	tk 52816-14 297	tk 53410-16 192	tk 56765-00 36	tk 87290-2F-BK.. 341
tk 52682-11 196	tk 52688-05 176	tk 52816-18 297	tk 53504-10 178	tk 56765-01 36	tk 87290-2F-BL.. 341
tk 52682-12 196	tk 52688-06 176	tk 52816-23 297	tk 53515-08 178	tk 56766-00 38	tk 87290-2F-GR.. 341
tk 52682-13 196	tk 52688-07 176	tk 52816-27 297	tk 53515-10 178	tk 56766-01 38	tk 87290-2F-RE.. 341
tk 52683-01 174	tk 52688-08 176	tk 52816-31 297	tk 53515-12 178	tk 56766-02 38	tk 87290-2F-SI.. 341
tk 52683-02 174	tk 52688-09 176	tk 52816-35 297	tk 53515-14 178	tk 56766-03 38	tk 87290-2F-YE.. 341
tk 52683-03 174	tk 52688-10 176	tk 52816-40 297	tk 53515-16 178	tk 56766-04 38	
tk 52683-04 174	tk 52688-11 176	tk 52816-45 297	tk 53515-18 178	tk 56766-05 38	
tk 52683-05 174	tk 52689-01 177	tk 52816-50 297	tk 53515-20 178	tk 56775-13 38	tk 90000-
tk 52683-06 174	tk 52689-02 177	tk 52816-60 297	tk 53515-22 178	tk 56795-00 298	tk 90004-00 347
tk 52683-07 174	tk 52689-03 177	tk 52816-70 297	tk 53515-24 178		tk 90004-01 347
tk 52683-08 174	tk 52689-04 177	tk 53361-30 193	tk 53515-26 178	tk 80000-	tk 90004-50 347
tk 52683-09 174	tk 52689-05 177	tk 53361-40 193	tk 53515-28 178	tk 83105-15 311	tk 90005-00 346
tk 52683-10 174	tk 52689-06 177	tk 53361-50 193	tk 53515-30 178	tk 83105-17 311	tk 90005-01 346
tk 52684-01 195	tk 52689-07 177	tk 53361-60 193	tk 53525-08 178	tk 83105-18 311	tk 90005-50 346
tk 52684-02 195	tk 52689-08 177	tk 53362-30 193	tk 53525-10 178	tk 83105-26 311	
tk 52684-03 195	tk 52689-09 177	tk 53362-40 193	tk 53525-12 178	tk 83105-28 311	
tk 52684-04 195	tk 52689-10 177	tk 53362-50 193	tk 53525-14 178	tk 83105-30 311	
tk 52684-05 196	tk 52810-06 296	tk 53362-60 193	tk 53525-16 178	tk 83105-32 311	
tk 52684-06 196	tk 52810-07 296	tk 53363-30 193	tk 53525-18 178	tk 83105-36 311	
tk 52684-07 196	tk 52810-08 296	tk 53363-40 193	tk 53525-20 178	tk 83105-39 311	
tk 52684-08 196	tk 52810-10 296	tk 53363-50 193	tk 53525-22 178	tk 83110-02 311	
tk 52684-09 196	tk 52810-15 296	tk 53363-60 193	tk 53525-24 178	tk 83110-05 311	
tk 52684-10 196	tk 52810-18 296	tk 53364-30 193	tk 53525-26 178	tk 83110-09 311	
tk 52684-11 196	tk 52810-23 296	tk 53364-40 193	tk 53525-28 178	tk 83110-13 311	
		tk 53364-50 193	tk 53525-30 178	tk 83110-15 311	

Inhaltsverzeichnis
Index

Table des matières
Indice
Indice

Inhaltsverzeichnis
Index

Table des matières
Indice
Indice

Deutsch

A

ABRAHAM Tonsillennmesser 143
 Adapter für Lichtleitkabel 340
 ADLERKEUTZ chirurgische Pinzetten 248
 ADSON Pinzetten 245, 247
 ADSON Raspatorien 293
 ADSON Saugrohre 228
 ADSON-BROWN Pinzetten 247
 ADSON-GRAEFE Pinzetten 247
 ADSON-Micro Pinzetten 247
 Akkumulatoren und Batteriecontainer 215
 ALLIS Gewebefasszangen 262
 ALLIS-ADAIR Gewebefasszange 262
 ALLIS-Baby Gewebefasszange 262
 ALM Wundsperrerr 276
 Anatomische Pinzetten 245-250
 ANDREW Zungendrucker 207
 Antrumküretten 105
 Antrumstanzen 133
 Arterienklemmen 151-153, 254-258
 ASCH Septumzange 101
 Atraumatische Pinzetten 251, 252
 AUFRIECHT Nasenhaken 89, 92
 AUFRIECHT Nasenraspeln 97

B

BABCOCK Gewebefasszangen 261
 Baby CRILE-WOOD Nadelhalter 280
 BACKHAUS Tuchklemmen 263
 BAINBRIDGE Arterienklemmen 151
 BALLENGER Knochenmeißel 113
 BALLENGER Ringmesser 90
 BALLENGER-HAJEK Elevatorien 110, 294
 BARANY Lärmtrummel 11
 BARBARA Mikro-Ohrnadeln 57, 58
 BARNHILL Ringmesser 144
 BARON Saugrohre 40
 BARRAQUER Nadelhalter 287
 BECKMANN Nasenspekula 66
 BECKMANN Ringmesser 145
 BELUCCI Mikro-Ohrscheren 51
 BELUCCI Wundsperrerr 36
 BERNHARD Tuchklemmen 263
 BEYER Hohlmeißelzange 301
 BEYER Ohr-Knochenstanzen 33
 BILLEAU Ohrschlingen 26
 BINNER Kaltlicht-Stirnlampe 203
 Binokularlupe 205
 BIRKET Arterienklemmen 151
 BLOHMKE Tonsillenzange 139
 BLUMENTHAL Hohlmeißelzangen 299
 BÖHLER Hohlmeißelzangen 300
 BÖHLER Knochensplitterzangen 302
 Bohrer 296-298
 BOSE Wundsperrerr 276
 BOSWORTH Zungendrucker 207
 BÖTTCHER Tonsillenschere 150, 244
 BOUCHERON Ohrspekula 15
 BOWMAN Tränenkanal-Dilatatoren 277
 BOYS-ALLIS Gewebefasszange 261

BOZEMAN Schlingendreher 289
 Broncho-Oesophagoskopiezangen 191-193
 Bronchoskope 190, 323
 BROPHY Chirurgische Pinzetten 248, 250
 BRUENINGS Broncho-Oesophagoskopiezangen 191, 192
 BRUENINGS Nasennmesser 84
 BRUENINGS Ohrspekula 16
 BRUENINGS scharfe Nasenzangen 76
 BRUENINGS Tonsillennmesser 143
 BRUENINGS Tonsillenschnürer 147
 BRUENINGS Zungendrucker 206
 BRUENINGS-BRUNK Kieferhöhlenhaken 100
 BUCK Fremdkörperzange 24
 BUCK Nasennmesser 85
 BUCK Ohrküretten 27, 28
 BUCK Parazentesenadel 30

C

CAIRNS Arterienklemmen 258
 CAPLAN Septumzange 103
 CARPENTER Eukleator 141
 CASTROVIEJO-JACOBSON Nadelhalter 287
 CHADWICK Eukleationsscheren 243
 CHEVALIER-JACKSON Broncho-Oesophagoskopiezangen 193
 CHEVALIER-JACKSON Trachealkanülen 185
 Chirurgische Pinzetten 245, 247, 248
 Chirurgische Scheren - Präparierscheren 237-241
 CHRISTOPHE Arterienklemmen 256
 CINELLI Osteotome 115
 CITELLI Keilbeinstanzen 135
 CITELLI Ohr-Knochenstanzen 34
 CLAR Stirnlampen 200, 201
 CLAUS Unterbindungsnadel 156
 CLAUS-EICKEN Unterbindungsnadel 156
 CLOWARD-CONTOUR Wundsperrerr 35
 COAKLEY Antrumküretten 105
 COAKLEY Trokar 226
 COLLER Arterienklemmen 258
 COLLIN Hammer 290
 COLLIN Skalpellgriff 231
 COLLIN Zungenzangen 208
 COLVER Tonsillenzangen 138
 CONVERSE Nasen- und Trachealhäkchen 89
 CONVERSE Nasennmesser 85
 CONVERSE Schere 242
 CORDES Broncho-Oesophagoskopiezangen 192
 COTTLE Hammer 62
 COTTLE Nasen- und Trachealhäkchen 89
 COTTLE Nasenhäkchen 86, 88
 COTTLE Nasennmesser 84
 COTTLE Nasenpinzette 22, 69
 COTTLE Nasenraspeln 97
 COTTLE Nasenschere 70
 COTTLE Nasenspekula 67
 COTTLE Osteotome 114-117
 COTTLE Osteotomführung 100
 COTTLE Periostelevatorien 110
 COTTLE Septumelevatorien 106, 107, 127, 128, 294, 295
 COTTLE Wundhaken 273
 COTTLE-KAZANJIAN Knochensplitterzange 302

Inhaltsverzeichnis
Index

Table des matières
Indice
Indice

COTTLE-MASING Nasenspekula 92
 COTTLE-NEIVERT Nasenhäkchen 88
 COTTLE-WALSHAM Septumzangen 74, 101
 CRAIG Nasenpolypenzange 73
 CRILE Arterienklemmen 257
 CRILE Wundhaken 273
 CRILE-MURRAY Nadelhalter 279
 CRILE-RANKIN Arterienklemmen 257
 CRILE-WOOD Nadelhalter 279
 CUSHING Pinzetten 245

D

DANDY Arterienklemmen 255
 DAVIS-BOYLE Mundsperrerr 222
 DAY Ohrhäkchen 25
 DE BAKEY Nadelhalter 285
 DE BAKEY Pinzetten 251, 252
 DEAN Tonsillenscheren 150
 DEAN-SHALLCROSS Arterienklemme 154
 DENHART Mundsperrerr 217
 DERF Nadelhalter 279
 Dermatome - Transplantationsmesser 235, 236
 DESCHAMPS Unterbindungsnadeln 157
 DESMARRES Wundhaken 270
 Diagnostik-Bestecke 198
 DIEFFENBACH Gefäßklemmen 253
 DIETER Mikro-Ohrzängchen 47
 DIETHRICH Gefäßklemmen 253
 DINGMANN Mundsperrerr 219
 DOYEN Tuchklemme 264
 DUEHRSEN Pinzette 250
 DUNHILL Arterienklemmen 258
 DUPUY-WEISS Unterbindungsnadeln 155
 Durchschneidende Nasenzangen 83

E

EICKEN Spülkanülen 227
 EMMET Wundhaken 269
 E nukleationsscheren 243
 EVES Tonsillenschnürer 147

F

FARABEUF Raspatorien 293
 FARABEUF-COLLIN Raspatorien 292
 FARELL-LATHBURY Watteträger 229
 FAULKNER Antrumkürette 105
 FEIN Watteträger 230
 Feine Scheren 242
 FERGUSSON Saugrohre 40
 FERGUSSON-ACKLAND Mundsperrerr 217
 FERRIS SMITH-KERRISON Stanzen 136
 Fiberglas-Lichtträger 165
 FISCH Mikro-Ohraspatorien 59
 FISCH Saugrohre 44
 FISCH Spülkanüle 227
 FISCHER Tonsillennmesser 143
 FISH Wundsperrerr 36
 FISH Wundsperrerr 38
 Fistelscheren 243
 Flexibler Spannarm 17

Flexibler Spannarm 92
 FOERSTER (BALLENGER) Schwammzangen 267
 FOMON Nasenhäkchen 86, 88
 FOMON Nasenmesser 84
 FOMON Nasenraspeln 98
 FOMON Nasenschere 70
 FOMON Osteotome 114
 FOMON TC Nasenraspeln 99
 FOSTER-GILLIES Nadelhalter 283
 FRAENKEL Broncho-Oesophagoskopiezangen 192
 FRAENKEL Kehlkopfpolypenzangen 180, 181
 FRAZIER Saugrohre 43
 FRAZIER Spülkanülen 228
 FREER Knochenmeißel 113
 FREER Nasenmesser 85
 FREER Septumelevatorien 106, 108, 109, 128, 295
 FREER Tonsillennmesser 143
 FRENCH Stimmgabeln 10
 FRENZEL Nystagmusbrillen 204
 FRENZEL Zungendrucker 206
 FRIEDMANN Hohlmeißelzange 299
 FULLER Mikro-Ohrzängchen 47

G

GALLAHER Nasenraspeln 98
 Gefäßklemmen 253
 GEMINI Arterienklemmen 260
 GERALD Pinzetten 246
 GERZOG Nasenmesser 85
 GERZOG Parazentesenadel 30
 GERZOG-SEXTON Ohrmesser 25
 Gewebe und Darmfasszangen 261, 262
 GILLIES chirurgische Pinzette 248
 GILLIES Nadelhalter 283
 GILLIES Nasenhäkchen 87
 Glasfaser-Kaltlichtkabel 338, 339
 GLATZEL Nasenspiegel 93
 GOOD Tonsillenschere 150, 244
 Griffe für Sinuskope 126
 GROSS Ohrküretten 29
 GROSS-MAIER Kornzangen 266
 GRUBER Ohrspekula 14

H

HAJEK Hammer 290
 HAJEK Keilbeinstanzen 134
 HAJEK-CLAUS Keilbeinstanze 135
 HAJEK-KOFLER Keilbeinstanzen 134
 HALLE Septumelevatorium 106, 294
 HALSEY Nadelhalter 281
 HALSTED-MOSQUITO Arterienklemmen 254
 Hämmer 111, 290
 HARTMANN Arterienklemmen 254
 HARTMANN Nasenpolypenzangen 71
 HARTMANN Ohrkatheter 18
 HARTMANN Ohrpolypenzange 24
 HARTMANN Ohrspekula 15
 HARTMANN Ohrzängchen 46
 HARTMANN scharfe Nasenzangen 82
 HARTMANN Stimmgabeln 9, 11

Inhaltsverzeichnis
Index

Table des matières
Indice
Indice

HARTMANN Tonsillotome	140
HARTMANN Zungendrücker	207
HARTMANN-HALLE Nasenspekula	64
HARTMANN-NOYES Ohrzängchen	46
HARTMANN-WEINGÄRTNER Ohrzängchen	46
HARTMANN-WULLSTEIN Ohrzängchen	46
HEANEY Nadelhalter	284
HEERMAN Mikro-Ohrmeißel	62
HEGAR-BAUMGARTNER Nadelhalter	280
HEISS Arterienklemmen	153
HEISTER Mundsperrerr	216
HENKE scharfe Nasenzange	77, 129
HENKE Tonsillendissektoren	142
HEUWIESER Antrumstanze	133
HEYMANN Nasenpolypenzangen	73
HEYMANN Nasenschere	70
HEYMANN-KNIGHT Nasenpolypenzange	73
HF-Geräte	346-348
Hohlmeißelzangen	299-301
HOLINGER Laryngoskope	162
HOLTZHEIMER Wundsperrerr	276
HOUSE Adapter	42
HOUSE Messsonde	53
HOUSE Mikro-Ohröffel	60, 61
HOUSE Saugrohre	40, 42
HUBER Universalgriff	191
HUMBY Dermatome	236
HURD Tonsillendissektoren	142
HURD Unterbindungsnadeln	155

I	
Instrumenten Kassetten	309
Instrumentensätze	349-359
IOWA Saugrohre	41
ITERSON Nasenhäkchen	87

J	
JACKSON Kehlkopfpinzette	138
JACKSON Laryngoskope	162
JACKSON Nasen- und Trachealhäkchen	89
JACKSON Trachealhäkchen	184, 268
JACOBSON Mikronadelhalter	308
JANSEN (GRUENWALD) Nasen- und Ohrpinzetten	23, 68
JANSEN scharfe Löffel	29
JANSEN Wundsperrerr	276
JENNINGS Mundsperrerr	216
JOHNS HOPKINS Gefäßklemmen	253
JONES Tuchklemmen	264
JOPSON-HORNE Watteträger	230
JOSEPH Nasenhäkchen	86, 87
JOSEPH Nasenmesser	84
JOSEPH Nasensägen	96
JOSEPH Septumelevatorium	106, 294
JOSEPH-MASING Septumelevatorium	109
JUDD-ALLIS Gewebefasszangen	261
JURASZ Kehlkopfpolypenzangen	180, 181
JURASZ Nasenrachenzange	140

K	
KABBIERSKE Pulverbläser	21

KAHN-FRAZIER Saugrohre	44
Kaltlichtquellen	332-336
Kaltlicht-Stirnlampe	203
Kameras	326-331
Katheterzangen	225
Kehlkopfinstrumente	166, 167, 179
Kehlkopfpolypenzangen	180, 181
Kehlkopfspiegel	178
Keilbeinstanzen	134, 135
KELLY Arterienklemmen	257
KELLY Fistelscheren	243
KELLY-RANKIN Arterienklemmen	257
KERRISON Keilbeinstanzen	135
KERRISON Ohr-Knochenstanzen	34
KILIAN Laryngofissurschere	179
KILIAN Nasenspekula	65
KILIAN Ohrkatheter	127
KILIAN Osteotom	114
KILIAN Septumelevatorien	108
KILIAN-CLAUS Osteotom	114
KILNER Nadelhalter	284
KILNER Nasen- und Trachealhäkchen	89
KILNER Nasenhäkchen	86
KILNER Wundhaken	272
KILNER-DOUGHTY Mundsperrerr	220
KNAPP (ROLLET) Wundhaken	270
KNIGHT Nasenpolypenzange	73
Knochenmeißel	112, 113
Knochensplitterzangen	302
KOCHER Arterienklemmen	258
KOCHER Kropfsonden	187, 224
KOCHER Wundhaken	271
KOCHER-LANGENBECK (OBWEGESER) Wundhaken	274
Kornzangen	266
KRAUSE Broncho-Oesophagoskopiezangen	192
KRAUSE Nasenpolypenschnürer	91
KRAUSE Ohrpolypenschnürer	32
KRAUSE Trokar	226
KRAUSE-VOSS Nasenpolypenschnürer	91
KRAUSE-VOSS Ohrpolypenschnürer	32
KROENIG Zungendrücker	206
Kropffasszangen -Kropfsonden	187, 224

L	
LA FORCE Ringmesser	146
LABORDE Trachealdilatatoren	184
LAHEY Kropffasszangen	187, 224
LAMBOTTE Raspatorien	293
LANDAU Trokar	226
LANDOLDT E nukleationsscheren	243
LANE Tuchklemmen	265
LANGE Broncho-Oesophagoskopiezangen	192
LANGE Nasenhäkchen	86
LANGENBECK Ohrküretten	29
LANGENBECK Wundhaken	274
LANGE-WILDE Nasenpolypenschnürer	91
LANGE-WILDE Ohrpolypenschnürer	32
LÄRMTRÖMMEL	11
Laryngoskope - Kaltlicht	212, 213
Laryngoskope - Warmlicht	209, 210

Inhaltsverzeichnis
Index

Table des matières
Indice
Indice

Laryngoskope (Optiken) 160, 161, 321
 Laryngoskopgriffe - Kaltlicht 214
 Laryngoskopgriffe - Warmlicht 211
 LAZAR Mikro-Knüpfpinzette 307
 LEMPert Ohrraspatorien 31
 LEMPert Septumelevatorien 106
 LERICHE Arterienklemmen 256
 LEWIS Tonsillenschraube 139
 LEXER-BABY Scheren 242
 LITAUER Nasenpolypenzange 73
 LITAUER Ohrpolypenzange 24
 LITTLEWOOD Gewebefasszange 261
 LOCKWOOD Gewebefasszange 262
 LORNA Tuchklemmen 264
 LOVE Uvula Haken 218
 LOVELACE Arterienklemmen 256
 LUBET-BARBON Nasenpolypenzange 71
 LUC scharfe Nasenzangen 75, 104
 LUCAE Hammer 111
 LUCAE Ohr- und Nasenpinzetten 23, 68
 LUCAE Ohrhäkchen 26
 LUCAE Parazentesenadeln 30
 LUCAE Stimmgabel 10
 LUER Standard Trachealkanülen 185
 LUER Wundhaken 268
 LUER-LOCK Spritzen 158
 LUER-LOCK Spülkanülen 227
 LUKENS Nasen- und Trachealhäkchen 89
 LUNIATSCHEK Tamponstopfer 141

M

MAGILL Katheterzangen 225
 MAGILL Saugrohre 41
 MAIER Kornzangen 266
 MALTZ Nasenraspeln 97, 98
 MANNERFELDT modif. Knochenmeißel 113
 MARQUARDT Hohlmeißelzange 300
 MARSCHIK Tonsillenpinzette 139
 MASING Periostelevatorium 110
 MASING Septumelevatorium 128
 MASTIN Kropffasszange 187, 224
 MATHIEU-OLSEN Nadelhalter 280
 MAUNDER Mundsperrerr 216
 MAYO Zungendrücker 206
 MAYO-HEGAR Nadelhalter 282
 MC INDOE Pinzetten 245
 MC INTOSH Laryngoskope 209, 212
 MCGEE Mikro-Ohrhäkchen 58
 MCGEE Mikro-Ohrzängchen 47
 MCIVOR Mundsperrerr 223
 MCKENTY Septumelevatorien 107
 MEAD Hammer 290
 METZENBAUM FINO Präparierscheren 241
 METZENBAUM Präparierscheren 239
 METZENBAUM-NESLON Präparierscheren 240
 MICHEL Kehlkopfspiegel 178
 MICRO-ADSON Pinzetten 245
 MICRO-MOSQUITO Arterienklemmen 255
 MIDLETON-JANSEN Septumzangen 102
 Mikro LED Stirnlampe 202

Mikro-Federscheren 306
 Mikro-Instrumente für die Laryngologie 169-177
 Mikro-Instrumente für Laryngo-Broncho-Oesophagoskopie 194-196
 Mikro-Klingenhalter - Mikro-Klingen 234
 Mikro-Knüpfpinzetten 307
 Mikro-Laryngoskope 161, 322
 Mikro-Löffelzängchen 49, 50
 Mikronadelhalter 308
 Mikronadelhalter mit Rundgriff 305
 Mikro-Ohrinstrumente 55, 56
 Mikro-Ohrhaken 60, 61
 Mikro-Ohrmeißel und Hämmer 62
 Mikro-Ohrnadeln und Häkchen 57, 58
 Mikro-Ohrraspatorien 59
 Mikro-Ohrscheren 51, 52
 Mikro-Ohrzängchen 47, 48
 Mikropinzetten 304
 Mikropräparierscheren 303
 MILLER Laryngoskope 210, 213
 MILLIGAN Wundsperrerr 35
 Mini CLAR Stirnlampe 200
 Mini FRIEDMANN Hohlmeißelzange 299
 Mini GEMINI Arterienklemmen 260
 Mini LAMBOTTE Knochenmeißel 112
 Mini LANGENBECK Wundhaken 271
 Mini LEXER Knochenmeißel 112
 Mini MCGEE Mikro-Ohrzängchen 48
 Mini Optiken 319
 Mini RYDER Nadelhalter 286
 Mod. MARTIN Watteträger 229
 Mod. WIEN Fadenfänger 289
 Mod. WIEN Nasenspekula 66
 MOLLISON Wundsperrerr 36
 MOLT Mundsperrerr 217
 MOSQUITO-DANDY Arterienklemme 255
 MUCK Ohrmesser 25
 Mundsperrerr 216-223
 MUSEUX Tonsillenzange 138
 MYLES scharfe Nasenzangen 82

N

Nadelhalter 279-288
 NAGER Gaumensegelhaken 218
 Nahtinstrumente 289
 Nahtinstrumente 155, 156
 Nasen- und Trachealhäkchen 89
 Nasenhäkchen 86-88
 Nasenmesser 84, 85
 Nasenpolypenschnürer 91
 Nasenpolypenzangen - Septumzangen 71-73
 Nasenraspeln 97, 98
 Nasensägen 96
 Nasenscheren 70, 71, 129
 Nasenspekula 64-68
 Nasenspiegel 93
 Nasentamponzange 72
 Naso-Pharyngoskope 94, 324
 NEGUS Arterienklemmen 154
 NEGUS Mundsperrerr 221
 NEIVERT Nadelhalter 284

Inhaltsverzeichnis
Index

Table des matières
Indice
Indice

NEIVERT Nasenhäkchen88
 NEIVERT-ANDERSON Osteotome 118
 Nierenschalen 311
 NIJMEGEN Saugrohre42
 NOYES Nasentamponzange72
 Nystagmusbrillen204

O
 OBWEGESER Nasenrückenschere 102
 OBWEGESER Septumzangen 103
 OBWEGESER Septumzangen 102, 103
 Oesophagoskop 190, 323
 Ohr Mikroraspatorien und Sonden53
 Ohr- und Nasenpinzetten 22, 23, 68, 69
 Ohrhäkchen und Messer25
 Ohrkatheter 18, 19, 127
 Ohr-Knochenstanzen33, 34
 Ohrküretten und scharfe Löffel27-29
 Ohrpolypenschnürer32
 Ohrpolypenzangen24
 Ohrraspatorien31
 Ohrschlingen und Häkchen26
 Ohr-Sichelmesser - Rundschnittmesser54
 Ohrspekula 13-16
 Ohrspritze 19
 Ohrzängchen46
 OLSEN-HEGAR Nadelhalter281
 Operationslaryngoskope 163, 164
 Osteotome und Flachmeißel 114-118
 Otoskope320
 OVERHOLT-GEISSENDOERFER Arterienklemmen259

P
 Parazentesenadeln30
 PARTSCH Hammer111
 PÉAN Arterienklemmen258
 PEERS-BERTRAM Tuchklemme265
 PELTESON Watteträger230
 PENNINGTON Septumelevatorium 109
 Periostelevatorien 110
 PIERCE Trokare226
 PLESTER Fussplattenhäkchen57
 PLESTER Lappenmesser, Rundschnittmesser54
 PLESTER Mikro-Ohrraspatorien53
 PLESTER Spülkanülen228
 PLESTER Wundsperrerr37
 POLITZER Ohrspekula 14
 POLITZER Parazentesenadeln30
 POLITZER Pulverbläser20
 POTTS-SMITH chirurgische Pinzetten 248
 Power LED Stirnlampe201
 Präparier- und Ligaturklemmen 154, 259, 260
 PRATT Antrumkürette 105
 PRINCE Tonsillenschere 150
 PROVIDENCE HOSPITAL Arterienklemmen255
 Pulverbläser 20, 21, 93

Q
 QUIRE Fremdkörperheber24

R
 RAGNELL-DAVIS Wundhaken273
 Raspatorien - Elevatorien 292, 293
 Raspeln mit Hartmetall99
 REICHERT Kehlkopfinstrument 179
 Reinigungs- und Sterilisationszubehör 341
 RICHNAU-HOLMGREN Ohrspekula 13
 Ringmesser90, 144-146
 RITTER-HALLE Stirnhöhlendilatoren 100
 ROBIN Tuchklemme264
 ROEDER Tuchklemmen263
 ROSE Wundhaken268
 ROSEN Bohrer297, 298
 ROSEN Mikro-Ohrnadel58
 ROSEN Ohrraspatorien31
 ROSEN Ohr-Sichelmesser54
 ROSEN Saugrohre41
 ROSER-KÖNIG Mundsperrerr217
 ROTTER Unterbindungsnadeln 156
 RUBIN Osteotome 116
 RUBIN Septumzange 103
 RUSKIN Hohlmeißelzangen 301
 RUSKIN-LISTON Knochensplitterzangen302
 RYDEL-SEIFFER Stimmgabel 10
 RYDER Nadelhalter286

S
 SAILER Nasenschere70
 SANVENERO Scheren242
 SAROT Nadelhalter284
 Saug- und Spülkanülen 227, 228
 Saugraspatorium 127
 Saugrohre 40-45
 Saugrohre für die Laryngologie 168
 SCHAEDEL Tuchklemme264
 Scharfe Doppellöffel291
 Scharfe Nasenzangen 75-82, 104, 129-131
 SCHEINMANN Broncho-Oesophagoskopiezangen 192
 SCHINK Dermatom235
 SCHMEDEN scharfe Nasenzangen 77, 129
 SCHMIEDEN Unterbindungsnadel 156
 SCHNIDT Arterienklemmen152
 SCHOENBORN Wundhaken268
 SCHUHKNECHT Rollermesser54
 Schüsseln 311
 Schwammzangen267
 SCHWARZ Nasenspekula65
 SEIFFERT Broncho-Oesophagoskopiezangen 192
 SEMKEN Pinzetten245
 SENN-GREEN Wundhaken273
 SENN-MILLER Wundhaken272
 Septum-Elevatorien 127, 128, 294, 295
 Septum-Elevatorien - Raspatorien 106-109
 Septumzangen 74, 101-103
 SEWALL Septumelevatorium 106
 SHAMBAUGH Mikro-Ohrnadeln 57, 58
 SHEA Mikro-Ohröffel60
 SHEEHAN Osteotome 117
 SIEGLE Ohrspekula 16
 SILVER Dermatom236

Inhaltsverzeichnis
Index

Table des matières
Indice
Indice

SILVER Osteotome 118
 SINUS Trokare..... 126
 Sinuskope 125, 319
 Skalpellgriffe..... 231, 232
 Skalpellklingen.....233
 SLUDER-BALLENGER Tonsillotome..... 149
 ST. CLAIR - THOMSON Ringmesser 144
 Standard Scheren237
 Stanzen.....136
 STERNBERG Wangenhalter..... 218
 Stimmgabeln.....9-12
 Stirnlampen 200-202
 Stirnspiegel.....199
 STRANDELL-STILLE Wundhaken273
 STRUEMPEL Ohrzängchen46
 STRUYCKEN scharfe Nasenzangen 77, 129

T

TAKAHASHI scharfe Nasenzangen75
 TAYLOR Pinzetten246
 TERRIER Arterienklemme254
 THIERSCH Dermatom235
 THOMS-ALLIS Gewebefasszange262
 TIECK-HALLE Nasenspekula64
 TILLEY Nasenpolypenzange.....72
 TOBOLD Zungendrucker.....207
 TOENNIS Arterienklemmen152
 TOHOKU-JAPAN Tuchklemmen265
 TOMATI scharfe Nasenzange..... 77, 129
 Tonsillen- und Septumkanülen 158
 Tonsillennstrumente..... 138-148
 Tonsillennmesser 143
 Tonsillenscheren 150, 244
 Tonsillennschnürer..... 147, 148
 Tonsillotome..... 149
 TOYNBEE Ohrspekula..... 13
 Trachealdilatatoren 184
 Trachealhäkchen..... 184, 268
 Trachealkanülen..... 185
 Tracheotomie-Besteck.....186
 Tränenkanal-Dilatatoren.....277
 TROELTSCH (WILDE) Ohr- und Nasenpinzetten22, 69
 TROELTSCH Ohrkatheter..... 19
 TROELTSCH Ohr-und Nasenpinzetten22, 69
 Trokare.....126, 226
 TROUSSEAU Trachealdilatatoren..... 184
 Tuchklemmen..... 263-265
 TYDING Tonsillennschnürer..... 148

U

UCKERMANN Trachealtrokar..... 185
 ULRICH Kornzangen.....266
 UNIVERASL Pulverbläser.....93
 Unterbindungsnadeln..... 157

V

VERHOEVEN Saugrohre42
 VOLKMANN Löffel.....291
 VOLKMANN Wundhaken272
 VOLTOLINI Nasenspekula.....68

W

WAGENER Ohrhäkchen26
 WALTER Osteotome 117
 WANGENSTEEN Pinzetten 247
 WATSON Dermatom236
 WATSON-WILIAMS scharfe Nasenzangen.....76
 Watteträger..... 229, 230
 WAUGH Pinzetten 247
 WEBSTER Nadelhalter280
 WEIL scharfe Nasenzange.....76
 WEIL-BLAKESLEY scharfe Nasenzangen.....82
 WEITLANER-LOKTITE Wundsperrerr.....275
 WEITLANER-WULLSTEIN Wundsperrerr35
 WESTMCOTT Nasenpolypenzange.....71
 WHITE Tonsillenzangen 138
 WHITEHEAD Mundsperrerr 216
 WIEDER Zungendrucker207
 WIENER Nasenraspeln98
 WILLIAMS Gewebefasszange262
 WILLIGER Raspatorien292
 WILLIGER Wundhaken38
 WULLSTEIN Mikro-Ohrscheren.....52
 WULLSTEIN Ohrspassatorien 31
 WULLSTEIN Wundsperrerr.....35
 Wundhaken268-274
 Wundsperrerr 35-38, 275, 276

Y

YANKAUER Saugrohr.....227
 YOUNG Zungenzangen208

Z

ZAUFAL-JANSEN Hohlmeißelzange300
 ZIEGLER Stirnspiegel..... 199
 Zirkular Stanzen..... 132
 ZÖLLNER Mikro-Ohrinstrumente 54-56
 ZÖLLNER Ohrspekula..... 14
 ZÖLLNER Saugrohre 41
 Zungendrucker206, 207
 Zungenzangen.....208

Inhaltsverzeichnis
Index

Table des matières
Indice
Indice

A

ABRAHAM tonsil knife 143

Accumulators and battery containers 215

Adapters for cold light cables 340

Adenoid curettes 90, 144-146

ADLERKEUTZ dissecting forceps 248

ADSON forceps 245, 247

ADSON raspatories 293

ADSON suction tubes 228

ADSON-BROWN forceps 247

ADSON-GRAEFE forceps 247

ADSON-Micro forceps 247

ALLIS tissue holding forceps 262

ALLIS-ADAIR tissue holding forceps 262

ALLIS-Baby tissue holding forceps 262

ALM self-retaining retractor 276

ANDREW tongue depressor 207

Antrum curettes 105

Antrum punches 133

ASCH septum forceps 101

Atomizers 20, 21, 93

Atraumatic forceps 251, 252

AUFRIEHT nasal hooks 89, 92

AUFRIEHT nasal rasps 97

B

BABCOCK tissue holding forceps 261

Baby CRILE-WOOD needle holder 280

BACKHAUS towel forceps 263

BAINBRIDGE haemostatic forceps 151

BALLENGER adenoid curettes 90

BALLENGER bone chisels 113

BALLENGER-HAJEK elevators 110, 294

BARANY noise drum 11

BARBARA micro ear needles 57, 58

BARNHILL adenoid curettes 144

BARON suction tubes 40

BARRAQUER needle holders 287

BECKMANN adenoid curettes 145

BECKMANN nasal specula 66

BELUCCI micro ear scissors 51

BELUCCI self-retaining retractors 36

BERNHARD towel forceps 263

BEYER bone rongeur 301

BEYER mastoid rongeur 33

BILLEAU ear loops 26

BINNER cold light head lamp 203

Binocular magnifying lens 205

BIRKET haemostatic forceps 151

BLOHMKE tonsil forceps 139

BLUMENTHAL bone rongeurs 299

BÖHLER bone cutting forceps 302

BÖHLER bone rongeurs 300

Bone chisels 112, 113

Bone curettes, double ended 291

Bone cutting forceps 302

Bone rongeurs 299-301

BOSE self-retaining retractor 276

BOSWORTH tongue depressor 207

BÖTTCHER tonsil scissors 150, 244

BOUCHERON ear specula 15

Bowls 311

BOWMAN lacrimal dilators 277

BOYS-ALLIS tissue holding forceps 261

BOZEMAN Knot tier 289

Broncho-oesophagoscopy forceps 191-193

Bronchoscopes 190, 323

BROPHY dissecting forceps 248, 250

BRUENINGS broncho-oesophagoscopy forceps 191, 192

BRUENINGS ear specula 16

BRUENINGS nasal cutting forceps 76

BRUENINGS nasal knife 84

BRUENINGS tongue depressor 206

BRUENINGS tonsil knife 143

BRUENINGS tonsil snare 147

BRUENINGS-BRUNK antrum retractor 100

BUCK ear curettes 27, 28

BUCK foreign body forceps 24

BUCK nasal knife 85

BUCK paracentesis needle 30

Burrs 296-298

C

CAIRNS haemostatic forceps 258

Cameras 326-331

CAPLAN septum forceps 103

CARPENTER enucleator 141

CASTROVIEJO-JACOBSON needle holders 287

Catheter forceps 225

CHADWICK enucleation scissors 243

CHEVALIER-JACKSON broncho-oesophagoscopy forceps 193

CHEVALIER-JACKSON trachea tubes 185

CHRISTOPHE haemostatic forceps 256

CINELLI osteotomes 115

Cirkular forceps 132

CITELLI mastoid rongeur 34

CITELLI sphenoid bone punches 135

CLAR head lamps 200, 201

CLAUS suture needle 156

CLAUS-EICKEN suture needle 156

Cleaning and sterilizing accessories 341

CLOWARD-CONTOUR self-retaining retractor 35

COAKLEY antrum curettes 105

COAKLEY trocar 226

Cold light head lamp 203

Cold light spources 332-336

COLLER haemostatic forceps 258

COLLIN hammer 290

COLLIN scalpel handle 231

COLLIN tongue forceps 208

COLVER tonsil forceps 138

CONVERSE nasal knife 85

CONVERSE scissors 242

CONVERSE trachea and nose retractor 89

CORDES broncho-oesophagoscopy forceps 192

COTTLE guide for osteotomes 100

COTTLE hammer 62

COTTLE nasal hooks 86, 88

COTTLE nasal knife 84

COTTLE nasal rasps 97

English

Inhaltsverzeichnis
Index

Table des matières
Indice
Indice

COTTLE nasal scissors70
 COTTLE nasal specula 67
 COTTLE nose forceps 22, 69
 COTTLE osteotomes 114-117
 COTTLE periosteal elevators..... 110
 COTTLE retractors273
 COTTLE septum elevators 106, 107, 127, 128, 294, 295
 COTTLE trachea and nose retractors.....89
 COTTLE-KAZANJIAN bone cutting forceps302
 COTTLE-MASING nasal specula.....92
 COTTLE-NEIVERT nasal hook.....88
 COTTLE-WALSHAM septum forceps 74, 101
 Cotton applicators 229, 230
 CRAIG nasal polypus forceps73
 CRILE haemostatic forceps257
 CRILE retractors.....273
 CRILE-MURRAY needle holder279
 CRILE-RANKIN haemostatic forceps257
 CRILE-WOOD needle holders279
 CUSHING forceps245

D

DANDY haemostatic forceps255
 DAVIS-BOYLE mouth gag222
 DAY ear hooks25
 DE BAKEY forceps 251, 252
 DE BAKEY needle holders285
 DEAN tonsil scissors150
 DEAN-SHALLCROSS haemostatic forceps..... 154
 Delicate scissors.....242
 DENHART mouth gag 217
 DERF needle holders279
 Dermatomes - transplantation knives 235, 236
 DESCHAMPS suture needles..... 157
 DESMARRS retractors.....270
 Diagnostic sets 198
 DIEFFENBACH haemostatic forceps253
 DIETER micro ear forceps 47
 DIETHRICH haemostatic forceps253
 DINGMANN mouth gag219
 Dissecting and ligature forceps.....154, 259, 260
 Dissecting forceps245, 247, 248
 Dissecting scissors - operating scissors..... 237-241
 DOYEN towel forceps264
 Dressing forceps.....245-250
 DUEHRSEN forceps250
 DUNHILL haemostatic forceps258
 DUPUY-WEISS suture needles..... 155

E

Ear- and nose forceps 22, 23, 68, 69
 Ear curettes and sharp spoons.....27-29
 Ear forceps.....46
 Ear hooks and knives25
 Ear loops und hooks.....26
 Ear micro raspatories and probes53
 Ear polypus forceps24
 Ear polypus snares.....32
 Ear raspatories.....31
 Ear seringue..... 19

Ear sickel-knives - circular cutting knives54
 Ear specula 13-16
 EICKEN suction and irrigation cannulas227
 EMMET retractors269
 ENucleation scissors.....243
 Eustachian catheters 18, 19, 127
 EVES tonsil snare..... 147

F

FARABEUF raspatories293
 FARABEUF-COLLIN raspatories.....292
 FARELL-LATHBURY cotton applicators.....229
 FAULKNER antrum curette105
 FEIN cotton applicator230
 FERGUSON suction tubes40
 FERGUSON-ACKLAND mouth gag..... 217
 FERRIS SMITH-KERRISON Stanzen..... 136
 Fiberglas cold light cables..... 338, 339
 Fiberglas light-guides 165
 FISCH micro ear raspatories59
 FISCH suction and irrigation cannula227
 FISCH suction tubes44
 FISCHER tonsil knife.....143
 FISH self-retaining retractors36, 38
 Fistula scissors243
 Flexible tension arm..... 17, 92
 FOERSTER (BALLENGER) sponge holding forceps267
 FOMON nasal hook86, 88
 FOMON nasal knife84
 FOMON nasal rasps98
 FOMON nasal scissors70
 FOMON osteotomes..... 114
 FOMON TC nasal rasps99
 FOSTER-GILLIES needle holders.....283
 FRAENKEL broncho-oesophagoscopy forceps 192
 FRAENKEL laryngeal polypus forceps..... 180, 181
 FRAZIER suction and irrigation cannulas228
 FRAZIER suction tubes43
 FREER bone chisels..... 113
 FREER nasal knives85
 FREER septum elevators 106, 108, 109, 128, 295
 FREER tonsil knives.....143
 FRENCH tuning forks 10
 FRENZEL nystagmus spectacles.....204
 FRENZEL tongue depressor206
 FRIEDMANN bone rongeur.....299
 FULLER micro ear forceps.....47

G

GALLAHER nasal rasps98
 GEMINI haemostatic forceps.....260
 GERALD forceps 246
 GERZOG nasal knife85
 GERZOG paracentesis needle30
 GERZOG-SEXTON ear knife.....25
 GILLIES dissecting forceps248
 GILLIES nasal hook87
 GILLIES needle holders283
 GLATZEL nasal mirror.....93
 Goitre grasping forceps - enucleators 187, 224

Inhaltsverzeichnis
Index

Table des matières
Indice
Indice

GOOD tonsil scissors 150, 244
GROSS ear curettes 29
GROSS-MAIER polypus and dressing forceps 266
GRUBER ear specula 14

H

Haemostatic forceps 151-153, 253-258
HAJEK hammer 290
HAJEK sphenoid bone punches 134
HAJEK-CLAUS sphenoid bone punch 135
HAJEK-KOFLER sphenoid bone punches 134
HALLE septum elevator 106, 294
HALSEY needle holders 281
HALSTED-MOSQUITO haemostatic forceps 254
Hammers 111, 290
Handles for sinusscopes 126
HARTMANN ear forceps 46
HARTMANN ear polypus forceps 24
HARTMANN ear specula 15
HARTMANN eustachian catheters 18
HARTMANN haemostatic forceps 254
HARTMANN nasal cutting forceps 82
HARTMANN nasal polypus forceps 71
HARTMANN tongue depressor 207
HARTMANN tonsilectome 140
HARTMANN tuning forks 9, 11
HARTMANN-HALLE nasal specula 64
HARTMANN-NOYES ear forceps 46
HARTMANN-WEINGÄRTNER ear forceps 46
HARTMANN-WULLSTEIN ear forceps 46
Head lamps 200-202
Head mirrors 199
HEANEY needle holders 284
HEERMAN micro ear chisels 62
HEGAR-BAUMGARTNER needle holders 280
HEISS haemostatic forceps 153
HEISTER mouth gag 216
HENKE nasal cutting forceps 77, 129
HENKE tonsil dissectors 142
HEUWIESER antrum punch 133
HEYMANN nasal polypus forceps 73
HEYMANN nasal scissors 70
HEYMANN-KNIGHT nasal polypus forceps 73
HF-units 346-348
HOLINGER laryngoscopes 162
HOLTZHEIMER self-retaining retractor 276
HOUSE Adapter 42
HOUSE measuring rod 53
HOUSE micro ear spoons 60, 61
HOUSE suction tubes 40, 42
HUBER standard handle 191
HUMBY dermatome+A307 236
HURD suture needles 155
HURD tonsil dissectors 142

I

Instrument sets 349-359
Instrument trays 309
IOWA suction tubes 41
ITERSON nasal hook 87

J

JACKSON laryngeal forceps 138
JACKSON laryngoscopes 162
JACKSON trachea and nose retractor 89
JACKSON trachea hooks 184, 268
JACOBSON micro needle holders 308
JANSEN (GRUENWALD) nasal and ear forceps 23, 68
JANSEN self-retaining retractor 276
JANSEN sharp spoons 29
JENNINGS mouth gags 216
JOHNS HOPKINS haemostatic forceps 253
JONES towel forceps 264
JOPSON-HORNE cotton applicator 230
JOSEPH nasal hooks 86, 87
JOSEPH nasal knives 84
JOSEPH nasal saws 96
JOSEPH septum elevator 106, 294
JOSEPH-MASING septum elevator 109
JUDD-ALLIS tissue holding forceps 261
JURASZ laryngeal polypus forceps 180, 181
JURASZ naso-pharyngeal forceps 140

K

KABIERSKE atomizer 21
KAHN-FRAZIER suction tubes 44
KELLY fistula scissors 243
KELLY haemostatic forceps 257
KELLY-RANKIN haemostatic forceps 257
KERRISON mastoid rongeur 34
KERRISON sphenoid bone punches 135
Kidney bowls 311
KILIAN eustachian catheters 127
KILIAN laryngectomy scissors 179
KILIAN nasal specula 65
KILIAN osteotome 114
KILIAN septum elevators 108
KILIAN-CLAUS osteotome 114
KILNER nasal hook 86
KILNER needle holder 284
KILNER retractors 272
KILNER trachea and nose retractor 89
KILNER-DOUGHTY mouth gag 220
KNAPP (ROLLET) retractor 270
KNIGHT nasal polypus forceps 73
KOCHER goitre enucleators 187, 224
KOCHER haemostatic forceps 258
KOCHER retractors 271
KOCHER-LANGENBECK (OBWEGESER) retractors 274
KRAUSE broncho-oesophagoscopy forceps 192
KRAUSE ear polypus snare 32
KRAUSE nasal polypus snare 91
KRAUSE trocar 226
KRAUSE-VOSS ear polypus snare 32
KRAUSE-VOSS nasal polypus snare 91
KROENIG tongue depressor 206

L

LA FORCE adenoid curettes 146
LABORDE trachea dilators 184
Lacrimal dilators 277

English

Inhaltsverzeichnis Index

Table des matières Indice Indice

LAHEY goitre grasping forceps.....	187, 224
LAMBOTTE raspatories.....	293
LANDAU trocar	226
LANDOLDT enucleation scissors.....	243
LANE towel forceps.....	265
LANGE broncho-oesophagoscopy forceps	192
LANGE nasal hook	86
LANGENBECK ear curettes	29
LANGENBECK retractors.....	274
LANGE-WILDE ear polypus snare	32
LANGE-WILDE nasal polypus snare.....	91
Laryngeal instruments	166, 167, 179
Laryngeal mirrors.....	178
Laryngeal polypus forceps	180, 181
Laryngoscope handles - cold light	214
Laryngoscope handles - warm light	211
Laryngoscopes - cold light	212, 213
Laryngoscopes - warm light	209, 210
Laryngoscopes (scopes)	160, 161, 321
LAZAR micro tying forceps.....	307
LEMPERT ear raspatories	31
LEMPERT septum elevators.....	106
LERICHE haemostatic forceps.....	256
LEWIS tonsil screw.....	139
LEXER-BABY scissors	242
LITAUER ear polypus forceps	24
LITAUER nasal polypus forceps	73
LITTLEWOOD tissue holding forceps	261
LOCKWOOD tissue holding forceps.....	262
LORNA towel forceps	264
LOVE uvula retractors	218
LOVELACE haemostatic forceps.....	256
LUBET-BARBON nasal polypus forceps.....	71
LUC nasal cutting forceps	75, 104
LUCAE ear- and nose forceps.....	23, 68
LUCAE ear hooks	26
LUCAE hammer.....	111
LUCAE paracentesis needle	30
LUCAE tuning fork.....	10
LUER retractors.....	268
LUER Standard trachea tubes	185
LUER-LOCK suction and irrigation cannulas.....	227
LUER-LOCK syringes	158
LUKENS trachea and nose retractor.....	89
LUNIATSCHEK tonsil tampon plugger.....	141

M

MAGILL catheter forceps	225
MAGILL suction tubes	41
MAIER polypus and dressing forceps	266
MALTZ nasal rasps	97, 98
MANNERFELDT modif. bone chisels.....	113
MARQUARDT bone rongeur.....	300
MARSCHIK tonsil forceps.....	139
MASING periosteal elevator	110
MASING septum elevator	128
MASTIN goitre grasping forceps.....	187, 224
Mastoid rongeurs	33, 34
MATHIEU-OLSEN needle holders.....	280
MAUNDER mouth gag	216

MAYO tongue depressor	206
MAYO-HEGAR needle holders.....	282
MC INDOE forceps	245
MC INTOSH laryngoscopes	209, 212
MCGEE micro ear forceps	47
MCGEE micro ear hooks	58
MCIVOR mouth gag.....	223
MCKENTY septum elevators.....	107
MEAD hammer.....	290
METZENBAUM FINO operating scissors	241
METZENBAUM operating scissors.....	239
METZENBAUM-NESLON operating scissors.....	240
MICHEL laryngeal mirrors	178
Micro blade-holder - micro-blades.....	234
Micro ear chisels and hammers	62
Micro ear forceps.....	47, 48
micro ear needles and hooks	57, 58
Micro ear nstruments.....	55, 56
Micro ear raspatories.....	59
Micro ear scissors.....	51, 52
Micro ear spoons	60, 61
Micro forceps.....	304
Micro instruments for laryngo-broncho-oesophagoscopy	194-196
Micro instruments for laryngology	169-177
Micro LED head lamp	202
Micro needle holders	308
Micro needle holders round handle.....	305
Micro operating scissors.....	303
Micro scissors.....	306
Micro spoon forceps	49, 50
Micro tying forceps	307
MICRO-ADSON forceps.....	245
Micro-laryngoscopes.....	161, 322
MICRO-MOSQUITO haemostatic forceps.....	255
MIDDLETON-JANSEN septum forceps.....	102
MILLER laryngoscopes.....	210, 213
MILLIGAN self-retaining retractor	35
Mini CLAR head lamp.....	200
Mini FRIEDMANN bone rongeur	299
Mini GEMINI haemostatic forceps.....	260
Mini LAMBOTTE bone chisels.....	112
Mini LANGENBECK retractors	271
Mini LEXER bone chisels.....	112
Mini MCGEE micro ear forceps	48
Mini RYDER needle holders.....	286
Mini Scopes	319
Mod. MARTIN cotton applicators	229
Mod. WIEN ligature catcher	289
Mod. WIEN nasal specula.....	66
MOLLISON self-retaining retractor	36
MOLT mouth gag.....	217
MOSQUITO-DANDY haemostatic forceps	255
Mouth gags	216-223
MUCK ear knife	25
MUSEUX tonsil forceps	138
MYLES nasal cutting forceps.....	82

N

NAGER soft plate retractor.....	218
Nasal cutting forceps	75-82, 104, 129-131

Inhaltsverzeichnis
Index

Table des matières
Indice
Indice

Nasal dressing forceps.....	72
Nasal hooks	86-88
Nasal knives.....	84, 85
Nasal mirror	93
Nasal polypus forceps - septum forceps	71-73
Nasal polypus snare.....	91
Nasal rasps	97, 98
Nasal saws.....	96
Nasal scissors.....	70, 71, 129
Nasal specula.....	64-68
Nasal through-cutting forceps.....	83
Naso-pharyngoscopes.....	94, 324
Needle holders.....	279-288
NEGUS haemostatic forceps	154
NEGUS mouth gag	221
NEIVERT nasal hook.....	88
NEIVERT needle holder	284
NEIVERT-ANDERSON osteotomes	118
NIJMEGEN suction tubes.....	42
Noise drum	11
NOYES nasal dressing forceps	72
Nystagmus spectacles	204

O	
OBWEGESER nasal bridge scissors	102
OBWEGESER septum forceps.....	102, 103
Oesophagoscope	190, 323
OLSEN-HEGAR needle holders	281
Operation laryngoscopes	163, 164
Osteotomes and chisels.....	114-118
Otoscopes.....	320
OVERHOLT-GEISSENDOERFER haemostatic forceps	259

P	
Paracentesis needles	30
PARTSCH hammer.....	111
PÉAN haemostatic forceps.....	258
PEERS-BERTRAM towel forceps.....	265
PELTESON cotton applicator	230
PENNINGTON septum elevator.....	109
Periosteal elevators.....	110
PIERCE trocars.....	226
PLESTER flap knife, circular cutting knife.....	54
PLESTER foot plate hook.....	57
PLESTER micro ear raspatories	53
PLESTER self-retaining retractors	37
PLESTER suction and irrigation cannulas	228
POLITZER atomizer.....	20
POLITZER ear specula	14
POLITZER paracentesis needles	30
Polypus and dressing forceps	266
POTTS-SMITH dissecting forceps	248
Power LED head lamp	201
PRATT antrum curette	105
PRINCE tonsil scissors	150
PROVIDENCE HOSPITAL haemostatic forceps.....	255
Punches	136

Q	
QUIRE foreign body lever	24

R	
RAGNELL-DAVIS retractors.....	273
Raspatories - elevators.....	292, 293
Rasps with tungsten carbide	99
REICHERT laryngeal instrument	179
Retractor for vocal cords.....	169
Retractors	268-274
RICHNAU-HOLMGREN ear specula	13
RITTER-HALLE frontal sinus bougies	100
ROBIN towel forceps	264
ROEDER towel forceps	263
ROSE retractors	268
ROSEN burrs.....	297, 298
ROSEN ear raspatories.....	31
ROSEN ear-sickle knife.....	54
ROSEN micro ear needles	58
ROSEN suction tubes	41
ROSER-KÖNIG mouth gag	217
ROTTER suture needles.....	156
RUBIN osteotomes.....	116
RUBIN septum forceps.....	103
RUSKIN bone rongeurs	301
RUSKIN-LISTON bone cutting forceps.....	302
RYDEL-SEIFFER tuning fork	10
RYDER needle holders.....	286

S	
SAILER nasal scissors	70
SANVENERO scissors.....	242
SAROT needle holders.....	284
Scalpel blades.....	233
Scalpel handles.....	231, 232
SCHAEDEL towel forceps.....	264
SCH EINMANN broncho-oesophagoscopy forceps	192
SCHINK dermatome.....	235
SCHMEDEN nasal cutting forceps	77, 129
SCHMIEDEN suture needle	156
SCHNIDT haemostatic forceps.....	152
SCHOENBORN retractors.....	268
SCHUHKNECHT roller knives	54
SCHWARZ nasal specula	65
SEIFFERT broncho-oesophagoscopy forceps.....	192
Self-retaining retractors	35-38, 275, 276
SEMKEN forceps	245
SENN-GREEN retractors.....	273
SENN-MILLER retractors	272
Septum elevators	127, 128, 294, 295
Septum elevators - raspatories	106-109
Septum forceps.....	74, 101-103
SEWALL septum elevator	106
SHAMBAUGH micro ear needles	57, 58
SHEA micro ear spoons	60
SHEEHAN osteotomes	117
SIEGLE ear specula	16
SILVER dermatome	236
SILVER osteotomes	118
SINUS trocars	126
Sinusscopes	125, 319
SLUDER-BALLENGER tonsilectomes	149
Sphenoid bone punches.....	134, 135

English

Inhaltsverzeichnis Index

Table des matières Indice Indice

Sponge holding forceps	267
ST. CLAIR - THOMSON adenoid curettes	144
Standard scissors	237
STERNBERG cheek retractors	218
STRANDELL-STILLE retractors	273
STRUEMPEL ear forceps	46
STRUYCKEN nasal cutting forceps	77, 129
Suction and irrigation cannulas	227, 228
Suction raspatory	127
Suction tubes	40-45
Suction tubes for laryngology	168
Suture instruments	155, 156, 289
Suture needles	157

T

TAKAHASHI nasal cutting forceps	75
TAYLOR forceps	246
TERRIER haemostatic forceps	254
THIERSCH dermatome	235
THOMS-ALLIS tissue holding forceps	262
TIECK-HALLE nasal specula	64
TILLEY nasal polypus forceps	72
Tissue grasping forceps	261, 262
TOBOLD tongue depressor	207
TOENNIS haemostatic forceps	152
TOHOKU-JAPAN towel forceps	265
TOMATI nasal cutting forceps	77, 129
Tongue depressors	206, 207
Tongue forceps	208
Tonsil and septum needles	158
Tonsil instruments	138-148
Tonsil knives	143
Tonsil scissors	150, 244
Tonsil snares	147, 148
Tonsilectomes	149
Towel forceps	263-265
TOYNBEE ear specula	13
Trachea and nose retractors	89
Trachea dilators	184
Trachea hooks	184, 268
Trachea tubes	185
Tracheotomy set	186
Trocars	126, 226
TROELTSCH (WILDE) ear- and nose forceps	22, 69
TROELTSCH ear-und nose forceps	22, 69
TROELTSCH eustachian catheters	19
TROUSSEAU trachea dilators	184
Tuning forks	9-12
TYDING tonsil snare	148

U

UCKERMANN trachea trocar	185
ULRICH polypus and dressing forceps	266
UNIVERASL atomizer	93

V

VERHOEVEN suction tubes	42
VOLKMANN retractors	272
VOLKMANN sharp spoons	291
VOLTOLINI nasal specula	68

W

WAGENER ear hooks	26
WALTER osteotomes	117
WANGENSTEEN forceps	247
WATSON dermatom	236
WATSON-WILIAMS nasal cutting forceps	76
WAUGH forceps	247
WEBSTER needle holders	280
WEIL nasal cutting forceps	76
WEIL-BLAKESLEY nasal cutting forceps	82
WEITLANER-LOKTITE self-retaining retractor	275
WEITLANER-WULLSTEIN self-retaining retractor	35
WESTMCOTT nasal polypus forceps	71
WHITE tonsil forceps	138
WHITEHEAD mouth gags	216
WIEDER tongue depressors	207
WIENER nasal rasps	98
WILLIAMS tissue holding forceps	262
WILLIGER raspatories	292
WILLIGER retractors	38
WULLSTEIN ear raspatories	31
WULLSTEIN micro ear scissors	52
WULLSTEIN self-retaining retractor	35

Y

YANKAUER suction tube	227
YOUNG tongue forceps	208

Z

ZAUFAL-JANSEN bone rongeur	300
ZIEGLER head mirrors	199
ZÖLLNER ear specula	14
ZÖLLNER micro ear instruments	54-56
ZÖLLNER suction tubes	41

**Inhaltsverzeichnis
Index**
**Table des matières
Indice
Indice**
A

Abaisse-langues.....	206, 207
ABRAHAM couteau à amygdales.....	143
Accessoires pour nettoyage et stérilisation.....	341
Accumulateurs et conteneurs de piles.....	215
Adaptateurs pour câbles de lumière froide.....	340
ADLERKEUTZ pinces à griffes.....	248
ADSON pinces.....	245, 247
ADSON rugines.....	293
ADSON tubes d'aspiration.....	228
ADSON-BROWN pinces.....	247
ADSON-GRAEFE pinces.....	247
ADSON-Micro pinces.....	247
Aiguilles de paracentèse.....	30
Aiguilles pour amygdales et la cloison nasale.....	158
Aiguilles pour sutures.....	157
ALLIS pinces pour le tissu.....	262
ALLIS-ADAIR pince pour le tissu.....	262
ALLIS-Baby pince pour le tissu.....	262
ALM écarteurs autostatiques.....	276
Amygdalotomes.....	149
ANDREW abaisse-langues.....	207
Anses et crochets auriculaires.....	26
Appareils HF.....	346-348
ASCH pince pour la cloison nasale.....	101
Assourdisseur.....	11
AUFRIEHT crochet nasal.....	89, 92
AUFRIEHT râpes nasales.....	97

B

BABCOCK pinces pour le tissu.....	261
Baby CRILE-WOOD porte-aiguilles.....	280
BACKHAUS pinces à champs.....	263
BAINBRIDGE pinces hémostatiques.....	151
BALLENGER ciseaux-burins.....	113
BALLENGER couteaux adénoïdes.....	90
BALLENGER-HAJEK éleveurs.....	110, 294
BARANY assourdisseur.....	11
BARBARA micro aiguilles auriculaires.....	57, 58
BARNHILL couteaux adénoïdes.....	144
BARON tubes d'aspiration.....	40
BARRAQUER porte-aiguilles.....	287
BECKMANN couteaux adénoïdes.....	145
BECKMANN spéculums nasaux.....	66
BELUCCI écarteurs autostatiques.....	36
BELUCCI micro ciseaux auriculaires.....	51
BERNHARD pinces à champs.....	263
BEYER pince gouge.....	301
BEYER rongeurs auriculaires.....	33
BILLEAU anses auriculaires.....	26
BINNER clairier frontal à lumière froide.....	203
BIRKET pinces hémostatiques.....	151
Bistouri pour le nez.....	84, 85
BLOHMKE pince pour amygdales.....	139
BLUMENTHAL pinces gouges.....	299
BÖHLER pinces coupantes à os.....	302
BÖHLER pinces gouges.....	300
BOSE écarteurs autostatiques.....	276
BOSWORTH abaisse-langues.....	207
BÖTTCHER ciseaux pour amygdales.....	150, 244

BOUCHERON spéculums auriculaires.....	15
BOWMAN dilateurs pour le canal lacrymal.....	277
BOYS-ALLIS pince pour le tissu.....	261
BOZEMAN torde-fils.....	289
Bras flexible.....	17
Bras flexible.....	92
Bronchoscopes.....	190, 323
BROPHY pinces à griffes.....	248, 250
BRUENINGS abaisse-langues.....	206
BRUENINGS bistouri pour le nez.....	84
BRUENINGS couteau à amygdales.....	143
BRUENINGS pinces coupantes pour le nez.....	76
BRUENINGS pinces pour broncho-oesophagoscopie.....	191, 192
BRUENINGS serre nœuds pour amygdales.....	147
BRUENINGS spéculums auriculaires.....	16
BRUENINGS-BRUNK écarteur pour le sinus maxillaire.....	100
BUCK aiguille de paracentèse.....	30
BUCK bistouri pour le nez.....	85
BUCK curettes auriculaires.....	27, 28
BUCK pince pour corps étrangers.....	24

C

Câbles de lumière froide.....	338, 339
CAIRNS pinces hémostatiques.....	258
Caméras.....	326-331
Canules pour aspiration et lavage.....	227, 228
Canules pour la trachéotomie.....	185
CAPLAN pince pour la cloison nasale.....	103
CARPENTER enucléateur.....	141
CASTROVIEJO-JACOBSON porte-aiguilles.....	287
CHADWICK ciseaux à énucléation.....	243
CHEVALIER-JACKSON canules pour la trachéotomie.....	185
CHEVALIER-JACKSON pinces pour broncho-oesophagoscopie.....	193
CHRISTOPHE pinces hémostatiques.....	256
CINELLI ostéotomes.....	115
Ciseaux à chirurgie - ciseaux à dissection.....	237-241
Ciseaux à énucléation.....	243
Ciseaux fins.....	242
Ciseaux nasaux.....	70, 71, 129
Ciseaux pour amygdales.....	150, 244
Ciseaux pour fistules.....	243
Ciseaux standard.....	237
Ciseaux-burins.....	112, 113
CITELLI pinces pour le sinus sphénoïdal.....	135
CITELLI rongeurs auriculaires.....	34
CLAR éclairateurs frontaux.....	200, 201
CLAUS aiguille pour sutures.....	156
CLAUS-EICKEN aiguille pour sutures.....	156
CLOWARD-CONTOUR écarteurs autostatiques.....	35
COAKLEY curettes d'antrum.....	105
COAKLEY trocar.....	226
COLLER pinces hémostatiques.....	258
COLLIN manche pour bistouri.....	231
COLLIN marteau.....	290
COLLIN pince tire-langues.....	208
COLVER pinces pour amygdales.....	138
Conteneurs d'instruments.....	309
CONVERSE bistouri pour le nez.....	85
CONVERSE ciseaux.....	242
CONVERSE écarteurs nasales et tracheales.....	89

Inhaltsverzeichnis
Index

Table des matières
Indice
Indice

CORDES pinces pour broncho-oesophagoscopie 192
 COTTLE bistouri pour le nez 84
 COTTLE ciseaux nasal 70
 COTTLE crochet nasal 86, 88
 COTTLE écarteurs 273
 COTTLE écarteurs nasales et tracheales 89
 COTTLE éleveurs pour la cloison nasale. 106, 107, 127, 128, 294, 295
 COTTLE éleveurs pour la périoste 110
 COTTLE guides pour ostéotomes..... 100
 COTTLE marteau 62
 COTTLE ostéotomes..... 114-117
 COTTLE pince nasale..... 22, 69
 COTTLE râpes nasales..... 97
 COTTLE spéculums nasaux 67
 COTTLE-KAZANJIAN pince coupante à os..... 302
 COTTLE-MASING spéculums nasaux 92
 COTTLE-NEIVERT crochet nasal..... 88
 COTTLE-WALSHAM pinces pour la cloison nasale 74, 101
 Coupoles..... 311
 Couteau à amygdales 143
 Couteaux adénoïdes 90, 144-146
 Couteaux faucilles - couteaux ronds 54
 CRAIG pince à polypes nasaux 73
 CRILE écarteurs 273
 CRILE pinces hémostatiques..... 257
 CRILE-MURRAY porte-aiguilles 279
 CRILE-RANKIN pinces hémostatiques 257
 CRILE-WOOD porte-aiguilles 279
 Crochets nasaux 86-88
 Crochets et couteaux auriculaires 25
 Curettes auriculaires et cuillères tranchantes 27-29
 Curettes d'antrum 105
 Curettes doubles..... 291
 CUSHING pinces..... 245

D

DANDY pinces hémostatiques..... 255
 DAVIS-BOYLE ouvre-bouche 222
 DAY crochets auriculaires 25
 DE BAKEY pinces 251, 252
 DE BAKEY porte-aiguilles 285
 DEAN ciseaux pour amygdales..... 150
 DEAN-SHALLCROSS pince hémostatique..... 154
 DENHART ouvre-bouche..... 217
 DERF porte-aiguilles 279
 Dermatomes - couteaux pour transplantations 235, 236
 DESCHAMPS aiguilles pour sutures 157
 DESMARRES écarteurs 270
 Diapasons 9-12
 DIEFFENBACH serre-fines 253
 DIETER micro pinces auriculaires 47
 DIETHRICH serre-fines 253
 Dilatateurs pour la trachéotomie..... 184
 Dilatateurs pour le canal lacrymal..... 277
 DINGMANN ouvre-bouche..... 219
 DOYEN pince à champs..... 264
 DUEHRSEN pince..... 250
 DUNHILL pinces hémostatiques..... 258
 DUPUY-WEISS aiguilles pour sutures 155

E

Ecarteur pour cordes vocales..... 169
 Ecarteurs 268-274
 Ecarteurs autostatiques 35-38, 275, 276
 Ecarteurs nasales et trachéales 89
 Ecarteurs trachéales 184, 268
 Eclaireur frontal à lumière froide..... 203
 Eclaireurs frontaux..... 200-202
 EICKEN canules pour aspiration et lavage..... 227
 Elevelateurs pour la cloison nasale 127, 128, 294, 295
 Elevelateurs pour la périoste..... 110
 Elevelateurs - rugines pour la cloison nasale 106-109
 EMMET écarteurs 269
 EVES serre nœuds pour amygdales..... 147

F

FARABEUF rugines 293
 FARABEUF-COLLIN rugines..... 292
 FARELL-LATHBURY porte-cotons 229
 FAULKNER curette d'antrum 105
 FEIN porte-cotons 230
 FERGUSSON tubes d'aspiration 40
 FERGUSSON-ACKLAND ouvre-bouche 217
 FERRIS SMITH-KERRISON rongeurs 136
 FISCH canule pour aspiration et lavage..... 227
 FISCH micro raspateurs auriculaires..... 59
 FISCH tubes d'aspiration 44
 FISCHER couteau à amygdales 143
 FISH écarteurs autostatiques..... 36, 38
 FOERSTER (BALLENGER) pinces à éponges 267
 FOMON bistouri pour le nez..... 84
 FOMON ciseaux nasal 70
 FOMON crochet nasal 86, 88
 FOMON ostéotomes..... 114
 FOMON râpes nasales 98
 FOMON TC râpes nasales 99
 FOSTER-GILLIES porte-aiguilles..... 283
 FRAENKEL pinces à polypes laryngiens 180, 181
 FRAENKEL pinces pour broncho-oesophagoscopie 192
 Fraises 296-298
 FRAZIER canules pour aspiration et lavage 228
 FRAZIER tubes d'aspiration 43
 FREER bistouris pour le nez 85
 FREER ciseaux-burins..... 113
 FREER couteaux à amygdales 143
 FREER éleveurs pour la cloison nasale..... 106, 108, 109, 128, 295
 FRENCH diapasons 10
 FRENZEL abaisse-langues 206
 FRENZEL lunettes pour le nystagme..... 204
 FRIEDMANN pince gouge..... 299
 FULLER micro pince auriculaire 47

G

GALLAHER râpes nasales..... 98
 GEMINI pinces hémostatiques 260
 GERALD pinces 246
 GERZOG aiguille de paracentèse..... 30
 GERZOG bistouri pour le nez 85
 GERZOG-SEXTON couteau auriculaire 25
 GILLIES crochets nasales..... 87

**Inhaltsverzeichnis
Index**
**Table des matières
Indice
Indice**

GILLIES pince à griffes	248
GILLIES porte-aiguilles	283
GLATZEL miroir nasal	93
GOOD ciseaux pour amygdales	150, 244
GROSS curettes auriculaires	29
GROSS-MAIER pinces à polypes et pansements	266
GRUBER spéculums auriculaires	14

H

HAJEK marteau	290
HAJEK pinces pour le sinus sphénoïdal	134
HAJEK-CLAUS pince pour le sinus sphénoïdal	135
HAJEK-KOFLER pinces pour le sinus sphénoïdal	134
HALLE éleveur pour la cloison nasale	106, 294
HALSEY porte-aiguilles	281
HALSTED-MOSQUITO pinces hémostatiques	254
Haricots	311
HARTMANN abaisse-langues	207
HARTMANN amygdalotomes	140
HARTMANN diapasons	9, 11
HARTMANN pince pour polypes auriculaires	24
HARTMANN pinces pour polypes nasaux	71
HARTMANN pinces auriculaires	46
HARTMANN pinces coupantes pour le nez	82
HARTMANN pinces hémostatiques	254
HARTMANN sondes auriculaires	18
HARTMANN spéculums auriculaires	15
HARTMANN-HALLE spéculums nasaux	64
HARTMANN-NOYES pince auriculaire	46
HARTMANN-WEINGÄRTNER pince auriculaire	46
HARTMANN-WULLSTEIN pince auriculaire	46
HEANEY porte-aiguilles	284
HEERMAN micro burins auriculaires	62
HEGAR-BAUMGARTNER porte-aiguilles	280
HEISS pinces hémostatiques	153
HEISTER ouvre-bouche	216
HENKE dissecteurs à amygdales	142
HENKE pince coupante pour le nez	77, 129
HEUWIESER pince pour l'antrum	133
HEYMANN ciseaux nasal	70
HEYMANN pinces à polypes nasaux	73
HEYMANN-KNIGHT pince à polypes nasaux	73
HOLINGER laryngoscopes	162
HOLTZHEIMER écarteurs autostatiques	276
HOUSE adaptateur	42
HOUSE micro curettes auriculaires	60, 61
HOUSE sonde à mesurer	53
HOUSE tubes d'aspiration	40, 42
HUBER poignée universelle	191
HUMBY dermatome	236
HURD aiguilles pour sutures	155
HURD dissecteurs à amygdales	142

I

Instruments de sutures	289
Instruments pour amygdales	138-148
Instruments pour la laryngologie	166, 167, 179
Instruments pour sutures	155, 156
IOWA tube d'aspiration	41
ITERSON crochets nasales	87

J

JACKSON écarteurs nasales et tracheales	89
JACKSON écarteurs trachéales	184, 268
JACKSON laryngoscopes	162
JACKSON pince laryngienne	138
JACOBSON micro porte-aiguilles	308
JANSEN (GRUENWALD) pinces auriculaires et nasaux	23, 68
JANSEN cuillères tranchantes	29
JANSEN écarteurs autostatiques	276
JENNINGS ouvre-bouches	216
Jeux d'instruments	349-359
JOHNS HOPKINS serre-fines	253
JONES pinces à champs	264
JOPSON-HORNE porte-cotons	230
JOSEPH bistouris pour le nez	84
JOSEPH crochet nasal	86, 87
JOSEPH éleveur pour la cloison nasale	106, 294
JOSEPH scies nasales	96
JOSEPH-MASING éleveur pour la cloison nasale	109
JUDD-ALLIS pinces pour le tissu	261
JURASZ pince naso-pharyngienne	140
JURASZ pinces à polypes laryngiens	180, 181

K

KABBIERSKE pulvérisateur	21
KAHN-FRAZIER tubes d'aspiration	44
KELLY ciseaux pour fistules	243
KELLY pinces hémostatiques	257
KELLY-RANKIN pinces hémostatiques	257
KERRISON pinces pour le sinus sphénoïdal	135
KERRISON rongeurs auriculaires	34
KILIAN ciseaux laryngien	179
KILIAN éleveurs pour la cloison nasale	108
KILIAN ostéotome	114
KILIAN sondes auriculaires	127
KILIAN spéculums nasaux	65
KILIAN-CLAUS ostéotome	114
KILNER crochet nasal	86
KILNER écarteurs	272
KILNER écarteurs nasales et tracheales	89
KILNER porte-aiguilles	284
KILNER-DOUGHTY ouvre-bouche	220
KNAPP (ROLLET) écarteurs	270
KNIGHT pince à polypes nasaux	73
KOCHER écarteurs	271
KOCHER pinces hémostatiques	258
KOCHER spatules à goitre	187, 224
KOCHER-LANGENBECK (OBWEGESER) écarteurs	274
KRAUSE pinces pour broncho-oesophagoscopie	192
KRAUSE serre nœuds auriculaire	32
KRAUSE serre nœuds pour polypes	91
KRAUSE trocart	226
KRAUSE-VOSS serre nœuds auriculaire	32
KRAUSE-VOSS serre nœuds pour polypes	91
KROENIG abaisse-langues	206

L

LA FORCE couteaux adénoïdes	146
LABORDE dilateurs pour la trachéotomie	184
LAHEY pinces à goitre	187, 224

Inhaltsverzeichnis
Index

Table des matières
Indice
Indice

LAMBOTTE rugines.....293
Lames de bistouris.....233
LANDAU trocart.....226
LANDOLDT ciseaux à énucléation.....243
LANE pinces à champs.....265
LANGE crochet nasal.....86
LANGE pinces pour broncho-oesophagoscopie.....192
LANGENBECK curettes auriculaires.....29
LANGENBECK écarteurs.....274
LANGE-WILDE serre nœuds auriculaire.....32
LANGE-WILDE serre nœuds pour polypes.....91
Laryngoscopes.....209, 210
Laryngoscopes (endoscopes).....160, 161, 321
Laryngoscopes - Lumière froide.....212, 213
Laryngoscopes pour opérations.....163, 164
LAZAR micro pinces à sutures.....307
LEMPERT éleveurs pour la cloison nasale.....106
LEMPERT raspateurs auriculaires.....31
LERICHE pinces hémostatiques.....256
LEWIS tire amygdales.....139
LEXER-BABY ciseaux.....242
LITAUER pince à polypes nasaux.....73
LITAUER pince pour polypes auriculaires.....24
LITTLEWOOD pince pour le tissu.....261
LOCKWOOD pince pour le tissu.....262
LORNA pinces à champs.....264
Loupe binoculaire.....205
LOVE écarteurs uvulaires.....218
LOVELACE pinces hémostatiques.....256
LUBET-BARBON pince à polypes nasaux.....71
LUC pinces coupantes pour le nez.....75, 104
LUCAE aiguilles de paracentèse.....30
LUCAE crochets auriculaires.....26
LUCAE diapason.....10
LUCAE marteau.....111
LUCAE pinces auriculaires et nasaux.....23, 68
LUER écarteurs.....268
LUER Standard canules pour la trachéotomie.....185
LUER-LOCK canules pour aspiration et lavage.....227
LUER-LOCK seringues.....158
LUKENS écarteurs nasales et tracheales.....89
Lunettes pour le nystagme.....204
LUNIATSCHEK porte coton.....141

M

MAGILL pinces pour cathéters.....225
MAGILL tubes d'aspiration.....41
MAIER pinces à polypes et pansements.....266
MALTZ râpes nasales.....97, 98
Manches pour bistouri.....231, 232
MANNERFELDT modif. ciseaux-burins.....113
MARQUARDT pince gouge.....300
MARSCHIK pince pour amygdales.....139
Marteaux.....111, 290
MASING éleveur pour la cloison nasale.....128
MASING éleveur pour la périoste.....110
MASTIN pince à goitre.....187, 224
MATHIEU-OLSEN porte-aiguilles.....280
MAUNDER ouvre-bouche.....216
MAYO abaisse-langues.....206

MAYO-HEGAR porte-aiguilles.....282
MC INDOE pinces.....245
MC INTOSH laryngoscopes.....209, 212
MCGEE micro crochets auriculaires.....58
MCGEE micro pince auriculaire.....47
MCIVOR ouvre-bouche.....223
MCKENTY éleveurs pour la cloison nasale.....107
MEAD marteau.....290
METZENBAUM ciseaux à dissection.....239
METZENBAUM FINO ciseaux à dissection.....241
METZENBAUM-NESLON ciseaux à dissection.....240
MICHEL miroirs laryngiens.....178
Micro pinces à sutures.....307
Micro aiguilles et crochets auriculaires.....57, 58
Micro burins auriculaires et marteaux.....62
Micro ciseaux.....306
Micro ciseaux à dissection.....303
Micro ciseaux auriculaires.....51, 52
Micro curettes auriculaires.....60, 61
Micro instrument pour la laryngologie.....169-177
Micro instruments auriculaires.....55, 56
Micro instruments pour laryngo-broncho-oesophagoscopie.....194-196
Micro laryngoscopes.....161, 322
Micro pince à cuillère.....49, 50
Micro pinces.....304
Micro pinces auriculaires.....47, 48
Micro porte-aiguilles.....308
Micro porte-aiguilles manche ronde.....305
Micro porte-lames - micro lames.....234
Micro raspateurs auriculaires.....59
Micro rugines et sondes auriculaires.....53
MICRO-ADSON pinces.....245
Micro-LED éclairer frontal.....202
MICRO-MOSQUITO pinces hémostatiques.....255
MIDDLETON-JANSEN pinces pour la cloison nasale.....102
MILLER laryngoscopes.....210, 213
MILLIGAN écarteur autostatique.....35
Mini CLAR éclairer frontal.....200
Mini endoscopes.....319
Mini FRIEDMANN pince gouge.....299
Mini GEMINI pinces hémostatiques.....260
Mini LAMBOTTE ciseaux-burins.....112
Mini LANGENBECK écarteurs.....271
Mini LEXER ciseaux-burins.....112
Mini MCGEE micro pinces auriculaires.....48
Mini RYDER porte-aiguilles.....286
Miroir nasal.....93
Miroirs frontaux.....199
Miroirs laryngiens.....178
Mod. MARTIN porte-cotons.....229
Mod. WIEN porte-ligatures.....289
Mod. WIEN spéculums nasaux.....66
MOLLISON écarteur autostatique.....36
MOLT ouvre-bouche.....217
MOSQUITO-DANDY pince hémostatique.....255
MUCK couteau auriculaire.....25
MUSEUX pince pour amygdales.....138
MYLES pinces coupantes pour le nez.....82

**Inhaltsverzeichnis
Index**
**Table des matières
Indice
Indice**
N

NAGER releveur du voile du palais	218
Naso-pharyngoscopes.....	94, 324
NEGUS ouvre-bouche	221
NEGUS pinces hémostatiques	154
NEIVERT crochet nasal.....	88
NEIVERT porte-aiguilles.....	284
NEIVERT-ANDERSON ostéotomes.....	118
NIJMEGEN tubes d'aspiration.....	42
NOYES pince à pansements pour le nez.....	72

O

OBWEGESER ciseaux pour le dos nasal.....	102
OBWEGESER pinces pour la cloison nasale.....	102, 103
Oesophagoscope	190, 323
OLSEN-HEGAR porte-aiguilles.....	281
Ostéotomes et ciseaux-burins.....	114-118
Otoscopes.....	320
Ouvre-bouches.....	216-223
OVERHOLT-GEISSENDOERFER pinces hémostatiques.....	259

P

PARTSCH marteau	111
PÉAN pinces hémostatiques	258
PEERS-BERTRAM pince à champs	265
PELTON porte-cotons.....	230
PENNINGTON éleveur pour la cloison nasale	109
PIERCE trocarts	226
Pince à pansements pour le nez.....	72
Pince coupante pour le nez	83
Pince pour polypes auriculaires	24
Pince tire-langues	208
Pinces à champs.....	263-265
Pinces à dissection	245-250
Pinces à dissequer et à sutures	154, 259, 260
Pinces à éponges.....	267
pinces à griffes	245, 247, 248
Pinces à polypes et pansements.....	266
Pinces à polypes laryngiens	180, 181
Pinces à polypes nasaux - pinces pour la cloison nasale.....	71-73
Pinces atraumatiques	251, 252
Pinces auriculaires.....	46
Pinces auriculaires et nasaux.....	22, 23, 68, 69
Pinces circulaires.....	132
Pinces coupantes à os	302
Pinces coupantes pour le nez	75-82, 104, 129-131
Pinces et spatules à goitre.....	187, 224
Pinces gouges.....	299-301
Pinces hémostatiques	151-153, 254-258
Pinces pour broncho-oesophagoscopie.....	191-193
Pinces pour cathéters	225
Pinces pour la cloison nasale	74, 101-103
Pinces pour l'antrum.....	133
Pinces pour le sinus sphénoïdal.....	134, 135
Pinces pour le tissu.....	261, 262
PLESTER canules pour aspiration et lavage	228
PLESTER couteau à lambeaux, couteau rond	54
PLESTER crochet à platine de l'étrier.....	57
PLESTER écarteurs autostatiques	37
PLESTER micro raspateurs auriculaires.....	53

Poignées pour laryngoscopes	211
Poignées pour laryngoscopes - lumière froide.....	214
Poignées pour sinuscopes.....	126
POLITZER aiguilles de paracentèse	30
POLITZER pulvérisateur.....	20
POLITZER spéculums auriculaires	14
Porte-aiguilles	279-288
Porte-cotons	229, 230
Portes lumière froide	165
POTTS-SMITH pinces à griffes.....	248
Power LED éclairer frontal.....	201
PRATT curette d'antrum	105
PRINCE ciseaux pour amygdales.....	150
PROVIDENCE HOSPITAL pinces hémostatiques	255
Pulvérisateurs	20, 21, 93

Q

QUIRE levier pour corps étrangers	24
---	----

R

RAGNELL-DAVIS écarteurs	273
Râpes avec inserts de carbure de tungstène.....	99
Râpes nasales.....	97, 98
Raspateurs auriculaires.....	31
REICHERT instrument laryngien	179
RICHNAU-HOLMGREN spéculums auriculaires.....	13
RITTER-HALLE dilateurs pour le sinus frontal	100
ROBIN pince à champs.....	264
ROEDER pinces à champs.....	263
Rongeurs.....	136
Rongeurs auriculaires	33, 34
ROSE écarteurs	268
ROSEN couteau faucille	54
ROSEN fraises.....	297, 298
ROSEN micro aiguille auriculaire.....	58
ROSEN raspateurs auriculaires	31
ROSEN tubes d'aspiration	41
ROSER-KÖNIG ouvre-bouches.....	217
ROTTER aiguilles pour sutures.....	156
RUBIN ostéotomes.....	116
RUBIN pince pour la cloison nasale.....	103
Rugine aspirante	127
Rugines - éleveurs.....	292, 293
RUSKIN pinces gouges.....	301
RUSKIN-LISTON pinces coupantes à os	302
RYDEL-SEIFFER diapason	10
RYDER porte-aiguilles	286

S

SAILER ciseaux nasal	70
SANVENERO ciseaux.....	242
SAROT porte-aiguilles	284
SCHAEDEL pince à champs	264
SCHEINMANN pinces pour broncho-oesophagoscopie	192
SCHINK dermatome.....	235
SCHMEDEN pinces coupantes pour le nez	77, 129
SCHMIEDEN aiguille pour sutures.....	156
SCHNIDT pinces hémostatiques.....	152
SCHOENBORN écarteurs	268
SCHUHKNECHT couteau à lame tournante.....	54

Inhaltsverzeichnis
Index

Table des matières
Indice
Indice

SCHWARZ spéculum nasal.....	65
Scies nasales.....	96
SEIFFERT pinces pour broncho-oesophagoscopie.....	192
SEMKEN pinces.....	245
SENN-GREEN écarteurs.....	273
SENN-MILLER écarteurs.....	272
Seringue auriculaire.....	19
Serre nœuds auriculaires.....	32
Serre nœuds pour amygdales.....	147, 148
Serre nœuds pour polypes.....	91
Serre-fines.....	253
SEWALL éleveur pour la cloison nasale.....	106
SHAMBAUGH micro aiguilles auriculaires.....	57, 58
SHEA micro curettes auriculaires.....	60
SHEEHAN ostéotomes.....	117
SIEGLE spéculums auriculaires.....	16
SILVER dermatome.....	236
SILVER ostéotomes.....	118
SINUS trocarts.....	126
Sinuscopes.....	125, 319
SLUDER-BALLENGER amygdalotomes.....	149
Sondes auriculaires.....	18, 19, 127
Sources de lumière froide.....	332-336
Spéculums auriculaires.....	13-16
Spéculums nasaux.....	64-68
ST. CLAIR - THOMSON couteaux adénoïdes.....	144
STERNBERG écarteurs des joues.....	218
STRANDELL-STILLE écarteurs.....	273
STRUEMPEL pinces auriculaires.....	46
STRUYCKEN pinces coupantes pour le nez.....	77, 129

T

TAKAHASHI pinces coupantes pour le nez.....	75
TAYLOR pinces.....	246
TERRIER pince hémostatique.....	254
THIERSCH dermatome.....	235
THOMS-ALLIS pince pour le tissu.....	262
TIECK-HALLE spéculums nasaux.....	64
TILLEY pince à polypes nasaux.....	72
TOBOLD abaisse-langues.....	207
TOENNIS pinces hémostatiques.....	152
TOHOKU-JAPAN pinces à champs.....	265
TOMATI pince coupante pour le nez.....	77, 129
TOYNBEE spéculums auriculaires.....	13
Trocarts.....	126, 226
TROELTSCH (WILDE) pinces auriculaires et nasaux.....	22, 69
TROELTSCH pinces auriculaires et nasaux.....	22, 69
TROELTSCH sondes auriculaires.....	19
Trousse pour la trachéotomie.....	186
TROUSSEAU dilateurs pour la trachéotomie.....	184
Trousses à diagnose.....	198
Tubes d'aspiration.....	40-45
Tubes d'aspiration pour la laryngologie.....	168
TYDING serre nœuds pour amygdales.....	148

U

UCKERMANN trocart pour la trachéotomie.....	185
ULRICH pinces à polypes et pansements.....	266
UNIVERASL pulvérisateur.....	93

V

VERHOEVEN tubes d'aspiration.....	42
VOLKMANN curettes.....	291
VOLKMANN écarteurs.....	272
VOLTOLINI spéculums nasaux.....	68

W

WAGENER crochets auriculaires.....	26
WALTER ostéotomes.....	117
WANGENSTEEN pinces.....	247
WATSON dermatome.....	236
WATSON-WILIAMS pinces coupantes pour le nez.....	76
WAUGH pinces.....	247
WEBSTER porte-aiguilles.....	280
WEIL pince coupante pour le nez.....	76
WEIL-BLAKESLEY pinces coupantes pour le nez.....	82
WEITLANER-LOKTITE écarteurs autostatiques.....	275
WEITLANER-WULLSTEIN écarteurs autostatiques.....	35
WESTMCOTT pince à polypes nasaux.....	71
WHITE pinces pour amygdales.....	138
WHITEHEAD ouvre-bouches.....	216
WIEDER abaisse-langues.....	207
WIENER râpes nasales.....	98
WILLIAMS pince pour le tissu.....	262
WILLIGER écarteur.....	38
WILLIGER rugines.....	292
WULLSTEIN écarteurs autostatiques.....	35
WULLSTEIN micro ciseaux auriculaires.....	52
WULLSTEIN raspateurs auriculaires.....	31

Y

YANKAUER tube d'aspiration.....	227
YOUNG pince tire-langues.....	208

Z

ZAUFAL-JANSEN pince gouge.....	300
ZIEGLER miroirs frontaux.....	199
ZÖLLNER micro instruments.....	54-56
ZÖLLNER spéculums auriculaires.....	14
ZÖLLNER tubes d'aspiration.....	41

**Inhaltsverzeichnis
Index**
**Table des matières
Indice
Indice**

A	
ABRAHAM cuchillo para amígdalas	143
Abrebocas.....	216-223
Accesorios para limpieza y esterilización	341
Accumuladores y contenedores para pilas.....	215
Adaptadores para cables de luz fría	340
ADLERKEUTZ pinzas de disección con dientes.....	248
ADSON canulas para aspiración	228
ADSON pinzas de disección	245, 247
ADSON raspatorios.....	293
ADSON-BROWN pinzas de disección.....	247
ADSON-GRAEFE pinzas de disección	247
ADSON-Micro pinzas de disección	247
Agujas de suturas	157
Agujas para amígdalas y el tabique nasal.....	158
Agujas para paracentesis.....	30
ALLIS pinzas para el tejido.....	262
ALLIS-ADAIR pinza para el tejido.....	262
ALLIS-Baby pinza para el tejido.....	262
ALM separadores autoestáticos.....	276
Amígdalótomos.....	149
ANDREW espátula bucal	207
Aparados HF	346-348
Aparato de ruido	11
Asas y ganchos auriculares.....	26
ASCH pinza para el tabique nasal	101
AUFRICHT ganchos nasales	89, 92
AUFRICHT limas nasales	97

B	
BABCOCK pinzas para el tejido	261
Baby CRILE-WOOD porta agujas	280
BACKHAUS pinzas de campo	263
BAINBRIDGE pinzas hemostáticas.....	151
BALLENGER cinceles	113
BALLENGER cuchillos para vegetaciones adenoides	90
BALLENGER-HAJEK elevadores	110, 294
BARANY aparato de ruido	11
BARBARA micro-agujas	57, 58
BARNHILL cuchillos para vegetaciones adenoides	144
BARON tubos para aspiración	40
BARRAQUER porta agujas.....	287
BECKMANN cuchillos para vegetaciones adenoides	145
BECKMANN espéculos nasales.....	66
BELUCCI micro tijeras auriculares.....	51
BELUCCI separadores autoestáticos	36
BERNHARD pinzas de campo	263
BEYER ostéotomos auriculares	33
BEYER pinza gubia	301
BILLEAU asas auriculares.....	26
BINNER ámpara frontal de luz fría.....	203
BIRKET pinzas hemostáticas	151
BLOHMKE pinza para amígdalas	139
BLUMENTHAL pinzas gubias	299
BÖHLER pinzas cortantes para huesos	302
BÖHLER pinzas gubias	300
BOSE separadores autoestáticos	276
BOSWORTH espátula bucal	207
BÖTTCHER tijera para amígdalas.....	150, 244
BOUCHERON espéculos auriculares	15

BOWMAN dilatadores lacrimales	277
BOYS-ALLIS pinza para el tejido.....	261
BOZEMAN tuerce-lazos	289
Brazo flexible	17, 92
Brocas.....	296-298
Broncoscopios	190, 323
BROPHY pinzas de disección con dientes	248, 250
BRUENINGS cierra-nudos para amígdalas.....	147
BRUENINGS cuchillo nasal.....	84
BRUENINGS cuchillo para amígdalas	143
BRUENINGS espátula bucal	206
BRUENINGS espéculos auriculares	16
BRUENINGS pinzas nasales cortantes	76
BRUENINGS pinzas para bronco-esofagoscopia.....	191, 192
BRUENINGS-BRUNK separador par el sinus.....	100
BUCK aguja para paracentesis.....	30
BUCK cuchillo nasal	85
BUCK curetas auriculares	27, 28
BUCK pinza para cuerpos extraños	24

C	
Cables de luz fría	338, 339
CAIRNS pinzas hemostáticas	258
Cajas de instrumental	309
Camáras	326-331
Canulas para aspiración.....	40-45
Canulas para aspiración y lavado	227, 228
Cánulas para la tráquea	185
CAPLAN pinza para el tabique nasal	103
CARPENTER enucleador.....	141
CASTROVIEJO-JACOBSON porta agujas.....	287
CHADWICK tijeras para enucleación	243
CHEVALIER-JACKSON cánulas para la tráquea	185
CHEVALIER-JACKSON pinzas para bronco-esofagoscopia	193
CHRISTOPHE pinzas hemostáticas.....	256
Cierra-nudos para amígdalas	147, 148
Cinceles	112-118
CINELLI cinceles	115
CITELLI ostéotomos auriculares	34
CITELLI pinzas para esfenoides	135
CLAR lámparas frontales	200, 201
CLAUS aguja de suturas	156
CLAUS-EICKEN aguja de suturas	156
CLOWARD-CONTOUR separadores autoestáticos	35
COAKLEY curetas para el antrum.....	105
COAKLEY trócar.....	226
COLLER pinzas hemostáticas.....	258
COLLIN mango de bisturí.....	231
COLLIN martillo	290
COLLIN pinzas tiralengua	208
COLVER pinzas para amígdalas.....	138
CONVERSE cuchillo nasal	85
CONVERSE separador tráqueal y nasal	89
CONVERSE tijera.....	242
CORDES pinzas para bronco-esofagoscopia	192
COTTLE cinceles	114-117
COTTLE cuchillo nasal.....	84
COTTLE elevadores para el periostio	110
COTTLE elevadores para el tabique nasal..	106, 107, 127, 128, 294, 295
COTTLE espéculos nasales.....	67

Inhaltsverzeichnis
Index

Table des matières
Indice
Indice

COTTLE ganchos nasales86, 88
 COTTLE guía para cinceles 100
 COTTLE limas nasales97
 COTTLE martillo62
 COTTLE pinza nasal.....22, 69
 COTTLE separador273
 COTTLE separadores tráqueales y nasales.....89
 COTTLE tijera nasal70
 COTTLE-KAZANJIAN pinza cortante para huesos302
 COTTLE-MASING espéculos nasales92
 COTTLE-NEIVERT ganchos nasales.....88
 COTTLE-WALSHAM pinzas para el tabique nasal..... 74, 101
 CRAIG pinza para pólipos nasales73
 CRILE pinzas hemostáticas257
 CRILE separador273
 CRILE-MURRAY porta agujas.....279
 CRILE-RANKIN pinzas hemostáticas.....257
 CRILE-WOOD porta agujas.....279
 Cuchillos en forma de hoz y redondos 54
 Cuchillos nasales84, 85
 Cuchillos para amígdalas 143
 Cuchillos para vegetaciones adenoides90, 144-146
 Curetas auriculares y legras cortantes.....27-29
 Curetas para el antrum 105
 CUSHING pinzas de disección.....245

D

DANDY pinzas hemostáticas255
 DAVIS-BOYLE abreboca.....222
 DAY ganchos auriculares.....25
 DE BAKEY pinzas de disección 251, 252
 DE BAKEY porta agujas285
 DEAN tijeras para amígdalas..... 150
 DEAN-SHALLCROSS pinza hemostática 154
 DENHART abreboca 217
 DERF porta agujas279
 Dermatomos - cuchillos para transplantaciones 235, 236
 DESCHAMPS agujas de suturas 157
 DESMARRES separador270
 Diapasones9-12
 DIEFFENBACH serrafinas253
 DIETER micro pinzas auriculares47
 DIETHRICH serrafinas253
 Dilatadores para la tráqueotomía 184
 Dilatadores lacrimales277
 DINGMANN abreboca219
 DOYEN pinza de campo264
 DUEHRSEN pinza de disección250
 DUNHILL pinzas hemostáticas258
 DUPUY-WEISS agujas de suturas 155

E

EICKEN canulas para aspiración y lavado.....227
 Elevadores para el periostio 110
 Elevadores para el tabique nasal..... 127, 128, 294, 295
 Elevadores y raspatorios para el tabique nasal 106-109
 EMMET separador.....269
 Esofagoscopia.....190, 323
 Espátula bucal206, 207
 Espéculos auriculares 13-16

Espéculos nasales..... 64-68
 Espejo nasal.....93
 Espejos frontales 199
 Espejos laringeos..... 178
 Estuche para tráqueotomía186
 EVES cierra-nudos para amígdalas..... 147

F

FARABEUF raspatorios293
 FARABEUF-COLLIN raspatorios.....292
 FARELL-LATHBURY porta-algodones229
 FAULKNER cureta para el antrum.....105
 FEIN porta-algodones230
 FERGUSSON tubos para aspiración40
 FERGUSSON-ACKLAND abreboca..... 217
 FERRIS SMITH-KERRISON pinzas cortantes 136
 FISCH canula para aspiración y lavado227
 FISCH micro raspatorios auriculares.....59
 FISCH tubos para aspiración.....44
 FISCHER cuchillo para amígdalas..... 143
 FISH separadores autoestáticos36
 FISH separadores autoestáticos38
 FOERSTER (BALLENGER) pinzas para esponjas.....267
 FOMON cinceles 114
 FOMON cuchillo nasal.....84
 FOMON ganchos nasales86, 88
 FOMON limas nasales98
 FOMON TC limas nasales.....99
 FOMON tijera nasal.....70
 FOSTER-GILLIES porta agujas283
 FRAENKEL pinzas para bronco-esofagoscopia 192
 FRAENKEL pinzas para pólipos laringeos 180, 181
 FRAZIER canulas para aspiración y lavado228
 FRAZIER tubos para aspiración43
 FREER cinceles 113
 FREER cuchillos nasales85
 FREER cuchillos para amígdalas..... 143
 FREER elevadores para el tabique nasal..... 106, 108, 109, 128, 295
 FRENCH diapasones 10
 FRENZEL espátula bucal206
 FRENZEL gafas para el Nistagmus204
 FRIEDMANN pinza gubia.....299
 Fuentes de luz fría..... 332-336
 FULLER micro pinza auricular47

G

Gafas para el Nistagmus204
 GALLAHER limas nasales98
 Ganchos nasales..... 86-88
 Ganchos y cuchillos auriculares25
 GEMINI pinzas hemostáticas.....260
 GERALD pinzas de disección 246
 GERZOG aguja para paracentesis.....30
 GERZOG cuchillo nasal.....85
 GERZOG-SEXTON cuchillo auricular25
 GILLIES ganchos nasales87
 GILLIES pinza de disección con dientes248
 GILLIES porta agujas283
 GLATZEL espejo nasal.....93
 GOOD tijera para amígdalas..... 150, 244

**Inhaltsverzeichnis
Index**
**Table des matières
Indice
Indice**

GROSS curetas auriculares	29
GROSS-MAIER pinzas para pólipos y vendajes	266
GRUBER espéculos auriculares	14

H

HAJEK martillo	290
HAJEK pinzas para esfenoides.....	134
HAJEK-CLAUS pinza para esfenoides	135
HAJEK-KOFLER pinzas para esfenoides	134
HALLE elevador para el tabique nasal	106, 294
HALSEY porta agujas	281
HALSTED-MOSQUITO pinzas hemostáticas.....	254
HARTMANN amigdalótomo	140
HARTMANN diapasones.....	9, 11
HARTMANN espátula bucal.....	207
HARTMANN espéculos auriculares.....	15
HARTMANN pinza para pólipos auriculares.....	24
HARTMANN pinzas auriculares	46
HARTMANN pinzas hemostáticas.....	254
HARTMANN pinzas nasales cortantes.....	82
HARTMANN pinzas para pólipos nasales.....	71
HARTMANN sondas auriculares	18
HARTMANN-HALLE espéculos nasales.....	64
HARTMANN-NOYES pinza auricular.....	46
HARTMANN-WEINGÄRTNER pinza auricular	46
HARTMANN-WULLSTEIN pinzas auriculares.....	46
HEANEY porta agujas.....	284
HEERMAN micro cinceles	62
HEGAR-BAUMGARTNER porta agujas.....	280
HEISS pinzas hemostáticas	153
HEISTER abreboza	216
HENKE disectores para amígdalas	142
HENKE pinza nasal cortante	77, 129
HEUWIESER pinza antrum.....	133
HEYMANN pinzas para pólipos nasales.....	73
HEYMANN tijera nasal	70
HEYMANN-KNIGHT pinza para pólipos nasales	73
Hojas de bisturí.....	233
HOLINGER laringoscopios	162
HOLTZHEIMER separadores autoestáticos.....	276
HOUSE adaptador.....	42
HOUSE canulas para aspiración.....	40, 42
HOUSE micro-legras	60, 61
HOUSE sonda para medir	53
HUBER mango universal.....	191
HUMBY dermatomo	236
HURD agujas de suturas	155
HURD disectores para amígdalas.....	142

I

Instrumentos para amígdalas.....	138-148
Instrumentos para laringología.....	166, 167, 179
Instrumentos para suturas.....	155, 156, 289
IOWA canula para aspiración	41
ITERSON ganchos nasales	87

J

JACKSON laringoscopios	162
JACKSON pinza laringea.....	138
JACKSON separadores tráqueales.....	184, 268

JACKSON separadores tráqueales y nasales	89
JACOBSON micro-porta agujas	308
JANSEN (GRUENWALD) pinzas auriculares y nasales	23, 68
JANSEN legras cortantes.....	29
JANSEN separadores autoestáticos	276
JENNINGS abrebozas	216
Jeringa auricular.....	19
JOHNS HOPKINS serrafinas	253
JONES pinzas de campo.....	264
JOPSON-HORNE porta-algodones	230
JOSEPH cuchillos nasales.....	84
JOSEPH elevador para el tabique nasal	106, 294
JOSEPH ganchos nasales	86, 87
JOSEPH sierras nasales.....	96
JOSEPH-MASING elevador para el tabique nasal.....	109
JUDD-ALLIS pinzas para el tejido	261
Juegos de instrumentos	349-359
Juegos para diagnóstica.....	198
JURASZ pinza naso-faringea.....	140
JURASZ pinzas para pólipos laringeos.....	180, 181

K

KABBIERSKE pulverizador	21
KAHN-FRAZIER tubos para aspiración.....	44
KELLY pinzas hemostáticas.....	257
KELLY tijeras para fistulas.....	243
KELLY-RANKIN pinzas hemostáticas	257
KERRISON ostéotomos auriculares	34
KERRISON pinzas para esfenoides	135
KILIAN cincel	114
KILIAN elevadores para el tabique nasal	108
KILIAN espéculos nasales	65
KILIAN sondas auriculares	127
KILIAN tijera laringea	179
KILIAN-CLAUS cincel	114
KILNER gancho nasal	86
KILNER porta agujas	284
KILNER separador	272
KILNER separador tráqueal y nasal	89
KILNER-DOUGHTY abreboza.....	220
KNAPP (ROLLET) separador	270
KNIGHT pinza para pólipos nasales.....	73
KOCHER pinzas hemostáticas	258
KOCHER separador	271
KOCHER sondas para el bocio	187, 224
KOCHER-LANGENBECK (OBWEGESER) separador.....	274
KRAUSE pinzas para bronco-esofagoscopia.....	192
KRAUSE polipótomo auricular	32
KRAUSE polipótomo nasal	91
KRAUSE trócar.....	226
KRAUSE-VOSS polipótomo auricular	32
KRAUSE-VOSS polipótomo nasal.....	91
KROENIG espátula bucal	206

L

LA FORCE cuchillos para vegetaciones adenoideas	146
LABORDE dilatadores para la tráqueotomía	184
LAHEY pinzas para coger el bocio.....	187, 224
LAMBOTTE raspatorios	293
Lámpara frontal de luz fría	203

Inhaltsverzeichnis
Index

Table des matières
Indice
Indice

Lámparas frontales 200-202
 LANDAU trócar 226
 LANDOLDT tijeras para enucleación 243
 LANE pinzas de campo 265
 LANGE gancho nasal 86
 LANGE pinzas para bronco-esofagoscopia 192
 LANGENBECK curetas auriculares 29
 LANGENBECK separador 274
 LANGE-WILDE polipótomo auricular 32
 LANGE-WILDE polipótomo nasal 91
 Laringoscopios 209, 210
 Laringoscopios - luz fría 212, 213
 Laringoscopios (ópticas) 160, 161, 321
 Laringoscopios para operaciones 163, 164
 LAZAR micro-pinza de suturas 307
 Legras aspiradora 127
 Legras cortantes 291
 LEMPERT elevadores para el tabique nasal 106
 LEMPERT raspatorios auriculares 31
 LERICHE pinzas hemostáticas 256
 LEWIS tira amigdales 139
 LEXER-BABY tijeras 242
 Limas con carbura de tungsteno 99
 Limas nasales 97, 98
 LITAUER pinza para pólipos auriculares 24
 LITAUER pinza para pólipos nasales 73
 LITTLEWOOD pinza para el tejido 261
 LOCKWOOD pinza para el tejido 262
 LORNA pinzas de campo 264
 LOVE separadores para Uvula 218
 LOVELACE pinzas hemostáticas 256
 LUBET-BARBON pinza para pólipos nasales 71
 LUC pinzas nasales cortantes 75, 104
 LUCAE agujas para paracentesis 30
 LUCAE diapason 10
 LUCAE ganchos auriculares 26
 LUCAE martillo 111
 LUCAE pinzas auriculares y nasales 23, 68
 LUER separador 268
 LUER Standard cánulas para la tráquea 185
 LUER-LOCK canulas para aspiración y lavado 227
 LUER-LOCK Spritzen 158
 LUKENS separador tráqueal y nasal 89
 LUNIATSCHKEK porta algodones 141
 Lupa binocular 205

M

MAGILL pinzas para catéteres 225
 MAGILL tubos para aspiración 41
 MAIER pinzas para pólipos y vendajes 266
 MALTZ limas nasales 97, 98
 Mangos de bisturí 231, 232
 Mangos para laringoscopios 211
 Mangos para laringoscopios - luz fría 214
 Mangos para sinuscopios 126
 MANNERFELDT modif. cinceles 113
 MARQUARDT pinza gubia 300
 MARSCHIK pinza para amigdales 139
 Martillos 111, 290
 MASING elevador para el tabique nasal 128

MASING elevador para el periostio 110
 MASTIN pinza para coger el bocio 187, 224
 MATHIEU-OLSEN porta agujas 280
 MAUNDER abreboca 216
 MAYO espátula bucal 206
 MAYO-HEGAR porta agujas 282
 MC INDOE pinzas de disección 245
 MC INTOSH laringoscopios 209, 212
 MCGEE micro gancho 58
 MCGEE micro pinza auricular 47
 MCIVOR abreboca 223
 MCKENTY elevadores para el tabique nasal 107
 MEAD martillo 290
 METZENBAUM FINO tijeras de disección 241
 METZENBAUM tijeras de disección 239
 METZENBAUM-NESLON tijeras de disección 240
 MICHEL espejos laringeos 178
 Micro- pinzas a cucharillas 49, 50
 MICRO-ADSON pinzas de disección 245
 Micro-agujas y ganchos auriculares 57, 58
 Micro-cinceles y martillos 62
 Micro-instrumentos auriculares 55, 56
 Micro-instrumentos para la laringo-bronco-esofagoscopia 194-196
 Micro-instrumentos para laringología 169-177
 Micro-laringoscopios 161, 322
 Micro-LED lámpara frontal 202
 Micro-legras auriculares 60, 61
 MICRO-MOSQUITO pinzas hemostáticas 255
 Micro-pinzas auriculares 47, 48
 Micro-pinzas de disección 304
 Micro-pinzas de suturas 307
 Micro-porta agujas 308
 Micro-porta agujas con mango redondo 305
 Micro-porta-hojas - micro-hojas 234
 Micro-raspatorios auriculares 59
 Micro-sondas y raspatorios auriculares 53
 Micro-tijeras 306
 Micro-tijeras auriculares 51, 52
 Micro-tijeras de disección 303
 MIDDLETON-JANSEN pinzas para el tabique nasal 102
 MILLER laringoscopios 210, 213
 MILLIGAN separador autoestático 35
 Mini CLAR lámpara frontal 200
 Mini FRIEDMANN pinza gubia 299
 Mini GEMINI pinzas hemostáticas 260
 Mini LAMBOTTE cinceles 112
 Mini LANGENBECK separador 271
 Mini LEXER cinceles 112
 Mini MCGEE micro pinzas auriculares 48
 Mini ópticas 319
 Mini RYDER porta agujas 286
 Mod. MARTIN porta-algodones 229
 Mod. WIEN captador de hilos 289
 Mod. WIEN espéculos nasales 66
 MOLLISON separador autoestático 36
 MOLT abreboca 217
 MOSQUITO-DANDY pinza hemostática 255
 MUCK cuchillo auricular 25
 MUSEUX pinza para amigdales 138
 MYLES pinzas nasales cortantes 82

Inhaltsverzeichnis
Index

Table des matières
Indice
Indice

N

NAGER separador del velo palatino 218
 Nasofaringoscopios 94, 324
 NEGUS abreboca 221
 NEGUS pinzas hemostáticas 154
 NEIVERT ganchos nasales 88
 NEIVERT porta agujas 284
 NEIVERT-ANDERSON cinceles 118
 NIJMEGEN tubos para aspiración 42
 NOYES pinza para tampones nasales 72

O

OBWEGESER pinzas para el tabique nasal 102, 103
 OBWEGESER tijera para el dorso nasal 102
 OLSEN-HÉGAR porta agujas 281
 Ostéotomos auriculares 33, 34
 Otoscopios 320
 OVERHOLT-GEISSENDOERFER pinzas hemostáticas 259

P

Palanganas 311
 PARTSCH martillo 111
 PÉAN pinzas hemostáticas 258
 PEERS-BERTRAM pinza de campo 265
 PELTESON porta-algodones 230
 PENNINGTON elevador para el tabique nasal 109
 PIERCE trócares 226
 Pinza para tampones nasales 72
 Pinzas antrum 133
 Pinzas atraumáticas 251, 252
 Pinzas auriculares 46
 Pinzas auriculares y nasales 22, 23, 68, 69
 Pinzas circulares 132
 Pinzas cortantes 136
 Pinzas cortantes para huesos 302
 Pinzas de campo 263-265
 Pinzas de disección 245-250
 Pinzas de disección con dientes 245, 247, 248
 Pinzas gubias 299-301
 Pinzas hemostáticas 151-153, 254-258
 Pinzas nasales cortantes 75-83, 104, 129-131
 Pinzas para bronco-esofagoscopia 191-193
 Pinzas para catéteres 225
 Pinzas para coger el bocio -sondas para el bocio 187, 224
 Pinzas para coger el tejido 261, 262
 Pinzas para el tabique nasal 74, 101-103
 Pinzas para esfenoides 134, 135
 Pinzas para esponjas 267
 Pinzas para pólipos auriculares 24
 Pinzas para pólipos laringeos 180, 181
 Pinzas para pólipos nasales - pinzas para el tabique nasal 71-73
 Pinzas para pólipos y vendajes 266
 Pinzas para preparación y suturas 154, 259, 260
 Pinzas tiralengua 208
 PLESTER canulas para aspiración y lavado 228
 PLESTER cuchillo para lobulos, cuchillo redondo 54
 PLESTER gancho para placa de oído 57
 PLESTER micro raspatorios auriculares 53
 PLESTER separadores autoestáticos 37
 Polipótomos auriculares 32

Polipótomos nasales 91
 POLITZER agujas para paracentesis 30
 POLITZER espéculos auriculares 14
 POLITZER pulverizador 20
 Porta agujas 279-288
 Porta fibras 165
 Porta-algodones 229, 230
 POTTS-SMITH pinzas de disección con dientes 248
 Power-LED lámpara frontal 201
 PRATT cureta para el antrum 105
 PRINCE tijera para amígdalas 150
 PROVIDENCE HOSPITAL pinzas hemostáticas 255
 Pulverizadores 20, 21, 93

Q

QUIRE elevador para cuerpos extraños 24

R

RAGNELL-DAVIS separador 273
 Raspatorios - elevadores 292, 293
 Raspatorios auriculares 31
 REICHERT instrumento laringeo 179
 RICHNAU-HOLMGREN espéculos auriculares 13
 Riñoneras 311
 RITTER-HALLE dilatadores para el sinus frontal 100
 ROBIN pinza de campo 264
 ROEDER pinzas de campo 263
 ROSE separador 268
 ROSEN brocas 297, 298
 ROSEN cuchillo de hoz 54
 ROSEN micro-aguja 58
 ROSEN raspatorios auriculares 31
 ROSEN tubos para aspiración 41
 ROSER-KÖNIG abreboca 217
 ROTTER agujas de suturas 156
 RUBIN cinceles 116
 RUBIN pinza para el tabique nasal 103
 RUSKIN pinzas gubias 301
 RUSKIN-LISTON pinzas cortantes para huesos 302
 RYDEL-SEIFFER diapason 10
 RYDER porta agujas 286

S

SAILER tijera nasal 70
 SANVENERO tijeras 242
 SAROT porta agujas 284
 SCHAEDEL pinza de campo 264
 SCHEINMANN pinzas para bronco-esofagoscopia 192
 SCHINK dermatomo 235
 SCHMEDEN pinzas nasales cortantes 77, 129
 SCHMIEDEN aguja de suturas 156
 SCHNIDT pinzas hemostáticas 152
 SCHOENBORN separador 268
 SCHUHKNECHT cuvhillo redondo 54
 SCHWARZ espéculo nasal 65
 SEIFFERT pinzas para bronco-esofagoscopia 192
 SEMKEN pinzas de disección 245
 SENN-GREEN separador 273
 SENN-MILLER separador 272
 Separador para cuerdas vocales 169

Inhaltsverzeichnis
Index

Table des matières
Indice
Indice

Separadores	268-274
Separadores autoestáticos	35-38, 275, 276
Separadores tráqueales	184, 268
Separadores tráqueales y nasales	89
Serrafinas	253
SEWALL elevador para el tabique nasal	106
SHAMBAUGH micro-agujas	57, 58
SHEA micro cuchillo	60
SHEEHAN cinceles	117
SIEGLE espéculos auriculares	16
Sierras nasales	96
SILVER cinceles	118
SILVER dermatomo	236
SINUS trócares	126
Sinuscopios	125, 319
SLUDER-BALLENGER amigdalótomos	149
Sondas auriculares	18, 19, 127
ST. CLAIR - THOMSON cuchillos para vegetaciones adenoides	144
STERNBERG sepeardores de mejillas	218
STRANDELL-STILLE separador	273
STRUEMPEL pinzas auriculares	46
STRUYCKEN pinzas nasales cortantes	77, 129

T	
TAKAHASHI pinzas nasales cortantes	75
TAYLOR pinzas de disección	246
TERRIER pinza hemostática	254
THIERSCH dermatomo	235
THOMS-ALLIS pinza para el tejido	262
TIECK-HALLE espéculos nasales	64
Tijeras finas	242
Tijeras nasales	70, 71, 129
Tijeras para amigdales	150, 244
Tijeras para cirugía - tijeras de disección	237-241
Tijeras para enucleación	243
Tijeras para fistulas	243
Tijeras STANDARD	237
TILLEY pinza para pólipos nasales	72
TOBOLD espatula bucal	207
TOENNIS pinzas hemostáticas	152
TOHOKU-JAPAN pinzas de campo	265
TOMATI pinza nasal cortante	77, 129
TOYNBEE espéculos auriculares	13
Trócares	126, 226
TROELTSCH (WILDE) pinzas auriculares y nasales	22, 69
TROELTSCH pinzas auriculares y nasales	22, 69
TROELTSCH sondas auriculares	19
TROUSSEAU dilatadores para la tráqueotomía	184
Tubos de aspiración para la laringología	168
TYDING cierra-nudos para amigdales	148

U	
UCKERMANN trócar de tráquea	185
ULRICH pinzas para pólipos y vendajes	266
UNIVERASL pulverizador	93

V	
VERHOEVEN tubos para aspiración	42
VOLKMANN legras	291
VOLKMANN separador	272

VOLTOLINI espéculos nasales	68
-----------------------------------	----

W	
WAGENER ganchos auriculares	26
WALTER cinceles	117
WANGENSTEEN pinzas de disección	247
WATSON dermatomo	236
WATSON-WILIAMS pinzas nasales cortantes	76
WAUGH pinzas de disección	247
WEBSTER porta agujas	280
WEIL pinza nasal cortante	76
WEIL-BLAKESLEY pinzas nasales cortantes	82
WEITLANER-LOKTITE separadores autoestáticos	275
WEITLANER-WULLSTEIN separadores autoestáticos	35
WESTMCOTT pinza para pólipos nasales	71
WHITE pinzas para amigdales	138
WHITEHEAD abre bocas	216
WIEDER espatulas bucales	207
WIENER limas nasales	98
WILLIAMS pinza para el tejido	262
WILLIGER raspatorios	292
WILLIGER separador	38
WULLSTEIN micro-tijeras auriculares	52
WULLSTEIN raspatorios auriculares	31
WULLSTEIN separadores autoestáticos	35

Y	
YANKAUER canula para aspiración y lavado	227
YOUNG pinza tiralengua	208

Z	
ZAUFAL-JANSEN pinza gubia	300
ZIEGLER espejos frontales	199
ZÖLLNER canulas para aspiración	41
ZÖLLNER espéculos auriculares	14
ZÖLLNER micro-instrumentos auriculares	54-56

**Inhaltsverzeichnis
Index**
**Table des matières
Indice
Indice**

A	
Abbassalingua.....	206, 207
ABRAHAM bisturi per tonsille.....	143
Accessori per pulizia e sterilizzazione.....	341
Accumulatori e contenitori per pila.....	215
Adattatori per cavi luce.....	340
Adenotomi.....	90, 144-146
ADLERKEUTZ pinze chirurgiche.....	248
ADSON cannule d'aspirazione.....	228
ADSON periostotomi.....	293
ADSON pinze.....	245, 247
ADSON-BROWN pinze.....	247
ADSON-GRAEFE pinze.....	247
ADSON-MICRO pinze.....	247
Aghi per paracentesi.....	30
Aghi per sutura.....	157
ALLIS pinze per tessuti.....	262
ALLIS-ADAIR pinze per tessuti.....	262
ALLIS-Baby pinze per tessuti.....	262
ALM divaricatori autostatici.....	276
ANDREW abbassalingua.....	207
Anse auricolari e uncini.....	26
Apribocca.....	216-223
ASCH pinza per il setto nasale.....	101
Assordatore.....	11
Astuccio per tracheotomia.....	186
AUFRIEHT raspe nasali.....	97
AUFRIEHT uncini nasali.....	89, 92

B	
BABCOCK pinze per tessuti.....	261
Baby CRILE-WOOD porta aghi.....	280
Baccinelle reniforme.....	311
BACKHAUS pinze fissateli.....	263
BAINBRIDGE pinze emostatiche.....	151
BALLENGER adenotomi.....	90
BALLENGER scalpelli, sgorbi.....	113
BALLENGER-HAJEK elevatori.....	110, 294
BARANY assordatore.....	11
BARBARA micro-uncini.....	57, 58
BARNHILL adenotomi.....	144
BARON cannule d'aspirazione.....	40
BARRAQUER porta aghi.....	287
BECKMANN adenotomi.....	145
BECKMANN specoli nasali.....	66
BELUCCI divaricatori autostatici.....	36
BELUCCI micro-forbici auricolari.....	51
BERNHARD pinze fissateli.....	263
BEYER concotomi auricolari.....	33
BEYER pinza sgorbia.....	301
BILLEAU anse auricolari.....	26
BINNER lampada frontale a luce fredda.....	203
BIRKET pinze emostatiche.....	151
Bisturi per naso.....	84, 85
Bisturi per tonsille.....	143
BLOHMKE pinza per tonsille.....	139
BLUMENTHAL pinze sgorbie.....	299
BÖHLER cesoie per ossa.....	302
BÖHLER pinze sgorbie.....	300
BOSE divaricatori autostatici.....	276

BOSWORTH abbassalingua.....	207
BÖTTCHER forbice per tonsille.....	150, 244
BOUCHERON specoli auricolari.....	15
BOWMAN dilatatori lacrimali.....	277
BOYS-ALLIS pinza per tessuti.....	261
BOZEMAN torcifilo.....	289
Braccio flessibile.....	17, 92
Broncoscopi.....	190, 323
BROPHY pinze chirurgiche.....	248, 250
BRUENINGS abbassalingua.....	206
BRUENINGS bisturi per naso.....	84
BRUENINGS bisturi per tonsille.....	143
BRUENINGS pinze per bronco-esofagoscopia.....	191, 192
BRUENINGS pinze taglienti per naso.....	76
BRUENINGS serranodi per tonsille.....	147
BRUENINGS specoli auricolari.....	16
BRUENINGS-BRUNK retrattore mascellare.....	100
BUCK aghi per paracentesi.....	30
BUCK bisturi per naso.....	85
BUCK curette auricolari.....	27, 28
BUCK pinza per corpi estranei.....	24

C	
CAIRNS pinze emostatiche.....	258
Cannule d'aspirazione.....	40-45
Cannule d'aspirazione per laringologia.....	168
Cannule per aspirazione e lavaggio.....	227, 228
Cannule per tonsille e setto.....	158
Cannule tracheali.....	185
CAPLAN pinza per il setto nasale.....	103
CARPENTER enucleatore.....	141
CASTROVIEJO-JACOBSON porta aghi.....	287
Cavi luce in fibra ottica.....	338, 339
Cesoie per ossa.....	302
CHADWICK forbici per enucleazione.....	243
CHEVALIER-JACKSON cannule tracheali.....	185
CHEVALIER-JACKSON pinze per bronco-esofagoscopia.....	193
CHRISTOPHE pinze emostatiche.....	256
CINELLI osteotomi.....	115
CITELLI concotomi auricolari.....	34
CITELLI pinze sfenoidali taglienti.....	135
CLAR lampade frontali.....	200, 201
CLAUS ago per sutura.....	156
CLAUS-EICKEN ago per sutura.....	156
CLOWARD-CONTOUR divaricatori autostatici.....	35
COAKLEY curette per antrum.....	105
COAKLEY trequarti.....	226
COLLER pinze emostatiche.....	258
COLLIN manico per bisturi.....	231
COLLIN martello.....	290
COLLIN pinze tirlingua.....	208
Coltelli auricolari.....	54
Coltello per trapianto.....	235
COLVER pinze per tonsille.....	138
Concotomi auricolari.....	33, 34
CONVERSE bisturi per naso.....	85
CONVERSE forbice.....	242
CONVERSE uncini tracheali e nasali.....	89
CORDES pinze per bronco-esofagoscopia.....	192
COTTLE bisturi per naso.....	84

Inhaltsverzeichnis
Index

Table des matières
Indice
Indice

COTTLE divaricatore.....273
 COTTLE elevatore per setto..... 106, 107, 127, 128, 294, 295
 COTTLE elevatori per il periostoto 110
 COTTLE forbice nasale70
 COTTLE guida per osteotomi100
 COTTLE martello62
 COTTLE osteotomi..... 114-117
 COTTLE pinza nasale.....22, 69
 COTTLE raspe nasali97
 COTTLE specoli nasali.....67
 COTTLE uncini nasali.....86, 88
 COTTLE uncini tracheali e nasali89
 COTTLE-KAZANJIAN cesoia per ossa302
 COTTLE-MASING specoli nasali.....92
 COTTLE-NEIVERT uncini nasali88
 COTTLE-WALSHAM pinze per il setto nasale 74, 101
 CRAIG pinza per polipi nasali73
 CRILE divaricatori.....273
 CRILE pinze emostatiche257
 CRILE-MURRAY porta aghi279
 CRILE-RANKIN pinze emostatiche.....257
 CRILE-WOOD porta aghi279
 Curette auricolari e cucchiari taglienti.....27-29
 Curette doppie.....291
 Curette per antrum105
 CUSHING pinze.....245

D

DANDY pinze emostatiche255
 DAVIS-BOYLE apribocca.....222
 DAY uncini auricolari25
 DE BAKEY pinze 251, 252
 DE BAKEY porta aghi.....285
 DEAN forbici per tonsille150
 DEAN-SHALLCROSS pinza emostatica154
 DENHART apribocca217
 DERF porta aghi279
 Dermatomi..... 235, 236
 DESCHAMPS aghi per sutura157
 DESMARRES divaricatori.....270
 Diagnostici, set198
 Diapason.....9-12
 DIEFFENBACH serrafine.....253
 DIETER micro-pinze auricolari47
 DIETHRICH serrafine.....253
 Dilatatori lacrimali.....277
 Dilatatori tracheali184
 DINGMANN apribocca219
 Divaricatore per cordi vocali169
 Divaricatori268-274
 Divaricatori autostatici35-38, 275, 276
 DOYEN pinza fissateli.....264
 DUEHRSSSEN pinza.....250
 DUNHILL pinze emostatiche258
 DUPUY-WEISS aghi per sutura155

E

EICKEN cannule per lavaggio227
 Elettrobisturi 346-348
 Elevatore-aspiratore.....127

Elevatori per il periostoto 110
 Elevatori per setto..... 127, 128, 294, 295
 Elevatori per setto - periostotomi106-109
 EMMET divaricatori269
 Esofagoscopio.....190, 323
 EVES serranodi per tonsille.....147

F

FARABEUF periostotomi.....293
 FARABEUF-COLLIN periostotomi.....292
 FARELL-LATHBURY portacotoni.....229
 FAULKNER curretta per antrum.....105
 FEIN portacotoni.....230
 FERGUSON cannule d'aspirazione40
 FERGUSON-ACKLAND apribocca217
 FERRIS SMITH-KERRISON pinze tagliente136
 FISCH cannula per lavaggio227
 FISCH cannule d'aspirazione.....44
 FISCH micro-raspari auricolari59
 FISCHER bisturi per tonsille143
 FISH divaricatori autostatici.....36, 38
 FOERSTER (BALLENGER) pinze per tamponi267
 FOMON bisturi per naso84
 FOMON forbice nasale.....70
 FOMON osteotomi114
 FOMON raspe nasali98
 FOMON TC raspe nasali99
 FOMON uncini nasali86, 88
 Fonte di luce fredda332-336
 Forbici fini.....242
 Forbici nasali.....70, 71, 129
 Forbici per chirurgia - Forbici per dissezione237-241
 Forbici per enucleazione243
 Forbici per fistole.....243
 Forbici per microchirurgia306
 Forbici per tonsille150, 244
 FOSTER-GILLIES porta aghi.....283
 FRAENKEL pinze per bronco-esofagoscopia192
 FRAENKEL pinze per polipi laringei180, 181
 FRAZIER cannule d'aspirazione43
 FRAZIER cannule per lavaggio228
 FREER bisturi per naso85
 FREER bisturi per tonsille.....143
 FREER elevatore per setto.....106, 108, 109, 128, 295
 FREER scalpelli, sgorbi.....113
 FRENCH diapason.....10
 FRENZEL abbassalingua206
 FRENZEL occhiali per Nistagmo204
 Frese.....296-298
 FRIEDMANN pinza sgorbia.....299
 FULLER micro-pinze auricolari47

G

GALLAHER raspe nasali98
 GEMINI pinze emostatiche260
 GERALD pinze246
 GERZOG aghi per paracentesi30
 GERZOG bisturi per naso85
 GERZOG-SEXTON coltello auricolare25
 GILLIES pinza chirurgica.....248

**Inhaltsverzeichnis
Index**
**Table des matières
Indice
Indice**

GILLIES porta aghi	283
GILLIES uncini nasali.....	87
GLATZEL specchio nasale	93
GOOD forbice per tonsille	150, 244
GROSS curette auricolari	29
GROSS-MAIER pinze per medicazione e polipi	266
GRUBER specoli auricolari	14

H	
HAJEK martello	290
HAJEK pinza sfenoidali tagliente.....	134
HAJEK-CLAUS pinza sfenoidali tagliente.....	135
HAJEK-KOFLER pinza sfenoidali tagliente	134
HALLE elevatorio per setto.....	106, 294
HALSEY porta aghi.....	281
HALSTED-MOSQUITO pinze emostatiche	254
HARTMANN abbassalingua	207
HARTMANN diapason	9, 11
HARTMANN pinza per polipi auricolari	24
HARTMANN pinze auricolari.....	46
HARTMANN pinze emostatiche	254
HARTMANN pinze per polipi nasali.....	71
HARTMANN pinze taglienti per naso	82
HARTMANN sonde auricolari	18
HARTMANN specoli auricolari.....	15
HARTMANN tonsillotomi	140
HARTMANN-HALLE specoli nasali	64
HARTMANN-NOYES pinze auricolari.....	46
HARTMANN-WEINGÄRTNER pinze auricolari.....	46
HARTMANN-WULLSTEIN pinze auricolari	46
HEANEY porta aghi	284
HEERMAN micro scalpelli per orecchio.....	62
HEGAR-BAUMGARTNER porta aghi	280
HEISS pinze emostatiche	153
HEISTER apribocca.....	216
HENKE dissettori tonsillari	142
HENKE pinza tagliente per naso.....	77, 129
HEUWIESER pinza antrum	133
HEYMANN forbice nasale.....	70
HEYMANN pinze per polipi nasali.....	73
HEYMANN-KNIGHT pinza per polipi nasali	73
HOLINGER laringoscopi	162
HOLTZHEIMER divaricatori autostatici.....	276
HOUSE adattatore.....	42
HOUSE cannule d'aspirazione	40, 42
HOUSE micro-cucchiai auricolari	60, 61
HOUSE sonda per misurare.....	53
HUBER manico universale	191
HUMBY dermatomo	236
HURD aghi per sutura	155
HURD dissettoressa tonsillare.....	142

I	
IOWA cannule d'aspirazione.....	41
ITERSON uncini nasali.....	87

J	
JACKSON laringoscopi	162
JACKSON pinza laringea	138
JACKSON uncini tracheali.....	184, 268

JACKSON uncini tracheali e nasali.....	89
JACOBSON micro porta aghi	308
JANSEN (GRUENWALD) pinza nasale e auricolare	23, 68
JANSEN cucchiai taglienti	29
JANSEN divaricatori autostatici	276
JENNINGS apribocca	216
JOHNS HOPKINS serrafine.....	253
JONES pinze fissateli.....	264
JOPSON-HORNE portacotoni.....	230
JOSEPH bisturi per naso.....	84
JOSEPH elevatorio per setto.....	106, 294
JOSEPH seghe nasali.....	96
JOSEPH uncini nasali.....	86, 87
JOSEPH-MASING elevatorio per setto	109
JUDD-ALLIS pinze per tessuti.....	261
JURASZ pinza naso-faringea.....	140
JURASZ pinze per polipi laringei	180, 181

K	
KABIERSKE soffiatori.....	21
KAHN-FRAZIER cannule d'aspirazione.....	44
KELLY forbici per fistole	243
KELLY pinze emostatiche	257
KELLY-RANKIN pinze emostatiche.....	257
KERRISON concotomi auricolari.....	34
KERRISON pinze sfenoidali taglienti.....	135
KILIAN elevatori per setto	108
KILIAN forbici laringee	179
KILIAN scalpello.....	114
KILIAN sonde auricolari.....	127
KILIAN specoli nasali.....	65
KILIAN-CLAUS scalpello.....	114
KILNER divaricatori	272
KILNER porta aghi	284
KILNER uncini nasali	86
KILNER uncini tracheali e nasali.....	89
KILNER-DOUGHTY apribocca	220
KNAPP (ROLLET) divaricatori.....	270
KNIGHT pinza per polipi nasali	73
KOCHER divaricatori	271
KOCHER pinze emostatiche	258
KOCHER sonde per gozzo	187, 224
KOCHER-LANGENBECK (OBWEGESER) divaricatori.....	274
KRAUSE pinze per bronco-esofagoscopia	192
KRAUSE serratodi auricolari	32
KRAUSE serratodi nasali	91
KRAUSE trequarti.....	226
KRAUSE-VOSS serratodi auricolari	32
KRAUSE-VOSS serratodi nasali	91
KROENIG abbassalingua	206

L	
LA FORCE adenotomi.....	146
LABORDE dilatatori tracheali	184
LAHEY pinze per gozzo.....	187, 224
LAMBOTTE periostotomi	293
Lame per bisturi.....	233
Lampada frontale a luce fredda	203
Lampada frontale micro LED.....	202
Lampade frontali.....	200-202

Inhaltsverzeichnis
Index

Table des matières
Indice
Indice

LANDAU trequarti	226
LANDOLDT forbici per enucleazione	243
LANE pinze fissateli	265
LANGE pinze per bronco-esofagoscopia	192
LANGE uncini nasali	86
LANGENBECK curette auricolari	29
LANGENBECK divaricatori	274
LANGE-WILDE serranodi auricolari	32
LANGE-WILDE serranodi nasali	91
Laringoscopi – luce calda	209, 210
Laringoscopi – luce fredda	212, 213
Laringoscopi (ottiche)	160, 161, 321
Laringoscopi per intervento chirurgico	163, 164
LAZAR pinze per micro-suture	307
LEMPERT elevatori per setto	106
LEMPERT raspari auricolari	31
Lente binoculare	205
LERICHE pinze emostatiche	256
LEWIS fissa tonsille	139
LEXER-BABY forbici	242
LITAUER pinza per polipi auricolari	24
LITAUER pinza per polipi nasali	73
LITTLEWOOD pinza per tessuti	261
LOCKWOOD pinza per tessuti	262
LORNA pinze fissateli	264
LOVE divaricatori per ugola	218
LOVELACE pinze emostatiche	256
LUBET-BARBON pinza per polipi nasali	71
LUC pinze taglienti per naso	75, 104
LUCAE aghi per paracentesi	30
LUCAE diapason	10
LUCAE martello	111
LUCAE pinze auricolari e nasali	23, 68
LUCAE uncini auricolari	26
LUER divaricatori	268
LUER STANDRAD cannule tracheali	185
LUER-LOCK cannule per lavaggio	227
LUER-LOCK siringhe	158
LUKENS uncini tracheali e nasali	89
LUNIATSCHEK porta tamponi	141

M

MAGILL cannule d'aspirazione	41
MAGILL pinze per catetere	225
MAIER pinze per medicazione e polipi	266
MALTZ raspe nasali	97, 98
Manici per bisturi	231, 232
Manici per laringoscopi – luce calda	211
Manici per laringoscopi – luce fredda	214
Manici per sinuscopi	126
MANNERFELDT modificato scalpelli, sgorbi	113
MARQUARDT pinza sgorbia	300
MARSHIK pinza per tonsille	139
Martelli	111, 290
MASING elevatore per periosto	110
MASING elevatore per setto	128
MASTIN pinza per gozzo	187, 224
MATHIEU-OLSEN porta aghi	280
MAUNDER apribocca	216
MAYO abbassalingua	206

MAYO-HEGAR porta aghi	282
MC INDOE pinze	245
MC INTOSH laringoscopi	209, 212
MCGEE micro-pinze auricolari	47
MCGEE micro-uncini auricolari	58
MCIVOR apribocca	223
MCKENTY elevatori per setto	107
MEAD martello	290
METZENBAUM FINO forbici per dissezione	241
METZENBAUM forbici per dissezione	239
METZENBAUM-NELSON forbici per dissezione	240
MICHEL specchi laringei	178
Micro laringoscopi	161, 322
Micro porta aghi	308
Micro porta aghi con manico rotondo	305
Micro scalpelli per orecchio e martelli	62
MICRO-ADSON pinze	245
Micro-cucchiai auricolari	60, 61
Micro-forbici auricolari	51, 52
Micro-forbici per dissezione	303
Micro-lame	234
MICRO-MOSQUITO pinze emostatiche	255
Micro-pinze auricolari	47, 48
Micro-pinze auricolari a cucchiaio	49, 50
Micro-raspari auricolari	59
Micro-raspari e sonde auricolari	53
Micro-strumenti per laringo-bronco-esofagoscopia	194-196
Micro-strumenti per laringologia	169-177
Micro-uncini ed aghi auricolari	57, 58
MIDDLETON-JANSEN pinze per il setto nasale	102
MILLER laringoscopi	210, 213
MILLIGAN divaricatori autostatici	35
Mini CLAR lampada frontale	200
Mini FRIEDMANN pinza sgorbia	299
Mini GEMINI pinze emostatiche	260
Mini LAMBOTTE scalpelli, sgorbi	112
Mini LANGENBECK divaricatori	271
Mini LEXER scalpelli, sgorbi	112
Mini MCGEE micro-pinze auricolari	48
Mini RYDER porta aghi	286
Mod. MARTIN portacotoni	229
Mod. WIEN portalegature	289
Mod. WIEN specoli nasali	66
MOLLISON divaricatori autostatici	36
MOLT apribocca	217
MOSQUITO-DANDY pinza emostatica	255
MUCK coltelli auricolari	25
MUSEUX pinza per tonsille	138
MYLES pinze taglienti per naso	82

N

NAGER retrattori per velo palatino	218
Nasofaringoscopia flessibile	94, 324
NEGUS apribocca	221
NEGUS pinze emostatiche	154
NEIVERT porta aghi	284
NEIVERT uncini nasali	88
NEIVERT-ANDERSON scalpelli	118
NIJMEGEN cannule d'aspirazione	42
NOYES pinza per tamponamento nasale	72

**Inhaltsverzeichnis
Index**
**Table des matières
Indice**

O	
OBWEGESER forbice per dorso nasale	102
OBWEGESER pinze per il setto nasale	102, 103
Occhiali per Nistagmo.....	204
OLSEN-HEGAR porta aghi	281
Osteotomi per plastica nasale.....	114-118
Otoscopi	320
Ottiche mini	319
OVERHOLT-GEISSENDOERFER pinze emostatiche.....	259

P	
PARTSCH martello	111
PÉAN pinze emostatiche	258
PEERS-BERTRAM pinza fissatelli.....	265
PELTESON portacotoni.....	230
PENNINGTON elevatore per setto	109
Periostotomi- Elevatori	292, 293
PIERCE trequarti	226
Pinza a taglio circolare	132
Pinza per tamponamento nasale	72
Pinze	136
Pinze anatomiche.....	245-250
Pinze antrum.....	133
Pinze auricolari	46
Pinze auricolari e nasali	22, 23, 68, 69
Pinze chirurgiche	245, 247, 248
Pinze emostatiche.....	151-153, 254-258
Pinze fissateli	263-265
Pinze per bronco-esofagoscopia	191-193
Pinze per catetere	225
Pinze per dissezione atraumatiche.....	251, 252
Pinze per gozzo	187, 224
Pinze per il setto nasale	74, 101-103
Pinze per medicazione e polipi.....	266
Pinze per microchirurgia	304
Pinze per micro-suture.....	307
Pinze per polipi auricolari.....	24
Pinze per polipi laringei.....	180, 181
Pinze per polipi nasali - Pinze per il setto nasale	71-73
Pinze per preparazioni e suture.....	154, 259, 260
Pinze per tamponi	267
Pinze per tessuti ed intestinali	261, 262
Pinze sfenoidali taglienti	134, 135
Pinze sgorbie	299-301
Pinze taglienti per naso	75-83, 104, 129-131
Pinze tiralingua	208
PLESTER cannule per lavaggio	228
PLESTER coltello per stacci, coltello rotondo	54
PLESTER divaricatori autostatici	37
PLESTER micro-raspatori auricolari.....	53
PLESTER uncino per placca di piede	57
POLITZER aghi per paracentesi	30
POLITZER soffiatori	20
POLITZER specoli auricolari	14
Porta aghi	279-288
Porta luce con fibra ottica.....	165
Porta micro-lame	234
Portacotoni	229, 230
POTTS-SMITH pinze chirurgiche.....	248
Power LED lampada frontale.....	201

PRATT curretta per antrum	105
PRINCE forbice per tonsille	150
PROVIDENCE HOSPITAL pinze emostatiche	255

Q	
QUIRE leva per corpi estranei	24

R	
RAGNELL-DAVIS divaricatori.....	273
Raspatori auricolari	31
Raspe con tungsteno	99
Raspe nasali.....	97, 98
REICHERT strumento laringeo	179
RICHNAU-HOLMGREN specoli auricolari.....	13
RITTER-HALLE dilatatore per il seno frontale.....	100
ROBIN pinza fissateli	264
ROEDER pinze fissateli	263
ROSE divaricatori	268
ROSEN cannule d'aspirazione	41
ROSEN coltelli auricolari	54
ROSEN frese	297, 298
ROSEN micro aghi auricolari	58
ROSEN raspatori auricolari.....	31
ROSER-KÖNIG apribocca.....	217
ROTTER aghi per sutura	156
RUBIN pinza per il setto nasale	103
RUBIN scalpelli	116
RUSKIN pinze sgorbie	301
RUSKIN-LISTON cesoie per ossa.....	302
RYDEL-SEIFFER diapason	10
RYDER porta aghi.....	286

S	
SAILER forbice nasale	70
SANVENERO forbici	242
SAROT porta aghi.....	284
Scalpelli per plastica nasale.....	114-118
Scalpelli, sgorbi.....	112, 113
Scatole per sterilizzazione.....	309
SCHAEDEL pinza fisatelli.....	264
SCH EINMANN pinze per bronco-esofagoscopia	192
SCHINK dermatomo.....	235
SCHMEDEN pinze taglienti per naso	77, 129
SCHMIEDEN ago per sutura	156
SCHNIDT pinze emostatiche	152
SCHOENBORN divaricatori.....	268
SCHUHKNECHT coltello rotondo.....	54
SCHWARZ specoli nasali	65
Scodelle	311
Seghe nasali	96
SEIFFERT pinze per bronco-esofagoscopia.....	192
SEMKEN pinze	245
SENN-GREEN divaricatori.....	273
SENN-MILLER divaricatori	272
Serrafine	253
Serranodi auricolari	32
Serranodi nasali	91
Serranodi per tonsille.....	147, 148
Set di strumenti	349-359
SEWALL elevatore per setto	106

Inhaltsverzeichnis Index

Table des matières Indice Indice

SHAMBAUGH micro aghi auricolari	57, 58
SHEA micro-cucchiai auricolari	60
SHEEHAN scalpelli	117
SIEGLE specoli auricolari	16
SILVER dermatomo	236
SILVER scalpelli	118
SINUS trequarti	126
Sinuscopi	125, 319
Siringhe auricolari	19
SLUDER-BALLENGER tonsillotomi	149
Soffiatori	20, 21, 93
Sonde auricolari	18, 19, 127
Sonde per gozzo	187, 224
Specchi frontali	199
Specchi laringei	178
Specchio nasale	93
Specoli auricolari	13-16
Specoli nasali	64-68
ST. CLAIR - THOMSON adenotomi	144
Standard forbici	237
STERNBERG divaricatori per guancia	218
STRANDELL-STILLE divaricatori	273
STRUEMPEL pinze auricolari	46
Strumenti per laringologia	166, 167, 179
Strumenti per micro-chirurgia auricolare	55, 56
Strumenti per sutura	155, 156, 289
Strumenti per tonsille	138-148
STRUYCKEN pinze taglienti per naso	77, 129

T

TAKAHASHI pinze taglienti per naso	75
TAYLOR pinze	246
Telecamera	326-331
TERRIER pinza emostatica	254
THIERSCH dermatomo	235
THOMS-ALLIS pinza per tessuti	262
TIECK-HALLE specoli nasali	64
TILLEY pinza per polipi	72
TOBOLD abbassalingua	207
TOENNIS pinze emostatiche	152
TOHOKU-JAPAN pinze fissateli	265
TOMATI pinza tagliente per naso	77, 129
Tonsillotomi	149
TOYNBEE specoli auricolari	13
Trequarti	126, 226
TROELTSCH (WILDE) pinze auricolari e nasali	22, 69
TROELTSCH pinze auricolari e nasali	22, 69
TROELTSCH sonde auricolari	19
TROUSSEAU dilatatori tracheali	184
TYDING serranodi per tonsille	148

U

UCKERMANN trequarti tracheali	185
ULRICH pinze per medicazione e polipi	266
Uncini auricolari e coltelli	25
Uncini nasali	86-89
Uncini tracheali	89, 184, 268
UNIVERSAL soffiatori	93

V

VERHOEVEN cannule d'aspirazione	42
VOLKMANN cucciaio	291
VOLKMANN divaricatori	272
VOLTOLINI specoli nasali	68

W

WAGENER uncini auricolari	26
WALTER scalpelli	117
WANGENSTEEN pinze	247
WATSON dermatomo	236
WATSON-WILIAMS pinze taglienti per naso	76
WAUGH pinze	247
WEBSTER porta aghi	280
WEIL pinze tagliente per naso	76
WEIL-BLAKESLEY pinze taglienti per naso	82
WEITLANER-LOKTITE divaricatori autostatici	275
WEITLANER-WULLSTEIN divaricatori autostatici	35
WESTMCOTT pinze per polipi nasale	71
WHITE pinze per tonsille	138
WHITEHEAD apribocca	216
WIEDER abbassalingua	207
WIENER raspe nasali	98
WILLIAMS pinza per tessuti	262
WILLIGER divaricatori	38
WILLIGER periostotomi	292
WULLSTEIN divaricatori autostatici	35
WULLSTEIN micro-forbici auricolari	52
WULLSTEIN raspatori auricolari	31

Y

YANKAUER cannula per aspirazione	227
YOUNG pinze tiralingua	208

Z

ZAUFAL-JANSEN pinza sgorbia	300
ZIEGLER specchi frontali	199
ZÖLLNER cannule d'aspirazione	41
ZÖLLNER specoli auricolari	14
ZÖLLNER strumenti per micro-chirurgia auricolare	54-56

Wichtige Hinweise

Dieser Katalog bleibt Eigentum der Firma TEKNO-MEDICAL Optik-Chirurgie GmbH & Co. KG, auch wenn dafür eine Schutzgebühr bezahlt wurde. Er kann von uns jederzeit zurückgefordert werden, wenn er gegen unsere Interessen und nicht zum Vertrieb und Einkauf von TEKNO Produkten verwendet wird. Auch behalten wir uns in solch einem Falle weitergehende Maßnahmen vor.

Der Nachdruck oder Kopieren dieses Kataloges – im Gesamten oder auch nur auszugsweise – ist ohne unsere schriftliche Genehmigung verboten.

Modelländerungen vorbehalten. Gedruckt in der Bundesrepublik Deutschland

Important notice

This catalogue remains property of TEKNO-MEDICAL Optik-Chirurgie GmbH & Co. KG even if we have asked for a lending fee of charges. We can at any time recall the catalogue, in case that it has been not used according to our interests, i.e. sale or purchase of TEKNO products. We preserve the right for further steps in that case.

Reproduction or copying of this catalogue in whole or in parts is forbidden without our written permission.

Patterns are subject to change. Printed in Germany

Indications importantes

Ce catalogue reste la propriété de TEKNO-MEDICAL Optik-Chirurgie GmbH & Co. KG, même si nous avons demandé le paiement d'une taxe de protection. Nous pouvons demander le retour du catalogue dans le cas où celui-ci n'est pas utilisé conformément à nos intérêts, pour la vente ou l'achat de nos produits. Dans ce cas nous nous réservons le droits de mener des actions juridiques.

La reproduction ou la copie totale ou partielle de ce catalogue est interdite sans notre accord écrit.

Sous réserve des modifications techniques. Imprimé en Allemagne

Avisos importantes

Este catálogo es propiedad de TEKNO-MEDICAL Optik-Chirurgie GmbH & Co. KG, aún en el caso de haber abonado por él una tasa de colaboración. Podemos solicitar la devolución del catálogo en caso de que no sea utilizado para la compra o venta de nuestros productos. En este caso nos reservamos el derecho de tomar medidas jurídicas.

La reproducción o copia total o parcial de este catálogo esta prohibido sin nuestro consentimiento escrito.

Salvo modificaciones técnicas. Impreso en la República Federal de Alemania

Avvertenze importanti

Questo catalogo rimane proprietà della TEKNO-MEDICAL Optik-Chirurgie GmbH & Co. KG, anche se è stato rilasciato gratuitamente o contro pagamento. Possiamo in ogni momento richiederlo indietro, in caso non stato usato in accordo con i nostri interessi (acquisto e vendita dei prodotti TEKNO-Medical). Ci riserviamo in questo caso il diritto di prendere ulteriori provvedimenti.

La copia o la riproduzione di questo catalogo in parte o nella sua totalità è vietata senza il nostro permesso scritto.

Ci riserviamo la facoltà di cambiamenti nei modelli. Stampato nella R. F. T.

MM - INCH

6 mm	¼"
12 mm	½"
19 mm	¾"
25 mm	1"
32 mm	1¼"
38 mm	1½"
45 mm	1¾"
51 mm	2"
57 mm	2¼"
64 mm	2½"
70 mm	2¾"
76 mm	3"
86 mm	3¼"
89 mm	3½"
95 mm	3¾"
102 mm	4"
108 mm	4¼"
114 mm	4½"
121 mm	4¾"
127 mm	5"
140 mm	5½"
152 mm	6"
165 mm	6½"
178 mm	7"
191 mm	7½"
203 mm	8"
216 mm	8½"
229 mm	9"
241 mm	9½"
254 mm	10"
267 mm	10½"
279 mm	11"
292 mm	11½"
305 mm	12"

MM - CHARRIÈRE

2 mm	6
2⅔ mm	8
3⅓ mm	10
3⅔ mm	11
4 mm	12
4⅓ mm	13
4⅔ mm	14
5 mm	15
5⅓ mm	16
5⅔ mm	17
6 mm	18
6⅓ mm	19
6⅔ mm	20
7 mm	21
7⅓ mm	22
7⅔ mm	23
8 mm	24
8⅓ mm	25
8⅔ mm	26
9 mm	27
9⅓ mm	28
9⅔ mm	29
10 mm	30
10⅔ mm	32
11⅓ mm	34
12 mm	36

MM



INCH





TEKNO-MEDICAL Optik-Chirurgie GmbH

Sattlerstrasse 11 · 78532 Tuttlingen, Germany
Telefon +49 (74 61) 1701-0 · Fax +49 (74 61) 1701-50
mail@tekno-medical.com · www.tekno-medical.com

© Copyright 10.2009 - **TEKNO-MEDICAL** Optik-Chirurgie GmbH
TEKNO is a registered trademark of **TEKNO-MEDICAL** Optik-Chirurgie GmbH