



ENDOSCOPY
UROLOGY



Urologie | Urologie
Urology | Urología
Urologia

Katalog
Catalogue
Catalogue
Catálogo
Catalogo

No. **208**

**Kataloge
Catalogues**

**Catalogues
Catálogos
Cataloghi**

SURGERY



Hauptkatalog Chirurgie
Main catalogue surgery
Catalogue général
Catálogo general
Catalogo generale

No. 111



Plastische Chirurgie
Plastic surgery
Chirurgie plastique
Cirugía plástica
Chirurgia plastica

No. 112



Ophthalmologie
Ophthalmology
Ophtalmologie
Oftalmologia
Oftalmologia

No. 113



Traumatologie
Traumatology
Traumatologie
Traumatologia
Traumatologia

No. 114



Gefäßchirurgie
Vascular surgery
Chirurgie vasculaire
Cirugía vascular
Chirurgia vascolare

No. 115



Retraktor Systeme
Retractor systems
Systèmes des écarteurs
Sistema de retractores
Sistemi di retrattori

No. 133



Aneurismen Clips
Aneurysm clips
Clips pour anévrismes
Clips para aneurismas
Clips per aneurismi

No. 134



HNO Hauptkatalog
ENT main catalogue
ORL catalogue général
ORL catálogo general
ORL catalogo generale

No. 501

CONTAINER

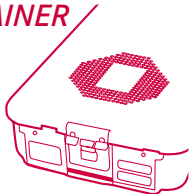

Container I
Container I
Contenaires I
Contenedores I
Container I

No. 302



Container II
Container II
Contenaires II
Contenedores II
Container II

No. 303

OR LIGHTS

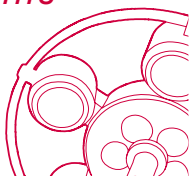

ATRIA 1
ATRIA 1
ATRIA 1
ATRIA 1
ATRIA 1

No. 701



ATRIA 2
ATRIA 2
ATRIA 2
ATRIA 2
ATRIA 2

No. 702



ATRIA 3
ATRIA 3
ATRIA 3
ATRIA 3
ATRIA 3

No. 703



ATRIA 5
ATRIA 5
ATRIA 5
ATRIA 5
ATRIA 5

No. 704



ATRIA 7
ATRIA 7
ATRIA 7
ATRIA 7
ATRIA 7

No. 705

Kataloge
Catalogues

Catalogues
Catálogos
Cataloghi

ENDOSCOPY

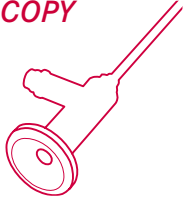

Geräte
Units
Appareils
Equipos
Apparecchi

No. 205

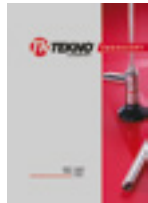

Optiken
Scopes
Optiques
Ópticas
Ottiche

No. 206



Laparoskopie
Laparoscopy
Laparoscopia
Laparoscopia
Laparoscopia

No. 207



Urologie
Urology
Urologie
Urología
Urologia

No. 208



Gynäkologie
Gynaecology
Gynécologie
Ginecología
Ginecologia

No. 209



Arthroskopie
Arthroscopy
Arthroscopie
Artroscopia
Artroscopia

No. 210

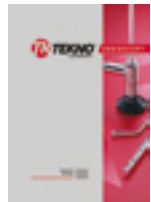

Sinuskopie
Sinuscopy
Sinuscopie
Sinuscopia
Sinuscopia

No. 211



Mini & Mikro System für MIC
Mini & micro system for MIS
Système mini & mikro pour MIC
Sistema mini y micro para MIC
Sistema mini e micro per MIC

No. 213

ELECTRO SURGERY

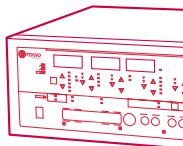

Elektro Chirurgie
Electro surgery
Électrochirurgie
Electro-Cirurgia
Elettrobisturi

No. 212

DENTAL



Dental
Dental
Dentaire
Dental
Dentale

No. 402

OR TABLES

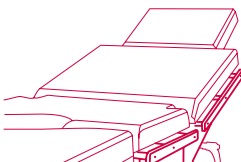

VECTOR 1
VECTOR 1
VECTOR 1
VECTOR 1
VECTOR 1

No. 601



VECTOR 3
VECTOR 3
VECTOR 3
VECTOR 3
VECTOR 3

No. 602



VECTOR 5
VECTOR 5
VECTOR 5
VECTOR 5
VECTOR 5

No. 603



Zubehör
Accessories
Accessoires
Accesorios
Accessori

No. 610

	<p>Zystoskopie <i>Cystoscopy</i> Cystoscopie <i>Cistoscopia</i> Cistoscopia</p>	<p>7-23</p>
	<p>Laser-Zystoskop-Urethroskop Schäfte <i>Laser-cystoscopy-urethroscope sheaths</i> Gains pour cystoscopie-uretroscopie à laser <i>Vainas para cistoscopia-uretroscopia de laser</i> Camicie per laser-cistoscopia-uretroscopia</p>	<p>24</p>
	<p>Resektoskopie, monopolar <i>Resectoscopy, monopolar</i> Résectoscopie, monopolaire <i>Resectoscopia, monopolare</i> Resettoscopia, monopolare</p>	<p>25-35</p>
	<p>Resektoskopie, bipolar <i>Resectoscopy, bipolar</i> Résectoscopie, bipolaire <i>Resectoscopia, bipolare</i> Resettoscopia, bipolare</p>	<p>36-46</p>
	<p>Laser Resektoskop Arbeitselement <i>Laser resectoscope working element</i> Élément de travail pour laser <i>Elemento de trabajo para laser</i> Elemento operativo per resettoscopia laser</p>	<p>47-49</p>
	<p>Urethrotomie <i>Urethrotomy</i> Urétrotomie <i>Uretrótomia</i> Uretrotomia</p>	<p>50-56</p>
	<p>Uretero-Renoskopie <i>Uretero-renaloscopy</i> Uretero-rénoscopie <i>Uretero-renaloscopia</i> Uretero-renaloscopia</p>	<p>57-58</p>
	<p>Mini Nephroskopie <i>Mini nephroscopy</i> Néphroscopie mini <i>Nefroscopia mini</i> Nefroscopia mini</p>	<p>59-62</p>

Inhalt	Contenu
Content	Indice
	Indice



9

Perkutane Nephroskopie
Percutaneous nephroscopy
 Néphroscopie percutane
Nefroscopia percutanea
 Nefroscopia percutanea

63-66

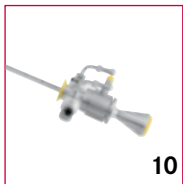

10

Pädiatrische Zystoskopie
Pediatric cystoscopy
 Cystoscopie pédiatrique
Cistoscopia pediátrica
 Cistoscopia pediatrica

67-71



11

Pädiatrische Resektoskopie
Pediatric resectoscopy
 Resectoscopie pédiatrique
Resectoscopia pediátrica
 Resettoscopia pediatrica

72-74

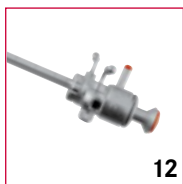

12

Pädiatrische Urethrotomie
Pediatric urethrotomy
 Urétrotomie pédiatrique
Uretrótomia pediátrica
 Uretrotomia pediatrica

75-78



13

Zubehör
Accessories
 Accessoires
Accesorios
 Accessori

79-90

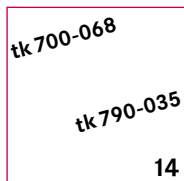

14

tk 700-068

tk 790-035

Nummernverzeichnis
Numerical index
 Index numérique
Indice numerico
 Indice dei numeri d'articolo

91-93

TEKNO-FLEX

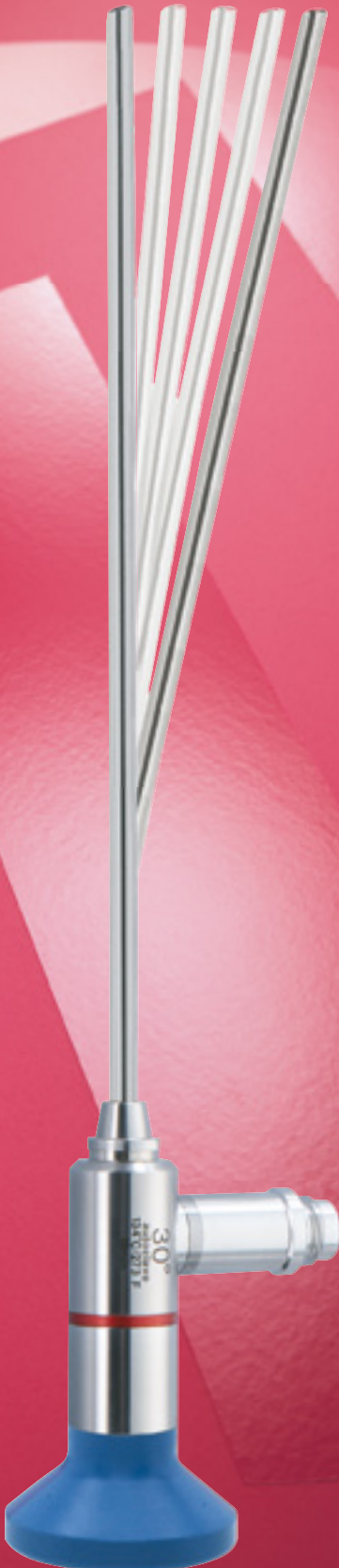

Die Vorteile von Tekno-Flex Endoskope (patentiert):

- weniger anfällig gegen äußere mechanische Einwirkungen, wie Verbiegen
- höhere Flexibilität im Vergleich zu Standard Endoskopen
- höhere Widerstandsfähigkeit (70% aller Reparaturen basieren auf gebrochenen Stablinsen, verursacht durch gebogene Schäfte)
- kratzsicheres Saphirglas am distalen Ende und am Okular
- korrekte Farbwiedergabe und gleichmäßige Bildschärfe
- 1 Jahr Garantie auf gebrochene Stablinsen
- Tekno-Flex Optiken sind durch den Zusatz "SF" gekennzeichnet

The advantages of Tekno-Flex endoscopes (patented):

- *the optical system is less sensitive to bending*
- *higher flexibility compared to standard rigid endoscopes*
- *higher robustness (70% of all repairing is due to broken rod-lenses caused by bent tubes)*
- *scratch-proof saphire glass on the distal end and ocular side*
- *high resolution and contrast reproduction*
- *1 year warranty against broken rod-lenses*
- *Tekno-Flex scopes can be recognized by the suffix "SF"*

Les avantages des endoscopes Tekno-Flex (brevetés):

- haute résistance contre influences mécaniques
- meilleure souplesse comparé avec des endoscopes rigides
- meilleure résistance (70% de toutes réparations sont provoquées par des ruptures des lentilles cylindriques)
- verres distales et proximales en saphir
- reproduction parfaite des couleurs et profondeur de champ exceptionnel
- 1 an de garantie sur ruptures des lentilles cylindriques
- les optiques Teko-Flex peuvent être reconnues par l'annexe "SF"

Las ventajas de los endoscopios Tekno-Flex (patentados):

- *gran resistencia al estrés mecánico*
- *mayor flexibilidad en comparación a ópticas tradicionales*
- *mayor resistencia (70% de todas las reparaciones son debidas a roturas de lentes cilíndricas)*
- *las lentes distales y proximales son de zafiro de alta resistencia*
- *perfecta reproducción de color y extraordinaria profundidad de campo*
- *1 año de garantía sobre roturas de lentes cilíndricas*
- *las opticas Tekno-Flex son reconocidos por el anexo "SF"*

I vantaggi degli endoscopi Tekno-Flex (brevettato):

- maggiore resistenza contro stress meccanico
- accetta una grande flessione rispetto ad ottiche tradizionali
- elevata robustezza (70% di tutte le riparazioni é dovuto a rotture delle rod-lenses)
- lenti distale e prossimale in zaffiro ad alta resistenza
- perfetta riproduzione dei colori e immagine a fuoco a tutto campo
- 1 anno di garanzia su rottura delle rod-lens
- le ottiche Tekno-Flex hanno un numero d'articolo con "SF" aggiunto

Systemübersicht
System overview

 Aperçu général du système
 Vista general del sistema
 Visione sul sistema

 Symbole und Besonderheiten, Cystoskopie
 Symbols and characteristics, cystoscopy

 Symboles et caractéristiques, cystoscopie
 Símbolos y características, cistoscopia
 Simboli e caratteristiche, cistoscopia

 Auch mit Plastikhähnen lieferbar
 Also available with plastic stopcocks

 Aussi disponible avec robinets en plastique
 También disponible con llaves en plastica
 Anche disponibili con rubinetto in plastica

 Farberkennung für jeweilige Charr.
 Colour code for respective Charr.

 Marquage en couleur pour Charr. respectives
 Identificación de color para cada Charr.
 Identificazione a colori per i relativi Charr.

15 Charr.	■
17 Charr.	■
19 Charr.	■
21 Charr.	■
23 Charr.	■
25 Charr.	■

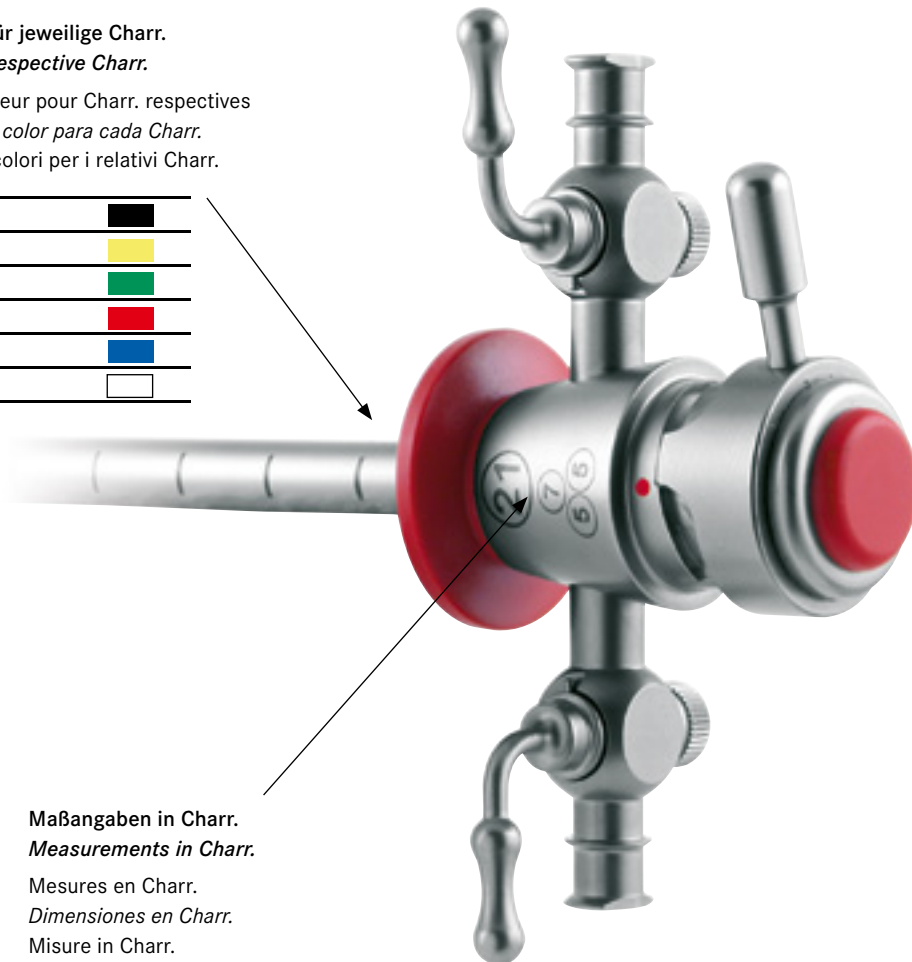
 Maßangaben in Charr.
 Measurements in Charr.
 Mesures en Charr.
 Dimensiones en Charr.
 Misure in Charr.

Systemübersicht
System overview

Aperçu général du système
Vista general del sistema
Visione sul sistema

15 Charr.	■
17 Charr.	■
19 Charr.	■
21 Charr.	■
23 Charr.	■
25 Charr.	□

■ tk 790-015
 ■ tk 790-017
 ■ tk 790-019
 ■ tk 790-021
 ■ tk 790-023
 □ tk 790-025
 ■ tk 790-037

tk 790-100 ■ ■ □
 tk 790-102 ■ ■ □
 tk 790-104 ■ ■ □
 tk 790-106 ■ ■ □
 tk 790-110 ■ ■ □
 tk 790-120 ■ ■ □
 tk 790-139 ■ ■ □
 tk 790-112 □

Visual obturators for 30° endoscopes only

■ tk 794-040
 ■ tk 794-041
 ■ tk 794-042
 ■ tk 794-043
 □ tk 794-044

■ tk 790-052
 ■ ■ ■ ■ □ tk 790-050
 ■ tk 790-053
 ■ ■ ■ ■ □ tk 790-055

■ tk 790-046
 ■ ■ ■ ■ □ tk 790-040
 ■ tk 790-047
 ■ ■ ■ ■ □ tk 790-042
 ■ tk 790-048
 ■ ■ ■ ■ □ tk 790-044

Systemübersicht
System overview

Aperçu général d'instrument
Vista general del sistema
Visione sul sistema

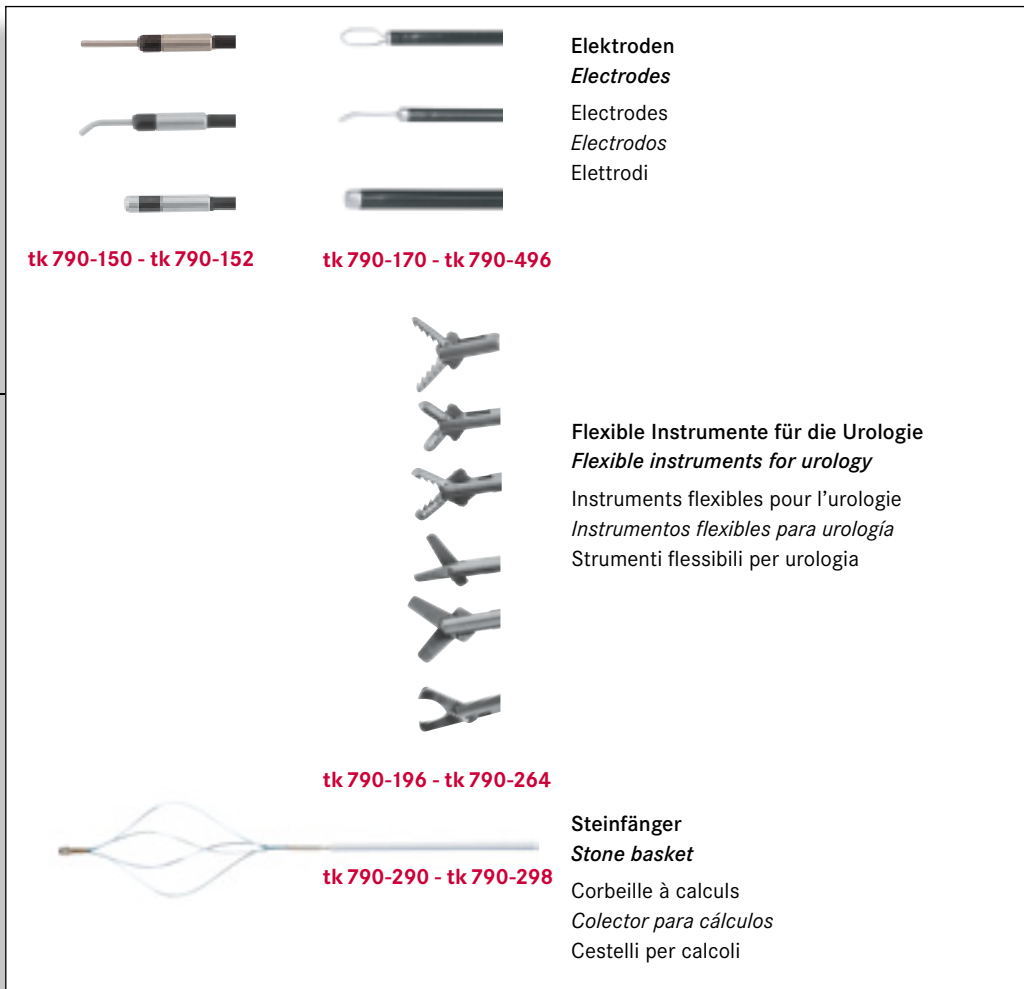
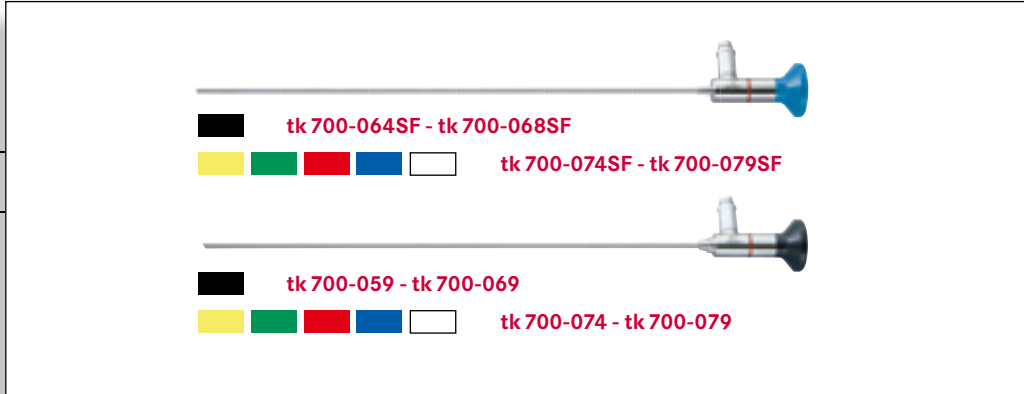

Optiken | Optiques
 Scopes | Ópticas
 Ottiche

autoklavierbar / autoclavable
 134°C / 273°F - 18 min.

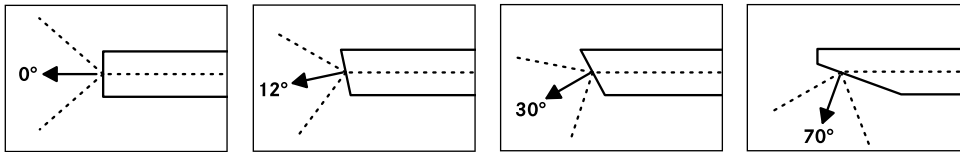

Ø 2.7 mm - 302 mm	tk 700-064	tk 700-065	tk 700-068	tk 700-069
Ø 2.9 mm - 302 mm	tk 700-059	tk 700-061	tk 700-066	-
Ø 4.0 mm - 302 mm	tk 700-074	tk 700-075	tk 700-078	tk 700-079
Ø 2.7 mm - 302 mm	tk 700-064SF	tk 700-065SF	tk 700-068SF	-
Ø 4.0 mm - 302 mm	tk 700-074SF	tk 700-075SF	tk 700-078SF	tk 700-079SF

Arbeitslänge

Working length

Longueur de travail

Longitud de trabajo

Lunghezza operativa

SF = Tekno-Flex

Zystoskop-Urethroskop Schäfte Cystoscope-urethroscope sheaths

Gaines pour cystoscopie-uretroscopie
Vainas para cistoscopia-uretroscopia
Camicie per cistoscopia-uretroscopia



15 Charr. System abweichend von Abbildung

15 Charr. system, different from picture

15 Charr. système, différent à la photo

15 Charr. sistema, differente del photo

15 Charr. sistema different da quello raffigurato



15 Charr.	Quick Lock	Ø 2.7 mm / 2.9 mm	tk 790-015	tk 790-515	tk 790-615
17 Charr.		Ø 4.0 mm	tk 790-017	tk 790-517	tk 790-617
19 Charr.		Ø 4.0 mm	tk 790-019	tk 790-519	tk 790-619
21 Charr.		Ø 4.0 mm	tk 790-021	tk 790-521	tk 790-621
23 Charr.		Ø 4.0 mm	tk 790-023	tk 790-523	tk 790-623
25 Charr.		Ø 4.0 mm	tk 790-025	tk 790-525	tk 790-625

für Optiken
for scopes

pour optiques
para ópticas
per ottiche

komplett
complete

complet
completo
completo

Schaft alleine
Sheath only

Gaine seule
Vaina sola
Camicia sola

Obturator alleine
Obturator only

Obturateur seule
Obturator solo
Otturatore solo



17 Charr.		Ø 4.0 mm	tk 790-037	tk 790-537	tk 790-627
		für Optiken for scopes	komplett complete	Schaft alleine Sheath only	Obturator alleine Obturator only
		pour optiques para ópticas per ottiche	complet completo completo	Gaine seule Vaina sola Camicia sola	Obturateur seule Obturator solo Otturatore solo



tk 790-334

Adapterstück zur Verwendung in der Urethroskopie bei Frauen
Adapter for use in womens urethroscopy

Adapteur pour l'uretroscopie féminin
Adaptador para ureteroscopya feminina

Adattatore per l'uso dell'uretroscopio nelle donne

Optikbrücken | **Ponts pour télescopes**
Telescope bridges | **Puentes ópticos**
Ponti per cistoscopi



15 Charr. System abweichend von Abbildung
 15 Charr. system, different from picture
 15 Charr. système, différent à la photo
 15 Charr. sistema, diferente del photo
 15 Charr. sistema different da quello raffigurato



15 Charr.	tk 790-046
17-25 Charr.	tk 790-040







15 Charr.	tk 790-047
17-25 Charr.	tk 790-042

15 Charr.	tk 790-048
17-25 Charr.	tk 790-044

Optikbrücke zur Diagnostik
Telescope bridge for diagnostics
 Pont pour télescope pour la diagnose
 Puente operativo diagnóstico
 Ponte diagnostico

Optikbrücke mit 1 Instrumentenkanal
Telescope bridge with 1 instrument channel
 Pont pour télescope avec un canal d'instruments
 Puente operativo con un canal para instrumento
 Ponte operativo ad 1 rubinetto e 1 canale per strumenti

Optikbrücke mit 2 Instrumentenkanälen
Telescope bridge with 2 instrument channels
 Pont pour télescope avec deux canaux d'instruments
 Puente operativo con dos canales para instrumentos
 Ponte operativo a 2 rubinetti e 2 canali per strumenti

		Schäfte Sheaths Gaines Vainas Camicie	Optikbrücke Telescope bridge Pont pour télescopes Puente óptico Ponte operativo			
			tk 790-042	tk 790-047	tk 790-044	tk 790-048
15 Charr.	 Quick Lock	tk 790-015		1 x 5 Charr.		2 x 3 Charr. 1 x 5 Charr.
17 Charr.		tk 790-017 tk 790-027	1 x 5 Charr.		2 x 4 Charr. 1 x 5 Charr.	
19 Charr.		tk 790-019 tk 790-029	1 x 6 Charr.		2 x 5 Charr. 1 x 6 Charr.	
21 Charr.		tk 790-021 tk 790-031	1 x 7 Charr.		2 x 5 Charr. 1 x 7 Charr.	
23 Charr.		tk 790-023 tk 790-033	1 x 9 Charr.		2 x 6 Charr. 1 x 9 Charr.	
25 Charr.		tk 790-025 tk 790-035	1 x 10 Charr.		2 x 8 Charr. 1 x 10 Charr.	

Durchlasskapazität für flexible Instrumente
Capacity for flexible instruments
 Capacité pour instruments flexibles
 Dimensiones del canal operativo para instrumentos flexibles
 Dimensione del canale operativo per strumenti flessibili

Arbeitseinsätze mit ALBARRAN Lenkhebel
Working insert with ALBARRAN deflector

Inserts de travail ALBARRAN
Mecanismos de deflexión uña de ALBARRAN
Elementi operativi ALBARRAN



15 Charr.	tk 790-052
17-25 Charr.	tk 790-050

Arbeitseinsatz mit ALBARRAN Lenkhebel, Sicherheitssonde und 1 Instrumentenkanal, passend zu tk 790-019 - 025 und tk 790-029 - 035
Working insert with ALBARRAN deflecting mechanism, safety probe and 1 instrument channel, corresponding to tk 790-019 - 025 and tk 790-029 - 035

Insert de travail ALBARRAN avec sonde de sécurité et 1 canal d'instruments, pour tk 790-019 - 025 et tk 790-029 - 035

Inserto de trabajo ALBARRAN con sonda de seguridad y 1 canal de instrumentos, para tk 790-019 - 025 y tk 790-029 - 035

Elemento operativo ALBARRAN, mandrino di sicurezza e 1 canale per strumenti per tk 790-019 - 025 e tk 790-029 - 035









15 Charr.	tk 790-053
17-25 Charr.	tk 790-055

Arbeitseinsatz mit ALBARRAN Lenkhebel, Sicherheitssonde und 2 Instrumentenkanälen, passend zu tk 790-019 - 025 und tk 790-029 - 035
Working insert with ALBARRAN deflecting mechanism, safety probe and 2 instrument channels, corresponding to tk 790-019 - 025 and tk 790-029 - 035

Insert de travail ALBARRAN avec sonde de sécurité et 2 canaux d'instruments, pour tk 790-019 - 025 et tk 790-029 - 035

Inserto de trabajo ALBARRAN con sonda de seguridad y 2 canales de instrumentos, para tk 790-019 - 025 y tk 790-029 - 035





Elemento operativo ALBARRAN, mandrino di sicurezza e 2 canali per strumenti, per tk 790-019 - 025 e tk 790-029 - 035

		Schäfte Sheaths Gaines Vainas Camicie	ALBARRAN			
			tk 790-050	tk 790-052	tk 790-055	tk 790-053
15 Charr.	 Quick Lock	tk 790-015		1 x 5 Charr.		2 x 3 Charr. 1 x 5 Charr.
17 Charr.		tk 790-017 tk 790-027	1 x 5 Charr.		2 x 4 Charr. 1 x 5 Charr.	
19 Charr.		tk 790-019 tk 790-029	1 x 5 Charr.		2 x 4 Charr. 1 x 5 Charr.	
21 Charr.		tk 790-021 tk 790-031	1 x 6 Charr.		2 x 5 Charr. 1 x 6 Charr.	
23 Charr.		tk 790-023 tk 790-033	1 x 9 Charr.		2 x 6 Charr. 1 x 9 Charr.	
25 Charr.		tk 790-025 tk 790-035	1 x 10 Charr.		2 x 8 Charr. 1 x 10 Charr.	

Sichtobturatoren
Visual obturators

Obturbateurs visuels
Obturadores visuales
Otturatori ottici



17 Charr.		tk 794-040
19 Charr.		tk 794-041
21 Charr.		tk 794-042
23 Charr.		tk 794-043
25 Charr.		tk 794-044

Sichtobturatoren für 30° Endoskope

Visual obturators for 30° endoscopes









Obturbateurs visuels pour endoscopes de 30°

Obturadores visuales para endoscopios 30°

Otturatore ottico per endoscopi 30°

Optische Instrumente
Optical instruments

 Instruments optiques
 Instrumentos ópticos
 Strumenti ottici

	 Probeexisionszange <i>Biopsy forceps</i> Pince à biopsie <i>Pinza de biopsia</i> Pinza da biopsia	tk 790-100	tk 700-074 (0°) tk 700-075 (12°)	
	 Probeexisionszange <i>Biopsy forceps</i> Pince à biopsie <i>Pinza de biopsia</i> Pinza da biopsia	tk 790-102	tk 700-074 (0°) tk 700-075 (12°)	
2,3 mm I	 Probeexisionszange <i>Biopsy forceps</i> Pince à biopsie <i>Pinza de biopsia</i> Pinza da biopsia	tk 790-104	tk 700-075 (12°) tk 700-078 (30°) tk 700-079 (70°)	
3,0 mm I	 Probeexisionszange <i>Biopsy forceps</i> Pince à biopsie <i>Pinza de biopsia</i> Pinza da biopsia	tk 790-106	tk 700-078 (30°)	tk 790-021 tk 790-023 tk 790-025 tk 790-031 tk 790-033 tk 790-035 tk 790-320 + tk 790-333 tk 790-330 + tk 790-333
	 Fasszange <i>Grasping forceps</i> Pince à saisir <i>Pinza de agarre</i> Pinza da presa	tk 790-110	tk 700-074 (0°) tk 700-075 (12°)	
	 Hakenschere <i>Hook scissors</i> Ciseaux à crochet <i>Tijeras de gancho</i> Forbice da uncino	tk 790-120	tk 700-074 (0°) tk 700-075 (12°)	
	 Fasszange für Stents <i>Grasping forceps for stents</i> Pince à saisir pour stents <i>Pinza de agarre para stents</i> Pinza da presa per stents	tk 790-339	tk 700-074 (0°) tk 700-075 (12°) tk 700-078 (30°)	
	 tk 790-333		für Optiken <i>for scopes</i> pour optiques <i>para ópticas</i> per ottiche	für Schäfte <i>for sheaths</i> pour gaines <i>para vainas</i> per camicie

Adapter zur Verwendung mit Resektoskopschäften 790-320 / 790-330

Adapter for use with resectoscope sheaths 790-320 / 790-330

Adaptateur pour avec gaines de resectoscopie 790-320 / 790-330

Adaptador para con vainas de resectoscopia 790-320 / 790-330

Adattatore per camicie di resettoscopia 790-320 / 790-330

Optische Instrumente
Optical instruments

Instruments optiques
Instrumentos ópticos
Strumenti ottici



Steinfasszange <i>Stone grasping forceps</i> Pince pour saisir des calculs <i>Pinze para cálculos</i> Pinza per calcoli	tk 790-112	tk 700-075 (12°) tk 700-078 (30°)	tk 790-025 tk 790-035 tk 790-321 + tk 790-430 tk 790-331 + tk 790-430
--	-------------------	--------------------------------------	--

Doppelbeweglich
Double action

Double articulation
Doble articulación
Doppia azione

für Optiken
for scopes
pour optiques
para ópticas
per ottiche

für Schäfte
for sheaths
pour gaines
para vainas
per camicie



tk 790-430

Adapter zur Verwendung mit Tekno-Medical Resektoskopschäften (tk 790-321 / tk 790-331)
Adaptor for using with Tekno-Medical resectoscope sheaths (tk 790-321 / tk 790-331)

Adaptateur pour l'utilisation avec des gaines de resectoscopie Tekno-Medical (tk 790-321 / tk 790-331)
Adaptador para la utilización con vainas de resectoscopia Tekno-Medical (tk 790-321 / tk 790-331)
Adattatore per l'utilizzazione con camicie Tekno-Medical di resectoscopia (tk 790-321 / tk 790-331)



tk 790-326

Adapter zur Verwendung mit Original Storz Resektoskopschäften
Adaptor for use with original Storz resectoscope sheaths

Adaptateur pour l'utilisation avec des gaines de resectoscopie original Storz
Adaptador para la utilización con vainas de resectoscopia originales Storz
Adattatore per l'utilizzazione con camicie originale Storz di resectoscopia

Optische Instrumente
Optical instruments

Instruments optiques
Instrumentos ópticos
Strumenti ottici

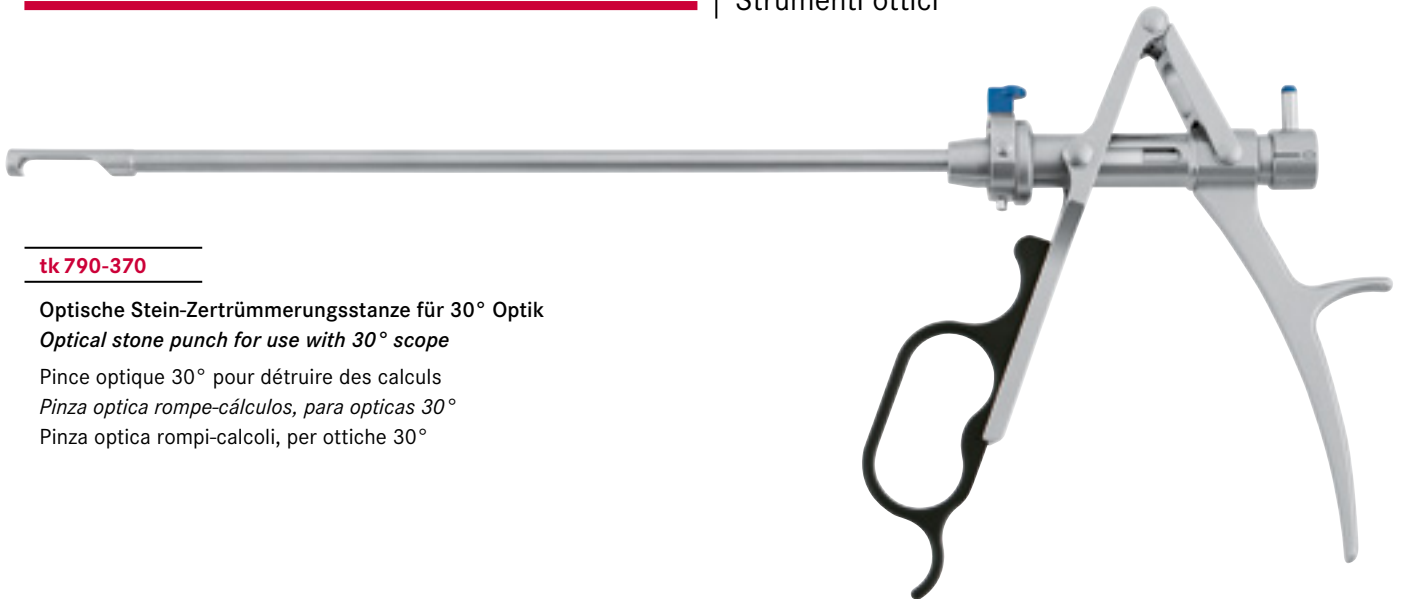

tk 790-370

Optische Stein-Zertrümmerungsstanze für 30° Optik
Optical stone punch for use with 30° scope

Pince optique 30° pour détruire des calculs
Pinza óptica rompe-cálculos, para ópticas 30°
Pinza óptica rompi-calcoli, per ottiche 30°



24 Charr.

tk 790-471

Schaft für Stein-Zertrümmerungsstanze , Zentralhahn
Sheath for stone punch, central valve

Gaine pour pince à détruire des calculs, valve centrale
Vaina para pinza rompe-cálculos, grifo central
Camicia per pinza rompi-calcoli, rubinetto centrale

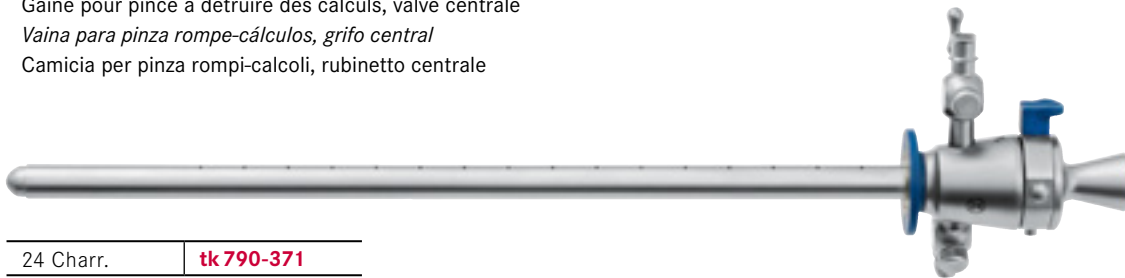

24 Charr.

tk 790-371

Schaft für Stein-Zertrümmerungsstanze
Sheath for stone punch

Gaine pour pince optique
Vaina para pinza rompe-cálculos
Camicia per pinza rompi-calcoli



tk 790-375

Innenschaft mit Instrumentenkanal, 7 CH
Inner sheath with instrument channel, 7 CH

Tube interne avec canal d'instruments, 7 CH
Vaina interna con canal para instrumentos, 7 CH
Camicia interna con canale per strumenti, 7 CH

Optische Instrumente
Optical instruments

Instruments optiques
Instrumentos ópticos
Strumenti ottici

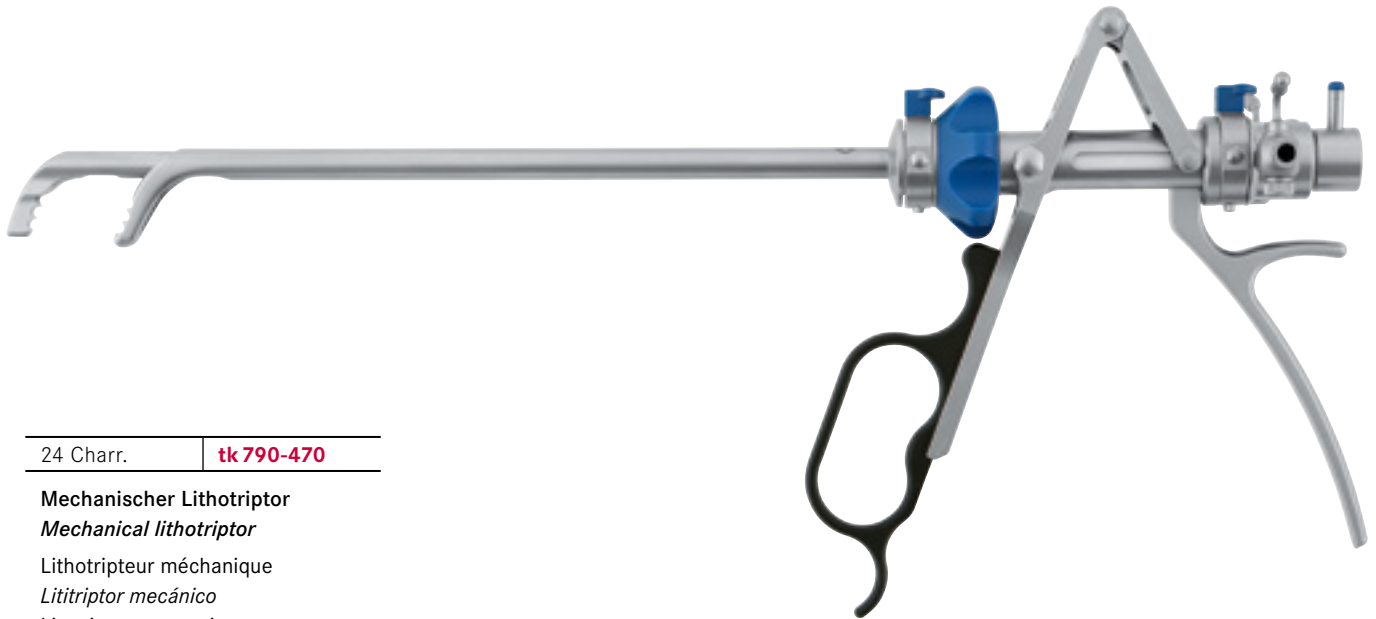

24 Charr. | **tk790-470**

Mechanischer Lithotriptor
Mechanical lithotriptor
Lithotriporteur mécanique
Litriptor mecánico
Litotritore meccanico

Flexible Instrumente
Flexible instruments

Instruments flexibles
Instrumentos flexibles
Strumenti flessibili

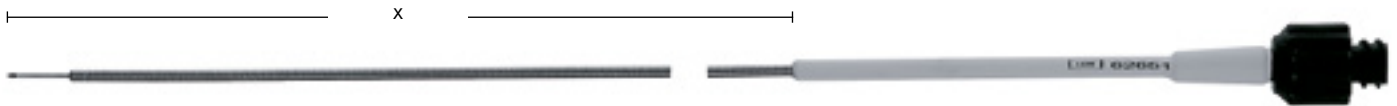

	x = 50 cm
6 Charr.	tk 790-480

Injektionskanüle, flexibel
Injection needle, flexible

Canule à injection, flexible
Cánula para inyección, flexible
Ago per iniezione, flessibile



			x = 70 cm
Ø 3 Charr.	20 mm	4	tk 790-291
Ø 5 Charr.	30 mm	6	tk 790-293
Ø 7 Charr.	40 mm	4	tk 790-294

Steinfänger <i>Stone dislodger</i>	Körbchenlänge <i>Basket length</i>	Körbchen Typ/Drähte <i>Basket type/wires</i>
Saisir calculs <i>Trapa-cálculos</i> Sonda	Longueur du panier <i>Longitud de la cesta</i> Lunghezza del cestino	Type de panier/fils <i>Tipo de cesta/alambres</i> Tipo di cestino/fili

3/5 Charr.	tk 790-290
7 Charr.	tk 790-298

Handgriff für Steinfänger
Handle for stone dislodger

Poignée pour pince à saisir
Mango para atrapa-cálculos
Manico per sonda

Flexible Instrumente
Flexible instruments

Instruments flexibles
Instrumentos flexibles
Strumenti flessibili



	x= 40 cm	x= 40 cm	x= 40 cm
5 Charr.	tk 790-219	tk 790-199	tk 790-239
7 Charr.	tk 790-226	tk 790-206	tk 790-246
9 Charr.	tk 790-227	tk 790-207	tk 790-247
Fasszange, Alligatormaul <i>Grasping forceps, alligator jaw</i>	halbstarr <i>semi-rigid</i>	flexibel <i>flexible</i>	flexibel und isoliert <i>flexible and insulated</i>
Pince à saisir, mors crocodile <i>Pinza de agarre con dientes de cocodrilo</i>	semi-rigide <i>semi-rígido</i>	flexible <i>flexible</i>	flexible isolée <i>flexible con aislamiento</i>
Pinza da presa con morso a cocodrillo	semi rigida	flessibile	flessibile e isolata



	x= 40 cm	x= 40 cm	x= 40 cm
5 Charr.	tk 790-217	tk 790-197	tk 790-237
7 Charr.	tk 790-222	tk 790-202	tk 790-242
9 Charr.	tk 790-223	tk 790-203	tk 790-243
Biopsiezange, Löffel oval <i>Biopsy forceps, oval spoon</i>	halbstarr <i>semi-rigid</i>	flexibel <i>flexible</i>	flexibel und isoliert <i>flexible and insulated</i>
Pince à biopsie, mors oval <i>Pinza para biopsia, cuchara oval</i>	semi-rigide <i>semi-rígido</i>	flexible <i>flexible</i>	flexible isolée <i>flexible con aislamiento</i>
Pinza da biopsia a cucciaio ovale	semi rigida	flessibile	flessibile e isolata



	x= 40 cm	x= 40 cm	x= 40 cm
5 Charr.	tk 790-218	tk 790-198	tk 790-238
7 Charr.	tk 790-224	tk 790-204	tk 790-244
9 Charr.	tk 790-225	tk 790-205	tk 790-245
Biopsiezange, Löffel oval, gezahnt <i>Biopsy forceps, oval spoon, serrated</i>	halbstarr <i>semi-rigid</i>	flexibel <i>flexible</i>	flexibel und isoliert <i>flexible and insulated</i>
Pince à biopsie, mors oval, dentelée <i>Pinza para biopsia, cuchara oval, dentado</i>	semi-rigide <i>semi-rígido</i>	flexible <i>flexible</i>	flexible isolée <i>flexible con aislamiento</i>
Pinza da biopsia a cucciaio ovale, dentellata	semi rigida	flessibile	flessibile e isolata

Flexible Instrumente
*Flexible instruments*Instruments flexibles
Instrumentos flexibles
Strumenti flessibiliAndere Längen und Durchmesser auf Anfrage
Other lengths and diameters on request

Autres longueurs et diamètres sur demande

Otras longitudes y diámetros sobre demanda

Altre lunghezze ed altri diametri disponibili su richiesta



	x= 40 cm	x= 40 cm	x= 40 cm
5 Charr.	tk 790-216	tk 790-196	tk 790-236
7 Charr.	tk 790-220	tk 790-200	tk 790-240
9 Charr.	tk 790-221	tk 790-201	tk 790-241
Scheren <i>Scissors</i>	halbstarr <i>semi-rigid</i>	flexibel <i>flexible</i>	flexibel und isoliert <i>flexible and insulated</i>
Ciseaux <i>Tijeras</i>	semi-rigide <i>semi-rigido</i>	flexible <i>flexible</i>	flexible isolée <i>flexible con aislamiento</i>
Forbice	semi rigida	flessibile	flessibile e isolata



	x= 40 cm	x= 40 cm	x= 40 cm
7 Charr.	tk 790-263	tk 790-262	tk 790-264
Scheren <i>Scissors</i>	halbstarr <i>semi-rigid</i>	flexibel <i>flexible</i>	flexibel und isoliert <i>flexible and insulated</i>
Ciseaux <i>Tijeras</i>	semi-rigide <i>semi-rigido</i>	flexible <i>flexible</i>	flexible isolée <i>flexible con aislamiento</i>
Forbice	semi rigida	flessibile	flessibile e isolata



	x= 40 cm	x= 40 cm	x= 40 cm
7 Charr.	tk 790-255	tk 790-250	tk 790-258
9 Charr.	tk 790-256	tk 790-251	tk 790-260
Hakenscheren <i>Hook scissors</i>	halbstarr <i>semi-rigid</i>	flexibel <i>flexible</i>	flexibel und isoliert <i>flexible and insulated</i>
Ciseaux á crochet <i>Tijeras de gancho</i>	semi-rigide <i>semi-rigido</i>	flexible <i>flexible</i>	flexible isolée <i>flexible con aislamiento</i>
Forbice ad uncino	semi rigida	flessibile	flessibile e isolata

Flexible Instrumente
Flexible instruments

Instruments flexibles
Instrumentos flexibles
Strumenti flessibili

Monopolar
Monopolar
Monopolaire
Monopolar
Monopolare



	x = 45 cm	x = 45 cm	x = 45 cm
3 Charr.	tk 790-482	tk 790-487	-
4 Charr.	tk 790-483	tk 790-488	-
5 Charr.	tk 790-280	tk 790-284	tk 790-288
6 Charr.	tk 790-282	-	-
7 Charr.	tk 790-281	tk 790-285	tk 790-289
8 Charr.	tk 790-484	-	-
9 Charr.	tk 790-485	-	tk 790-495
10 Charr.	tk 790-486	-	tk 790-496

	x = 65 cm	x = 65 cm	x = 65 cm
3 Charr.	tk 790-170	tk 790-177	-
4 Charr.	tk 790-171	tk 790-178	-
5 Charr.	tk 790-172	tk 790-179	tk 790-186
6 Charr.	tk 790-169	-	-
7 Charr.	tk 790-173	tk 790-180	tk 790-187
8 Charr.	tk 790-174	-	-
9 Charr.	tk 790-175	-	tk 790-189
10 Charr.	tk 790-176	-	tk 790-194

Koagulations-Elektrode, kugelförmig
Coagulation electrode, ball shaped

Electrode à boule, pour coagulation
Electrodo de bola para coagulación
Elettrodo a pallina per coagulazione

Nadelelektrode
Needle electrode

Electrode à aiguille
Electrodo de aguja
Elettrodo a ago

Schlingenelektrode
Loop electrode

Electrode de asa
Electrodo de lazo
Elettrodo ad ansa



Ø = 4 mm	3m	tk 790-310
Aesculap, Berchtold, Martin		
Ø = 5 mm	3m	tk 790-311
Storz, Erbe		
Ø = 8 mm	3m	tk 790-312
Tekno, Valleylab, Bovie		
Ø = 4 mm	3m	tk 790-313
Berchtold, Martin		



Flexible Instrumente
Flexible instruments

Instruments flexibles
Instrumentos flexibles
Strumenti flessibili

Bipolar
Bipolar
Bipolaire
Bipolar
Bipolare



	x = 36 cm	x = 36 cm	x = 36 cm
5 Charr.	tk 790-150	tk 790-151	tk 790-152
	Koagulations-Elektrode, kugelförmig <i>Coagulation electrode, ball shaped</i> Electrode à boule, pour coagulation <i>Electrodo de bola para coagulación</i> Elettrodo a pallina per coagulazione	Nadelelektrode <i>Needle electrode</i> Electrode à aiguille <i>Electrodo de aguja</i> Elettrodo ad agho	Nadelelektrode <i>Needle electrode</i> Electrode à aiguille <i>Electrodo de aguja</i> Elettrodo ad agho

		3m	tk 707-330	Flat plug round	
		3m	tk 707-300	Flat plug square	
		3m	tk 707-331	Flat plug round	
		3m	tk 707-301	Flat plug square	
		3m	tk 707-332	Flat plug round	
		3m	tk 707-302	Flat plug square	
		3m	tk 707-333	Flat plug round	
		3m	tk 707-303	Flat plug square	
		3m	tk 707-338	Flat plug round	

Laser-Zystoskop-Urethroskop Schäfte
Laser-cystoscope-urethroscope sheaths

Gaines pour cystoscopie-uretroscopie à laser
 Vainas para cistoscopia-uretroscopia de laser
 Camice per laser-cistoscopia-uretroscopia



23 Charr.	tk 790-852	tk 790-862
	Schaft <i>Sheath</i>	Obturator <i>Obturator</i>
	Gaine <i>Vaina</i>	Obturateur <i>Obturador</i>
	Camicia	Otturatore



8 Charr	tk 790-833
---------	-------------------

Innenschaft mit einem Instrumentenkanal
Inner sheath with one instrument channel
 Gaine interne avec un canal d´instrument
Vaina interna con un canal para instrumentos
 Camicia interna con un canale per strumenti

tk 790-843

Sichtobturatoren für 30° Endoskope
Visual obturators for 30° endoscopes
 Obturateurs visuels pour endoscopes de 30°
Obturadores visuales para endoscopios 30°
 Otturatore ottico per endoscopi 30°



Systemübersicht
System overview

Aperçu général du système
Vista general del sistema
Visione sul sistema

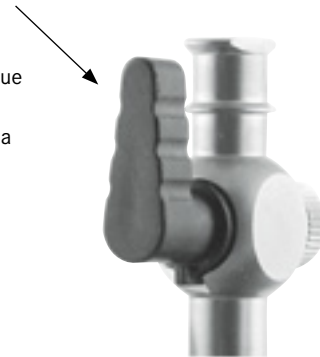

Symbole und Besonderheiten, Resektoskopie
Symbols and characteristics, resectoscopy
Symboles et caractéristiques, résectoscopie
Símbolos y características, resectoscopia
Simboli e caratteristiche, resectoscopia

Auch mit Plastikhähnen lieferbar
Also available with plastic stopcocks
Aussi disponible avec robinets en plastique
También disponible con llaves en plastica
Anche disponibili con rubinetto in plastica



Farberkennung für jeweilige Charr.
Colour code for respective Charr.

Marquage en couleur pour respectives Charr.
Identificación de color para cada Charr.
Identificazione a colori per i relativi Charr.

19/22 Charr.	
24/26 Charr.	
27/28.5 Charr.	

Schnellverschluss (QL-Verriegelung)
Quick-lock fixation

Fixation rapide, quick-lock
Fijación rápida, quick-lock
Chiusura rapida, quick-lock

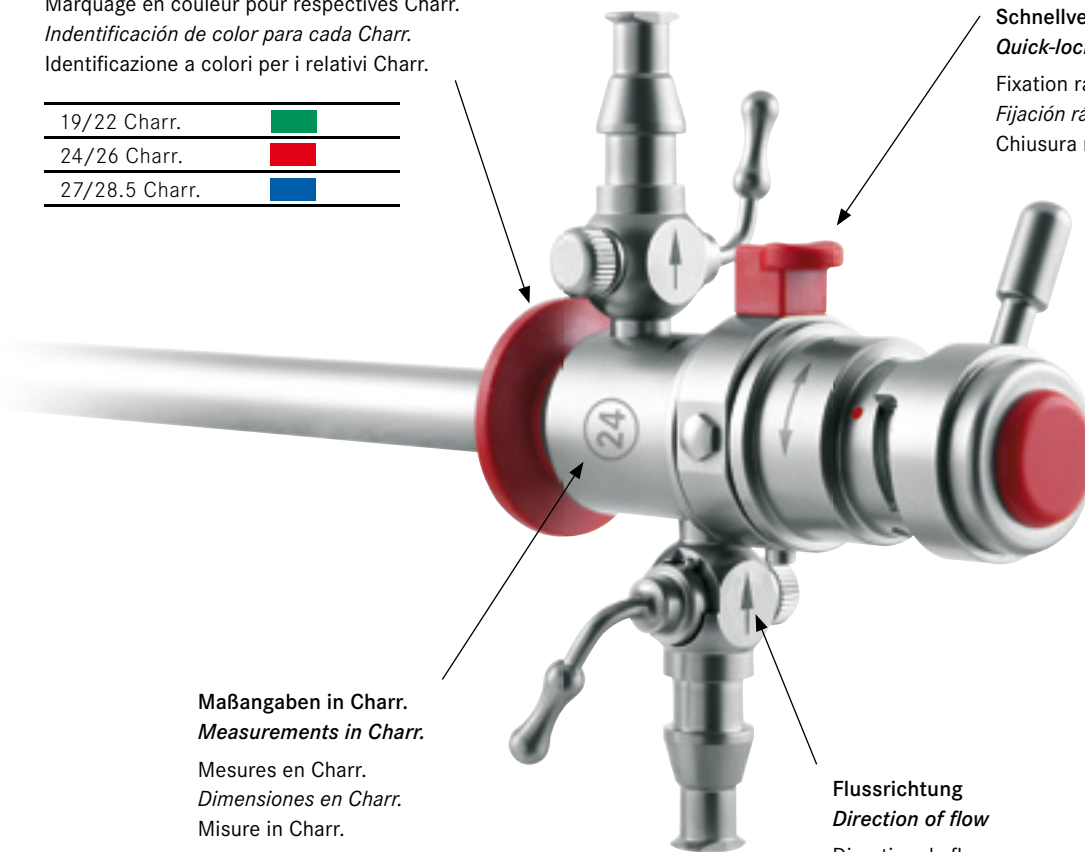

Maßangaben in Charr.
Measurements in Charr.
Mesures en Charr.
Dimensiones en Charr.
Misure in Charr.

Flussrichtung
Direction of flow
Direction de flux
Dirección del flujo
Direzione del flusso

 = Durchmesser Aussenschaft
Outer diameter sheath
Diamètre de la gaine externe
Diametro de la vaina externa
Diametro camicia esterna

 = Durchmesser Innenschaft
Inner diameter sheath
Diamètre de la gaine interne
Diametro de la vaina interna
Diametro camicia interna

Systemübersicht
System overview

Aperçu général du système
Vista general del sistema
Visione sul sistema

⊙ 19 / ⊙ 22 Charr.	■
⊙ 24 / ⊙ 26 Charr.	■
⊙ 27 / ⊙ 28.5 Charr.	■



Elektroden
Electrodes
Electrodes
Electrodos
Elettrodi

■ tk 791-420 - tk 791-423
■ tk 791-350 - tk 791-365
■ tk 791-450 - tk 791-465

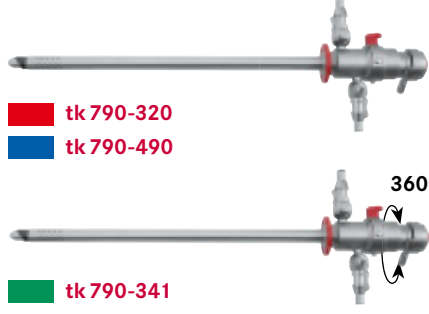

■ tk 790-320
■ tk 790-490

■ tk 790-341
■ tk 790-330
■ tk 790-315

360°

Permanente Spülung
Continuous flow

Irrigation permanente
Irrigación continua
Flusso continuo



■ tk 790-324
■ tk 790-323
■ tk 790-318

■ tk 790-325
■ tk 790-725



tk 790-690

Trokarset zur suprapubischen Aspiration
Suprapubic aspiration set

Jeu de trocar pour l'aspiration suprapubique
Juego de trocares para la aspiración suprapubica
Set di trocar per la aspirazione suprapubica

Systemübersicht
System overview

Aperçu général du système
Vista general del sistema
Visione sul sistema

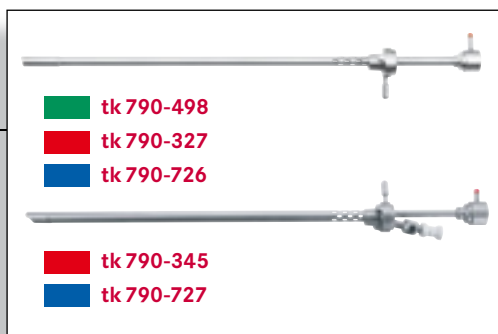
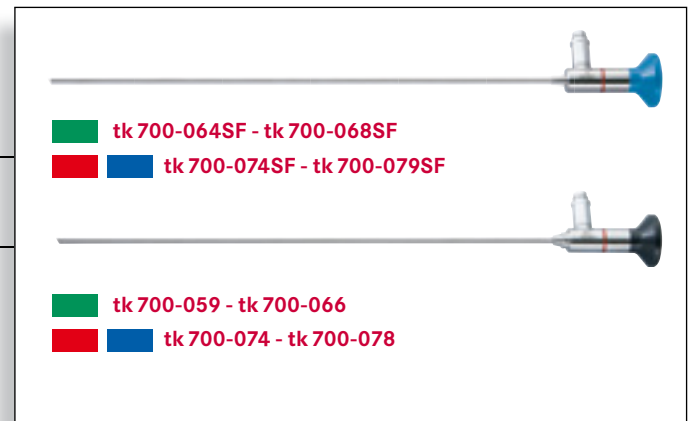
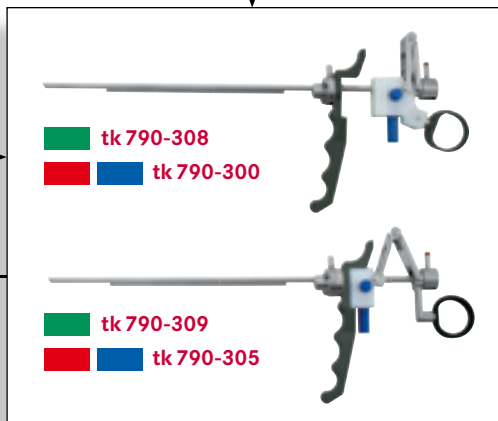

Optiken | Optiques
 Scopes | Ópticas
 Ottiche

autoklavierbar / autoclavable
 134°C / 273°F - 18 min.

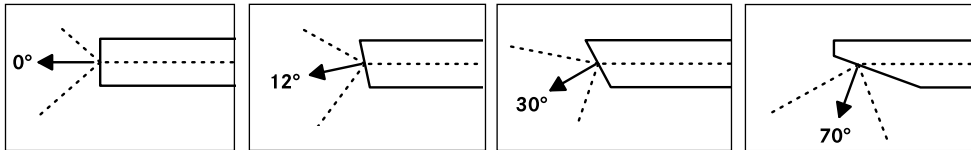

Ø 2.7 mm - 302 mm	tk 700-064	tk 700-065	tk 700-068	tk 700-069
Ø 2.9 mm - 302 mm	tk 700-059	tk 700-061	tk 700-066	-
Ø 4.0 mm - 302 mm	tk 700-074	tk 700-075	tk 700-078	tk 700-079

Ø 2.7 mm - 302 mm	tk 700-064SF	tk 700-065SF	tk 700-068SF	-
Ø 4.0 mm - 302 mm	tk 700-074SF	tk 700-075SF	tk 700-078SF	tk 700-079SF

Arbeitslänge
 Working length

Longueur de travail
 Longitud de trabajo
 Lunghezza operativa

SF = Tekno-Flex

Hochfrequenzkabel, monopolar
 High frequency cables, monopolar

Câbles de haute fréquence, monopolaire
 Cables alta frecuencia, monopolar
 Cavi ad alta frequenza, monopolare



Ø = 4 mm	3m	tk 790-310
Aesculap, Berchtold, Martin		
Ø = 5 mm	3m	tk 790-311
Storz, Erbe		
Ø = 8 mm	3m	tk 790-312
Tekno, Valleylab, Bovie		
Ø = 4 mm	3m	tk 790-313
Berchtold, Martin		



Monopolare Arbeitselemente
Monopolar working elements

Eléments de travail monopolaires
Elementos de trabajo monopolares
Elementi operativi monopolari



19 Charr.		tk 790-308
-----------	---	-------------------

24 Charr.		tk 790-300
-----------	---	-------------------

Arbeitselement, passiv schneidend, einläufig
Working element, passive cutting, single stem

Elément de travail, coupe passive, single-stem
Elemento de trabajo, corte pasivo, un vástago
Elemento operativo passivo, un stelo



19 Charr.		tk 790-309
-----------	---	-------------------

24 Charr.		tk 790-305
-----------	---	-------------------

Arbeitselement, aktiv schneidend, einläufig
Working element, active cutting, single stem

Elément de travail, coupe active, single-stem
Elemento de trabajo, corte activo, un vástago
Elemento operativo attivo, un stelo





Auf Wunsch auch mit geschlossenem Griff erhältlich
Available with closed handle upon request

Disponible avec poignée fermée sur demande
Disponible con mango cerrado según demanda
Disponibile con manico chiuso su richiesta

Monopolar-Elektroden
Monopolar electrodes

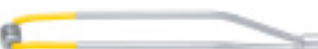
 Electrodes monopolaires
Electrodos monopolares
 Elettrodi monopolari

 einläufig
single stem
 single-stem
un vástago
 un stelo

	 19 Charr.	 24 Charr.	 27 Charr.
Messerelektrode, gewinkelt 90° <i>Knife electrode, angled 90°</i> Electrode à couteau, coudée 90° <i>Electrodo de cuchillo, angulado 90°</i> Elettrodo a bisturi, angolato 90°	tk 791-420	tk 791-350	tk 791-450
Schlingenelektrode, gerade <i>Loop electrode, straight</i> Electrode à anse, droit <i>Electrodo de asa, recto</i> Elettrodo ad ansa, retto	tk 791-424	tk 791-351	tk 791-451
Schlingenelektrode, gewinkelt 30° <i>Loop electrode, angled 30°</i> Electrode à anse, coudée, 30° <i>Electrodo de asa, angulado 30°</i> Elettrodo ad ansa, angolato 30°	tk 791-421	tk 791-352	tk 791-452
Schlingenelektrode, gewinkelt 90° <i>Loop electrode, angled 90°</i> Electrode à anse, coudée, 90° <i>Electrodo de asa, angulado 90°</i> Elettrodo ad ansa, angolato 90°	-	tk 791-357	tk 791-457
Vaporisationselektrode, gerieft, Ø 3 mm <i>Vaporization electrode, serrated, Ø 3 mm</i> Electrode de vaporisation, striée, Ø 3 mm <i>Electrodo de vaporización, estriado, Ø 3 mm</i> Elettrodo per vaporizzazione, scanalato, Ø 3 mm	-	tk 791-358	tk 791-458
Vaporisationselektrode, gerieft, Ø 5 mm <i>Vaporization electrode, serrated, Ø 5 mm</i> Electrode de vaporisation, striée, Ø 5 mm <i>Electrodo de vaporización, estriado, Ø 5 mm</i> Elettrodo per vaporizzazione, scanalato, Ø 5 mm	-	tk 791-353	tk 791-453



 Packung à 6 Stck.
Box of 6 pcs.
 Paquet de 6 pcs.
Paquete de 6 pzas.
 Confezione con 6 pezzi

Monopolar-Elektroden
Monopolar electrodes

 Electrodes monopolaires
 Electrodoos monopolares
 Elettrodi monopolari

 einläufig
 single stem

 single-stem
 un vástago
 un stelo

	 19 Charr.	 24 Charr.	 27 Charr.
Kugelelektrode, Ø 3 mm Ball electrode, Ø 3 mm Electrode à boule, Ø 3 mm Electrodo de bola, Ø 3 mm Elettrodo a pallina, Ø 3 mm	tk 791-423	tk 791-354	tk 791-454
Kugelelektrode, Ø 5 mm Ball electrode, Ø 5 mm Electrode à boule, Ø 5 mm Electrodo de bola, Ø 5 mm Elettrodo a pallina, Ø 5 mm	-	tk 791-363	tk 791-463
Kegelelektrode Cone electrode Electrode conique Electrodo conico Elettrodo a cono	-	tk 791-355	tk 791-455
Schneide/Vaporisationselektrode Vaporisation electrode Électrode de vaporisation Electrodo de vaporización Elettrodo per vaporizzazione	-	tk 791-359	-
Rollenelektrode, glatt, Ø 3 mm Roller electrode, smooth, Ø 3 mm Electrode forme rouleau, lisse, Ø 3 mm Electrodo de rollo, liso, Ø 3 mm Elettrodo a ruolo, smusso, Ø 3 mm	tk 791-422	tk 791-367	tk 791-467
Rollenelektrode, glatt, Ø 5 mm Roller electrode, smooth, Ø 5 mm Electrode forme rouleau, lisse, Ø 5 mm Electrodo de rollo, liso, Ø 5 mm Elettrodo a ruolo, smusso, Ø 5 mm	-	tk 791-365	tk 791-465

Packung à 6 Stck.

Box of 6 pcs.

Paquet de 6 pcs.

Paquete de 6 pzas.

Confezione con 6 pezzi

tk 790-374

 Schutzhülse zur Sterilisation von Elektroden
 Protection tube for sterilization of electrodes

Tube de protection et stérilisation des électrodes

Tubo protector para la esterilización de electrodos

Camicia di protezione per sterilizzazione degli elettrodi



Monopolare Resektorschäfte
Monopolar resectoscopes sheaths

Gaines des résectoscopie monopolaires
Vaines de resectoscopia monopolares
Camicie per resettoscopia monopolari

drehbar
rotatable
rotative
giratoria
rotante



⊕ 19 / ⊕ 22 Charr. ■	tk 790-344	tk 790-343	tk 790-324
Resektoskopschaft zur Dauerspülung <i>Resectoscope sheath for continuous flow</i>	Außenschaft <i>Outer sheath</i>	Innenschaft <i>Inner sheath</i>	Obturator <i>Obturator</i>
Gaine de résectoscopie à irrigation permanente <i>Vaina de resectoscopia para irrigación continua</i>	Gaine extérieur <i>Vaina exterior</i>	Gaine intérieur <i>Vaina interior</i>	Obturateur <i>Obturator</i>
Camicia resettoscopia a lavaggio continuo	Camicia esterna	Camicia interna	Otturatore
tk 790-341	x	x	x

komplett
complete
complet
completo
completo

⊕ 24 / ⊕ 26 Charr. ■	tk 790-331	tk 790-332	tk 790-323
Resektoskopschaft zur Dauerspülung <i>Resectoscope sheath for continuous flow</i>	Außenschaft <i>Outer sheath</i>	Innenschaft <i>Inner sheath</i>	Obturator <i>Obturator</i>
Gaine de résectoscopie à irrigation permanente <i>Vaina de resectoscopia para irrigación continua</i>	Gaine extérieur <i>Vaina exterior</i>	Gaine intérieur <i>Vaina interior</i>	Obturateur <i>Obturator</i>
Camicia resettoscopia a lavaggio continuo	Camicia esterna	Camicia interna	Otturatore
tk 790-330	x	x	x

komplett
complete
complet
completo
completo

⊕ 27 / ⊕ 28.5 Charr. ■	tk 790-316	tk 790-317	tk 790-318
Resektoskopschaft zur Dauerspülung <i>Resectoscope sheath for continuous flow</i>	Außenschaft <i>Outer sheath</i>	Innenschaft <i>Inner sheath</i>	Obturator <i>Obturator</i>
Gaine de résectoscopie à irrigation permanente <i>Vaina de resectoscopia para irrigación continua</i>	Gaine extérieur <i>Vaina exterior</i>	Gaine intérieur <i>Vaina interior</i>	Obturateur <i>Obturator</i>
Camicia resettoscopia a lavaggio continuo	Camicia esterna	Camicia interna	Otturatore
tk 790-315	x	x	x

komplett
complete
complet
completo
completo

Monopolare Resektorschäfte
Monopolar resectoscopes sheaths

Gaines des résectoscopie monopolaires
Vaines de resectoscopia monopolares
 Camicie per resettoscopia monopolari



© 24 / © 26 Charr. ■	tk 790-321	tk 790-322	tk 790-323
Resektoskopschaft zur Dauerspülung <i>Resectoscope sheath for continuous flow</i>	Außenschaft <i>Outer sheath</i>	Innenschaft <i>Inner sheath</i>	Obturator <i>Obturator</i>
Gaine de résectoscopie à irrigation permanente <i>Vaina de resectoscopia para irrigación continua</i>	Gaine extérieur <i>Vaina exterior</i>	Gaine intérieur <i>Vaina interior</i>	Obtuteur <i>Obturador</i>
Camicia resettoscopia a lavaggio continuo	Camicia esterna	Camicia interna	Otturatore
tk 790-320	x	x	x
komplett <i>complete</i> complet <i>completo</i> completo			
© 27 / © 28.5 Charr. ■	tk 790-491	tk 790-492	tk 790-318
Resektoskopschaft zur Dauerspülung <i>Resectoscope sheath for continuous flow</i>	Außenschaft <i>Outer sheath</i>	Innenschaft <i>Inner sheath</i>	Obturator <i>Obturator</i>
Gaine de résectoscopie à irrigation permanente <i>Vaina de resectoscopia para irrigación continua</i>	Gaine extérieur <i>Vaina exterior</i>	Gaine intérieur <i>Vaina interior</i>	Obtuteur <i>Obturador</i>
Camicia resettoscopia a lavaggio continuo	Camicia esterna	Camicia interna	Otturatore
tk 790-490	x	x	x
komplett <i>complete</i> complet <i>completo</i> completo			

Obturatoren | Obturateurs
Obtursors | *Obturadores*
 Otturatori



19 Charr.		tk 790-324
24 Charr.		tk 790-323
27 Charr.		tk 790-318

Standardobturator
Standard obturator

Obturateur standard
Obturador estándar
 Otturatore standard



24 Charr.		tk 790-325
27 Charr.		tk 790-725

Obturator beweglich
Deflecting obturator

Obturateur mobile
Obturador móvil
 Otturatore mobile





19 Charr.		tk 790-498
24 Charr.		tk 790-327
27 Charr.		tk 790-726

Sichtobturator
Visual obturator

Obturateur visuel
Obturador óptico
 Otturatore ottico



24 Charr.		- Ø 5 Charr.	tk 790-345
27 Charr.		- Ø 7 Charr.	tk 790-727

Sichtobturator mit einem Instrumentenkanal
Visual obturator with one instrument channel

Obturateur visuel avec canal d'instruments
Obturador óptico con un canal para instrumentos
 Otturatore ottico con un canale per strumenti

Suprapubischer Trokar
Suprapubic trocar

Suprapubique trocar
Suprapubica trocar
Suprapubica trocar



tk 790-690

Trokarset zur suprapubischen Aspiration
Suprapubic aspiration set

Jeu de trocar pour l'aspiration suprapubique
Juego de trocares para la aspiración suprapubica
Set di trocar per la aspirazione suprapubica

Systemübersicht
System overview

Aperçu général du système
Vista general del sistema
Visione sul sistema

BIPOLARK

⊙ 17.5 / ⊙ 18.5 Charr.	■
⊙ 19 / ⊙ 22 Charr.	■
⊙ 24 / ⊙ 26 Charr.	■



Elektroden
Electrodes
Electrodes
Electrodos
Elettrodi

- tk 799-576 - tk 799-579
- tk 799-360 - tk 799-366
- tk 799-350 - tk 799-357
- tk 799-371 - tk 799-378



- tk 799-320 / tk 799-328
- tk 799-310
- tk 799-330 / tk 799-335
- tk 790-572



- tk 790-575
- tk 799-313
- tk 799-323

Permanente Spülung
Continuous flow

Irrigation permanente
Irrigación continua
Flusso continuo

Systemübersicht
System overview

Aperçu général du système
Vista general del sistema
Visione sul sistema

tk 707-350

Kabel
Cables
Câbles
Cables
Cavi



tk 90009-04



tk 90016-00

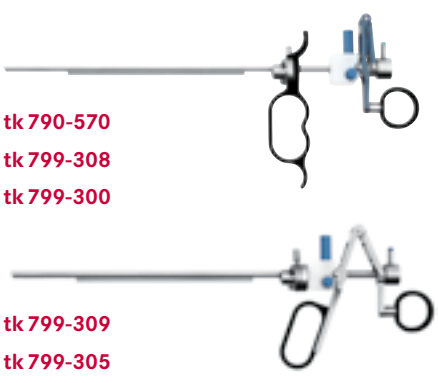

tk 790-570
tk 799-308
tk 799-300

tk 799-309
tk 799-305

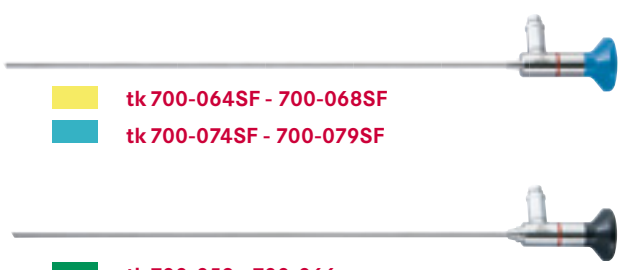

tk 700-064SF - 700-068SF
tk 700-074SF - 700-079SF

tk 700-059 - 700-066
tk 700-059 - 700-066
tk 700-074 - 700-078

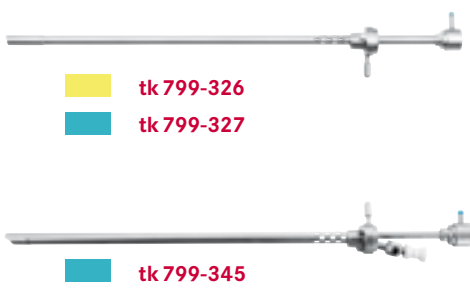

tk 799-326
tk 799-327

tk 799-345

Optiken | Optiques
 Scopes | Ópticas
 Ottiche

autoklavierbar / autoclavable
 134°C / 273°F - 18 min.

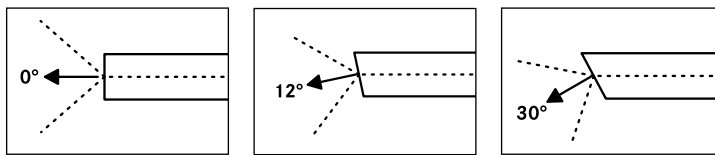

Ø 2.9 mm - 302 mm	tk 700-059	tk 700-061	tk 700-066
Ø 4.0 mm - 302 mm	tk 700-074	tk 700-075	tk 700-078
Ø 4.0 mm - 302 mm	tk 700-074SF	tk 700-075SF	tk 700-078SF

Arbeitslänge
 Working length

Longueur de travail
 Longitud de trabajo
 Lunghezza operativa

SF = Tekno-Flex

Bipolare Arbeitselemente
Bipolar working elements

Eléments de travail bipolaires
Elementos de trabajo bipolares
Elementi operativi bipolari

BIPOLARK

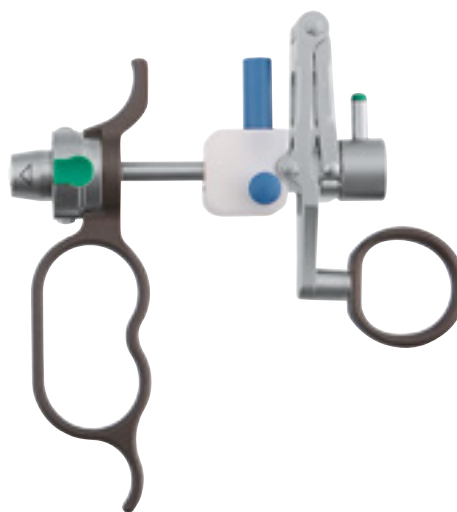

18.5 Charr.  tk 790-570

Arbeitselement, passiv schneidend, einläufig
Working element, passive cutting, single stem

Elément de travail, coupe passive, single-stem
Elemento de trabajo, corte pasivo, un vástago
Elemento operativo passivo, un stelo



		
	18.5 Charr.	
	Schlingenelektrode, gewinkelt 30° <i>Loop electrode, angled 30°</i> Electrode à anse, coudée, 30° <i>Electrodo de asa, angulado 30°</i> Elettrodo ad ansa, angolato 30°	tk 799-576 0°/12°
	Messerelektrode, gewinkelt 90° <i>Knife electrode, angled 90°</i> Electrode à couteau, coudée 90° <i>Electrodo de cuchillo, angulado 90°</i> Elettrodo a bisturi, angolato 90°	tk 799-577 0°/12°
	Rollenelektrode, glatt, Ø 2 mm <i>Roller electrode, smooth, Ø 2 mm</i> Electrode forme rouleau, lisse, Ø 2 mm <i>Electrodo de rollo, liso, Ø 2 mm</i> Elettrodo a ruolo, smusso, Ø 2 mm	tk 799-578 30°
	Kugelelektrode, Ø 2 mm <i>Ball electrode, Ø 2 mm</i> Electrode à boule, Ø 2 mm <i>Electrodo de bola, Ø 2 mm</i> Elettrodo a pallina, Ø 2 mm	tk 799-579 30°

Packung á 6 Stück
Box of 6 pieces
Paquet de 6 pcs.
Paquete de 6 pzas.
Confezione con 6 pezzi

für Optiken
for scopes
pour optiques
para ópticas
per ottiche

Bipolare Resektoskopschäfte
Bipolar resectoscope sheaths

Gaines de résectoscopie bipolaire
Vainas de resectoscopia bipolares
Camicie per resettoscopio bipolari

BIPOLAR **TK**



© 17,5 / © 18.5 Charr. ■	tk 790-573	tk 790-574	tk 790-575
Resektoskopschaft zur Dauerspülung <i>Resectoscope sheath for continuous flow</i>	Außenschaft <i>Outer sheath</i>	Innenschaft <i>Inner sheath</i>	Obturator <i>Obturator</i>
Gaine de résectoscopie à irrigation permanente <i>Vaina de resectoscopio para irrigación continua</i>	Gaine extérieur <i>Vaina exterior</i>	Gaine intérieur <i>Vaina interior</i>	Obturateur <i>Obturador</i>
Camicia resettoscopia a lavaggio continuo	Camicia esterna	Camicia interna	Otturatore
tk 790-572	x	x	x
komplett <i>complete</i>			
complet <i>completo</i>			
completo			

Bipolare Arbeitselemente
Bipolar working elements

Eléments de travail bipolaires
Elementos de trabajo bipolares
Elementi operativi bipolari

BIPOLARK



19 Charr.		tk 799-308
24 Charr.		tk 799-300

passiv schneidend, einläufig
passive cutting, single stem

oupe passive, single-stem
corte pasivo, un vástago
passivo, un stelo



19 Charr.		tk 799-309
24 Charr.		tk 799-305

aktiv schneidend, einläufig
active cutting, single stem

coupe active, single-stem
corte activo, un vástago
operativo attivo, un stelo

Hochfrequenzkabel, bipolar
High frequency cables, bipolar

Câbles de haute fréquence, monopolaire
Cables alta frecuencia, monopolar
Cavi ad alta frequenza, monopolare











TEKNO TOM 411 PRO	tk 707-350	3 m
Geräteseite Unit side Coté appareil Lado equipo Lato elettrobisturi	Instrumentenseite Instrument side Coté instrument Lado instrumento Lato strumento	



Bipolar-Elektroden | Electrodes bipolaires
Bipolar electrodes | *Electrodos bipolares*
 Elettrodi bipolari

BIPOLARK

	19 Charr. 	24 Charr. 		
 <p>Schlingenelektrode, 30°, PI-Cut, extra langlebig <i>Loop electrode, 30°, PI-Cut, extra durable</i> Electrode à anse, 30°, extra durable <i>Electrodo de asa, 30°, extra durable</i> Elettrodo ad ansa, 30°, extra lunga durata</p>	-	tk 799-374	30°	0°/30°
 <p>Schlingenelektrode, 30°, Prostata/Urethra <i>Loop electrode, 30°, Prostate/urethra</i> Electrode à anse, 30°, Prostate/urètre <i>Electrodo de asa, 30°, Próstata/uretra</i> Elettrodo ad ansa, 30°, Prostata/uretra</p>	tk 799-362	tk 799-372	30°	0°/30°
 <p>Schlingenelektrode, 90°, PI-Cut, extra langlebig <i>Loop electrode, 90°, PI-Cut, extra durable</i> Electrode à anse, 90°, extra durable <i>Electrodo de asa, 90°, extra durable</i> Elettrodo ad ansa, 90°, extra lunga durata</p>	-	tk 799-378	0°/ 12°	0°
 <p>Schlingenelektrode, 90°, Prostata/Urethra <i>Loop electrode, 90°, Prostate/urethra</i> Electrode à anse, 90°, Prostate/urètre <i>Electrodo de asa, 90°, Próstata/uretra</i> Elettrodo ad ansa, 90°, Prostata/uretra</p>	-	tk 799-373	0°/ 12°	0°
 <p>Schlingenelektrode, gerade, Prostata/Urethra <i>Loop electrode, straight, Prostate/urethra</i> Electrode à anse, Prostate/urètre <i>Electrodo de asa, Próstata/uretra</i> Elettrodo ad ansa, Prostata/uretra</p>	tk 799-361	tk 799-371	0°/ 12°	0°/ 30°
 <p>Messerelektrode, gewinkelt 90° <i>Knife electrode, angled 90°</i> Electrode à couteau, coudée 90° <i>Electrodo de cuchillo, angulado 90°</i> Elettrodo a bisturi, angolato 90°</p>	tk 799-360	tk 799-350	0°/12°/30°	0°/ 30°
 <p>Kugelelektrode, Ø 3 mm <i>Ball electrode, Ø 3 mm</i> Electrode à boule, Ø 3 mm <i>Electrodo de bola, Ø 3 mm</i> Elettrodo a pallina, Ø 3 mm</p>	tk 799-365	tk 799-355	0°/12°/30°	0°/ 30°

Packung à 6 Stck.
Box of 6 pcs
 Paquet de 6 pcs.
Paquete de 6 pzas.
 Confezione con 6 pezzi





für Optiken
for scopes
 pour optiques
para ópticas
 per ottiche

für Schäfte
for sheaths
 pour gaines
para vainas
 per camicie

Bipolar-Elektroden | Electrodes bipolaires
Bipolar electrodes | *Electrodos bipolares*
 Elettrodi bipolari

BIPOLARK



	19 Charr. 	24 Charr. 		
 <p>Vaporisationselektrode, gerieft, Ø 3 mm <i>Vaporization electrode, serrated, Ø 3 mm</i> Electrode de vaporisation, striée, Ø 3 mm <i>Electrodo de vaporización, estriado, Ø 3 mm</i> Elettrodo per vaporizzazione, scanalato, Ø 3 mm</p>	-	tk 799-354	0°/12°/30°	0°/30°
 <p>Rollenelektrode, glatt, Ø 3 mm <i>Roller electrode, smooth, Ø 3 mm</i> Electrode forme rouleau, lisse, Ø 3 mm <i>Electrodo de rollo, liso, Ø 3 mm</i> Elettrodo a ruolo, smusso, Ø 3 mm</p>	tk 799-366	tk 799-356	0°/12°/30°	0°/30°
 <p>Kegelelektrode <i>Cone electrode</i> Electrode conique <i>Electrodo conico</i> Elettrodo a cono</p>	-	tk 799-357	0°/12°/30°	0°/30°
Packung à 6 Stck. <i>Box of 6 pcs</i> Paquet de 6 pcs. <i>Paquete de 6 pzas.</i> Confezione con 6 pezzi			für Optiken <i>for scopes</i> pour optiques <i>para ópticas</i> per ottiche	für Schäfte <i>for sheaths</i> pour gaines <i>para vainas</i> per camicie

Bipolare Resektoskopschäfte
Bipolar resectoscope sheaths

Gaines de résectoscopie bipolaire
Vainas de resectoscopia bipolares
Camicie per resettoscopio bipolari

BIPOLAR 

drehbar
rotatable
rotative
giratoria
rotante



⊕ 19 / ⊕ 22 Charr. 	tk 799-311	tk 799-312	tk 799-313
Resektoskopschaft zur Dauerspülung <i>Resectoscope sheath for continuous flow</i>	Außenschaft <i>Outer sheath</i>	Innenschaft 30° <i>Inner sheath 30°</i>	Obturator <i>Obturator</i>
Gaine de résectoscopie à irrigation permanente <i>Vaina de resectoscopio para irrigación continua</i>	Gaine extérieur <i>Vaina exterior</i>	Gaine intérieur 30° <i>Vaina interior 30°</i>	Obturateur <i>Obturator</i>
Camicia resettoscopia a lavaggio continuo	Camicia esterna	Camicia interna 30°	Otturatore

tk 799-310	x	x	x
------------	---	---	---

komplett
complete
complet
completo
completo



⊕ 24 / ⊕ 26 Charr. 	tk 799-331	tk 799-332	tk 799-333	tk 799-323
Resektoskopschaft zur Dauerspülung <i>Resectoscope sheath for continuous flow</i>	Außenschaft <i>Outer sheath</i>	Innenschaft 30° <i>Inner sheath 30°</i>	Innenschaft 0° <i>Inner sheath 0°</i>	Obturator <i>Obturator</i>
Gaine de résectoscopie à irrigation permanente <i>Vaina de resectoscopio para irrigación continua</i>	Gaine extérieur <i>Vaina exterior</i>	Gaine intérieur 30° <i>Vaina interior 30°</i>	Gaine intérieur 0° <i>Vaina interior 0°</i>	Obturateur <i>Obturator</i>
Camicia resettoscopia a lavaggio continuo	Camicia esterna	Camicia interna 30°	Camicia interna 0°	Otturatore

tk 799-330	x	x	-	x
tk 799-335	x	-	x	x

komplett
complete
complet
completo
completo

Bipolare Resektoskopschäfte
Bipolar resectoscope sheaths

Gaines de résectoscopie bipolaire
Vainas de resectoscopia bipolares
Camicie per resettoscopio bipolari

BIPOLARK



⊙ 24 / ⊙ 26 Charr.	tk 799-321	tk 799-322	tk 799-324	tk 799-323
Resektoskopschaft zur Dauerspülung <i>Resectoscope sheath for continuous flow</i>	Außenschaft <i>Outer sheath</i>	Innenschaft 30° <i>Inner sheath 30°</i>	Innenschaft 0° <i>Inner sheath 0°</i>	Obturator <i>Obturator</i>
Gaine de résectoscopie à irrigation permanente <i>Vaina de resectoscopia para irrigación continua</i>	Gaine extérieur <i>Vaina exterior</i>	Gaine intérieur 30° <i>Vaina interior 30°</i>	Gaine intérieur 0° <i>Vaina interior 0°</i>	Obturateur <i>Obturador</i>
Camicia resettoscopia a lavaggio continuo	Camicia esterna	Camicia interna 30°	Camicia interna 0°	Otturatore
tk 799-320	x	x	-	x
tk 799-328	x	-	x	x

komplett
complete
complet
completo
completo

Obturatoren
Obturator

Obturateurs
Obturadores
Otturatori

BIPOLARTK



19 Charr.		tk 799-313
24 Charr.		tk 799-323

Standardobturator
Standard obturator

Obturateur standard
Obturador estándar
Otturatore standard



19 Charr.		tk 799-326
24 Charr.		tk 799-327

Sichtobturator für Dauerspülung
Visual obturator for permanent flow

Obturateur visuel pour irrigation permanente
Obturador óptico para irrigación permanente
Otturatore ottico per lavaggio continuo



24 Charr.		- Ø 5 Charr.	tk 799-345
-----------	---	--------------	-------------------

Sichtobturator mit einem Instrumentenkanal
Visual obturator with one instrument channel

Obturateur visuel avec canal d'instruments
Obturador óptico con un canal para instrumentos
Otturatore ottico con un canale per strumenti

Laser Resektoskop Arbeitselement
Laser resectoscope working element

Elément de travail pour le laser
 Elemento de trabajo para el laser
 Elemento operativo per ressectoscopia laser



0.8 mm - 800 µm	tk 790-808	tk 790-809	tk 700-074 (0°) tk 700-075 (12°) tk 700-078 (30°)	tk 790-320
1.0 mm - 1000 µm	tk 790-810	tk 790-811		tk 790-490
1.2 mm - 1200 µm	tk 790-812	tk 790-813		tk 790-330
1.4 mm - 1400 µm	tk 790-814	tk 790-815		tk 790-315

Führungsrohr
 Guiding tube

Lasersonde
 Laser probe

mit Abhalter
 with spreader

für Optiken
 for scopes

für Schäfte
 for sheaths

Gaine de guidage
 Vaina de guía

Sonde de laser
 Sonda de laser

avec écarteur
 con separador

pour optiques
 para ópticas

pour gaines
 para vainas

Camicia da guida

Sonda di laser

con divaricatore

per ottiche

per camicie

tk 790-807

Laser-Arbeitselement für auswechselbare Führungsrohre, passiv
 Laser working element for exchangeable fiber guides, passive

Élément de travail passive, laser pour gaines interchangeables
 Elemento de trabajo passivo, laser para vainas intercambiables
 Elemento di lavoro laser passivo per tubi intercambiabile

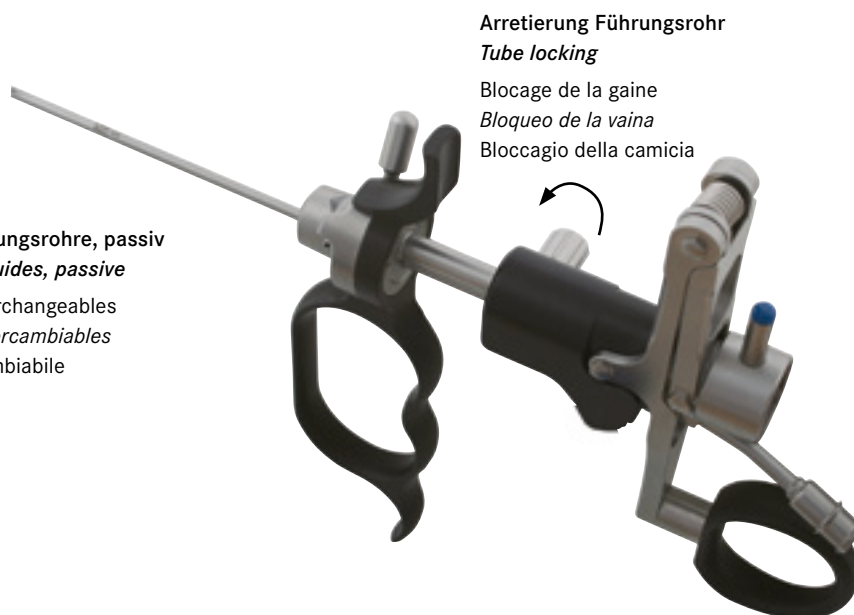

Arretierung Führungsrohr
 Tube locking

Blocage de la gaine
 Bloqueo de la vaina
 Bloccaggio della camicia

Laser Resektoskop Arbeitselement
Laser resectoscope working element

Elément de travail pour le laser
Elemento de trabajo para el laser
 Elemento operativo per resetroscopio laser



0.8 mm - 800 µm	tk 790-800	tk 700-074 (0°) tk 700-075 (12°) tk 700-078 (30°)	tk 790-320 tk 790-490 tk 790-330 tk 790-315
1.2 mm - 1200 µm	tk 790-801		
2.2 mm - 2200 µm	-		

für Lasersonden bis max. Ø
for laser probes up to Ø
 pour fibres de laser à Ø
 para fibras de laser hasta Ø
 per fibre di laser fino a Ø

für Optiken
for scopes
 pour optiques
 para ópticas
 per ottiche

für Schäfte
for sheaths
 pour gaines
 para vainas
 per camicie



tk 790-820

Ansatz zur Lasersonden-Aufnahme mit Luer-Lock Anschluss, drehbar
Approach to laser probe admission with Luer-Lock connection, rotatable

Approche à l'admission de la sonde laser avec connexion Luer-Lock, rotatives
Approximador a admission de sonda laser con connexion Luer-Lock, rotabile
 Approccio all'ammissione della sonda laser con connessione Luer-Lock, girevoli



ENDOSCOPY



Geräte | Appareils
Units | Equipos
Apparecchi



ELECTRO SURGERY



Elektro Chirurgie | Electrochirurgie
Electro surgery | Electro-Chirgie
Elettrochirurgia



Bitte fordern Sie unseren Spezialkatalog an.
Please ask for our special catalogue.

Veuillez demander pour notre catalogue spécial.
Por favor pregunte por el catalogo especial.

Per favore domandate per il nostro catalogo speciale.

Systemübersicht
System overview

Aperçu général du système
Vista general del sistema
Visione sul sistema

⊕ 19 / ⊕ 21 Charr.

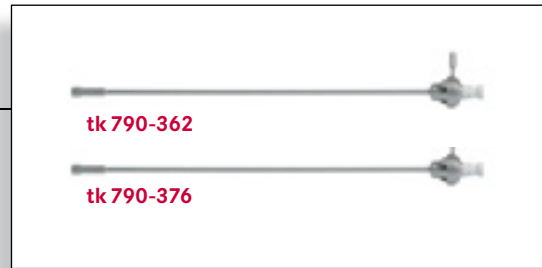
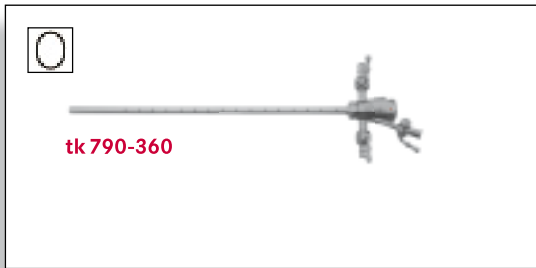
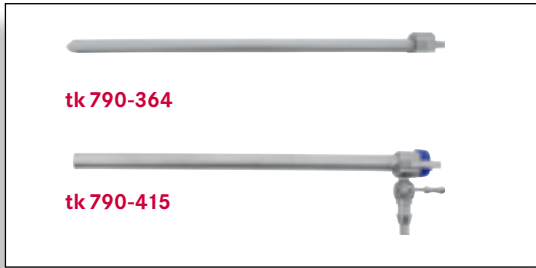

6

⊕ 19 / ⊕ 15.5 Charr.

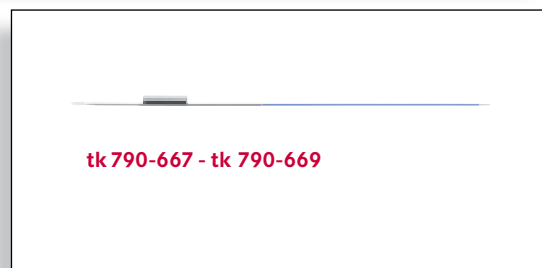
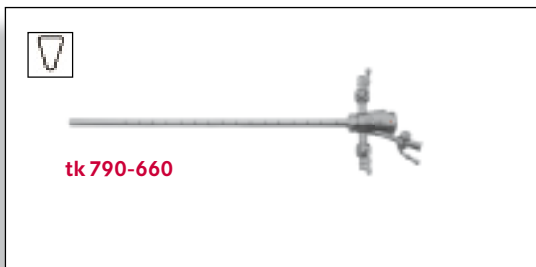

Systemübersicht
System overview

Aperçu général du système
Vista general del sistema
Visione sul sistema

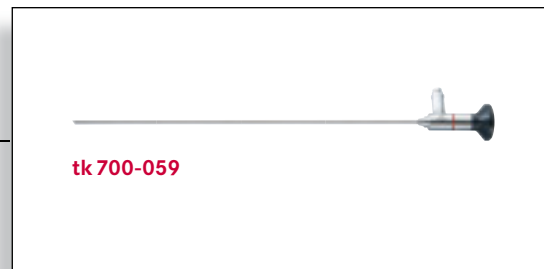
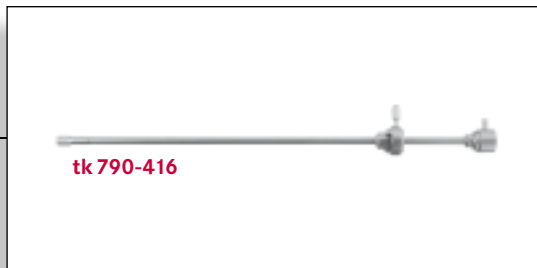
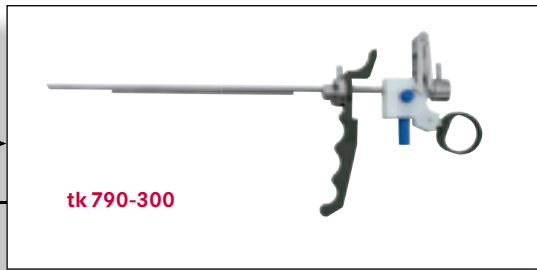

Urethrotom | Uréthrotome
 Urethrotome | Uretrótomo
 Uretrotomo

autoklavierbar / autoclavable
 134°C / 273°F - 18 min.

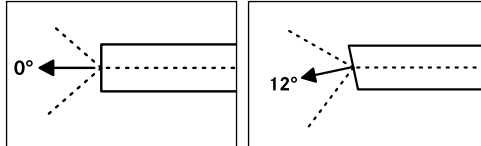

Ø 2.9 mm - 302 mm	tk 700-059	-
Ø 4.0 mm - 302 mm	tk 700-074	tk 700-075
Ø 4.0 mm - 302 mm	tk 700-074 SF	tk 700-075 SF

Arbeitslänge

Working length

Longueur de travail

Longitud de trabajo

Lunghezza operativa

SF = Tekno-Flex



15.5 Charr. <input type="checkbox"/>	tk 790-665
21 Charr. <input type="checkbox"/>	tk 790-300

Arbeitselement, passiv schneidend, einläufig

Working element, passive cutting, single stem,

Elément de travail, coupe passive, single-stem

Elemento de trabajo, corte pasivo, un vástago

Elemento operativo passivo, un stelo



Arbeitselemente nicht mit HF-Strom verwenden!

Do not use working elements with HF power!

Ne pas utiliser les transporteurs avec courant HF!

No se deben usar los transportadores con corriente AF!

Non usare gli elementi di lavoro con corrente AF!

Urethrotomschaft
Urethrotome sheath

Gaine d'uréthrotome
Vaina para uretrótomo
Camicia di uretrotomo

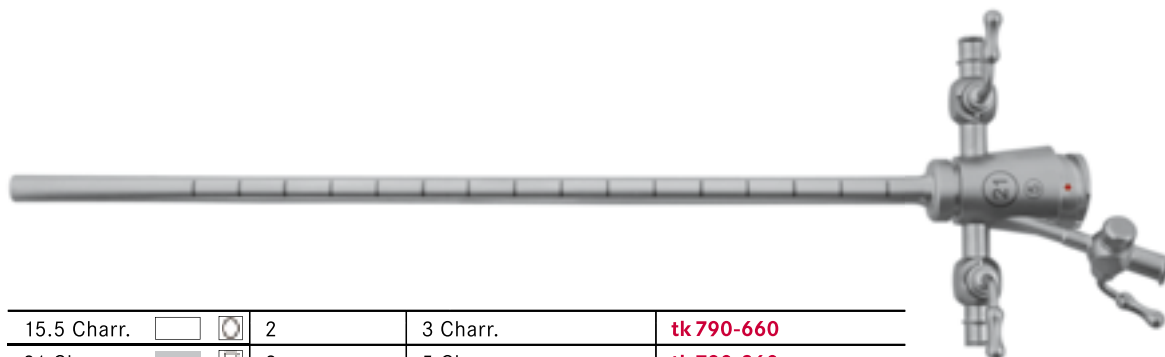

15.5 Charr.			2	3 Charr.	tk 790-660
21 Charr.			2	5 Charr.	tk 790-360

Hähne	Instrumentenkanal	Scala (Einteilung = 10 mm)
Stopcocks	Instrument channel	Scale (Division = 10 mm)
Robinets	Canal d'instruments	Échelle (Division = 10 mm)
Llaves	Canal para instrumentos	Escala (División = 10 mm)
Rubinetti	Canale per strumenti	Scala (Graduazione = 10 mm)



15.5 Charr.		tk 790-662
21 Charr.		tk 790-362

Obturator für Urethrotomschaft tk 790-360
Obturator for urethrotome sheath tk 790-360

Obturateur pour gaine tk 790-360
Obturator para vaina tk 790-360
Otturatore per camicia tk 790-360



21 Charr.		tk 790-376
-----------	--	-------------------

Obturator mit Instrumentenkanal, 5 Charr.
Obturator with instrument channel, 5 Charr.
Obturateur avec canal d'instruments, 5 Charr.
Obturator con canal para instrumentos, 5 Charr.
Otturatore con canale per strumenti, 5 Charr.



21 Charr.		tk 790-416
-----------	--	-------------------

Sichtobturator für tk 790-360
Visual obturator for tk 790-360
Obturateur visuel pour tk 790-360
Obturator óptico para tk 790-360
Otturatore visivo per tk 790-360

Urethrotomschaft
Urethrotome sheath

Gaine d'uréthrotome
Vaina para uretrótomo
Camicia di uretrotomo



21 Charr. tk 790-364

Führungsrohr zum Legen eines Ballon-Katheters
Guide tube for insertion of balloon catheters

Guide pour introduire des cathéters
Guía tubo para introducción de catéteres
Camicia guida per introduzione catetere a balloncino

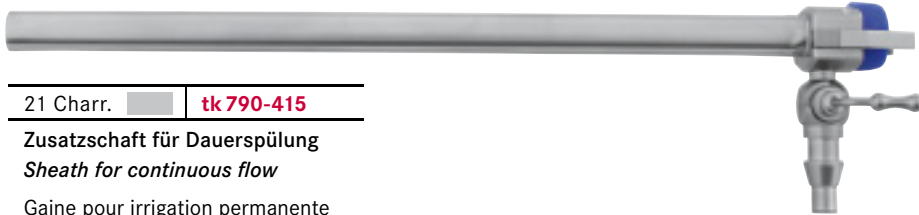

21 Charr. tk 790-415

Zusatzschaft für Dauerspülung
Sheath for continuous flow

Gaine pour irrigation permanente
Vaina para irrigación permanente
Camicia per lavaggio continuo

Optik Brücke
Telescope bridge

Ponts pour télescopes
Puentes ópticos
Ponti per cistoscopi

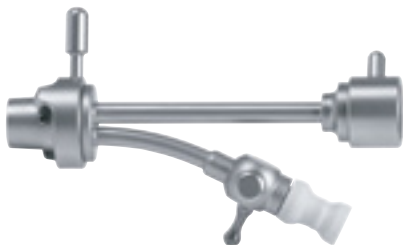

15.5 Charr. tk 790-666

21 Charr. tk 790-366

Untersuchungseinsatz mit 1 Instrumentenkanal, 5 Charr.
Telescope bridge with 1 instrument channel, 5 Charr.

Pont pour télescope avec 1 canal d'instruments, 5 Charr.
Puente operativo con un canal para instrumentos, 5 Charr.
Ponte operativo ad 1 canale per strumenti, 5 Charr.

Strikturmesser
Cold knives

 Bistouris pour uréthrotome
 Cuchillos de uretrótomo
 Bisturi uretrotomo

Einläufig, zum Gebrauch nur mit Arbeitselement Seite 52

Single stem, for use only with working element page 52

Single stem, pour l'usage seulement avec transporteur page 52

Un vástago, uso solamente con el elemento de trabajo pagina 52

Un stelo, utilizzo solamente con elemento operativo pagina 52

Strikturmesser nicht mit HF-Strom verwenden!
Do not use cold knives with HF power!

Ne pas utiliser les bistouris avec courant HF!

No se deben usar los cuchillos con corriente AF!

Non usare gli bisturi con corrente AF!



15.5 Charr. <input type="checkbox"/>	-	tk 790-667	tk 790-668	-	tk 790-669
21 Charr. <input type="checkbox"/>	tk 790-369	tk 790-368	tk 790-410	tk 790-411	tk 790-412

einläufig
single stem

single stem

un vástago

un stelo

21 Charr.	tk 790-369 DL	tk 790-368 DL	-	-	-
doppelläufig	Rund	Gerade	Wellenschliff gerade	Ringförmig	Hakenförmig
<i>double stem</i>	<i>Round</i>	<i>Straight</i>	<i>Wave cut, straight</i>	<i>Ring shaped</i>	<i>Hook shaped</i>
double stem	Circulaire	Droit	Dentelé, droit	Anneau	Crochet
<i>doble vástago</i>	<i>Redondo</i>	<i>Recto</i>	<i>Ondulado, recto</i>	<i>Forma de anillo</i>	<i>Forma de gancho</i>
doppio stelo	Rotondo	Retto	Seghettato, retto	Ad anello	Ad uncino

tk 790-374
Schutzhülse zur Sterilisation von Strikturmessern
Protection tube for sterilization of cold knives

Tube de protection et stérilisation des bistouris

Tubo protector para la esterilización de los cuchillos

Tubo di protezione per sterilizzazione degli bisturi

OTIS Urethrotom
OTIS Urethrotome

OTIS Urétrotome
OTIS Uretrótomo
OTIS Uretrotomo



	tk 30424-10	tk 30424-00	tk 30424-01	tk 30424-02	tk 30424-03
	1x Dilatator 1x Dilator	2x Messer 2x Blades	1x Ansatz, konisch 1x Conical tip	1x Ansatz, flach 1x Flat tip	1x Ansatz, Kugel 1x Ball tip
	1x Dilatateur 1x Dilatador	2x Couteaux 2x Cuchillos	1x Embout conique 1x Terminal cónico	1x Embout plat 1x Terminal plano	1x Embout sphérique 1x Terminal esférico
	1x Dilatatore	2x Coltelli	1x Terminale conico	1x Terminale piatto	1x Terminale sferico
tk 30423-00	x	x	x	x	x

Komplett im Holzetui, bestehend aus:

Complete in wooden case, consisting of:

Complet en boîte de bois, se composant de:

Completo en estuche de madera, compuesto de:

Completo in astuccio di legno, composto di:

Uretero-Renoskopie
Uretero-renoscopy

 Uretero-rénoscopie
Uretero-renoscopia
 Uretero-renosconio

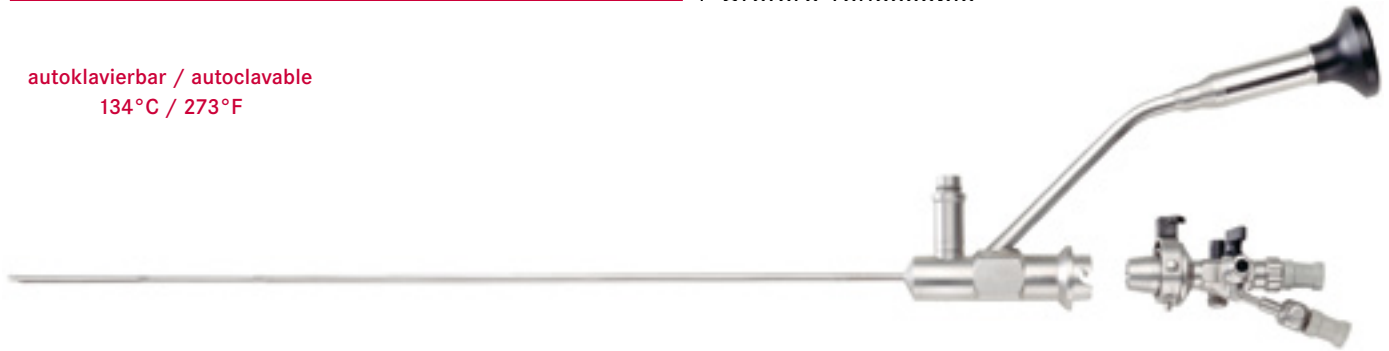
 autoklavierbar / autoclavable
 134°C / 273°F

Ø 6 / 7.5 Charr. – 425 mm	1 x 4 or 2 x 2,4 Charr.	tk 790-390
Ø 6 / 7.5 Charr. – 310 mm	1 x 4 or 2 x 2,4 Charr.	tk 790-391
Ø 7.5 / 9.8 Charr. – 425 mm	1 x 5 or 2 x 3 Charr.	tk 790-380
Ø 7.5 / 9.8 Charr. – 310 mm	1 x 5 or 2 x 3 Charr.	tk 790-381

Halbstarres Uretero-Renoskop 12°
Semirigid Uretereo-renoscope 12°
 Uretero-renoscope 12°, semi-rigide
Uretero-renoscopia 12°, semi-rigido
 Uretero-renoscopia semirigido 12°

2 Instrumentenkanäle
2 Instrument channels
 2 Canaux d'instruments
2 Canales para instrumentos
 2 Canali operativi

 Weitere Modelle auf Anfrage
Other models on request

 Autres modèles sur demande
Otros modelos sobre demanda
 Altre modelli disponibili su richiesta

tk 790-384

Adapter für EMS® Swiss Lithoclast 1
Adaptor for EMS® Swiss Lithoclast 1
 Adaptateur pour EMS® Swiss Lithoclast 1
Adaptador para EMS® Swiss Lithoclast 1
 Adattatore per EMS® Swiss Lithoclast 1

tk 790-404

Adapter für EMS® Swiss Lithoclast 2
Adaptor for EMS® Swiss Lithoclast 2
 Adaptateur pour EMS® Swiss Lithoclast 2
Adaptador para EMS® Swiss Lithoclast 2
 Adattatore per EMS® Swiss Lithoclast 2



Ø 7.5 / 10.0 Charr. – 425 mm	1 x 5 or 2 x 3 Charr.	tk 790-394
Ø 7.5 / 10.0 Charr. – 310 mm	1 x 5 or 2 x 3 Charr.	tk 790-395

Halbstarres Uretero-Renoskop 12°
Semirigid Uretereo-renoscope 12°
 Uretero-renoscope 12°, semi-rigide
Uretero-renoscopia 12°, semi-rigido
 Uretero-renoscopia semirigido 12°

2 Instrumentenkanäle
2 Instrument channels
 2 Canaux d'instruments
2 Canales para instrumentos
 2 Canali operativi

 Ø 1.65 mm / 600 mm **tk 790-409**

Flexible Reinigungsbürste
Flexible cleaning brush
 Brosse de nettoyage flexible
Cepillo flexible
 spazzolino flessibile per pulizia

 Ø 3.9 mm **tk 790-408**

Silikon-Automatikventil (Pack á 5 Stück) für Brücke
Silicone automatic valve (5 pieces per package) for bridge
 Valva automatica en silicone (paq á 5 pcs.) pour poat d'optique
Valva automatica de sílicona (paq de 5 pzas.) para puente
 Valvola automatica in silicone (conf. da 5 pezzi) per poute per otiche

Instrumente für die Uretero-Renoskopie
Uretero renoscopy instruments

Instrumentos pour l'uretero-rénoscopie
Instrumentos par la uretero-renoscopia
Strumenti di uretero-renoscopia

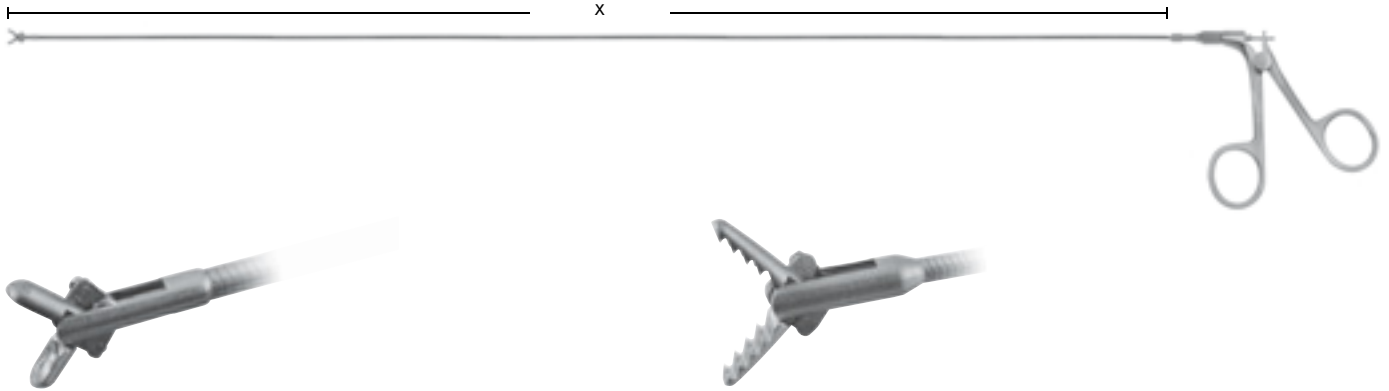

	x = 60 cm	x = 60 cm
Ø 1.0 mm - 3 Charr.	tk 794-390	tk 794-391
Ø 1.6 mm - 5 Charr.	tk 790-385	tk 794-385

Biopsiefassszange <i>Biopsy grasping forceps</i>	halbstarr <i>semi-rigid</i>	flexibel <i>flexible</i>
Pince à biopsie	semi-rigide	flexible
Pinza para biopsia	semi-rígida	flexible
Pinza per biopsia	semi-rigida	flessibile

	x = 60 cm	x = 60 cm
Ø 1.0 mm - 3 Charr.	tk 794-392	tk 794-393
Ø 1.6 mm - 5 Charr.	tk 790-386	tk 794-386

Fremdkörperfasszange <i>Foreign body grasping forceps</i>	halbstarr <i>semi-rigid</i>	flexibel <i>flexible</i>
Pince corps étrangers	semi-rigide	flexible
Pinza cuerpos extraños	semi-rígida	flexible
Pinza corpi estranei	semi-rigida	flessibile



	x = 60 cm	x = 60 cm
Ø 1.0 mm - 3 Charr.	tk 794-394	tk 794-395
Ø 1.6 mm - 5 Charr.	tk 790-387	tk 794-387

Schere <i>Scissors</i>	halbstarr <i>semi-rigid</i>	flexibel <i>flexible</i>
Ciseaux	semi-rigide	flexible
Tijera	semi-rígida	flexible
Forbice	semi-rigida	flessibile



	x = 60 cm	x = 60 cm
Ø 1.6 mm - 5 Charr.	tk 790-388	tk 794-388

Fremdkörperfasszange <i>Foreign body grasping forceps</i>	halbstarr <i>semi-rigid</i>	flexibel <i>flexible</i>
Pince corps étrangers	semi-rigide	flexible
Pinza cuerpos extraños	semi-rígida	flexible
Pinza corpi estranei	semi-rigida	flessibile



	x = 60 cm	x = 60 cm
Ø 1.6 mm - 5 Charr.	tk 790-389	tk 794-389

Fasszange <i>Grasping forceps</i>	halbstarr <i>semi-rigid</i>	flexibel <i>flexible</i>
Pince à saisir	semi-rigide	flexible
Pinza de agarre	semi-rígida	flexible
Pinza da presa	semi-rigida	flessibile

Systemübersicht
System overview

Aperçu général du système
Vista general del sistema
Visione sul sistema

15/18 Charr.	■
16.5/19.5 Charr.	■
21/24 Charr.	■

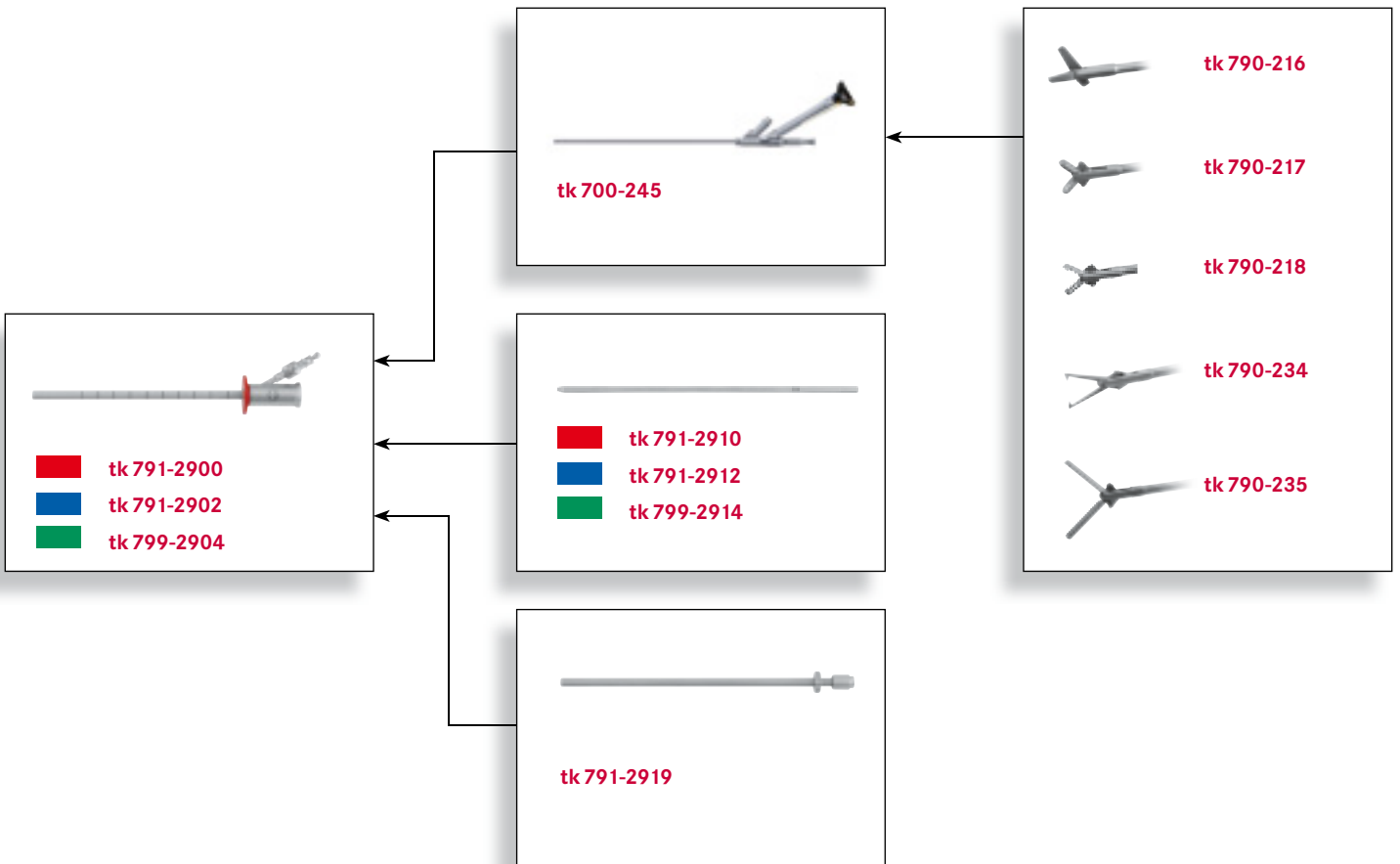

Perkutane Mini Nephroskopie
Percutaneous mini nephroscopy

Mini néphroscopie percutanée
Mini nefroscopia percutanea
 Mini nefroscopia percutanea

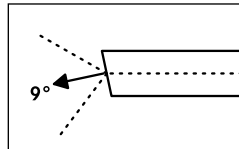

Ø 4.0 mm - 220 mm	Ø 6.6 Charr.	tk 700-245
-------------------	--------------	-------------------

Arbeitslänge <i>Working length</i>	Instrumentenkanal <i>Instrument channel</i>
Longueur de travail <i>Longitud de trabajo</i>	Canal d'instruments <i>Canal para instrumentos</i>
Lunghezza operativa	Canale operativo



tk 95010-00

Dichtungskappe, Silikon, (10 Stück)
Silicon cap, (10 pieces)
 Capuchon de silicon, (10 pièces.)
Capuchón de silicona, (10 piezas)
 Tappo in silicone, (10 pezzi)

tk 790-406

Silikon-Automatikventil für tk 790-407
Silicone automatic valve for tk 790-407
 Valva automatique en silicone pour tk 790-407
Valva automatica de silicona para tk 790-407
 Valvola automatica in silicone per tk 790-407





tk 790-407

Adapter mit Silikon-Valve für Nephroskop
Silicone valve adapter for nephroscope
 Adaptateur avec valve en silicone pour nephroscope
Adaptador con valvula de silicona para nefroscopio
 Adattatore con valvola di silicone per nefroscopia

Schäfte für Mini Nephroskopie
Sheaths for mini nephroscopy

Gaines pour mini Néphroscopie
Vainas para mini Nefroscopia
Camicie per mini Nefroscopia





15/18 Charr.		tk 791-2900
16.5/19.5 Charr.		tk 791-2902
21/24 Charr.		tk 791-2904

Schaft zur Dauerspülung
Sheath for continuous flow

Gaine á irrigation permanente
Vaina para irrigación continua
Camicia per flusso continuo



15/18 Charr.		1 x 3 Charr.	tk 791-2910
16.5/19.5 Charr.		2 x 3 Charr.	tk 791-2912
21/24 Charr.		2 x 5 Charr.	tk 791-2914

für Schäfte
for sheaths

pour gaines
para vainas
per camicie

Instrumentenkanal
Instrument channel

Canal d'instruments
Canal para instrumentos
Canale per strumenti

„one-step“ Dilatator
“one-step” Dilator

«one-step» Dilatateur
“one-step” Dilatador
“one-step” Dilatore



15/18 Charr.		tk 791-2919
16.5/19.5 Charr.		
21/24 Charr.		

Kanüle zur Applikation von Medikamenten
Cannula for application of medicine

Canule pour l'application des médicaments
Cánula para la aplicación de medicamentos
Cannula per la applicazione di medicinali

Instrumente für die perkutane Mini Nephroskopie
Instruments for percutaneous mini nephroscopy

Instrumentos para la mini nefroscopia percutánea
 Strumenti per la mini nefroscopia percutanea

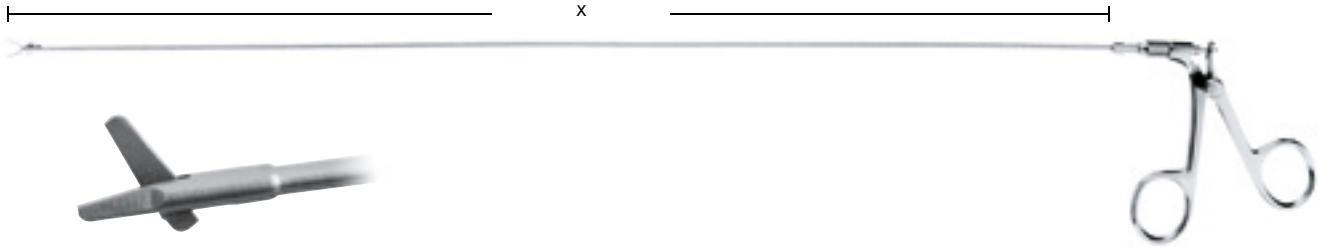

	x= 40 cm
5 Charr.	tk 790-216
Scheren	halbstarr
Scissors	semi-rigid
Ciseaux	semi-rigide
Tijeras	semi-rigido
Forbice	semi rigida



	x= 40 cm
5 Charr.	tk 790-217
Biopsiezange, Löffel oval	halbstarr
<i>Biopsy forceps, oval spoon</i>	semi-rigid
Pince à biopsie, mors oval	semi-rigide
<i>Pinza para biopsia, cuchara oval</i>	semi-rigido
<i>Pinza da biopsia a cucciaio ovale</i>	semi rigida



	x= 40 cm
5 Charr.	tk 790-234
Fasszange	halbstarr
<i>Grasping forceps</i>	semi-rigid
Pince à saisir	semi-rigide
<i>Pinza de agarre</i>	semi-rigida
<i>Pinza da presa</i>	semi-rigida



	x= 40 cm
5 Charr.	tk 790-218
Biopsiezange, Löffel oval, gezahnt	halbstarr
<i>Biopsy forceps, oval spoon, serrated</i>	semi-rigid
Pince à biopsie, mors oval, dentelée	semi-rigide
<i>Pinza para biopsia, cuchara oval, dentado</i>	semi-rigido
<i>Pinza da biopsia a cucciaio ovale, dentellata</i>	semi rigida



	x= 40 cm
5 Charr.	tk 790-235
Fremdkörperfasszange	halbstarr
<i>Foreign body grasping forceps</i>	semi-rigid
Pince corps étrangers	semi-rigide
<i>Pinza cuerpos extraños</i>	semi-rigida
<i>Pinza corpi estranei</i>	semi-rigida

Systemübersicht
System overview

Aperçu général du système
Vista general del sistema
Visione sul sistema

for nephroscopes working length: 200 mm	⊙ 24 Charr.	■
	⊙ 26 Charr.	■
for nephroscopes working length: 250 mm	⊙ 24 Charr.	■
	⊙ 26 Charr.	■

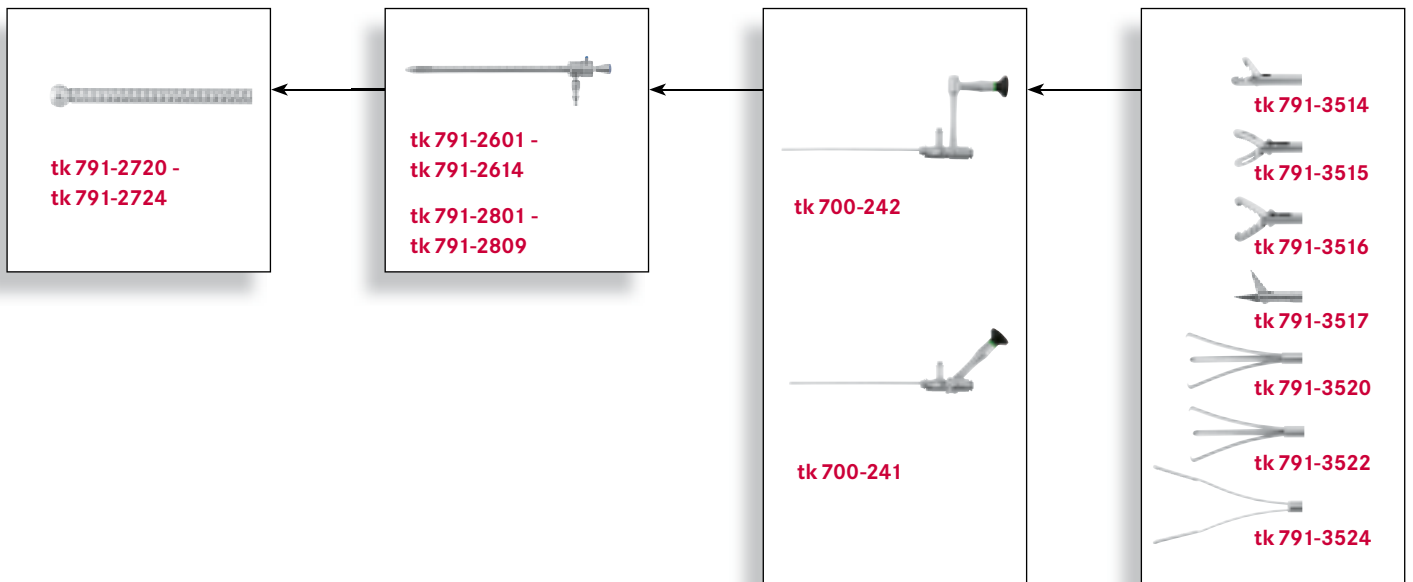

Perkutane Nephroskopie
Percutaneous nephroscopy

Néphroscopie percutanée
Nefroscopia percutanea
Nefroscopia percutanea

Nephroskop mit 90° abgewinkeltem Doppelprismenokular und integriertem Spülkanal
Nephroscope with angled 90° doubleprism ocular and integrated irrigation channel
Nephroscope, avec oculaire de double prismes, coudé 90° et canal d'irrigation
Nefroscopio, con ocular de doble prisma, angulado 90°, con canal de irrigación
Nefroscopio con oculare di doppio prisma, angolato a 90° e canale di lavaggio integrato

autoklavierbar / autoclavable
134°C / 273°F

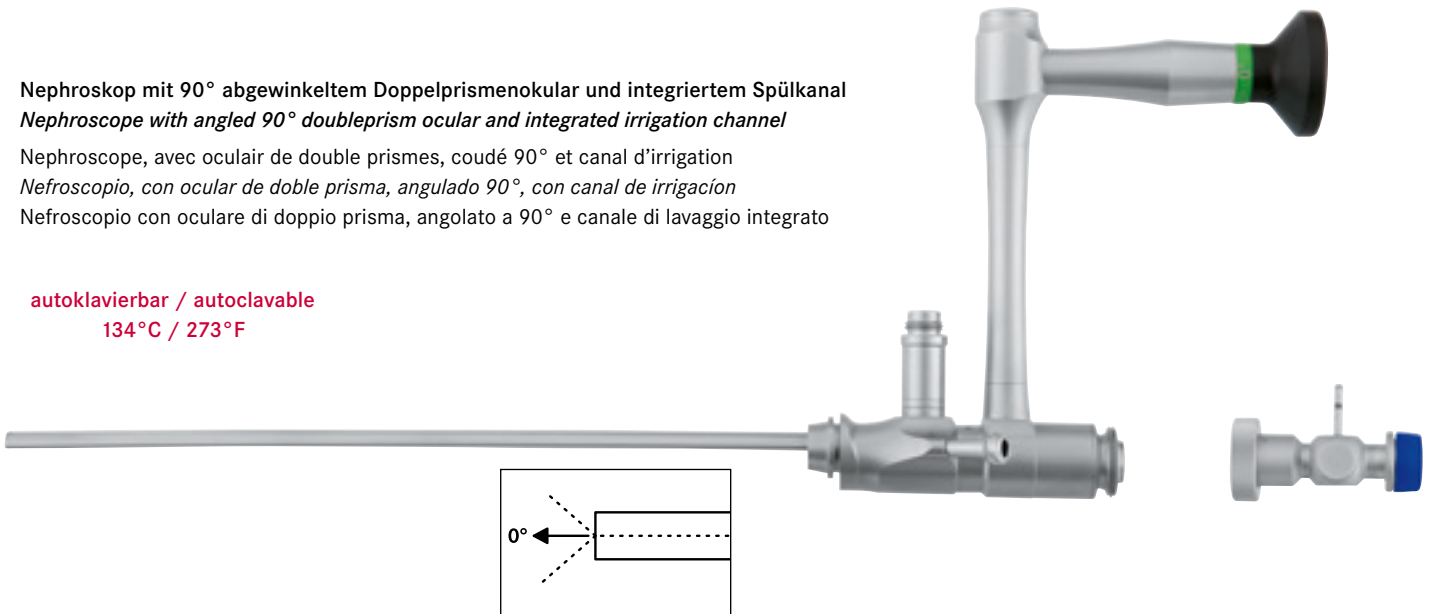

Ø 7.40 mm - 200 mm	Ø 5.0 mm	tk 700-242
Arbeitslänge <i>Working length</i>	Instrumentenkanal <i>Instrument channel</i>	inkl. Adapter <i>incl. adapter</i>
Longueur de travail <i>Longitud de trabajo</i>	Canal d'instruments <i>Canal para instrumentos</i>	incl. adaptateur <i>incl. adaptador</i>
Lunghezza operativa	Canale operativo	incl. adattatore

tk 700-243
Adapter <i>Adapter</i>
Adaptateur <i>Adaptador</i>
Adattatore

Nephroskop mit 45° abgewinkeltem Okular und integriertem Spülkanal
Nephroscope with angled ocular 45° and integrated irrigation channel
Nephroscope, avec oculaire coudé 45° et canal d'irrigation
Nefroscopio, con ocular angulado 45°, con canal de irrigación
Nefroscopio con oculare angolato a 45° e canale di lavaggio integrato

autoklavierbar / autoclavable
134°C / 273°F

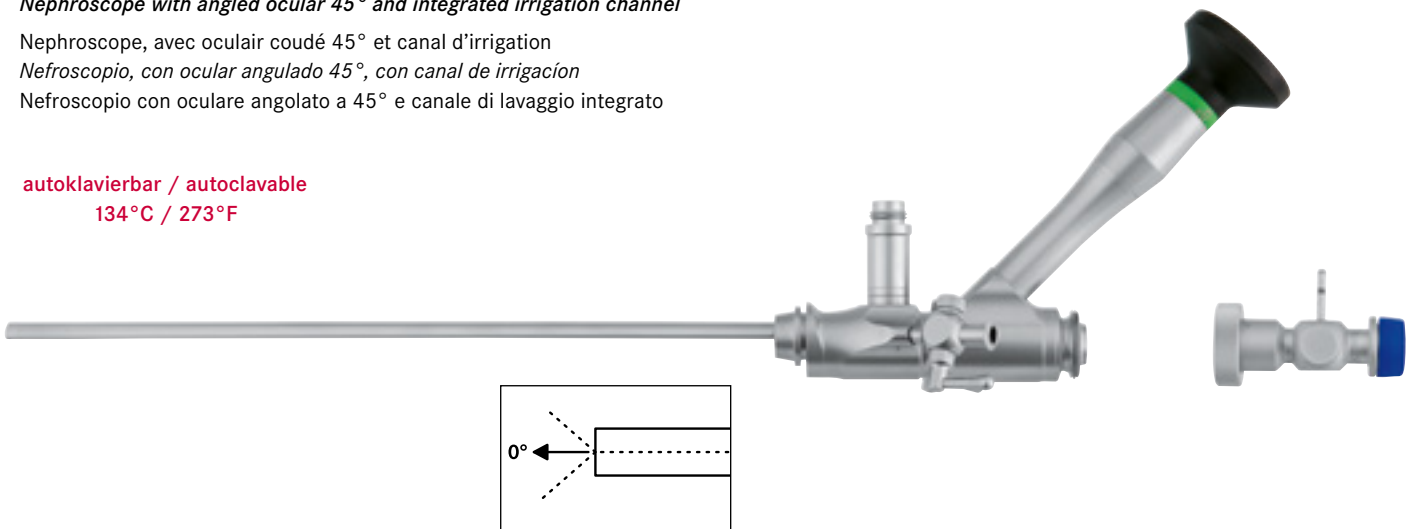

Ø 7.40 mm - 200 mm	Ø 5.0 mm	tk 700-241
Arbeitslänge <i>Working length</i>	Instrumentenkanal <i>Instrument channel</i>	inkl. Adapter <i>incl. adapter</i>
Longueur de travail <i>Longitud de trabajo</i>	Canal d'instruments <i>Canal para instrumentos</i>	incl. adaptateur <i>incl. adaptador</i>
Lunghezza operativa	Canale operativo	incl. adattatore

tk 700-243
Adapter <i>Adapter</i>
Adaptateur <i>Adaptador</i>
Adattatore

Schäfte für Perkutane Nephroskopie
Sheaths for percutaneous nephroscopy

Gaines pour la néphroscopie percutanée
Vainas para la nefroscopia percutanea
Camicie per la nefroscopia percutanea 360°

drehbar
rotatable
rotative
giratoria
rotante



for nephroscopes working length: 200 mm	⊘ 24 Charr.	■	-	tk 791-2805
	⊘ 26 Charr.	■	tk 791-2601	tk 791-2602
for nephroscopes working length: 250 mm	⊘ 24 Charr.	■	-	tk 791-2806
	⊘ 26 Charr.	■	tk 791-2608	tk 791-2610

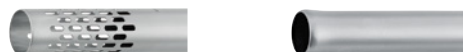

for nephroscopes working length: 200 mm	⊘ 24 Charr.	■	-	tk 791-2801
	⊘ 26 Charr.	■	tk 791-2604	tk 791-2606
for nephroscopes working length: 250 mm	⊘ 24 Charr.	■	-	tk 791-2802
	⊘ 26 Charr.	■	tk 791-2612	tk 791-2614



tk 791-2725

Punktionskanüle zur Lokalisation von Nierensteinen
Punction cannula for the localization of kidney stones

Canule de ponction pour la localisation des calculs rénales
Cánula de punción para la localización de cálculos renales
Cannula per punzione per la localizzazione dei calcoli renali

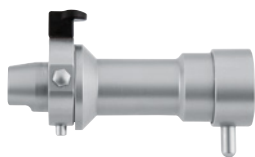

tk 791-2740

Adapter zur Verwendung mit Resektoskopschäften
Adapter for use with resectoscope sheaths

Adaptateur pour avec gaines de resectoscopie
Adaptador para con vainas de resectoscopia
Adattatore per camicie di resettoscopia



Set 9 - 24 Charr.	tk 791-2720
27 Charr.	tk 791-2721
30 Charr.	tk 791-2722

Teleskop Dilatator
Telescop dilatator
Dilateur telescopique
Dilatador telescopio
Dilatatore telescopico



tk 791-2723

Führungssonde starr
Guiding probe, rigid
Gaine de guidace, rigide
Vaina de guíca, rigida
Camicia du guida, rigida

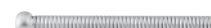

tk 791-2724



flexibel
flexible
flexible
flejible
flessibile

Instrumente für die Perkutane Nephroskopie
Instruments for percutaneous Nephroscopy

Instrumentos para la nefroscopia percutánea
Strumenti per la nefroscopia percutanea



1:1

x = 350 mm	Ø 3.5 mm - 10.0 Charr.	
<p>Biopsiezange, Löffel oval, einseitig öffnend <i>Biopsy forceps, oval spoon, single action</i></p> <p>Pince à saisir des biopsie, mors oval, articulación simple <i>Pinza para biopsia, cuchara oval, articulación simple</i> <i>Pinza da biopsia a cucchiaino ovale, singola azione</i></p>	tk 791-3514	
 <p>1:1</p>	<p>Faßzange für Steinfragmente, beidseitig öffnend <i>Grasping forceps for stone fragments, double action</i></p> <p>Pince à saisir des calculs, articulación double <i>Pinza de agarre, doble articulación</i> <i>Pinza da presa, doppia azione</i></p>	tk 791-3515
 <p>1:1</p>	<p>Faßzange für Steinfragmente, beidseitig öffnend <i>Grasping forceps for stone fragments, double action</i></p> <p>Pince à saisir des calculs, articulación double <i>Pinza de agarre, doble articulación</i> <i>Pinza da presa, doppia azione</i></p>	tk 791-3516
 <p>1:1</p>	<p>Mikro-Schere, einseitig öffnend <i>Micro scissors, single action</i></p> <p>Micro-ciseaux, articulación simple <i>Micro-tijera, articulación simple</i> <i>Micro-forbice, singola azione</i></p>	tk 791-3517

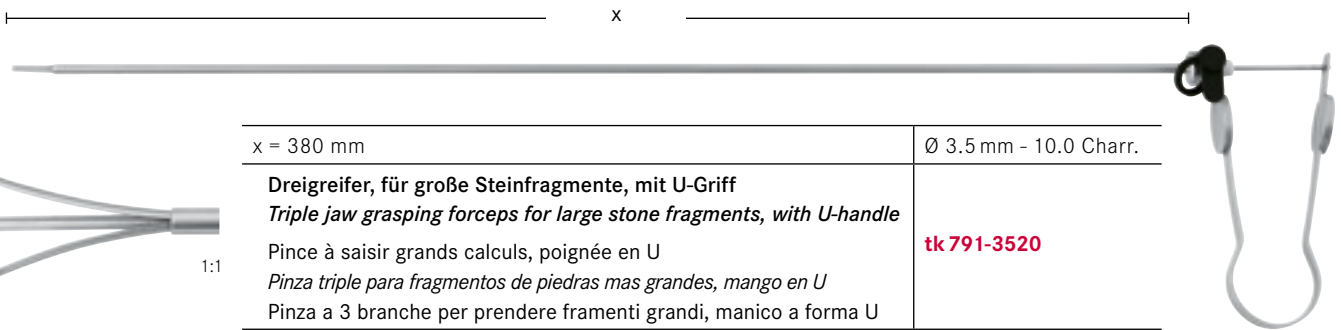

1:1



1:1



1:1

x = 380 mm	Ø 3.5 mm - 10.0 Charr.
<p>Dreigreifer, für große Steinfragmente, mit U-Griff <i>Triple jaw grasping forceps for large stone fragments, with U-handle</i></p> <p>Pince à saisir grands calculs, poignée en U <i>Pinza triple para fragmentos de piedras mas grandes, mango en U</i> <i>Pinza a 3 branche per prendere frammenti grandi, manico a forma U</i></p>	tk 791-3520
<p>Dreigreifer, für kleine Steinfragmente, mit U-Griff <i>Triple jaw grasping forceps for small stone fragments, with U-handle</i></p> <p>Pince à saisir petits calculs, poignée en U <i>Pinza triple para fragmentos de piedras pequeños, mango en U</i> <i>Pinza a 3 branche per prendere frammenti piccoli, manico a forma U</i></p>	tk 791-3522
<p>Zange zum Fassen von Steinfragmenten, mit U-Griff <i>Grasper for stone fragments, with U-handle</i></p> <p>Pince à saisir fragments des calculs, poignée en U <i>Pinza para coger fragmentos de cálculos, mango en U</i> <i>Pinza per afferrare frammenti di calcoli, manico a forma U</i></p>	tk 791-3524

Kinder-Optiken
Paediatric scopes

Optiques pédiatriques
Ópticas pediátricas
Ottiche pediatrici

autoklavierbar / autoclavable
134°C / 273°F - 18 min.

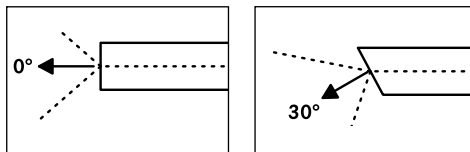
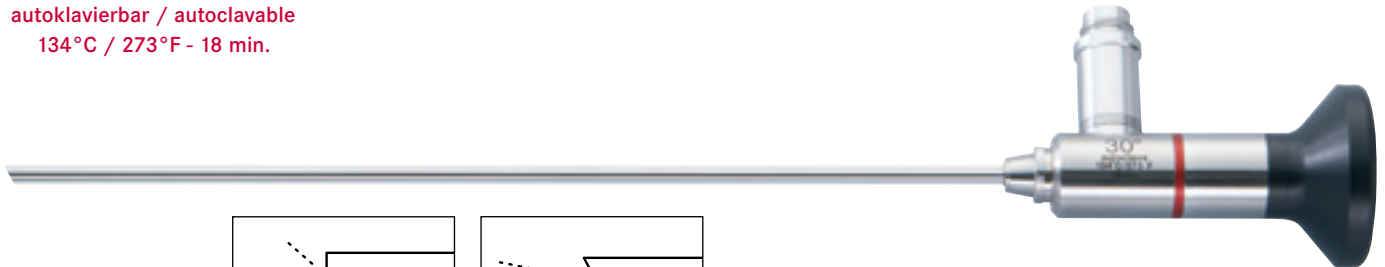

Ø 1.9 mm - 117 mm	tk 700-274	tk 700-277
Ø 1.9 mm - 187.5 mm	tk 700-271	tk 700-272
Ø 2.7 mm - 187.5 mm	tk 700-270	tk 700-273
Ø 2.7 mm - 187.5 mm	tk 700-270 SF	tk 700-273 SF

Arbeitslänge
Working length

Longueur de travail
Longitud de trabajo
Lunghezza operativa

SF = Tekno-Flex





Kinder-Zystoskop-Urethroskop Schäfte
Paediatric cystoscope-urethroscope sheaths

Gaines de cystoscopie-urethroscopie pédiatriques
 Vainas para cistoscopia-urethroscopia pediatrica
 Camicie per cistoscopia-urethroscopia pediatrici





Ø 7.5 Charr.	 only for diagnostics	2	Ø 1.9 mm - 0°/30° - 117.0 mm	tk 793-008
--------------	--	---	------------------------------	-------------------



Ø 1 x 3 Charr - 9.0 Charr.		2	Ø 1.9 mm - 0°/30° - 117 mm	tk 793-026
Ø 1 x 3 Charr - 9.5 Charr.		2	Ø 1.9 mm - 0°/30° - 187.5 mm	tk 793-010
Ø 1 x 3 Charr - 11 Charr.		2	Ø 2.7 mm - 30° - 187.5 mm	tk 793-011
Ø 1 x 5 Charr - 11 Charr.			Ø 1.9 mm - 30° - 187.5 mm	



Ø 1 x 3 Charr - 13 Charr.		2	Ø 2.7 mm - 0°/30° - 187.5 mm	tk 793-013
Ø 1 x 5 Charr or 2x4 Charr - 13 Charr.		2	Ø 2.7 mm - 0°/30° - 187.5 mm	tk 793-023

Kinder Cystoskop-Urethroskop-Schaft mit Obturator	Hähne	für Optiken
<i>Paediatric cystoscope-urethroscope sheath with obturator</i>	<i>stopcocks</i>	<i>for scopes</i>
Gaine de cystoscopie-urethroscopie pédiatrique, avec obturateur	robinets	pour optiques
<i>Vaina para cistoscopia-urethroscopia, con obturador</i>	<i>grifos</i>	<i>para ópticas</i>
Camicie per cistoscopia-urethroscopia, con otturatore	rubinetti	per ottiche

Kinder-Zystoskop-Urethroskop Schäfte
Paediatric cystoscope-urethroscope sheaths

Gaines de cystoscopie-urethroscopie pédiatriques
 Vainas para cistoscopia-urethroscopia pediátrica
 Camicie per cistoscopia-urethroscopia pediatrici



13 Charr.  tk 793-052

Arbeitseinsatz mit ALBARRAN Lenkhebel
Working insert with ALBARRAN deflecting mechanism

Insert de travail ALBARRAN
 Inserto de trabajo ALBARRAN
 Elemento operative ALBARRAN

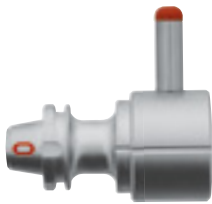

13 Charr.  tk 793-040

Optikbrücke
Telescope bridge
 Pont pour télescope
 Puente óptico
 Ponte per ottiche

Flexible Instrumente
Flexible instruments

Instruments flexibles
Instrumentos flexibles
Strumenti flessibili

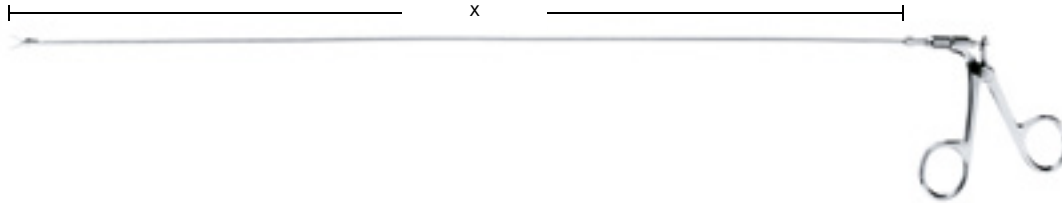

2:1

	x= 25 cm	x= 25 cm
Ø 3.0 Charr.	tk 793-186	tk 793-187

Fasszange, Alligatormaul	flexibel	halbstarr
<i>Grasping forceps, alligator jaw</i>	<i>flexible</i>	<i>semi-rigid</i>
Pince à saisir, dentelée, crocodile	flexible	semi-rigide
<i>Pinza de agarre con dientes de cocodrilo</i>	<i>flexible</i>	<i>semi-rígida</i>
Pinza da presa con morso a cocodrillo	flessibile	semi rigida



2:1

	x= 25 cm	x= 25 cm
Ø 3.0 Charr.	tk 793-180	tk 793-181

Scheren	flexibel	halbstarr
<i>Scissors</i>	<i>flexible</i>	<i>semi-rigid</i>
Ciseaux	flexible	semi-rigide
<i>Tijeras</i>	<i>flexible</i>	<i>semi-rígida</i>
Forbice	flessibile	semi-rigida

10



2:1

	x= 25 cm	x= 25 cm
Ø 3.0 Charr.	tk 793-182	tk 793-183

Biopsiezange, Löffel oval	flexibel	halbstarr
<i>Biopsy forceps, oval spoon</i>	<i>flexible</i>	<i>semi-rigid</i>
Pince à biopsie, mors ovale	flexible	semi-rigide
<i>Pinza para biopsia, cuchara oval</i>	<i>flexible</i>	<i>semi-rígida</i>
Pinza da biopsia a cuchiaio ovale	flessibile	semi rigida



2:1

	x= 25 cm	x= 25 cm
Ø 3.0 Charr.	tk 793-184	tk 793-185

Biopsiezange, Löffel oval	flexibel, gezahnt	halbstarr, gezahnt
<i>Biopsy forceps, oval spoon</i>	<i>flexible, serrated</i>	<i>semi-rigid, serrated</i>
Pince à biopsie, mors ovale	flexible, dentelée	semi-rigide, dentelée
<i>Pinza para biopsia, cuchara oval</i>	<i>flexible, dentado</i>	<i>semi-rígida, dentado</i>
Pinza da biopsia a cuchiaio ovale	flessibile, dentellata	semi rigida, dentellata

Flexible Instrumente
Flexible instruments

Instruments flexibles
Instrumentos flexibles
Strumenti flessibili



Ø 3.0 Charr. - 45 cm	tk 790-482	tk 790-487
	Knopfelektrode, flexibel <i>Button electrode, flexible</i> Electrode à boule, flexible <i>Electrodo a bola, flexible</i> Elettrodo a bottone, flessibile	Nadelelektrode, flexibel <i>Needle electrode, flexible</i> Electrode d'aiguille, flexible <i>Electrodo de aguja, flexible</i> Elettrodo ad ago, flessibile

Hochfrequenzkabel, monopolar
High frequency cables, monopolar

Câbles de haute fréquence, monopolaire
Cables alta frecuencia, monopolar
Cavi ad alta frequenza, monopolare

	Ø = 4 mm	3m	tk 790-310	
Aesculap, Berchtold, Martin				
	Ø = 5 mm	3m	tk 790-311	
Storz, Erbe				
	Ø = 8 mm	3m	tk 790-312	
Tekno, Valleylab, Bovie				
	Ø = 4 mm	3m	tk 790-313	
Berchtold, Martin				

Monopolares Kinder-Arbeitsselement
Paediatric monopolar working element

Elément de travail pédiatrique monopolaire
Elemento de trabajo pediátrico monopolar
Elemento operativo monopolare pediatrico

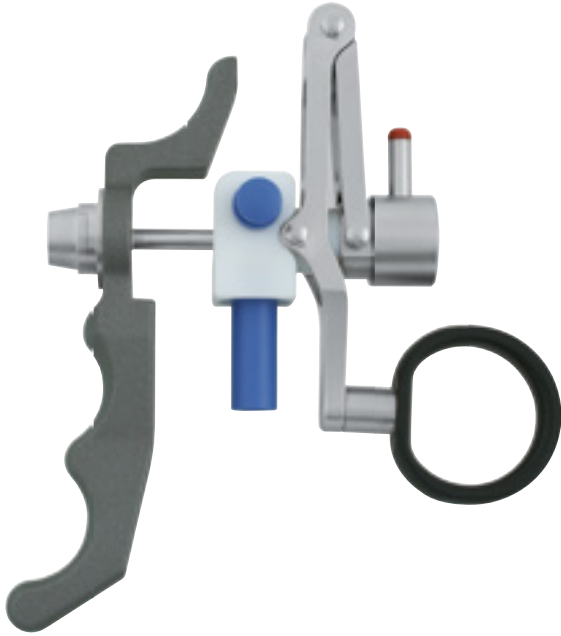

tk 793-300

Arbeitsselement, passiv schneidend, einläufig
Working element, passive cutting, single stem

Elément de travail, coupe passive, single-stem
Elemento de trabajo, corte pasivo, un vástago
Elemento operativo passivo, uno stelo

Hochfrequenzkabel, monopolar
High frequency cables, monopolar

Câbles de haute fréquence, monopolaire
Cables alta frecuencia, monopolar
Cavi ad alta frequenza, monopolare









Ø = 4 mm	3m	tk 790-310
Aesculap, Berchtold, Martin		
Ø = 5 mm	3m	tk 790-311
Storz, Erbe		
Ø = 8 mm	3m	tk 790-312
Tekno, Valleylab, Bovie		
Ø = 4 mm	3m	tk 790-313
Berchtold, Martin		

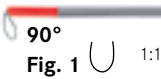
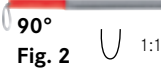

Monopolare Elektroden
Monopolar electrodes

 Electrodes monopolaires
Electrodos monopolares
 Elettrodi monopolari

	9 Charr. 	11 Charr. 	13 Charr. 
 1:1 Messerelektrode <i>Knife electrode</i> Electrode à couteau <i>Electrodo de cuchillo</i> Elettrodo a bisturi	tk 793-240	tk 793-250	tk 793-350
 1:1 90° Fig. 1 U	tk 793-242	tk 793-252	tk 793-352
 1:1 90° Fig. 2 U	tk 793-243	tk 793-253	tk 793-353
 1:1 Kugelelektrode <i>Ball electrode</i> Electrode à boule <i>Electrodo de bola</i> Elettrodo a pallina	tk 793-244	tk 793-254	tk 793-354
 1:1 Hakenelektrode <i>Hook electrode</i> Electrode de crochet <i>Electrodo de gancho</i> Elettrodo ad uncino	tk 793-245	tk 793-255	tk 793-355

tk 790-374
Schutzhülse zur Sterilisation von Elektroden
Protection tube for sterilization of electrodes



 Tube de protection et stérilisation des électrodes
Tubo protector para la esterilización de electrodos

Camicia di protezione per sterilizzazione degli elettrodi

Monopolare Kinder-Resektoskopschäfte
Paediatric monopolar resectoscope sheaths

Gaines pour la résectoscopie monopolaire pédiatrique
Vainas para la resectoscopia monopolar pediátrica
 Camicia per la resettoscopia monopolare pediatrica



9 Charr.  for Ø 1.9 mm - 0° - 187.5 mm	tk 793-126	tk 793-127
11 Charr.  for Ø 1.9 mm - 0° - 187.5 mm	tk 793-121	tk 793-123
13 Charr.  for Ø 2.7 mm - 0° - 187.5 mm	tk 793-321	tk 793-323

Standard Resektoskopschaft, 1 Hahn drehbar, mit Obturator <i>Standard resectoscope sheath, 1 stopcock rotating, with obturator</i>	Standard Resektoskopschaft <i>Standard resectoscope sheath</i>	Standard Obturator <i>Standard obturator</i>
Gaine standard avec 1 robinet rotatif, avec obturateur <i>Vaina, con 1 grifo giratorio, y obturador</i>	Gaine de résection standard <i>Vaina de resectoscopia</i>	Obturateur standard <i>Obturador estándar</i>
Camicia con 1 rubinetto rotante e otturatore	Camicia per resettoscopia	Otturatore

9 Charr.  tk 793-125	x	x
11 Charr.  tk 793-120	x	x
13 Charr.  tk 793-320	x	x

komplett
 complete
 complet
 completo
 completo



11 Charr.  tk 793-049
13 Charr.  tk 793-050

Einsatz zur Diagnostik, mit 1 Instrumentenkanal, 3 Charr.
Insert for diagnostic, with 1 instrument channel, 3 Charr.

Insert pour la diagnose, avec 1 canal d'instruments, 3 Charr.
Inserto para diagnosis, con un canal para instrumentos, 3 Charr.
 Inserto per diagnostica, ad 1 canale per strumenti, 3 Charr.

Pädiatrisches Urethrotom
Paediatric Urethrotome

Urétrotome pédiatrique
Uretrótomo pediátrica
Uretrotomo pediatrica

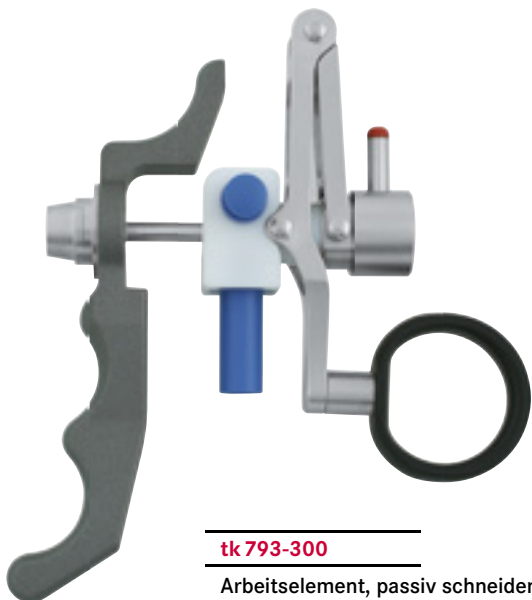

tk 793-300

Arbeitselement, passiv schneidend, einläufig
Working element, passive cutting, single stem

Élément de travail, coupe passive, single-stem
Elemento de trabajo, corte pasivo, un vástago
Elemento operativo passivo, un stelo



Strikturmesser nicht mit HF-Strom verwenden!
Do not use cold knives with HF power!

Ne pas utiliser les bistouris avec courant HF!
No se deben usar los cuchillos con corriente AF!
Non usare gli bisturi con corrente AF!

Hochfrequenzkabel, monopolar
High frequency cables, monopolar

Câbles de haute fréquence, monopolaire
Cables alta frecuencia, monopolar
Cavi ad alta frequenza, monopolare



Ø = 4 mm	3m	tk 790-310
----------	----	------------

Aesculap, Berchtold, Martin



Ø = 5 mm	3m	tk 790-311
----------	----	------------

Storz, Erbe



Ø = 8 mm	3m	tk 790-312
----------	----	------------

Tekno, Valleylab, Bovie



Ø = 4 mm	3m	tk 790-313
----------	----	------------

Berchtold, Martin



Pädiatrische Strikturmesser
Paediatric cold knives

Bistouris pédiatrique
Cuchillos pediátricas
Coltelli pediatriche



1:1





1:1



1:1



1:1

	11 Charr. 	13 Charr. 
gerade <i>straight</i> droit <i>recto</i> retto	tk 793-364	tk 793-368
rund <i>round</i> circulaire <i>redondo</i> retondo	tk 793-365	tk 793-369
hakenförmig <i>hook shaped</i> crochet <i>forma de gancho</i> ad uncino	tk 793-366	tk 793-376
sichelförmig <i>sickle knife</i> à faucille <i>a forma de hoz</i> a forma di falce	tk 793-367	tk 793-377

Strikturmesser
Cold knives
Bistouris
Cuchillos
Coltelli





Strikturmesser nicht mit HF-Strom verwenden!
Do not use cold knives with HF power!

Ne pas utiliser les bistouris avec courant HF!
No se deben usar los cuchillos con corriente AF!
Non usare gli bisturi con corrente AF!

Pädiatrischer Urethrotomschaft
Paediatric urethrotome sheath

Gaine d'uréthrotome pédiatrique
Vaina para uretrótomo pediátrica
Camicia di uretrotomo pediatrica



11 Charr. 	2	Ø 1.9 mm - 0° - 187.5 mm	tk 793-361
13 Charr. 	2	Ø 2.7 mm - 0° - 187.5 mm	tk 793-360
Urethrotomschaft mit Obturator <i>Urethrotome sheath with obturator</i>	Hähne drehbar <i>stopcocks rotating</i>	für Optiken <i>for scopes</i>	
Gaine d'urethrotomie avec obturateur <i>Vaina uretrótomo con obturador</i> Camicia di uretrotomo con otturatore	robinets rotatifs <i>grifos giratorios</i> rubinetti rotanti	pour optiques <i>para ópticas</i> per ottiche	



11 Charr. 	tk 793-049
13 Charr. 	tk 793-050

Einsatz zur Diagnostik, mit 1 Instrumentenkanal, 3 Charr.
Insert for diagnostic, with 1 instrument channel, 3 Charr.

Insert pour la diagnose, avec 1 canal d'instruments, 3 Charr.
Inserto para diagnosis, con un canal para instrumentos, 3 Charr.
Inserto per diagnostica, ad 1 canale per strumenti, 3 Charr.

Flexible Instrumente
Flexible instruments









Instruments flexibles
Instrumentos flexibles
Strumenti flessibili



Ø 3.0 Charr. - 45 cm	tk 790-482	tk 790-487
	Knopfelektrode, flexibel <i>Button electrode, flexible</i>	Nadelelektrode, flexibel <i>Needle electrode, flexible</i>
	Electrode à boule, flexible <i>Electrodo a bola, flexible</i>	Electrode d'aiguille, flexible <i>Electrodo de aguja, flexible</i>
	Elettrodo a bottone, flessibile	Elettrodo ad ago, flessibile

Hochfrequenzkabel, monopolar
High frequency cables, monopolar

Câbles de haute fréquence, monopolaire
Cables alta frecuencia, monopolar
Cavi ad alta frequenza, monopolare

	Ø = 4 mm	3m	tk 790-310	
Aesculap, Berchtold, Martin				
	Ø = 5 mm	3m	tk 790-311	
Storz, Erbe				
	Ø = 8 mm	3m	tk 790-312	
Tekno, Valleylab, Bovie				
	Ø = 4 mm	3m	tk 790-313	
Berchtold, Martin				

Zubehör | Accessoires
 Accessories | Accesorios
 Accessori



	tk 30430-01	tk 30430-02	tk 30430-04	tk 30430-03
ELLIK Evakuator <i>ELLIK Evacuator</i>	Glaszylinder, allein <i>Glass bowl, only</i>	Schlauchteil mit Konus <i>Tube with cone</i>	Schlauchteil mit QL-Konus <i>Tube with QL-Cone</i>	Gummiball, allein <i>Rubber ball, only</i>
ELLIK evacuateur <i>ELLIK evacuador</i>	Corps de verre, seul <i>Recipiente de vidrio, solo</i>	Tube avec connecteur <i>Tubo con conector</i>	Tuyan avec connecteur QL <i>Tubo con conector QL</i>	Ballon en caoutchouc <i>Pera de aire en plástico, solo</i>
ELLIK evaquatore	Recipiente in vetro	Tubo con adattatore	Tubo con adattatore QL	Palla in gomma

tk 30430-00	x	x	-	x
tk 30431-00	x	-	x	x

ELLIK Evakuator, komplett
ELLIK evacuador, complete
 ELLIK evacuateur, complet
ELLIK evacuador, completo
 ELLIK evaquatore, completo



tk 790-398

LUER-Lock Schlauchverbindung
LUER-Lock tube connector
 LUER-Lock raccord
LUER-Lock conector para tubos
 LUER-Lock raccordo



tk 790-399

LUER-Lock Schlauchverbindung mit Hahn
LUER-Lock tube connector with stopcock
 LUER-Lock raccord avec robinet
LUER-Lock conector para tubos con grifo
 LUER-Lock raccordo con rubinetto d'arresto

Zubehör
Accessories

Accessoires
Accesorios
Accessori

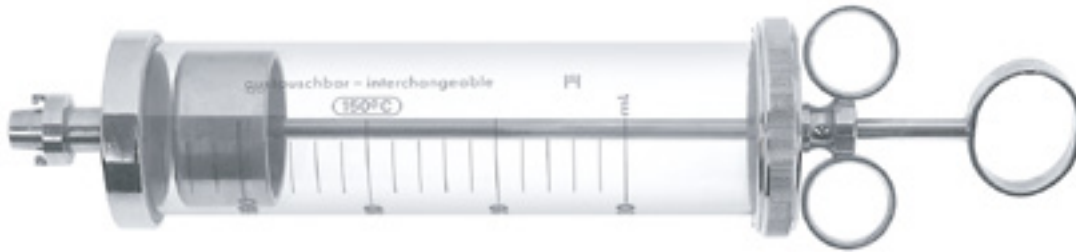

REINER-ALEXANDER (JANET-G-S)

	50 ml	75 ml	100 ml	150 ml	200 ml
Quick-lock	tk 6760-11	tk 6760-12	tk 6760-13	tk 6760-14	tk 6760-15
Standard	tk 6760-01	tk 6760-02	tk 6760-03	tk 6760-04	tk 6760-05

Blasenspritze mit Verriegelungsadapter

Bladder syringe with locking adapter

Séringue avec adaptateur

Jeringa para vejiga con adaptador

Siringa per lavaggio con adattatore

50 ml	75 ml	100 ml	150 ml	200 ml
tk 6761-01	tk 6761-02	tk 6761-03	tk 6761-04	tk 6761-05

Ersatz-Zylinder für Blasenspritze, mit Verriegelungsadapter, ohne Abbildung

Spare barrel for bladder syringe, with locking adapter, without illustration

Cylindre de verre pour séringue, sans photo

Cilindro de recambio, con adaptador, sin ilustración

Cilindro di ricambio in vetro, con adattatore, senza illustrazione



tk 790-397

Spülansatz für Katheter

Catheter adaptor

Adaptateur pour chathéters

Adaptador para catéteres

Adattore per catetere

Zubehör
AccessoriesAccessoires
Accesorios
Accessori

Dilatationsbougies

Dilating bougies

Bougies dilatatrices

Bujías dilatadoras

Candelette dilatatrici

DITTEL

		220mm-8 $\frac{3}{4}$ "
2 $\frac{2}{3}$ mm Ø	8 Charr./Fr.	tk 30390-08
3 mm Ø	9 Charr./Fr.	tk 30390-09
3 $\frac{1}{3}$ mm Ø	10 Charr./Fr.	tk 30390-10
3 $\frac{2}{3}$ mm Ø	11 Charr./Fr.	tk 30390-11
4 mm Ø	12 Charr./Fr.	tk 30390-12
4 $\frac{1}{3}$ mm Ø	13 Charr./Fr.	tk 30390-13
4 $\frac{2}{3}$ mm Ø	14 Charr./Fr.	tk 30390-14
5 mm Ø	15 Charr./Fr.	tk 30390-15
5 $\frac{1}{3}$ mm Ø	16 Charr./Fr.	tk 30390-16
5 $\frac{2}{3}$ mm Ø	17 Charr./Fr.	tk 30390-17
6 mm Ø	18 Charr./Fr.	tk 30390-18
6 $\frac{1}{3}$ mm Ø	19 Charr./Fr.	tk 30390-19
6 $\frac{2}{3}$ mm Ø	20 Charr./Fr.	tk 30390-20
7 mm Ø	21 Charr./Fr.	tk 30390-21
7 $\frac{1}{3}$ mm Ø	22 Charr./Fr.	tk 30390-22
7 $\frac{2}{3}$ mm Ø	23 Charr./Fr.	tk 30390-23
8 mm Ø	24 Charr./Fr.	tk 30390-24
8 $\frac{1}{3}$ mm Ø	25 Charr./Fr.	tk 30390-25
8 $\frac{2}{3}$ mm Ø	26 Charr./Fr.	tk 30390-26
9 mm Ø	27 Charr./Fr.	tk 30390-27
9 $\frac{1}{3}$ mm Ø	28 Charr./Fr.	tk 30390-28
9 $\frac{2}{3}$ mm Ø	29 Charr./Fr.	tk 30390-29
10 mm Ø	30 Charr./Fr.	tk 30390-30
10 $\frac{2}{3}$ mm Ø	32 Charr./Fr.	tk 30390-32
11 mm Ø	33 Charr./Fr.	tk 30390-33
11 $\frac{1}{3}$ mm Ø	34 Charr./Fr.	tk 30390-34
12 mm Ø	36 Charr./Fr.	tk 30390-36

1:2

gerade
straightdroit
recta
rette

DITTEL

		350mm-13 $\frac{3}{4}$ "
2 $\frac{2}{3}$ mm Ø	8 Charr./Fr.	tk 30392-08
3 mm Ø	9 Charr./Fr.	tk 30392-09
3 $\frac{1}{3}$ mm Ø	10 Charr./Fr.	tk 30392-10
3 $\frac{2}{3}$ mm Ø	11 Charr./Fr.	tk 30392-11
4 mm Ø	12 Charr./Fr.	tk 30392-12
4 $\frac{1}{3}$ mm Ø	13 Charr./Fr.	tk 30392-13
4 $\frac{2}{3}$ mm Ø	14 Charr./Fr.	tk 30392-14
5 mm Ø	15 Charr./Fr.	tk 30392-15
5 $\frac{1}{3}$ mm Ø	16 Charr./Fr.	tk 30392-16
5 $\frac{2}{3}$ mm Ø	17 Charr./Fr.	tk 30392-17
6 mm Ø	18 Charr./Fr.	tk 30392-18
6 $\frac{1}{3}$ mm Ø	19 Charr./Fr.	tk 30392-19
6 $\frac{2}{3}$ mm Ø	20 Charr./Fr.	tk 30392-20
7 mm Ø	21 Charr./Fr.	tk 30392-21
7 $\frac{1}{3}$ mm Ø	22 Charr./Fr.	tk 30392-22
7 $\frac{2}{3}$ mm Ø	23 Charr./Fr.	tk 30392-23
8 mm Ø	24 Charr./Fr.	tk 30392-24
8 $\frac{1}{3}$ mm Ø	25 Charr./Fr.	tk 30392-25
8 $\frac{2}{3}$ mm Ø	26 Charr./Fr.	tk 30392-26
9 mm Ø	27 Charr./Fr.	tk 30392-27
9 $\frac{1}{3}$ mm Ø	28 Charr./Fr.	tk 30392-28
9 $\frac{2}{3}$ mm Ø	29 Charr./Fr.	tk 30392-29
10 mm Ø	30 Charr./Fr.	tk 30392-30
10 $\frac{2}{3}$ mm Ø	32 Charr./Fr.	tk 30392-32
11 mm Ø	33 Charr./Fr.	tk 30392-33
11 $\frac{1}{3}$ mm Ø	34 Charr./Fr.	tk 30392-34
12 mm Ø	36 Charr./Fr.	tk 30392-36

1:2

gebogen
curvedcourbe
curva
curve

Zubehör
Accessories

Accessoires
Accesorios
Accessori



VAN BUREN

2 $\frac{2}{3}$ mm Ø	8 Charr./Fr.	tk 30391-08
3 $\frac{1}{3}$ mm Ø	10 Charr./Fr.	tk 30391-10
4 mm Ø	12 Charr./Fr.	tk 30391-12
4 $\frac{2}{3}$ mm Ø	14 Charr./Fr.	tk 30391-14
5 $\frac{1}{3}$ mm Ø	16 Charr./Fr.	tk 30391-16
6 mm Ø	18 Charr./Fr.	tk 30391-18
6 $\frac{2}{3}$ mm Ø	20 Charr./Fr.	tk 30391-20
7 $\frac{1}{3}$ mm Ø	22 Charr./Fr.	tk 30391-22
8 mm Ø	24 Charr./Fr.	tk 30391-24
8 $\frac{2}{3}$ mm Ø	26 Charr./Fr.	tk 30391-26
9 $\frac{1}{3}$ mm Ø	28 Charr./Fr.	tk 30391-28
10 mm Ø	30 Charr./Fr.	tk 30391-30
10 $\frac{2}{3}$ mm Ø	32 Charr./Fr.	tk 30391-32
11 $\frac{1}{3}$ mm Ø	34 Charr./Fr.	tk 30391-34
12 mm Ø	36 Charr./Fr.	tk 30391-36

VAN BUREN

tk 30391-00

Satz, Fig. 08 – Fig. 36

Set, Fig. 08 – Fig. 36

Jeu, Fig. 08 – Fig. 36

Juego, Fig. 08 – Fig. 36

Serie, Fig. 08 – Fig. 36



GUYON

3 $\frac{1}{3}$ mm Ø	10 Charr./Fr.	tk 30393-10
3 $\frac{2}{3}$ mm Ø	11 Charr./Fr.	tk 30393-11
4 mm Ø	12 Charr./Fr.	tk 30393-12
4 $\frac{1}{3}$ mm Ø	13 Charr./Fr.	tk 30393-13
4 $\frac{2}{3}$ mm Ø	14 Charr./Fr.	tk 30393-14
5 mm Ø	15 Charr./Fr.	tk 30393-15
5 $\frac{1}{3}$ mm Ø	16 Charr./Fr.	tk 30393-16
5 $\frac{2}{3}$ mm Ø	17 Charr./Fr.	tk 30393-17
6 mm Ø	18 Charr./Fr.	tk 30393-18
6 $\frac{1}{3}$ mm Ø	19 Charr./Fr.	tk 30393-19
6 $\frac{2}{3}$ mm Ø	20 Charr./Fr.	tk 30393-20
7 mm Ø	21 Charr./Fr.	tk 30393-21
7 $\frac{1}{3}$ mm Ø	22 Charr./Fr.	tk 30393-22
7 $\frac{2}{3}$ mm Ø	23 Charr./Fr.	tk 30393-23
8 mm Ø	24 Charr./Fr.	tk 30393-24
8 $\frac{1}{3}$ mm Ø	25 Charr./Fr.	tk 30393-25
8 $\frac{2}{3}$ mm Ø	26 Charr./Fr.	tk 30393-26
9 mm Ø	27 Charr./Fr.	tk 30393-27
9 $\frac{1}{3}$ mm Ø	28 Charr./Fr.	tk 30393-28
9 $\frac{2}{3}$ mm Ø	29 Charr./Fr.	tk 30393-29
10 mm Ø	30 Charr./Fr.	tk 30393-30

GUYON

tk 30393-00

Satz, Fig. 10 – Fig. 30, ohne Innengewinde

Set, Fig. 10 – Fig. 30, without inner thread

Jeu, Fig. 10 – Fig. 30, sans filet intérieur

Juego, Fig. 10 – Fig. 30, sin filete interior

Serie, Fig. 10 – Fig. 30, senza filetto interno

Zubehör
Accessories

Accessoires
Accesorios
Accessori

Metallkatheter für Frauen
Metal catheters for women

Sondes métalliques pour femmes
Sondas metálicas para mujeres
Sonde metalliche per donne



GUYON

2 mm Ø	6 Charr./Fr.	tk 30410-06
2½ mm Ø	7 Charr./Fr.	tk 30410-07
2⅔ mm Ø	8 Charr./Fr.	tk 30410-08
3 mm Ø	9 Charr./Fr.	tk 30410-09
3⅓ mm Ø	10 Charr./Fr.	tk 30410-10
3⅔ mm Ø	11 Charr./Fr.	tk 30410-11
4 mm Ø	12 Charr./Fr.	tk 30410-12
4⅓ mm Ø	13 Charr./Fr.	tk 30410-13
4⅔ mm Ø	14 Charr./Fr.	tk 30410-14
5 mm Ø	15 Charr./Fr.	tk 30410-15
5⅓ mm Ø	16 Charr./Fr.	tk 30410-16
5⅔ mm Ø	17 Charr./Fr.	tk 30410-17
6 mm Ø	18 Charr./Fr.	tk 30410-18
6⅓ mm Ø	19 Charr./Fr.	tk 30410-19
6⅔ mm Ø	20 Charr./Fr.	tk 30410-20
7 mm Ø	21 Charr./Fr.	tk 30410-21
7⅓ mm Ø	22 Charr./Fr.	tk 30410-22
7⅔ mm Ø	23 Charr./Fr.	tk 30410-23
8 mm Ø	24 Charr./Fr.	tk 30410-24

Metallkatheter für Männer
Metal catheters for men

Sondes métalliques pour hommes
Sondas metálicas para hombres
Sonde metalliche per uomini



2 mm Ø	6 Charr./Fr.	tk 30400-06
2½ mm Ø	8 Charr./Fr.	tk 30400-08
3⅓ mm Ø	10 Charr./Fr.	tk 30400-10
4 mm Ø	12 Charr./Fr.	tk 30400-12
4⅔ mm Ø	14 Charr./Fr.	tk 30400-14
5⅓ mm Ø	16 Charr./Fr.	tk 30400-16
6 mm Ø	18 Charr./Fr.	tk 30400-18
6⅔ mm Ø	20 Charr./Fr.	tk 30400-20
7⅓ mm Ø	22 Charr./Fr.	tk 30400-22
8 mm Ø	24 Charr./Fr.	tk 30400-24

Zubehör
Accessories

Accessoires
Accesorios
Accessori



GUYON

35 cm

tk 30445-35

Katheterspanner, gebogen
Catheter introducer, curved

Tendeur pour cathéters, curbe
Introductor para catéteres, curvo
Introduttore per catetere, curvo



GUYON

39 cm

tk 30444-39

Katheterspanner, gerade
Catheter introducer, straight

Tendeur pour cathéters, droit
Introductor para catéteres, recto
Introduttore per catetere, retto



STOCKMANN

tk 30460-08

Penisklemme
Penis clamp

Clamp pour le pénis
Pinza para pene
Stringipene



STRAUSS

tk 30465-11

Penisklemme
Penis clamp

Clamp pour le pénis
Pinza para pene
Stringipene

Glasfaser-Kaltlichtkabel
Fiberoptic cables

 Cables de lumière froide
 Cables de fibra óptica
 Cavi luce in fibra ottica

 autoklavierbar / autoclavable
 134°C / 273°F

< Ø 5mm	Ø 3.5 mm	1800 mm	tk 39520-18	tk 39530-18
	Ø 3.5 mm	2300 mm	tk 39520-23	tk 39530-23
	Ø 3.5 mm	3000 mm	tk 39520-30	tk 39530-30
	Ø 3.5 mm	4000 mm	tk 39520-40	tk 39530-40
≥ Ø 5mm	Ø 4.9 mm	1800 mm	tk 39521-18	tk 39531-18
	Ø 4.9 mm	2300 mm	tk 39521-23	tk 39531-23
	Ø 4.9 mm	2500 mm	tk 39521-25	tk 39531-25
	Ø 4.9 mm	3000 mm	tk 39521-30	tk 39531-30
	Ø 4.9 mm	4000 mm	tk 39521-40	tk 39531-40
	Ø 4.9 mm	5000 mm	tk 39521-50	tk 39531-50

für Optiken <i>for scopes</i>	Faserbündel <i>Fiber bundle</i>	Länge <i>Length</i>	Kabel ohne Adapter <i>Cable without adapters</i>	komplett mit 2 Adaptern: TEKNO / Storz <i>complete with 2 adapters: TEKNO / Storz</i>
pour optiques	Fibres	Longueur	Cable sans adaptateurs	complet avec 2 adaptateurs : TEKNO / Storz
para ópticas	Fibras	Longitud	Cable sin adaptadores	completo con 2 adaptadores : TEKNO / Storz
per ottiche	Cavo luce	Lunghezza	Cavo senza adattatori	completo di 2 adattatori: TEKNO / Storz

- adaptierbar an alle gängigen Systeme mittels Adapter
- *suitable for all common systems with adapters*
- compatibles avec tous systèmes commun avec adaptateurs
- *compatibles con todos equipos corrientes con adaptadores*
- compatibile con tutti i sistemi più comuni con appositi adattatori

 Nicht für 300W Xenon-Lichtquellen geeignet
Not for use with 300W Xenon light sources

 Ne pas utiliser avec des sources de lumière 300W Xenon
No usar con fuentes de luz 300W Xenon
 Non usare insieme alle fonti di luce Xenon 300W

Glasfaser-Kaltlichtkabel
Fiberoptic cables
Cables de lumière froide
Cables de fibra óptica
Cavi luce in fibra ottica
autoklavierbar / autoclavable
134°C / 273°F

			Xenon / LED	Xenon (TEKNO/Storz)	LED (TEKNO-Wolf)
< Ø 5mm	Ø 3.5 mm	1800 mm	tk 39522-18	tk 39532-18	tk 39560-18
	Ø 3.5 mm	2300 mm	tk 39522-23	tk 39532-23	tk 39560-23
	Ø 3.5 mm	3000 mm	tk 39522-30	tk 39532-30	tk 39560-30
≥ Ø 5mm	Ø 4.8 mm	1800 mm	tk 39523-18	tk 39533-18	tk 39561-18
	Ø 4.8 mm	2300 mm	tk 39523-23	tk 39533-23	tk 39561-23
	Ø 4.8 mm	3000 mm	tk 39523-30	tk 39533-30	tk 39561-30

für Optiken <i>for scopes</i>	Faserbündel <i>Fiber bundle</i>	Länge <i>Length</i>	Kabel ohne Adapter <i>Cable without adapters</i>	komplett mit 2 Adaptern <i>complete with 2 adapters</i>	komplett mit 2 Adaptern <i>complete with 2 adapters</i>
pour optiques <i>para ópticas</i> per ottiche	Fibres <i>Fibras</i> Cavo luce	Longueur <i>Longitud</i> Lunghezza	Cable sans adaptateurs <i>Cable sin adaptadores</i> Cavo senza adattatori	complet avec 2 adaptateurs <i>completo con 2 adaptadores</i> completo di 2 adattatori	complet avec 2 adaptateurs <i>completo con 2 adaptadores</i> completo di 2 adattatori

- Speziell für XENON & LED-Lichtquellen

Unsere Hochleistungs-Kaltlichtkabel werden durch ein Spezialverfahren am Lichteintritt komprimiert und können so mehr Licht transportieren. Sie sind speziell für hochenergetische Xenon & LED-Lichtquellen geeignet!

- adaptierbar an alle gängigen Systeme mittels Adapter
- Especially for XENON & LED light sources

Our high density fiber optic cables are specially prepared at the light entrance for transporting more light. They are suited for high energy XENON & LED light sources.

- suitable for all common systems with adapter
- Spécialement pour sources de lumière de XENON & LED.

Les cables de haute performance sont préparés spécialement à l'entrée de la lumière pour pouvoir transporter plus de lumière. Ils sont appropriés pour les sources énergétiques de Xenon & LED.

- compatibles avec tous systèmes commun avec adaptateurs
- Particularmente para fuentes de luz XENON & LED.

Nuestros cables de fibra óptica de alto rendimiento disponen de un tratamiento especial en la punta proximal para una mayor transmisión de luz. Estos cables son especialmente recomendados para el uso con fuentes de luz Xenon & LED.

- compatibles con todos equipos corrientes con adaptador
- Specialmente per fonti di luce allo XENON & LED

I nostri cavi luce ad alta densità sono preparati in modo speciale nella connessione con la fonte per trasportare maggior quantità di luce. Essi sono costruiti per le fonti di luce XENON & LED ad alta potenzialità.

- fornibili per tutti i sistemi più comuni con adattatori

**Adapter
Adapters** | Adaptateurs
Adaptadores
Adattatori

Projektor-Seite
Projector-side
Coté projecteur
Fuente de luz
Lato fonte luce



tk 39525-00	tk 39528-00	tk 39527-00	tk 39530-00
Tekno Storz Aesculap	Wolf HSW Dyonics Medicon Comeg Linvatec	Olympus	ACMI Stryker

Endoskop-Seite
Endoscope-side
Coté endoscope
Endoscopio
Lato endoscopio



tk 39525-10	tk 39528-20	tk 39530-10
Tekno Storz Aesculap Olympus	Wolf HSW Dyonics Medicon Comeg Stryker	ACMI Linvatec



Weitere Adapter auf Anfrage erhältlich
Further adapters available on request

Autres adaptateurs sont disponibles sur demande
Otros adaptadores son disponibles según demanda
Altri adattatori a richiesta

<p>Zubehör Accessories</p>	<p>Accessoires Accesorios Accessori</p>
--------------------------------	---



380 x 260 x 65 mm

tk 85109-01

Sterilisier Container mit Einsatz (für Resektoskopie Set, ohne Instrumente)
Sterilisation containers with insert (for resectoscopy set, without instruments)
 Contenaires pour stérilisation avec insert (pour résectoscopie, sans instruments)
 Contenedor para esterilización con inserto (para set de resectoscopia, sin instrumentos)
 Container per sterilizzazione con inserto (per set di resectoscopia, senza strumenti)

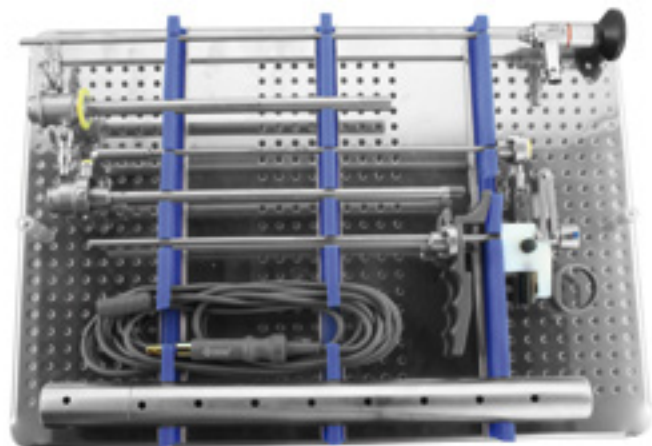

tk 85109-10

Textilfilter für tk 85109-01
 Textile filter for tk 85109-01
 Filtre en textile pour tk 85109-01
 Filtro de tejido para tk 85109-01
 Filtro tessile per tk 85109-01

370 x 255 x 45 mm

tk 85109-02

Einsatz für Container tk 85109-01 (ohne Instrumente)
Insert for container tk 85109-01 (without instruments)
 Insert pour conteneur tk 85109-01 (sans instruments)
 Inserto para contenedor tk 85109-01 (sin instrumentos)
 Inserto per container tk 85109-01 (senza strumenti)

Zubehör
AccessoriesAccessoires
Accesorios
Accessori

Perforierter Boden und Deckel, ohne Filter.
Silikonhalterungen für zwei Endoscope.

*Perforated bottom and lid, without filter.
Silicon fittings for two endoscopes.*

Couvercle et fond perforés, sans filtres.
Pièces en silicon pour 2 optiques.

*Tapa y fondo perforados, sin filtros.
Piezas en silicona para 2 ópticas.*

Coperchio e fondo perforato, senza filtri.
Sostegno di silicone per 2 ottiche.

250 x 60 x 50 mm		tk 87280-2F-SI
250 x 60 x 50 mm		tk 87280-2F-YE
250 x 60 x 50 mm		tk 87280-2F-GR
250 x 60 x 50 mm		tk 87280-2F-BL
250 x 60 x 50 mm		tk 87280-2F-RE
250 x 60 x 50 mm		tk 87280-2F-BK

Deckelfarbe
Lid colour

Couleur du couvercle
Color de la tapa
Colore del coperchio

450 x 70 x 70 mm		tk 87290-2F-SI
450 x 70 x 70 mm		tk 87290-2F-YE
450 x 70 x 70 mm		tk 87290-2F-GR
450 x 70 x 70 mm		tk 87290-2F-BL
450 x 70 x 70 mm		tk 87290-2F-RE
450 x 70 x 70 mm		tk 87290-2F-BK

Deckelfarbe
Lid colour

Couleur du couvercle
Color de la tapa
Colore del coperchio



460 x 80 x 52 mm	tk 707-650
290 x 80 x 52 mm	tk 707-651

Siebkorb für Optiken > ø 2,7mm
Wire basket for endoscopes > ø 2,7 mm
Panier pour optiques > ø 2,7 mm
Cesta para ópticas > ø 2,7 mm
Cestello per ottiche con > ø 2,7 mm

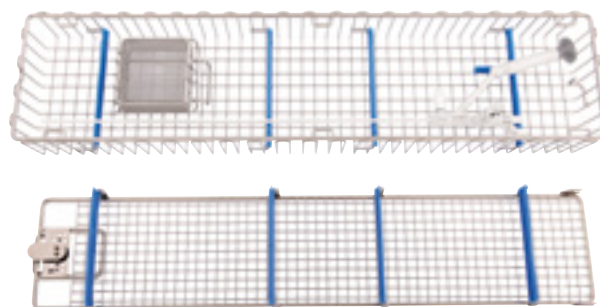

640 x 150 x 77 mm	tk 707-654
-------------------	-------------------

Siebkorb für Uretero-Renoskop
Wire basket for uretereo-rensoscope

Panier pour uretero-rensoscope
Cesta para uretero-rensoscopia
Cestello per uretero-rensoscopia



tk 700-999

Autoklavierbare Schutzhülse für Endoskope bis Ø 5 mm, durch Zusammenstecken von 2 Hülssen erweiterbar für Urologie / Gynäkologie - Optiken
Autoclavable protection tube for endoscopes up to Ø 5 mm, assembling of two tubes will allow a protection for Urology / Gynaecology scopes

Gaines de protection autoclavables pour optiques jusqu'au 5mm Ø. En combinant deux gaines, élargable pour des optiques d'urologie et gynécologie.

Vainas de protección autoclavables para ópticas fino a Ø 5mm. Conectando dos vainas se pueden utilizar también para ópticas de Urología / Ginecología

Tubi di protezione autoclavabili per ottiche fino a 5 mm fino Ø 5 mm. L'assemblaggio di due tubi consentirà la protezione delle per urologia/ginecologia

Ersatzteile, Pflegemittel
Spare parts, detergents for instruments

Pièces de réchange, détergents
Piezas de recambio, detergentes
Pezzi di ricambio, detergenti



	30 ml	25 ml	15 ml
	tk 95000-50	tk 95000-51	tk 95000-52
Antibeslagmittel <i>Antifog solution</i> Solution antibuée <i>Solución antiraho</i> Anti appannante	Durchstichflasche (steril) <i>Pierce bottle (sterile)</i> Bouteille perforée (stérile) <i>Botella perforada (estéril)</i> Bottiglia perforata (sterile)	Pipettenflasche <i>Pipette bottle</i> Bouteille pipette <i>Botella con pipeta</i> Bottiglia con pipetta	Sprühflasche <i>Spray bottle</i> Bouteille spray <i>Botella de spray</i> Bottiglia di spray



	tk 95011-00	tk 95011-02	tk 95012-00
LL-Verschlusschrauben <i>End screws for LL channels</i> Vis pour connecteur LL <i>Tornillos para conexión LL</i> Tappi di chiusura LL	Kunststoff weiß <i>Plastic, white</i> Plastifié, blanc <i>Plástico blanco</i> Plastica bianca	Kunststoff schwarz <i>Plastic, black</i> Plastifié, noir <i>Plástico negro</i> Plastica nero	Edelstahl <i>Stainless steel</i> Acier inoxydable <i>Acero inoxidable</i> Acciaio inossidabile



tk 95010-00

Dichtungskappe, Silikon, (10 Stück)
Silicon cap, (10 pieces)
Capuchon de silicón, (10 pièces.)
Capuchón de sílicona, (10 piezas)
Tappo in silicone, (10 pezzi)



tk 95000-20

Hanfett, 5g
Grease for stopcocks, 5g
Graisse pour robinets, 5g
Grasa para robinetes, 5g
Grasso per rubinette, 5g

Nummernverzeichnis
Numerical Index

Index numériques

Indice numerico

Indice dei numeri d'articolo

Art. No.	Page	Art. No.	Page	Art. No.	Page	Art. No.	Page
tk 30390-08	81	tk 30392-24	81	tk 30410-22	83	tk 39560-23	86
tk 30390-09	81	tk 30392-25	81	tk 30410-23	83	tk 39560-30	86
tk 30390-10	81	tk 30392-26	81	tk 30410-24	83	tk 39561-18	86
tk 30390-11	81	tk 30392-27	81	tk 30423-00	56	tk 39561-23	86
tk 30390-12	81	tk 30392-28	81	tk 30424-00	56	tk 39561-30	86
tk 30390-13	81	tk 30392-29	81	tk 30424-01	56	tk 6760-01	80
tk 30390-14	81	tk 30392-30	81	tk 30424-02	56	tk 6760-02	80
tk 30390-15	81	tk 30392-32	81	tk 30424-03	56	tk 6760-03	80
tk 30390-16	81	tk 30392-33	81	tk 30424-10	56	tk 6760-04	80
tk 30390-17	81	tk 30392-34	81	tk 30430-00	79	tk 6760-05	80
tk 30390-18	81	tk 30392-36	81	tk 30430-01	79	tk 6760-11	80
tk 30390-19	81	tk 30393-00	82	tk 30430-02	79	tk 6760-12	80
tk 30390-20	81	tk 30393-10	82	tk 30430-03	79	tk 6760-13	80
tk 30390-21	81	tk 30393-11	82	tk 30430-04	79	tk 6760-14	80
tk 30390-22	81	tk 30393-12	82	tk 30431-00	79	tk 6760-15	80
tk 30390-23	81	tk 30393-13	82	tk 30444-39	84	tk 6761-01	80
tk 30390-24	81	tk 30393-14	82	tk 30445-35	84	tk 6761-02	80
tk 30390-25	81	tk 30393-15	82	tk 30460-08	84	tk 6761-03	80
tk 30390-26	81	tk 30393-16	82	tk 30465-11	84	tk 6761-04	80
tk 30390-27	81	tk 30393-17	82	tk 39520-18	85	tk 6761-05	80
tk 30390-28	81	tk 30393-18	82	tk 39520-23	85	tk 700-059	10, 28, 38, 52
tk 30390-29	81	tk 30393-19	82	tk 39520-30	85	tk 700-061	10, 28, 38
tk 30390-30	81	tk 30393-20	82	tk 39520-40	85	tk 700-064	10, 28
tk 30390-32	81	tk 30393-21	82	tk 39521-18	85	tk 700-064SF	10, 28
tk 30390-33	81	tk 30393-22	82	tk 39521-23	85	tk 700-065	10, 28
tk 30390-34	81	tk 30393-23	82	tk 39521-25	85	tk 700-065SF	10, 28
tk 30390-36	81	tk 30393-24	82	tk 39521-30	85	tk 700-066	10, 28, 38
tk 30391-00	82	tk 30393-25	82	tk 39521-40	85	tk 700-068	10, 28
tk 30391-08	82	tk 30393-26	82	tk 39521-50	85	tk 700-068SF	10, 28
tk 30391-10	82	tk 30393-27	82	tk 39522-18	86	tk 700-069	10, 28
tk 30391-12	82	tk 30393-28	82	tk 39522-23	86	tk 700-074	10, 28, 38, 52
tk 30391-14	82	tk 30393-29	82	tk 39522-30	86	tk 700-074 SF	10, 28, 38, 52
tk 30391-16	82	tk 30393-30	82	tk 39523-18	86	tk 700-075	10, 28, 38, 52
tk 30391-18	82	tk 30400-06	83	tk 39523-23	86	tk 700-075 SF	10, 28, 38, 52
tk 30391-20	82	tk 30400-08	83	tk 39523-30	86	tk 700-078	10, 28, 38
tk 30391-22	82	tk 30400-10	83	tk 39525-00	87	tk 700-078SF	10, 28, 38
tk 30391-24	82	tk 30400-12	83	tk 39525-10	87	tk 700-079	10, 28
tk 30391-26	82	tk 30400-14	83	tk 39527-00	87	tk 700-079SF	10, 28
tk 30391-28	82	tk 30400-16	83	tk 39528-00	87	tk 700-241	64
tk 30391-30	82	tk 30400-18	83	tk 39528-20	87	tk 700-242	64
tk 30391-32	82	tk 30400-20	83	tk 39530-00	87	tk 700-243	64
tk 30391-34	82	tk 30400-22	83	tk 39530-10	87	tk 700-245	60
tk 30391-36	82	tk 30400-24	83	tk 39530-18	85	tk 700-270	67
tk 30392-08	81	tk 30410-06	83	tk 39530-23	85	tk 700-270 SF	67
tk 30392-09	81	tk 30410-07	83	tk 39530-30	85	tk 700-271	67
tk 30392-10	81	tk 30410-08	83	tk 39530-40	85	tk 700-272	67
tk 30392-11	81	tk 30410-09	83	tk 39531-18	85	tk 700-273	67
tk 30392-12	81	tk 30410-10	83	tk 39531-23	85	tk 700-273 SF	67
tk 30392-13	81	tk 30410-11	83	tk 39531-25	85	tk 700-274	67
tk 30392-14	81	tk 30410-12	83	tk 39531-30	85	tk 700-277	67
tk 30392-15	81	tk 30410-13	83	tk 39531-40	85	tk 700-999	89
tk 30392-16	81	tk 30410-14	83	tk 39531-50	85	tk 707-300	23
tk 30392-17	81	tk 30410-15	83	tk 39532-18	86	tk 707-301	23
tk 30392-18	81	tk 30410-16	83	tk 39532-23	86	tk 707-302	23
tk 30392-19	81	tk 30410-17	83	tk 39532-30	86	tk 707-303	23
tk 30392-20	81	tk 30410-18	83	tk 39533-18	86	tk 707-330	23
tk 30392-21	81	tk 30410-19	83	tk 39533-23	86	tk 707-331	23
tk 30392-22	81	tk 30410-20	83	tk 39533-30	86	tk 707-332	23
tk 30392-23	81	tk 30410-21	83	tk 39560-18	86	tk 707-333	23

Nummernverzeichnis
Numerical Index

Index numériques
Indice numerico
Indice dei numeri d'articolo

Art. No.	Page	Art. No.	Page	Art. No.	Page	Art. No.	Page
tk 707-338	23	tk 790-199	20	tk 790-309	29	tk 790-399	79
tk 707-350	41	tk 790-200	21	tk 790-310	22, 28, 71, 72	tk 790-404	57
tk 707-650	89	tk 790-201	21		75, 78	tk 790-406	60
tk 707-651	89	tk 790-202	20	tk 790-311	22, 28, 71, 72	tk 790-407	60
tk 707-654	89	tk 790-203	20		75, 78	tk 790-408	57
tk 790-015	11, 12, 13	tk 790-204	20	tk 790-312	22, 28, 71, 72	tk 790-409	57
tk 790-017	11, 12, 13	tk 790-205	20		75, 78	tk 790-410	55
tk 790-019	11, 12, 13	tk 790-206	20	tk 790-313	22, 28, 71, 72	tk 790-411	55
tk 790-021	11, 12, 13	tk 790-207	20		75, 78	tk 790-412	55
tk 790-021	15	tk 790-216	21, 62	tk 790-315	26, 32, 47, 48	tk 790-415	54
tk 790-023	11, 12, 13	tk 790-217	20, 62	tk 790-316	32	tk 790-416	53
tk 790-023	15	tk 790-218	20, 62	tk 790-317	32	tk 790-430	16
tk 790-025	11, 12, 13	tk 790-219	20	tk 790-318	32, 33, 34	tk 790-470	18
tk 790-025	15, 16	tk 790-220	21	tk 790-320	33	tk 790-471	17
tk 790-027	12, 13	tk 790-221	21	tk 790-321	33	tk 790-480	19
tk 790-029	12, 13	tk 790-222	20	tk 790-322	33	tk 790-482	22, 71, 78
tk 790-031	12, 13, 15	tk 790-223	20	tk 790-323	32, 33, 34	tk 790-483	22
tk 790-033	12, 13, 15	tk 790-224	20	tk 790-324	32, 34	tk 790-484	22
tk 790-035	5, 12, 13, 15, 16	tk 790-225	20	tk 790-325	34	tk 790-485	22
tk 790-037	11	tk 790-226	20	tk 790-326	16	tk 790-486	22
tk 790-040	12	tk 790-227	20	tk 790-327	34	tk 790-487	22, 71, 78
tk 790-042	12	tk 790-234	62	tk 790-330	32	tk 790-488	22
tk 790-044	12	tk 790-235	62	tk 790-331	32	tk 790-490	33
tk 790-046	12	tk 790-236	21	tk 790-332	32	tk 790-491	33
tk 790-047	12	tk 790-237	20	tk 790-333	15	tk 790-492	33
tk 790-048	12	tk 790-238	20	tk 790-333	65	tk 790-495	22
tk 790-050	13	tk 790-239	20	tk 790-334	11	tk 790-496	22
tk 790-052	13	tk 790-240	21	tk 790-339	15	tk 790-498	34
tk 790-053	13	tk 790-241	21	tk 790-341	32	tk 790-515	11
tk 790-055	13	tk 790-242	20	tk 790-343	32	tk 790-517	11
tk 790-100	15	tk 790-243	20	tk 790-344	32	tk 790-519	11
tk 790-102	15	tk 790-244	20	tk 790-345	34	tk 790-521	11
tk 790-104	15	tk 790-245	20	tk 790-360	53	tk 790-523	11
tk 790-106	15	tk 790-246	20	tk 790-362	53	tk 790-525	11
tk 790-110	15	tk 790-247	20	tk 790-364	54	tk 790-537	11
tk 790-112	16	tk 790-250	21	tk 790-366	54	tk 790-570	39
tk 790-120	15	tk 790-251	21	tk 790-368	55	tk 790-572	40
tk 790-150	23	tk 790-255	21	tk 790-368 DL	55	tk 790-573	40
tk 790-151	23	tk 790-256	21	tk 790-369	55	tk 790-574	40
tk 790-152	23	tk 790-258	21	tk 790-369 DL	55	tk 790-575	40
tk 790-169	22	tk 790-260	21	tk 790-370	17	tk 790-615	11
tk 790-170	22	tk 790-262	21	tk 790-371	17	tk 790-617	11
tk 790-171	22	tk 790-263	21	tk 790-374	31, 55, 73	tk 790-619	11
tk 790-172	22	tk 790-264	21	tk 790-375	17	tk 790-621	11
tk 790-173	22	tk 790-280	22	tk 790-376	53	tk 790-623	11
tk 790-174	22	tk 790-281	22	tk 790-380	57	tk 790-625	11
tk 790-175	22	tk 790-282	22	tk 790-381	57	tk 790-627	11
tk 790-176	22	tk 790-284	22	tk 790-384	57	tk 790-660	53
tk 790-177	22	tk 790-285	22	tk 790-385	58	tk 790-662	53
tk 790-178	22	tk 790-288	22	tk 790-386	58	tk 790-666	54
tk 790-179	22	tk 790-289	22	tk 790-387	58	tk 790-667	55
tk 790-180	22	tk 790-290	19	tk 790-388	58	tk 790-668	55
tk 790-186	22	tk 790-291	19	tk 790-389	58	tk 790-669	55
tk 790-187	22	tk 790-293	19	tk 790-390	57	tk 790-690	35
tk 790-189	22	tk 790-294	19	tk 790-391	57	tk 790-725	34
tk 790-194	22	tk 790-298	19	tk 790-394	57	tk 790-726	34
tk 790-196	21	tk 790-300	29, 52	tk 790-395	57	tk 790-727	34
tk 790-197	20	tk 790-305	29	tk 790-397	80	tk 790-800	48
tk 790-198	20	tk 790-308	29, 52	tk 790-398	79	tk 790-801	48

Nummernverzeichnis
Numerical Index

Index numériques
Indice numerico
Indice dei numeri d'articolo

Art. No.	Page	Art. No.	Page	Art. No.	Page	Art. No.	Page
tk 790-802	48	tk 791-365	31	tk 793-354	73	tk 799-365	42
tk 790-808	47	tk 791-367	31	tk 793-355	73	tk 799-366	43
tk 790-809	47	tk 791-420	30	tk 793-360	77	tk 799-371	42
tk 790-810	47	tk 791-421	30	tk 793-361	77	tk 799-372	42
tk 790-811	47	tk 791-422	31	tk 793-364	76	tk 799-373	42
tk 790-812	47	tk 791-423	31	tk 793-365	76	tk 799-374	42
tk 790-813	47	tk 791-424	30	tk 793-366	76	tk 799-378	42
tk 790-814	47	tk 791-450	30	tk 793-367	76	tk 799-576	39
tk 790-815	47	tk 791-451	30	tk 793-368	76	tk 799-577	39
tk 790-833	24	tk 791-452	30	tk 793-369	76	tk 799-578	39
tk 790-843	24	tk 791-453	30	tk 793-376	76	tk 799-579	39
tk 790-852	24	tk 791-454	31	tk 793-377	76	tk 85109-01	88
tk 790-862	24	tk 791-455	31	tk 794-040	14	tk 85109-02	88
tk 791-2601	65	tk 791-457	30	tk 794-041	14	tk 85109-10	88
tk 791-2602	65	tk 791-458	30	tk 794-042	14	tk 87280-2F-BK	89
tk 791-2604	65	tk 791-463	31	tk 794-043	14	tk 87280-2F-BL	89
tk 791-2606	65	tk 791-465	31	tk 794-044	14	tk 87280-2F-GR	89
tk 791-2608	65	tk 791-467	31	tk 794-385	58	tk 87280-2F-RE	89
tk 791-2610	65	tk 793-008	68	tk 794-386	58	tk 87280-2F-SI	89
tk 791-2612	65	tk 793-010	68	tk 794-387	58	tk 87280-2F-YE	89
tk 791-2614	65	tk 793-011	68	tk 794-388	58	tk 87290-2F-BK	89
tk 791-2720	65	tk 793-013	68	tk 794-389	58	tk 87290-2F-BL	89
tk 791-2721	65	tk 793-023	68	tk 794-390	58	tk 87290-2F-GR	89
tk 791-2722	65	tk 793-026	68	tk 794-391	58	tk 87290-2F-RE	89
tk 791-2723	65	tk 793-040	69	tk 794-392	58	tk 87290-2F-SI	89
tk 791-2724	65	tk 793-049	74, 77	tk 794-393	58	tk 87290-2F-YE	89
tk 791-2725	65	tk 793-050	74, 77	tk 794-394	58	tk 95000-20	90
tk 791-2801	65	tk 793-052	69	tk 794-395	58	tk 95000-50	90
tk 791-2802	65	tk 793-120	74	tk 799-300	41	tk 95000-51	90
tk 791-2803	65	tk 793-121	74	tk 799-305	41	tk 95000-52	90
tk 791-2804	65	tk 793-123	74	tk 799-308	41	tk 95010-00	60, 90
tk 791-2805	65	tk 793-125	74	tk 799-309	41	tk 95011-00	90
tk 791-2806	65	tk 793-126	74	tk 799-310	44	tk 95011-02	90
tk 791-2807	65	tk 793-127	74	tk 799-311	44	tk 95012-00	90
tk 791-2809	65	tk 793-180	70	tk 799-312	44		
tk 791-2900	61	tk 793-181	70	tk 799-313	44, 46		
tk 791-2902	61	tk 793-182	70	tk 799-320	45		
tk 791-2904	61	tk 793-183	70	tk 799-321	45		
tk 791-2910	61	tk 793-184	70	tk 799-322	45		
tk 791-2912	61	tk 793-185	70	tk 799-323	44		
tk 791-2914	61	tk 793-186	70	tk 799-323	45, 44		
tk 791-2919	61	tk 793-187	70	tk 799-324	45		
tk 791-350	30	tk 793-240	73	tk 799-326	46		
tk 791-351	30	tk 793-242	73	tk 799-327	46		
tk 791-3514	66	tk 793-243	73	tk 799-328	45		
tk 791-3515	66	tk 793-244	73	tk 799-330	44		
tk 791-3516	66	tk 793-245	73	tk 799-331	44		
tk 791-3517	66	tk 793-250	73	tk 799-332	44		
tk 791-352	30	tk 793-252	73	tk 799-333	44		
tk 791-3520	66	tk 793-253	73	tk 799-335	44		
tk 791-3522	66	tk 793-254	73	tk 799-345	46		
tk 791-3524	66	tk 793-255	73	tk 799-350	42		
tk 791-353	30	tk 793-300	72, 75	tk 799-354	43		
tk 791-354	31	tk 793-320	74	tk 799-355	42		
tk 791-355	31	tk 793-321	74	tk 799-356	43		
tk 791-357	30	tk 793-323	74	tk 799-357	43		
tk 791-358	30	tk 793-350	73	tk 799-360	42		
tk 791-359	31	tk 793-352	73	tk 799-361	42		
tk 791-363	31	tk 793-353	73	tk 799-362	42		

Notizen
Notes

Notices
Notas
Note

Notizen | Notices
Notes | *Notas*
Note

Notizen
Notes

Notices
Notas
Note

Wichtige Hinweise

Dieser Katalog bleibt Eigentum der Firma TEKNO-MEDICAL Optik-Chirurgie GmbH, auch wenn dafür eine Schutzgebühr bezahlt wurde. Er kann von uns jederzeit zurückgefordert werden, wenn er gegen unsere Interessen und nicht zum Vertrieb und Einkauf von TEKNO Produkten verwendet wird. Auch behalten wir uns in solch einem Falle weitergehende Maßnahmen vor.

Der Nachdruck oder Kopieren dieses Kataloges – im Gesamten oder auch nur auszugsweise – ist ohne unsere schriftliche Genehmigung verboten. Modelländerungen vorbehalten. Gedruckt in der Bundesrepublik Deutschland

Important notice

This catalogue remains property of TEKNO-MEDICAL Optik-Chirurgie GmbH even if we have asked for a lending fee. We can at any time recall the catalogue, in case that it has been not used according to our interests, i.e. sale or purchase of TEKNO products. We preserve the right for further steps in that case.

Reproduction or copying of this catalogue in whole or in parts is forbidden without our written permission. Patterns are subject to change. Printed in Germany

Indications importantes

Ce catalogue reste la propriété de TEKNO-MEDICAL Optik-Chirurgie GmbH, même si nous avons demandé le paiement d'une taxe de protection. Nous pouvons demander le retour du catalogue dans le cas où celui-ci n'est pas utilisé conformément à nos intérêts, pour la vente ou l'achat de nos produits. Dans ce cas nous nous réservons le droits de mener des actions juridiques.

La reproduction ou la copie totale ou partielle de ce catalogue est interdite sans notre accord écrit. Sous réserve des modifications techniques. Imprimé en Allemagne

Avisos importantes

Este catálogo es propiedad de TEKNO-MEDICAL Optik-Chirurgie GmbH, aún en el caso de haber abonado por él una tasa de colaboración. Podemos solicitar la devolución del catálogo en caso de que no sea utilizado para la compra o venta de nuestros productos. En este caso nos reservamos el derecho de tomar medidas jurídicas.

La reproducción o copia total o parcial de este catálogo esta prohibido sin nuestro consentimiento escrito. Salvo modificaciones técnicas. Impreso en la República Federal de Alemania

Avvertenze importanti

Questo catalogo rimane proprietà della TEKNO-MEDICAL Optik-Chirurgie GmbH, anche se è stato rilasciato gratuitamente contro pagamento. Possiamo in ogni momento richiederlo indietro, in caso non stato usato in accordo con i nostri interessi (acquisto e vendita dei prodotti TEKNO-Medical). Ci riserviamo in questo caso il diritto di prendere ulteriori provvedimenti.

La copia o la riproduzione di questo catalogo in parte o nella sua totalità è vietata senza il nostro permesso scritto. Ci riserviamo la facoltà di cambiamenti nei modelli. Stampato in Germania



TEKNO-MEDICAL Optik-Chirurgie GmbH

Sattlerstrasse 11 · 78532 Tuttlingen, Germany

Telefon +49 (74 61) 1701-0 · Fax +49 (74 61) 1701-50

mail@tekno-medical.com · www.tekno-medical.com

© 11.2014 - TEKNO-MEDICAL Optik-Chirurgie GmbH

TEKNO is a registered trademark of TEKNO-MEDICAL Optik-Chirurgie GmbH