

RENOVATION PROPOSAL

***** MCBEAN PKWY
 Unit *****
 Valencia, CA 91354

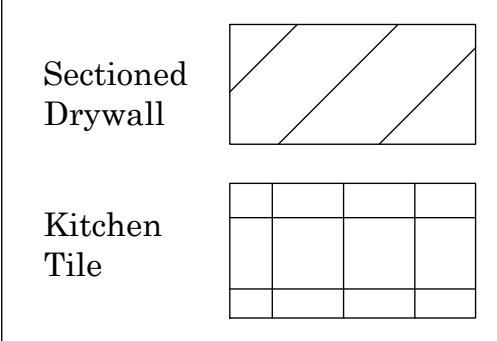

KEY

- A1 - Recessed Downlight
- B1 - Recessed Adjustable Downlight
- D1 - Exterior Sconce
- G1 - Interior Sconce
- Recessed LED Strip
- A1 - Fan / Light Combo
- F1 - Decorative Pendant Large
- E1 - Decorative Pendant Small
- H1 - Recessed Wall

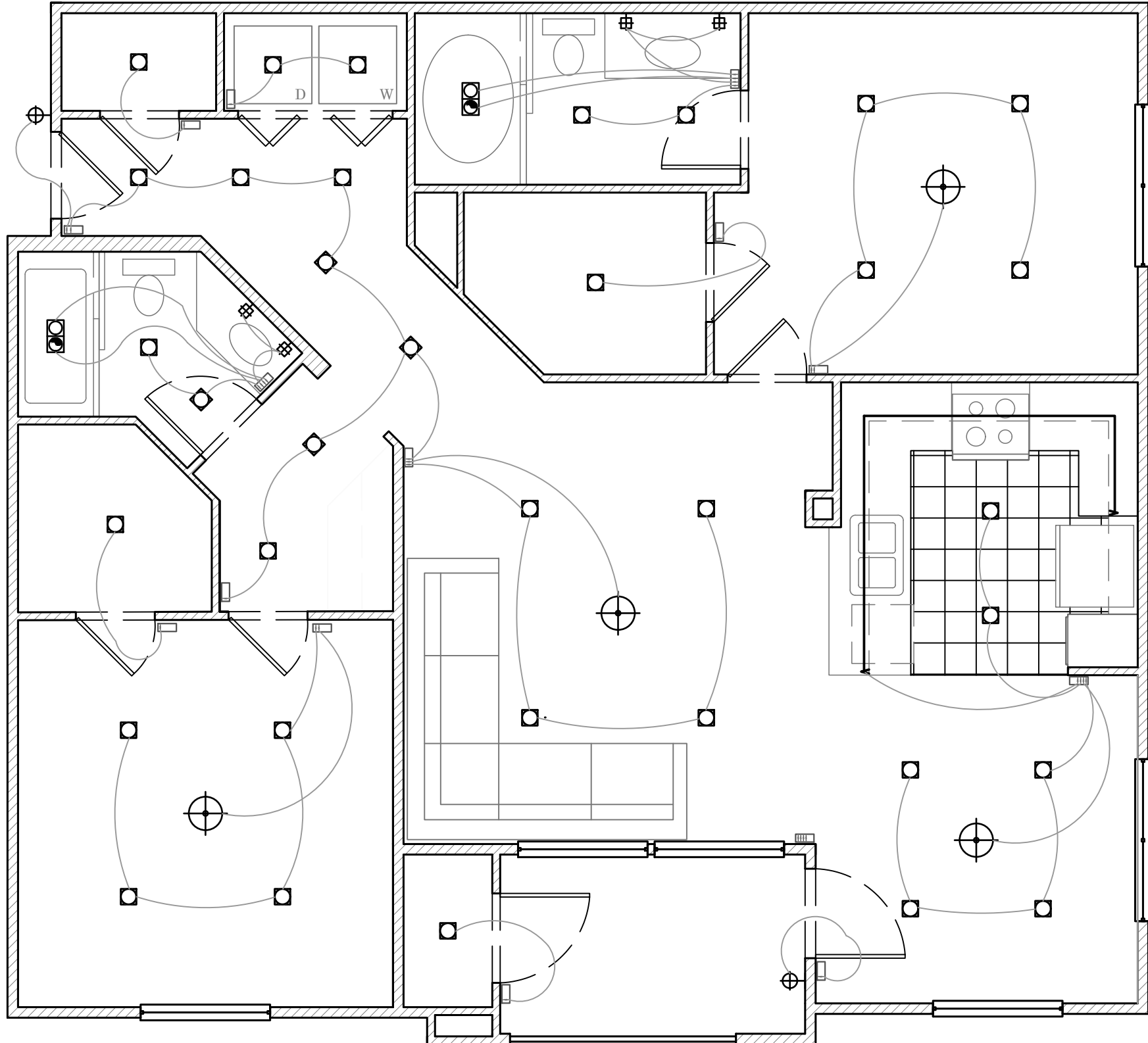

SCALE: 1/4" = 1' - 0"

LIGHTING DESIGN

MAX OKST
 103 OAKES STREET
 PORT JEFFERSON, NY 11777
 (631) 605-9525

<p> A1 - Recessed Downlight</p> <p> B1 - Recessed Adjustable Downlight</p> <p> D1 - Exterior Sconce</p> <p> G1 - Interior Sconce</p> <p> Recessed LED Strip</p>	<p> A1 - Fan / Light Combo</p> <p> F1 - Decorative Pendant Large</p> <p> E1 - Decorative Pendant Small</p> <p> H1 - Recessed Wall</p>
---	---

GENERAL ELECTRICAL NOTES:

ALL WORK SHALL BE DONE ACCORDING TO CA STATE AND LOCAL CODES AND BE SUPERVISED BY A LICENSED ELECTRICIAN FROM THE STATE OF CALIFORNIA.

ELECTRICIAN SHALL BE RESPONSIBLE FOR WIRING ACCORDING TO PLANS AND INCLUDE OUTLETS, WIRING, FIXTURES, SMOKE & CO DETECTORS PER CODE, ALL MECHANICAL POWER

ALL FIXTURES ARE LIGHTING DESIGNER & OWNER SELECTED.

ALL EXTERIOR FIXTURES, OUTLETS, & SWITCHES TO BE WEATHER-PROOFED

ELECTRICIAN SHALL REVIEW PLAN AND MAKE SUGGESTIONS FOR IMPROVEMENTS TO LIGHTING DESIGNER, ARCHITECT & OWNER. ANY DISCREPANCIES IN PLANS SHALL BE BROUGHT TO THE ATTENBTION OF THE LIGHTING DESIGNER IMMEDIATELY.

LOCATION OF CABLE & INTERNET TO BE CONFIRMED BY OWNER.

REVISIONS

DATE	CHANGES	WHO
	Final Plot	MAO

GENERAL ELECTRICAL NOTES:

ALL WORK SHALL BE DONE ACCORDING TO CA STATE AND LOCAL CODES AND BE SUPERVISED BY A LICENSED ELECTRICIAN FROM THE STATE OF CALIFORNIA.

ELECTRICIAN SHALL BE RESPONSIBLE FOR WIRING ACCORDING TO PLANS AND INCLUDE OUTLETS, WIRING, FIXTURES, SMOKE & CO DETECTORS PER CODE, ALL MECHANICAL POWER

ALL FIXTURES ARE LIGHTING DESIGNER & OWNER SELECTED.

ALL EXTERIOR FIXTURES, OUTLETS, & SWITCHES TO BE WEATHER-PROOFED

ELECTRICIAN SHALL REVIEW PLAN AND MAKE SUGGESTIONS FOR IMPROVEMENTS TO LIGHTING DESIGNER, ARCHITECT & OWNER. ANY DISCREPANCIES IN PLANS SHALL BE BROUGHT TO THE ATTENTION OF THE LIGHTING DESIGNER IMMEDIATELY.



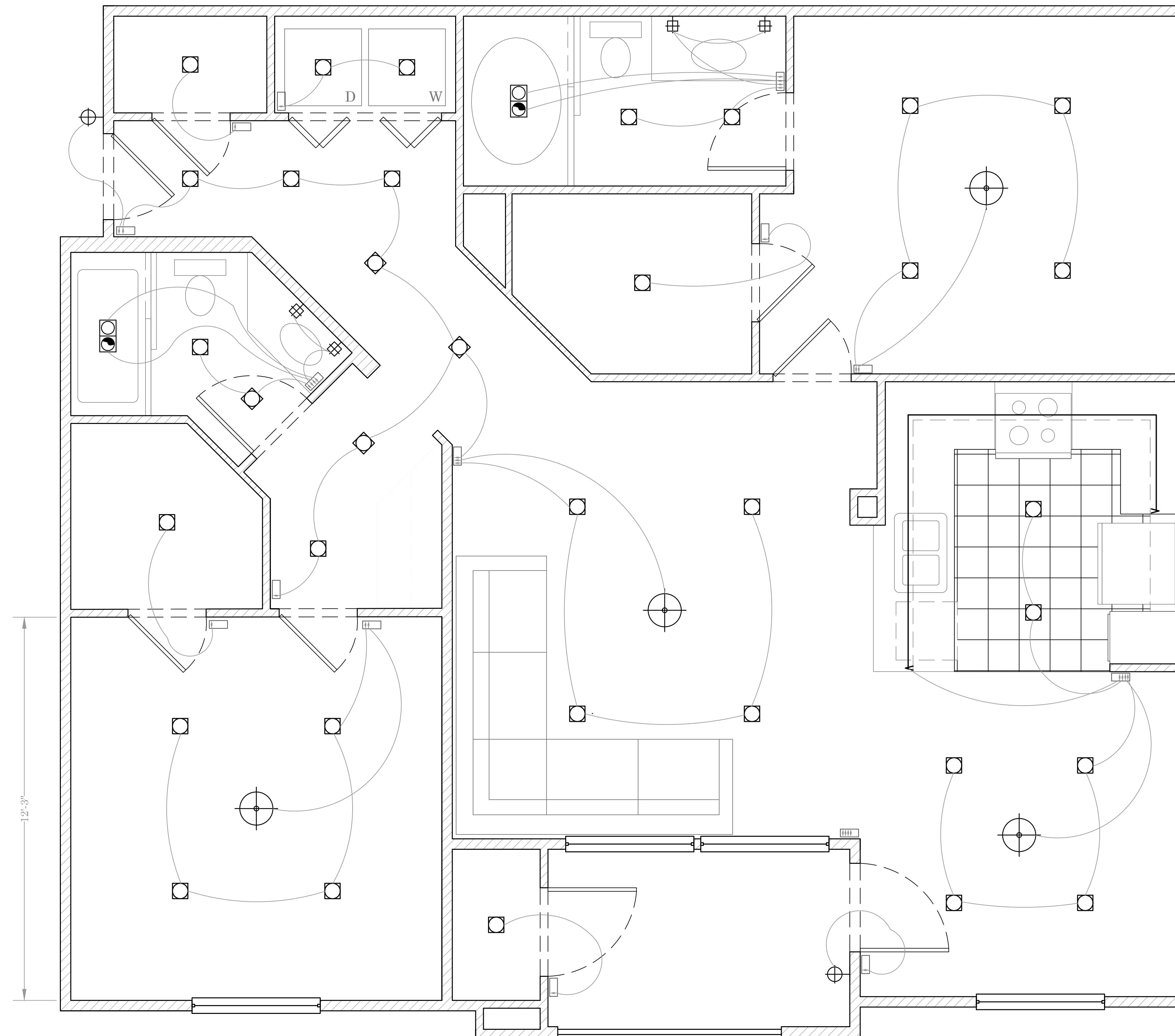

LOCATION OF CABLE & INTERNET TO BE CONFIRMED BY OWNER.



LIGHTING FIXTURE & CIRCUIT LAYOUT

SCALE: 1/2" = 1' - 0"

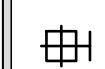
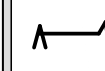
KEY

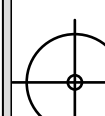
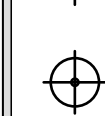
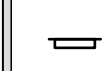
-  A1 - Recessed Downlight
-  B1 - Recessed Adjustable Downlight
-  D1 - Exterior Sconce
-  G1 - Interior Sconce
-  Recessed LED Strip
-  A1 - Fan / Light Combo
-  F1 - Decorative Pendant Large
-  E1 - Decorative Pendant Small
-  H1 - Recessed Wall

REVISIONS

DATE	CHANGES	WHO
	Final Plot	MAO

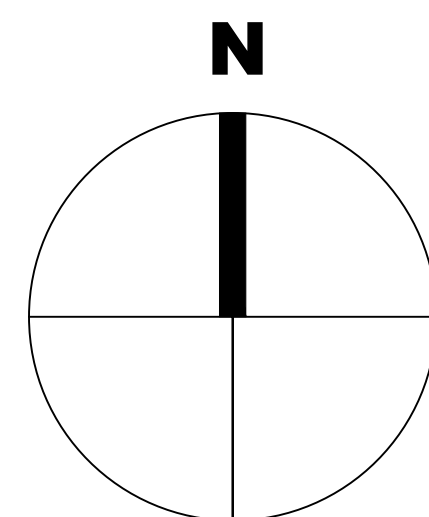

MAX OKST PLATE
 (631) 605-9525 | maxokst@gmail.com
 www.maxokst.com

LX Circuit Layout

Scale: 1/2" = 1' - 0" Size: ARCH D

2

OF 6

This drawing represents visual concepts, suggested construction and fixture placement only. The designer is responsible for determining the electrical and electrical requirements of this design. Engineering, construction, handling, or use should be determined by qualified individuals. All materials and construction must comply with the most stringent applicable Federal and Local Fire, Safety, Energy, and Environmental Codes.

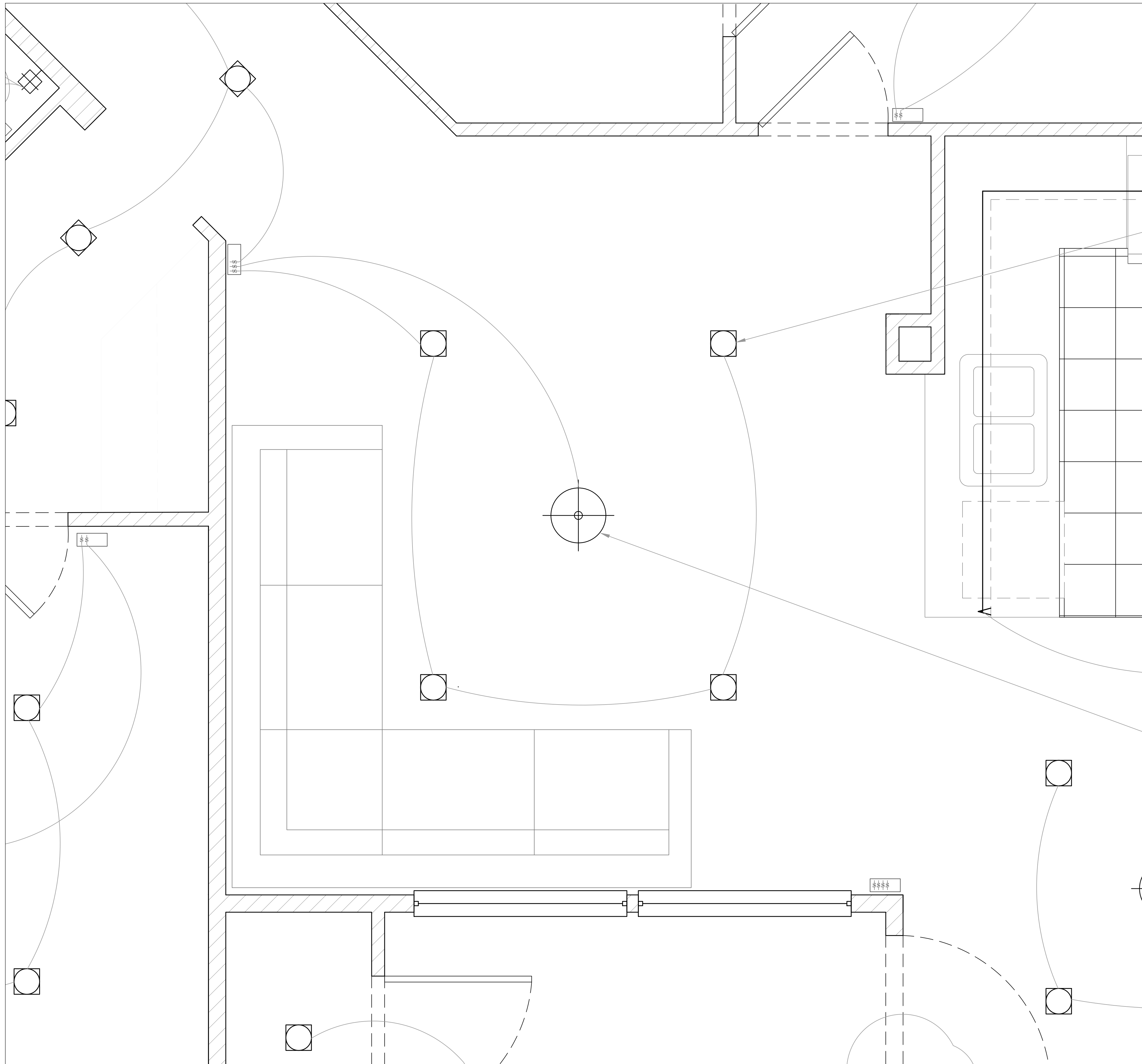

SCALE: 1" = 1' - 0"

Recessed Downlight -

Nora Lighting M2 LED Canless Recessed Fixture 2" Square Trim - IC Rated and Airtight - 3000K - 600 Lumens











Hanging Pendant - Large

Darby - 36" | 86w, 5130 lumens



KEY

-  A1 - Recessed Downlight
-  B1 - Recessed Adjustable Downlight
-  D1 - Exterior Sconce
-  G1 - Interior Sconce
-  Recessed LED Strip
-  A1 - Fan / Light Combo
-  F1 - Decorative Pendant Large
-  E1 - Decorative Pendant Small
-  H1 - Recessed Wall

REVISIONS

DATE	CHANGES	WHO
	Final Plot	MAO

MAX OKST PLATE
 (631) 605-9525 | maxokst@gmail.com
 www.maxokst.com

Living Room Detail **3**
 Scale: 1" = 1' - 0" Size: ARCH D OF 6

This drawing represents visual concepts, suggested construction and fixture placement only. The designer is responsible to determine the electrical and structural requirements of this design. Engineering, construction, handling, or use should be determined by qualified individuals. All materials and construction must comply with the most stringent applicable Federal and Local Fire, Safety, Energy, and Environmental Codes.

SCALE: 1-1/2" = 1' - 0"

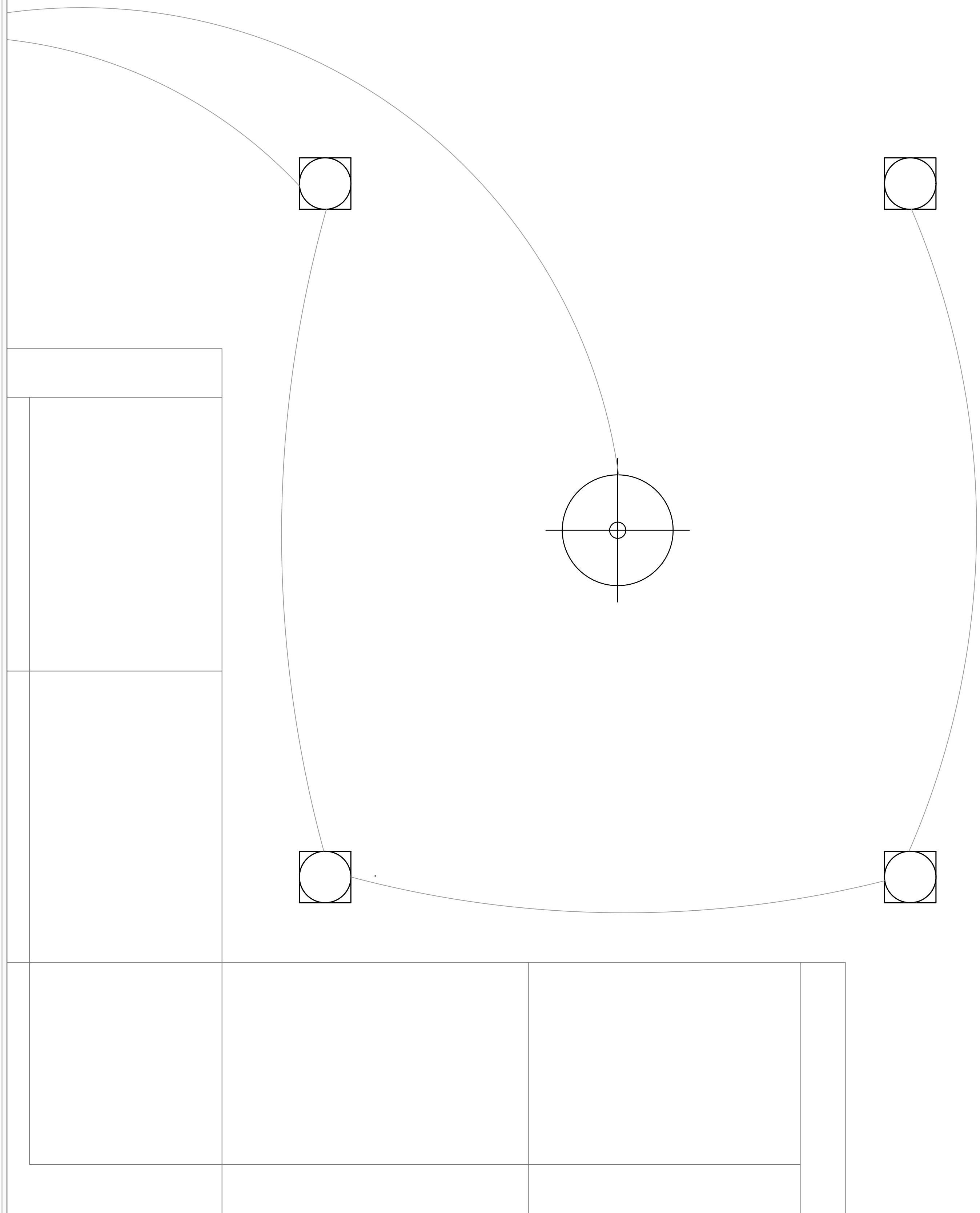

LIVING ROOM PENDANT - MOUNT



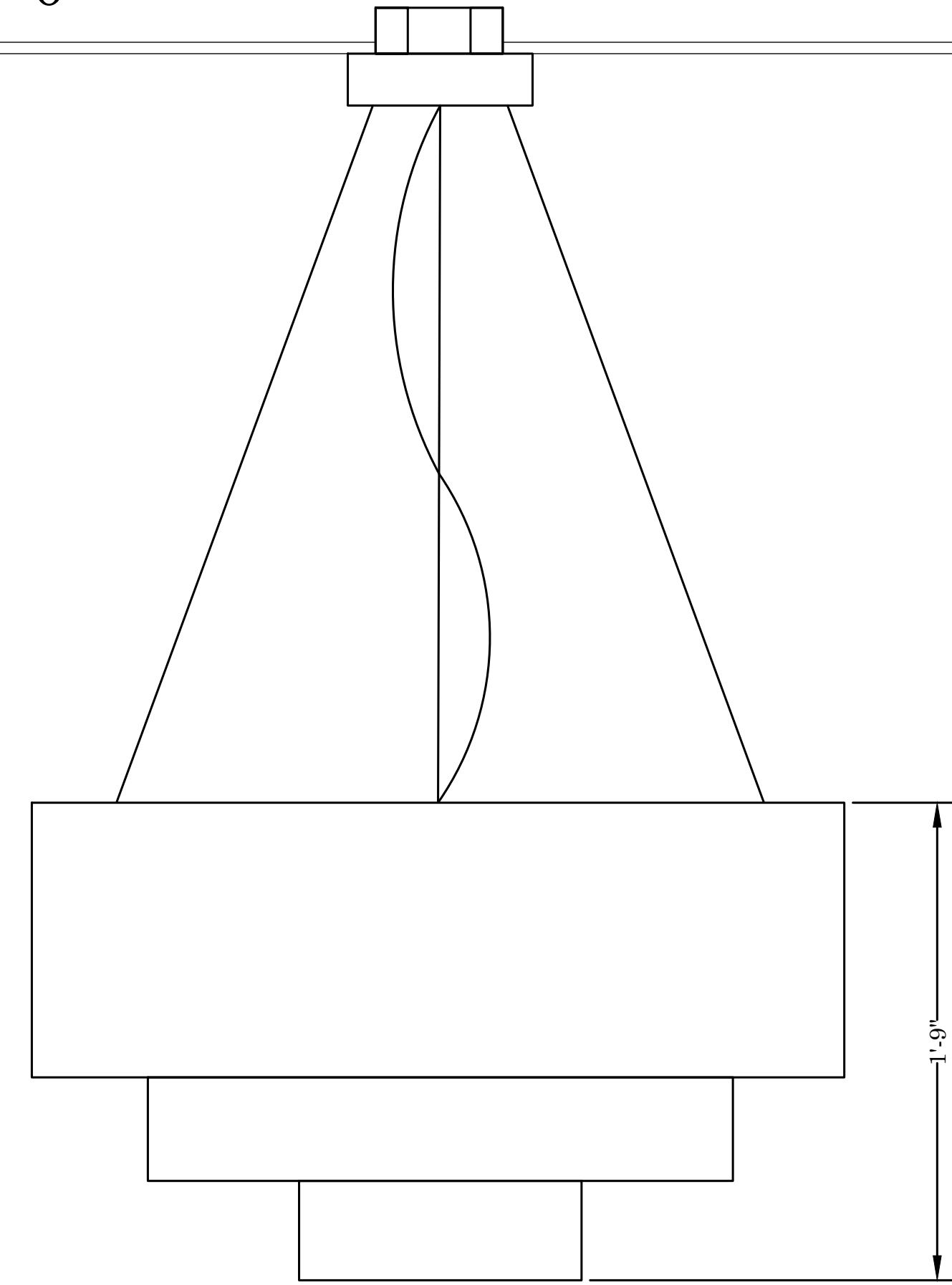



SCALE: 1' - 0" = 1' - 0"



Darby - 36" | 86w,
5130 lumens

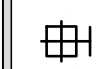
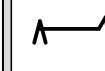

KEY

-  A1 - Recessed Downlight
-  B1 - Recessed Adjustable Downlight
-  D1 - Exterior Sconce
-  G1 - Interior Sconce
-  Recessed LED Strip
-  A1 - Fan / Light Combo
-  F1 - Decorative Pendant Large
-  E1 - Decorative Pendant Small
-  H1 - Recessed Wall

REVISIONS

DATE	CHANGES	WHO
	Final Plot	MAO

MAX OKST PLATE
 (631) 605-9525 | maxokst@gmail.com
 www.maxokst.com

LR Mounting Detail 4 OF 6
 Scale: Various Size: ARCH D

This drawing represents visual concepts, suggested construction and fixture placement only. The designer is not qualified to determine the structural or electrical requirements of this design. Engineering, construction, handling, or use should be determined by qualified individuals. All materials and construction must comply with the most stringent applicable Federal and Local Fire, Safety, Energy, and Environmental Codes.

SCALE: 3" = 1' - 0"

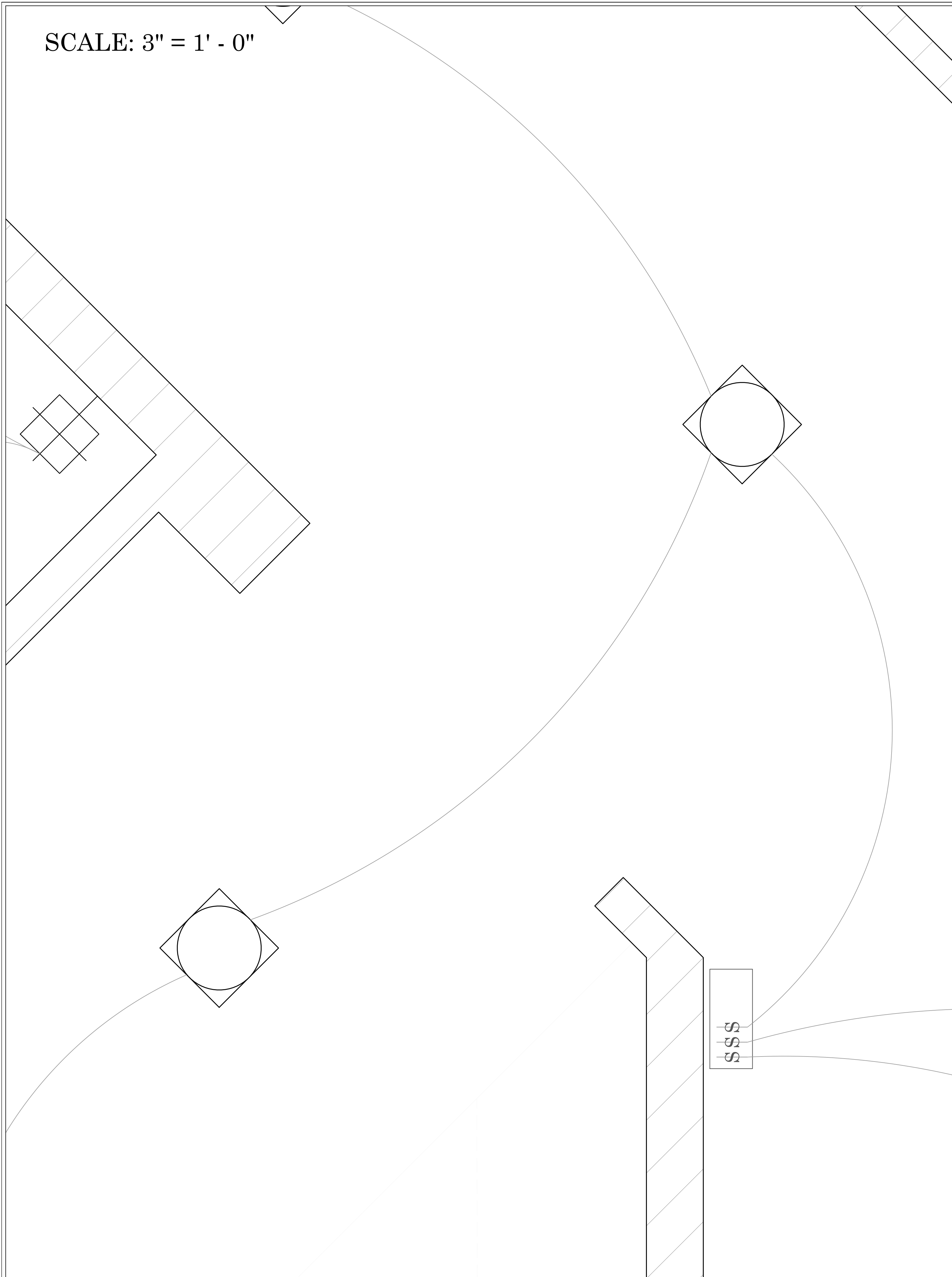

RECESSED DOWNLIGHT - TYPICAL



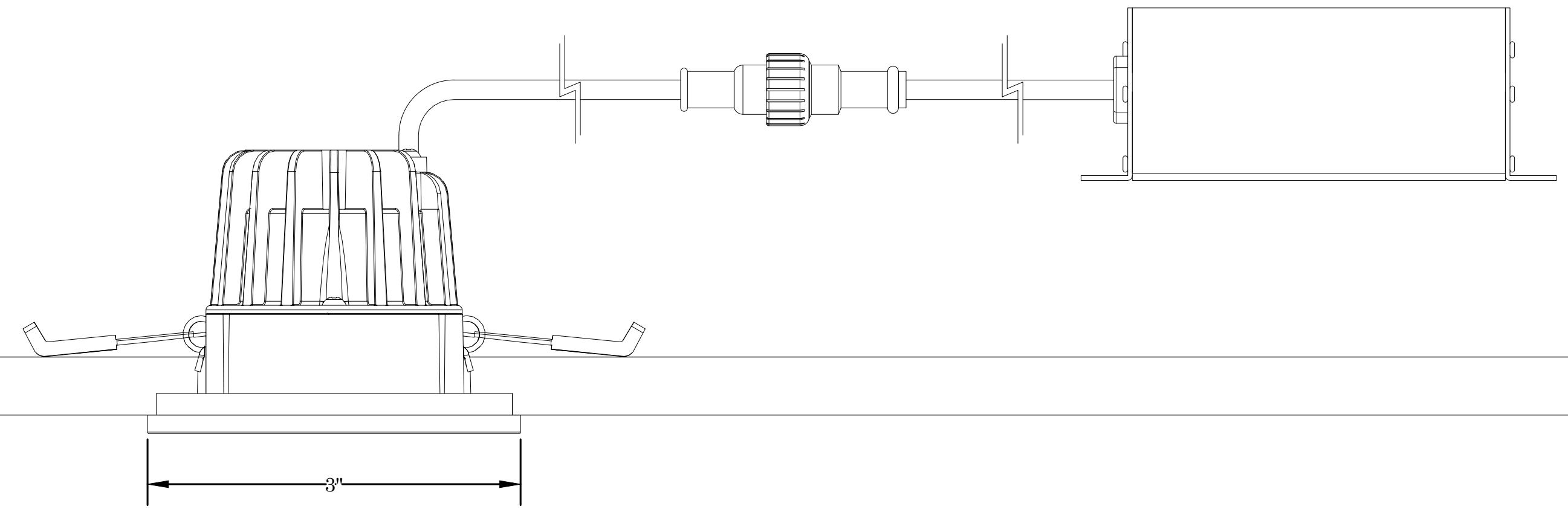



SCALE: 1' - 0" = 1' - 0"



Nora Lighting M2 LED
Canless Recessed
Fixture 2" Square Trim
- IC Rated and Airtight
- 3000K - 600 Lumens

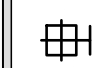
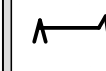

KEY

-  A1 - Recessed Downlight
-  B1 - Recessed Adjustable Downlight
-  D1 - Exterior Sconce
-  G1 - Interior Sconce
-  Recessed LED Strip
-  A1 - Fan / Light Combo
-  F1 - Decorative Pendant Large
-  E1 - Decorative Pendant Small
-  H1 - Recessed Wall

REVISIONS

DATE	CHANGES	WHO
	Final Plot	MAO

MAX OKST PLATE
 (631) 605-9525 | maxokst@gmail.com
 www.maxokst.com





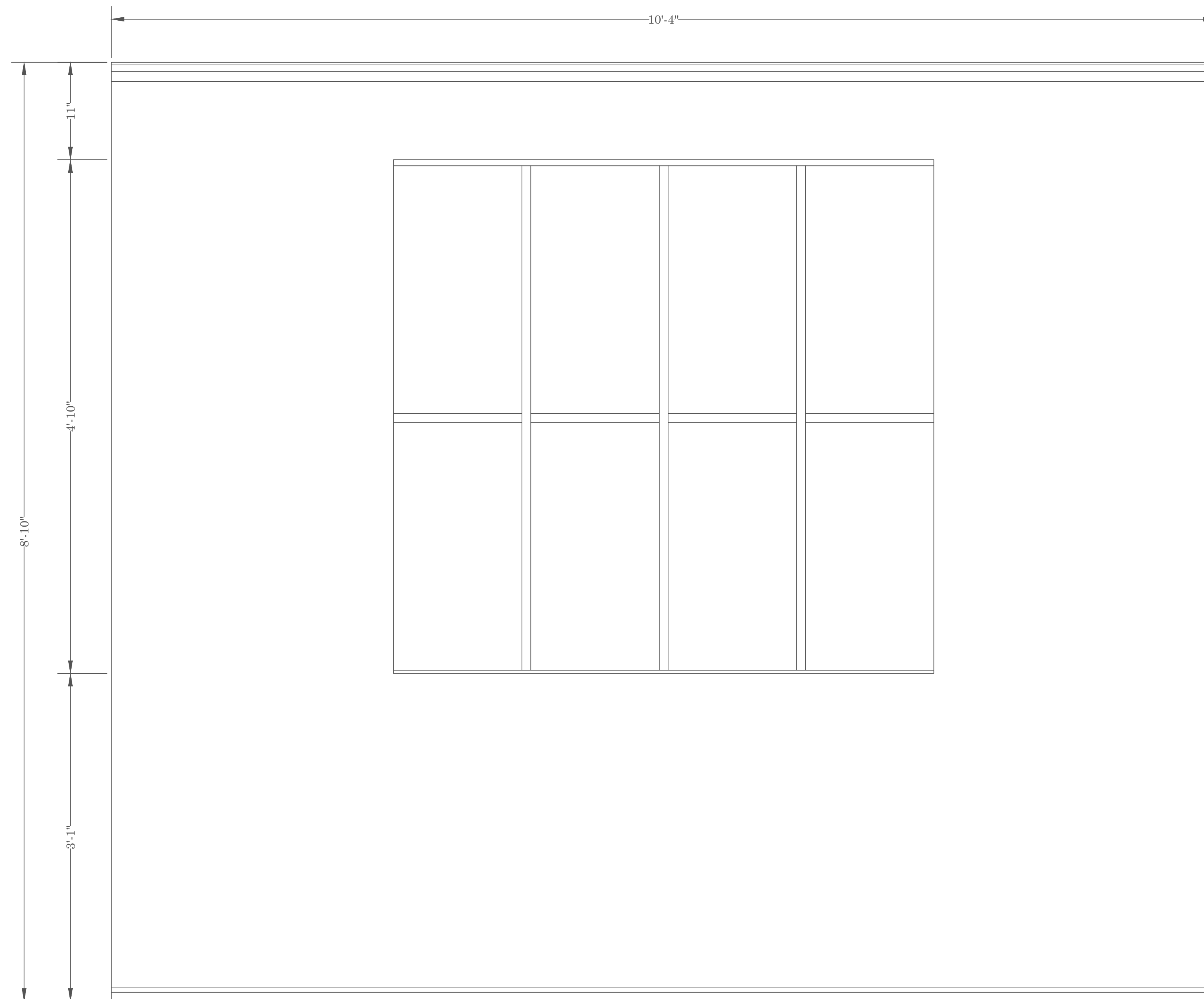



Typ. Recessed Mount **5**
 Scale: Various Size: ARCH D OF 6

This drawing represents visual concepts, suggested construction and fixture placement only. The designer is responsible to determine the electrical and structural requirements of this design. Engineering, construction, handling, or use should be determined by qualified individuals. All materials and construction must comply with the most stringent applicable Federal and Local Fire, Safety, Energy, and Environmental Codes.

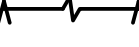

DINING ROOM EAST WALL
 SCALE: 1-1/2" = 1' - 0"

KEY

-  A1 - Recessed Downlight
-  B1 - Recessed Adjustable Downlight
-  D1 - Exterior Sconce
-  G1 - Interior Sconce
-  Recessed LED Strip
-  A1 - Fan / Light Combo
-  F1 - Decorative Pendant Large
-  E1 - Decorative Pendant Small
-  H1 - Recessed Wall

REVISIONS

DATE	CHANGES	WHO
	Final Plot	MAO