

BD



Dissecting and Tissue Forceps

Pinzas de disección y pinzas quirúrgicas

Dissecting and Tissue Forceps - Pinzas de disección y pinzas quirúrgicas

Micro Forceps, Jeweler Patterns

Micropinzas, tipo relojero

BD



0.2 mm

1/1

1/2

BD330R

110 mm, 4 3/8"

0.15 mm

1/1

1/2

BD331R

110 mm, 4 3/8"

0.3 mm

1/1

1/2

BD329R

110 mm, 4 3/8"

0.2 mm

1/1

1/2

BD333R

115 mm, 4 1/2"

0.4 mm

1/1

1 x 2 teeth
1 x 2 dientes

1/2

BD343R

115 mm, 4 1/2"

0.3 mm

1/1

1/2

BD335R

135 mm, 5 1/4"

0.4 mm

1/1

1 x 2 teeth
1 x 2 dientes

1/2

BD345R

135 mm, 5 1/4"



Dissecting and Tissue Forceps – Pinzas de disección y pinzas quirúrgicas

Micro Suture Tying Forceps

Micropinzas para anudar suturas

BD

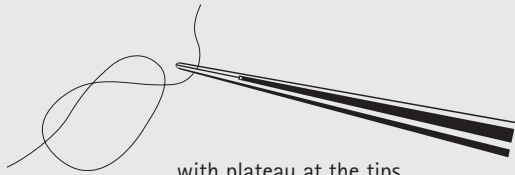

with plateau at the tips
con plataforma en las puntas

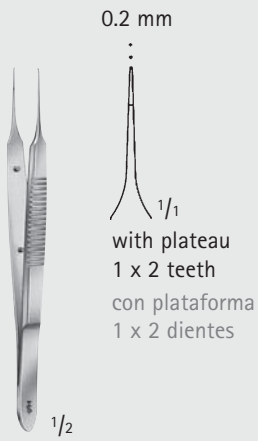

0.2 mm

1/1

with plateau
1 x 2 teeth
con plataforma
1 x 2 dientes

1/2

BONNER MODELL

BD505R

95 mm, 3 3/4"

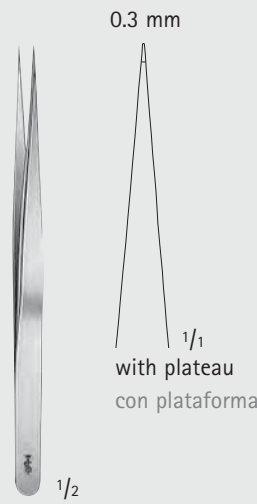

0.3 mm

1/1

with plateau
con plataforma

1/2

BD338R

120 mm, 4 3/4"

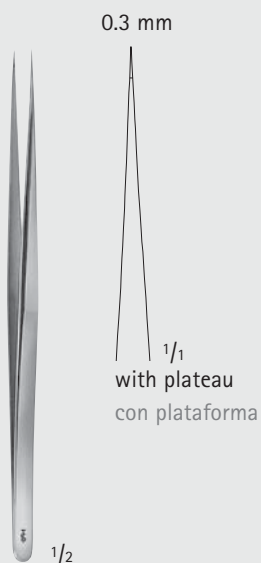

0.3 mm

1/1

with plateau
con plataforma

1/2

WISE

BD336R

135 mm, 5 1/4"

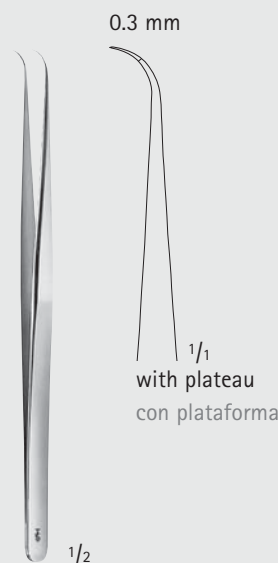

0.3 mm

1/1

with plateau
con plataforma

1/2

WISE

BD337R

135 mm, 5 1/4"



MILLIMETERS

Dissecting and Tissue Forceps - Pinzas de disección y pinzas quirúrgicas

Micro Suture Tying Forceps

Micropinzas para anudar suturas

BD



0.5 mm



1/2

LAZAR

BD260R

155 mm, 6"

0.8 mm



1/2

LAZAR

BD261R

155 mm, 6"

0.5 mm

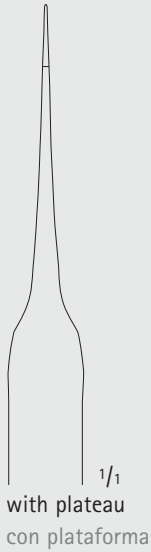

1/2

BD264R

185 mm, 7 1/4"

0.8 mm

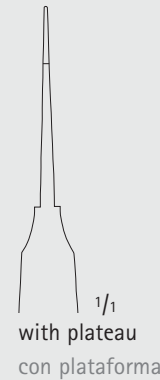

1/2

AUSTIN

BD340R

140 mm, 5 1/2"



Dissecting and Tissue Forceps – Pinzas de disección y pinzas quirúrgicas

Micro Forceps with Lightweight Plastic Handle

Micropinzas con mangos de plástico ligero



The MÜLLER Micro instrument system

A top quality set for peripheral microsurgery. Numerous details tried and tested in practice mean increased efficiency and safety.

Natural holding position = increased sensitivity

- The light plastic profile increases the grip surface, thus guaranteeing a natural hand position without cramping and providing enhanced sensitivity.

Easier rotation = extended working area

- The round grip cross section permits easy and uniform rotation of the instrument. This extends the application and working areas.

Safe grip

- Optimum handling
- Development in accordance with ergonomic criteria and the low weight of the new plastic grips provide fatiguefree working and optimum handling.

El sistema de microinstrumentos de MÜLLER

Un juego de calidad superior para la microcirugía periférica. Numerosos detalles probados y examinados en la práctica llevan a una efectividad y seguridad elevada.

Posición natural de agarre = mayor sensibilidad

- El ligero perfil de plástico incrementa la superficie de agarre, garantizando así una posición natural de la mano libre de calambres y proporcionando mayor sensibilidad.

Rotación más fácil = aumenta el campo de intervención

- El corte transversal redondo de la superficie de agarre permite una rotación sencilla y uniforme del instrumento. Esto aumenta aplicaciones y campos de intervención.

Agarre seguro

- Manejo óptimo
- El desarrollo siguiendo criterios ergonómicos en combinación con el bajo peso de las ramas de plástico permite un trabajo sin fatiga y un manejo óptimo.

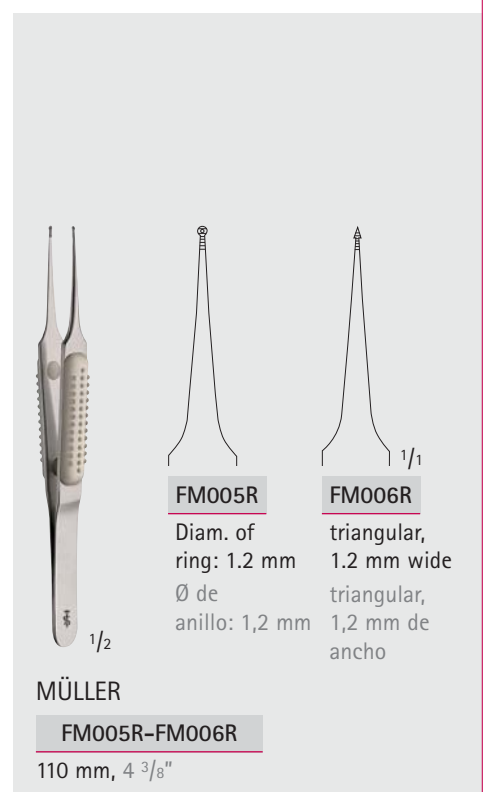
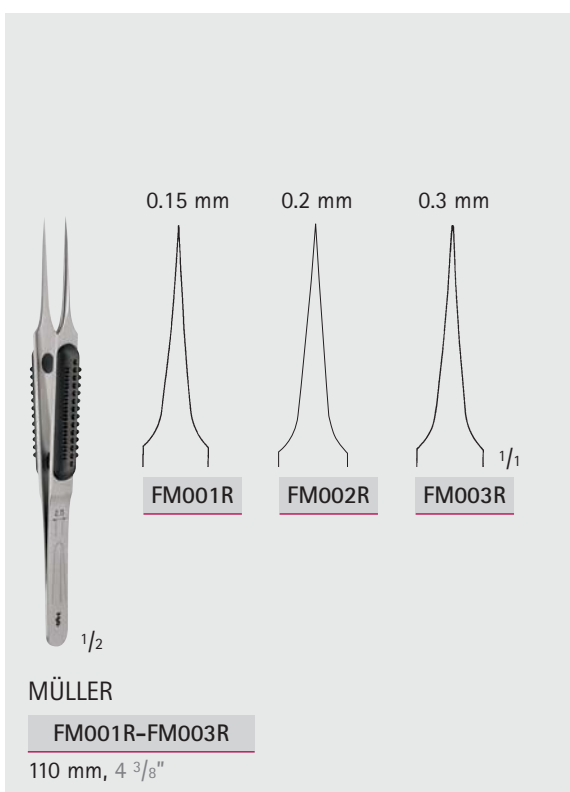

BD



MILLIMETERS

Dissecting and Tissue Forceps – Pinzas de disección y pinzas quirúrgicas

Micro Forceps with Lightweight Plastic Handle

Micropinzas con mangos de plástico ligero

BD



0.3 mm



FM033R

0.4 mm



FM036R

with plateau
con
plataforma

1/2

MÜLLER

FM033R-FM036R

160 mm, 6 1/4"



0.5 mm



1/1

1 x 2 teeth

1 x 2 dientes

1/2

MÜLLER

FM034R

160 mm, 6 1/4"



1/1

Diam. of ring:

1.2 mm

Ø de anillo:

1,2 mm

1/2

MÜLLER

FM035R

160 mm, 6 1/4"



Dissecting and Tissue Forceps – Pinzas de disección y pinzas quirúrgicas

Micro Suture Tying Forceps with Round Handle

Micropinzas para anudar suturas con mangos redondas



... with round handles

- Round handles allow turning manipulations between the fingers.
- Optimum balance individually for each instrument due to solid or hollowed-out handles.

... con mangos redondos

- Los mangos redondos permiten movimientos giratorios entre los dedos.
- Óptimo equilibrio individual para cada instrumento, ya sea por medio de mangos sólidos o huecos.

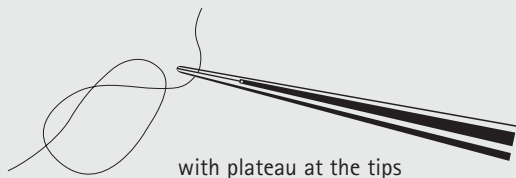

with plateau at the tips
con plataforma en las puntas

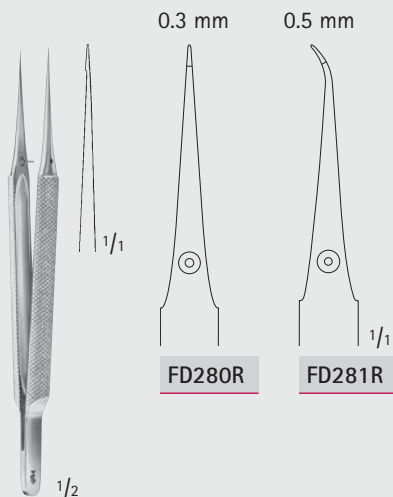

FD280R-FD281R

120 mm, 4 3/4"

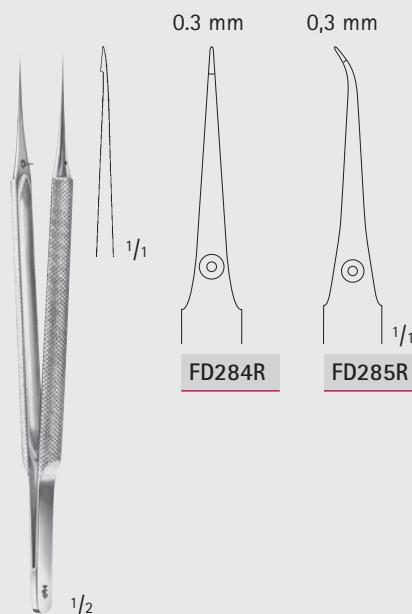

FD284R-FD285R

150 mm, 6"

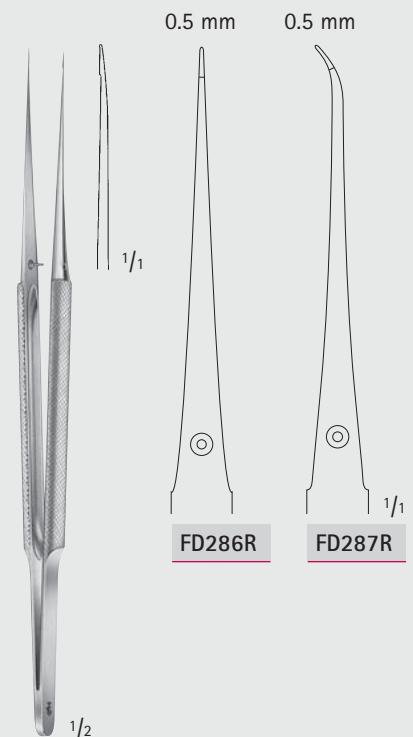

FD286R-FD287R

180 mm, 7"

BD

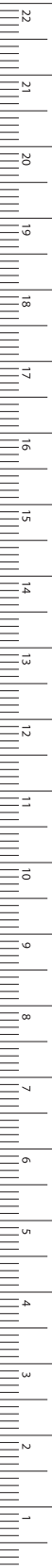

MILLIMETERS

Dissecting and Tissue Forceps - Pinzas de disección y pinzas quirúrgicas

Micro Forceps with Round Handles and Counter Balance

Micropinzas con mangos redondos y contrapeso

BD



150 mm, 6" $\frac{1}{1}$

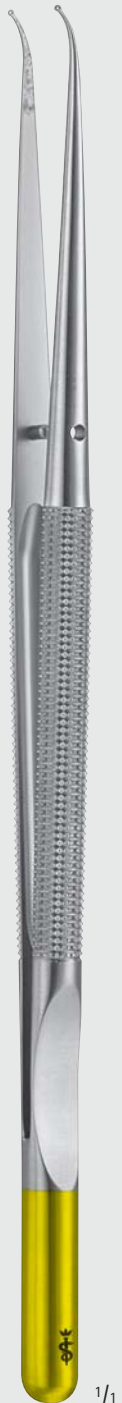

185 mm, 7 $\frac{1}{4}$ " $\frac{1}{1}$



210 mm, 8 $\frac{1}{4}$ " $\frac{1}{1}$



230 mm, 9" $\frac{1}{1}$



250 mm, 10" $\frac{1}{1}$



Dissecting and Tissue Forceps – Pinzas de disección y pinzas quirúrgicas

Micro Forceps with Round Handles and Counter Balance Micropinzas con mangos redondos y contrapeso

BD



MILLIMETERS



The diamond dust coating ensures an even harder and more wear resistant surface on the inside of the jaws. Moreover, the structure of the DIA DUST® coating guarantees a reliable grip for fine needles and sutures, as well as for tissue.

El recubrimiento de polvo de diamante asegura una superficie interior de la boca todavía más dura y más resistente al desgaste. La estructura del recubrimiento DIA DUST® además garantiza un agarre seguro de agujas finas y material de sutura así como tejido blando.

| Jaw Forma de boca | diam. of ring: 1 mm, straight Ø del anillo: 1 mm, recta | diam. of ring: 1 mm, curved Ø del anillo: 1 mm, curvada | diam. of ring: 2 mm, straight Ø del anillo: 2 mm, recta | Platform tips, straight punta de plataforma, recta | Platform tips, curved punta de plataforma, curvada | 1 mm, DeBakey tip 1 mm, dentado De Bakey |
|----------------------|--|--|--|---|---|---|
| Length Longitud | | | | | | |
| 150 mm 6" | FM570R | FM571R | | FM578R | FM581R | |
| 185 mm 7 1/4" | FM572R | FM573R | FM579R | FM580R | FM583R | FM592R |
| 210 mm 8 1/4" | FM574R | FM575R | | FM599R | FM585R | FM600R |
| 230 mm 9" | FM576R | FM577R | | | | |
| 250 mm 10" | FM596R | FM595R | | FM594R | FM593R | |

Dissecting and Tissue Forceps - Pinzas de disección y pinzas quirúrgicas

Micro Forceps with Round Handles and Counter Balance

Micropinzas con mangos redondos y contrapeso

BD



185 mm, 7 1/4" 1/1

210 mm, 8 1/4" 1/1



Dissecting and Tissue Forceps – Pinzas de disección y pinzas quirúrgicas

Micro Forceps with Round Handles, without Counter Balance Micropinzas con mangos redondos, sin contrapeso

BD





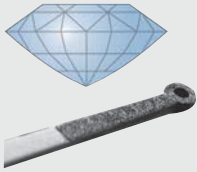

MILLIMETERS

DIA DUST®



The diamond dust coating ensures an even harder and more wear resistant surface on the inside of the jaws. Moreover, the structure of the DIA DUST® coating guarantees a reliable grip for fine needles and sutures, as well as for tissue.

El recubrimiento de polvo de diamante asegura una superficie interior de la boca todavía más dura y más resistente al desgaste. La estructura del recubrimiento DIA DUST® además garantiza un agarre seguro de agujas finas y material de sutura así como tejido blando.

| Jaw Forma de boca | diam. of ring: 1 mm, straight Ø del anillo: 1 mm, recta | diam. of ring: 1 mm, curved Ø del anillo: 1 mm, curvada | diam. of ring: 1 mm, platform tip Ø del anillo: 1 mm, punta de plataforma | Platform tip, straight punta de plataforma, recta | 1 mm, DeBakey tip 1 mm, dentado De Bakey |
|----------------------|--|--|--|--|--|
| Length Longitud |  |  |  |  |  |
| 185 mm 7 1/4" | FM597R | FM587R | FM582R | FM586R | FM590R |
| 210 mm 8 1/4" | FM598R | FM589R | FM584R | FM588R | FM591R |

Dissecting and Tissue Forceps - Pinzas de disección y pinzas quirúrgicas

Micro Forceps with Flat Handle

Micropinzas con mangos redondos

BD



180 mm, 7" $\frac{1}{1}$



200 mm, 8" $\frac{1}{1}$



250 mm, 10" $\frac{1}{1}$



Dissecting and Tissue Forceps – Pinzas de disección y pinzas quirúrgicas

Micro Forceps with Flat Handle Micropinzas con mangos redondos

BD

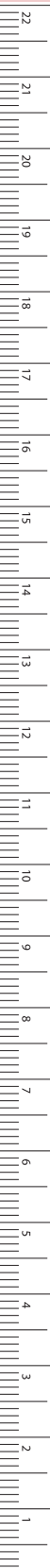





MILLIMETERS



DIA DUST®

The diamond dust coating ensures an even harder and more wear resistant surface on the inside of the jaws. Moreover, the structure of the DIA DUST® coating guarantees a reliable grip for fine needles and sutures, as well as for tissue.

El recubrimiento de polvo de diamante asegura una superficie interior de la boca todavía más dura y más resistente al desgaste. La estructura del recubrimiento DIA DUST® además garantiza un agarre seguro de agujas finas y material de sutura así como tejido blando.

| Jaw Forma de boca | 1 mm, cross serrated | 1 mm, DeBakey tip | diam. of ring: 1 mm, straight | diam. of ring: 1 mm, curved | 1 mm, straight |
|----------------------|--|--|--|--|--|
| | 1 mm, estrias cruzadas | 1 mm, dentado De Bakey | Ø del anillo: 1 mm, recta | Ø del anillo: 1 mm, curvada | 1 mm, recta |
| |  |  |  |  |  |
| Length Longitud | | | | | 1/1 |
| 180 mm 7" | BD190R | BD191R | BD192R | BD193R | BD194R |
| 200 mm 8" | | BD195R | | | BD196R |
| 250 mm 10" | BD197R | | | | |

Dissecting and Tissue Forceps – Pinzas de disección y pinzas quirúrgicas

Micro Forceps

Micropinzas

BD



cross serrated
estrias cruzadas

1/2

FM063R
Round handle
Mango redondo
200 mm, 8"



FM053R
diam. of ring: 2.5 mm
Ø del anillo: 2,5 mm
180 mm
7"



FM054R
diam. of ring: 2.5 mm
Ø del anillo: 2,5 mm
200 mm
8"

FM053R-FM054R
Round handle
Mango redondo



1/1
with plateau
con plataforma

1/2

FD253R
Round handle
Mango redondo
180 mm, 7"



Dissecting and Tissue Forceps – Pinzas de disección y pinzas quirúrgicas

Delicate Dissecting Forceps

Pinzas de disección, finas

BD

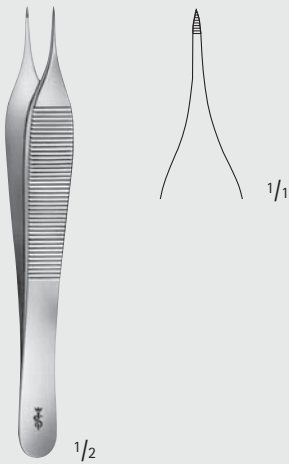

THORPE

OC069R

Corneal forceps

Pinza para córnea

120 mm, 4 3/4"

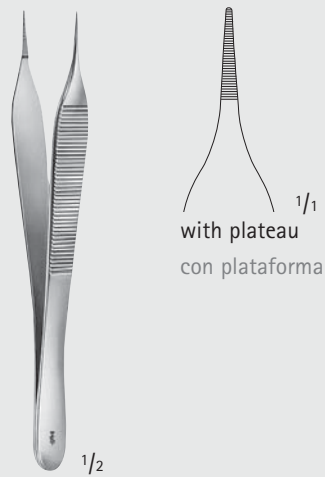

MICRO-ADSON

BD220R

120 mm, 4 3/4"

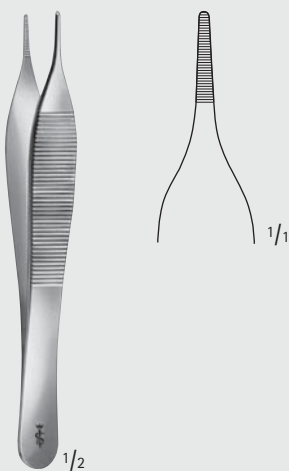

ADSON

BD222R

120 mm, 4 3/4"



HUDSON

BD225R

125 mm, 5"



MILLIMETERS

Dissecting and Tissue Forceps – Pinzas de disección y pinzas quirúrgicas

Delicate Dissecting Forceps

Pinzas de disección, finas

BD

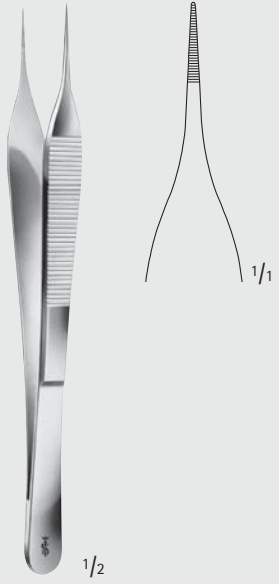

MICRO-ADSON

BD223R

150 mm, 6"

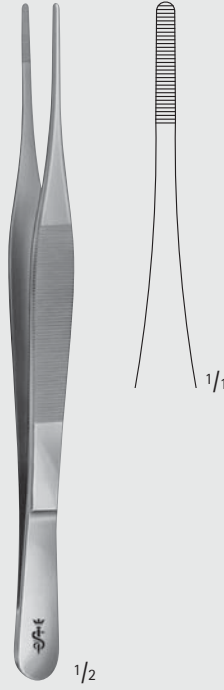

ADSON

BD224R

180 mm, 7"

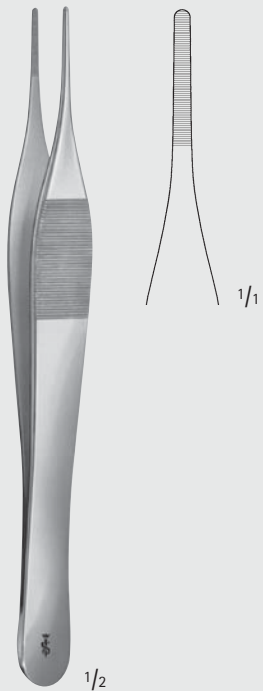

JEFFERSON

BD226R

180 mm, 7"

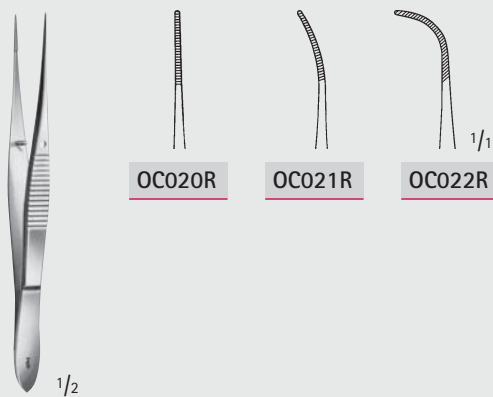

OC020R-OC022R

100 mm, 4"



Dissecting and Tissue Forceps – Pinzas de disección y pinzas quirúrgicas

Delicate Dissecting Forceps

Pinzas de disección, finas

BD

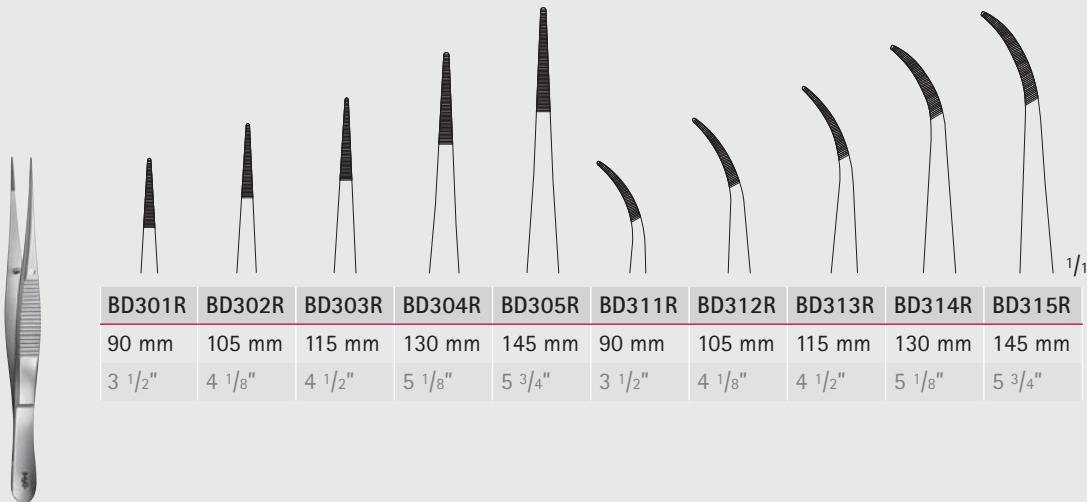

| BD301R | BD302R | BD303R | BD304R | BD305R | BD311R | BD312R | BD313R | BD314R | BD315R |
|--------|--------|--------|--------|--------|--------|--------|--------|--------|--------|
| 90 mm | 105 mm | 115 mm | 130 mm | 145 mm | 90 mm | 105 mm | 115 mm | 130 mm | 145 mm |
| 3 1/2" | 4 1/8" | 4 1/2" | 5 1/8" | 5 3/4" | 3 1/2" | 4 1/8" | 4 1/2" | 5 1/8" | 5 3/4" |

BD301R-BD315R

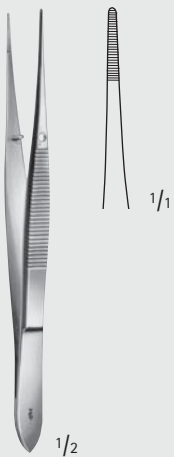

1/2

BD210R

115 mm, 4 1/2"



1/2

BD320R

100 mm, 4"

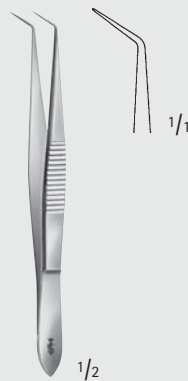

1/2

BD321R

100 mm, 4"

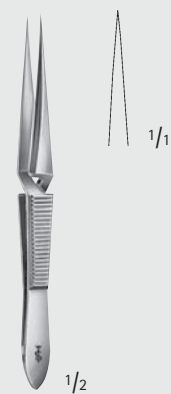

1/2

BD322R

100 mm, 4"



MILLIMETERS

Dissecting and Tissue Forceps - Pinzas de disección y pinzas quirúrgicas

Delicate Dissecting Forceps

Pinzas de disección, finas

BD

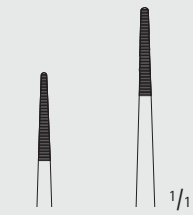

| BD215R | BD216R |
|--------|--------|
| 125 mm | 150 mm |
| 5" | 6" |

SEMKEN

BD215R-BD216R



1/2 155 mm, 6"

BD217R



1/2 150 mm, 6"

GILLIES

BD213R



1/2

MC INDOE

BD236R

150 mm, 6"

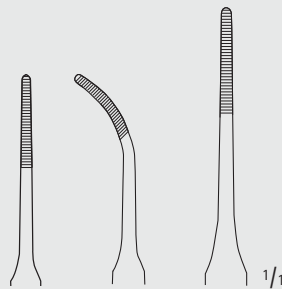

| BD228R | BD229R | BD230R |
|--------|--------|--------|
| 175 mm | 175 mm | 230 mm |
| 7" | 7" | 9" |

GERALD

BD228R-BD230R

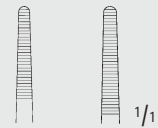

| BD268R | BD269R |
|--------|--------|
| 175 mm | 215 mm |
| 7" | 8 1/2" |

CAIRNS-DOTT

BD268R-BD269R



Dissecting and Tissue Forceps – Pinzas de disección y pinzas quirúrgicas

Delicate Dissecting Forceps

Pinzas de disección, finas

BD

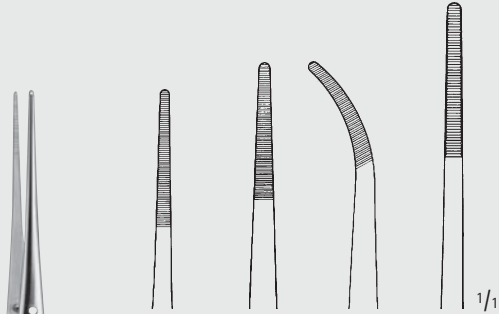

| BD238R | BD239R | BD243R | BD240R |
|--------|--------|--------|--------|
| 180 mm | 200 mm | 200 mm | 250 mm |
| 7" | 8" | 8" | 10" |

CUSHING

BD238R-BD243R

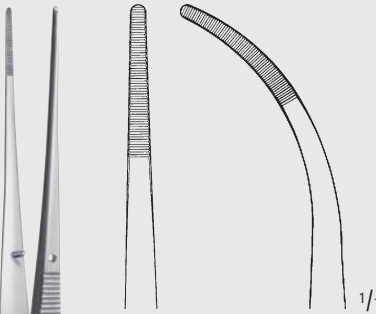

BD246R

BD247R

BROPHY

BD246R-BD247R

1/2 200 mm, 8"

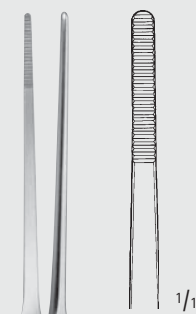

1/1

BD081R

1/2 200 mm, 8"

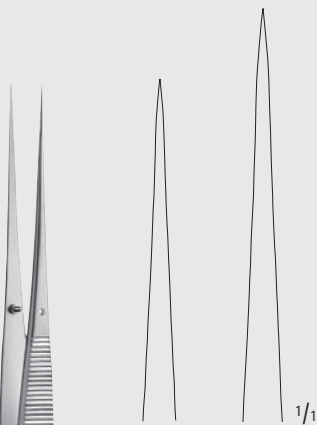

| BD231R | BD232R |
|--------|--------|
| 180 mm | 200 mm |
| 7" | 8" |

BD231R-BD232R

smooth jaws
boca lisa



1/1

COOLEY

BD250R

200 mm, 8"

1/2



1/1

BD257R

200 mm, 8"

1/2

Dissecting and Tissue Forceps - Pinzas de disección y pinzas quirúrgicas

Dissecting Forceps

Pinzas de disección

BD

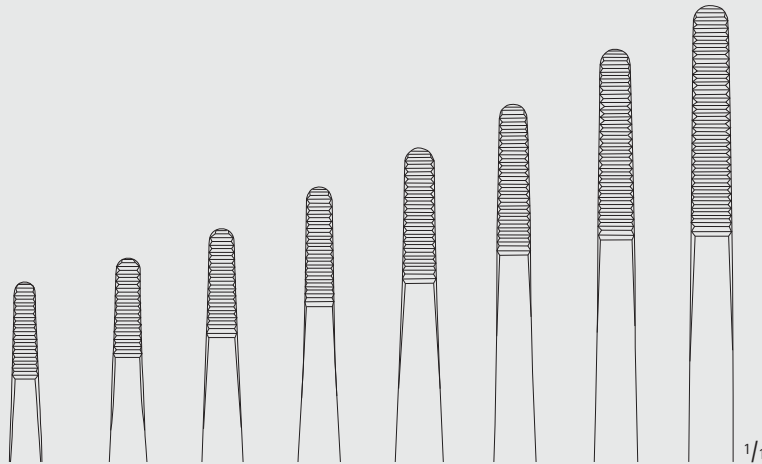

| BD043R | BD045R | BD047R | BD049R | BD050R | BD051R | BD052R | BD053R |
|--------|--------|--------|--------|--------|--------|--------|--------|
| 115 mm | 130 mm | 145 mm | 160 mm | 180 mm | 200 mm | 250 mm | 300 mm |
| 4 1/2" | 5 1/8" | 5 3/4" | 6 1/4" | 7" | 8" | 10" | 12" |

BD043R-BD053R

Standard patterns

Modelos estándar

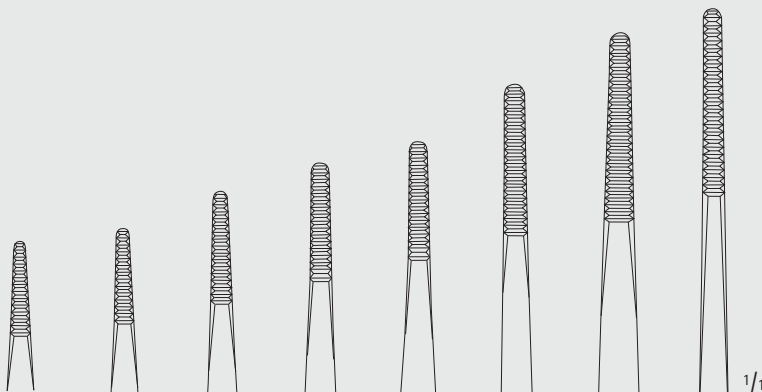

| BD023R | BD025R | BD027R | BD029R | BD030R | BD031R | BD032R | BD033R |
|--------|--------|--------|--------|--------|--------|--------|--------|
| 115 mm | 130 mm | 145 mm | 160 mm | 180 mm | 200 mm | 250 mm | 305 mm |
| 4 1/2" | 5 1/8" | 5 3/4" | 6 1/4" | 7" | 8" | 10" | 12" |

BD023R-BD033R

medium

mediana

INCHES



Dissecting and Tissue Forceps – Pinzas de disección y pinzas quirúrgicas

Dissecting Forceps
Pinzas de disección

BD

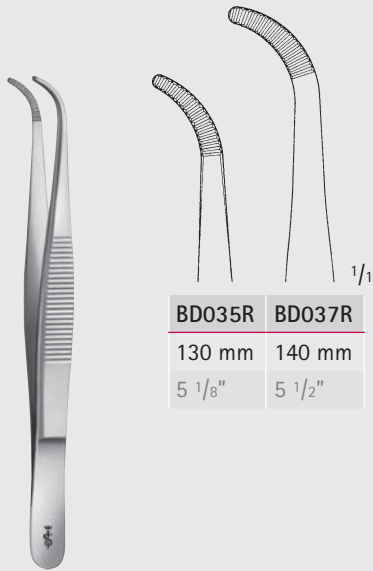

| BD035R | BD037R |
|--------|--------|
| 130 mm | 140 mm |
| 5 1/8" | 5 1/2" |

BD035R-BD037R

medium
mediana

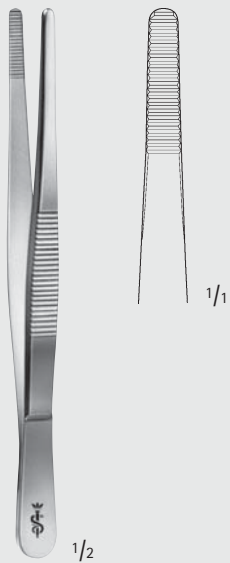

BD077R

extra large
extra grande
145 mm, 5 3/4"

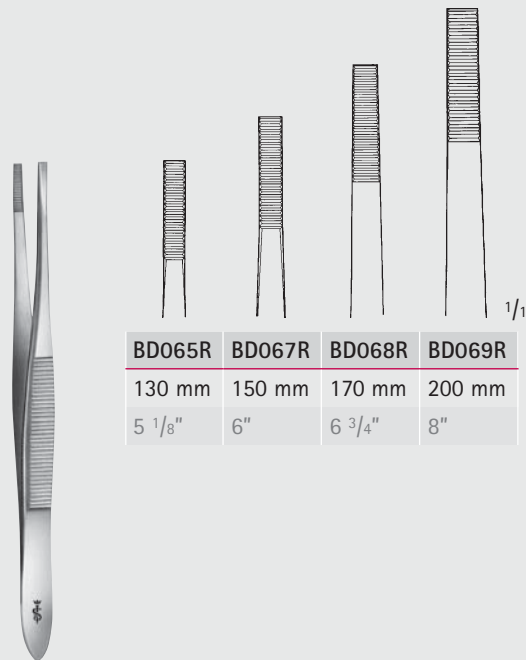

| BD065R | BD067R | BD068R | BD069R |
|--------|--------|--------|--------|
| 130 mm | 150 mm | 170 mm | 200 mm |
| 5 1/8" | 6" | 6 3/4" | 8" |

SCHWEDISCHES MODELL

BD065R-BD069R



MILLIMETERS

Dissecting and Tissue Forceps – Pinzas de disección y pinzas quirúrgicas

Dissecting Forceps

Pinzas de disección

BD

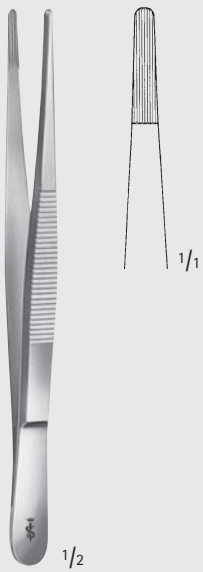
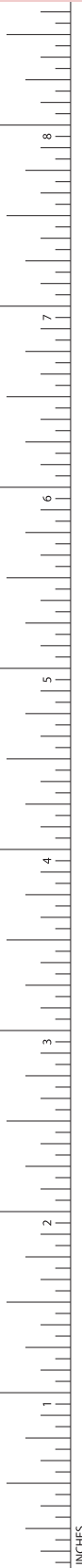

OCHSNER

BD130R

Ligature forceps

Pinzas para ligadura

145 mm, 5 3/4"



BONNEY

BD078R

175 mm, 7"

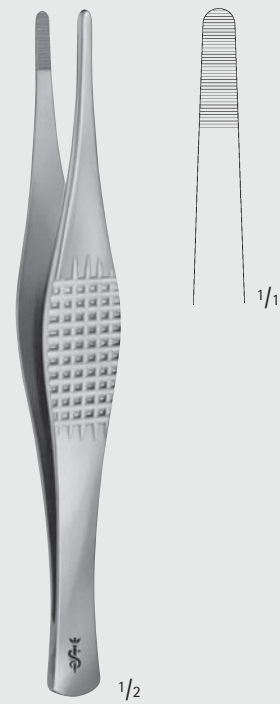

RAMSEY

BD083R

180 mm, 7"



Toothings DE BAKEY



Dentado DE BAKEY

Dissecting and Tissue Forceps – Pinzas de disección y pinzas quirúrgicas

AIRAUMATA®

Ultra-Light-Forceps

Pinzas ultraligeras

BD

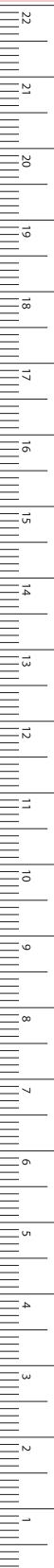
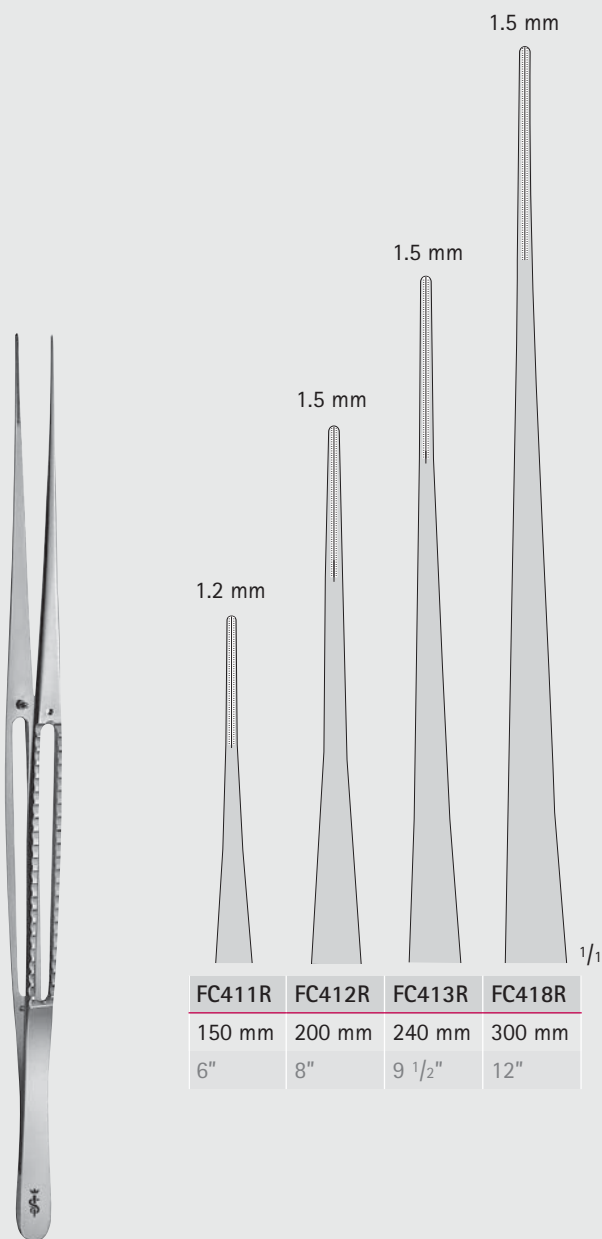

MILLIMETERS

DE BAKEY

FC411R-FC418R

Dissecting and Tissue Forceps - Pinzas de disección y pinzas quirúrgicas

Forceps
Pinzas

Toothing DE BAKEY



Dentado DE BAKEY

ARAUMATA[®]

BD

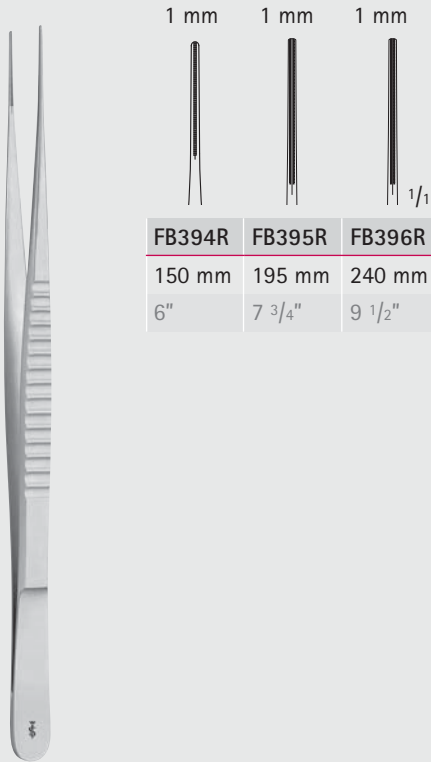

| FB394R | FB395R | FB396R |
|--------|--------|--------|
| 150 mm | 195 mm | 240 mm |
| 6" | 7 3/4" | 9 1/2" |

DE BAKEY

FB394R-FB396R

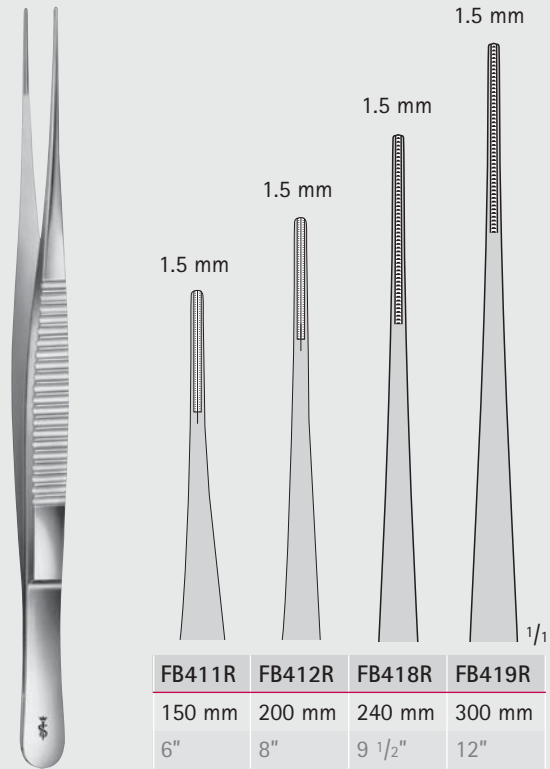

| FB411R | FB412R | FB418R | FB419R |
|--------|--------|--------|--------|
| 150 mm | 200 mm | 240 mm | 300 mm |
| 6" | 8" | 9 1/2" | 12" |

DE BAKEY

FB411R-FB419R

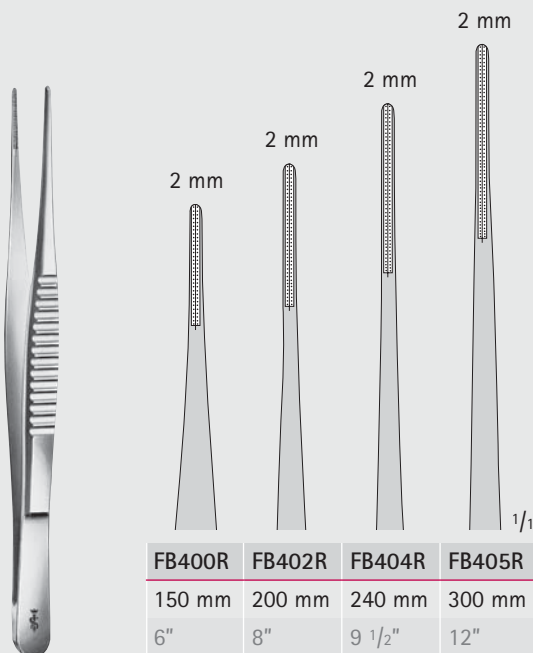

| FB400R | FB402R | FB404R | FB405R |
|--------|--------|--------|--------|
| 150 mm | 200 mm | 240 mm | 300 mm |
| 6" | 8" | 9 1/2" | 12" |

DE BAKEY

FB400R-FB405R

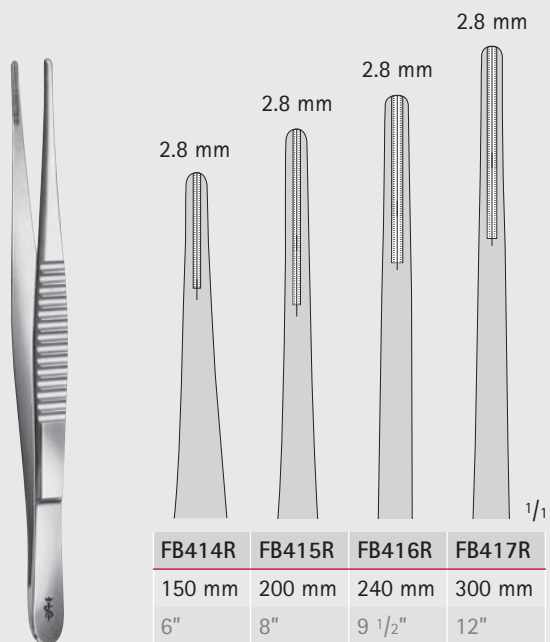

| FB414R | FB415R | FB416R | FB417R |
|--------|--------|--------|--------|
| 150 mm | 200 mm | 240 mm | 300 mm |
| 6" | 8" | 9 1/2" | 12" |

DE BAKEY

FB414R-FB417R



Toothings DE BAKEY

Dentado DE BAKEY

Dissecting and Tissue Forceps - Pinzas de disección y pinzas quirúrgicas

AIRAUMATA®

Forceps
Pinzas

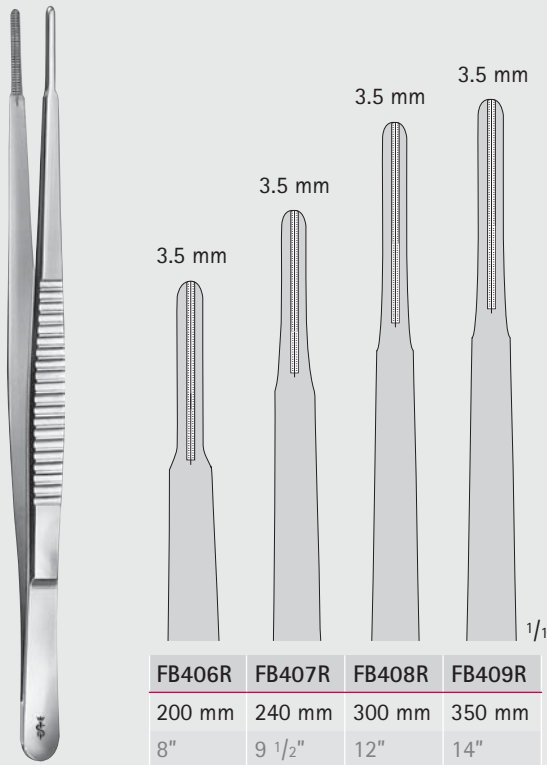

DE BAKY

FB406R-FB409R

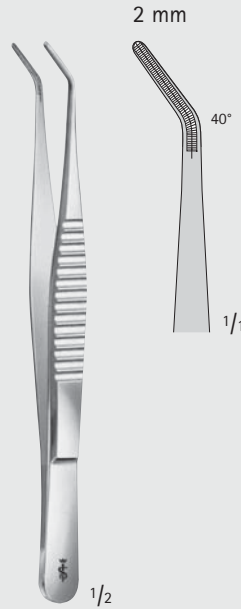

DE BAKY

FB401R

150 mm, 6"

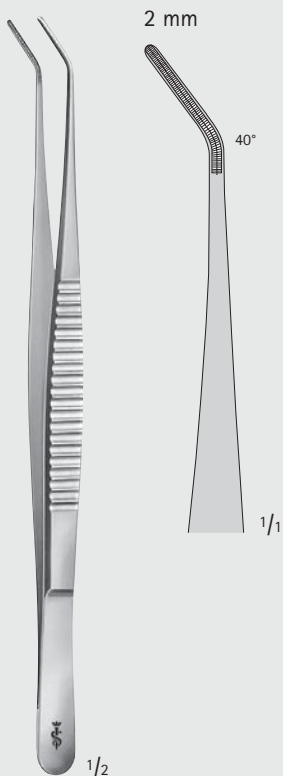

DE BAKY

FB403R

200 mm, 8"



DE BAKY

FB410R

240 mm, 9 1/2"

Toothings COOLEY



Dentado COOLEY

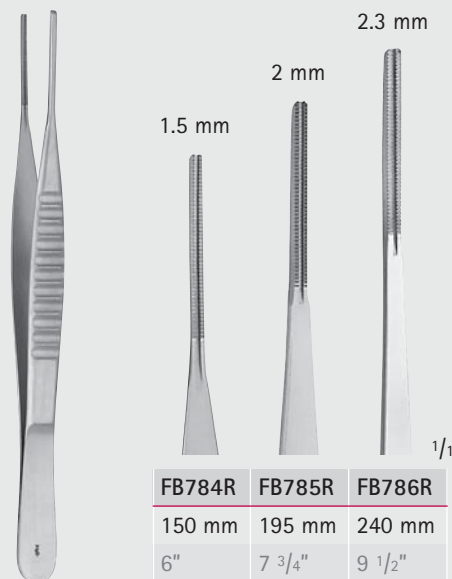

COOLEY

FB784R-FB786R

BD



MILLIMETERS

Dissecting and Tissue Forceps – Pinzas de disección y pinzas quirúrgicas

DUROGRIP® Non-traumatic Dissecting Forceps

Pinzas de disección atraumáticas DUROGRIP®

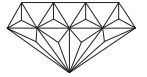

BD

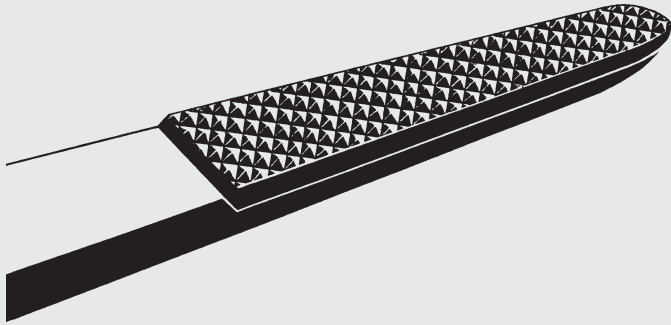

- Precisely worked out fine structure of carbide inserts
- thus firm and non-traumatic gripping of tissue
- universal in use – long working life
- Las finas estructuras de las placas de metal extraduro son elaboradas con suma precisión
- agarre de tejido firme y atraumático
- uso universal – larga vida útil



DUROGRIP® Dissecting forceps with carbide inserts
Identification: gold-plated end

Pinzas de disección DUROGRIP® con placas de metal extraduro. Identificación: Extremo dorado



ADSON
BD151R
120 mm, 4 3/4"

| | |
|---------------|---------------|
| BD154R | BD156R |
| 145 mm | 180 mm |
| 5 3/4" | 7" |

BD154R-BD156R

| | |
|---------------|---------------|
| BD157R | BD159R |
| 200 mm | 250 mm |
| 8" | 10" |

BD157R-BD159R

BD158R
230 mm, 9"

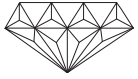

Dissecting and Tissue Forceps – Pinzas de disección y pinzas quirúrgicas

DUROGRIP® Dissecting Forceps
Pinzas de disección DUROGRIP®

BD

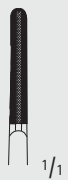

Cushion shaped tip ensures a safe and gentle grasping of the thread

Bocas en forma de cojín para un agarre seguro y delicado del hilo.

1/2

BD180R

Suture forceps
Pinza para suturas
200 mm, 8"

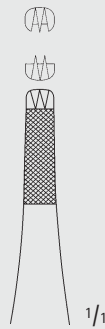

1/2

FERRIS-SMITH

BD181R

175 mm, 7"

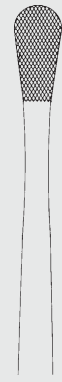

1/1

| BD171R | BD173R |
|--------|--------|
| 150 mm | 230 mm |
| 6" | 9" |

WANGENSTEEN

BD171R-BD173R

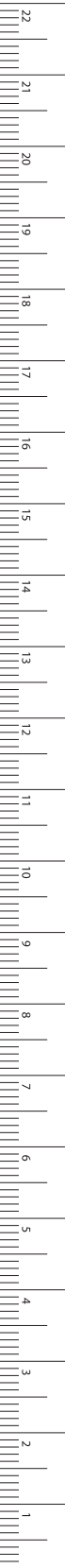

MILLIMETERS

Dissecting and Tissue Forceps – Pinzas de disección y pinzas quirúrgicas

DUROGRIP® Dissecting Forceps
Pinzas de disección DUROGRIP®

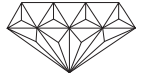

BD



| | | |
|---------------|---------------|---------------|
| BD164R | BD165R | BD166R |
| 145 mm | 200 mm | 250 mm |
| 5 3/4" | 8" | 10" |

| | |
|---------------|---------------|
| BD160R | BD198R |
| 180 mm | 250 mm |
| 7" | 10" |

| |
|----------------|
| BD168R |
| 185 mm, 7 1/4" |

STANDARD
BD164R–BD166R

CUSHING
BD160R–BD198R
with scraper end
con raspador en el extremo

GRUENWALD
BD168R
185 mm, 7 1/4"



Dissecting and Tissue Forceps – Pinzas de disección y pinzas quirúrgicas

Forceps, Bayonet-Shaped Pinzas, en forma de bayoneta

BD

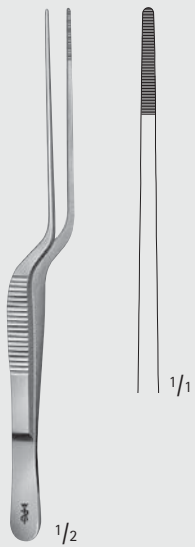

LUCAE

BD878R

140 mm, 5 1/2"

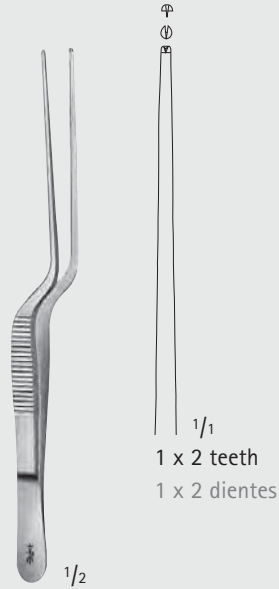

LUCAE

BD879R

140 mm, 5 1/2"



COTTLE

OL011R

Fixation forceps
Pinza de fijación
140 mm, 5 1/2"

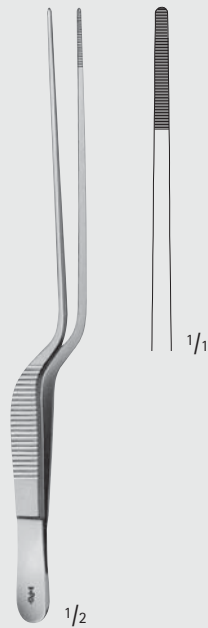

JANSEN

BD880R

160 mm, 6 1/4"

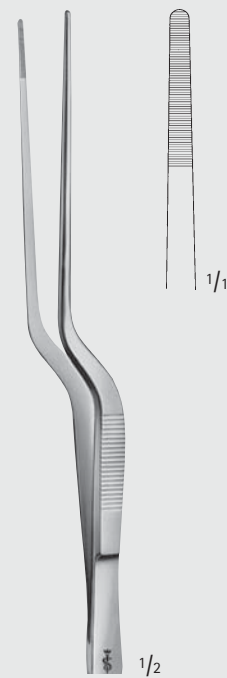

ADSON

BD870R

180 mm, 7"



Dissecting and Tissue Forceps – Pinzas de disección y pinzas quirúrgicas

Forceps, Bayonet-Shaped

Pinzas, en forma de bayoneta

BD

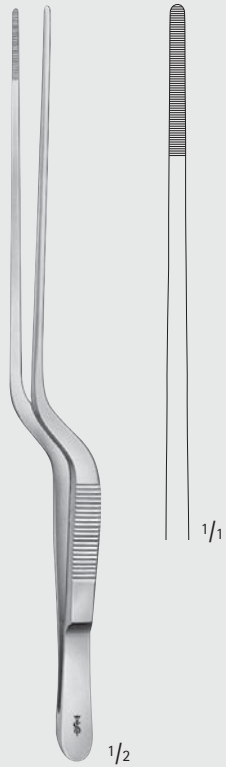

GRUENWALD

BD883R

200 mm, 8"

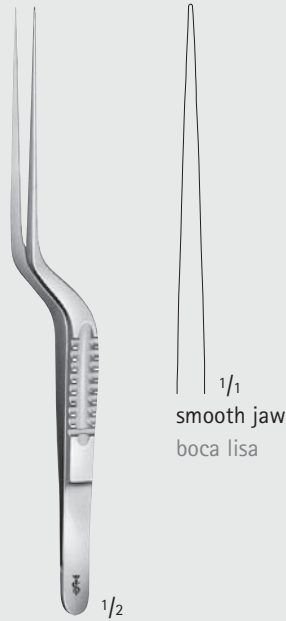

smooth jaw
boca lisa

BD887R

160 mm, 6 1/4"

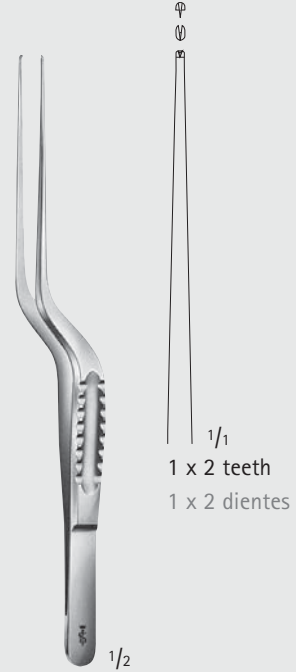

1 x 2 teeth
1 x 2 dientes

BD888R

160 mm, 6 1/4"



smooth jaw
boca lisa

BD885R

185 mm, 7 1/4"

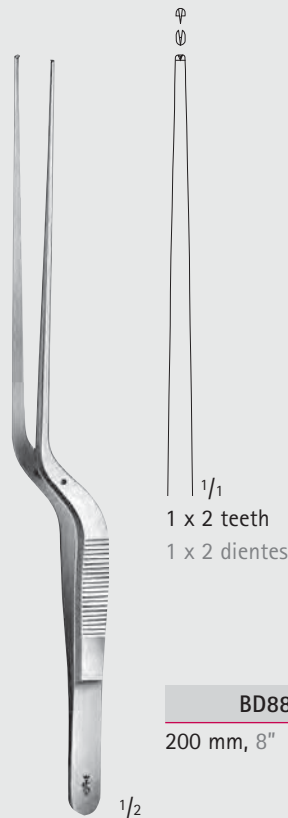

1 x 2 teeth
1 x 2 dientes

BD886R

200 mm, 8"



Dissecting and Tissue Forceps – Pinzas de disección y pinzas quirúrgicas

Forceps, Angular
Pinzas, acodadas

BD

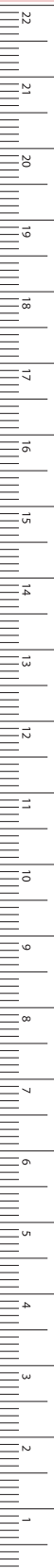

MILLIMETERS



TROELTSCH

BD900R

100 mm, 4"

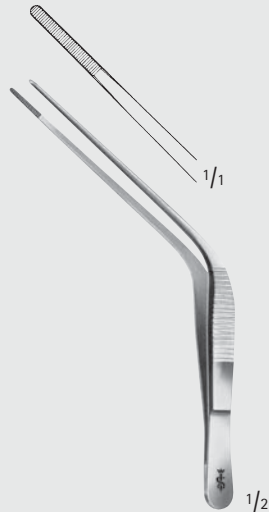

TROELTSCH

BD902R

115 mm, 4 1/2"

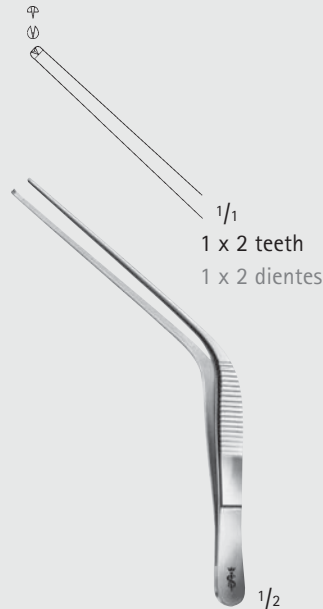

TROELTSCH

BD903R

115 mm, 4 1/2"

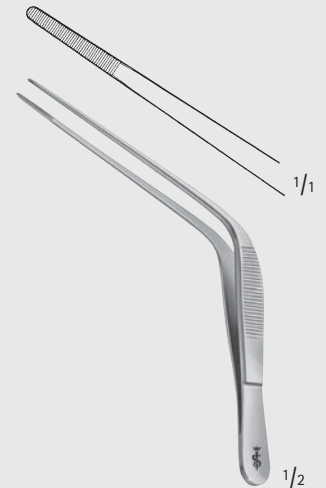

WILDE

BD904R

115 mm, 4 1/2"

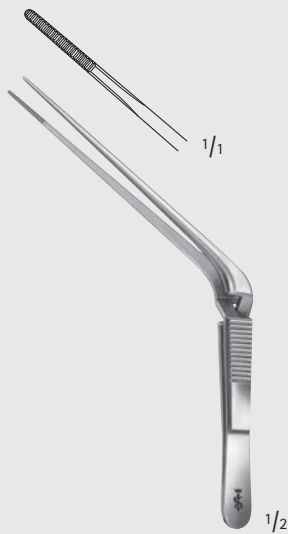

TROELTSCH

BD905R

cross action
con cierre automático
120 mm, 4 3/4"



TROELTSCH

BD910R

140 mm, 5 1/2"

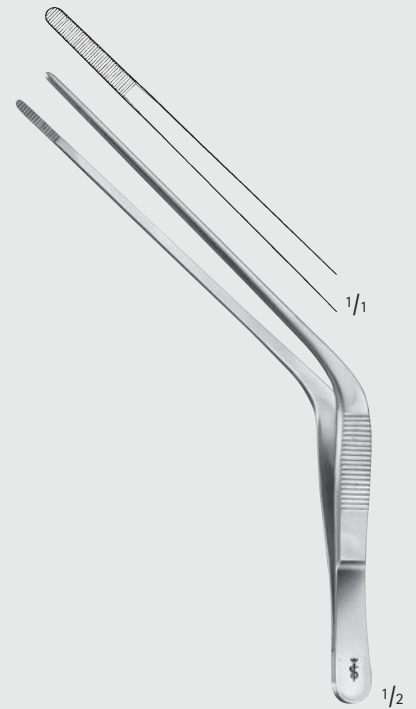

TROELTSCH

BD911R

170 mm, 6 3/4"

Dissecting and Tissue Forceps – Pinzas de disección y pinzas quirúrgicas

Delicate Tissue Forceps

Pinzas quirúrgicas, finas

BD

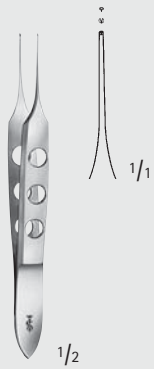

BISHOP-HARMON

OC051R

Eye forceps

Pinza ocular

85 mm, 3 1/2"



ST. MARTIN

OC091R

Eye forceps

Pinza ocular

80 mm, 3 1/8"

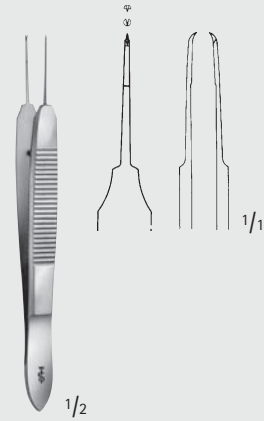

CASTROVIEJO

OC094R

Eye forceps

Pinza ocular

100 mm, 4"



MICRO-ADSON-BIEMER

BD509R

120 mm, 4 3/4"

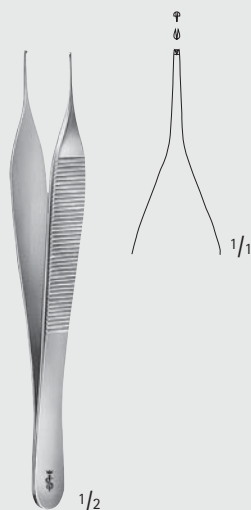

MICRO-ADSON

BD510R

120 mm, 4 3/4"

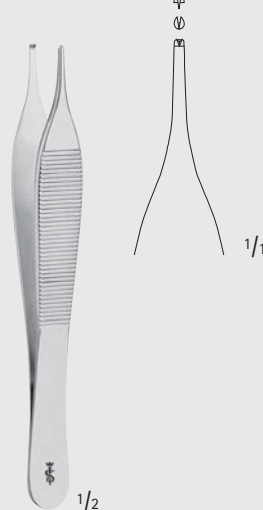

ADSON

BD511R

120 mm, 4 3/4"

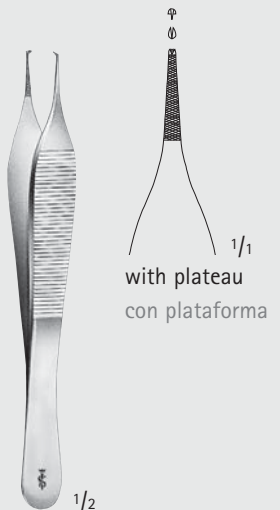

ADSON

BD512R

120 mm, 4 3/4"



Dissecting and Tissue Forceps – Pinzas de disección y pinzas quirúrgicas

Delicate Tissue Forceps
Pinzas quirúrgicas, finas

BD

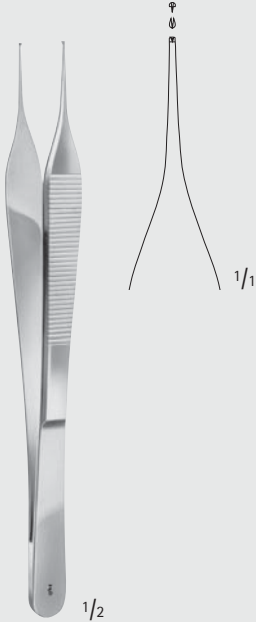
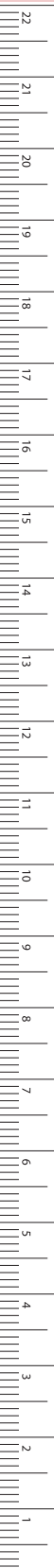

MICRO-ADSON

BD520R

150 mm, 6"



ADSON

BD522R

180 mm, 7"

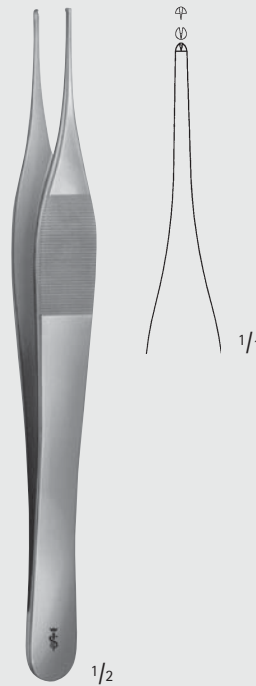

JEFFERSON

BD523R

180 mm, 7"

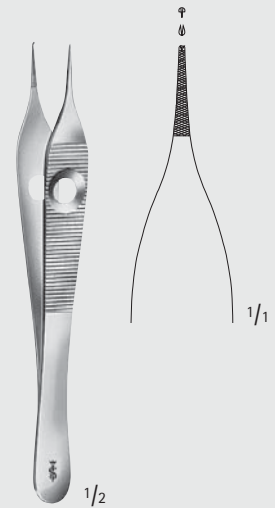

ADSON

BD508R

120 mm, 4 3/4"

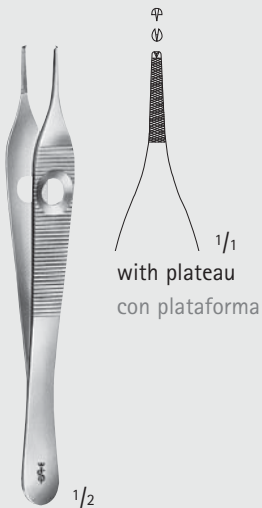

ADSON

BD513R

120 mm, 4 3/4"

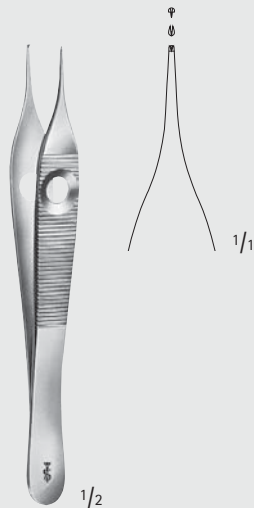

ADSON

BD506R

120 mm, 4 3/4"

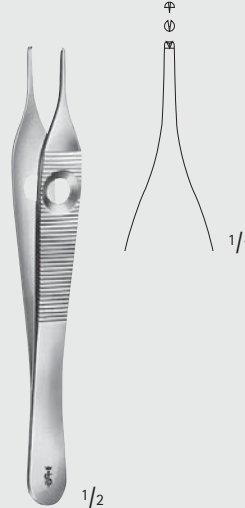

ADSON

BD507R

120 mm, 4 3/4"

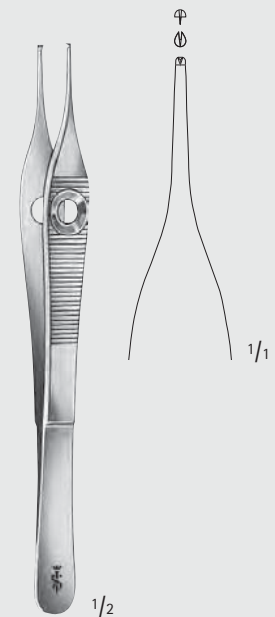

ADSON

BD521R

150 mm, 6"

Dissecting and Tissue Forceps – Pinzas de disección y pinzas quirúrgicas

Tissue Forceps

Pinzas quirúrgicas

BD

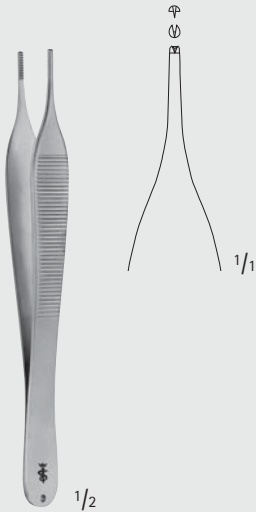

HUDSON

MB291R

125 mm, 4 7/8"



ADSON

MB454R

120 mm, 4 3/4"

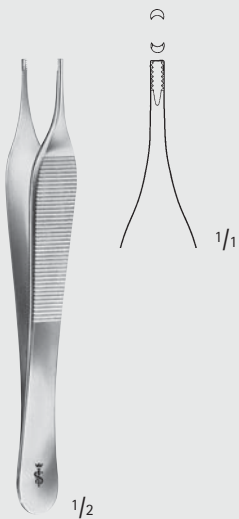

ADSON-BROWN

BD700R

Tissue forceps, sharp
Pinza quirúrgica aguda
120 mm, 4 3/4"

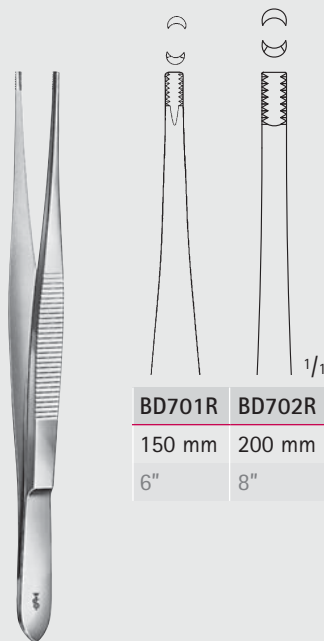

BROWN

BD701R-BD702R

| | |
|---------------|---------------|
| BD701R | BD702R |
| 150 mm | 200 mm |
| 6" | 8" |

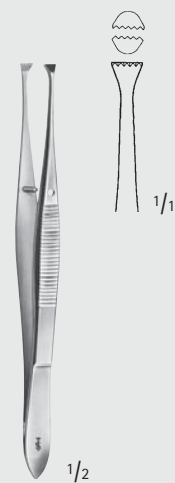

GRAEFFE

OC100R

110 mm, 4 1/2"



Dissecting and Tissue Forceps – Pinzas de disección y pinzas quirúrgicas

Delicate Tissue Forceps
Pinzas quirúrgicas, finas

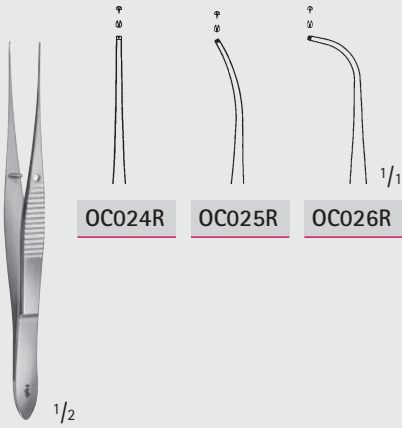

OC024R **OC025R** **OC026R**

OC024R-OC026R

very delicate
muy fina
100 mm, 4"



BD500R

100 mm, 4"



BD501R

110 mm, 4 3/8"



2 x 3 teeth
2 x 3 dientes

BD502R

110 mm, 4 3/8"



BD665R **BD666R** **BD667R**

125 mm 125 mm 150 mm

5" 5" 6"

2 x 3
teeth
2 x 3
dientes

SEMKEN

BD665R-BD667R

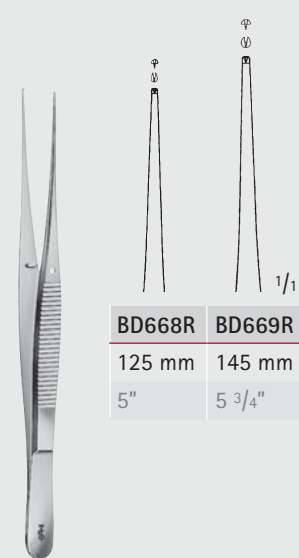

BD668R **BD669R**

125 mm 145 mm

5" 5 3/4"

SEMKEN

BD668R-BD669R

BD



MILLIMETERS

Dissecting and Tissue Forceps - Pinzas de disección y pinzas quirúrgicas

Delicate Tissue Forceps

Pinzas quirúrgicas, finas

BD



GILLIES

BD660R

155 mm, 6"



MC INDOE

BD661R

150 mm, 6"

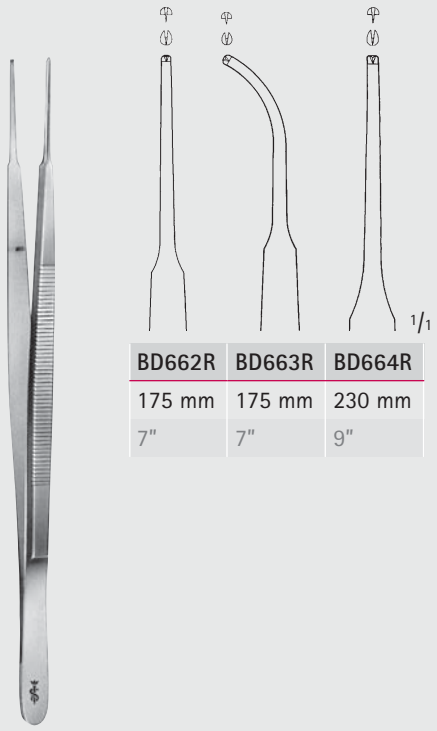

GERALD

BD662R-BD664R

| BD662R | BD663R | BD664R |
|--------|--------|--------|
| 175 mm | 175 mm | 230 mm |
| 7" | 7" | 9" |



WAUGH

BD670R-BD679R

| BD670R | BD671R | BD672R | BD679R |
|--------|--------|--------|--------|
| 180 mm | 200 mm | 250 mm | 305 mm |
| 7" | 8" | 10" | 12" |



Dissecting and Tissue Forceps – Pinzas de disección y pinzas quirúrgicas

Tissue Forceps
Pinzas quirúrgicas

BD

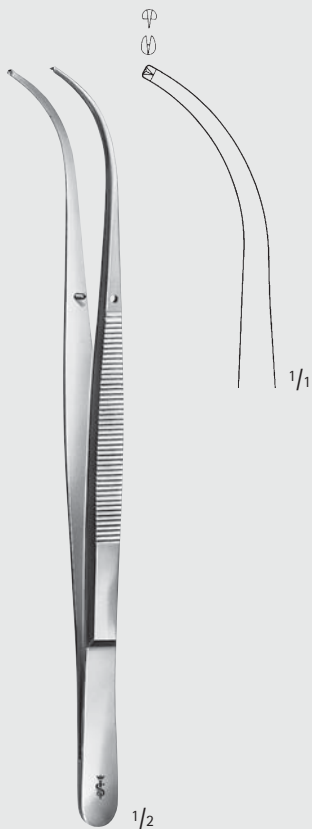

BROPHY

BD678R

200 mm, 8"



BD651R

200 mm, 8"



CUSHING

MD463

180 mm, 7"

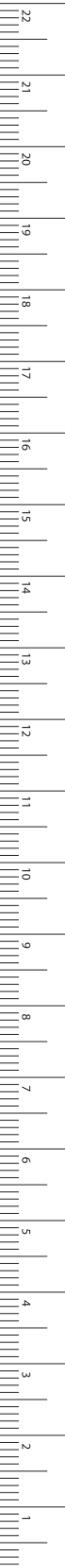

MILLIMETERS

Dissecting and Tissue Forceps - Pinzas de disección y pinzas quirúrgicas

Tissue Forceps

Pinzas quirúrgicas

BD

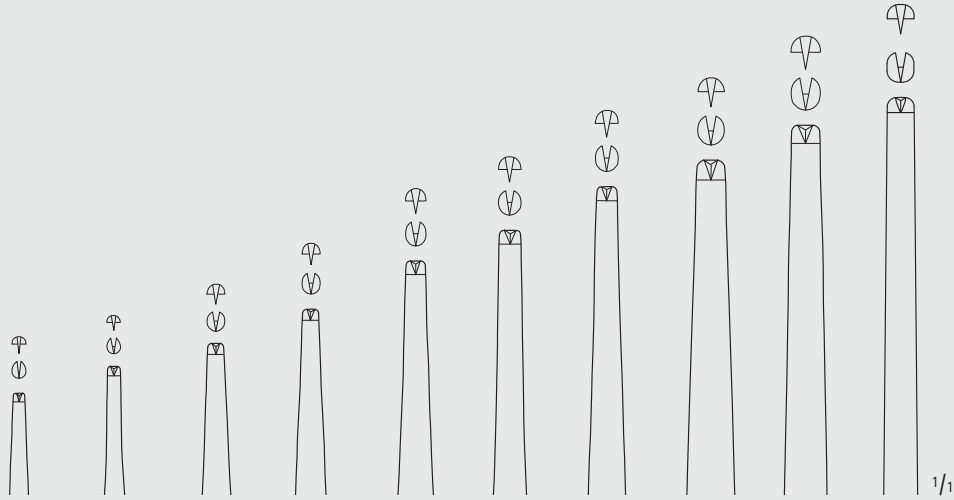

| BD552R | BD553R | BD555R | BD557R | BD559R | BD560R | BD561R | BD562R | BD563R | BD564R |
|--------|--------|--------|--------|--------|--------|--------|--------|--------|--------|
| 105 mm | 115 mm | 130 mm | 145 mm | 160 mm | 180 mm | 200 mm | 250 mm | 300 mm | 350 mm |
| 4 1/8" | 4 1/2" | 5 1/8" | 5 3/4" | 6 1/4" | 7" | 8" | 10" | 12" | 14" |

BD552R-BD564R

Standard patterns

Modelos estándar

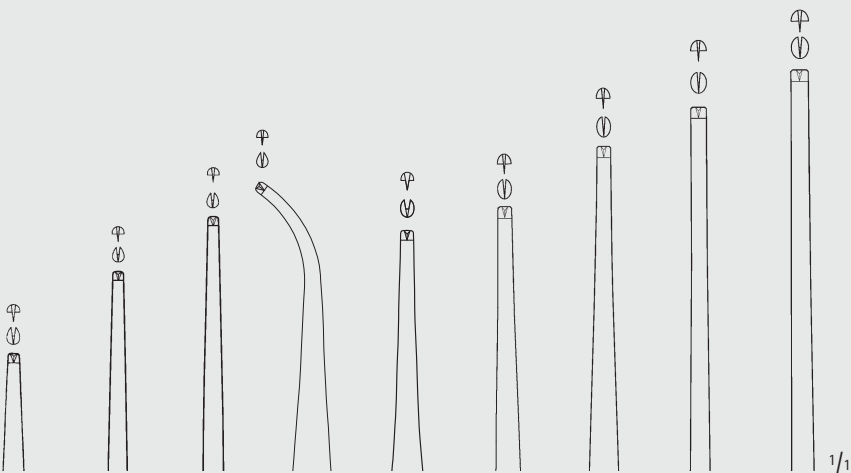

| BD533R | BD535R | BD537R | BD527R | BD539R | BD540R | BD541R | BD542R | BD543R |
|--------|--------|--------|--------|--------|--------|--------|--------|--------|
| 115 mm | 130 mm | 145 mm | 145 mm | 160 mm | 180 mm | 200 mm | 250 mm | 300 mm |
| 4 1/2" | 5 1/8" | 5 3/4" | 5 3/4" | 6 1/4" | 7" | 8" | 10" | 12" |

BD527R-BD543R

medium

medianas



Dissecting and Tissue Forceps – Pinzas de disección y pinzas quirúrgicas

Tissue Forceps
Pinzas quirúrgicas

BD

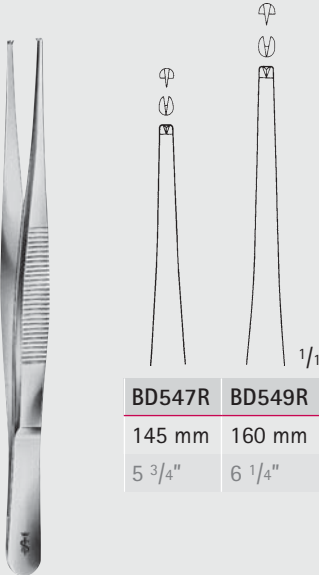

| BD547R | BD549R |
|--------|--------|
| 145 mm | 160 mm |
| 5 3/4" | 6 1/4" |

BD547R-BD549R

stronger as BD537R and BD539R
but finer than BD557R and BD559R
más fuertes que BD537R y BD539R
pero más finas que BD557R y BD559R



BD600R

Heavy Modelo
Modelo fuerte
145 mm, 5 3/4"

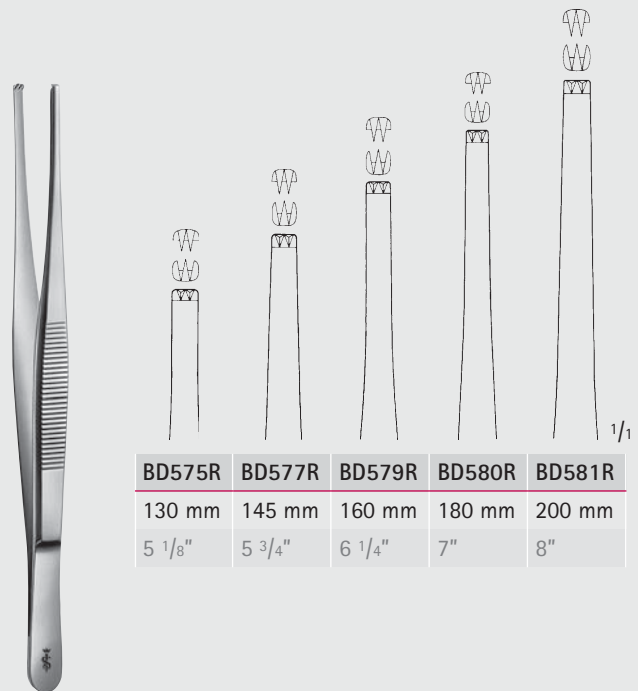

| BD575R | BD577R | BD579R | BD580R | BD581R |
|--------|--------|--------|--------|--------|
| 130 mm | 145 mm | 160 mm | 180 mm | 200 mm |
| 5 1/8" | 5 3/4" | 6 1/4" | 7" | 8" |

BD575R-BD581R

2 x 3 teeth
2 x 3 dientes



Dissecting and Tissue Forceps – Pinzas de disección y pinzas quirúrgicas

Tissue Forceps

Pinzas quirúrgicas

BD

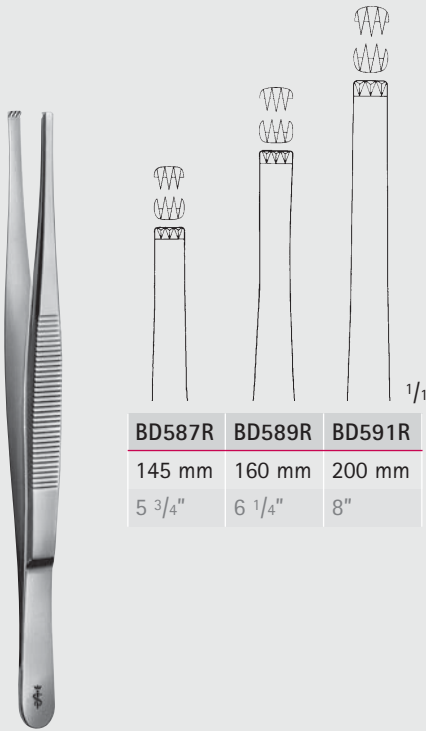

| BD587R | BD589R | BD591R |
|--------|--------|--------|
| 145 mm | 160 mm | 200 mm |
| 5 3/4" | 6 1/4" | 8" |

BD587R-BD591R

3 x 4 teeth
3 x 4 dientes

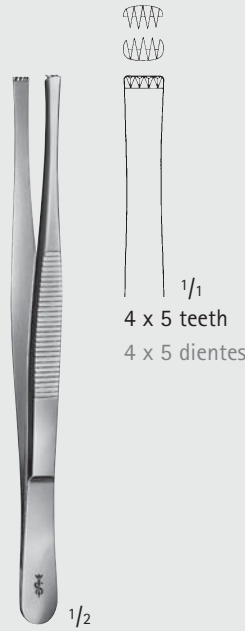

1/1
4 x 5 teeth
4 x 5 dientes

1/2

BD597R

145 mm, 5 3/4"



1/1
4 x 5 teeth
4 x 5 dientes

1/2

OFFICER

BD598R

150 mm, 6"

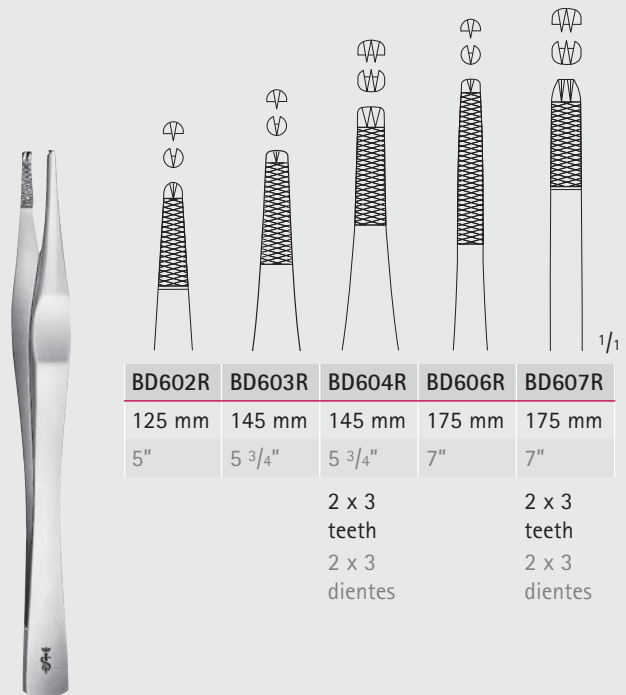

| BD602R | BD603R | BD604R | BD606R | BD607R |
|--------|--------|------------------|--------|------------------|
| 125 mm | 145 mm | 145 mm | 175 mm | 175 mm |
| 5" | 5 3/4" | 5 3/4" | 7" | 7" |
| | | 2 x 3 teeth | | 2 x 3 teeth |
| | | 2 x 3 dientes | | 2 x 3 dientes |

1/1

LANE

BD602R-BD607R



Dissecting and Tissue Forceps – Pinzas de disección y pinzas quirúrgicas

Tissue Forceps
Pinzas quirúrgicas

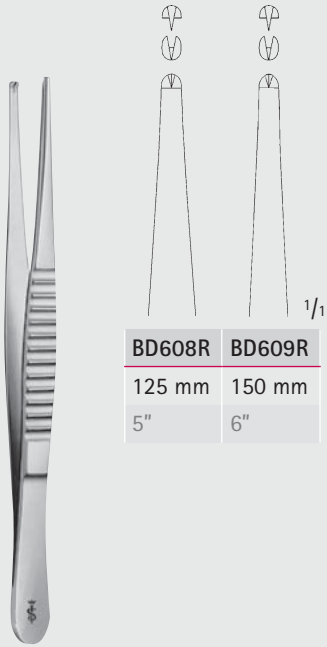

| BD608R | BD609R |
|--------|--------|
| 125 mm | 150 mm |
| 5" | 6" |

TREVES

BD608R-BD609R

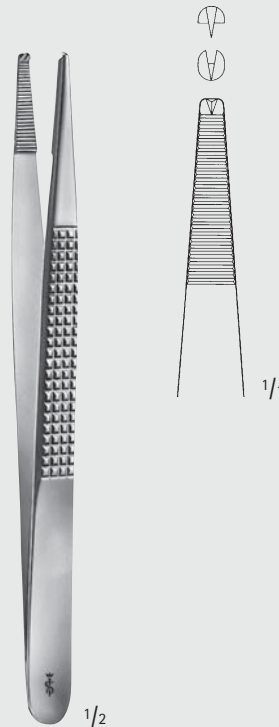

BONNEY

BD693R

175 mm, 7"

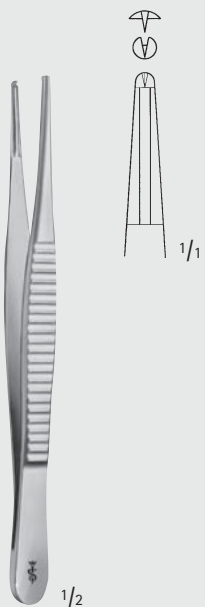

JACKSON-BURROWS

BD704R

140 mm, 5 1/2"

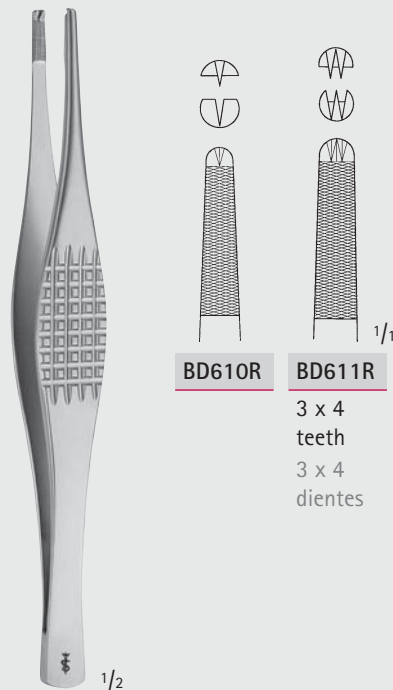

BD610R

BD611R

3 x 4
teeth
3 x 4
dientes

RAMSEY

BD610R-BD611R

180 mm, 7"

BD

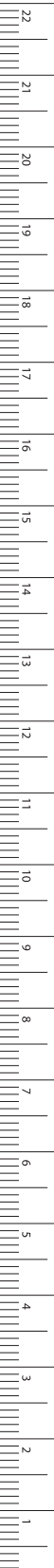

MILLIMETERS

Dissecting and Tissue Forceps – Pinzas de disección y pinzas quirúrgicas

Tissue Forceps

Pinzas quirúrgicas

BD

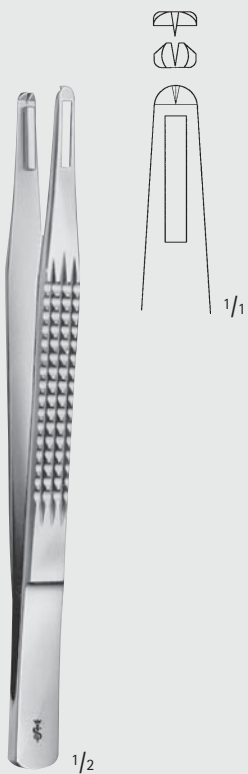

CHARNLEY

BD705R

180 mm, 7"

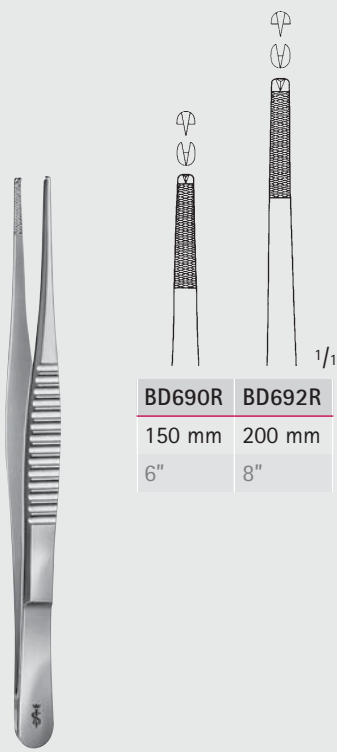

STRASSBURGER MODELL

BD690R-BD692R

| BD690R | BD692R |
|--------|--------|
| 150 mm | 200 mm |
| 6" | 8" |

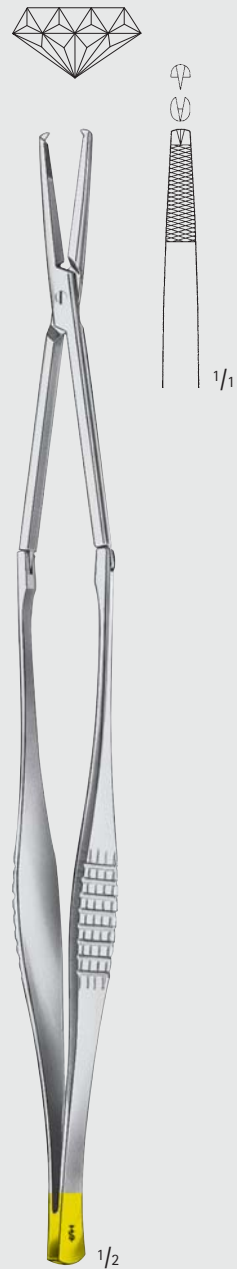

BD185R

Suture forceps

Pinza para suturas

300 mm, 12"



Dissecting and Tissue Forceps – Pinzas de disección y pinzas quirúrgicas

Tissue Forceps
Pinzas quirúrgicas



| BD735R | BD736R |
|---------------|---------------|
| 150 mm | 200 mm |
| 6" | 8" |
| 4 x 5 teeth | 4 x 5 teeth |
| 4 x 5 dientes | 4 x 5 dientes |

ADLERKREUTZ

BD735R-BD736R

Vascular and tumor forceps

Pinzas vasculares y para tumores

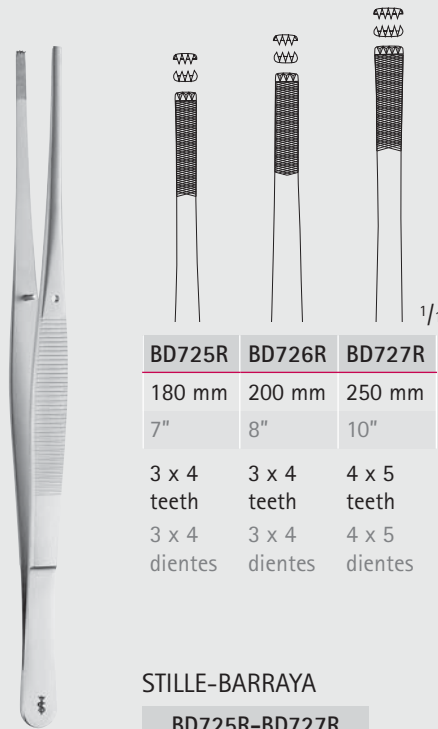

| BD725R | BD726R | BD727R |
|---------------|---------------|---------------|
| 180 mm | 200 mm | 250 mm |
| 7" | 8" | 10" |
| 3 x 4 teeth | 3 x 4 teeth | 4 x 5 teeth |
| 3 x 4 dientes | 3 x 4 dientes | 4 x 5 dientes |

STILLE-BARRAYA

BD725R-BD727R

Vascular and tumor forceps

Pinzas vasculares y para tumores



RUSS. MODELL

BD755R

150 mm, 6"



RUSS. MODELL

BD760R

200 mm, 8"



RUSS. MODELL

BD761R

255 mm, 10"



SELMAN

BD750R

155 mm, 6"

BD



MILLIMETERS

Dissecting and Tissue Forceps – Pinzas de disección y pinzas quirúrgicas

Lung Grasping Dissecting Forceps, Intestinal Forceps

Pinzas para agarrar pulmones, pinzas intestinales

BD

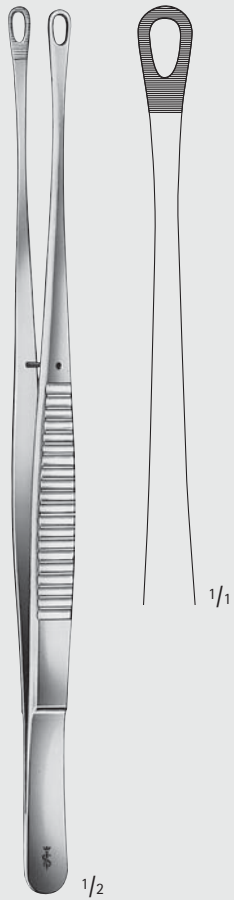
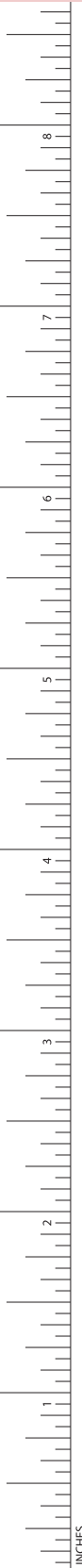

TUTTLE

BD801R

Lung grasping forceps
Pinza para agarrar pulmones
230 mm, 9"

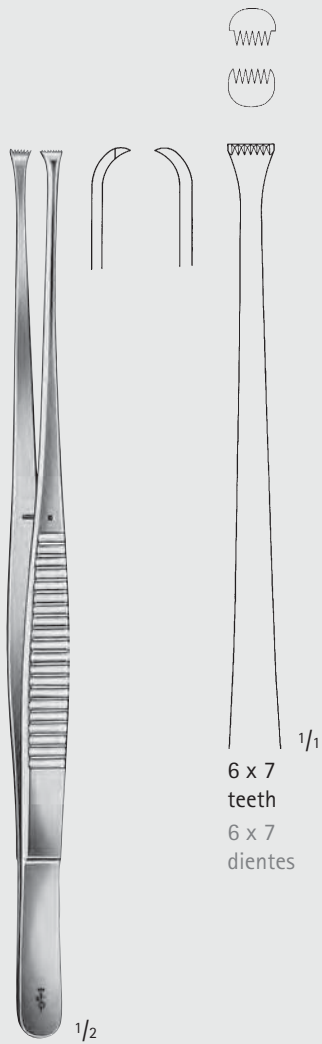

NELSON

BD802R

Lung grasping forceps
Pinza para agarrar pulmones
230 mm, 9"



DUVAL

BD820R

Intestinal forceps
Pinza intestinal
140 mm, 5 1/2"

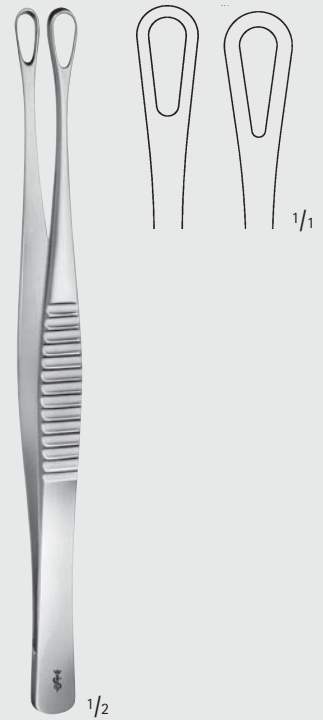

DENIS-BROWNE

EA027R

Intestinal forceps
Pinza intestinal
190 mm, 7 1/2"



Dissecting and Tissue Forceps – Pinzas de disección y pinzas quirúrgicas

Splinter Forceps Pinzas para astillas



BD952R

Splinter forceps
Pinza para astillas
80 mm, 3 1/8"

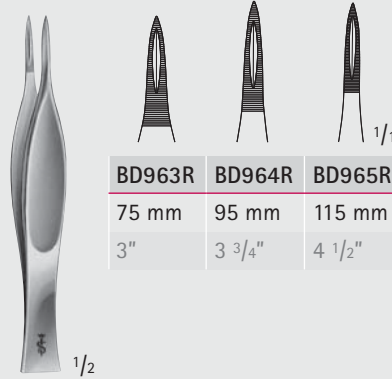

| BD963R | BD964R | BD965R |
|--------|--------|--------|
| 75 mm | 95 mm | 115 mm |
| 3" | 3 3/4" | 4 1/2" |

FEILCHENFELD

BD963R-BD965R

Splinter forceps
Pinzas para astillas

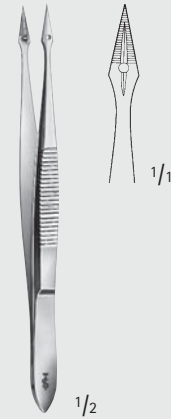

HUNTER

BD980R

Splinter forceps
Pinza para astillas
105 mm, 4 1/8"

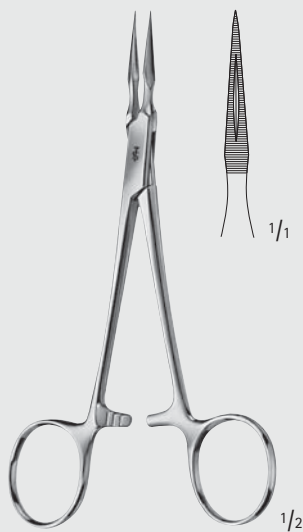

STIEGLITZ

BD992R

Splinter forceps
Pinza para astillas
140 mm, 5 1/2"

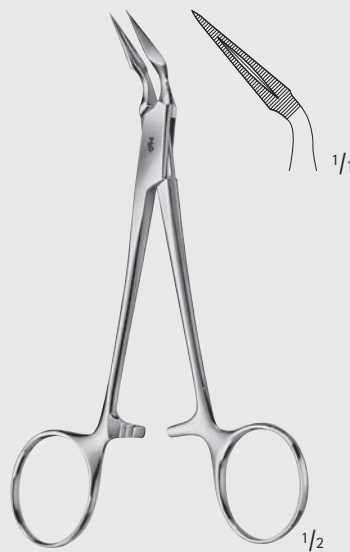

STIEGLITZ

BD993R

Splinter forceps
Pinza para astillas
140 mm, 5 1/2"



PEET

BD995R

Splinter forceps
Pinza para astillas
120 mm, 4 3/4"

BD



MILLIMETERS

