

# Model : DE-PRO Rev.A v.1.1

## Dual Action Dust-Free - Components List

# PRO SPOT

ORDER ONLINE @ [shop.prospot.com](http://shop.prospot.com)



DE-DS Serial #

**DS-**

Checked By:

### Dust-Free Sanding System Components

#### BOX#1

**84-6001** Dual Action Sander - 5mm Orbit  
6" (150mm) Dia. w/ Multi-Hole Pad



1 ea.

**84-6003** Anti-Static Hose Assembly



1 ea.

**84-6002** Hand Block 2.75 x 7.5



1 ea.

**84-6004** Anti-Static Hose Assembly



1 ea.

**84-6056** Disc Hand Block



1 ea.

**SA-0505** Sander & Hose Holder



1 ea.

**84-6011** Anti-Static Vacuum Bag

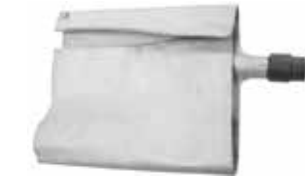

2 ea.

**WA-0100** Ground Adapter



1 ea.

**SA-0677** Worktop Wrap Handle Assy.

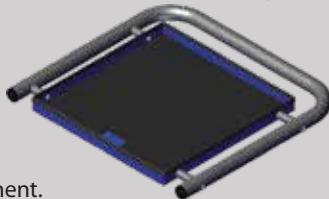

Cart component.

1 ea.

**50-4000** Abrasive Sample Pack



1 ea.

**84-6012** Filter



1 ea.

#### BOX#2 - CART KNOCKED DOWN - P/N DE-MBL-1

**90-1989** DE-MBL Toolboard



2 ea.

**90-2009** DE-MBL Base Mat



1 ea.

**90-1993** Tool Board Shelf

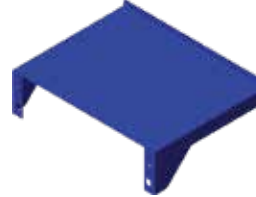

1 ea.

**SA-0671** Sander Head Holder



1 ea.

**90-1963** DE-MBL Base



1 ea.

**SA-0715** Base w/ ESD Grounding

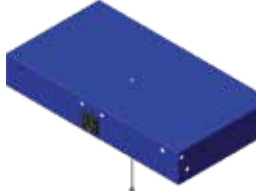

1 ea.

**Continued...**

# Model : DE-PRO Rev.A v.1.0

## Dual Action Dust-Free - Components List

# PRO SPOT

ORDER ONLINE @ [shop.prospot.com](http://shop.prospot.com)

BOX#2 - CART KNOCKED DOWN - P/N DE-MBL-1 Continued...

### SHELF AND ATTACHMENT KIT - P/N DE-MBL-2

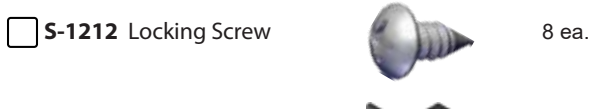
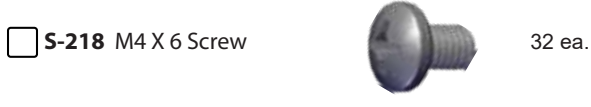
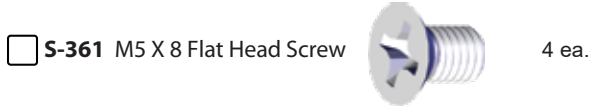
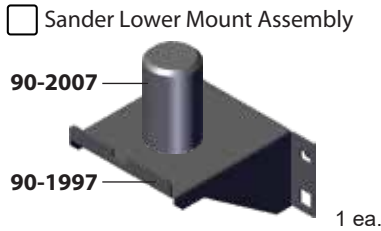
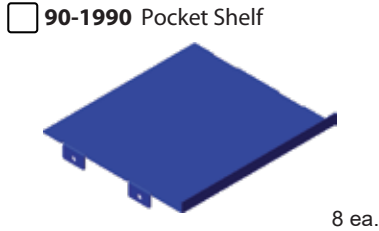

### CASTER KIT - P/N DE-MBL-3

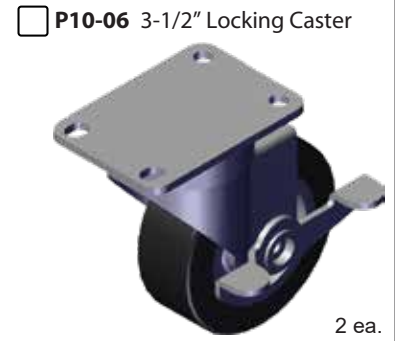

## OPTIONAL ACCESSORIES

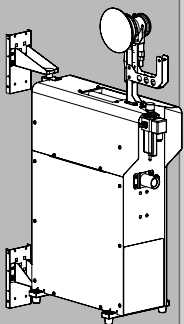

**Wall Mount Kit**  
Mount the Dust Extraction System to a shop wall. The Pro Spot Wall Mount Kit allows pivoting action and easy on/off docking.  
Item# **DE-WALL**

**Replacement Pad**  
Replacement Multi-Hole pad for 6" Dia. DA Sander.  
Item# **84-6020**



**Multi-Hole Interface Pads**  
Attach an interface pad between the sanding pad and abrasive for increased disc flexibility and a balanced pressure. Interface pads are great for rounded surfaces.

Item# **84-6057** S10

Item# **84-6058** M15

Item# **84-6059** H20



**Abrasives Now Available!**



VISIT OUR WEBSTORE  
TO SEE THE LATEST  
PRODUCT ADDITIONS



**File Board**  
Pro Spot's largest dust-free block measures 16 x 2-3/4" and is compatible with both SANDamigo and i-Grit abrasives.  
Item# **84-6016**



**Dual-Action Vacuum Sanders**

Expand your dust extracting arsenal.

Item# **84-6013** 6" Dia. 7mm Orbiting Action

Item# **84-6014** 6" Dia. 3mm Orbiting Action