

Lift Rack Accessories

For Hunter wheel alignment lift racks



FIA Fully Integrated Alignment



FIA streamlines the entire alignment process.

Communication links automate tasks once performed by the technician manually, eliminating time-consuming trips around the vehicle and to-and-from the console.



1



PATENTED

RX Scissor Lift console

- ✓ Raising the vehicle triggers the sensors to look for wheel targets
- ✓ Control PowerSlide® and Inflation Station settings on the lift console
- ✓ Store bar-code scanner and CodeLink tool near the vehicle to save steps



AlignLights turn on automatically at alignment height

2



PATENTED

WinAlign® console

- ✓ Centralized control of entire system
- ✓ Communicate directly with lift to set tire pressure and automatically operate turnplates and slipplates
- ✓ Guide the technician through the alignment process



Measurements are taken automatically once the fourth target is installed

3



POWER SLIDE™

PATENTED

PowerSlide® system

- ✓ Slipplates and turnplates automatically lock and unlock at appropriate times
- ✓ No more struggles with lock pins



Auto-locking turnplates and slipplates save trips around the vehicle

4



INFLATION STATION

PATENTED

Inflation Station

- ✓ Automatically inflate all four tires simultaneously
- ✓ Record starting and final pressure
- ✓ Hose recoils to keep work area clear



Software tracks before and after tire pressures for the customer's printout

PowerSlide™ system



The PowerSlide™ system secures and releases slipplates and turnplates with one touch. With the PowerSlide™ system, technicians no longer have to make multiple trips around the vehicle or struggle to remove and replace lock pins during an alignment.



PATENTED

PowerSlide™ Turnplates

See page 7 for PowerSlide™ turnplate options.



PowerSlide™ Slipplates



RX Lift PowerSlide™ control



Four-Post Lift PowerSlide™ control

TIP

PowerSlide™ saves time operating as a stand-alone system, but operates most efficiently when connected to an aligner through FIA.

- ✓ Conveniently located on the lift console
- ✓ Locks and unlocks slipplates and turnplates with the touch of a button
- ✓ Automatically locks when lift is lowered*

PowerSlide™ upgrades

- PowerSlide™ turnplates *not* included.
- Kits include all parts needed for upgrade but no installation payment. Consult your service rep before quoting.

NEWER

RX10K/12K SCISSOR LIFTS

20-3527-1

Adds PowerSlide™ capability & FIA

RX14K/RX16KF SCISSOR LIFT

20-3528-1

Adds PowerSlide™ capability

NEWER

L45X FOUR-POST LIFTS

20-3069-1

Adds PowerSlide™ capability

Inflation Station system

The Inflation Station system inflates all four tires to a pre-selected pressure simultaneously - while you raise the lift or do other tasks!
Saves steps and save time!



RX Lift Inflation Station control panel



Four-Post Lift Inflation Station/FIA console

- ✓ Set tire pressure at the lift console or at the aligner*
- ✓ Automatically inflate all four tires simultaneously
- ✓ Record starting and final pressure**

Integrated inflation hoses, located at each wheel position, retract when not in use to keep the work area clear.

*Printouts show starting and final tire pressures.**



TIP

Inflation Station saves time operating as a stand-alone system, but operates most efficiently when connected to an aligner through FIA.

Inflation Station upgrades

- PowerSlide™ turnplates *not* included.
- Kits include all parts needed for upgrade but no installation payment. Consult your service rep before quoting.

	RX10K/12K SCISSOR LIFTS	RX16 SCISSOR LIFT	NEWER L45X FOUR-POST LIFTS
Lift has no FIA features	20-3529-1	20-3530-1	20-3070-1

*Inflation Station operation at the aligner requires WA400 or WA300 series alignment console and FIA-equipped lift.

**Requires FIA-equipped aligner with WinAlign 10.x software or greater

AlignLights

The AlignLights system provides a safe and efficient LED light source underneath the vehicle without additional electrical cords.

The lights automatically switch on when the lift is raised and off when the lift is lowered.

20-3438-1 – for RX_K models only

20-2993-1 – for L45x models

AlignLights is an ALI listed accessory for all lift models.



AlignLights is available for most Hunter alignment lifts as an installed option or can be retrofitted to most previously installed lifts.

Swing Air Jacks

Hunter Swing Air Jacks provide reliable, full-pneumatic operation.

Proven over decades of use, air-operated cylinders raise the vehicle from either the suspension or frame. Swing air jacks are engineered to handle a wide variety of vehicles and provide easy, low-maintenance service.



Swing air jacks combine low drive-on height with high lifting capacity.



**9,000-lb. Capacity,
Triple Composite Cylinder Jack
133-84-1**

Ideal for use with RX16, L45x lift models.



**6,000-lb. Capacity,
Dual Composite Cylinder Jack
133-85-1**

Ideal for use with RX-10 and RX12A lift models.

Swing Air Jack clearances

A	Clearance	1.5 in.
B	Max. Low Flip	16 in.
C	Max. High Flip	18 in.

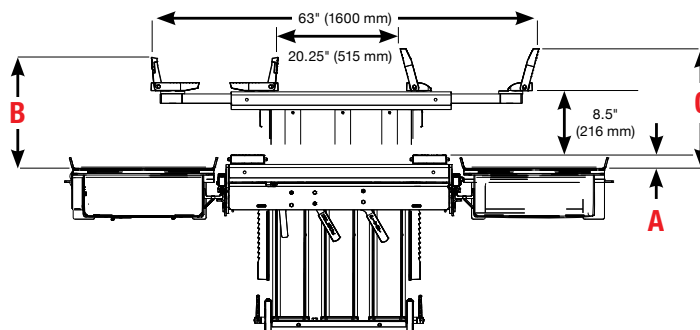

Turnplates



PowerSlide™ Turnplates

PowerSlide™ turnplates eliminate the hassle of removing and replacing lock pins during an alignment. Integrated bridges lower and raise as plates are locked. PowerSlide™ turnplates are an optional feature that may be added later to qualified RX and Four-Post series lifts.

20-2076-1	PowerSlide™ turnplates with automatic bridges	For use with camera-based alignment sensors
------------------	---	---



Stainless Steel Turnplates

Resists corrosion and maintains free movement during the alignment procedure. Stainless steel construction for long, trouble-free life. No pointer.

20-2532-1	Stainless Steel (set of 2)	Fits 1.5" or 50 mm turnplate pockets <i>Includes guide strips</i>
20-2533-1	Stainless Steel, Low Friction (set of 2)	Fits 50 mm turnplate pockets <i>Includes guide strips</i>



Painted Turnplates

20-2531-1BLK

Set of two turnplates for 1.5" or 50 mm turnplate pockets. Steel construction with a powder-coated paint finish. No pointer.



Turnplate Bridge

Eases rolling compensation when rack is used with camera-based alignment sensors.

20-2307-1 Universal Bridge for 50 mm and 1.5" turnplate pockets

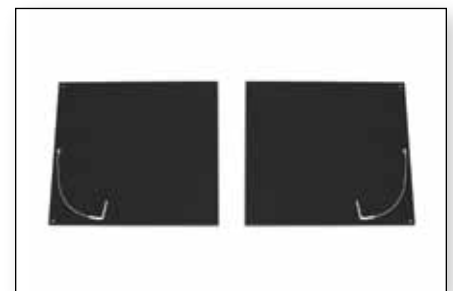

Filler Plates

Fills turnplate pockets when turnplates are not used. 19.5" wide.

20-2395-1BLK For 50 mm pockets (two included)

Ramps & extensions

High-floor-slope conditions and low-ground-clearance vehicles occasionally require additional approach ramp length.

Stage 2 RX Approach Ramp Extensions *(only available in red or black)*

20-3113-1	RX ramp extension kit (set of 2)	Adds 17.75" to the length of RX10K, RX9, RX10, and RX16 <i>Standard on RXDC, RX12K, and RX14K</i>
20-2189-1	RX ramp extension (incl. quick-release pins)	Adds 50" to length of RX10K, RX9, RX10, and RX16 Adds 37.25" to RX-12, RX12A, RX12K, and RX14K



Stage 2 Four-Post Ramp Extension Kit *(only available in red or black)*

20-3145-1	Four-Post ramp extension for 26-in. runways	Adds 17.5" to length of ramps
20-3146-1	Four-Post ramp extension for 26-in. runways	Adds 40" to the length of ramps

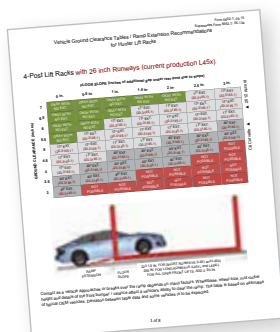

Refer to form **6652-T** for ramp extension recommendations based on vehicle ground clearance.

Ramps & extensions cont.

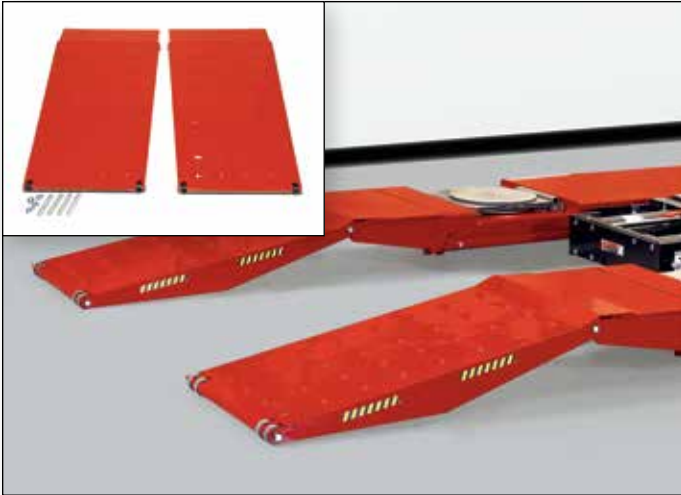

Drive-Thru Kit – 20-2498-1

(Only available in red or black.)

RX10K, RX12K, and RX14K drive-thru kit for camera sensors

Also suitable for legacy RX10, RX12A, and RX16 racks

Adds 52" to overall length

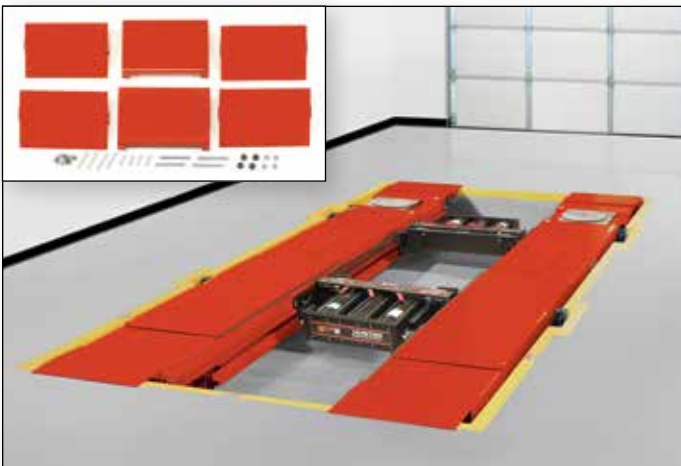

Flush-Mount Conversion Kit – 20-2736-1

Converts surface-mount installations to flush-mount installations, using current site requirements. *(Only available in red or black.)*

For RX10K and RX12K

Also fits legacy RX10 and RX12A racks

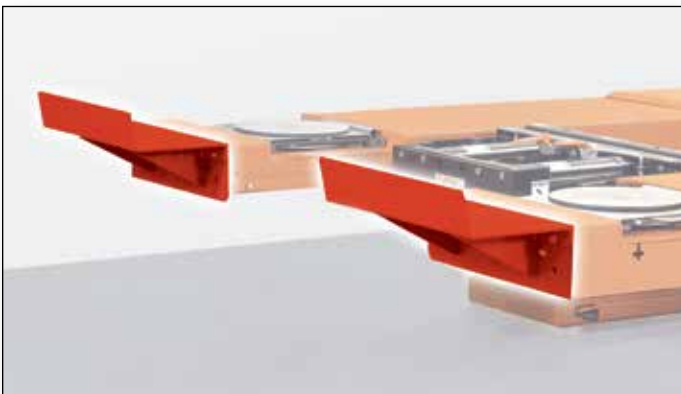

Long Wheel Stops – 20-2497-1

For use with conventional sensors and vehicles with low spoilers. *(Only available in red or black.)*

Fits current RX10K, RX12K, RX14K racks, as well as legacy RX10, RX12A, and RX16 racks

Adds approximately 12" in length

Additional lift accessories



Pit Hose Reel Cover Plates (set of 4) 20-2267-1

Cover plate for Inflation Station lifts to trim around flush-mount cut-outs.

51-2308-1 Single pit hose reel cover plate



Work Step – 51-1696-1

Work step makes custom steer or underhood shim work easier. Can be used with RX, L45X, L42X, L44X, RM, PN and RMHD models.

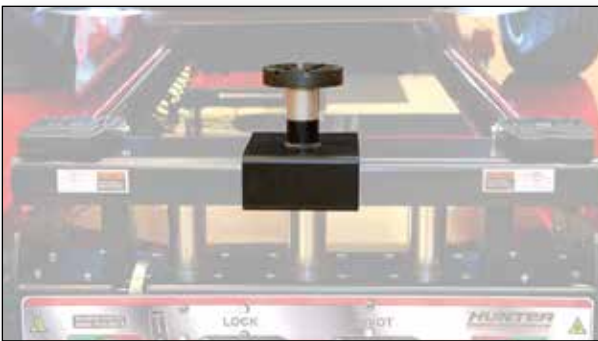

Center Lift Jack Adaptor

20-2854-1 (6,000 lb) **20-2853-1** (9,000 lb)

Ideal accessory for lifting from the differential or subframe on many vehicles. Includes storage bracket.

Suitable for **133-84-1** and **133-85-1** jacks only.



Jack Riser Kit (set of 2) – 20-2801-1

Extends the reach of the jack to make lifting high- ground-clearance and long-wheelbase vehicles easier. Adds 4.5" to overall jack lift height.

Suitable for **133-84-1** and **133-85-1** jacks only.



Front-Mount Power Unit Bracket – 20-3072-1

For L45x models

Moves power unit mounting to front of four-post column for bays with very little space.

Additional lift accessories

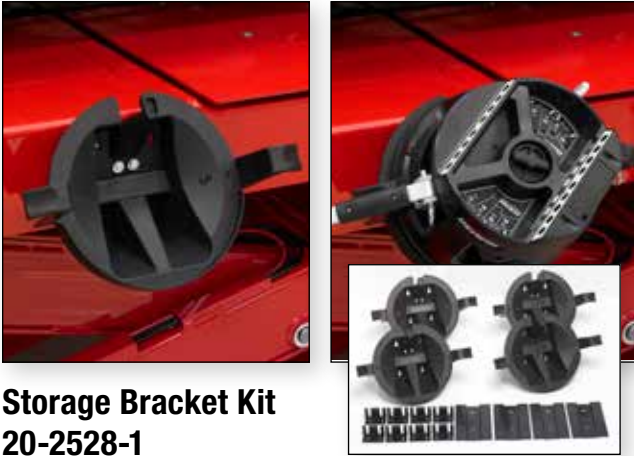

Storage Bracket Kit 20-2528-1

Provides storage for wheel adaptors on console, lift or HawkEye Elite® sensor column. Simply bolts on to clip-on work step holes, no drilling required. Includes four brackets.



Wheel Chock – 22-525-2

Prevents vehicle from rolling once on the lift. Two chocks are included standard in any new lift purchase.



Be sure to check out Hunter's lift rack literature for more detailed information on each product.

Because of continuing technological advancements, specifications, models, and options are subject to change without notice.

WinAlign and HawkEye Elite are registered trademarks of Hunter Engineering Company.

0722CH

Copyright © 2022, Hunter Engineering Company

HUNTER
Engineering Company

www.hunter.com

Form RB05262-00, 07/22
Supersedes Form RB05262-00, 08/21