

# TUBA

Taizhou Tool-bar Machinery Co., Ltd.

Add:Yingbin Road, Songmen Town, Wenling, Zhejiang, China

Tel:+86-576-86229528

Fax:+86-576-86622508

Website:TubaSprayGun.com

www.tool-bar.cn

Email:sales.tuba@gmail.com; sales@tool-bar.cn



E-catalogue 2018 - 2019

[www.TubaSprayGun.com](http://www.TubaSprayGun.com)

[www.Tool-Bar.cn](http://www.Tool-Bar.cn)

# TUBA

## AFFORDABLE HI-END SPRAY GUN



# TUBA

PASSION FOR PERFECTION

TAIZHOU TOOL-BAR MACHINERY CO.,LTD  
TOOL-BAR SPRAY GUN  
AFFORDABLE HI-END SPRAY GUN

## COMPANY PROFILE

Founded by talented engineer Mr. Rifu Zheng in 2011, Tool-bar is a China-based company that manufactures professional and industrial paint spraying equipment and accessories. In just few years, Tool-bar has built its reputation in the spray finishing industry with its quality products.

Combined with its engineering-driven culture, rich industrial experience and manufacturing know-how, Tool-bar is the only manufacturer in the world that can provide a full line hi-end spray guns with totally no o-ring design for extended durability and easy cleaning.

In the automotive refinishing market, Tool-bar equipment provides excellent atomization of high-solids clears that leads to glass like finishes. Tool-bar equipment is optimized to virtually eliminate mottling and striping with metallic base coats and produce excellent color match.

Tool-bar's goal is to re-set the standard for spray finishing through its continuous research and development, innovative product line, and commitment to customer service.

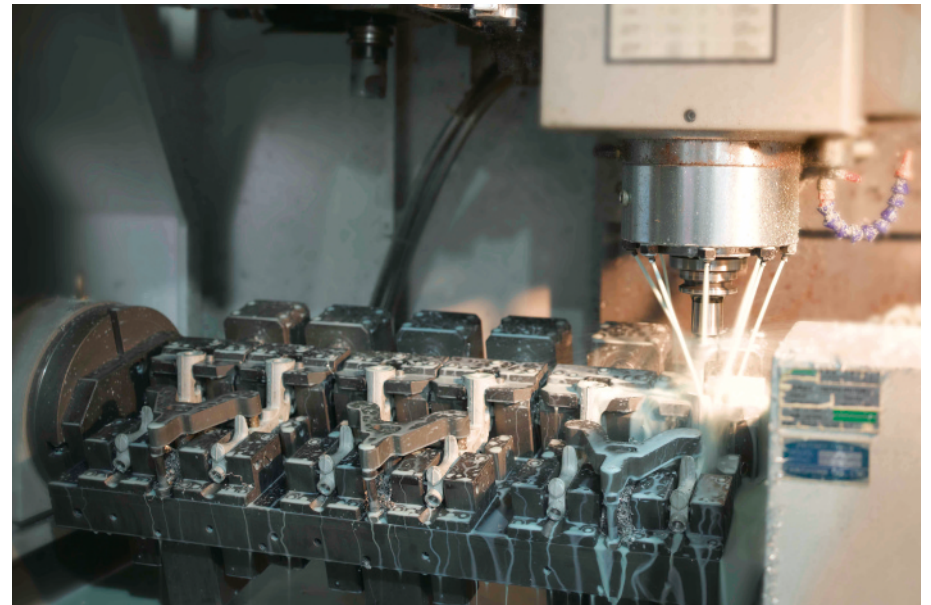

# TABLE OF CONTENTS

Tool-bar Spray Gun

## Manual Spray Gun

P01-17

### Auto Refinishing Spary Gun

TH101AG/BG	P02-03
TH101AS	P04
TH102AG	P05
TH102AG-NS Non-stick edition	P06
TH102BG Round Pattern Edition	P06
TH102AG-ML Metal Flake Spray Gun	P07
TH201AG	P08-09

### Industrial Spray Gun

TR100AG	P11
TR100AS	P12
TR100AP	P13
TR200AG	P14
TR200AS	P15
TR200AP	P16
TM100A For re ease agent	P17
TP300 Airless spray gun	P17

## Industrial Automatic Spray Gun

P18-19

## Premium Accessories

P20-23

# AUTO REFINISHING

Manual Spray Gun



# TH101AG/BG

## Auto Refinishing Spray Gun

Top Coating & General Purpose  
Gravity Feed



**TH-101AG**  
Die-casting body



H.V.L.P.



MP



**TH-101BG**  
Forged body

## Auto Refinishing Spray Gun H.V.L.P./M.P.

Top Coating & General Purpose  
Gravity Feed



No O-ring Design



High Grade S.S. Tip & Needle



Unique Dual Color Ring & Knobs

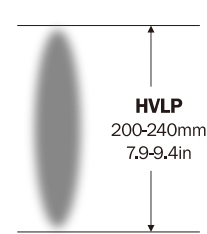

**H.V.L.P.**  
200-240mm  
7.9-9.4in

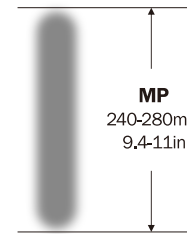

**MP**  
240-280mm  
9.4-11in

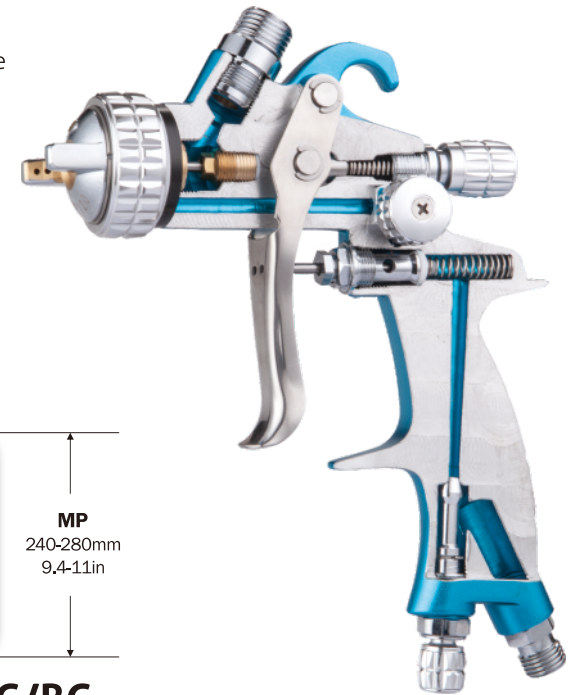

### MODEL:TH101AG/BG

Atomization Technology	H.V.L.P.	M.P.	
Model	TH101AG/TH101BG	TH101AG/TH101BG	
Nozzle Range	1.0-2.0mm	1.0-2.0mm	
Pattern (1.3mm)	200-240mm	240-280mm	
	7.9-9.4in	9.4-11in	
Recommended Air Inlet Pressure	2.0bar	2.5bar	
	29psi	36psi	
Air Consumption	400l/min	300l/min	
	14cfm	10.6cfm	
Air Inlet	G/NPT 1/4"		
Cup	600ml plastic	600ml plastic	
Weight (gun only)	498g	498g	
Material	Body	Aluminum Die-casted/Forged	Aluminum Die-casted/Forged
	Air Cap	Special Selected Brass	
	Nozzle/Fluid Tip	High Grade Stainless Steel	
	Needle	High Grade Stainless Steel	



## Auto Refinishing Spray Gun HVLP/MP

Top Coating & General Purpose  
Siphon Feed



No O-ring  
Design



Unique Dual  
Color Ring  
& Knobs



High Grade  
S.S Tip  
& Needle



Patented No-glue,  
Detachable Paint  
Pick-up System

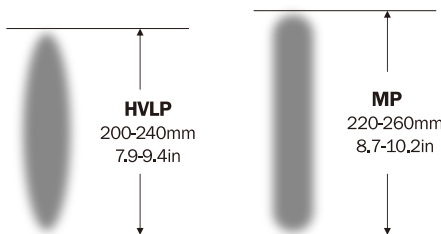

### MODEL:TH101AS

Atomization Technology	HVLP	MP	
Model	TH101AS	TH101AS	
Nozzle Range	1.0-2.0mm	1.0-2.0mm	
Pattern (1.3mm)	200-240mm	220-260mm	
	7.9-9.4in	8.7-10.2in	
Recommended Air Inlet Pressure	2.5bar	3.0bar	
	36psi	43.5psi	
Air Consumption	400l/min	300l/min	
	14cfm	10.6cfm	
Air Inlet	G/NPT 1/4"		
Cup	1000ml Aluminum	1000ml Aluminum	
	Weight (gun only)	548g	548g
Material	Body	Die-casted Aluminum	Die-casted Aluminum
	Air Cap	Special Selected Brass	
	Nozzle/Fluid Tip	High Grade Stainless Steel	
	Needle	High Grade Stainless Steel	



## Auto Refinishing Mini Spray Gun HVLP

Top Coating & General Purpose  
Gravity Feed



No O-ring  
Design



Unique Dual  
Color Ring  
& Knobs



High Grade  
S.S Tip  
& Needle



2-FINGER  
TRIGGER

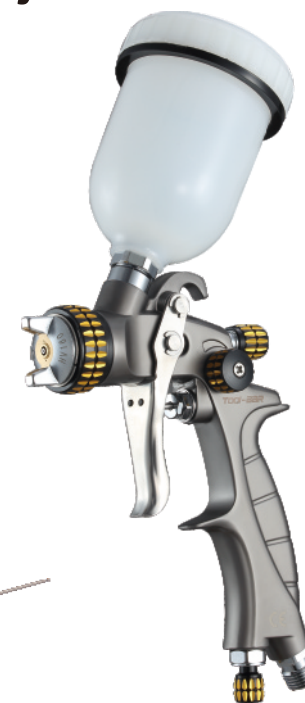

### MODEL:TH102AG

Atomization Technology	HVLP		
Model	TH102AG		
Nozzle Range	0.5-1.2mm		
Pattern (1.0mm)	140-180mm		
	5.5-7.1in		
Recommended Air Inlet Pressure	1.5bar		
	22psi		
Air Consumption	200l/min		
	7cfm		
Air Inlet	G/NPT 1/4"		
Cup	100ml plastic		
Weight (gun only)	322g		
Material	Body	Die-casted Aluminum	
	Air Cap	Special Selected Brass	
	Nozzle/Fluid Tip	High Grade Stainless Steel	
	Needle	High Grade Stainless Steel	

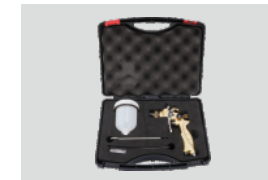

## Auto Refinishing Mini Spray Gun

**HVLP**

NON-Stick Edition  
Gravity Feed



No O-ring Design



Unique Dual Color Ring & Knobs



High Grade S.S Tip & Needle



2-FINGER TRIGGER

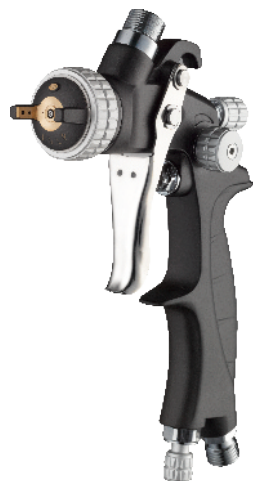

**TH102AG-NS**  
Non-stick edition

## Mini Spray Gun

Round Pattern Edition  
Gravity Feed



No O-ring Design



Unique Dual Color Ring & Knobs



High Grade S.S Tip & Needle



2-FINGER TRIGGER



**TH102BG**  
Round Pattern Edition

## Mini Spray Gun For Metal Flakes

Gravity Feed



No O-ring Design



Unique Dual Color Ring & Knobs



High Grade S.S Tip & Needle



2-FINGER TRIGGER



- ▶ Patented cup liner for smooth material delivery
- ▶ Specially for Metal Flakes and High Solid paints
- ▶ 2.0mm special nozzle setup



# TH201AG

## Top Grade Auto Refinishing Spray Gun

All Climates  
Gravity Feed

High Transfer Rate  
**H.V.L.P.**  
Max. Material Saving

High Efficiency  
**M.P.**  
Max. Application Speed

High Efficiency +  
**H.P.**  
Finest Painting Quality



**TH201AG**

**TH201AG-NS**  
Non-stick edition



HVLP



MP



HP



## Top Grade Auto Refinishing Spray Gun HVL/MP/HP

All Climates  
Gravity Feed



No O-ring Design



Left Hand Friendly



High Grade S.S Tip & Needle



Wide Pattern



Waterborne Compatible

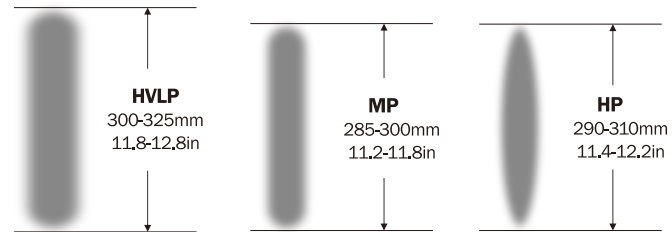
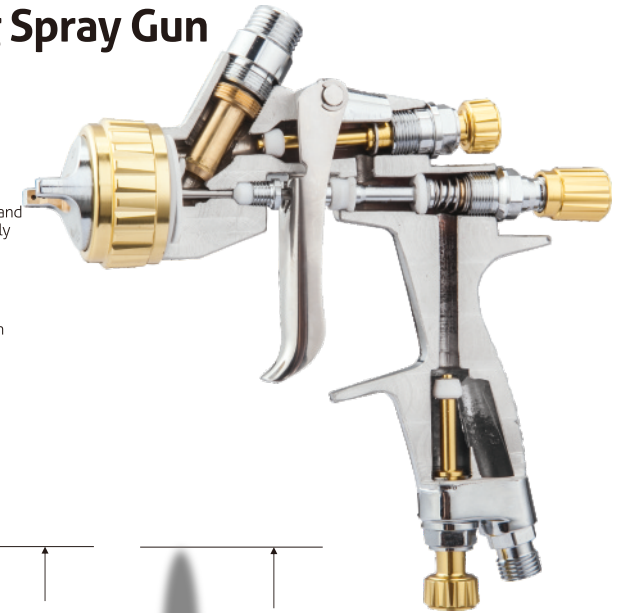

### MODEL:TH201AG

Atomization Technology	HVLP	MP	HP
Model	TH201AG		
Nozzle Range	1.0-2.5mm		
Pattern (1.2-1.4mm)	300-325mm 11.8-12.8in	285-300mm 11.2-11.8in	290-310mm 11.4-12.2in
Recommended Air Inlet Pressure	1.8bar 26psi	2bar 29psi	2bar 29psi
Air Consumption	465l/min 16.4cfm	350l/min 12.4cfm	275l/min 9.7cfm
Air Inlet	G/NPT 1/4"		
Cup	600ml plastic		
Weight(gun only)	492g		
Material	Body	Die-casted Aluminum	
	Air Cap	Special Selected Brass	
	Nozzle/Fluid Tip	High Grade Stainless Steel	
	Needle	High Grade Stainless Steel	



# INDUSTRIAL

## Manual Spray Gun



### Industrial Spray Gun

Compact Size  
Side-gravity Feed



No O-ring Design



Left Hand Friendly



High Grade S.S Tip & Needle



Light Weight Body



### MODEL:TR100AG

Atomization Technology	NP (between LP and MP)	LP
Model	TR100AG	
Nozzle Range	1.0-1.8mm	1.3mm
Pattern (1.3mm)	200-220mm	155-170mm
	7.9-8.7in	6.1-6.7in
Recommended Air Inlet Pressure	2.5bar	2-2.5bar
	36psi	29-36psi
Air Consumption	210l/min	250l/min@2.5bar
	7.4cfm	8.8cfm
Air Inlet	G/NPT 1/4"	
Cup	400ml	400ml
	Aluminum	Aluminum
Weight(gun only)	295g	
Material	Body	Die-casted Aluminum
	Air Cap	Special Selected Brass
	Nozzle/Fluid Tip	High Grade Stainless Steel
	Needle	High Grade Stainless Steel





## Industrial Spray Gun

Compact Size  
Siphon Feed



No O-ring Design



Left Hand Friendly



High Grade S.S Tip & Needle



Light Weight Body



### MODEL:TR100AS

Atomization Technology	NP (between LP and MP)	LP
Model	TR100AS	TR100AS
Nozzle Range	1.0-1.8mm	1.3mm
Pattern (1.3mm)	200-220mm	140-145mm
	7,9-8,7in	5,5-5,7in
Recommended Air Inlet Pressure	3bar	2-2,5bar
	43,5psi	29-36psi
Air Consumption	210l/min	250l/min@2,5bar
	7,4cfm	8,8cfm
Air Inlet	G/NPT 1/4"	
Cup	600ml	600ml
	Aluminum	Aluminum
Weight(gun only)	295g	
Material	Body	Die-casted Aluminum
	Air Cap	Special Selected Brass
	Nozzle/Fluid Tip	High Grade Stainless Steel
	Needle	High Grade Stainless Steel



## Industrial Spray Gun

Compact Size  
Pressure Feed



No O-ring Design



Left Hand Friendly



High Grade S.S Tip & Needle



Light Weight Body









### MODEL:TR100AP

Atomization Technology	Pressure Feed	
Model	TR100AP	
Nozzle Range	1.0-1.8mm	
Pattern (1.3mm)	240-300mm	
Recommended Air Inlet Pressure	2.5bar	
	36psi	
Air Consumption	210l/min	
	7,4cfm	
Air Inlet	G/NPT 1/4"	
Cup	n/a	
Weight(gun only)	295g	
Material	Body	Die-casted Aluminum
	Air Cap	Special Selected Brass
	Nozzle/Fluid Tip	High Grade Stainless Steel
	Needle	High Grade Stainless Steel



## Industrial Spray Gun

Full Size  
Gravity Feed

-  No O-ring Design
-  Left Hand Friendly
-  100% Stainless steel fluid passages
-  Light Weight Body
-  Wide Pattern
-  Waterborne Compatible
-  True LVLP technology



100% stainless steel fluid passages

### MODEL:TR200AG

Atomization Technology	LVLP	HVLP	MP
Model	TR200AG/BG		
Nozzle Range	1.0-3.0mm		
Pattern (1.3mm)	280mm	300mm	290mm
	11in	11.8in	11.4in
Air Inlet Pressure	1.2bar	1.8bar	2.0bar
	17psi	26psi	29psi
Air Consumption	270l/min	465l/min	370l/min
	9.5cfm	16.4cfm	13.1cfm
Air Inlet	G/NPT 1/4		
Cup	600ml		
	Plastic		
Weight(gun only)	446g		
Material	Body	Die-casted Aluminum with built-in stainless steel fluid passages	
	Air Cap	Special Selected Brass	
	Nozzle/Fluid Tip	High grade stainless steel/hardened steel (optional)	
	Needle	High grade stainless steel/hardened steel (optional)	



## Industrial Spray Gun

Full Size  
Siphon Feed

-  No O-ring Design
-  Patented No-glue, Detachable Paint Pick-up System
-  100% Stainless steel fluid passages
-  Light Weight Body
-  Wide Pattern
-  Waterborne Compatible
-  True LVLP technology



### MODEL:TR200AS

Atomization Technology	LVLP	MP
Model	TR200AS	
Nozzle Range	1.3,1.4 mm	1.5, 1.7, 1.8, 2.0, 2.5mm
	250-270 mm	290-380 mm
Pattern	9.8-10.6 in	11.4-15 in
	1.6bar	2.5bar
Air Inlet Pressure	24psi	36psi
	250l/min	270l/min
Air Consumption	8.8cfm	9.5cfm
	G/NPT 1/4"	
Air Inlet	G/NPT 1/4"	
Cup	600/1000ml Plastic	
Weight(gun only)	446g	
Material	Body	Die-casted Aluminum with built-in stainless steel fluid passages
	Air Cap	Special Selected Brass
	Nozzle/Fluid Tip	High grade stainless steel/hardened steel (optional)
	Needle	High grade stainless steel/hardened steel (optional)



## Industrial Spray Gun

Full Size  
Pressure Feed

-  No O-ring Design
-  Left Hand Friendly
-  100% Stainless steel fluid passages
-  Light Weight Body
-  Hardened Nozzle & Needle (Optional)
-  Waterborne Compatible
-  True LVLP technology



### MODEL:TR200AP

Atomization Technology	LVLP	MP
Model	TR200AP	
Nozzle Range	1.2mm	2.0, 2.5mm
Pattern	300 mm	370mm@25 cm
	11.8 in	14,6in@9,8 in
Air Inlet Pressure	2bar	3,5bar
	29psi	50psi
Air Consumption	500l/min	500l/min
	18,2cfm	18,2cfm
Air Inlet	G/NPT 1/4"	
Cup	n/a	
Weight(gun only)	446g	
Material	Body	Die-casted Aluminum with built-in stainless steel fluid passages
	Air Cap	Special Selected Brass
	Nozzle/Fluid Tip	High grade stainless steel/hardened steel (optional)
	Needle	High grade stainless steel/hardened steel (optional)



## Industrial Spray Gun

Compact Spray Gun  
For Release Agent

-  No O-ring Design
-  Durable forged body
-  Wide Pattern
-  Light Weight Body



**TM100A**

Nozzle Range	0.3-0.8 mm	
Air Inlet Pressure	1.0 bar	
	14,5 psi	
Material	Body	High Grade Stainless Steel
	Air Cap	Special Selected Brass
	Nozzle/Fluid Tip	High Grade Stainless Steel
	Needle	High Grade Stainless Steel

## Heavy-duty Airless Spray Gun

3600psi/250 bar

-  No O-ring Design
-  Durable forged body
-  Wide Pattern
-  Light Weight Body







**TP300**

# TA501

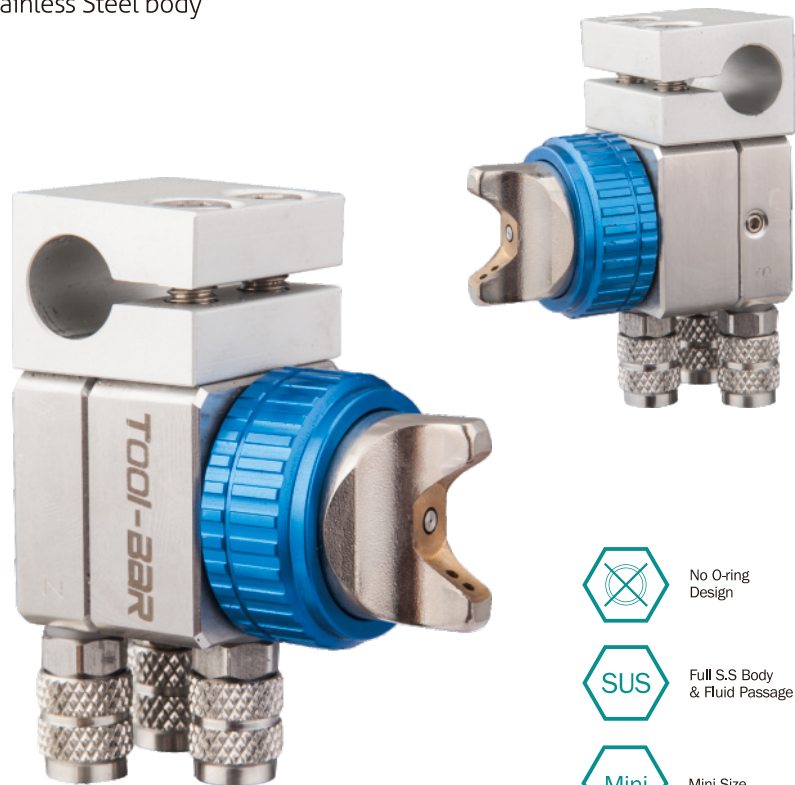
## Industrial Automatic Spray Gun

Full Stainless Steel body



-  No O-ring Design
-  Full S.S Body & Fluid Passage
-  Mini Size



Model	TA501	
Nozzle Range	0.3-1.5mm	
Air Pressure(Material)	Max. 3.0bar	
	Max. 43,5psi	
Air Pressure(Control)	3.0-6.0bar	
	43,5-87psi	
Weight(gun only)	140g/190g(with damp)	
Material	Body	High grade stainless steel
	Air Cap	Special Selected Brass
Material	Nozzle/Fluid Tip	High Grade Stainless Steel
	Needle	High Grade Stainless Steel

# TA501

## Industrial Automatic Spray Gun

Full Stainless Steel body

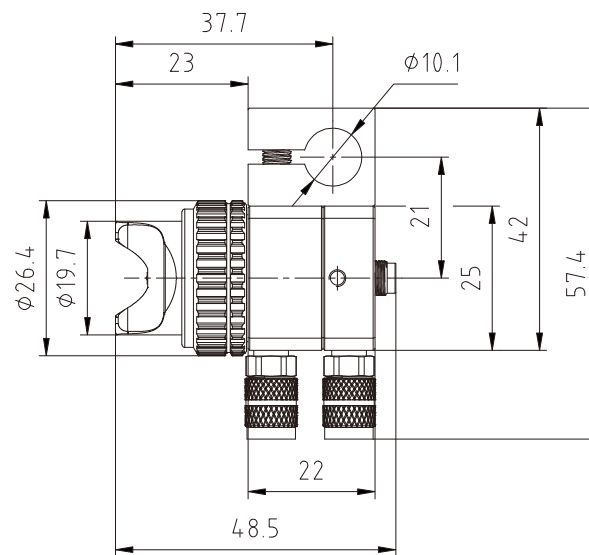
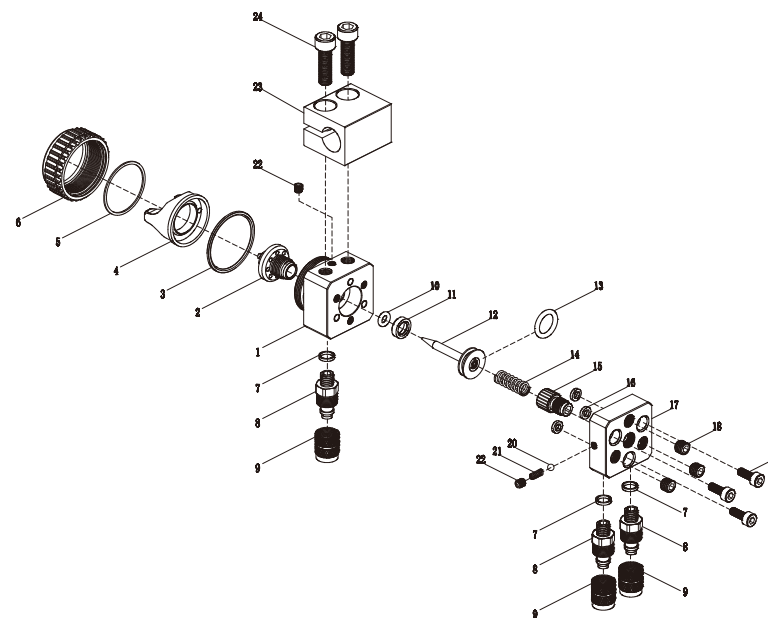

# PREMIUM ACCESSORIES

## PS2901A 1000ml



Durable stainless steel rivets for perfect sealing quality



Patented adhesive-free detachable paint pick up system



PG1601A  
600ml



PG1301A  
300ml



PG1101A  
100ml



PG1301D  
300ml



PS2604A  
600ml



PS2605A  
600ml non-stick

Patented professional Aluminum gravity cup

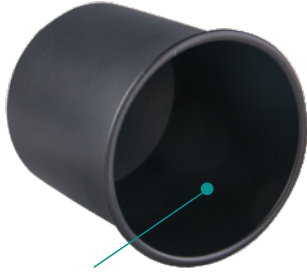

Black non-stick finish for easy cleaning and also is good for UV paints.



Durable one-piece structure



PG2101A  
150ml



PG2602A2 Anodized  
PG2602A3 Non-stick  
600ml



PG2602A  
600ml



PG2906A  
1000ml



PG2902A1 Non-stick  
1000ml



PG2902A  
1000ml

- High flow air passage that 100% compatible with HVLP technology;
- Durable no rubber o-ring design (body).
- Knob type regulator-to-gun fitting
- Compact size and light wight



High Flow Professional Air Pressure Regulator With Gauge

JYF02 w/ hex nut head  
JYF02B w/knob head

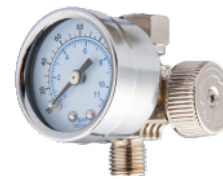

Mini Air Pressure Regulator With Gauge



JYF01

Whip Hose With Swivel Connector



High Flow Professional Swivel Connectors

SJ10-FG02A / RJG02-MM15A