

# Unite U10074

## Audio Amplifier

### User Guide



Unite Audio

Nexus Audio Visual Pty Ltd

15-19 Villas Road

Dandenong South,

Victoria, Australia 3175

## Table of Contents

Introduction.....	3
Installation.....	3
Equipment.....	3
Amplifier Front-Panel Features.....	4
Amplifier Rear-Panel Features.....	5
Web Interface.....	6
Amplifier Configuration.....	7
Settings.....	9
Amplifier Use.....	10
Specifications.....	13

Document Revision	Details	dd/mm/yy Inits
Rev A	Initial Release.	12/04/21 DJA
Rev B	Fix some issues	13/11/21 AAA

## Introduction

This document provides a user's guide for the Unite U10074 amplifier. The U10074 is part of the Unite family of Commercial and Domestic amplifiers.

In this guide the term Zone refers to a particular location serviced by one of the amplifier outputs. Each Zone is Mono and the 100V line drive is supplied by 100V impedance transformers which in-turn are driven by amplifiers connected internally for Bridge-Tied Load (BTL). All outputs feature internal 4th order High Pass filter to remove very low frequencies and protect the line drivers.

The term Source refers to a particular signal source connected to the amplifier inputs. Example sources are CD players, solid-state sources such as memory sticks, Internet streaming sources, microphones and so on.

## Installation

The simplest configuration of the U10074 is with mono (Inputs 1 and 2) and stereo (Inputs 3, 4 and 5) analog signal Inputs and stereo Speaker outputs.

An S/PDIF digital audio signal may also be connected to Input 6.

## Equipment

- Model U10074 Amplifier
- Loudspeakers
- Signal sources
- Internet connection
- Web browser (Chrome, Firefox, Edge, Vivaldi etc.)
- Interconnect cables

## Amplifier Front-Panel Features

The U10074 amplifier can be controlled from the front panel. There are four multi-function rotary controls to adjust Source and Volume configuration for each Zone.

The U10074 amplifier indicates its operational condition with three LED indicators on the right-hand side and a full-colour screen on the left-hand side.

### LED indicators

The U10074 LED indicators show the power/boot status, network connection status and alert status.

### Display

The U10074 display shows the Source selected for each Zone and the volume setting for each Zone. The display also shows the IP address the amplifier and ID.



### Controls

The U10074 features 4 rotary/push controls (encoders) for user control over basic operation.

This includes setting:

- Volume of Zone
- Source for Zone
- Set Power
- Controls Off

## Amplifier Rear-Panel Features

All the connectors for the U10074 amplifier are on the rear panel. This includes Power, internet, hardware controls, signal Source inputs and Zone speaker outputs.

### Basic Connections

Make sure the amplifier mains switch is in the Off (O) position before making any connections.

- Connect mains power to the mains input socket.
- Connect Source signal sources to the Inputs as required.
- Connect Zone speakers to the Speaker Outputs as required.
- Connect the amplifier to the internet via a patch cable to the LAN socket.

If hardware controls such as Mute and PTT are not required, there is no need to make any connections to these inputs.

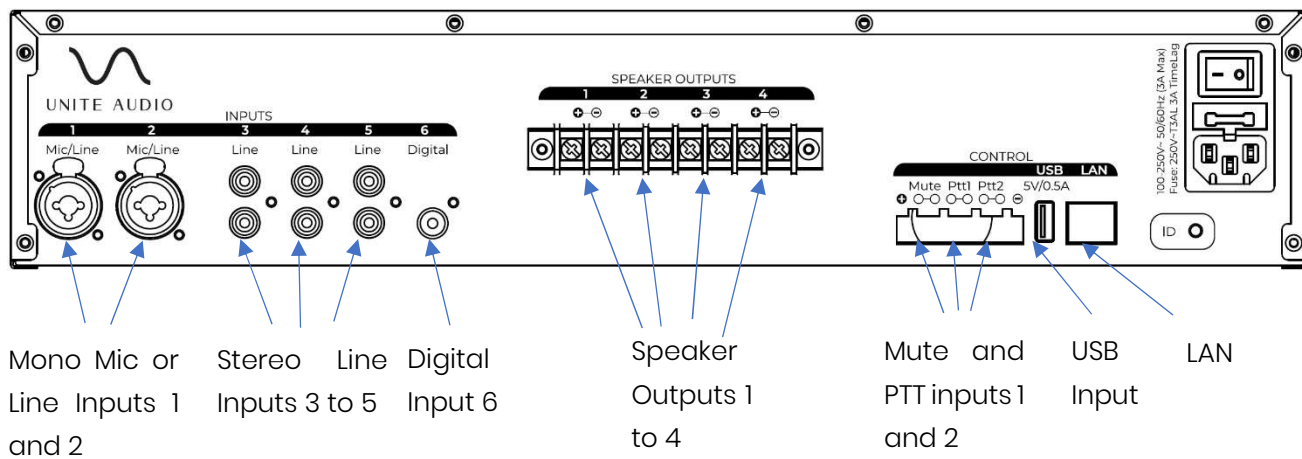

### Power-up

Check connections and move the power switch to the ON (I) position.

The front panel power LED will flash while the amplifier boots up, acquires an IP address and loads its last-set configuration.

When this process has completed the power LED will remain ON steady and the Display will light up and indicate the current Zone Source and volume settings.

## Web Interface

The U10074 amplifier can be configured and controlled via its web interface.

There are 2 levels of access: User and Manager. Manager access is required for Configuration and Control while User only allows Zone volume control.

### Login

Record the IP address of the amplifier as shown on the front panel display.

**Option1:** Enter the following address into your Web browser (most browsers):

<http://unite.local>

**Option2:** If the browser does not connect using option1 method then enter the IP address into your Web browser in the following format:

<http://aaa.bbb.ccc.ddd>

Where aaa.bbb.ccc.ddd is the address noted from the front panel display.

Option1 or Option2 will take you to the login page of the amplifier.

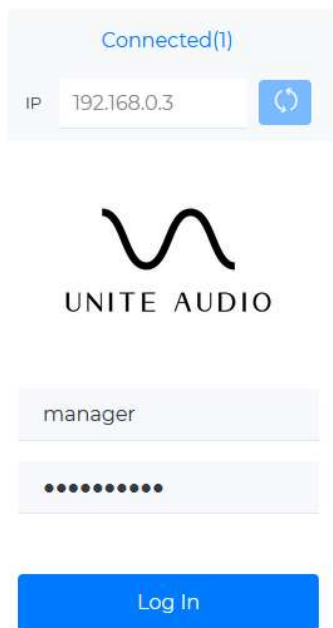

In this case the amplifier's IP address is *192.168.0.3*. (Individual address ranges will vary.)

For basic User access enter the word "user" for the user and "uunite2020" for the password.

For full access enter Manager credentials. Please request this information from your sales contact.

## Amplifier Configuration

The U10074 amplifier needs to be configured via web browser prior to use in a new installation. **Manager credentials are required for this process.** The parameters that need to be set include the following:

Sources:

- Input gain setting (Sources 1 and 2)
- Volume settings - Volume Limit, Volume and Balance
- Equalisation settings – High, HighMid, Mid, LowMid, and Low
- Unite Bass

The amplifier also can also have its Zone type configured and Zones and Sources can be renamed for convenience to suit the physical layout and signal sources.

### Configuration

Upon successful login the amplifier will display its Zone configuration web page as shown in the image example below.

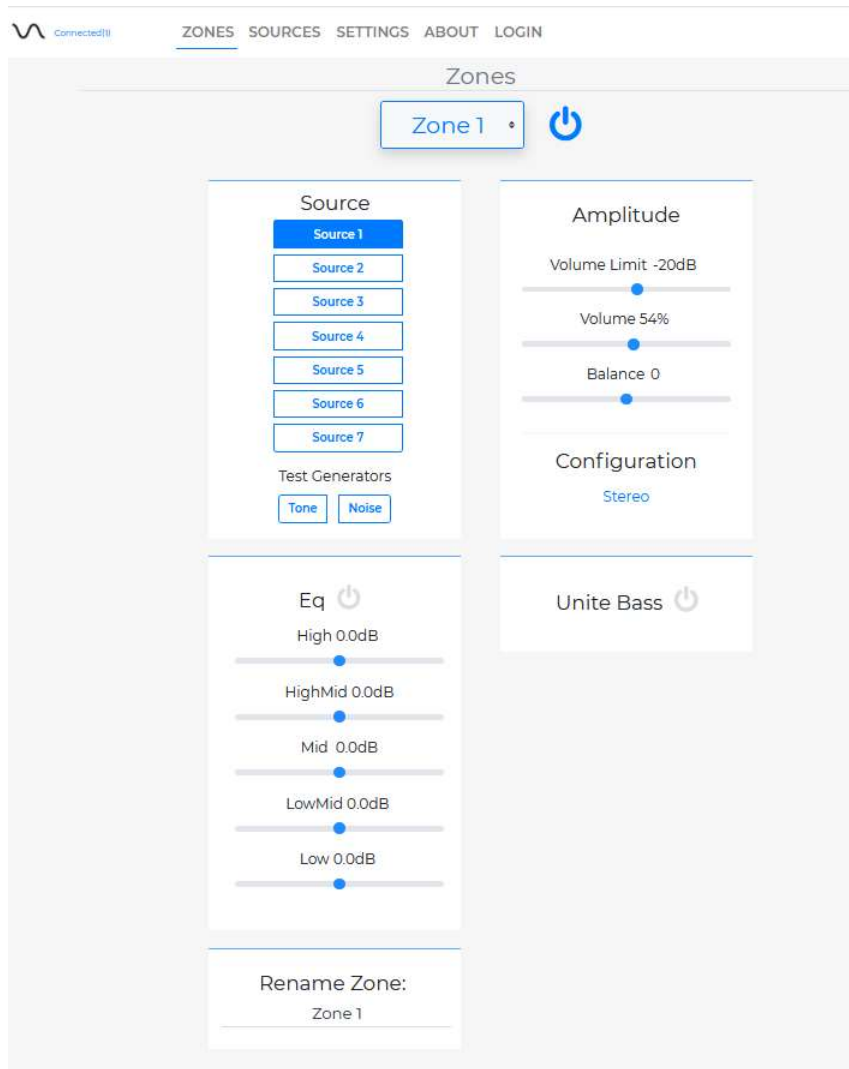

There is a separate page for each Zone. The individual Zones are selected via the UP/DOWN arrows in the ZONE selection box:



The name of each Zone will be displayed. Note that the Zone names can be changed to suit a particular installation. The defaults are Zone1, Zone2 ... Zone4 (Zone6 for 6-Zone variants).

The **ON** icon next to the Zone name **MUST** be **ON** (Blue) for the Zone to be enabled and active. If the Zone is not enabled the **ON** icon will be greyed-out as shown below:



To select a particular Source for a given Zone, select it directly from the SOURCE selection boxes. Note that the Source names can be changed to suit a particular installation. The defaults are Source1, Source2 ... Source7.

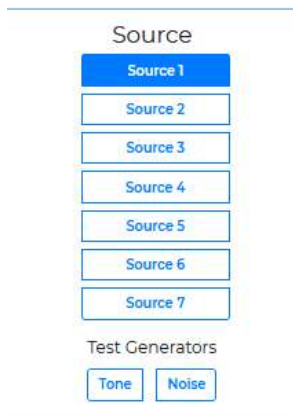

In the example shown above, Source 1 has been selected.

For the selected Source, the Amplitude settings need to be configured. This includes the Volume that is also able to be set via the front panel controls.

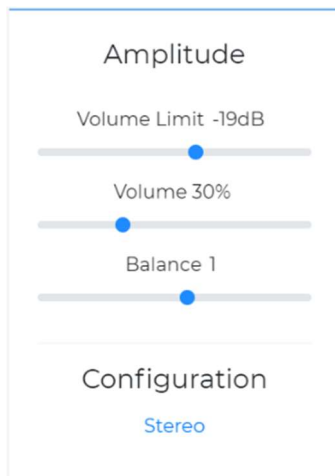



In a similar manner, the Equalisation for the Zone may be configured:



## Settings

The Settings page shows the current configuration of the amplifier.

The Connected Device will show the MAC of the target device. This can be verified from the front display panel with the last 4 digits of the ID field.

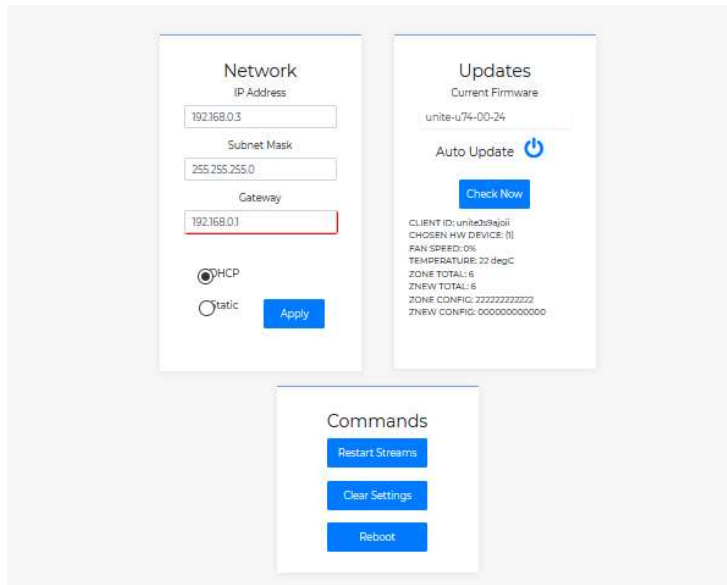

## Output Configurations

The U10074 amplifier outputs are fixed configuration to comply with driving 100V lines.

## Amplifier Use

Once configuration is complete, the amplifier may be controlled via web interface in either Manager or User modes and by the front panel controls.

### Web Interface

With User-level access, only the volume, zone enable, and source controls are available:

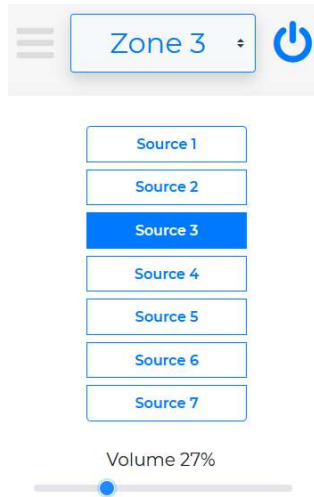

The User cannot change other settings. These settings need to be configured by a Manager.

### Front Panel Status and Control

The U10074 has a 2.5 inch full-colour status display and four rotary/push controls for user control over basic operation.

This includes setting:

- Volume of Zone
- Source for Zone
- Set Power
- Controls Off

Each press of a control knob will change which of the above is being controlled. The active mode cycles around with each control knob push as shown overleaf:

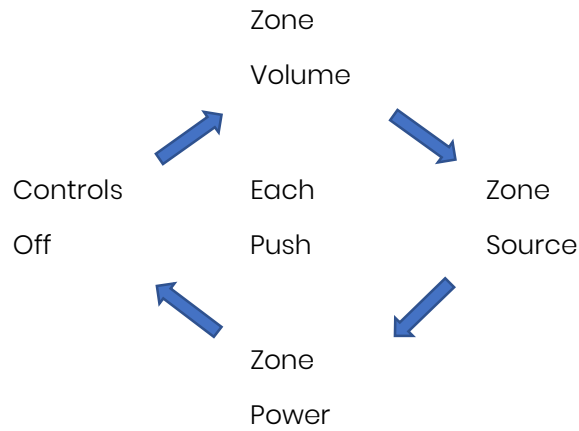

### *Set Volume*

Set volume is the default screen and control following power-up. Each front panel control has direct control over its respective zone.



Rotate the controls clockwise to increase the Zone's volume, counterclockwise to decrease.

### *Zone Source*

Push any control once to advance from the Set Volume mode to Set Source mode.



Rotate the controls to select the active Source for each Zone.

### *Set Power*

Use this function to disable Zones, muting them and powering them down.

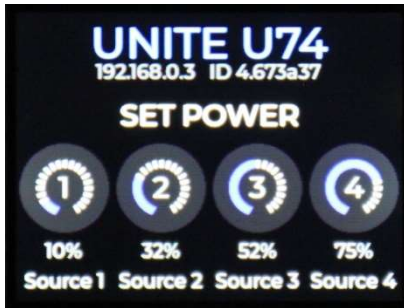

Each Zone can be individually powered-down. Rotate the Zone's control clockwise to activate, counterclockwise to power-down.

### *Control Off*

This function disables all controls to prevent accidental adjustment.



Press any control again to re-activate.

## Specifications

Unless otherwise specified, Ta=25C, Supplied by UI0074 @ 230Vac mains voltage.

Mains Supply Voltage	100 to 240Vac
Mains Minimum/Maximum Voltage	Absolute Supply 85 to 264Vac
Mains Frequency	45 to 65Hz
Maximum Mains Power Input	400W
Mains Socket	IEC-style
Mains Supply Transients	6kV common mode
Maximum Power Consumption	320W
Standby Power	115Vac: 4.2W 230Vac: 7.8W
Fuse Rating	T3AL Time-Lag 115Vac: 5A 230Vac: 3A
Ambient Temperature	0 to 50C
Maximum Humidity	85% Non-Condensing
Maximum Altitude	2,000m
Cooling	Fan forced, thermostatic control
USB	5Vdc, 0.5A
Output power @ 0.1%THD+N 20Hz < f < 20kHz (single Zone)	160W per Zone
Output HPF cut-off	4 <sup>th</sup> order 65Hz HPF on every channel.
Zones	4 x BTL Mono
Sources	<ul style="list-style-type: none"> <li>• 2 x Mic/Line – XLR or ¼” plug</li> <li>• 3 x Stereo – RCA</li> <li>• 1 x S/PDIF – RCA</li> <li>• 1 x USB</li> </ul>
Dimensions	Stand Alone: 96.5 x 438 x 327.5 (H x W x D) Rack Mount: 87.6 x 481.8 (2RU) x 304 (H x W x D)
Weight	TBA
Rack Mount	Optional RM kit, SA as standard.

Display	63.5mm (2.5") diagonal full-colour display <ul style="list-style-type: none"><li>• 240 x 320 Dot Matrix</li><li>• 36.72 x 48.96 (W x H) Active Display Area</li></ul>
Status Indication	3 x Status LEDs: <ul style="list-style-type: none"><li>• Power/boot status</li><li>• Network connection status</li><li>• Alert status.</li></ul>
Control	4 x rotary/push encoders
Mic input Phantom Power	12, 24 or 48Vdc