

E-Z Style

FURNITURE





ASSEMBLY INSTRUCTIONS AND PARTS IDENTIFICATION

MODEL # 1910EZ-18NE

WALL SHELF

Thank you for purchasing this quality product. Be sure to check all packing material carefully for small parts that may have come loose inside the carton during shipment.

Key Parts			
No	Code	Qty	Description
1	1910EZ-18NE	1 pc	Wooden shelf
2	1910EZ-18NE	1 pc	Shelf support

Hardware kit (1910EZ-18NE)			
No	Description	Qty	
A	 Screwdriver	1 pc	
B	 Screws	4 pcs	
C	 Wall screws (2" long)	3 pcs	
D	 Wall anchors	3 pcs	

***NOT TO BE USED TO SUPPORT A TV**
WEIGHT LIMIT 10 POUNDS

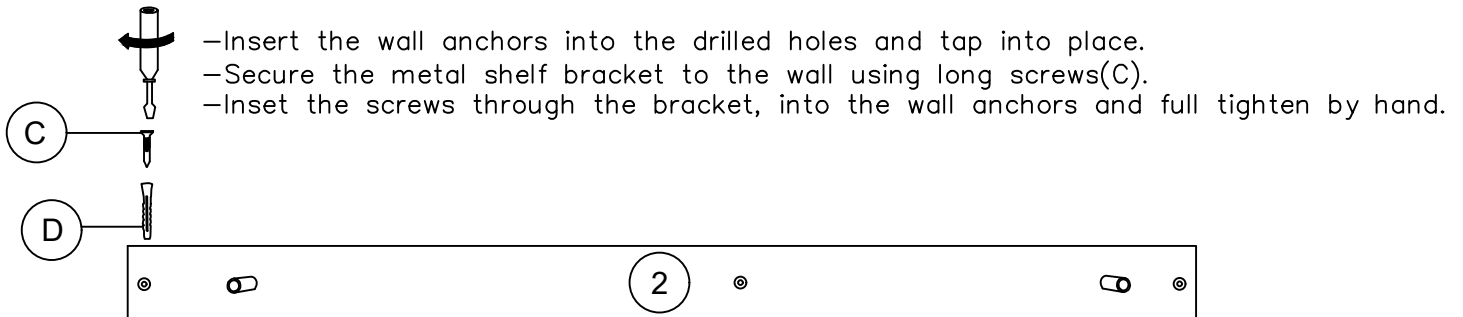
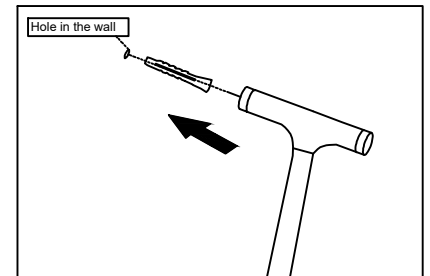
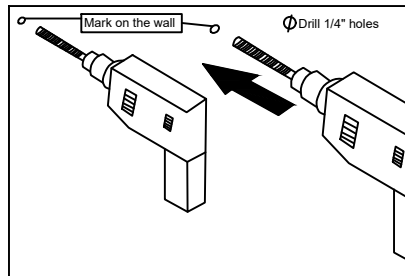
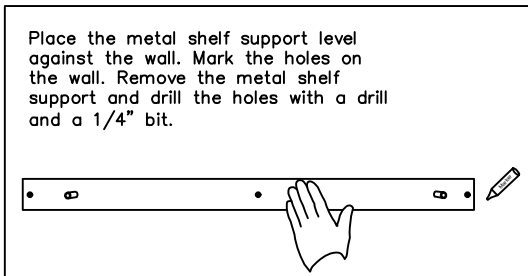

-Insert the shelf by lining up the holes to the connecting rods on the bracket.
 -Make sure the holes in shelf face down.
 -Secure the shelf to the bracket using the short screws(B) and hand tighten with the screwdriver.

