

# *E-Z Style*

## *FURNITURE*

# ASSEMBLY INSTRUCTIONS AND PARTS IDENTIFICATION

## MODEL # 1910EZ-24NE





### WALL SHELF

Thank you for purchasing this quality product. Be sure to check all packing material carefully for small parts that may have come loose inside the carton during shipment.

#### Key Parts

No	Code	Qty	Description
1	1910EZ-24NE	1 pc	Wooden shelf
2	1910EZ-24NE	1 pc	Shelf support

#### Hardware kit (1910EZ-24NE)

No	Description	Qty
A	 Screwdriver	1 pc
B	 Screws	4 pcs
C	 Wall screws (2" long)	3 pcs
D	 Wall anchors	3 pcs

**\*NOT TO BE USED TO SUPPORT A TV**  
**WEIGHT LIMIT 15 POUNDS**

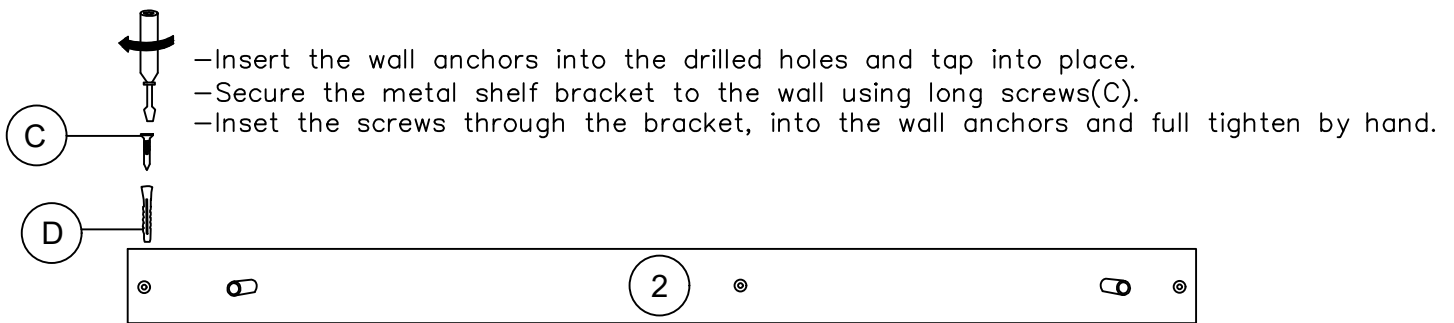
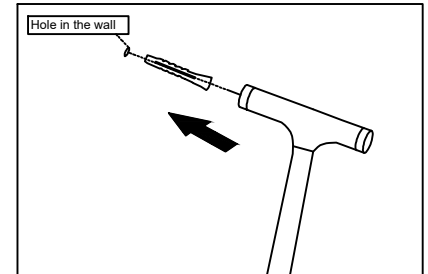
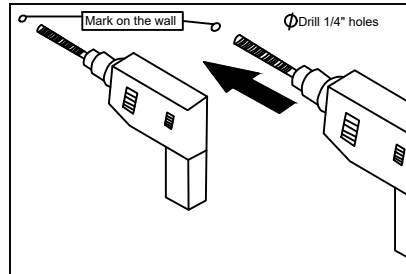
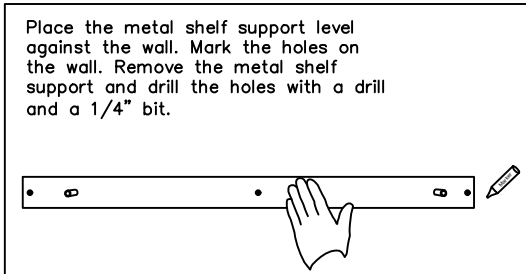

-Insert the shelf by lining up the holes to the connecting rods on the bracket.  
 -Make sure the holes in shelf face down.  
 -Secure the shelf to the bracket using the short screws(B) and hand tighten with the screwdriver.

