



**OPERATING AND
SERVICE MANUAL**



BLOWERS

8000 SERIES

10" - 22" GEAR DIAMETER

**SB-7-627
Version 02
January, 2006**

**MAINTAIN BLOWER RELIABILITY AND PERFORMANCE
WITH GENUINE GARDNER DENVER
PARTS AND SUPPORT SERVICES**

Factory genuine parts, manufactured to design tolerances, are developed for optimum dependability --- specifically for your blower. Design and material innovations are born from years of experience with hundreds of different blower applications. When you specify factory genuine parts you are assured of receiving parts that incorporate the most current design advancements . . . manufactured in our state-of-the-art blower factory under exacting quality standards.

Your **AUTHORIZED DISTRIBUTOR** offers all the backup you require. A worldwide network of authorized distributors provides the finest product support in the blower industry.

Your **AUTHORIZED DISTRIBUTOR** can support your

blower investment with these services:

1. Trained parts technical representatives to assist you in selecting the correct replacement parts.
2. Complete inventory of new machines and new, genuine factory parts.
3. A full line of factory tested AEON™ PD blower lubricants specifically formulated for optimum performance in all blowers.
4. Authorized Distributor service technicians are factory-trained and skilled in blower maintenance and repair. They are ready to respond and assist you by providing fast, expert maintenance and repair services.

INSTRUCTIONS FOR DETERMINING BLOWER CONFIGURATION

1. Face the blower drive shaft.
2. In a **VERTICAL** configuration, air flow is horizontal.
3. In a **HORIZONTAL** configuration, air flow is vertical.
4. In a vertical configuration, a **BOTTOM HAND** exists when the drive shaft is below the horizontal center line of the blower. A **TOP HAND** exists when the drive shaft is above the horizontal center line of the blower.
5. In a horizontal configuration, a **RIGHT HAND** exists when the drive shaft is to the right of the vertical center line of the blower. A **LEFT HAND** exists when the drive shaft is to the left of the vertical center line of the blower.

INSTRUCTIONS FOR ORDERING REPAIR PARTS

For pricing and ordering information, contact your nearest **AUTHORIZED FACTORY DISTRIBUTOR**.

When ordering parts, specify Blower **MODEL** and **SERIAL NUMBER** (see nameplate on unit).

Rely upon the knowledge and experience of your **AUTHORIZED DISTRIBUTOR** and let them assist you in making the proper parts selection for your blower.



4400 Morris Park Drive
Charlotte, NC 28227
Phone: (704) 545-3922

Web: www.suncopowder.com
Email: info@suncopowder.com
Fax: (704) 545-8345

FOREWORD

Sutorbilt® blowers are the result of advanced engineering and skilled manufacturing. To be assured of receiving maximum service from this machine the owner must exercise care in its operation and maintenance. This book is written to give the operator and maintenance department essential information for day-to-day operation, maintenance and adjustment. Careful adherence to these instructions will result in economical operation and minimum downtime.

DANGER

Danger is used to indicate the presence of a hazard which will cause severe personal injury, death, or substantial property damage if the warning is ignored.

WARNING

Warning is used to indicate the presence of a hazard which can cause severe personal injury, death, or substantial property damage if the warning is ignored.

CAUTION

Caution is used to indicate the presence of a hazard which will or can cause minor personal injury or property damage if the warning is ignored.

NOTICE

Notice is used to notify people of installation, operation or maintenance information which is important but not hazard-related.

For Part List information, see:

Gear Diameter	Parts List
10"	SB-7-528
12"	SB-7-529
14"	SB-7-530
16"	SB-7-531
18"	SB-7-532
20"	SB-7-533
22"	SB-7-534

SAFETY PRECAUTIONS

Safety is everybody's business and is based on your use of good common sense. All situations or circumstances cannot always be predicted and covered by established rules. Therefore, use your past experience, watch out for safety hazards and be cautious. Some general safety precautions are given below:

DANGER

Failure to observe these notices could result in injury to or death of personnel.

- **Keep fingers and clothing away from blower inlet and discharge ports, revolving belts, sheaves, drive coupling, etc.**
- **Do not use the air discharge from this unit for breathing - not suitable for human consumption.**
- **Do not loosen or remove the oil filler plug, drain plugs, covers, or break any connections, etc., in the blower air or oil system until the unit is shut down and the air pressure has been relieved.**
- **Electrical shock can and may be fatal.**
- **Blower unit must be grounded in accordance with the National Electrical Code.**
- **Open main disconnect switch, tag and lockout before working on the control.**
- **Disconnect the blower unit from its power source, tag and lockout before working on the unit - the machine may be automatically controlled and may start at any time.**

WARNING

Failure to observe these notices could result in damage to equipment.

- **Stop the unit if any repairs or adjustments on or around the blower are required.**
- **Disconnect the blower unit from its power source, tag and lockout before working on the unit - the machine may be automatically controlled and may start at any time.**
- **Do not exceed the rated maximum speed shown on the nameplate.**
- **Do not operate unit if safety devices are not operating properly. Check periodically. Never bypass safety devices.**

TABLE OF CONTENTS

	Page
Maintain Blower Reliability and Performance with Genuine Gardner Denver Parts and Support Services	i
Instructions for Ordering Repair Parts	i
Instructions for Determining Blower Configuration	i
Foreword	ii
Safety Precautions	iii
Index	v
List of Illustrations	vi
Introduction, Your Key To Trouble Free Service	1
Operating Principles	1
Section 1, Equipment Check	2
Section 2, Installation	3
Section 3, Pre-Start	6
Section 4, Operation	9
Section 5, Maintenance	15
Section 6, Repair and Replacement	19
Warranty	Last Page

INDEX

<p>AEON PD Food Grade Lubricant Part Numbers . . . 6</p> <p>AEON PD Lubricant Part Numbers 6</p> <p>Air Filters, Start-Up Screens and Test Coupon . . . 8</p> <p>Bearing and Seal Replacement 20</p> <p>Blower Startup Checklist 12</p> <p>Checklist, Blower Startup 12</p> <p>Drive End 21</p> <p>Drive Installation 4</p> <p>EQUIPMENT CHECK, SECTION 1 2</p> <p>Filter-Silencers and Air Filters 8</p> <p>Force Feed Lubrication 6</p> <p>Foreword ii</p> <p>Foundation 3</p> <p>Gear End 20</p> <p>Gear Inspection 15</p> <p>Impeller Clearances, Determining 16</p> <p>Impeller Clearances, Resetting 17</p> <p>Impeller Inspection 15</p> <p>Inspection</p> <p style="padding-left: 20px;">Gear 15</p> <p style="padding-left: 20px;">Impeller 15</p> <p>INSTALLATION, SECTION 2 3</p> <p>Installation, Location 3</p> <p>Installation, Drive 4</p> <p>Limitations, Operation 9</p> <p>Lip Type Oil Seal 21</p> <p>Location, Installation 3</p> <p>Lubrication 6</p> <p style="padding-left: 20px;">Force Feed 6</p> <p style="padding-left: 20px;">Splash 6</p>	<p>Lubrication Service 6</p> <p>MAINTENANCE, SECTION 5 15</p> <p style="padding-left: 20px;">Mechanical Seal 21</p> <p style="padding-left: 20px;">Mounting Configurations 3</p> <p style="padding-left: 20px;">Operating Principles 1</p> <p>OPERATION, SECTION 4 9</p> <p style="padding-left: 20px;">Operation, Routine 9</p> <p style="padding-left: 20px;">Piping 4</p> <p>PRE-START, SECTION 3 6</p> <p style="padding-left: 20px;">Protective Materials, Removing 2</p> <p style="padding-left: 20px;">Removing Protective Materials 2</p> <p style="padding-left: 20px;">Repair 15</p> <p>REPAIR & REPLACEMENT, SECTION 6 19</p> <p style="padding-left: 20px;">Repair Parts, Ordering Instructions i</p> <p style="padding-left: 20px;">Routine Operation 9</p> <p>Safety Precautions iii, 13</p> <p>Seal</p> <p style="padding-left: 20px;">Lip Type Oil 21</p> <p style="padding-left: 20px;">Mechanical 21</p> <p style="padding-left: 20px;">Shaft Replacement 17</p> <p style="padding-left: 20px;">Shut Down 10</p> <p style="padding-left: 20px;">Splash-Lubrication 6</p> <p style="padding-left: 20px;">Startup Checklist, Blower 12</p> <p style="padding-left: 20px;">Storage 2</p> <p style="padding-left: 20px;">Timing 15</p> <p style="padding-left: 20px;">Timing Gear and Hub Removal 19</p> <p style="padding-left: 20px;">Trouble Shooting 13, 14</p> <p>Warranty Last Page</p> <p>YOUR KEY TO TROUBLE FREE SERVICE, INTRODUCTION 1</p>
--	---

LIST OF ILLUSTRATIONS

Figure #	Description	Page
Figure 1	Operating Principles	1
Figure 2	Lifting the Blower	3
Figure 3	Blower Mounting Configuration	3
Figure 4	Belt Drive Overhung Load Limitations	5
Figure 5	Lubrication Location	6
Figure 6	Approximate Oil Sump Capacities	7
Figure 7	Lubrication Recommendation	8
Figure 8	Maximum Operating Limitations	11
Figure 9	Location of Timing Gear Bolts	15
Figure 10	Gear End Clearance	16
Figure 11	Torque Requirements - Timing Gear Cap Screws	16
Figure 12	Impeller Lobe Clearances	16
Figure 13	Torque Requirements - Gear End Shaft Assembly	17
Figure 14	Timing Gear and Hub Removal	19
Figure 15	Bearing Cartridge Removal	20
Figure 16	Mechanical Seal Installation	20

INTRODUCTION

YOUR KEY TO TROUBLE FREE SERVICE

Thank you for investing in Sutorbilt quality. The Sutorbilt reputation for rugged dependability has been earned by over 50 years of service in demanding, industrial operations where downtime cannot be tolerated and efficient blower performance is expected.

Your Sutorbilt blower is a precision engineered blower that has been carefully manufactured and thoroughly tested at the state-of-the-art Gardner Denver Blower Factory in Sedalia, Missouri.

As with other precision machinery, there are several relatively simple installation, operation and maintenance procedures that you must observe to assure optimum blower performance. There is no guesswork in the manufacture of your highly advanced Sutorbilt blower and there must be none in preparing the blower to get the job done in the field.

The purpose of this manual is to help you properly install, operate and maintain your Sutorbilt blower. It is essential that you review all sections of this manual in preparation for installing your blower. Follow the instructions carefully and you will be rewarded with trouble-free Sutorbilt service . . . year in and year out.

OPERATING PRINCIPLES - The 8000 Series rotary blowers are the positive displacement type with two figure-eight shaped impellers rotating in opposite directions inside the casing. As each lobe of an impeller passes the blower inlet, it traps a quantity of air equal to exactly one-fourth the displacement of the blower. This entrapment air is forced around the case to the blower outlet. Timing gears accurately position the impellers in relation to each other to maintain the minute clearances so vital to the high volumetric efficiency of the rotary positive blower. See FIGURE 1.

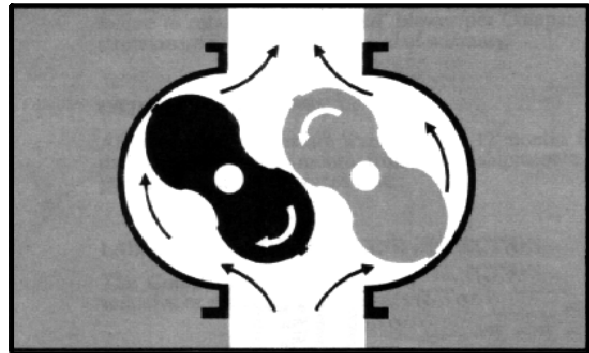

FIGURE 1 - OPERATING PRINCIPLES

IMPORTANT SUTORBILT TELEPHONE NUMBERS

YOUR AUTHORIZED SUTORBILT DISTRIBUTOR

NAME: _____
TELEPHONE: _____
FAX: _____
CONTACT: _____

THANKS . . . FOR THE PRIVILEGE OF SERVING YOU WITH DEPENDABLE SUTORBILT QUALITY.

SECTION 1 EQUIPMENT CHECK

Before uncrating, check the packing slip carefully to be sure all the parts have been received. All accessories are listed as separate items on the packing slip, and small important accessories such as relief valves can be overlooked or lost. After every item on the packing slip has been checked off, uncrate carefully. Register a claim with the carrier for lost or damaged equipment.

WARNING

Customers are cautioned to provide adequate protection, warning and safety equipment necessary to protect personnel against hazards involved in installation and operation of this equipment in the system or facility.

STORAGE

Your Sutorbilt Blower was packaged at the factory with adequate protection to permit normal storage for up to six (6) months.

If the unit is to be stored under adverse conditions or for extended periods of time, the following additional measures should be taken to prevent damage.

1. Store the blower in a clean, dry, heated (if possible) area.
2. Make certain inlet and discharge air ports are tightly covered to prevent foreign material from entering the air box.
3. All exposed, non-painted surfaces should be protected against rust and corrosion.
4. Provide adequate protection to avoid accidental mechanical damage.
5. In high humidity or corrosive environments, additional measures may be required to prevent rusting of the blower internal surfaces.
6. To prevent rusting of gears, bearings, etc., the oil reservoirs may be filled with normal operating oil.

CAUTION

Before running the blower, drain the oil and replace to the proper operating level with clean, fresh lubricant.

7. Rotate the blower shaft (10 to 25 turns) monthly during storage. Inspect the blower shaft (near the shaft seal area) monthly and spray with rust inhibitor if needed.
8. For long term storage (over six (6) months), contact Gardner Denver Customer Service for recommendations.

REMOVING PROTECTIVE MATERIALS

The shaft extension is protected with rust inhibitor which can be removed with any standard safety solvent.

CAUTION

Follow the safety directions of the safety solvent manufacturer.

Blower inlet and outlet are temporarily capped to keep out dirt and other contaminants during shipment. These covers must be removed before start-up.

The internal surfaces of all Sutorbilt units are mist sprayed with a rust preventative to protect the machine during shipment. Remove this film upon initial startup, using any commercial safety solvent.

Position the blower so that the inlet and discharge connections are in the vertical position (vertical airflow). On vertically mounted units, it will be necessary to lay the unit on its side supporting the ends of the unit so as not to restrict the port on the bottom side. Place a shallow pan on the under side of the unit. With the blower disconnected from power, spray the solvent in the top port, rotating the impellers by spinning the shaft manually. Continue this procedure until the unit is visibly clean.

WARNING

Rotating components will cause severe injury in case of personal contact. Keep hands away from blower inlet and discharge ports.

SECTION 2 INSTALLATION

LOCATION

If possible, install the blower in a well lit, clean, dry place with plenty of room for inspection and maintenance.

FOUNDATIONS

For permanent installations we recommend concrete foundations be provided, and the equipment should be grouted to the concrete. It is necessary that a suitable base be used, such as a steel combination base under blower and motor, or a separate sole plate under each. Before grouting, equipment must be leveled, free of all strains, and anchored so no movement will occur during setting of grout. After grout has completely hardened, a recheck is necessary to compensate for shrinkage, etc. If required, add shims under blower feet after final tightening of foundation anchor bolts to remove strain from the blower housing.

Where jack screws or wedges are used during grouting, they must be backed off or removed before final tightening of anchor bolts.

Where a concrete foundation is not feasible, care must be taken to insure that equipment is firmly anchored to adequate structural members.

Refer to grouting instructions.

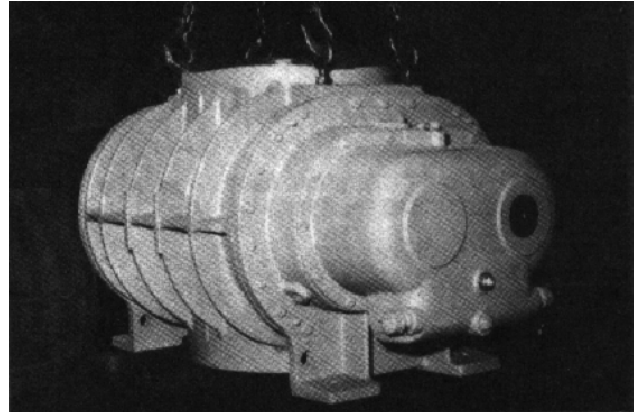

FIGURE 2 - LIFTING THE BLOWER

LIFTING AND HANDLING

Reasonable care should be taken during unloading and moving to insure against undue strain on the blower.

Eye bolts and lifting lugs are designed to support the weight of the blower only. They are not intended to be used to lift packages or components. See FIGURE 2.

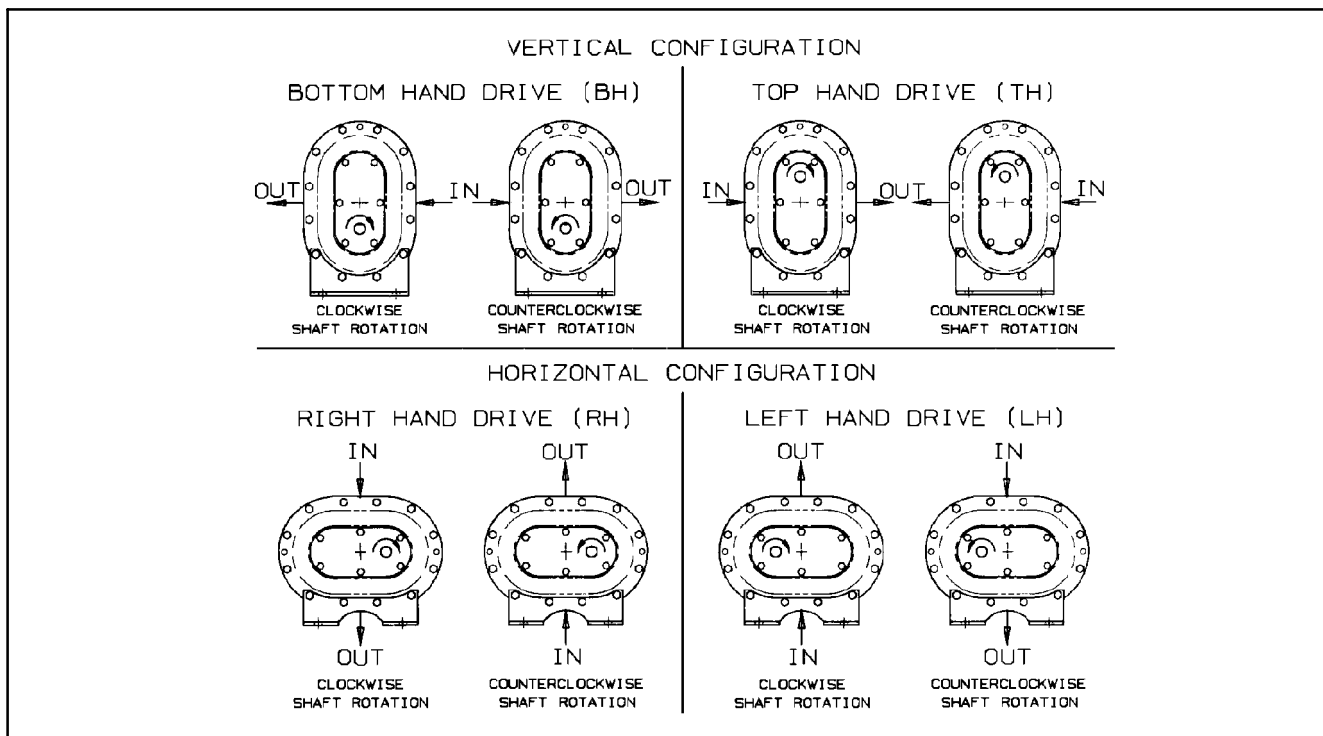

FIGURE 3 - BLOWER MOUNTING CONFIGURATIONS

Protective covers and rust preventatives should be left in place until just prior to installation.

DRIVE INSTALLATION

Large blowers are generally driven by a coupling. On the direct connected units, adjustments and lubrication of couplings to the specifications of the coupling manufacturer are very important. When mounted drives are supplied from the factory, proper alignment has been established before shipment. However, during shipping, handling and installation, it is likely that the alignment has been disturbed and final adjustment must be made before startup. To reduce vibration, the coupling must be aligned to 0.003"/0.005" for both parallel and angular alignment.

 WARNING
Overtightening belts leads to heavy bearing loads and premature failure.

When selecting a V-belt drive, check to be sure the shaft overhung load limitation is not exceeded. Refer to FIGURE 4, page 5, for overhung load calculations and limitations.

Belt drives must be carefully aligned. Motor and blower pulleys must be parallel to each other and in the same plane within 1/32 inch. Belt tension should be carefully adjusted to the belt manufacturer's recommendation using a belt tension gauge. Check tension frequently during the first day of operation.

 WARNING
Exceeding overhung load limitations leads to unwarrantable premature bearing failure and shaft breakage.

The location of the sheave on the blower shaft greatly affects the stress in the shaft. The optimum blower sheave positioning is as close as possible to the blower drive cover, not to exceed dimension "C" in Drive Shaft Illustration, FIGURE 4, page 5.

The calculated shaft moment must not exceed the maximum allowable moment listed in Maximum Allow-

able Moment Chart, FIGURE 4, page 5. If the calculated shaft moment exceeds the maximum allowable moment:

- Increase Sheave Diameters to Reduce Belt Pull
- Use Jackshaft Drive
- Use Direct Coupled or Gearbox Drive

To calculate shaft moment for a given V-Belt Drive Arrangement:

1. Use the formula for Calculation of Belt Pull, FIGURE 4, page 5, to calculate belt pull. Refer to Arc of Contact Factor Chart, FIGURE 4, page 5.
2. Insert the calculated belt pull into the formula for Calculation of Shaft Moment, FIGURE 4, page 5, to arrive at the calculated shaft moment.

PIPING

Inlet and discharge connections on all blowers are large enough to handle maximum volume with minimum friction loss. Reducing the pipe diameter on either inlet or discharge will only create additional line loss and increase the overall pressure differential, causing increased power and temperature rise.

Excessive weight of piping and fittings will cause internal misalignment and premature wear. Never allow the blower to carry the weight of the pipe. If possible, a spool or sleeve-type expansion joint should be installed between the unit and the piping. Where a flexible connection is not practical, the weight of the rigid connection must be separately supported, and provisions must be made for thermal growth.

All system piping must be cleaned internally before connecting to the blower.

 WARNING
Sutorbilt blowers are shipped dry from the factory. Do not attempt to operate the blower before following proper lubrication instructions. Permanent damage to the gears, bearings and seals will occur.

Gear Diameter (Inches)	Dimensions (Inches)			Maximum Allowable Moment	
	A	B	C (Max)	(LB-IN)	Kg M
10	11.50	3.50	.75	16065	185,1
12	12.81	3.81	.75	25789	297,1
14	14.19	4.19	.75	38824	447,3
16	15.38	4.38	.75	65280	752,1
18	17.00	5.00	.75	91975	1059,7
20	18.75	5.25	.75	118673	1367,2
22	20.19	5.19	.75	137269	1581,5

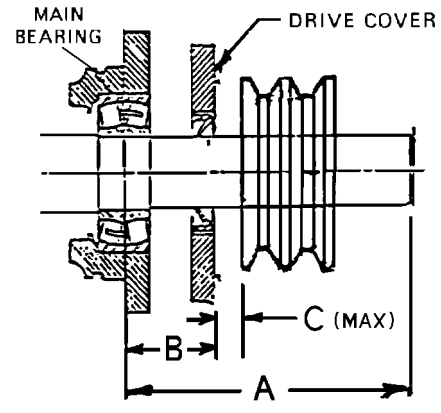

MAXIMUM ALLOWABLE MOMENT

DRIVE SHAFT ILLUSTRATION

Z	Ac	Z	Ac	Z	Ac	Z	Ac	Z	Ac	Z	Ac
0.000	1.000	0.250	0.966	0.500	0.926	0.750	0.879	1.000	0.823	1.250	0.751
0.025	0.997	0.275	0.962	0.525	0.922	0.775	0.874	1.025	0.816	1.275	0.742
0.050	0.994	0.300	0.958	0.550	0.917	0.800	0.869	1.050	0.810	1.300	0.734
0.075	0.990	0.325	0.954	0.575	0.913	0.825	0.864	1.075	0.803	1.325	0.725
0.100	0.987	0.350	0.951	0.600	0.908	0.850	0.858	1.100	0.796	1.350	0.716
0.125	0.983	0.375	0.947	0.625	0.904	0.875	0.852	1.125	0.789	1.375	0.706
0.150	0.980	0.400	0.943	0.650	0.899	0.900	0.847	1.150	0.782	1.400	0.697
0.175	0.977	0.425	0.939	0.675	0.894	0.925	0.841	1.175	0.774	1.425	0.687
0.200	0.973	0.450	0.935	0.700	0.889	0.950	0.835	1.200	0.767		
0.225	0.969	0.475	0.930	0.725	0.884	0.975	0.829	1.225	0.759		

ARC OF CONTACT FACTORS

$$\text{Belt Pull} = \left[\frac{2.5 - A_c}{A_c} \right] \left[\frac{125954 \times H_p \times S.F.}{D \times \text{RPM}} \right]$$

- Key:
- A_c = Arc of Contact Factor (Refer to Arc of Contact Factors Chart above)
 - H_p = Blower Horsepower for Operating Conditions
 - S.F. = Actual Drive Service Factor
 - D = Blower Sheave Pitch Diameter in Inches
 - RPM = Blower Sheave Speed
 - Z = $\frac{\text{Large Sheave Pitch Diameter (in)} - \text{Small Sheave Pitch Diameter (in)}}{\text{Sheave Center Distance (in)}}$

CALCULATION OF BELT PULL

$$\text{Shaft Moment (LB-IN)} = \text{Belt Pull} \times \left[B + C + \left(\frac{\text{Sheave Width}}{2} \right) \right]$$

CALCULATION OF SHAFT MOMENT

FIGURE 4 - BELT DRIVE OVERHUNG LOAD CALCULATIONS

SECTION 3 PRE-START

LUBRICATION

Force Feed Lubrication (FFL) - Timing gears and bearings are lubricated by a pressure system which features large diameter piping. A reversible oil pump brings oil from an oversize sump which is large enough to eliminate the need for an oil cooler at discharge temperatures up to 325° F. (When not required, oil coolers are available as optional equipment). An oil strainer is located in the sump.

Splash-Lubrication - The gear end and drive end of the blower are lubricated by the splash method. Oil is picked up from the sump and thrown out by the gears in the gear end and by an oil slinger on the drive end. Both gears and bearings are lubricated in this manner.

Approximate oil sump capacities in U.S. gallons are listed in FIGURE 6, page 7.

The factory recommended lubricant is AEON PD Synthetic Lubricant. AEON PD is formulated especially for positive displacement blowers to provide maximum protection at any temperature. One filling of AEON PD will last a minimum of 4 times longer than a premium mineral oil, depending on actual operating conditions. AEON PD contains a special additive package designed for greater rust and corrosion protection.

Order AEON PD from your Sutorbilt Distributor or call Gardner Denver Customer Service to find your nearest distributor. A food-grade formula is also available. Part numbers are listed below.

AEON PD Lubricant

Description	Part Number
1 Quart	28G23
Case/12 Quarts	28G24
5 Gallon Pail	28G25
55 Gallon Drum	28G28

AEON PD Food Grade Lubricant

Description	Part Number
1 Quart	28H97
Case/12 Quarts	28H98
5 Gallon Pail	28H99
55 Gallon Drum	28H100

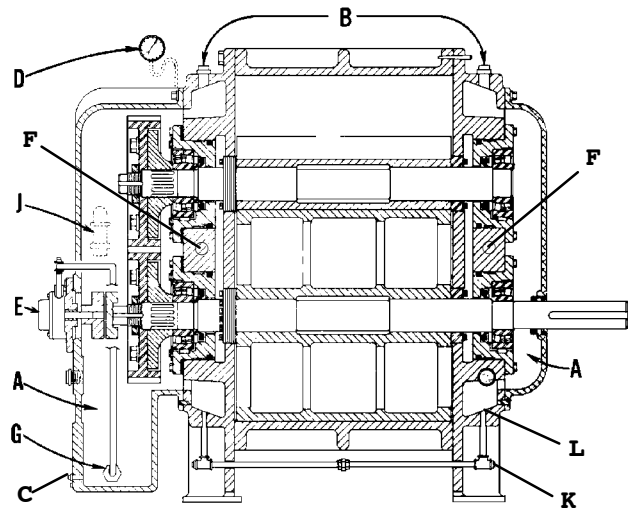

FIGURE 5 - LUBRICATION LOCATION

NOTICE

Machines are shipped without oil in the sumps. Do not operate before adding lubricant.

LUBRICATION INSTRUCTIONS

Remove the vented fill (oil breather) caps (B) in FIGURE 5. Do not remove any pipe plugs on top of the headplates. Fill sumps through the breather cap standpipes. When filling housing with oil, stop filling as soon as the oil appears in the sight glass and allow a few minutes for the level to stabilize. Once oil level has stabilized, add or drain as necessary to adjust the oil level to the midpoint of the sight glass. Be sure fill caps are secured in place once proper oil level is obtained.

Force-Feed lubricated blowers have a common line between oil sumps and oil can be added at either the drive end or gear end. Splash-lubricated blowers have separate oil sumps and oil must be added at both the drive end and gear end.

Check the oil level after the initial operation. **Maintain oil level at the midpoint of the sight glass when the blower is not operating.** It may be necessary to add oil to maintain this level as oil will migrate to fill the lubrication passages.

Gear Diameter (in)	Vertical Configuration				Horizontal Configuration			
	Splash Lubrication			Force-Feed Lubrication	Splash Lubrication			Force-Feed Lubrication
	Drive End	Gear End	Total	Total	Drive End	Gear End	Total	Total
10	0.62	2.63	3.25	4.0	1.75	4.25	6	6.75
12	0.75	2.75	3.5	4.25	2.25	8.5	10.75	11.5
14	1.25	5.25	6.5	7.5	2	9.25	11.25	12.25
16	1.75	7.5	9.25	10.5	2.25	9.5	11.75	13.0
18	1.5	7	8.5	10.0	3	9.75	12.75	14.25
20	2.25	9	11.25	12.75	3.25	15.5	18.75	20.25
22	2.75	10.75	13.5	15.25	8.5	25.75	34.25	36.0

FIGURE 6 - APPROXIMATE OIL SUMP CAPACITIES IN U.S. GALLONS

Force Feed Lubrication: After one minute of operation, there should be a register of pressure in the gauge (D) FIGURE 5, page 6. IF there is none, prime the oil pump (E) FIGURE 5, page 6.

 WARNING
<p>Do not overfill as this will tend to cause excessive heating of the gears and may damage the unit.</p>

AEON PD Synthetic Lubricant should be drained after 6000 hours of operation. Re-fill with fresh AEON PD oil. If mineral oil is used, perform the above oil-change maintenance every 1500 hours. Recommended service intervals are for normal blower operating conditions. Severe operating conditions may warrant more frequent oil changes. Laboratory analysis of lubricant should be used to help determine the optimum oil change interval.

Force Feed Lubrication: Oil should be drained at the drive headplate (K) and gear sump (C) in FIGURE 5, page 6. The mesh-type strainer (G) FIGURE 5, located in the sump, should be cleaned each time the oil is changed. There are two perforated brass screens located at the oil line connection to the headplates (F) FIGURE 5. These should be removed and cleaned or replaced as necessary. Oil pressure should be in the range of 10 to 15 psi.

Oil pressure is controlled by the relief valve (J), FIGURE 5, page 6, in the bypass line from the pump to the oil sump. If it is necessary to change the pressure adjustment, remove lower cap and gasket from the relief valve. Loosen the locking nut and turn the adjusting screw clockwise to increase, and counter-clockwise to decrease the oil pressure. Tighten locknut and replace gasket and cap. Mount the oil pressure gauge (D), FIGURE 5, on a vibration free panel to prevent gauge damage and inaccurate reading.

Splash lubrication: Oil should be drained at the Drive Headplate (L) and Gear Sump (C) in FIGURE 5, page 6.

For the best performance and equipment protection, use AEON PD Synthetic Lubricant, which has been specifically formulated for positive displacement blowers.

If you choose not to use AEON PD Synthetic Blower Lubricant, select an oil with rust and oxidation inhibitors, anti-foam additives, and the viscosity listed in FIGURE 7, page 8. Do not use an oil that contains EP additives.

You will need to flush the oil whenever a change is made from one type of oil to another. Drain the current lubricant as thoroughly as possible. Refill with new lubricant. Fill to the normal level of the blower, which is the middle of the sight glass when the machine is not operating. Run the blower for one hour. Shut off the blower and drain the lubricant completely. Refill the blower again with the new lubricant.

AIR FILTERS, START-UP SCREENS AND TEST COUPON

⚠ WARNING

If used on Wet Vacuum, servicing the air filters is one of the most important maintenance operations to be performed to insure long pump life.

1. Filters in the system should be checked and replaced periodically.
2. Start-up screens are recommended to be installed at the inlet side of the pump.

3. Test coupon is recommended downstream of the last pump to monitor any corrosion or scaling in the system.

In all cases refer to the filter manufacturer's service instructions. Due to the many types of filters, it is not practical to give specific instructions covering all models.

NOTICE

No matter what type of filter is used, always make sure all seats, gaskets, clamps and hose connections on the filter and inlet line are absolutely air tight. Each time the filter is serviced, inspect interior of the pump for dirt.

Blower Discharge Temperature	Oil Grade ISO	Oil Viscosity SUS @ 100° F
32° to 100° F (0° to 38° C)	100	465
100° to 225° F (38° to 105° C)	150	700
225° to 300° F (105° to 149° C)	220	1000
Over 300° F (149° C)	*	*

* The oil viscosity must be 70 SUS minimum at discharge temperature minus 50° F.

FIGURE 7 - LUBRICATION RECOMMENDATION

SECTION 4 OPERATION

Future operating problems can be avoided if proper precautions are observed when the equipment is first put into service.

Before starting under power, the blower should be turned over by hand to make certain there is no binding, or internal contact.

Each size blower has limits on pressure differential, running speed, and discharge temperature which must not be exceeded. For information regarding limitations, refer to "Maximum Operating Limitations," FIGURE 8, page 11.

WARNING

Operating beyond the specified operating limitations will result in damage to the unit.

It is important that the pressures and temperatures are measured directly at the ports of the blower to avoid error that may be caused by intervening pipe runs, fittings, etc.

Relief valves must be used to protect against excessive pressure or vacuum conditions. These valves should be tested at initial startup to be sure they are adjusted to relieve at or below the maximum pressure differential rating of the blower.

NOTICE

Relief valves should be placed as close as possible to the blower inlet or discharge.

In some instances, pressure may be relieved at a lower level than the blower maximum in order to protect the motor and/or the system components.

LIMITATIONS

For information regarding limitations, refer to "Maximum Operating Limitations," FIGURE 8, page 11.

WARNING

Do not operate equipment without adequate silencing devices installed since high noise level may cause hearing damage. (Reference OSHA standards.)

After the unit has been started, the load should be applied gradually. A blow-off valve for unloaded starting is recommended.

The first few minutes of operation are the most critical, in so far as potential problems are concerned, so all equipment should be observed closely for excessive heat, noise or vibration during this period. Speeds, pressures, temperatures, vacuums and other operating conditions should be checked to insure that specified limits are not exceeded. See FIGURE 8, page 11.

ROUTINE OPERATION

Since the unit is a positive displacement type, the volume flow is fixed for constant speed so no regulation can be achieved by restricting the pipe or adjusting the valves. Excess air flow may be discharged through a relief valve or blow-off to atmosphere. Volume flow is essentially proportional to the speed and this offers a method of flow adjustment with V-belt driven machines.

Although these units are extremely rugged and are designed with adequate factors of safety, it is possible to cause serious damage by exceeding the manufacturer's limits.

Periodically the gauges, instruments, and safety devices used to monitor the blower should be checked for calibration and functioning.

NOTICE

Full rated pressure is full pressure differential from the inlet flange to the discharge flange.



CAUTION

Precaution should be taken to insure that the unit cannot be started accidentally and cause injury to personnel or damage to equipment.

SHUT DOWN

The blower should be unloaded before shut down. Consideration should be given to possible backflow and reverse rotation of the equipment as a result of pressure on the discharge side of the unit. A check valve is recommended.

If the unit is to be shut down for extended periods of time, it may be desirable to take some steps to prevent rust forming inside the casing. Condensation, gas vapors, or seal water can close up internal clearances and cause the unit to bind. Injection of oil or other rust retardant will help to prevent this problem.

MAXIMUM OPERATING LIMITATIONS

SIZE	8000 Series RPM	PRESSURE		VACUUM		SIZE	8000 Series RPM	PRESSURE		VACUUM	
		PSI	M BAR	IN.HG	mm HG			PSI	M BAR	IN.HG	mm HG
1008	1800	20.0	1379	18	457	1818	1000	20.0	1379	18	457
1011	1800	20.0	1379	18	457	1821	1000	20.0	1379	18	457
1013	1800	18.9	1303	18	457	1824	1000	18.8	1297	18	457
1016	1800	15.6	1076	18	457	1830	1000	15.0	1034	18	457
1018	1800	13.9	959	18	457	1833	1000	13.4	924	18	457
1021	1800	13.3	917	18	457	1836	1000	12.5	862	18	457
1024	1800	10.4	717	18	457	1842	1000	10.7	738	18	457
1030	1800	8.3	572	16	406	1845	1000	10.0	690	18	457
						1848	1000	9.4	648	18	457
						1854	1000	8.3	572	16	406
1213	1500	20.0	1379	18	457	2020	900	20.0	1379	18	457
1216	1500	18.8	1297	18	457	2024	900	20.0	1379	18	457
1218	1500	16.2	1117	18	457	2031	900	16.1	1110	18	457
1220	1500	15.0	1034	18	457	2034	900	14.7	1014	18	457
1223	1500	13.0	897	18	457	2037	900	13.3	917	18	457
1226	1500	11.5	793	18	457	2040	900	12.5	862	18	457
1230	1500	10.0	690	18	457	2048	900	10.4	717	18	457
1236	1500	8.3	572	16	406	2055	900	9.1	628	18	457
						2060	900	8.3	572	16	406
1415	1285	20.0	1379	18	457	2224	800	20.0	1379	18	457
1419	1285	18.4	1269	18	457	2231	800	17.5	1207	18	457
1421	1285	16.7	1152	18	457	2236	800	15.3	1055	18	457
1423	1285	15.2	1048	18	457	2242	800	13.1	903	18	457
1426	1285	13.5	931	18	457	2248	800	11.5	793	18	457
1431	1285	11.3	779	18	457	2254	800	10.2	703	18	457
1437	1285	9.5	655	18	457	2260	800	9.2	634	18	457
1442	1285	8.3	572	16	406	2266	800	8.3	572	16	406
1617	1125	20.0	1379	18	457						
1623	1125	17.4	1200	18	457						
1626	1125	15.4	1062	18	457						
1630	1125	13.3	917	18	457						
1636	1125	11.1	766	18	457						
1640	1125	10.0	690	18	457						
1643	1125	9.3	641	18	457						
1648	1125	8.3	572	16	406						

DO NOT EXCEED THESE LIMITS

 **CAUTION**

The maximum speed at which an 8000 series unit can be safely operated varies as listed on the above chart. Be certain of the size and series before applying these maximum speeds.

NOTICE

Blower speed, line losses, elevation, and increased inlet temperatures will affect the maximum operating limitations.

FIGURE 8 - MAXIMUM OPERATING LIMITATIONS

BLOWER STARTUP CHECKLIST

This startup procedure should be followed during the initial installation and after any shutdown periods or after the blower has been worked on or moved to a new location. It is suggested that the steps be followed in sequence and checked off (✓) in the boxes provided.

1. Check the unit and all piping for foreign material and clean if required.
2. Check the flatness of the feet and the alignment of the drive. Feet that are bolted down in a bind can cause case distortion and internal rubbing. Misaligned V-drives can cause the impellers to rub against the headplates and cause a reduction in the volumetric efficiency of the unit. Misaligned couplings can ruin bearings.
3. If blower is V-belt driven, check the belt tension and alignment. Over-tensioned belts create heavy bearing loads which leads to premature failure.
4. Be sure adequate drive guards are in place to protect the operator from severe personal injury from incidental contact.
5. Check the unit for proper lubrication. Proper oil level cannot be overemphasized. Too little oil will ruin bearings and gears. Too much oil will cause overheating and can ruin gears and cause other damage.
6. With motor locked out, turn the drive shaft by hand to be certain the impellers do not bind.
7. "Jog" the unit with the motor a few times to check rotation and to be certain it turns freely and smoothly.
8. The internal surfaces of all Sutorbilt units are mist sprayed with a rust preventive to protect the machine during the shipping and installation period. This film should be removed upon initial start-up.
9. Start the unit and operate 15 minutes at no load. During this time, check for hot spots and other indications of interference.
10. Apply the load and observe the operation of the unit for one hour. Check frequently during the first day of operation.
11. If malfunctions occur, do not continue to operate. Problems such as knocking impellers can cause serious damage if the unit is operated without correction.

SAFETY PRECAUTIONS

1. Do not operate blower with open inlet or outlet port.
2. Do not exceed specified vacuum or pressure limitations.
3. Do not operate above or below recommended blower speed range.
4. Blower is not to be used where non-sparking equipment is specified.
5. Do not operate without belt guard or coupling shield.

 WARNING
Do not exceed sheave or coupling manufacturers' rim speed limit.

6. The blower and blower discharge piping may be extremely hot and can cause skin burns on contact.

TROUBLE SHOOTING

No matter how well the equipment is designed and manufactured, there may be times when servicing will be required due to normal wear, the need for adjustment, or various external causes. Whenever equip-

ment needs attention, the operator or repairman should be able to locate the cause and correct the trouble quickly. The Trouble Shooting Chart below is provided to assist the mechanic in those respects.

PROBLEM	POSSIBLE CAUSES	SOLUTION
Knocking	<ol style="list-style-type: none"> 1. Unit out of time. 2. Distortion due to improper mounting or pipe strains. 3. Excessive pressure differential. 4. Worn gears. 5. Worn bearings. 6. Worn bearing cartridges. 	<ol style="list-style-type: none"> 1. Retime impellers. 2. Check mounting alignment and relieve pipe strains. 3. Reduce to manufacturer's recommended pressure. Examine relief valve, re-set if necessary. 4. Replace timing gears. 5. Replace bearings. 6. Replace cartridges.
Excessive blower temperature.	<ol style="list-style-type: none"> 1. Too much oil in gear case. 2. Too low operating speed. 3. Clogged filter or muffler. 4. Excessive pressure differential. 5. Worn impeller clearances. 6. Internal contact. 	<ol style="list-style-type: none"> 1. Reduce oil level. 2. Increase blower speed. 3. Remove cause of obstruction. 4. Reduce pressure differential across the blower. 5. Replace impeller. 6. Correct clearances.
Impeller end or tip drag.	<ol style="list-style-type: none"> 1. Insufficient assembled clearances. 2. Case or frame distortion. 3. Excessive operating pressure. 4. Excessive operating temperature. 	<ol style="list-style-type: none"> 1. Correct clearances. 2. Check mounting and pipe strain. 3. Remove cause. 4. Remove cause.

TROUBLE SHOOTING (Continued)

PROBLEM	POSSIBLE CAUSES	SOLUTION
Lack of volume.	<ol style="list-style-type: none">1. Slipping belts.2. Worn clearances.	<ol style="list-style-type: none">1. Tighten belts.2. Re-establish proper clearances.
Excessive bearing or gear wear.	<ol style="list-style-type: none">1. Improper lubrication.	<ol style="list-style-type: none">1. Correct lubrication level. Replace dirty and/or improper oil.
Loss of oil.	<ol style="list-style-type: none">1. Headplate, gear case or drive cover vents plugged.2. Worn seal.	<ol style="list-style-type: none">1. Clean vents.2. Replace seals.
Lack of oil pressure.	<ol style="list-style-type: none">1. Dirty suction screen.2. Leak in suction line.3. Lubrication pump losing its prime.	<ol style="list-style-type: none">1. Clean suction screen.2. Repair leak.3. Reprime, by removing pipe plug and priming.

SECTION 5 MAINTENANCE

GEAR INSPECTION

Inspection of the timing gears may be accomplished by removing the gear case. Refer to FIGURE 9. Prior to removing the gear case the oil should be drained from the gear case sump. On units with force feed lubrication, remove the oil pump adaptor plate with the oil pump attached using the tapped jacking holes in the plate. After removing gear case flange bolts, the gear case may be removed. Be sure to support the gear case adequately while removing. Timing gears and gear end bearings are now exposed.

On completion of maintenance work, be certain that the oil pump and/or the gear case is returned to the original position. Use a paste type gasket compound on the mating surfaces. Always relubricate before starting.

IMPELLER INSPECTION

Series 8000 impellers can be inspected through the intake and discharge ports. This will reveal such conditions as out of time, excessive or insufficient clearances, abrasion of parts from passing foreign material, etc.

REPAIR

Assembly

WARNING

When rotation of the impellers is required in the assembly process, insure that all personnel are clear of lobes and gears to guard against serious injury.

TIMING

The impellers of the unit are separated by pre-determined minute clearances built into the machine. The timing of a unit is the setting of one impeller with respect to the other so they do not touch or knock during normal operation. The impellers are held 'in time' by timing gears which are bolted to a timing hub, which in turn is secured to the serrated impeller shaft by a lock washer and locknut. Retiming is necessary to restore proper impeller clearances after a unit has been jammed and the removal of the strain or foreign material does not stop the knocking or pounding during operation.

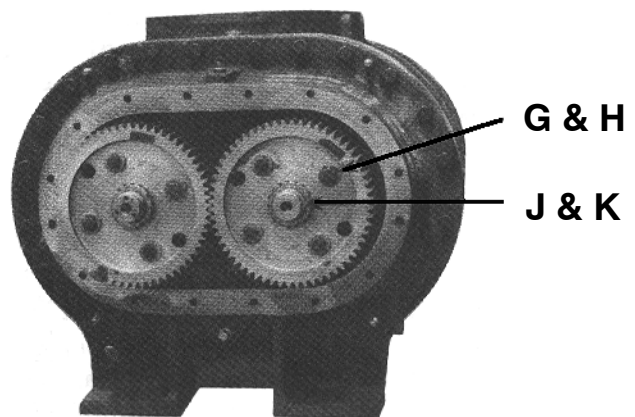
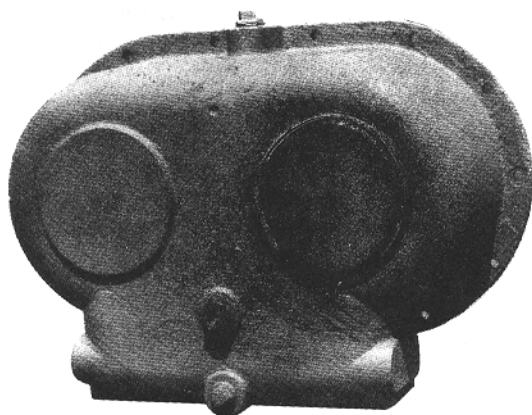

FIGURE 9 - LOCATION OF TIMING GEAR BOLTS

Gear End Clearance		
Gear Dia. In.	Min.	
	In.	CM
1008 to 1016	.006	.015
1018 to 1030	.007	.018
12	.007	.018
14	.008	.020
16	.009	.023
18	.009	.023
20	.010	.025
22	.011	.028

FIGURE 10 - GEAR END CLEARANCE

Torque Requirements Timing Gear Cap Screws		
Gear Dia.	Ft. Lbs. Torque	Nm Torque
10	70 - 100	95 - 136
12	160 - 225	217 - 305
14	210 - 350	285 - 475
16	250 - 350	339 - 475
18	250 - 350	339 - 475
20	400 - 500	542 - 678
22	400 - 600	542 - 813

FIGURE 11 - TORQUE REQUIREMENTS - TIMING GEAR CAP SCREWS

Determining Proper Impeller Clearances (FIGURE 12) - The clearances between impellers are measured at points 0-0 and c-c when the impellers are in the positions shown. Note that the impellers are shown viewed from the drive end of the blower; always face the drive shaft end when determining clearance. Select the illustration from the sketches which is applicable to your unit.

If the drive shaft is on the right side of centerline, it is a 'right hand' unit; if it is on the left, it is a 'left hand' unit. For vertical units: if the drive shaft is on the bottom side of the center line, it is a 'bottom hand' unit. Check above the drive shaft for a rotational arrow. If the arrow

appears, the unit is timed for rotation only in that direction. If no arrow appears, it is 'center timed' for rotation in either direction.

To determine total clearance, place the impellers in the 0-0 position. Measure the distance between 0-0 with a feeler gauge. Rotate the impellers 90° to position c-c and repeat the measurement between c-c. Add these figures together for total clearance.

To determine correct clearances for a unit originally timed for rotation in one direction only, return the impellers to position 0-0. Divide the total clearance figure into three parts. Two parts (2/3) will be the clearance setting between points 0-0 and the re-

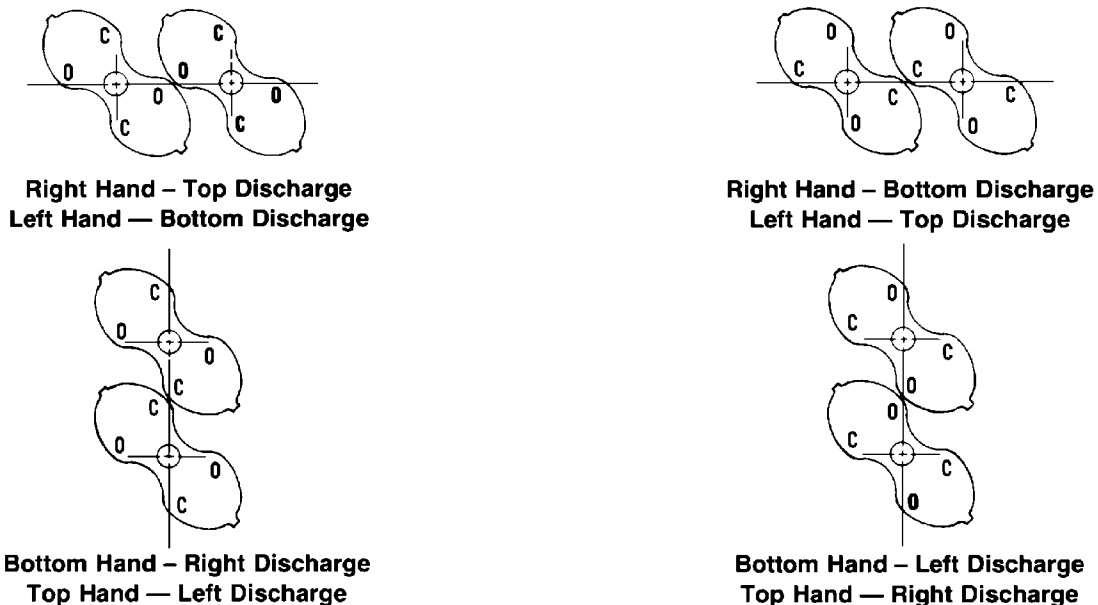

FIGURE 12 - IMPELLER LOBE CLEARANCES

maining part (1/3) will be set between points c-c. Blowers originally timed for rotation in either direction are retimed by dividing the total clearance evenly between points 0-0 and c-c.

RESETTING IMPELLER CLEARANCE

Impellers are held in time by gears which are bolted to a timing hub, which in turn is secured to the serrated impeller shaft by a locknut. The timing gear can be rotated in relation to the hub by loosening the cap screws. Because the cap screw holes in the gear are oversized, the gear will rotate - within limits - when the screws are loosened.

Refer to FIGURE 9, page 15, for the following instructions.

1. Remove the gear case.
2. To retime, remove the cap screws (G) and washers (H), loosen the locknut (J) and the lock washer (K) in one gear only.
3. Wedge the two impellers together against the exact amount of shim stock required to establish proper clearances as calculated in "Determining Proper Impeller Clearances," page 16.
4. Secure the gear in the new position with cap screws and washers (always reverse washers (H) when replacing) but do not tighten.
5. Rotate impellers by hand.
6. Recheck clearances. If proper timing has been re-established, tighten cap screws with a torque wrench. Refer to FIGURE 11, page 16, for correct torque values.
7. Tighten lock washer and locknut.
8. Obtain a piece of pipe of sufficient diameter to fit over the locknut and rest against the gear. Shock load the gear by striking the pipe with a sledge hammer, the retighten locknut. Repeat this procedure several times until all gear end components are drawn together and locknut is tight.
9. Check the end clearance before and after any work has been performed.

End Clearance - To check the gear end clearance, the locknut (J) (FIGURE 9, page 15) must be tight.

Torque Requirements Gear End Shaft Assembly		
Blower Size	Ft. Lbs. Torque	Nm Torque
10	30	41
12	50	68
14	50	68
16	115	155
18	115	155
20	225	304
22	330	446

FIGURE 13 - TORQUE REQUIREMENTS - GEAR END SHAFT ASSEMBLY

1. Remove two diametrically opposed timing bolts (G) and replace with long jack screws.
2. Tighten these against the bearing cartridge only enough to remove the axial play from the bearing.
3. Check the clearance inside the machine between the end of the impeller and the gear headplate. If the end clearance is less than that shown in the accompanying table, loosen the bearing cartridge (see "Bearing and Seal Replacement," page 20) and delete shims as required. Increase shims to reduce the clearance.
4. After completion of the work, replace the gear case and relubricate.

NOTICE

Follow Blower Startup Checklist on page 12 after every shutdown.

Shaft Replacement - One piece 4140 forged steel shafts are slip fitted through the impellers and bolted to them at the gear end. This advanced shaft design allows the diameter to be increased in the critical area between the impeller and gears without decreasing impeller strength with an enlarged bore, and avoids the use of the drive impeller to transmit power. By using a larger shaft at the gear end, torsional deflection of the shafts between timing gears and impellers is greatly reduced; therefore, increased pressure and horsepower ratings can be allowed with safety. The shafts can be removed from the impellers without removing

the headplates from the case. One piece shafts permit normal working loads for V-belt drives without the addition of outboard bearings.

In rare instances, shaft replacement might be necessary. Although removal is somewhat involved, it is fairly simple if the following procedure is adhered to.

1. Remove any obstructing oil lines from both ends of the unit.
2. Remove the gear case (see "Gear Inspection," page 15).
3. Check the fixed end impeller clearance. This clearance should be duplicated when repairs are completed.
4. Remove timing gears and hubs per instructions on page 19.
5. The impellers will now rotate freely in the case. Position both impellers so that one-half of the tip of the impellers can be seen when looking inside the unit from either the intake or discharge openings. Wedge a shim between the tips and the case on both the top and bottom of each impeller, locking them both in this position.
6. Unbolt and remove the cover on the drive end of the unit.
7. Unbolt and remove the bearing cartridges from both ends of the shaft being replaced as described in "Bearing and Seal Replacement," page 20.
8. Remove the socket head cap screws on the gear end of the shaft.
9. The shaft can now be removed by driving it from the drive side of the unit with a lead hammer and hydraulic press.
10. Before installing a new shaft, remove all burrs and coat the new shaft with anti-seize compound.

Slide the shaft in from the gear or fixed end toward the drive end.

11. Rebolt the shaft, using new cap screws, to the impellers and tighten with a torque wrench. See FIGURE 13, page 17, for torque values.
12. Replace bearing cartridge per instructions on page in "Bearing and Seal Replacement," page 20.
13. Remove the shims that are locking the impellers inside the case.
14. Set the impellers in the central timing position, making certain that the tip and throat match marks correspond. See "Determining Impeller Clearances," page 16, and replace timing gears and hubs as outlined on page 19.
15. Retime the blower according to instructions on page 17.
16. Remove the seal from the seal retainer mounted on the drive cover.
17. Replace the cover on the drive end.
18. Install a new oil seal in the retainer that mounts to the drive cover. Carefully center the seal on the shaft.
19. Replace the gear case and any oil lines.
20. Relubricate and follow "Blower Startup Checklist," page 12.

NOTICE

Follow Blower Startup Checklist on page 12 after every shutdown.

SECTION 6 REPAIR & REPLACEMENT

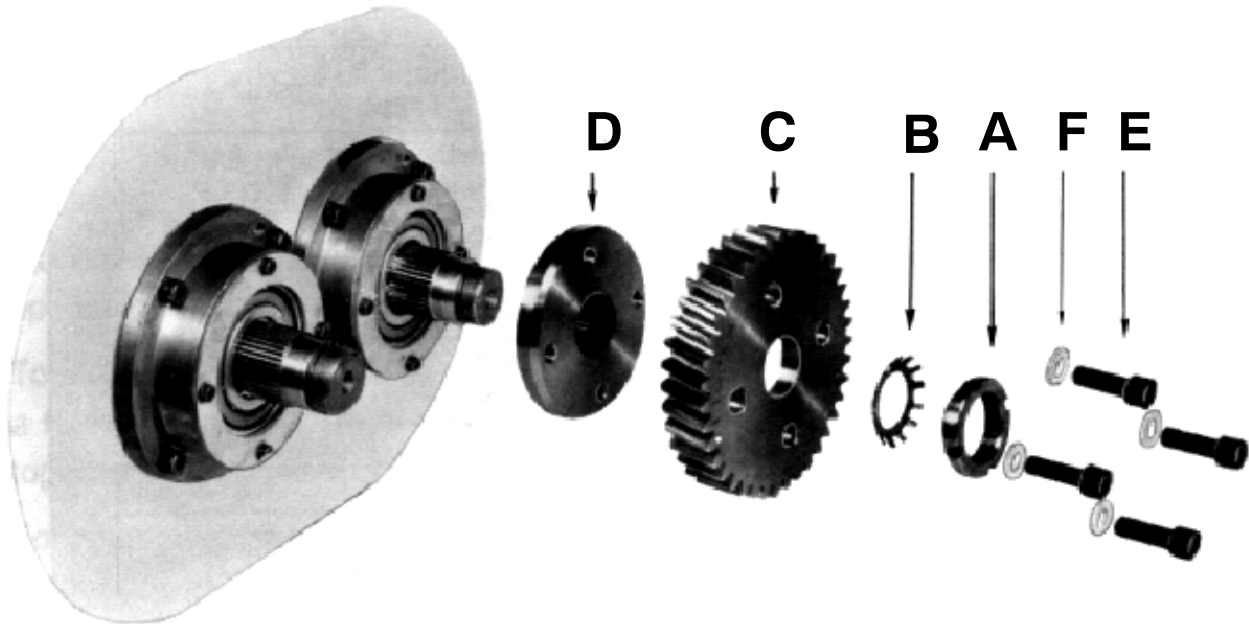

With proper maintenance and lubrication, normal life of bearings, gears and seals can be expected. To maintain the efficiency of your unit, however, these parts must be repaired or replaced when required.

Timing Gear and Hub Removal - Refer to FIGURE 14.

1. Remove the gear case (Gear Inspection, page 15).
2. Remove the cap screws (E), washers (F), lock nuts (A), and lock washers (B) from both shafts.
3. Match mark the shafts, gears and hubs to assure proper repositioning on completion of the work.
4. Remove gears (C) from hubs (D) and hubs from shafts. A gear puller may facilitate removal. Always match mark hubs in relation to shafts.

To reassemble:

1. Replace the hubs. When installing hubs, apply anti-seize compound on the splines. Do not use

force to install hub. In most cases it will be necessary to heat the hub to about 175° to 200° F.



CAUTION

Take care that the hubs are assembled to their original position on the shafts.

2. Replace gears.
3. Replace cap screws, washers (always turn washers over when replacing), locknuts, and lock washers to each shaft.
4. Establish a position for one gear, tighten the cap screws and locknut on that gear only. Then proceed with retiming according to instructions outlined in "Resetting Impeller Clearances," page 16.
5. Tighten the lock washers and nuts and use a torque wrench to tighten cap screws on the timing

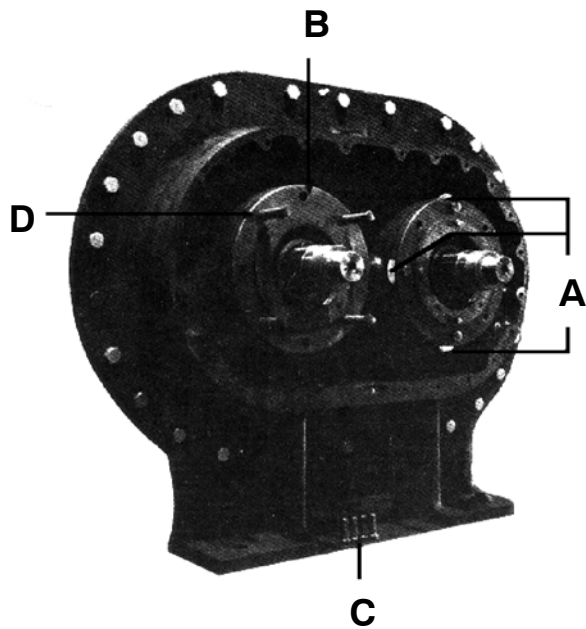

FIGURE 15 - BEARING CARTRIDGE REMOVAL

hub. Refer to FIGURE 13, page 17, for torque requirements.

6. Check the gear end clearance.
7. Replace the gear case.

NOTICE

Follow Blower Startup Checklist on page 12 after every shutdown.

BEARING AND SEAL REPLACEMENT

Gear End

1. Remove the gear case. Refer to "Gear Inspection," page 15.
2. Check the fixed gear end impeller clearance. This clearance must be duplicated when repairs are completed.
3. Remove the locknuts and washers from the ends of both shafts and match-mark the shafts, gears, hubs and bearing cartridges to assure repositioning during reassembly.

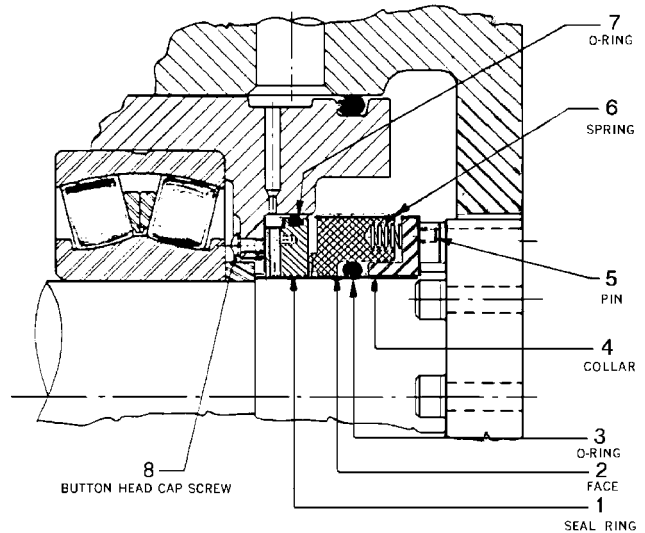

FIGURE 16 - MECHANICAL SEAL INSTALLATION

4. Remove gears and hubs using the procedure outlined in "Timing Gear and Hub Removal," page 19.

Refer to FIGURE 15. Shim spacers (A) added during production will now be exposed behind the bearing cartridge (B) on the gear end of the unit. The spacers were installed to assure accurate positioning of the impellers between the headplates; hence, it is important that they be returned to their exact positions on reassembly.

NOTICE

The number of spacers fastened behind each bearing cartridge varies. It is essential that each set of spacers be identified with its respective position during withdrawal.

To remove spacers:

1. Loosen, but do not remove, the bearing cartridge attachment bolts (C) (FIGURE 15).
2. Insert the jack screws (D) and back out the bearing cartridge until the shim spacers are loose.

Use care not to damage shim spacers under bearing cartridge with jackscrews.

3. Remove one bolt at a time, taking out the shims and marking them for accurate repositioning.
4. On removal of all bolts, continue using the jack screws to complete the bearing and cartridge removal.
5. Remove the bearing retaining ring from the face of the cartridge.

A lip type oil seal or mechanical seal is located behind each bearing on a blower, and a mechanical seal on a pump.

Lip Type Oil Seal - Whenever a cartridge is removed for repair purposes, always install a new seal before re-assembly. This can best be accomplished by using a driving instrument having the same approximate O.D. as the seal; use caution not to damage the new seal during installation. Always install the seal with the lip facing the bearing. Extreme care must be taken to avoid damaging the sealing elements when they are moved over the shafts.

Mechanical Seal (FIGURE 16, page 20) - Whenever a mechanical seal must be replaced, the following procedure should be followed.

1. Remove the old seal components.
2. Clean the shaft thoroughly, especially where the face (item 2) is located.
3. Coat the shaft with light oil.
4. It is necessary to use a tapered assembly tool when installing seal assembly, consisting of items 2 through 6. Be sure that the spring holder (item 4) is pushed against the cap screws.
5. When installing the seal (item 1) and "O"-ring (item 7) in the bearing cartridge, it is also necessary to use a tapered assembly tool to

prevent the "O"-ring from being damaged. Secure the seal ring (item 1) with three button head cap screws (item 8).

6. Tightened cap screws snugly.

 **WARNING**

Do not overtighten capscrews. Overtightening will pull seal ring out of flatness.

On completion of repair or replacement work, replace the "O"-ring on the bearing cartridge. Return the bearing cartridges to their respective shafts and restore the shim spacers to their original positions.

Bearing backup rings are factory installed against a shaft shoulder behind each gear and bearing. If these were removed during bearing cartridge disassembly, reinstall making certain that the 45° Chamfer faces the shaft shoulder.

Return bearings and secure in position. On force feed lubricated units the bearing retainer ring must be installed so that the lubrication notch is at the top and aligned with the oil passage in the bearing cartridge. Replace the gears and hubs using the procedure outlined in "Timing Gear and Hub Removal," page 19. Check the fixed end clearances. If necessary, add or delete shims behind the bearing cartridge flange as needed to restore original fixed gear end clearance.

Drive End - Remove the drive cover. A drive seal is located in the seal retainer on the drive cover. Always replace the drive seal when the drive cover is removed. Extreme care must be taken to avoid damaging the drive seal when moving it over the shaft keyway. Wrap a piece of light shim stock around the shaft to prevent keyway from cutting the seal element.

To replace the drive end bearings and seals follow the procedure as described for the gear end, page 20.

**SUTORBILT BLOWERS
4500 SERIES
8000 SERIES****GENERAL PROVISIONS AND LIMITATIONS**

Gardner Denver (the "Company") warrants to each original retail purchaser ("Purchaser") of its products from the Company or its authorized distributor that such products are, at the time of delivery to the Purchaser, made with good material and workmanship. No warranty is made with respect to:

1. Any product which has been repaired or altered in such a way, in the Company's judgment, as to affect the product adversely.
2. Any product which has, in the Company's judgment, been subject to negligence, accident, improper storage, or improper installation or application.
3. Any product which has not been operated or maintained in accordance with the recommendations of the Company.
4. Components or accessories manufactured, warranted and serviced by others.

Claims for items described in (4) above should be submitted directly to the manufacturer.

WARRANTY PERIOD

The Company's obligation under this warranty is limited to repairing or, at its option, replacing, during normal business hours at an authorized service facility of the Company, any part which in its judgment proved not to be as warranted within the applicable Warranty Period as follows.

BARE BLOWERS

Basic bare blowers, consisting of all parts within, are warranted for 12 months from date of initial use or 18 months from date of shipment to the first purchaser, whichever occurs first.

Any disassembly or partial disassembly of the blower, or failure to return the "unopened" blower per Company instructions, will be cause for denial of warranty.

OTHER COMPONENTS

All other components are warranted for 12 months from date of initial use or 18 months from date of shipment to first purchaser, whichever comes first.

The Company reserves the right to withdraw the Warranty where evidence indicates application outside the stated performance area, or where there is evidence of abuse

LABOR TRANSPORTATION AND INSPECTION

The Company will provide labor, by Company representative or authorized service personnel, for repair or re-

placement of any product or part thereof which in the Company's judgment is proved not to be as warranted. Labor shall be limited to the amount specified in the Company's labor rate schedule.

Labor costs in excess of the Company rate schedules caused by, but not limited to, location or inaccessibility of equipment, or labor provided by unauthorized service personnel is not provided by this warranty.

All costs of transportation of product, labor or parts claimed not to be as warranted and, of repaired or replacement parts to or from such service facilities shall be borne by the Purchaser. The Company may require the return of any part claimed not to be as warranted to one of its facilities as designated by the Company, transportation prepaid by Purchaser, to establish a claim under this warranty.

Replacement parts provided under the terms of the warranty are warranted for the remainder of the Warranty Period of the product upon which installed to the same extent as if such parts were original components.

DISCLAIMER

THE FOREGOING WARRANTY IS EXCLUSIVE AND IT IS EXPRESSLY AGREED THAT, EXCEPT AS TO TITLE, THE COMPANY MAKES NO OTHER WARRANTIES, EXPRESSED, IMPLIED OR STATUTORY, INCLUDING ANY IMPLIED WARRANTY OF MERCHANTABILITY.

THE REMEDY PROVIDED UNDER THIS WARRANTY SHALL BE THE SOLE, EXCLUSIVE AND ONLY REMEDY AVAILABLE TO THE PURCHASER AND IN NO CASE SHALL THE COMPANY BE SUBJECT TO ANY OTHER OBLIGATIONS OR LIABILITIES. UNDER NO CIRCUMSTANCES SHALL THE COMPANY BE LIABLE FOR ANY SPECIAL, INDIRECT, INCIDENTAL OR CONSEQUENTIAL DAMAGES, EXPENSES, LOSSES OR DELAYS HOWSOEVER CAUSED.

No statement, representation, agreement, or understanding, oral or written, made by any agent, distributor, representative, or employee of the Company which is not contained in this Warranty will be binding upon the Company unless made in writing and executed by an officer of the Company.

This warranty shall not be effective as to any claim which is not presented within 30 days after the date upon which the product is claimed not to have been as warranted. Any action for breach of this warranty must be commenced within one year after the date upon which the cause of action occurred.

Any adjustment made pursuant to this warranty shall not be construed as an admission by the Company that any product was not as warranted.



4400 Morris Park Drive
Charlotte, NC 28227
Phone: (704) 545-3922

Web: www.suncopowder.com
Email: info@suncopowder.com
Fax: (704) 545-8345

Gardner
Denver

Specifications subject to change without notice
© Copyright 2005 Gardner Denver, Inc. Litho in U.S.A.