



heating oil  
diesel fuel  
propane  
natural gas  
air conditioning  
energy audits  
insulation  
generators  
installations  
service plans





serving the community for over 76 years

Since 1939, the Cortese family has been providing customers with outstanding service and competitive pricing. New England Total Energy has evolved throughout the years into a total home energy company that offers our customers a variety of products and services that include heating oil, propane, diesel and natural gas in both homes and businesses. Residentially and commercially, we sell and service boilers, furnaces, central air conditioning systems and hot water heaters. Our number one priority is the health and safety of our customers. Our energy audit division can assess your home and equipment to make recommendations on how your home can be more energy efficient.

The Cortese family believes in giving back to the community through donations and support for the American Cancer Society, Mother's Against Drunk Driving, Touch a Truck and many other local charities. Because of our company's long legacy of excellent customer and community service, we were awarded the 2015 Best Family-Owned Business in Westchester and Fairfield County and presented a proclamation from the General Assembly designating October 19, 2014 as "New England Total Energy Day."





# PRODUCTS & SERVICES

## HEATING OIL

New England Total Energy is a full service oil company. We deliver premium heating oil to ensure your heating system runs at top efficiency. We use a sophisticated computerized system that measures your usage so we can always plan ahead of your needs.

## DIESEL FUEL

We deliver off-road and on-road diesel fuel to fleets. Our company offers wholesale & retail delivery, Construction/On Site fueling, fleet fueling, emergency fueling management and fuel tank service.

## PROPANE

Our services include delivery of propane, new tank installation, lease or purchase, conversions including indoor and outdoor piping of equipment, leak inspections and overall service needs. We partner with WESROC remote fuel monitoring system, we can automatically respond to any changes or increases in your propane consumption.

## NATURAL GAS

We are fully licensed to install and service all models of natural gas equipment. We sell a full line of Energy Star products. We have partnered with Sprague to offer competitive gas rates to our business customers.

## AIR CONDITIONING

We provide Energy Star HVAC systems including heat pumps, ductless mini splits and traditional systems. With the latest technology, rebates and special energy efficient financing, replacing AC units is more affordable than ever.

## ENERGY AUDITS

New England Total Energy looks at your home as a total system. An Energy Audit will examine all the heating and cooling systems in your home and how they function together. We will conduct safety and performance tests to assess your systems condition and identify savings opportunities. This is the first step when considering upgrading your equipment. The energy analysis will help outline the cost effectiveness of a new heating or cooling system as well as provide information needed to apply for energy efficiency rebates.

## INSULATION & WEATHERIZATION

Air sealing and proper insulation will prevent ice dams, frozen pipes and drafty houses as well as reduce your heating and cooling bills. Our energy audit report will show all major sources of air leaks and recommend the correct ventilation so your airflow is comfortable and energy efficient. Attics and crawlspaces can waste up to 30% of the energy used by your heating and cooling systems.

## GENERATORS

Backup power is fast becoming a household necessity. Let us plan your installation start to finish so your family will never have to be without electricity. Invest in an automatic standby generator and never worry about losing power again. Losing heat during the winter months can be devastating.

## INDOOR AIR QUALITY

We also offer air filtration systems, humidifiers and dehumidifiers to help keep indoor air quality healthy and clean.

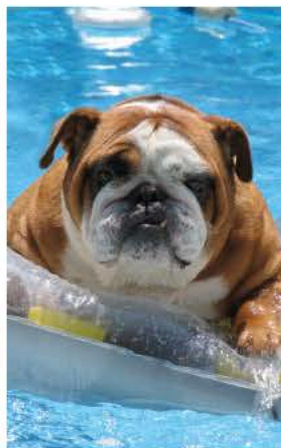

# SERVICE PLANS

## BASIC COMFORT OIL PLAN

This plan includes:

- ▶ Annual Tune-Up
- ▶ 15% Discount on Parts
- ▶ 15% Discount on Labor

**\$199 per unit** plus tax

**Oil Fired Hot Water Heater Service**

- ▶ Annual Tune-Up with heating system

**\$119 per unit** plus tax

## VALUE COMFORT OIL PLAN

This plan includes:

- ▶ Annual Tune-Up
- ▶ Coverage of over 35 Parts
- ▶ Labor
- ▶ Emergency Service on Plan Parts

**\$279 per unit** plus tax

**Oil Fired Hot Water Heater Service**

- ▶ Annual Tune-Up with heating system

**\$155 per unit** plus tax

## MAXIMUM COMFORT OIL PLAN

This plan includes:

- ▶ Annual Tune-Up
- ▶ Coverage of over 70 Parts
- ▶ Labor
- ▶ Emergency Service
- ▶ Bleeding of radiators once per season
- ▶ Drain expansion tank once per season

**\$450 per unit** plus tax

## PROPANE/NATURAL GAS SERVICE PLAN

This plan includes:

- ▶ Annual Tune-Up
- ▶ 15% Discount on Parts

**\$175 per unit** plus tax

**\$150 each add'l** plus tax

## GAS HOT WATER HEATER SERVICE PLAN

Annual Maintenance needs to be scheduled at the same time as heating system tune-up and includes:

- ▶ Annual Tune-Up
- ▶ 15% Discount on Parts

**\$155 per unit** plus tax

Customer is responsible for scheduling maintenance. Maintenance appointments are scheduled Monday - Friday: 8:00am - 4:00pm.

## OIL ANNUAL PREVENTATIVE MAINTENANCE

- Clean and replace nozzle, pump strainer & oil filter
- Oil & lubricate all moving parts
- Check and adjust the ignition system components
- Test & adjust the fuel pump pressure
- Check system operating pressure
- Brush & clean heat exchanger
- Test & Adjust all safety controls and aqua-stats
- Check and inspect combustion chambers and firebox
- Check and inspect oil tank and oil lines (tank to be accessible)
- Replace air filters if applicable
- Flush low water control if steam boiler

## EMERGENCY SERVICE CALLS

Emergency service during business hours is included with the Value Comfort Oil Plan and the Maximum Comfort Oil Plan. All other emergency service calls during business hours will be billed at \$125 hr. and \$187.50 after hours. Emergency service constitutes: no heat, serious fuel leaks or dangerous situations. All other regular service will be performed during normal business hours, Monday through Friday, 8:00am to 4:30pm. 1.800.260.5954

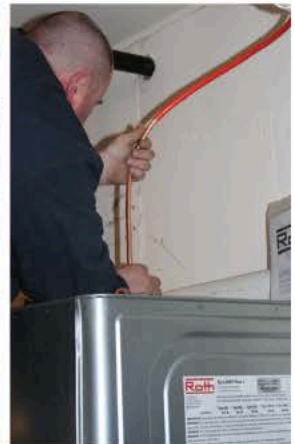



# PREVENTATIVE MAINTENANCE

## AIR CONDITIONING SERVICE PLAN

- ▶ Start System
  - ▶ Check/Clear Condensate Disposal System
  - ▶ Check & Replace Air Filter 1" disposable
  - ▶ Check Refrigerant Charge\*
  - ▶ Measure Operating Pressures and Temp
  - ▶ Check Fan Belts, Contactor Function
  - ▶ Lubricate and Check all Motors
  - ▶ Check Wiring Connections
  - ▶ Check Thermostat
  - ▶ Check Line Set Connections
- \$185** per system/ **\$150** each add'l

## HEAT PUMP SERVICE PLAN

- ▶ Start System
  - ▶ Check/Clear Condensate Disposal System
  - ▶ Check Operating Pressures\*
  - ▶ Check Voltage & Amperage
  - ▶ Check Static Pressure/Temp Drop Over Coil
  - ▶ Lubricate and Check all Motors
  - ▶ Check Outdoor Thermostat Setting
  - ▶ Check Electrical Lock-Out
  - ▶ Check Starting Contactor
  - ▶ Check Condenser Temp/Reversing Valve
- \$185** per system/ **\$150** each add'l

## ADD ON SERVICE PLANS

These add on plans need to be scheduled at the same time as heating or cooling system tune-ups:

- ▶ Electric Air Cleaner **\$75 per unit**
- ▶ Space Guard Filter **\$65 per unit**
- ▶ Basic Humidifier (does not include steam)  
Fall Start/Clean **\$35 per unit**  
Spring Shutoff/Drain **\$35 per unit**

\*adding refrigerant charge is an additional cost.

Outside temperature needs to be above 65 degrees to perform tune-up. Additional parts and labor outside the scope of preventative maintenance will be billed at prevailing New England Total Energy Rates. Certain restrictions may apply. Customer is responsible for scheduling maintenance. Maintenance appointments are scheduled Monday - Friday: 8:00am - 4:00pm.

## BEFORE YOU CALL FOR EMERGENCY SERVICE

### Are you out of fuel?

Check the gauge on top of your oil tank. Knocking on tank will not give a true indication of fuel level.

### Is your emergency switch on?

This switch is usually found at the top of the basement stairs and mistaken for a light switch. Should have a red plate on switch.

### Is your thermostat set above room temperature?

Sometimes a fireplace or other heat source creates a localized warm area, which can leave the rest of your home with no heat.

### Is there electrical power getting to your heating system?

Check for a tripped circuit breaker.

### Have you pressed the burner reset button?

If you have checked the list above then try the reset button only once.

## SERVICE PLAN BENEFITS

There are many benefits for investing in a service plan. An Annual Tune Up will help reduce the likelihood that your equipment will breakdown, save you money on costly repairs and extend the life of your equipment.

Call 1.800.260.5954 to schedule an appointment.

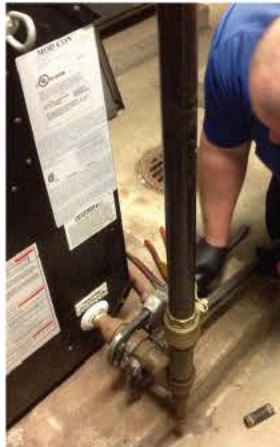

# OIL SERVICE PLAN COVERAGE

## FUEL & COMBUSTION

	VCP	MCP
1 Air Shutter	●	●
1 Hydraulic Piston	●	●
1 Hydraulic Line	●	●
2 Burner Coupling	●	●
3 Burner Fan	●	●
4 Burner Flange	●	●
4 Burner Flange Gasket	●	●
4 Air Tube	●	●
4 End Cone	●	●
5 Burner Motor (1/4HP)	●	●
6 Cad Cell Eye (Assy complete)	●	●
7 Primary Control	●	●
8 Re-Set Button	●	●
9 Combustion Chamber	●	●
10 Delayed Oil Valve	●	●
10 Delayed Oil Valve Coil	●	●
11 Draft Regulator (up to 7")	●	●
12 Electrodes	●	●
13 Emergency Switch	●	●
14 Fusible Burner Valve	●	●
14 Fuel Pump Gasket	●	●
14 Fuel Pump (single stage)	●	●
14 Fuel Pump Bleeder	●	●
14 Fuel Pump Strainer	●	●
15 Ignition Transformer	●	●
16 Aquastat (standard)	●	●

	VCP	MCP
16 Aquastat Well	●	●
17 Nozzle	●	●
17 Nozzle Adapter	●	●
17 Nozzle Line	●	●
18 Oil Filter Cartridge	●	●
18 Oil Filter Complete	●	●
Oil Tank Vent Cap	●	●
Oil Tank Fill Cap	●	●
Oil Safety Valve (OSV Valve)	●	●
19 Thermostat Standard	●	●

## WARM AIR

	VCP	MCP
20 Air Filter** (1" disposable)	●	●
21 Blower Pulley**	●	●
22 Blower Belt**	●	●
23 Blower Shaft**	●	●
23 Blower Bearings**	●	●
24 Blower Wheel	●	●
25 Blower Motor (1/3hp) (1/2hp)	●	●
Fan Center Relay**	●	●
26 Fan & Limit Control	●	●

## HOT WATER & STEAM COMPONENTS

	VCP	MCP
27 Air Scoop (1 1/4")	●	●
Automatic Air Vent (boiler room only)	●	●
28 Boiler Drain Valve	●	●

	VCP	MCP
29 Circulator Complete*	●	●
(Taco 007/Grundfos UPS15-58c/B&G Circulator only)		
29 Circulator Coupling*	●	●
(Taco 007/Grundfos UPS15-58c/B&G Circulator only)		
29 Single Zone Relay	●	●
29 Circulator Motor* (up to 1/5 hp/B&G only)	●	●
30 Combination Feeder	●	●
31 Back-Flow Preventer	●	●
Domestic Hot Water Temp./Pressure Relief Valve (15 Psi)	●	●
32 Extrol Tank (#30)	●	●
33 Feed Valve	●	●
34 Flow Check Valve	●	●
35 Gauge Glass & Washers	●	●
Low Voltage Transformer (40va)	●	●
Manual Feed Valve	●	●
Pressure Relief Valve (30 lbs Water Boiler)	●	●
Purge Valves (up to 3/4")	●	●
Pressuretrol (auto type only)	●	●
36 Pressure/Temperature Gauge	●	●
System 2000 System Manager	●	●
Tiger Loop (original type)	●	●
Zone Valve Complete*(1" Honeywell, Taco)	●	●
Zone Valve Motor* (Honeywell, Taco)	●	●
Zone Valve Power Head* (Honeywell, Taco)	●	●
Zone Damper Motor*/*** (Honeywell, Evc, Duro Zone)	●	●

\* One per year. Any other circulator brand is subject to add'l charge.

\*\*If parts are used for Air Conditioning, they are only covered from 10/1 thru 5/1.

\*\*\*Zone Damper Parts only covered on Warm Air Furnaces (Hydro units not included)

**Value Comfort Plan** ●  
**Maximum Comfort Plan** ●

## Residential Hot Water Boiler

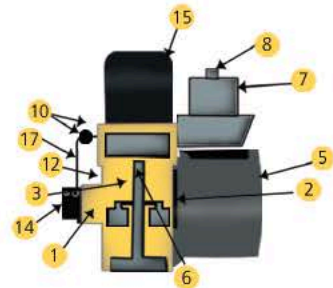
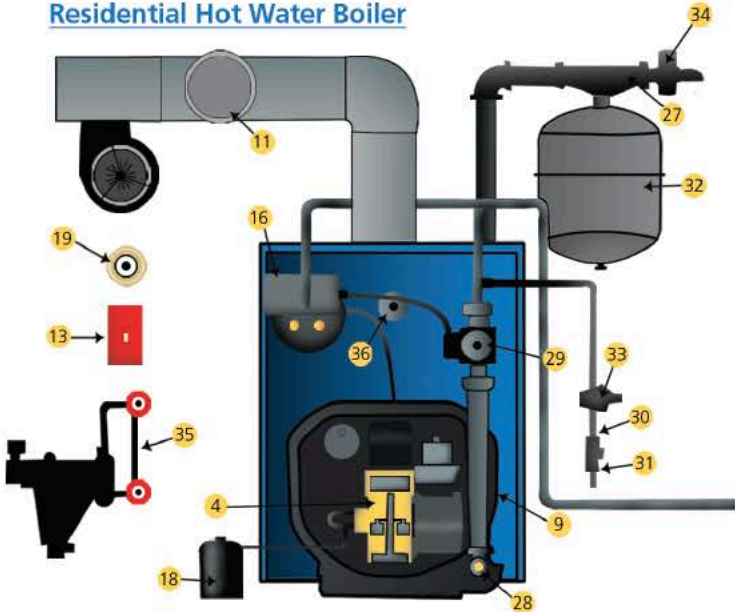

## Residential Warm Air Furnace

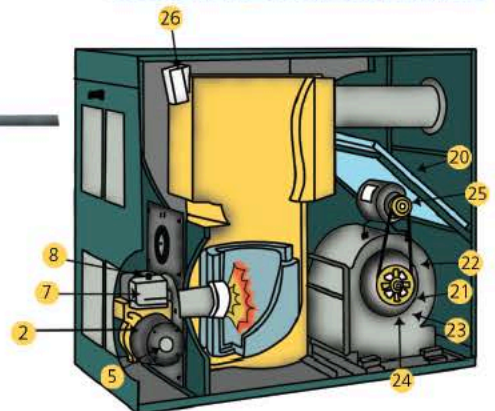



# INSTALLATIONS

New England Total Energy is a fully licensed installation company. We will help plan your project from beginning to end. We are here to help you make the most educated decision with all the specs and prices available. Most energy efficient upgrades and installations are eligible for rebates and financing. Having an Energy Audit performed on your home will provide valuable information regarding all your equipment and where your home is losing energy through air leaks. Installing new equipment and sealing up the air leaks can save up to 20% on your heating and cooling bills. We provide a variety of brands for:



- Oil & Gas Boilers
- Hot Water Heaters
- Pool Heaters
- Central Air Conditioning
- Oil & Gas Furnaces
- Mini-Split Systems
- Radiant Floors
- Generators



## FINANCING OPTIONS

There are several programs that are available to residents to finance the purchase and installation of cost-saving energy conservation improvements. There is even a zero percent financing product where you can borrow up to \$3,000 for insulation or other high efficiency measures. Some of these financing options can be billed on your electric bill, if you qualify. For more information, visit [www.energizect.com/residents/solutions/financing](http://www.energizect.com/residents/solutions/financing). Taking advantage of these programs will save energy and money. Programs change often so call to find out which Energy Efficiency Solution best fits your home improvement project. Special financing and rebates apply to most upgrades.

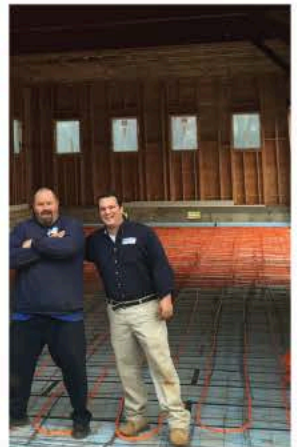



## CONTRACT TERMS

New England Total Energy reserves the right to cancel this contract if any of the General Conditions have been broken without liability against either party. This Service Agreement shall be for a period of twelve months. To avoid lapse in coverage, these plans shall automatically be renewed unless terminated by either party in writing within 30 days of the plan renewal date. Pricing subject to change upon renewal of contract. In the event that the service contract is cancelled by the customer, there are no refunds on any unused portion of the contract. We will however transfer the unused portion of the service contract to a current customer whom moves within our delivery area from one house to another. Service Contracts are not prorated and are nonrefundable. The contract is valid upon payment in full. Payment for all Service Plans is due net 15 days from invoice date. (Unless on budget payment plan) Your account must remain current and in good financial standing to be eligible to participate in any of the New England Total Energy Service Agreements. This service agreement does not cover service resulting from insufficient fuel oil in the tank due to deliveries being withheld because of unpaid account balance, delinquent accounts, or for "Will Call" accounts. "Will Call" accounts are not eligible for service agreements. A finance charge of 1.5% per month (annual percentage rate of 18%) is charged on items not paid 30 days from statements due date. This Service Agreement will be suspended if payment is delinquent. You are required to PURCHASE 100% of your fuel oil and be on an automatic oil delivery schedule to participate in any of the New England Total Energy Service Plans. If there is a cancellation of automatic delivery or fuel supplied by any other source other than New England Total Energy it will terminate the Service Agreement. All customers are required to use a minimum of 700 gallons of oil per heating season to participate in any New England Total Energy Service Agreements. (At the discretion of New England Total Energy) Purchase of fuel oil and or service by any other source other than New England Total Energy will void this Service Agreement. There shall be no liability for any reason on the part of New England Total Energy for work done by anyone else, unless such person is authorized in writing by New England Total Energy to perform such work or furnish parts.

## INSPECTION & PRE-EXISTING CONDITIONS

New England Total Energy reserves the right to inspect and test all heating systems upon acceptance of service agreements. Any labor and / or parts charges incurred prior to acceptance of this agreement cannot be credited. Repairs required to correct pre-existing conditions are not covered by this plan and will be charged at the company's normal rates. New England Total Energy has the option to waive the inspection.

## SERVICE HOURS

An annual tune-up / cleaning will be performed once during the Service Agreement term, during regular business hours (8:00am - 4:00pm Monday – Friday), as scheduled by our service department. Emergency Service is available 24 hours a day.

## SERVICE SCHEDULING

New England Total Energy will attempt to contact customers to schedule their service visit, however, it is ultimately the customers responsibility to see that the service is scheduled as there are no carry overs or rebates. New England Total Energy will always offer prompt and courteous service. We will and shall not be held responsible and or liable for damages or loss caused by a delay in securing parts, responding to calls for service, oil deliveries or any loss arising out of the performance of this contract. We also will not be held liable for any unforeseen and uncontrollable acts, be it Act of God, Fire Damage, Explosions, Flooding, Hurricanes, Tornadoes, Earthquakes, Blizzards, War, Civil Commotion, Acts of Terrorism, Hostilities, Riots, Local, State or Federal government acts or requests or other causes of "Force Majeure", Labor unrest or any other cause beyond our control. Failure of Public Utilities or Common Carriers to provide raw materials, energy or other supplies and services.

"Service Calls" and incidental damages related to insufficient combustion air. Also service and / or damages caused by draft issues related to such items as: Attic exhaust fans, whole house exhaust fans or clothes dryers. "Non Emergency Service Calls" / "Nuisance Calls" do to switches in the "Off" position, blown fuses, tripped circuit breakers thermostat satisfied, failure of low water cutoff do to failure to maintain proper supply of water in the heating system, air in baseboard or radiators, flooding of steam boilers, any type of plumbing related work or plumbing items (unless covered under max plan) and the pumping out of water or foreign matter from oil tanks are not covered under the service agreement. Customers with fuel oil tanks located outdoors and/or in unheated, unconditioned area's are to be required to use a cold temperature additive (pour point conditioner) offered by New England Total Energy. Refusal to use these additives will void the service contract. If the heating system becomes unsafe or uninsurable during the term of this Service Plan, we will request that the equipment be upgraded. Refusal to upgrade your system in a reasonable amount of time will result in automatic termination of this service agreement. This Plan may be terminated by New England Total Energy at the end of the term agreement due to poor equipment or excessive service related issues do to inadequate equipment.

## CONTRACT EXCLUSIONS

Service Agreement does not cover unattended or vacant homes and or buildings. This Service Agreement does not cover service related issues due to interruptions in oil deliveries due to customer's failure to provide us a safe access to the property and oil fill. (i.e. driveways to be plowed properly and sanded /salted, oil fills to be shovelled out and marked) If the heating system has been denied fuel by broken, frozen and or plugged oil lines by water, sediment or inadequate fuel system it is not covered under this Service Agreement. This agreement also does not cover environmental cleanups related to fuel system issues. Remediation of oil spills, water and soot are not covered under this plan. This plan also does not cover any Day Tanks, Supply Pumpers, Pressure Switches or Vacuum Breakers or related piping. This Service Agreement excludes discontinued and /or obsolete parts, special control systems, electronic printed boards, or any controls used for the purpose of energy conservation. i.e.: Tekmar, Watchman, etc. Programming or replacement of set-back type thermostats. This agreement also excludes all plumbing, and water related issues i.e.: Draining of expansion tank, bleeding of radiators, baseboard and or heating zones, and any other plumbing related parts and labor. Multi-fuel units are not covered under this plan nor are electronic air cleaners, Special Purpose Air Filters i.e.: Space Guard®, Air Bear® and Honeywell®. Humidifiers, oil lines and electrical wiring not attached to heating equipment. This Agreement does not cover damage caused by flooding, water leaks, lightning strikes, wind, attic fans, humidifier leaks and A/C coil pans leaks, poor chimney draft conditions or poor chimney flue design. Power venters, Draft Inducers, Automatic flue dampers and Powered Combustion Systems.

## PARTS

Parts & Labor that are not covered under this Service Plan are billed on a time and material basis.\* This plan does not cover water leaks or any plumbing parts, controls or piping that hold water or control the movement of water; or corrosion and or part failure do to the use of antifreeze, nor does it cover labor on any parts not covered under this Service Contract. Air Conditioning service or any related parts are not covered under this contract. We however offer a pre-season preventive maintenance program. We also offer repair and installation of air conditioning systems by our trained technicians at an additional charge. Service Agreements do not apply to "POOL HEATERS" installed in unconditioned areas. Coverage shall only apply to those units located in weather proof locations only!