

AVO Turboworld Japan
2-13-13 Musashino
Akishima-shi,
Tokyo 196-0021.
Tel: (81) 42-549-1296
Fax: (81) 42-549-1297
URL: www.avoturboworld.jp



SUZUKI JIMNY SIERRA JB74 - PRODUCT SELECTION

Our catalogue of products for the JB74 Suzuki are specific to the K15B engine models with either the 3 door or 5 door body types. Some parts are specific to each body style and are marked accordingly with either 3D or 5D.

Products will fit either Manual Transmission or Automatic Transmission and are suitable for both Right Hand Drive and Left Hand Drive vehicles unless otherwise specified.

AVO Turboworld Parts list for JB74 Suzuki Sierra

Part Number	Description	Page
<u>WJ2199F7A001T</u>	ECU Tune for AVO Turbocharger Kits	4
<u>WJ2199T7A001T</u>	Bolt-On Turbo Kit - Standard	6
<u>WJ2199T7A002T</u>	Bolt-On Turbo Kit - Hi-Mount Intercooler	7
<u>WJ2199T7A003T</u>	Bolt-On Turbo Kit - Snorkel Compatible	8
<u>WJ219F02BB0XT</u>	Snorkel Conversion Kit	9
<u>WJ219G3LACATT</u>	2.0in Turbo Outlet with Hi-Flow Cat	10
<u>WJ219G3LA001T</u>	2.0in Turbo Outlet Straight Pipe	10
<u>WJ219F3GA003T</u>	2.0in Front Pipe with Hi-Flow Cat	11
<u>WJ219F3GNOCAT</u>	2.0in Front Pipe Straight	11
<u>WJ219F3KA065T</u>	2.5in Header Back Exhaust Kit with Hi-Flow Cat	12
<u>WJ219F3GTB65T</u>	2.5in Turbo Back Exhaust Set Straight	12
<u>WJ219F3MA002T</u>	2.0in Catback Exhaust System - Performance	13
<u>WJ219F3MALR2T</u>	2.0in Catback Exhaust System - L/R Fuel Tank	13
<u>WJ219F3MACB3T</u>	2.0in Catback Exhaust System - Comfort	14
<u>WJ259F3M5CB4T</u>	2.0in Catback Exhaust System - Comfort - 5 Door	14
<u>WJ219F3MACENT</u>	2.0in Center Pipe Kit	15
<u>WJ259F3M5CENT</u>	2.0in Center Pipe Kit - 5 Door	15
<u>WJ219F3MASRMT</u>	2.0in Large Rear Muffler - Comfort	16
<u>WJ219F3MBSRMT</u>	2.0in Small Rear Muffler - Performance	16
<u>WJ219G0QA001T</u>	Oil Breather Tank Kit	17
<u>WJ219EYAA001A</u>	Engine Oil Cooler Kit	17
<u>S6Z12GFXA150J</u>	Fuel Pump with Filter - 155 L/Ph	18
<u>WJ2199FWBINJA</u>	Port Injector Set	18
<u>MAP3BARJ</u>	3 Bar Map Sensor	19
<u>WJ219UACT008T</u>	Upgrade Actuator	19
<u>WJ21990A4CAMT</u>	Heat Shield - Ignition Coils	20
<u>MAPADAPT</u>	Pressure Sensor Adaptor	20
<u>WJ2199F7A002T</u>	ECU Tune for NA Packages	21
<u>WJ219941A***T</u>	NA Silicone Intake / Throttle Body Hose Kit	24
<u>WJ219F02A001T</u>	NA Power Filter Kit	24
<u>WJ219F02ABOXT</u>	NA Power Filter and Air-box Set	25
<u>ENLEC002</u>	Replacement Power Filter	25
<u>WJ219943A001T</u>	Flat Panel Air Filter - OEM Air-box	25
<u>WJ2199G3NCATJ</u>	NA Header with Hi-Flow Cat	26
<u>WJ219G3NA018J</u>	NA Header Straight	26
<u>WJ219F3KA001T</u>	NA 2.0in Header Back Exhaust Kit	27
<u>S1H04M1GUB90J</u>	Front Stabilizer Bar End Link - Adjustable	28
<u>WJ21997GV027T</u>	Front Stabilizer Bar Bush	28

AVO Turboworld Suzuki Bolt-On Turbo Kits

We offer 3 different bolt-on Turbo Kits, each kit provides the same level of performance and reliability however the design elements of each kit vary in some areas in order to suit different use cases.

The Main Points (applicable to all kits):

- The kit is designed in a way so that both factory cat converters can be retained.
- The kit includes all oil and water plumbing for the turbocharger including a fitting that must be drilled and taped into the oil pan.
- The turbo exhaust manifold is a 4 into 1 runner design with the collector being a die cast piece for great durability and to finish it off is a CNC cut 16mm turbo mounting flange and CNC cut exhaust manifold flange. All of which is then high temperature ceramic coated. The kit includes a base 5 psi actuator.
- Intake and intercooler piping are constructed of a combination of 2" and 2 ½" mandrel bent 304 brush finished stainless. High quality silicone joiners, silicone moulded intake hose and silicone hump hose connect all pipework from filter to the turbo, turbo to intercooler entry and then intercooler discharge to the throttle body. A sports air filter completes the intake system.



Standard Kit - Intercooler is visible behind the bumper in the traditional position.



Hi-Mount Kit - Intercooler is higher up behind the grille for a stealth look.

ECU Tune for Turbo Kits

11819 /

Part Number: WJ2199F7A001T

Send us your ECU and we will load the tune file relevant to the parts you are fitting.



Standard ECU Tune

Our standard ECU tune has boost set at 0.4 bar, this tune is designed to run with the OEM injectors, fuel pump and exhaust including both OEM cat converters. Fit any of the 3 turbo kits and with no additional parts achieve a power increase of around 40% and an increase in torque of around 50%.

Manual Transmission Turbo - Standard Tune vs OEM Naturally Aspirated Dyno Graph:

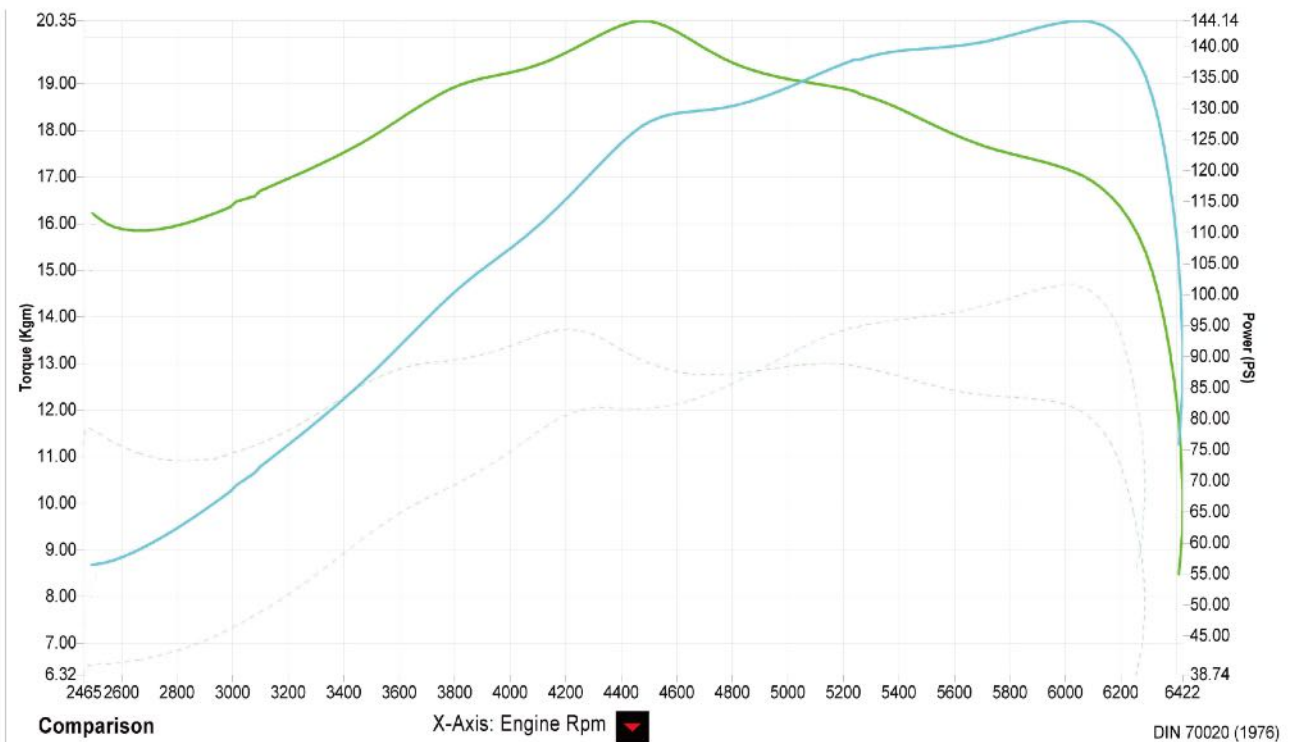

Hi-Power ECU Tune

To realize our turbo kits true potential we have developed our Hi-power tune which has boost set at 0.65 bar and offers over 100% power and torque increase.

In order to achieve such increases and run this ECU tune it will be necessary to fit the following upgrade parts.

- [WJ219F3GTB65T](#) 2.5in Turbo Back Exhaust Set Straight
- [S6Z12GFXA150J](#) Fuel Pump with Filter
- [WJ2199FWBINJA](#) Port Injector Set
- [WJ219UACT008T](#) Upgrade Actuator

Dyno Graph: Manual Transmission Turbo - With Above Upgrade Parts

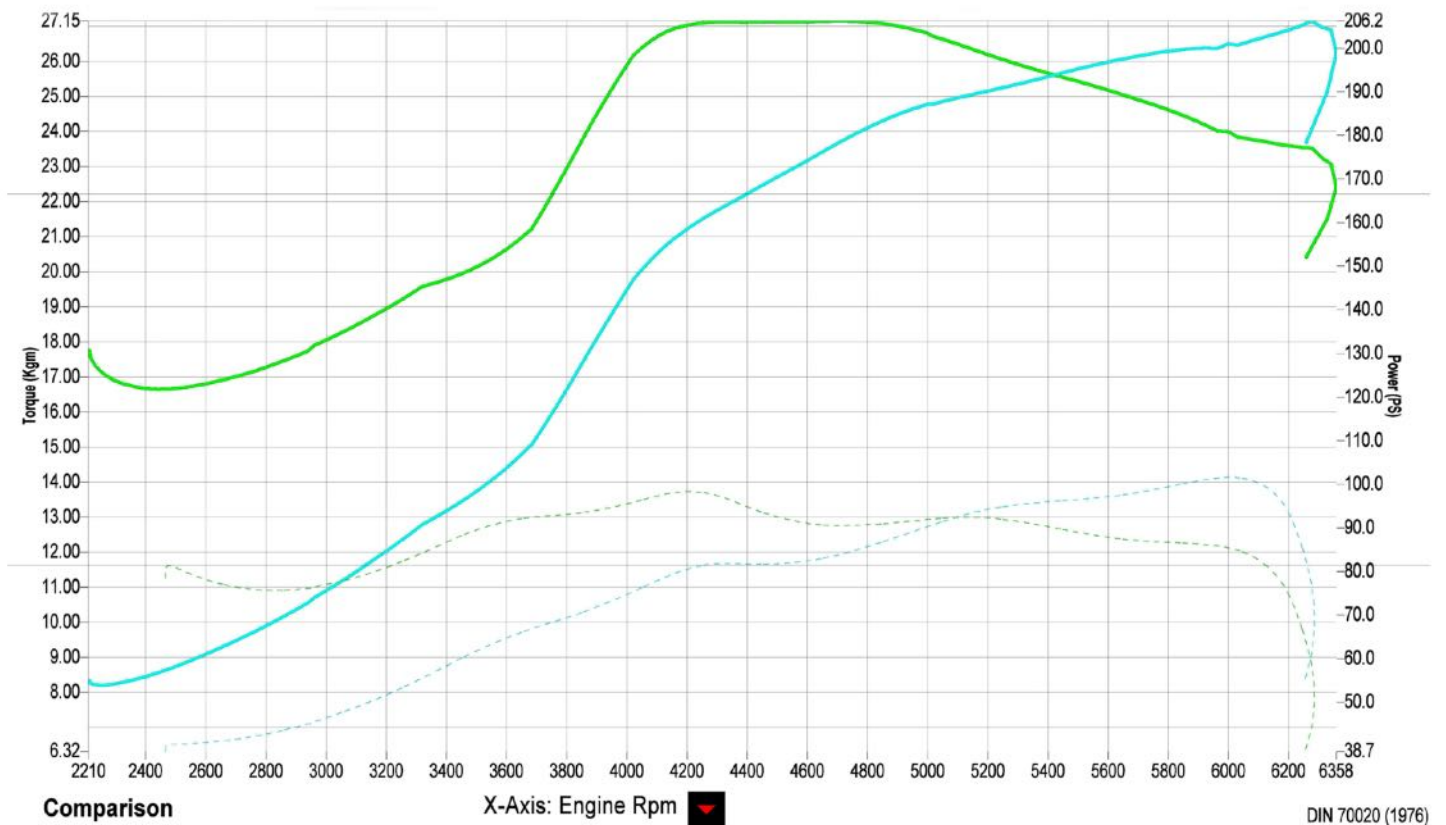

Bolt-On Turbo Kit - Standard Type

11594 / 4582459077414

Part Number: WJ2199T7A001T

This kit is designed to give the classic turbo look with the intercooler visible behind the front bumper and the intake visible behind the grille. This kit is not recommended for vehicles with oversized wheels and tires. For such vehicles please use the Hi-Mount Kit.

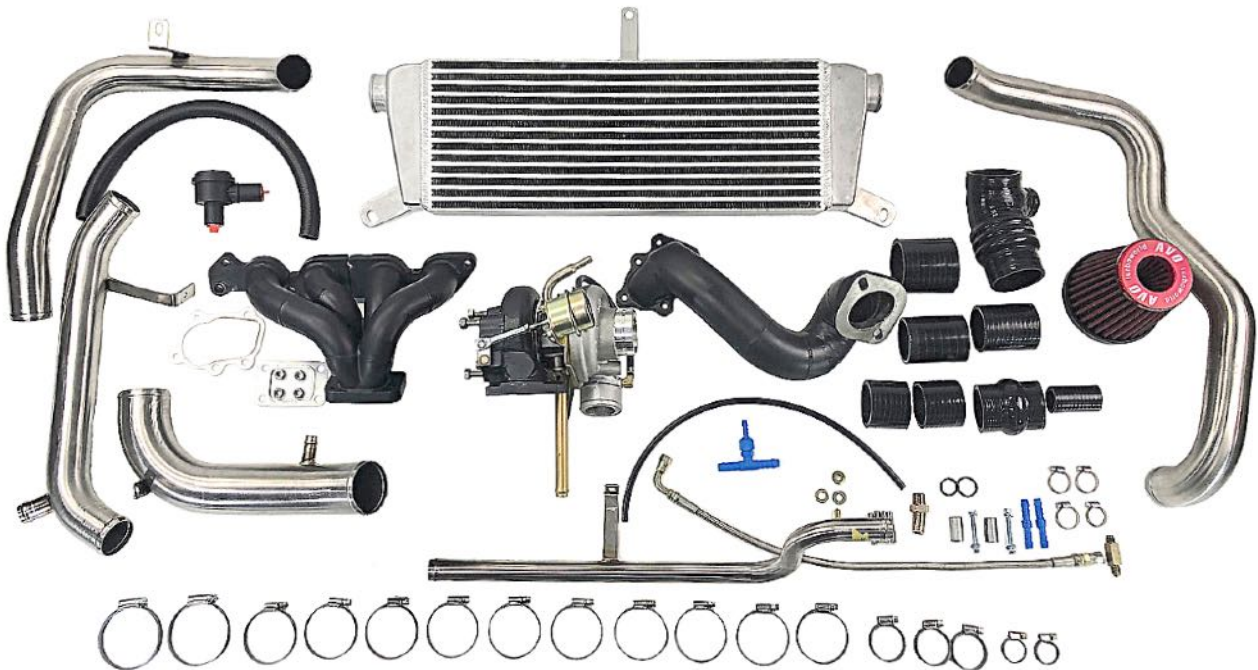

Bolt-On Turbo Kit - Hi-Mount Type

11753 / 4582459077490

Part Number: WJ2199T7A002T

This is the kit that is recommended for a stealth or OEM look as well as vehicles fitted with oversized wheels and tires as the intercooler is mounted behind the grille and therefore the piping is up higher so as not to interfere when cornering.



Bolt-On Turbo Kit - Hi-Mount Snorkel Compatible

11792 / 4582459077803

Part Number: WJ2199T7A003T

As the name suggests this is the kit to choose if you are planning to run an air intake snorkel as this kit has a sealed air box along with additional piping to fit with a snorkel setup. In addition this kit includes an engine breather tank to prevent oil blow-by.

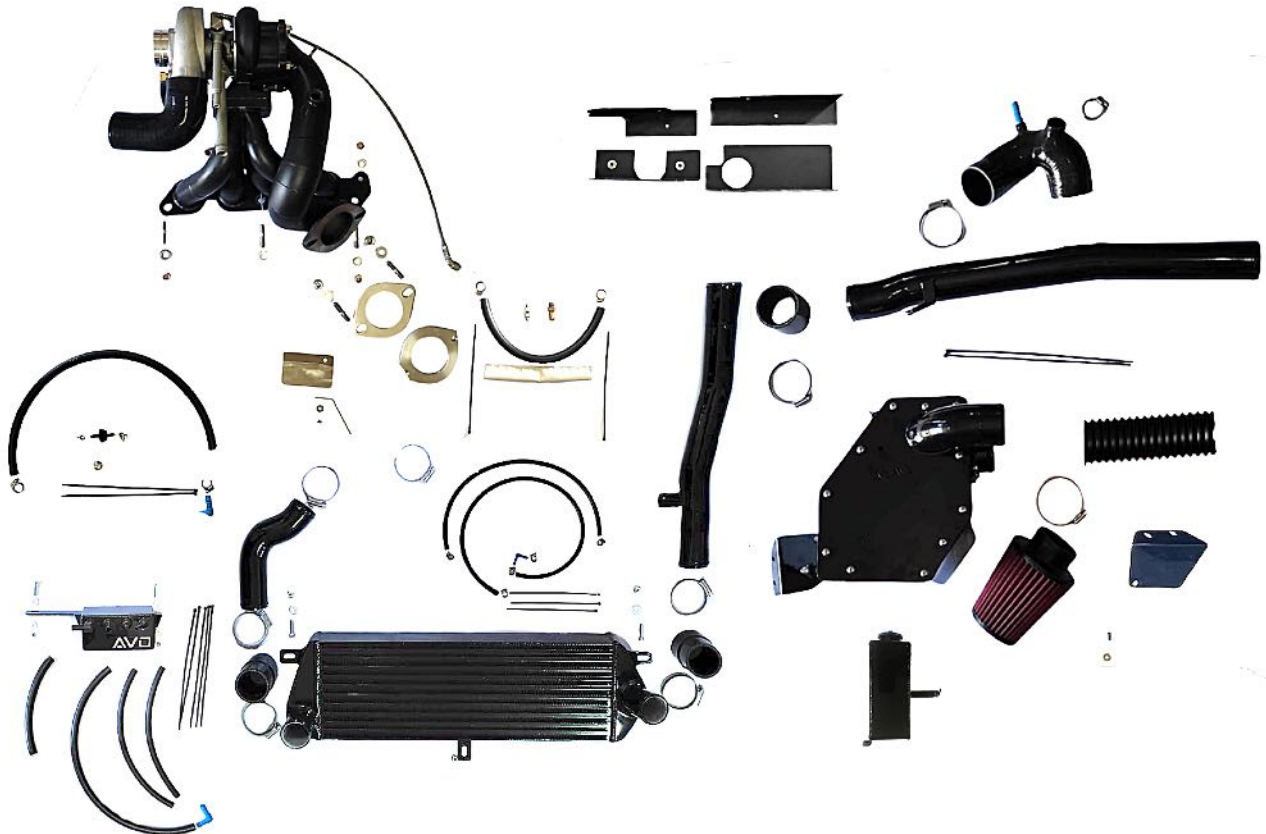

Snorkel Conversion Kit

11783 / 4582459079562

Part Number: WJ219F02BB0XT

This kit converts our Turbo Kit Part No. WJ2199T7A002T to Part No. WJ2199T7A003T so the car can be fitted with a snorkel setup without the need to replace the whole kit. It also adds our Engine Oil Breather Tank Kit.



Turbo Outlet with Hi-Flow Cat

11811 / 4582459079357

Part Number: WJ219G3LACATT

Easier installation on any of the turbo kits as this removes the need to cut the OEM manifold, also provides improved performance due to less back pressure compared to the OEM cat. This part is 2.5in down to 2.0in for use with the OEM front pipe.

Turbo Outlet Straight Pipe (Race use Only)

11812 / 4582459079340

Part Number: WJ219G3LA001T

Easier installation on any of the turbo kits as this removes the need to cut the OEM manifold. Increased performance due too much less back pressure. This part is 2.5in down to 2.0in for use with the OEM front pipe.



2.0in Front Pipe with Hi-Flow Cat

11735 / 4582459077445

Part Number: WJ219F3GA003T

Improved performance due to less back pressure compared to the 2nd OEM cat. This part is 2.0in for use with the OEM 1st cat and exhaust system.

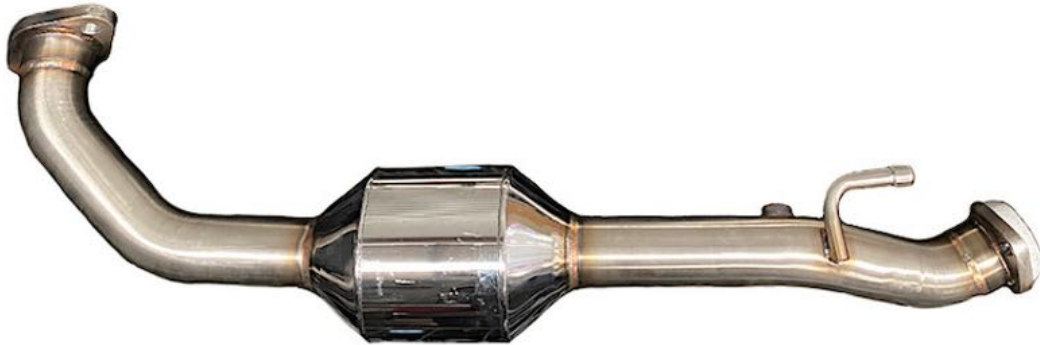
2.0in Front Pipe Straight (Race use Only)

11791 / 4582459079579

Part Number: WJ219F3GNOCAT

Increased performance due too much less back pressure. This part is 2.0in for use with the OEM 1st cat and exhaust system.



3D 2.5in Header Back Exhaust with Hi-Flow Cat

11838 / 4582459079586

Part Number: WJ219F3KA065T

This set has a 2.0in flange on the front pipe to match with the OEM header but with 2.5in piping after that for much improved flow, the front pipe maintains the factory flex setup, the set includes a centre muffler pipe, intermediate s-pipe, and a rear resonated pipe with 2 1/2" down pointing polished tip.

**3D 2.5in Turbo Back Exhaust Straight (Race use Only)**

11865 / 4582459079593

Part Number: WJ219F3GTB65T

Looking for maximum performance this is the kit to use due to the larger 2.5in pipe diameter all the way through and the straight pipe design providing much better gas flow. Use this with our Hi-Power tune to get the best possible performance from our turbo kits.



3D 2.0in Catback Exhaust System - Performance

11750 / 4582459077469

Part Number: WJ219F3MA002T

This exhaust is designed for performance offering substantially better flow and much improved sound than the standard system but still fit with the OEM front pipe.

**3D 2.0in Catback Exhaust System - L / R Fuel Tank**

11790 / 4582459077698

Part Number: WJ219F3MALR2T

If the vehicle is fitted with the optional long range fuel tank then choose this part to offer better flow than the standard system but still fit with the OEM front pipe.



3D 2.0in Catback Exhaust System - Comfort

11893 / 4582459079791

Part Number: WJ219F3MACB3T

This exhaust is designed for noise conscious owners who still want some gain in flow but with minimal increase in noise compared to the standard system. Fits the OEM front pipe.

**5D 2.0in Catback Exhaust System - Comfort**

11900 / 4582459077988

Part Number: WJ259F3M5CB4T

This part # is specific to the 5 door model and is designed for noise conscious owners who still want some gain in flow but with minimal increase in noise compared to the standard system. Fits the OEM front pipe.



3D 2.0in Center Pipe Kit

11892 / 4582459079807

Part Number: WJ219F3MACENT

This center pipe kit is ideal for those looking to increase exhaust flow and already have an after market rear muffler fitted. Fits the OEM front pipe and rear muffler.

**5D** 2.0in Center Pipe Kit

11899 / 4582459077995

Part Number: WJ259F3M5CENT

This part # is specific to the 5 door model and is ideal for those looking to increase exhaust flow and already have an after market rear muffler fitted. Fits the OEM front pipe and rear muffler..



2.0in Large Rear Muffler - Comfort

11891 / 4582459079814

Part Number: WJ219F3MASRMT

This rear muffler is ideal for those looking for a nice visual upgrade to the OEM part but without too much increase in noise. Fits with the OEM center pipe.



2.0in Small Rear Muffler - Performance

11907 / 4582459079197

Part Number: WJ219F3MBSRMT

This is our performance rear muffler for those looking for better flow and an increased exhaust sound. Fits with the OEM center pipe.



Engine Oil Breather Tank Kit

11795 / 4582459079609

Part Number: WJ219G0QA001T

Designed to prevent crankcase pressure build up, this kit should be used when looking to maximize the boost when running the turbo kits.

Note: this part is included in the WJ2199T7A003T turbo kit.

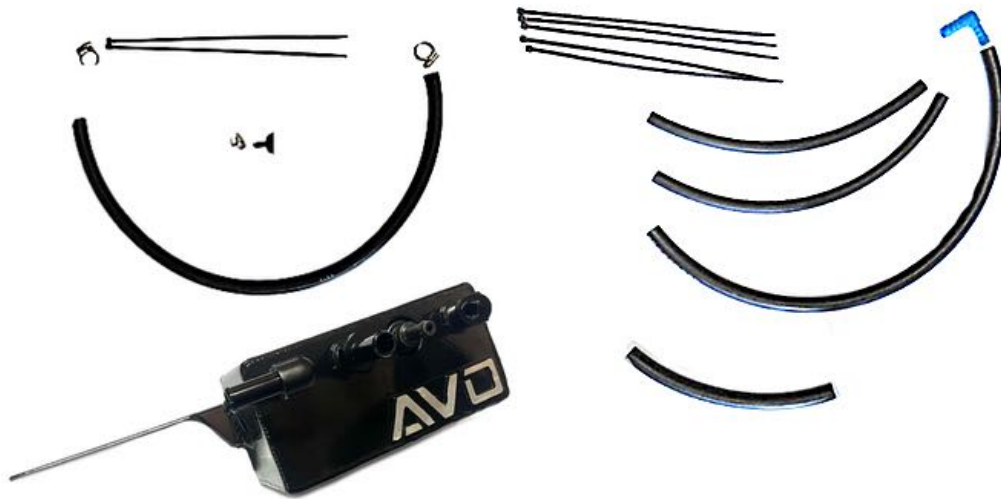

Engine Oil Cooler Kit

11858 / 4582459079616

Part Number: WJ219EYAA001A

With the added heat from running a turbocharger it is advisable to add additional oil cooling capacity especially when looking to run on boost for extended periods.

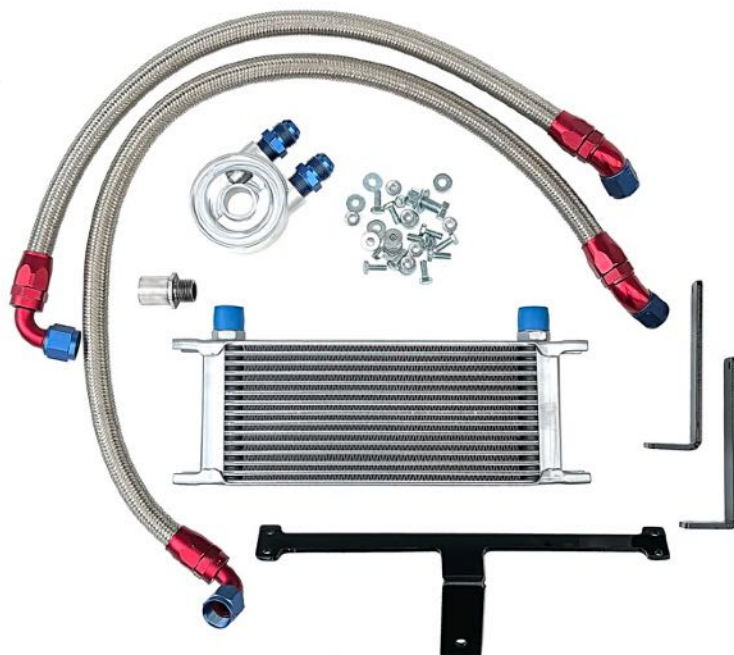

Upgrade Fuel Pump with Filter

11779 / 4582459079623

Part Number: S6Z12GFXA150J

To run higher boost or straight pipe exhaust systems the OEM fuel system must be upgraded or engine damage will occur due to insufficient fuel delivery.

This pump along with our upgraded injectors provide enough fuel to run our high boost ECU tune with our turbo kits.



Upgrade Fuel Injector Set

11861 / 4582459079630

Part Number: WJ2199FWBINJA

Higher flow injectors that are a direct replacement fit to go with our upgraded fuel pump for those wanting to run our high boost ECU tune or straight pipe exhaust systems.



3 Bar Map Sensor

41585 / 4582459076264

Part Number: MAP3BARJ

Our Hi-Power ECU tune is calibrated to run this map sensor in place of the stock one along with the upgraded fuel pump and injectors.



Upgrade Actuator

11864 / 4592459079647

Part Number: WJ219UACT008T

To run with the Hi-Power ECU tune it will be necessary to install this 8psi Actuator.



Coil Heat Shield

11844 / 4582459079449

Part Number: WJ21990A4CAMT

Ceramic coated shield to keep the heat from the turbocharger away from the ignition coils.



Pressure Sensor Adaptor

11785 /

Part Number: MAPADAPT

This adaptor lifts the map sensor providing a simple connection point for adding a boost gauge to your vehicle when fitting our turbo kits.



AVO Suzuki Normally Aspirated Performance Packages

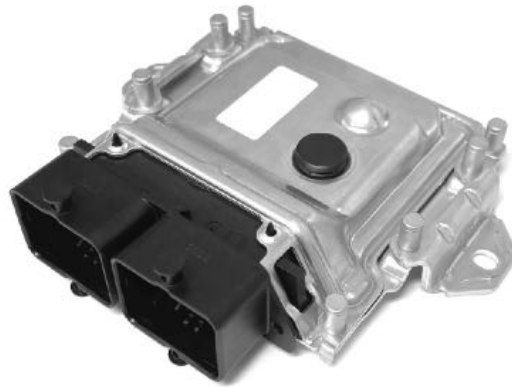

We offer 4 different stages of tune for the naturally aspirated Suzuki.

The first stage requires no additional hardware and is simply a re-mapping of the ECU to be more performance focused.

From stage 2 onwards each tune builds power and torque from the previous by adding AVO performance parts. The dyno sheets below compare each stage to the stock level.

Stage 1 - ECU Tune Only

11763 /

Part Number: WJ2199F7A002T

Stage 1 gives a good power and torque increase with the vehicle remaining in stock trim. As you can see by the dyno sheet the power goes from 47.7 kilowatts at the wheels to 52.5 kilowatts at the wheels which is a 10% increase while torque jumped from 89.9 nm at the wheels to 97.4 nm at the wheels which is an 8% increase in torque.

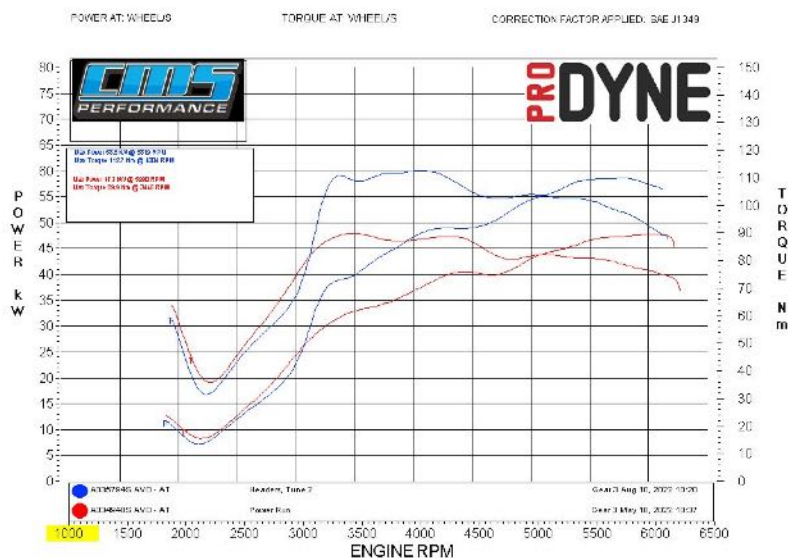

Stage 2 – Adds Hi-Flow Header

Part Number - Hi-Flow Header with Cat: WJ2199G3NCATJ

Part Number - Hi-Flow Header Straight: WJ2199G3NA18J

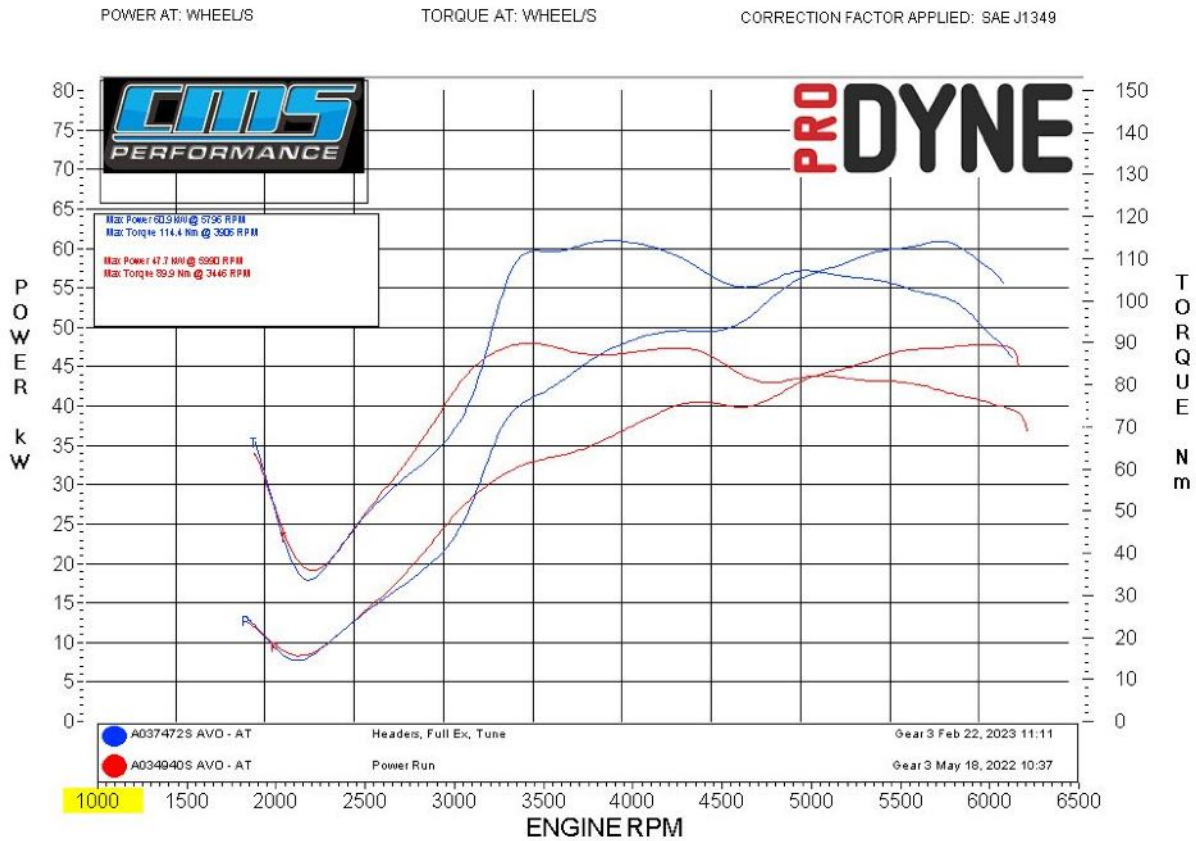

Stage 2 adds more power and torque due to the replacement of the restrictive standard header. Power is now up to 58.6 kilowatts at the wheels which is a 22% increase while torque has climbed to 112.7 nm at the wheels which is a 20% increase.

The Hi-Flow Catted Header is designed for on road use and the Straight Header option is for off road use. If choosing the Straight header expect an additional 2 kilowatts at the wheels compared to the Catted unit.

Stage 3 – Adds Header Back Exhaust System

Part Number - Header Back Exhaust: WJ219F3KA001T

Stage 3 removes further back pressure by replacing the full stock exhaust with the addition of our high flowing system. Power is now up to 60.9 kilowatts at the wheels which is a 28% increase while torque has increased to 114.4 nm at the wheels which is a 27% increase.

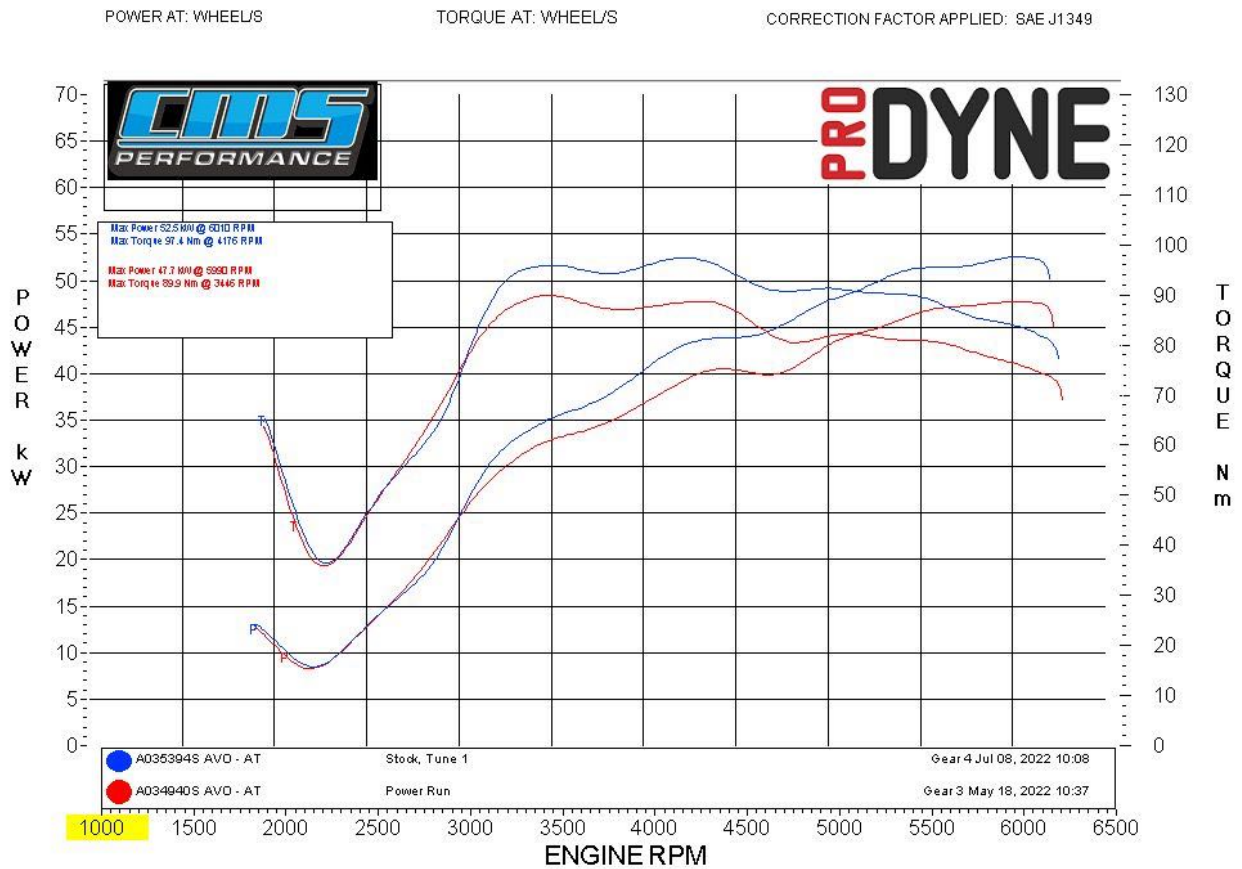

Stage 4 – Adds Intake and Air-box Kit.

Part Number - Intake with Air-box (Snorkel Compatible) WJ219F02ABOXT

Part Number - Open Power Filter Kit WJ219F02A001T

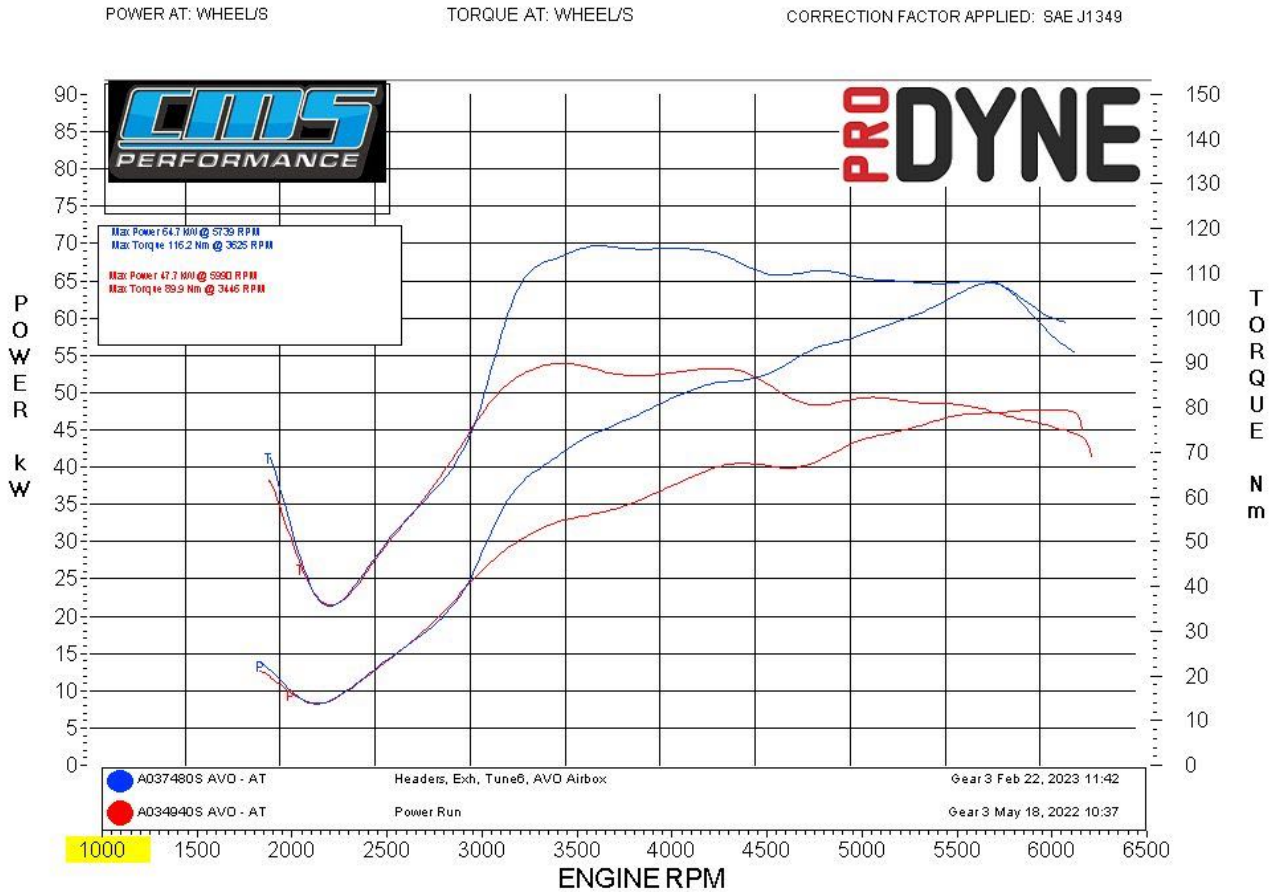

Stage 4 replaces the stock intake system to further improve airflow. Power is now up to 64.7 kilowatts at the wheels which is a 35% increase while torque has jumped to 116.2 nm at the wheels which is a 29% increase.

This is currently the best naturally aspirated tune we offer.

Naturally Aspirated Silicone Intake / Throttle Body Hose Kit

Part Numbers: WJ219941AREDT	11799 / 4582459077841
WJ219941AORGT	11800 / 4582459077858
WJ219941ABLKT	11801 / 4582459077827
WJ219941ABLUT	11802 / 4582459077834

AVOTurboworld designed its Silicone Throttle Body hose with 5-ply silicone reinforcing for use with the stock throttle body. It increases flow by eliminating the convolutions in the factory hose and is more durable than the OEM hose.



Naturally Aspirated Power Filter Kit

11711 / 4582459077421

Part Number: WJ219F02A001T

This kit comes with stainless steel intake pipe with mounting bracket, pod filter & hose clamp. To see the full benefits this intake offers it is required to re-tune the ECU.



Naturally Aspirated Power Filter and Air-box Set

11752 / 4582459077476

Part Number: WJ219F02ABOXT

Our specially designed air-box that encloses the AVO pod filter inside the box and is totally sealed off from water and contaminants.

To see the full benefits this part offers it is required to re-tune the ECU.

Replacement Power Filter

41905 /

Part Number: ENLEEC002

For all AVO Suzuki Power Filter Kits.

Flat Panel Air Filter - OEM Air-box

11805 / 4582459077865

Part Number: WJ219943A001T

Our high-flow drop-in flat panel air filter for the factory OEM air box.



Naturally Aspirated Header with Hi-Flow Cat

11727 / 4582459077407

Part Number: WJ2199G3NCATJ

Our design features 1.75" mandrel bent 2mm thick 304 stainless steel, extra thick stainless steel CNC machined head flange, and the heart of the design is AVO's exclusive 4 into 1 cast stainless steel merge collector and finally our hi-flow design cat converter. To see the full benefits this part offers it is required to re-tune the ECU.



Naturally Aspirated Header Straight (Race use Only)

11718 / 4582459077810

Part Number: WJ219G3NA018J

Ceramic coated 1.75" mandrel bent 2mm thick 304 stainless steel, extra thick stainless steel CNC machined head flange, and the heart of the design is AVO's exclusive 4 into 1 cast stainless steel merge collector. To see the full benefits this part offers it is required to re-tune the ECU.



3D Naturally Aspirated 2.0in Header Back Exhaust 11749 / 4582459077452

Part Number: WJ219F3KA001T

Designed specifically to have a minimum of bends while maintaining a bolt-on fit, allowing for maximum flow and a great note that accentuates the engine sound. Comes with a Hi-Flow catted front pipe that maintains the factory flex setup, centre muffler pipe, intermediate s-pipe, and a rear resonated pipe with 2 1/2" down pointed polished exhaust tip. To see the full benefits this part offers it is required to re-tune the ECU.

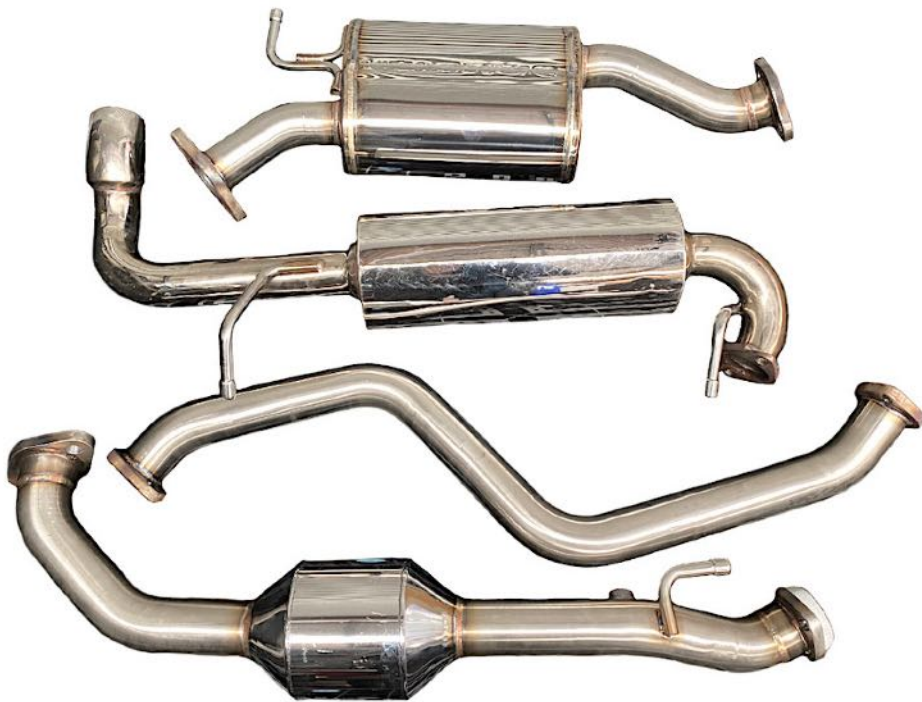

Adjustable Stabilizer Bar End-link - Front

11873 / 4582459078695

Part Number: S1H04M1GUB90J

Improved sway bar performance means improved concerning when driving, these end links are adjustable between 90mm - 100mm.



Front Stabilizer Bar Bush

11867 / 4582459079661

Part Number: WJ21997GV027T

By replacing the soft rubber sway bar bushing with a much stronger polyurethane bush, it will help enhance the sway bars performance.

