

BACKBANDS

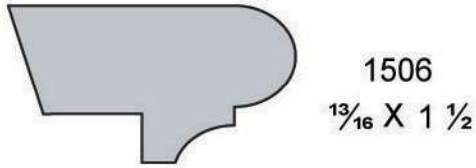

BASE CAPS

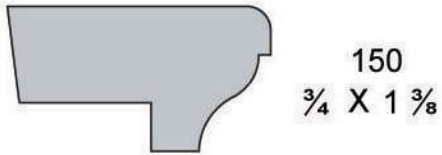
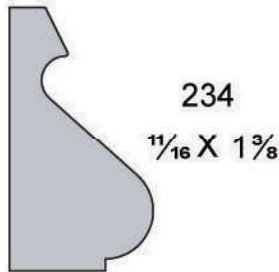
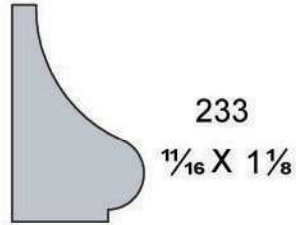
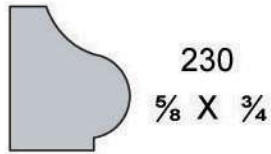

BASE SHOE

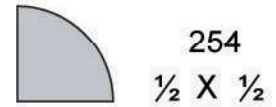
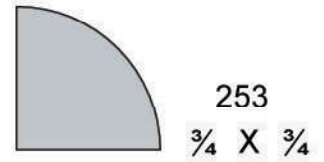
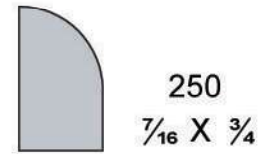

SCOTIA

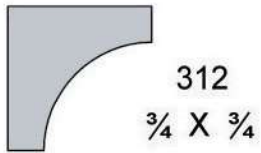

DOOR STOP

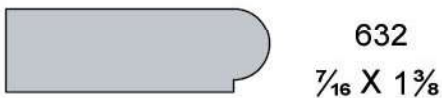

WAINSCOT CAP

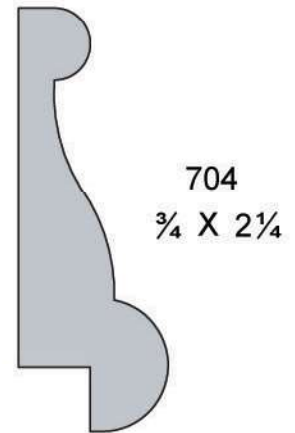

WINDOW/HEAD CAPS

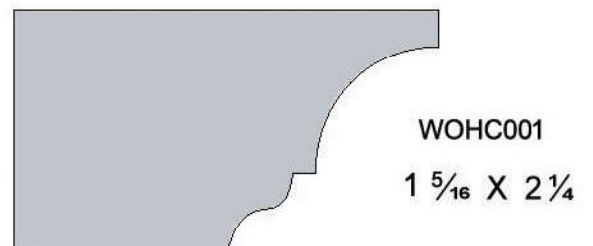
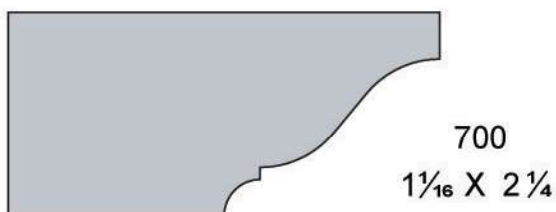

CASING & BASEBOARD



214
 $\frac{3}{4} \times 3 \frac{1}{4}$

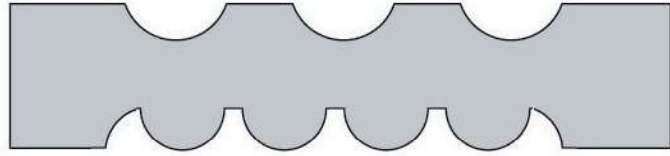

1504
 $\frac{3}{4} \times 3 \frac{1}{2}$



217
 $\frac{3}{4} \times 5 \frac{1}{4}$

PICTURE

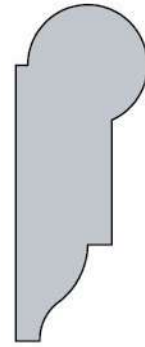

731
 $1 \frac{1}{16} \times 1 \frac{3}{4}$

CROWN

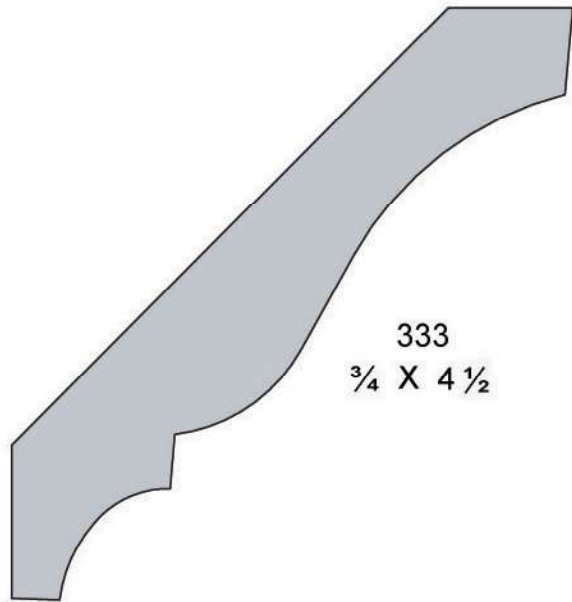

333
 $\frac{3}{4} \times 4 \frac{1}{2}$

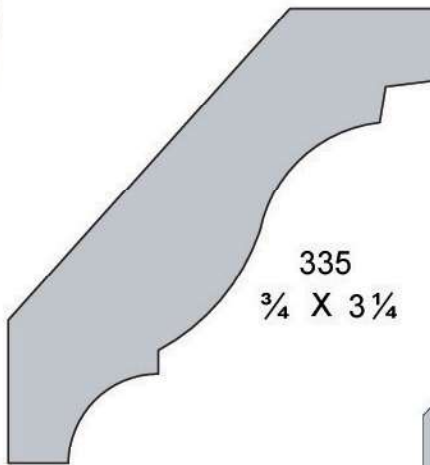

335
 $\frac{3}{4} \times 3 \frac{1}{4}$

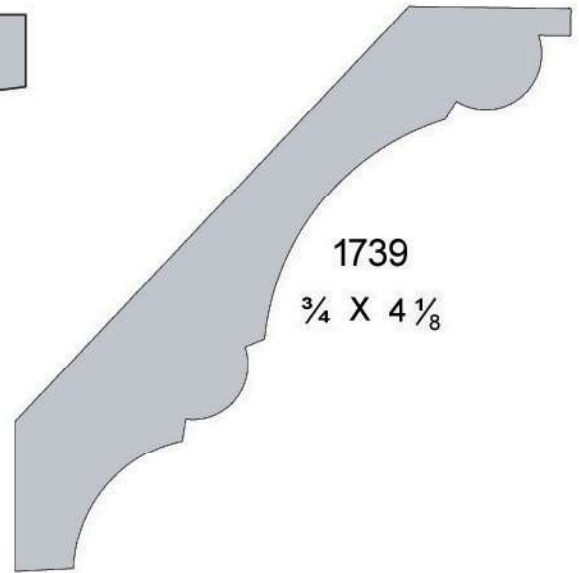

1739
 $\frac{3}{4} \times 4 \frac{1}{8}$

WAINSCOT & SHADOW GAP

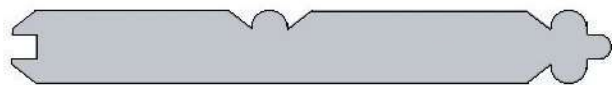

1319
 $\frac{3}{8} \times 3$



SHADOWGAP 6 $19/32 \times 5-3/8$

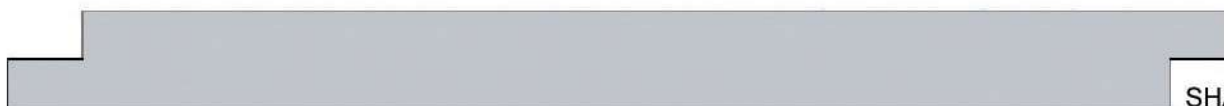

SHADOWGAP 8 $19/32 \times 7-3/8$

FILLET/SHOE

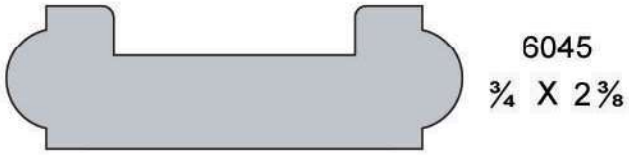
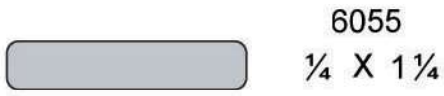

HAND RAIL

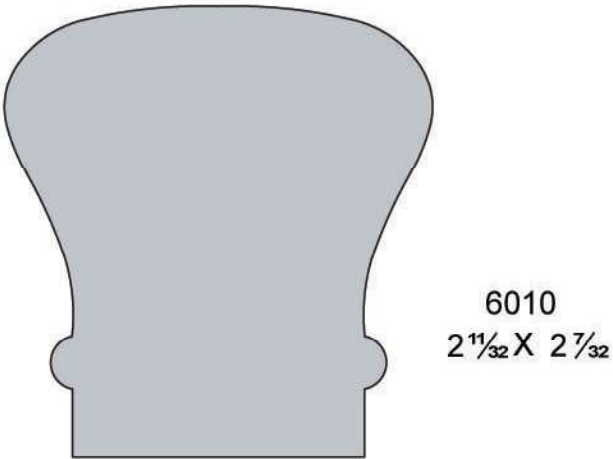
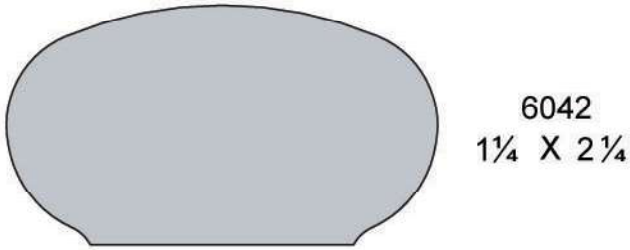
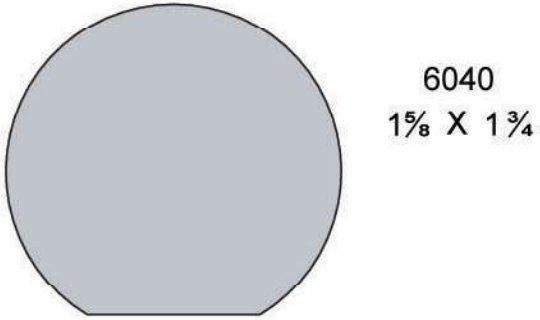

ROSETTE

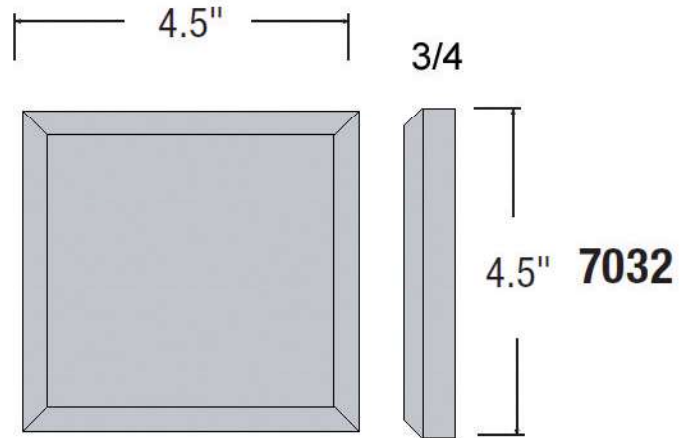
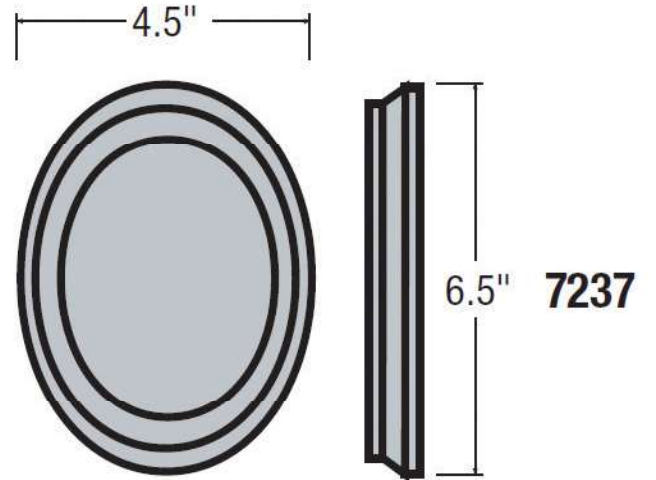
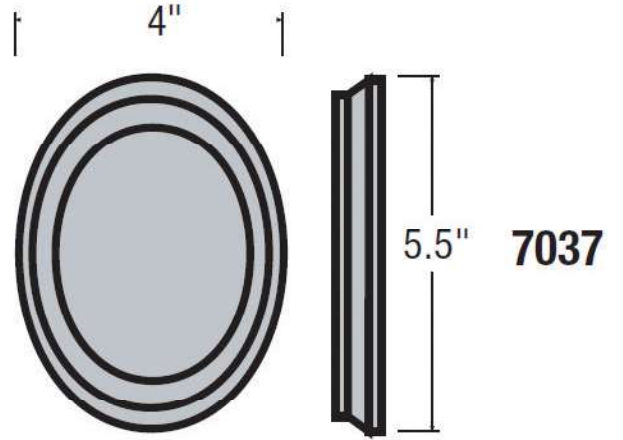

LANDING NOSING



RAIL HARDWARE

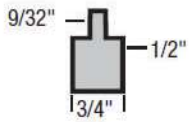

3006
Dowel Pin

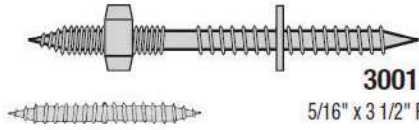

3001
5/16" x 3 1/2" Rail Bolt



3005
5/16" x 2 1/2" Baluster Bolt

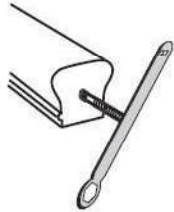

3092
Rail Bolt Wrench



3007
Newel Mounting Kit

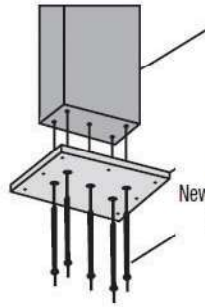

3020
Newel Mounting Plate With Trim



3002
Light Duty Wall Bracket



3003
Heavy Duty Wall Bracket

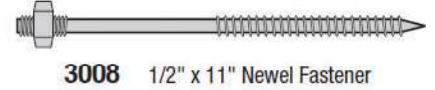

3008 1/2" x 11" Newel Fastener



3001 Driver



3005 Driver

NEWELS

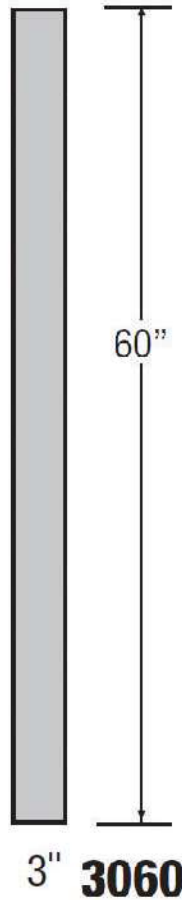
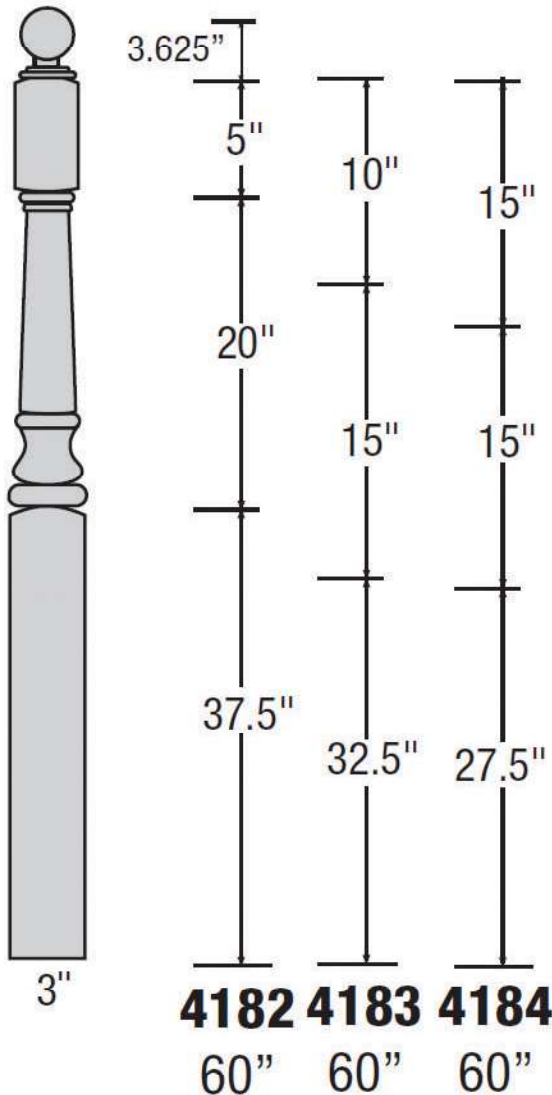

BALUSTERS

