

## BACKBANDS

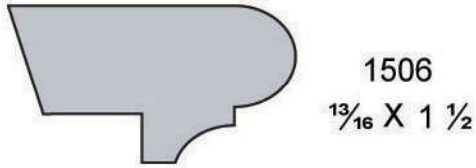

## BASE CAPS

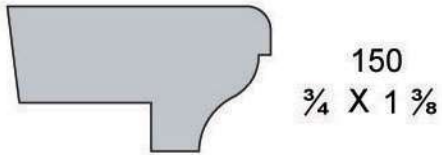
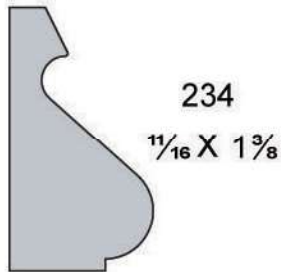
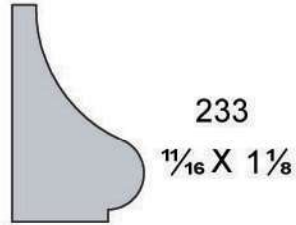
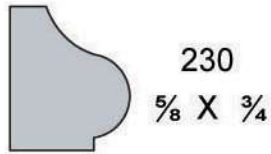

## BASE SHOE

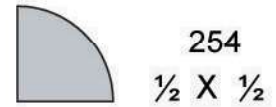
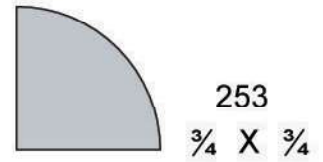
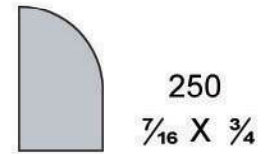

## SCOTIA

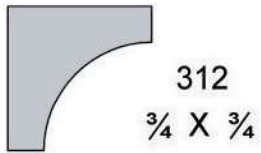

## CHAIR RAIL

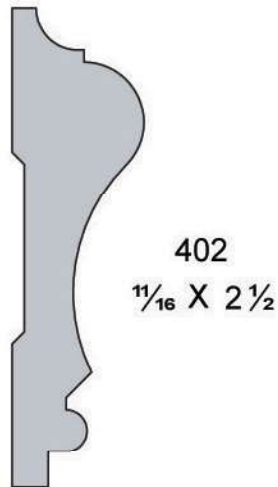

## WAINSCOT CAP

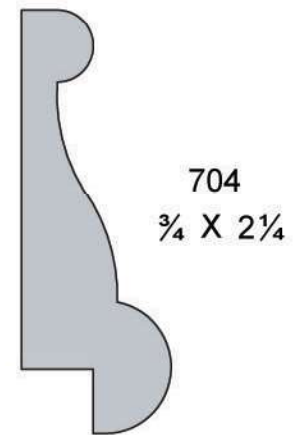

## DOOR STOP

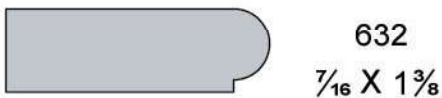

## WINDOW/HEAD CAPS

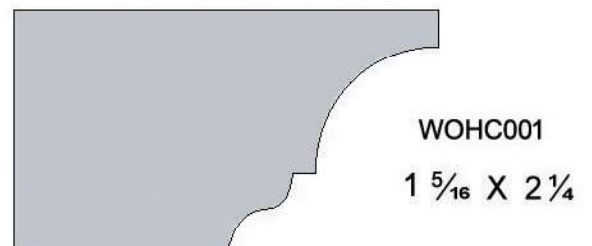
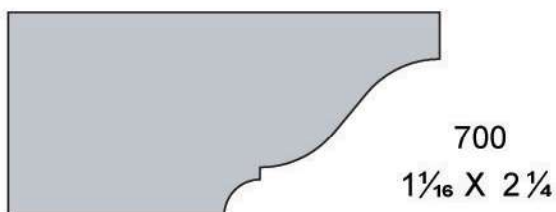

# CASING & BASEBOARD

---

# PICTURE

---



214  
 $\frac{3}{4} \times 3 \frac{1}{4}$

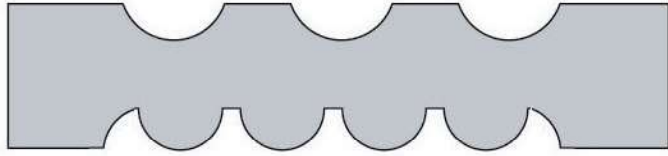

1504  
 $\frac{3}{4} \times 3 \frac{1}{2}$

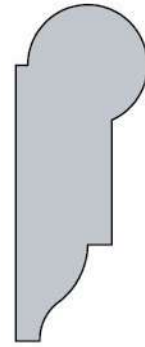

731  
 $1 \frac{1}{16} \times 1 \frac{3}{4}$



217  
 $\frac{3}{4} \times 5 \frac{1}{4}$

# CROWN

---

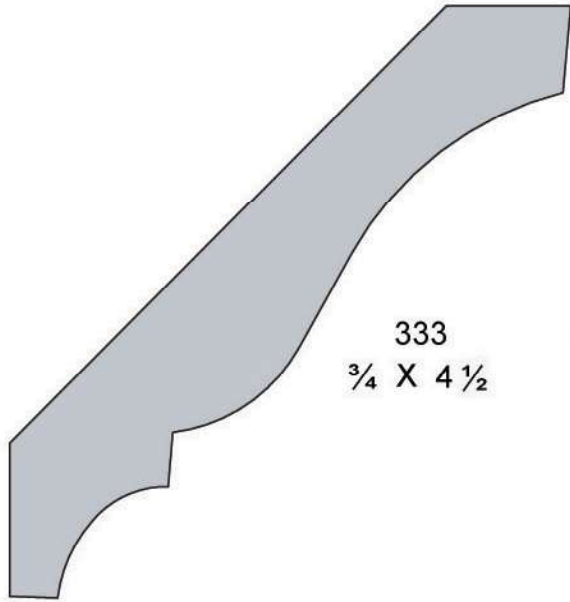

333  
 $\frac{3}{4} \times 4 \frac{1}{2}$

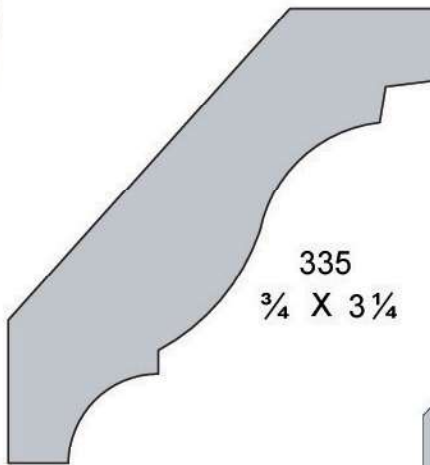

335  
 $\frac{3}{4} \times 3 \frac{1}{4}$

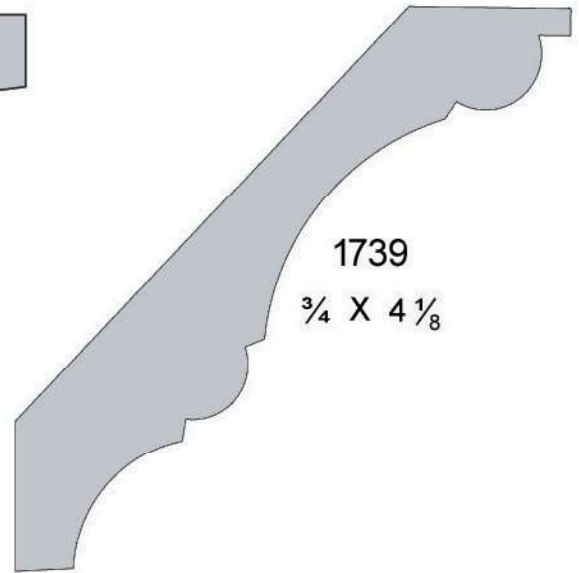

1739  
 $\frac{3}{4} \times 4 \frac{1}{8}$

# WAINSCOT & SHADOW GAP

---

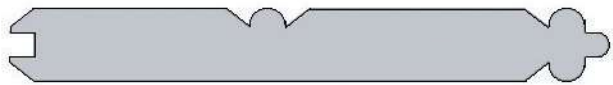

1319  
 $\frac{3}{8} \times 3$

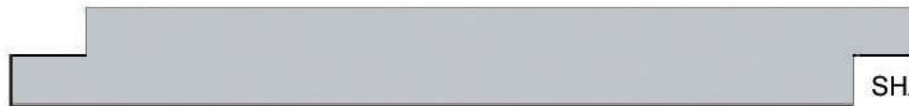

SHADOWGAP 6  $19/32 \times 5-3/8$



SHADOWGAP 8  $19/32 \times 7-3/8$

# FILLET/SHOE

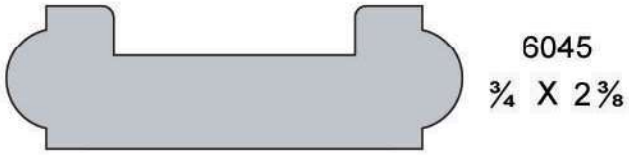
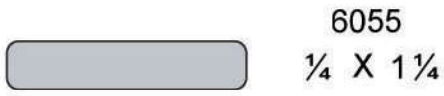

# HAND RAIL

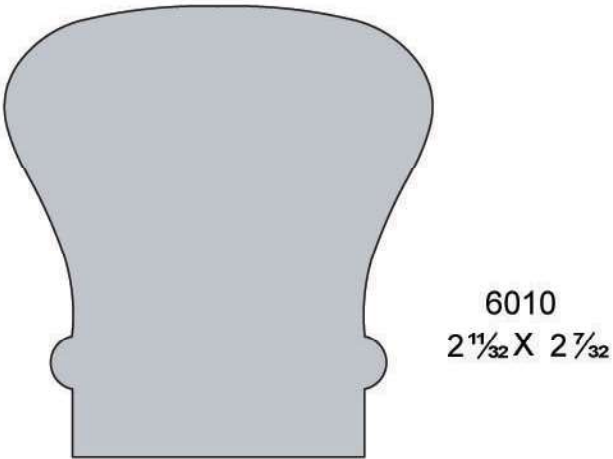
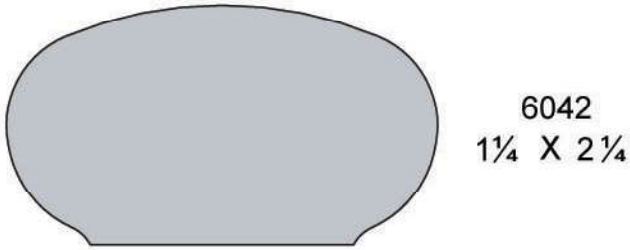
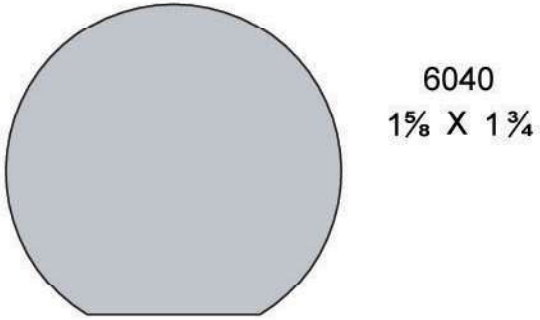

# ROSETTE

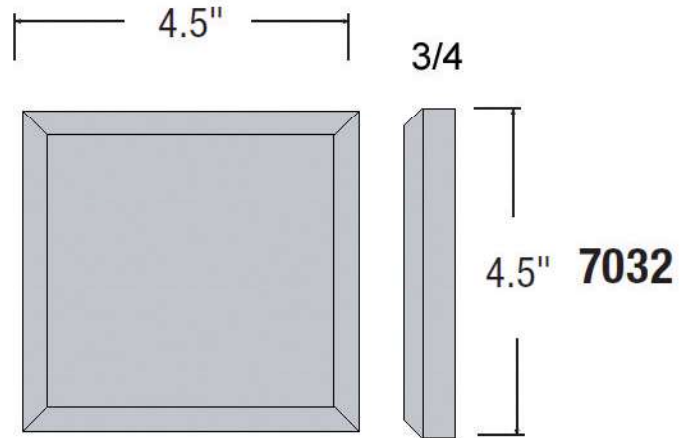
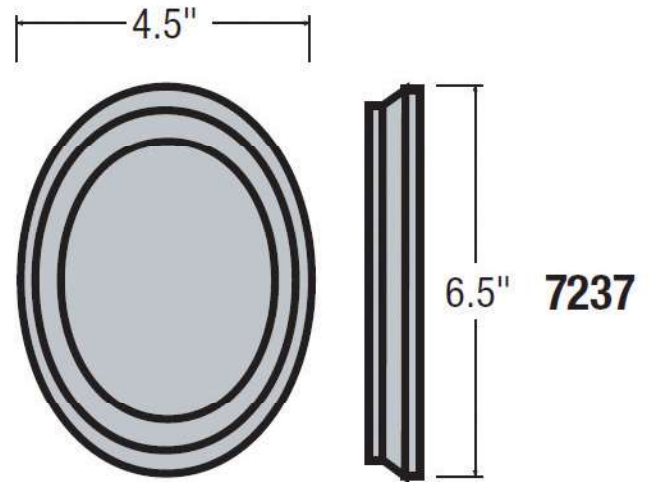
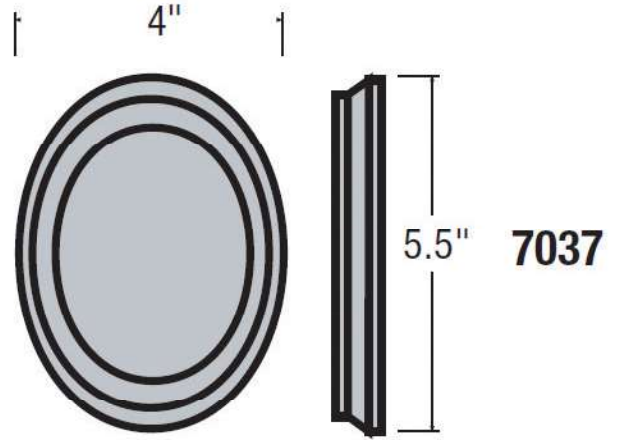

# LANDING NOSING



# RAIL HARDWARE

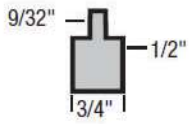

**3006**  
Dowel Pin

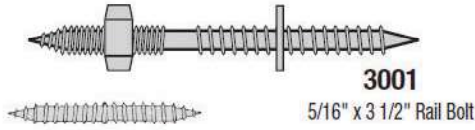

**3001**

5/16" x 3 1/2" Rail Bolt



**3005**  
5/16" x 2 1/2"  
Baluster Bolt

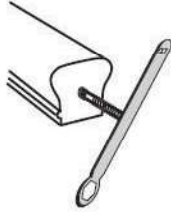

**3092**  
Rail Bolt Wrench



**3007**  
Newel Mounting Kit

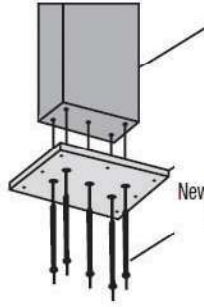

**3020**  
Newel Mounting Plate  
With Trim



**3002**  
Light Duty Wall Bracket



**3003**  
Heavy Duty Wall Bracket

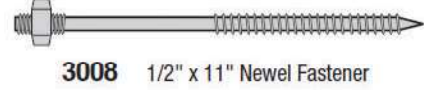

**3008** 1/2" x 11" Newel Fastener



**3001** Driver



**3005** Driver

# NEWELS

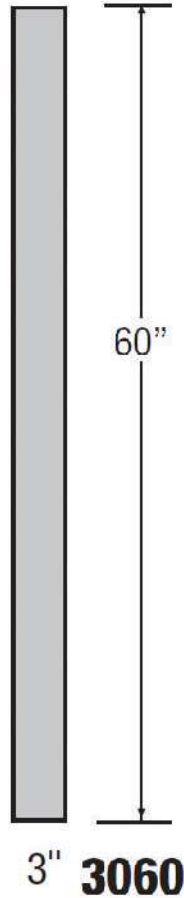
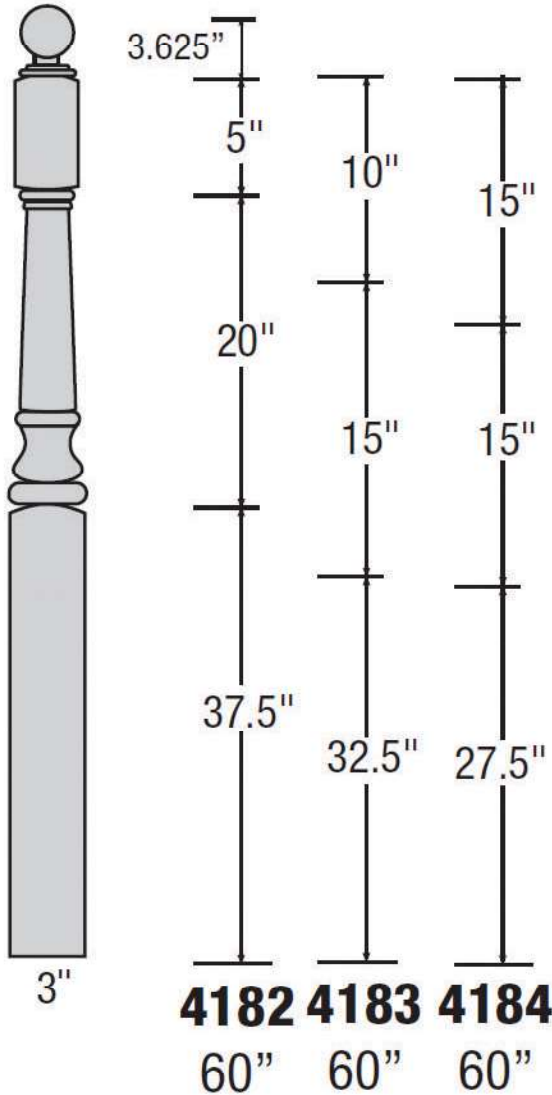

# BALUSTERS

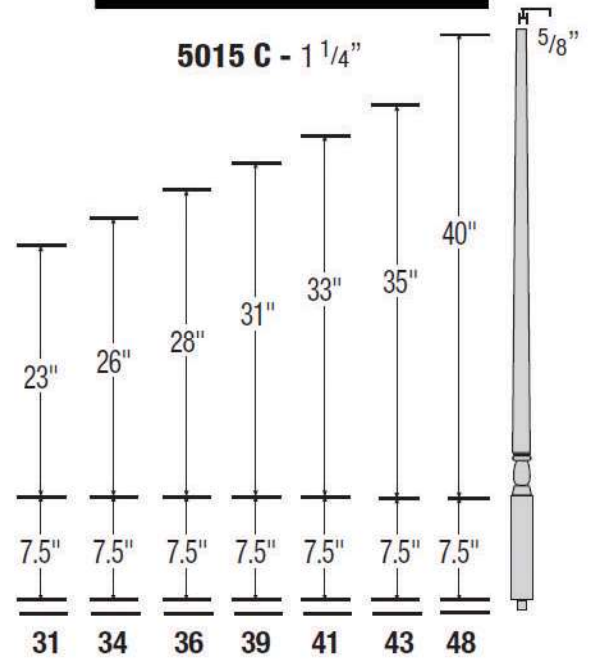

**5015 C - 1 1/4"**

**5060 - 1 1/4"**



**36 42**