



USC School of Dramatic Arts

RENT

MAGIC SHEET

Lighting Designer: Fernando Gonzalez
Bing Theatre, April 2024

A - TOP

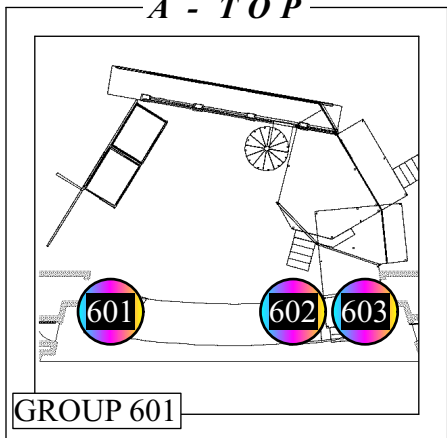

GROUP 601

A - FRONT

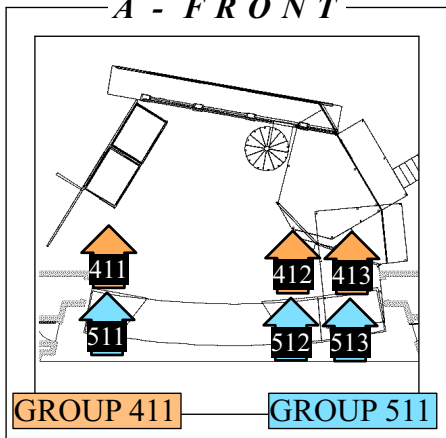

GROUP 411

GROUP 511

A - BACKLIGHT

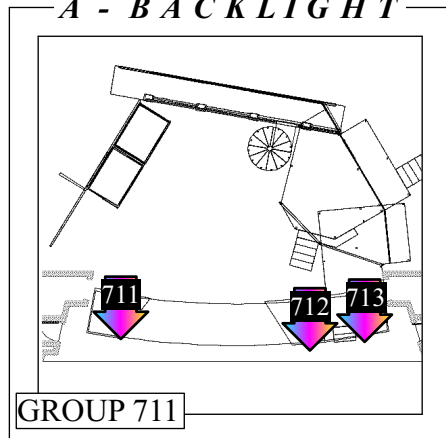

GROUP 711

B - TOP

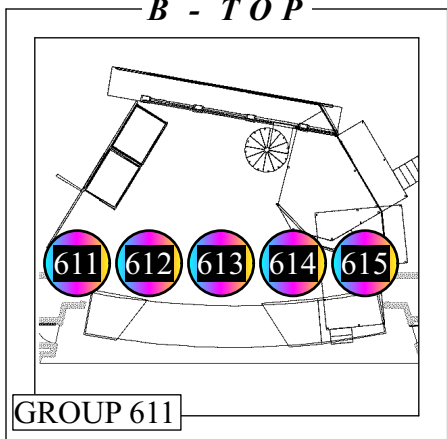

GROUP 611

B - FRONT

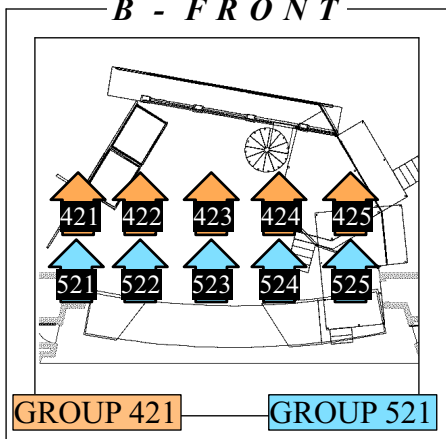

GROUP 421

GROUP 521

B - SIDES

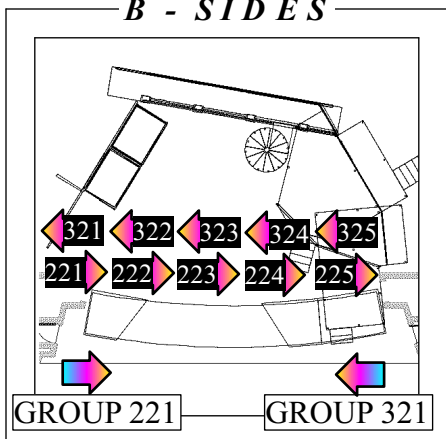

GROUP 221

GROUP 321

B - BACKLIGHT

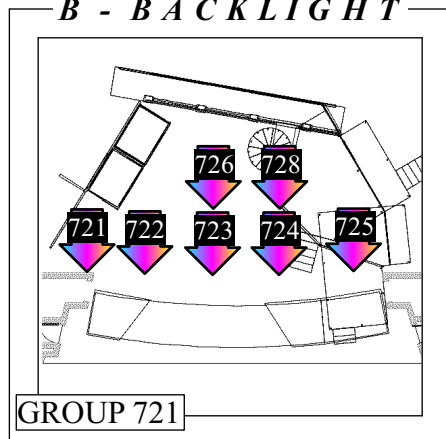

GROUP 721

C - TOP

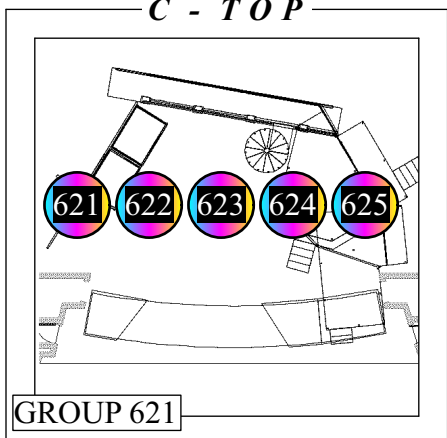

GROUP 621

C - FRONT

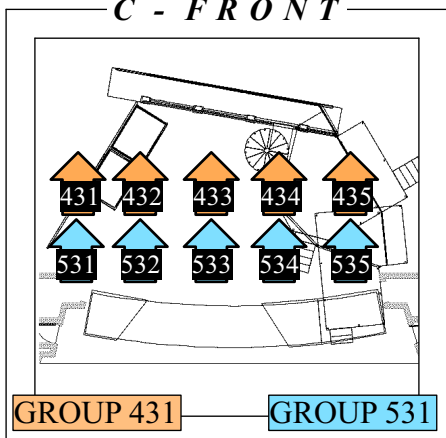

GROUP 431

GROUP 531

C - SIDES

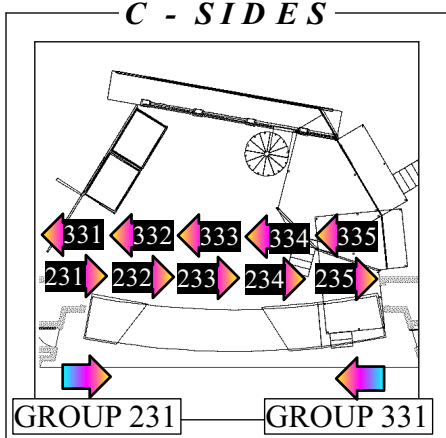

GROUP 231

GROUP 331

C - BACKLIGHT

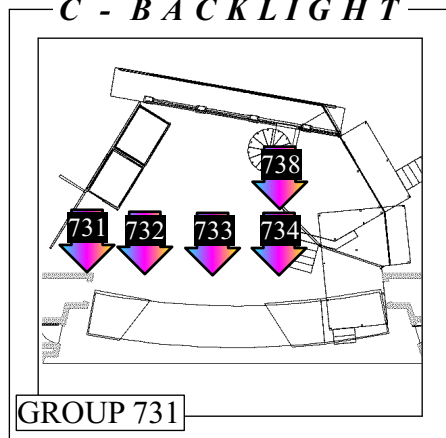

GROUP 731

D/E - TOP

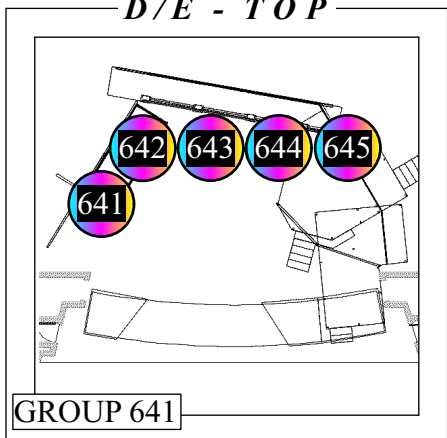

GROUP 641

D/E - FRONT

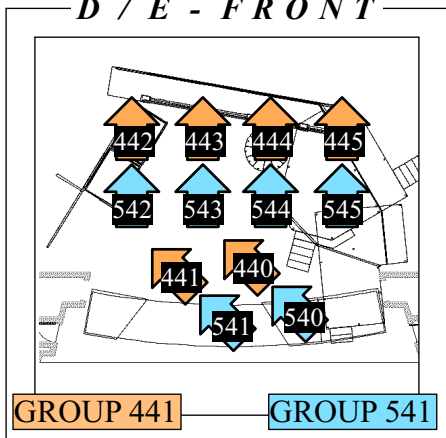

GROUP 441

GROUP 541

D/E - SIDES

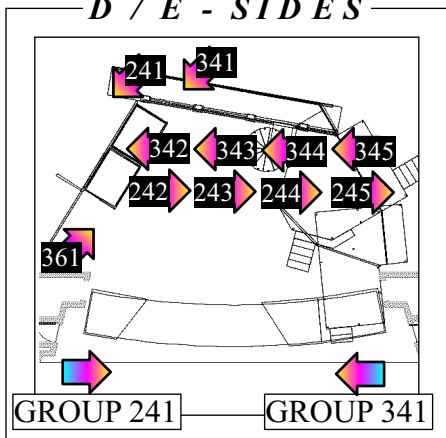

GROUP 241

GROUP 341

D/E - BACKLIGHT

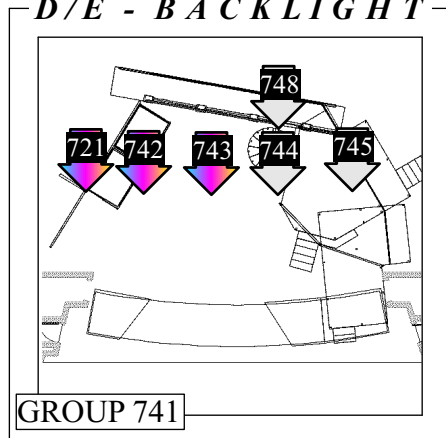

GROUP 741

F/G - TOP

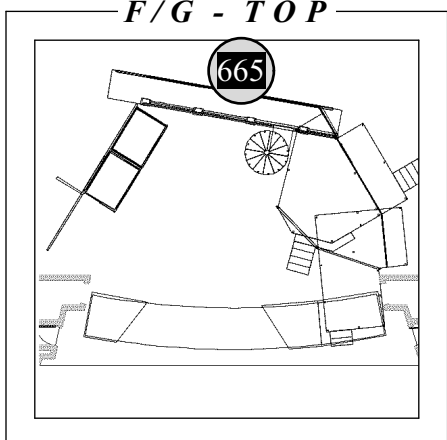

GROUP 665

F/G - FRONT

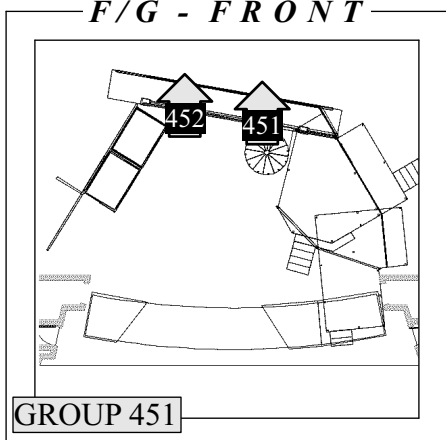

GROUP 451

F/G - SIDES

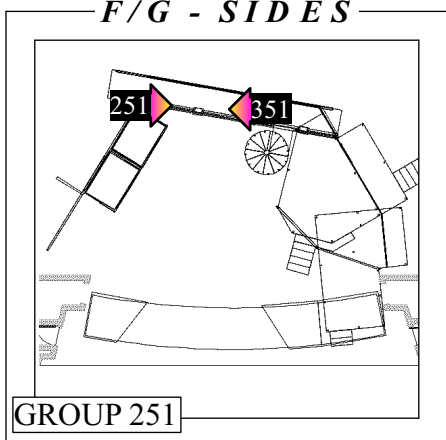

GROUP 251

F/G - BACKLIGHT

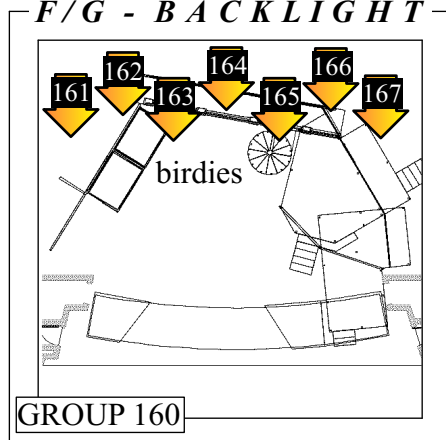

GROUP 160