

Guide to Teachers' Resource Sheets on Fisheries for the Cook Islands



Ministry of Marine Resources
GOVERNMENT OF THE COOK ISLANDS



COOK ISLANDS
Ministry of Education
Maraurau o te Pae Api'i



SPC
Secretariat
of the Pacific
Community

All rights for commercial / for profit reproduction or translation, in any form, reserved. SPC authorises the partial reproduction or translation of this material for scientific, educational or research purposes, provided that SPC and the source document are properly acknowledged. Permission to reproduce the document and/or translate in whole, in any form, whether for commercial / for profit or non-profit purposes, must be requested in writing. Original SPC artwork may not be altered or separately published without permission.

Original text: English

Secretariat of the Pacific Community Cataloguing-in-publication data

King, Mike

Teachers' Resource Kit on Fisheries for the Cook Islands / compiled by Mike King, Michel Blanc, Aymeric Desurmont, Michael Sharp and Céline Barré

1. Fisheries — Cook Islands — Handbooks, manuals, etc.
2. Fishery management — Study and teaching — Cook Islands.

I. King, Mike II. Blanc, Michel III. Desurmont, Aymeric IV. Sharp, Michael V. Barré, Céline
VI. Title VII. Secretariat of the Pacific Community

639.20995

AACR2

ISBN: 978-982-00-0696-6

Secretariat of the Pacific Community
Coastal Fisheries Programme
BP D5, 98848 Noumea Cedex, New Caledonia
Tel: +687 26 20 00
Fax: +687 26 38 18
Email: spc@spc.int; <http://www.spc.int/>

Prepared for publication and printed at
Secretariat of the Pacific Community headquarters
Noumea, New Caledonia, 2014

GUIDE to Teachers' Resource Sheets on Fisheries for the Cook Islands



This guide has been prepared for teachers in Cook Islands after discussions with local education and fisheries authorities. The guide is part of and should be used in conjunction with, the SPC Teachers' Resource Kit on Fisheries, the contents of which includes:

- 20 Teachers' Resource Sheets on Fisheries;
- 29 SPC Information Sheets for Fishing Communities;
- four fish posters;
- one invertebrate poster;
- one sea safety poster;
- one marine debris poster;
- a DVD and/or flash drive (with graphics and photographs).

This guide includes suggestions for exercises and activities for younger and older students, learning outcomes and curriculum links. It is expected that teachers will use their local knowledge and expertise to adapt, extend and add to these. The number and headings on the following pages refer to those on the Teachers' Resource Sheets on Fisheries (1 to 20) and on the Information Sheets for Fishing Communities (1 to 29). The latter 29 sheets were designed for fishing communities but contain much information useful to teachers and students.

All words followed by an asterisk () in the Teachers' Resource Kit on Fisheries are defined in the glossary on page 27 of this guide.*



1. Fisheries management

At the completion of studies:

Younger students will realise the need for fisheries management and the need for regulations to control fishing and catches.

Older students will be aware of the need for fisheries regulations and understand the types of regulations imposed. They will be able to determine the relationship between fish length and egg production and appreciate the need to leave some large fish in the sea.

In Cook Islands, fisheries are managed by the Ministry of Marine Resources (MMR) often working with local community leaders. A particular fisheries management tool for which Cook Islands is well known is its *Ra'ui* (see Teachers' Resource Sheet 4: No-take areas).

For younger and older students

Social Science. Strand: Resources and Economic Organisation; Level 1–3

- Request MMR to have a fisheries officer talk to students about fisheries management. What fisheries regulations have been imposed on local fisheries and why are they needed?
- Why is it important to leave some large female fish in the sea?

Mathematics. Strand: Measurement; Level 3

Most fish grow in length, width and height at the same rate (growth is said to be isometric). Egg production is related to the volume of female fish — that is, there is a cubic relationship between length and volume (and therefore egg production). If a mature fish doubles in length, how much does volume and therefore egg production, increase? (For younger students — count the “blocks” in the above diagram or use eight wooden blocks to suggest what happens when a fish doubles in length, width and height).

For older students

Mathematics. Strand: Statistics and Probability; Level 4–5

- In the figure below, volume (V) = length (L) cubed, or $V = L^3$. For example, a fish 30 cm long would have a volume related to $V = L^3$ or 30^3 or 27,000 cubic centimetres. If the fish doubles in size to 60 cm, $V = 60^3$, that is 216,000 cubic centimetres. That is, the egg carrying capacity has increased by eight times.

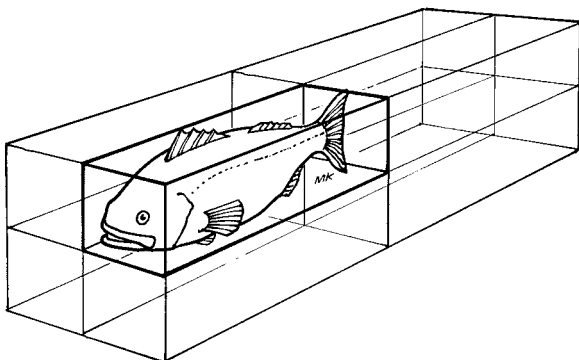

Have students collect a large number of one species of fish with a wide range of small to large sizes (alternatively the fish can be obtained by the teacher). Each fish should be measured to the nearest 5 millimetres and weighed to the nearest 10 grams.

Enter the data on an EXCEL spreadsheet and prepare a graph relating weight to length as in the example shown below.

Students studying statistics can extend the exercise to include the power curve equation and measures of goodness-of-fit. The power curve equation is of the form $\text{Weight} = a (\text{Length})^b$ where a is a constant and b should be close to 3 if the volumetric relationship holds true.

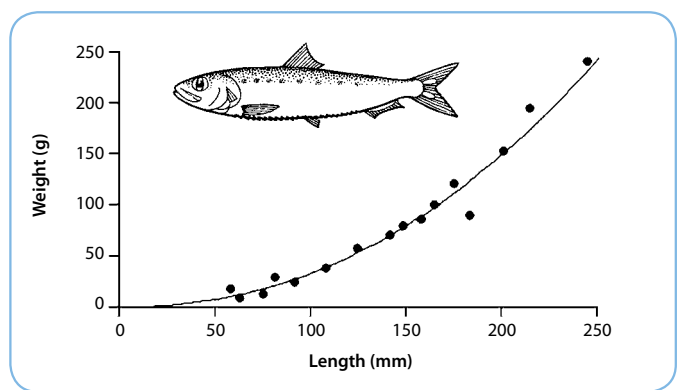

- Although the rate of population increase in Cook Islands is low, the rate in many other Pacific Islands is as high as 4% each year. Build an EXCEL spreadsheet using rates of 2%, 3%, 4% and 5%, to calculate when the population will be twice what it is today. Discuss the problems for local people in catching seafood when the population is doubled.
- Ask students to investigate the ways in which the local marine environment is being harmed — should excessive development be controlled, are trees left on the banks of rivers and coastlines, is garbage disposal satisfactory, is sewage treatment adequate?

2. Fisheries assessment

At the completion of studies:

Younger students will realise the need for fisheries assessments including the use of a 7-day fishing log to record catches in an extended family or community.

Older students will be aware of the need for fisheries assessments including the use of a 7-day fishing catch log and the use of fish tagging and quadrat sampling to estimate fish population size.

Scientists from MMR have completed assessments of many exploited marine species and these have been used in fisheries management. One example is the assessments of local trochus stock sizes and using these to set a quota* or catch limits for community fishers.

For younger students

Science. Strand: Living World; Aim 3, Level 1–2

- A. Ask students to identify the common Cook Islands reef fish and oceanic fish from the posters supplied in the Teachers' Resource Kit on Fisheries.

For younger and older students

Social Science. Strand: Resources and Economic Organisation; Level 2–3

Science. Strand: Scientific Skills, Information Gathering; Level 2–3

- B. Ask each student to keep a 7-day log of fish catches in their extended family. How much fish did they catch? How much fish did they buy? An example of a student 7-day basic fishing log is shown in the table below. The log can be extended to discover how much other meat is bought, etc.

If the exercise is done well, the information in these logs may be useful to MMR.

Student name							
Time period from Saturday	to Friday						
Area / Fishing location							
	Sat	Sun	Mon	Tues	Weds	Thurs	Fri
No. of people fishing							
Main method of fishing							
Total hours fishing							
Number of (species)							
Number of (species)							
Number of (species)							
Number of (species)							
Number of (species)							
ETC							

Students should use the fish posters to confirm identity of species used in the above log.

For older students

Social Science. Cultural Development and Change; Level 2–3

- C. Ask students to interview older fishers in their community or extended family. How long does it take to catch a basket or string or number of a particular fish at present? How long did it take 5 years ago? How long did it take 10 years ago?

Each student should record the information from the interviews. Has there been a decrease in catch rates? If so, ask the fishers why has this happened? What could go wrong by relying on the memories of people?

Science. Strand: Living World; Aim 4, Level 6

Science. Strand: Scientific Skills, Information gathering; Level 3–4

Mathematics. Strand: Statistics and Probability, Level 3–4

- D. Fisheries scientists tag or mark fish to examine fish migration, death rates and population size. Use the figure in Teachers' Resource Sheet 2: Fisheries assessment to discuss methods of tagging of marine species. The following activity uses beads to demonstrate how fish tagging can be used to estimate the population size of fish.
- E. Spread a few thousand small white beads on a large tray (the actual number of white beads should be known to the teacher although this is not necessary). Add a smaller number, about 300, black beads to the tray — provide the actual number of black beads to the students. All the beads should be mixed up so that the black beads are randomly distributed with the white beads in the tray.

To add some interest, ask students to guess the total number of black and white beads on the tray. The white and black beads added together represent a population of fish (N). The black beads represent the tagged fish (T).

Divide the students into groups of two or three and give each group an empty tray. One student from each group should use a rectangular plastic container (about the size of a match-box, depending on the size of the beads) to represent the fishing gear. Without looking, the student should drag the container across the tray to "catch" a sample of the beads.

After emptying the caught beads in the group's tray, the students must count the number of black beads caught — these represent the recaptured tagged fish (R).

Count the number of white beads caught. This number added to the number of black beads represents the total catch (C).

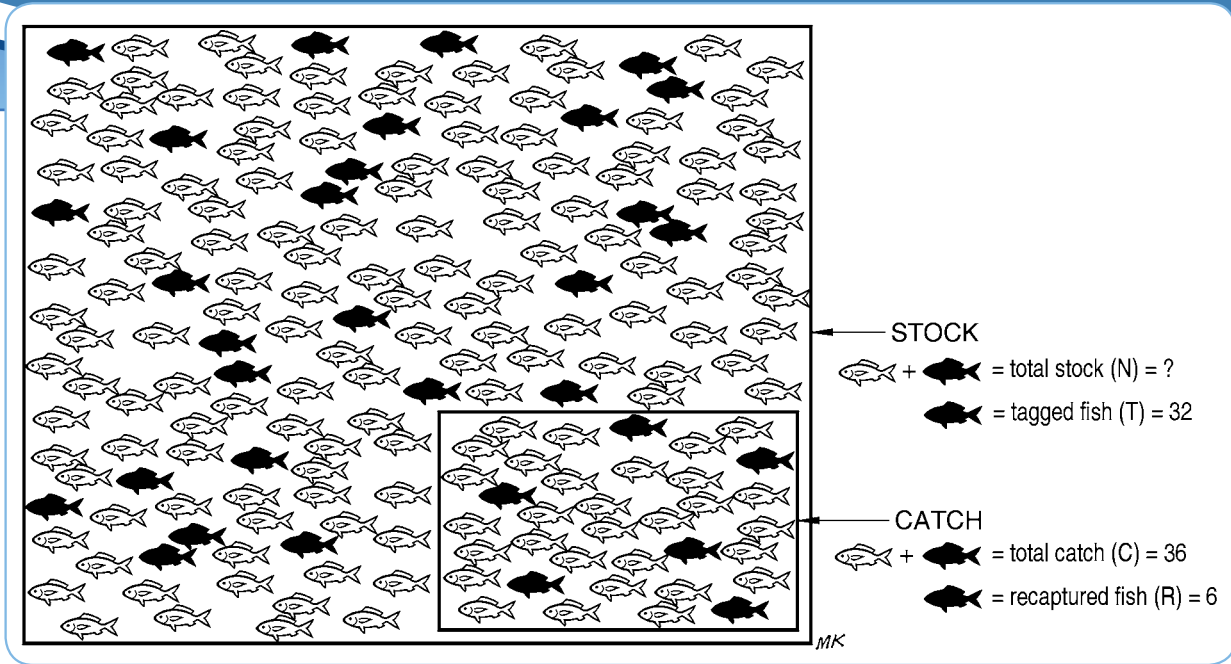

Use the information to estimate the population or stock size (N) as demonstrated in the figure and example above.

The large rectangle in the figure shows a fish stock of unknown size, into which 32 tagged fish (solid shapes) were released. At a later time, a catch of 36 fish (in the small rectangle in the lower right-hand corner) was found to include 6 tagged individuals. The stock size may be estimated by assuming that the ratio of tagged fish (T) in the stock (N) is equal to the ratio of recaptured tagged fish (R) in the catch (C). That is:

$$T/N = R/C$$

From this, an estimate of the stock size (N) may be obtained as:

$$N = TC/R = (32 \times 36)/6 = 192 \text{ fish.}$$

Science. Strand: Living World; Aim 4, Level 5–6

Older students studying statistics can make a number of replicate catches and estimate the standard error and confidence limits.

The accuracy of the above method depends on several assumptions being met:

1. the tagged individuals must be distributed randomly over the population;
2. there must be no loss or gain of individuals during the experiment;
3. the tag must not alter the chance of a fish either surviving or being caught.

Have students discuss what happens if assumption number 3 is not true. For example,

1. if an external plastic spaghetti tag resulted in tagged fish being more likely to be caught by becoming entangled in a gill net; or,
2. if a tagged fish became stressed and would not take the bait on a fishing line as readily as untagged fish.

For the answers, think in terms of the equation $N = TC/R$. In the first case, R would be larger than it should be and N would be smaller (the population would be underestimated). In the second case, R would be smaller than it should be and N would be larger (the population would be overestimated).

Science. Strand: Scientific Skills, Information gathering; Level 3–4

Mathematics. Strand: Statistics and Probability, Level 3–4

F. The following question relates to the figure on next page in which the small black squares represent sea cucumbers distributed around a sand bank. The teacher should copy the figure full size on A4 sheets, one for each student or student group.

Have each student or student group randomly select 6 quadrats (the small squares). Statistics students could use random number tables to do this. Otherwise, one student in each group should use a pencil to touch the sheet 6 times without looking.

Count the number of sea cucumbers (black dots) in each of the 6 quadrats selected. Total the sea cucumbers from all 6 quadrats and divide the total number by 6 to estimate the mean number per quadrat.

Multiply the mean number per quadrat by the total number of quadrats (156). This is an estimate of the total population size. Why could this be inaccurate? If by chance, students had randomly picked quadrats from deeper than the 10 m depth contour, the population would be underestimated. Alternatively, if all 6 quadrats were from between 5 and 10 m depth, the population would be overestimated.

As a preferred method, sample along a transect, say by selecting every second small square along column G. Have students discuss why this method is likely to be more accurate.

Senior students studying statistics could estimate the population size with 95% confidence limits.

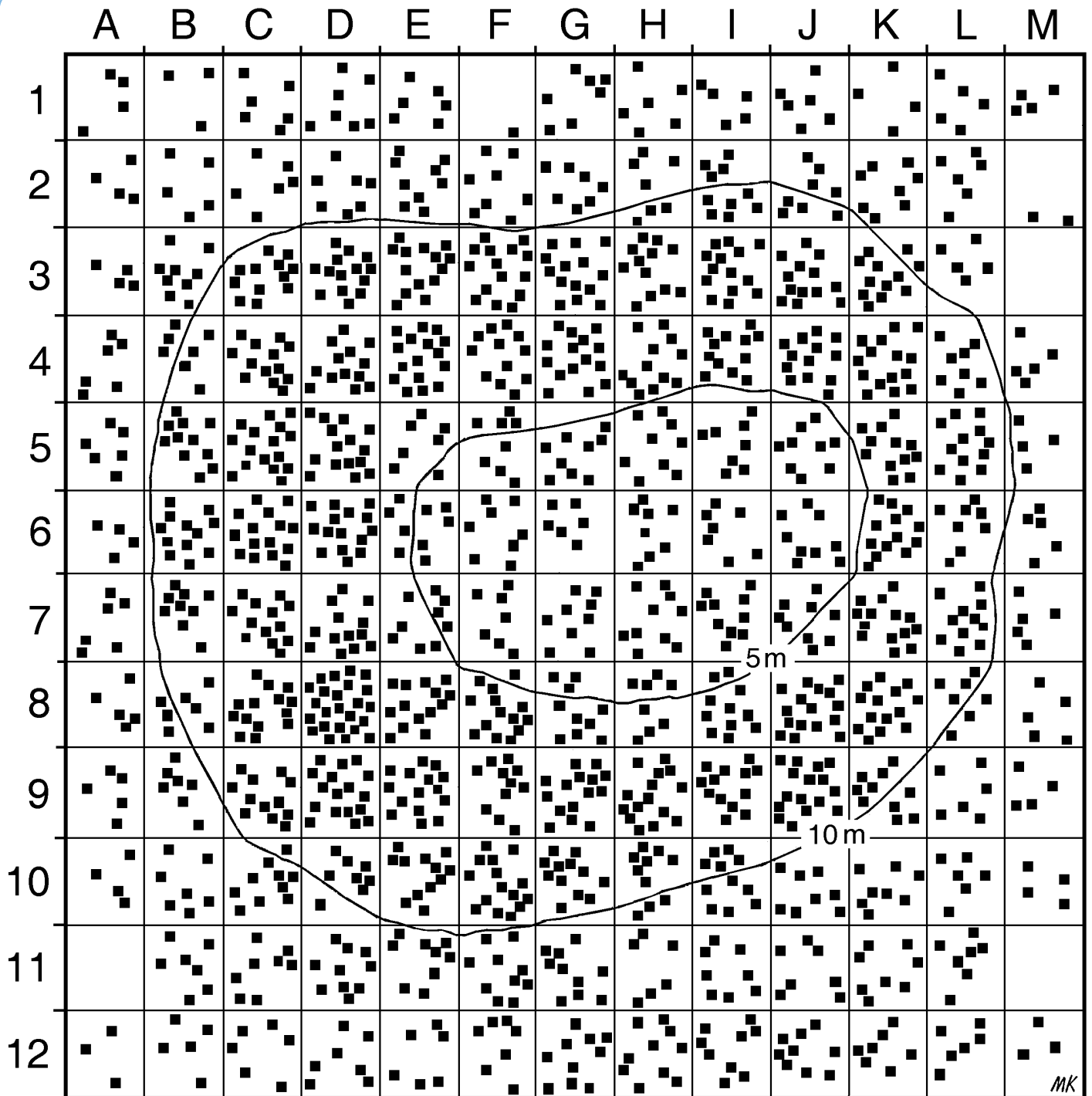

The distribution of sea cucumbers (square black points) in a total area of 15,600 m² around a sand bank. Each square grid (quadrat) is 100 m². Contours are shown at depths of 5 m and 10 m.
 From King M. 2007. Fisheries biology, assessment and management. UK, Oxford: Wiley-Blackwell. 400 p.

3. Fisheries economics

At the completion of studies:

Younger students will appreciate the importance of fisheries to the economy.

Older students will be aware of the importance of fisheries to the economy and the value of fisheries taking into account costs and returns.



For younger students

Social Science. Strand: Resources and Economic Organisation; Level 1–3

- A. Ask students to talk to older people in their community or extended family to discover the importance of local fisheries in supplying food and selling seafood for income.

For older students

Social Science. Strand: Resources and Economic Organisation; Level 4–5

- B. Ask students to examine the value of different fisheries in Cook Islands. Which fisheries are the most valuable? Identify fisheries that are subsistence or commercial on your island? Discuss how your country and the people living in your country benefit from fisheries?



4. No-take areas

At the completion of studies:

Younger students will be aware of the cultural significance of *Ra'ui* in coastal areas of Cook Islands.

Older students will be aware of the role of *Ra'ui* and, through field work, appreciate their importance in conserving fish stocks.

Cook Islands is well known for its *Ra'ui* — a ban on fishing in an area for a given amount of time imposed by traditional leaders to ensure that seafood resources are sustainable.

For younger students

Social Science. Strand: People, Place and Environment; Level 1–3

- A. Ask a community elder involved in *Ra'ui* to explain to students the history and benefits of *Ra'ui*. What are the likely benefits of having an area closed to fishing?

For older students

Social Science. Strand: People, Place and Environment; Level 4–5

- B. Ask students to either talk to older people in their community or locate a *Ra'ui* in which fishing is banned. Find out the rules for the *Ra'ui*. Ask how long the *Ra'ui* has been in operation? Has it been successful? Do all people obey the community rules? What happens if the *Ra'ui* opens? Do they have control measures when the *Ra'ui* is opened? Ask students to suggest measures that would be beneficial to implement when opening up the *Ra'ui* for harvest?
- C. Arrange for students to swim with masks and snorkels along a transect in a safe area of a lagoon (if possible and if permitted, do this within a *Ra'ui* area). Record the numbers and types of fish seen in a band width of 4 m (two metres each side of the swimmer). If possible, compare results from transects inside and outside a *Ra'ui* area.
- D. The following figure shows a hypothetical, community-managed, no-take area in another Pacific Island country (Cook Islands does not have the mangroves shown). Show the figure on a screen (from the DVD or flash drive supplied as part of the Teachers Resource Kit). Ask students to discuss the negative and positive aspects of the positioning of the no-take area shown.

Negative points that could be raised include:

- the community loses access to a part of its fishing area.

Positive points include:

- the area includes different habitats for marine life — seagrass beds, coral reef, estuary — which are important for the survival of many species.
- larvae from the no-take area are likely to drift out into the fished areas where they can settle and grow into adults that can be caught.

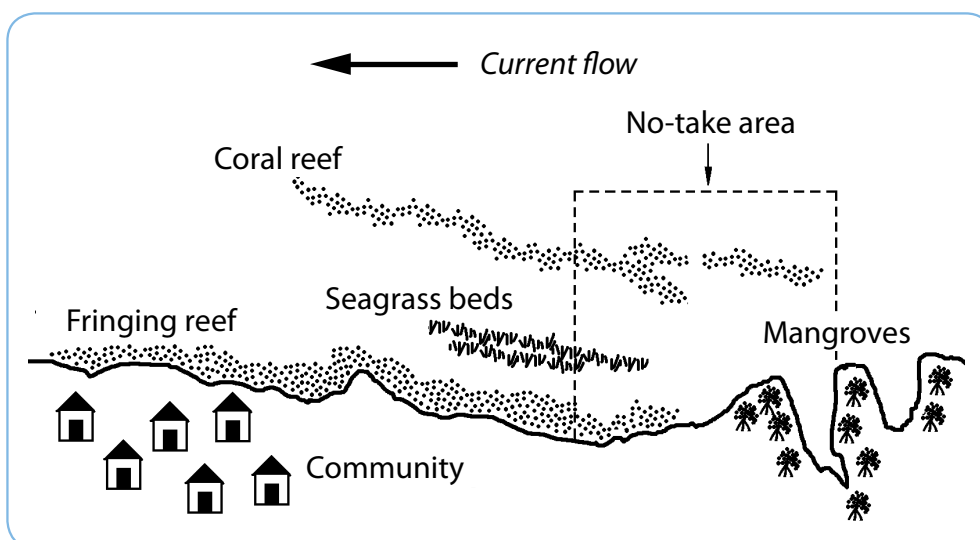

5. Fish anatomy

At the completion of studies:

Younger students will be aware of the external features of fish and sharks.

Older students will understand the structure and function of the external and internal parts of a fish.

Many young people, even those who have cleaned and gutted fish for their family, do not appreciate the structure and function of the different parts of a fish. These exercises are meant to increase awareness of fish, animals whose ancestors appeared on earth over 500 million years ago.

For younger students

Science. Strand: Living World; Aim 2, Level 1

- A. Make full-size, A4 black and white copies of the accompanying drawing of the external features of a bony fish and a shark with separated parts. Ask students to cut out the parts (along the dotted lines) and paste them onto the drawings.

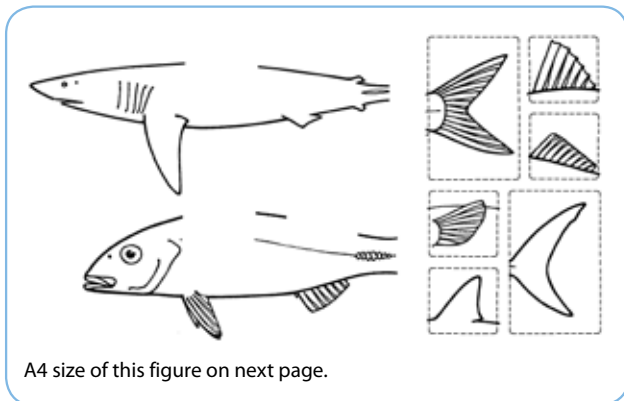

For older students

Science. Strand: Living World; Aim 2, Level 2–5

- B. Supply fresh fish of different kinds, one to each group of two or three students working together (each group will require a dissecting kit with scissors, scalpel (or knife) and probe — the scalpel could be omitted if safety is a concern.

Have each group of students a) identify the fish from the posters supplied, b) dissect each fish by carefully exposing the internal organs as shown in the figure on Sheet 5 and c) make a labelled drawing (use the figures on Sheet 5 as a guide: show the figures on a screen using the DVD or flash drive supplied as part of the Teachers Resource Kit).

Students should answer the following questions — is the dissected fish a herbivore or a carnivore? (examine the length of its intestine and the type of teeth it has); label the important parts of the fish and give their function — how does a fish “breathe”; how does a fish move through the water?



Michael Sharp © SPC

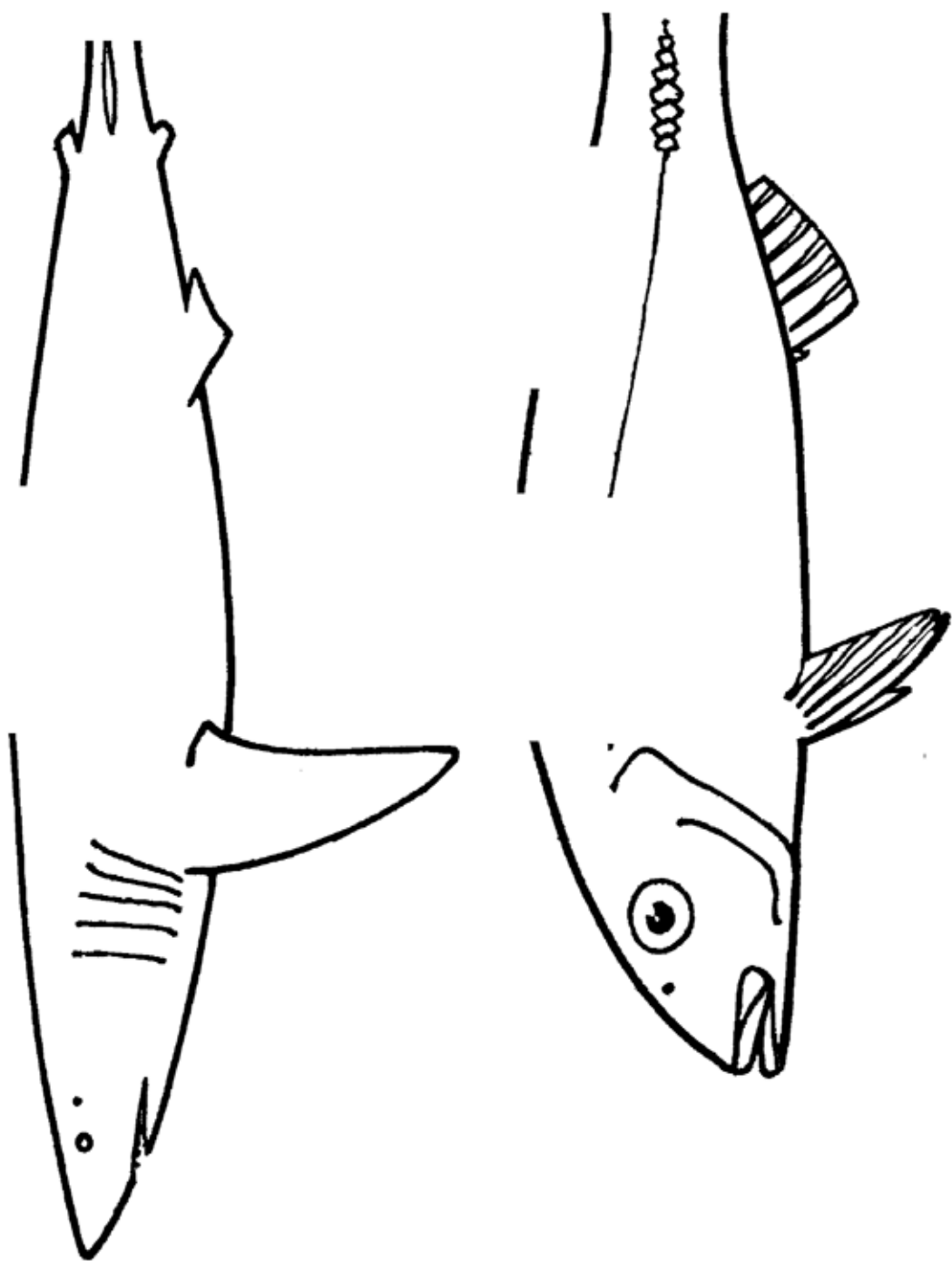
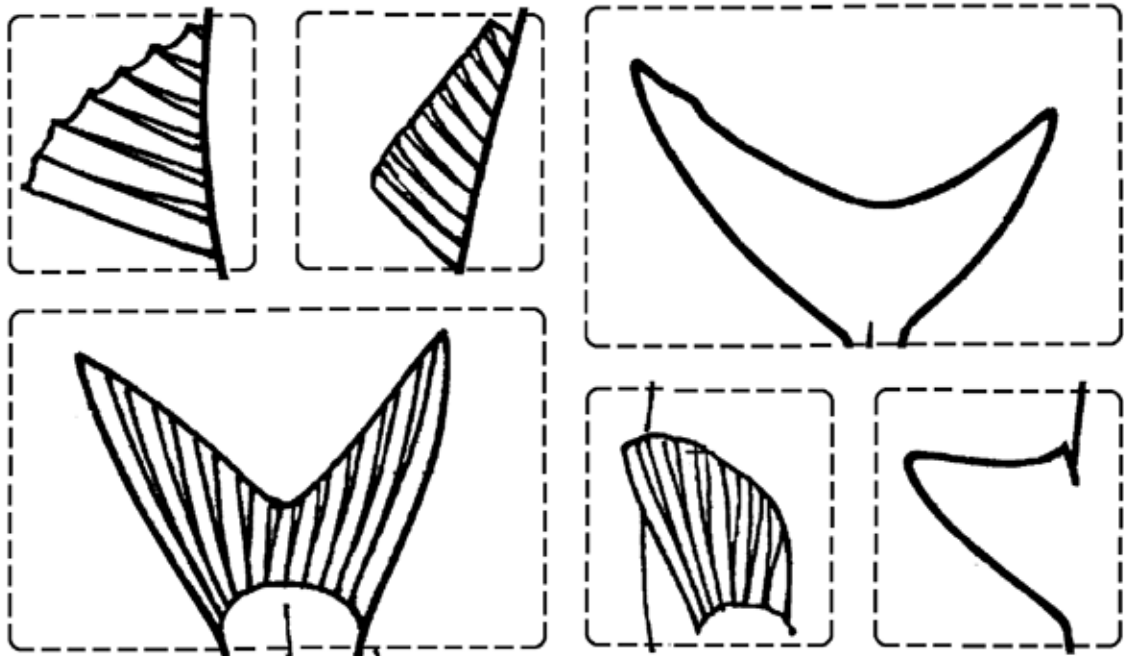

6. Marine food chains

At the completion of studies:

Younger students will be aware of the position of fish in the food webs of marine species.

Older students will be aware of marine food webs and understand the reduction in energy and food from plants to top-level carnivorous fish.

Most students would have some idea of the range of species in coastal areas of Cook Islands. These exercises are meant to make students aware of the connections between the species — that is, what eats what?

For younger students

Science. Strand: Living World; Aim 4, Level 1–3

- A. Ask students to draw common local fish and place them in a food web like the one shown in the accompanying illustration on Sheet 6. What does a rabbitfish eat? What does a parrotfish eat? What does an emperor eat?

For older students

Science. Strand: Living World; Aim 4, Level 3–5

- B. Discuss the energy pyramid shown in the Teachers' Resource Sheet on Fisheries 6. Assuming an energy loss of 90% in each stage of the food web, estimate how much plant material it takes to ultimately produce 1 kg of snapper meat.
- C. The food web shown below is the same as the one on Teachers Resource Sheet 6 but the connecting lines have been removed. Have students discuss primary production* (the use of sunlight, carbon dioxide and nutrients by plants) and the predator-prey relationships (what eats what?) and join the living things as well as detritus. Although the mangroves shown do not exist in Cook Islands, they are found in many other Pacific Islands.

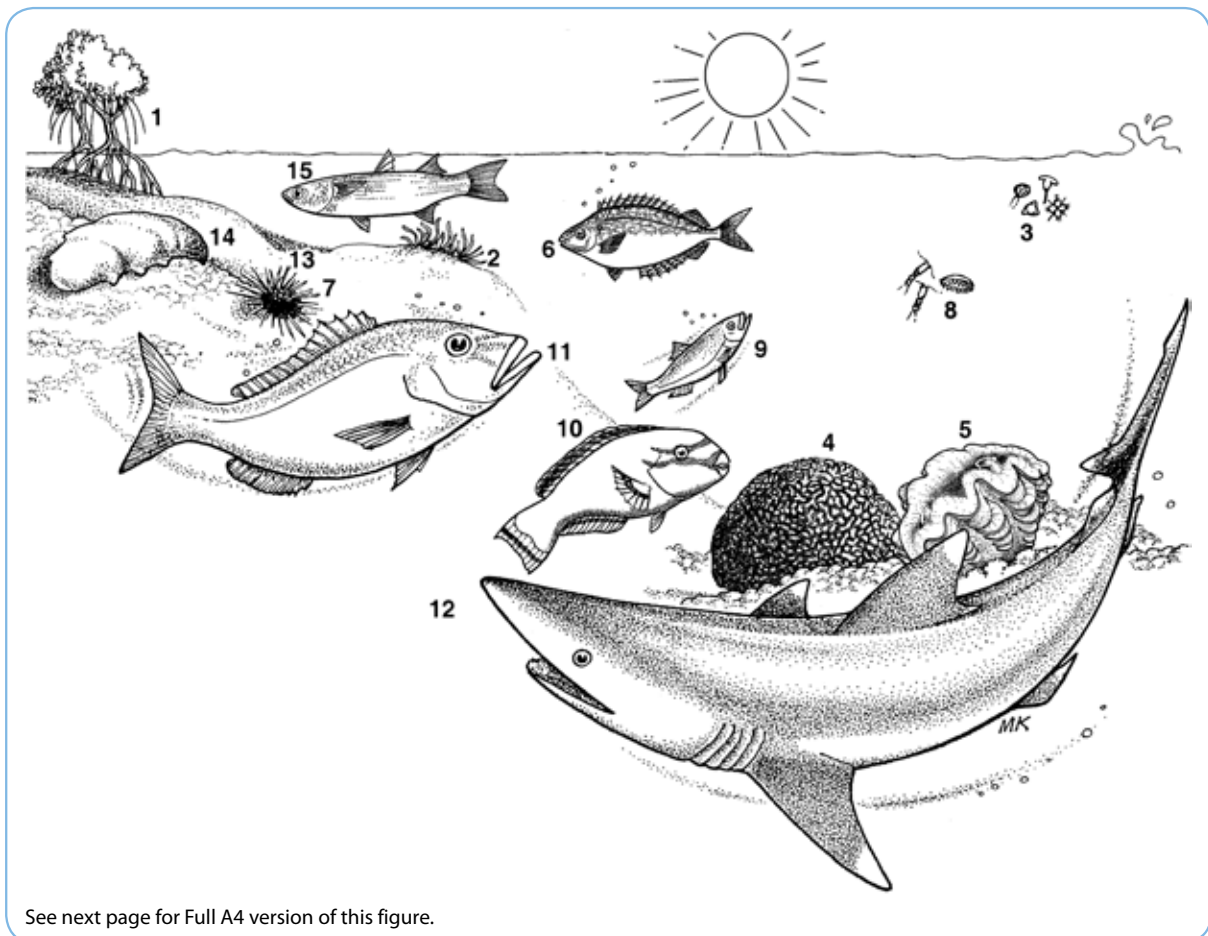

See next page for Full A4 version of this figure.

7. Oceanic species

At the completion of studies:

Younger students will be aware of differences between reef and oceanic fish.

Older students will be aware of the importance of oceanic fish and the evolution of fusiform shapes and counter-shading.

The Exclusive Economic Zone (EEZ) of Cook Islands covers an area of 1.8 million km² and shares common borders with five other Pacific Island countries or territories. Fish caught in this huge area for both local food and export include yellowfin tuna (*d'ai*), skipjack tuna (*au'opu*), albacore tuna (*toe veri*), marlin (*akura*), wahoo (*paara*) and mahi mahi (*mai mai*).

For younger students

Science. Strand: Living World; Aim 3, Level 1–2

- Ask students to examine the four fish posters of Cook Islands fish with the names hidden by masking tape. Ask them to write local and English names of the fish on the masking tape (local names may be different in each area).
- Compare the lives of open sea fish with reef fish. Why do they look different?

For younger and older students

Science. Strand: Living World; Aim 2, Level 2–3

- Show the figure of the fusiform shape and the fish with counter-shading on a screen. (These figures are on the DVD or flash drive supplied as part of the Teachers Resource Kit.) Have students discuss:
 - the advantages of a fusiform shape? Extend the discussion to other applications of the shape — e.g. the hulls of outrigger canoes and the bulbous bows on large sea-going vessels;
 - the purpose of counter-shading in fish.

For older students

Science. Strand: Living World; Aim 2, Level 4–5

- Ask students to examine the four fish posters of Cook Islands fish. What is the most noticeable difference between fish that swim fast and those that live on the reef? What shape is common in oceanic fish? Why is this shape common? Why do tuna need so much food? Why does a dolphin have the same shape as a fish?

Science. Strand: Living World; Aim 2, Level 5

- Ask students in student groups to prepare a status report on a local, exploited, marine species. The report should address the biology of the species, the history of the fishery, the state of the resource, current management measures and recommendations.

Social Science. Strand: Resources and Economic Organisation; Level 5

- As a class exercise, conduct a brief survey of a local fish market. Make a list of all species offered for sale with estimated weights and price per kg. Interview sellers to find out where each species comes from and how the availability of the marketed species varies seasonally.

8. Bonefish

At the completion of studies:

Younger students will know about the bonefish fishery in Cook Islands.

Older students will be aware of the fishery and how it is regulated.

Fly-fishing* for bonefish brings foreign exchange to Cook Islands. Fishers are required to have a permit and to fish only in designated areas. Fishing in spawning areas and nurseries is prohibited from three days before until three days after the new moon — a spawning area is an area where fish gather to reproduce; a nursery is an area where very young fish settle to grow and hide from predators. Most sports fishers release their catch immediately after capture.

For younger students

Social Science. Strand: Resources and Economic Organisation; Level 1–4

- Request a Fisheries Officer from MMR to talk about the bonefish fishery and the ways in which bonefish are caught.

For younger and older students

Social Science. Strand: Resources and Economic Organisation; Level 1–4

- Ask a local guide or keen fly-fisher to explain his technique and show how his fishing gear works. If practical, have students make a fly under instruction from the guide. (The video "Itu's Bone" includes local fly-fishing but is about one hour long.)

For older students

Social Science. Strand: Resources and Economic Organisation; Level 5

- Ask students to find out all they can about bonefish from the internet and news articles on the new bonefish fishery. Why is the bonefish fishery valuable to Cook Islands? How is it managed? Are there other fish that can get oxygen from the air like bonefish.

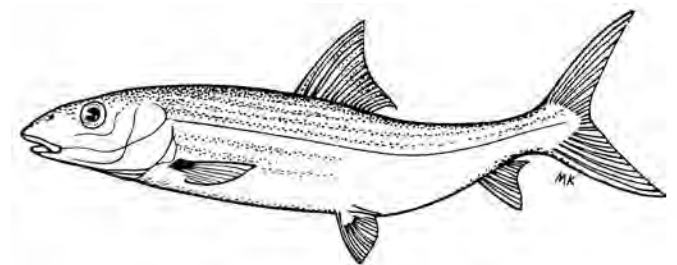

9. Pearl oysters



At the completion of studies:

Younger students will appreciate why pearl shells are regarded as attractive and are used in craft work.

Older students will be familiar with pearl production in Cook Islands and the internal anatomy of a pearl oyster or other bivalve mollusc.

Cook Islands is famous for its dark-coloured pearls from the black-lipped pearl oyster or *parau* (*Pinctada margaritifera*), which is farmed on Manihiki and Penrhyn.

For younger students

Science. Strand: Material World; Aim 1, Level 1–2

- A. If a sufficient quantity of pearl oyster shells can be obtained, ask each young student to make a small necklace pendant from a broken piece of shell. Each student will require some coarse sandpaper and a hole could be drilled into the shell by the teacher to complete the pendant.



Ben Ponia © SPC

For older students

Social Science. Strand: Resources and Economic Organisation; Level 1–5

- B. Arrange a talk from a fisheries officer, pearl trader or pearl-farm owner.
- C. Have students investigate why oysters produce pearls. How are pearls formed by the pearl oyster? Why is pearl shell so glossy and reflective? Has the production of pearls in Cook Islands changed over the years? — if so, why?

Science. Strand: Living World; Aim 2, Level 1–5

- D. If a number of whole, live, pearl oysters can be obtained, provide one for each small group of two to three students. Ask each group to carefully remove one of the oyster's shells and one lobe of the mantle to expose the internal structure. Students should identify the muscle, gills and intestine and make a labelled drawing. The drawing of the internal structure of the pearl oyster given in Sheet 9 can be used as a guide.
- E. If whole, live, pearl oysters are not obtainable, another two-shelled (bivalve) mollusc such as a *pipi* could be dissected instead. Alternatively, have students complete the labels on copies of the following drawing and discuss the functions of each. This figure is the same as the one on Teachers' Resource Sheet 9 but with the labels hidden.

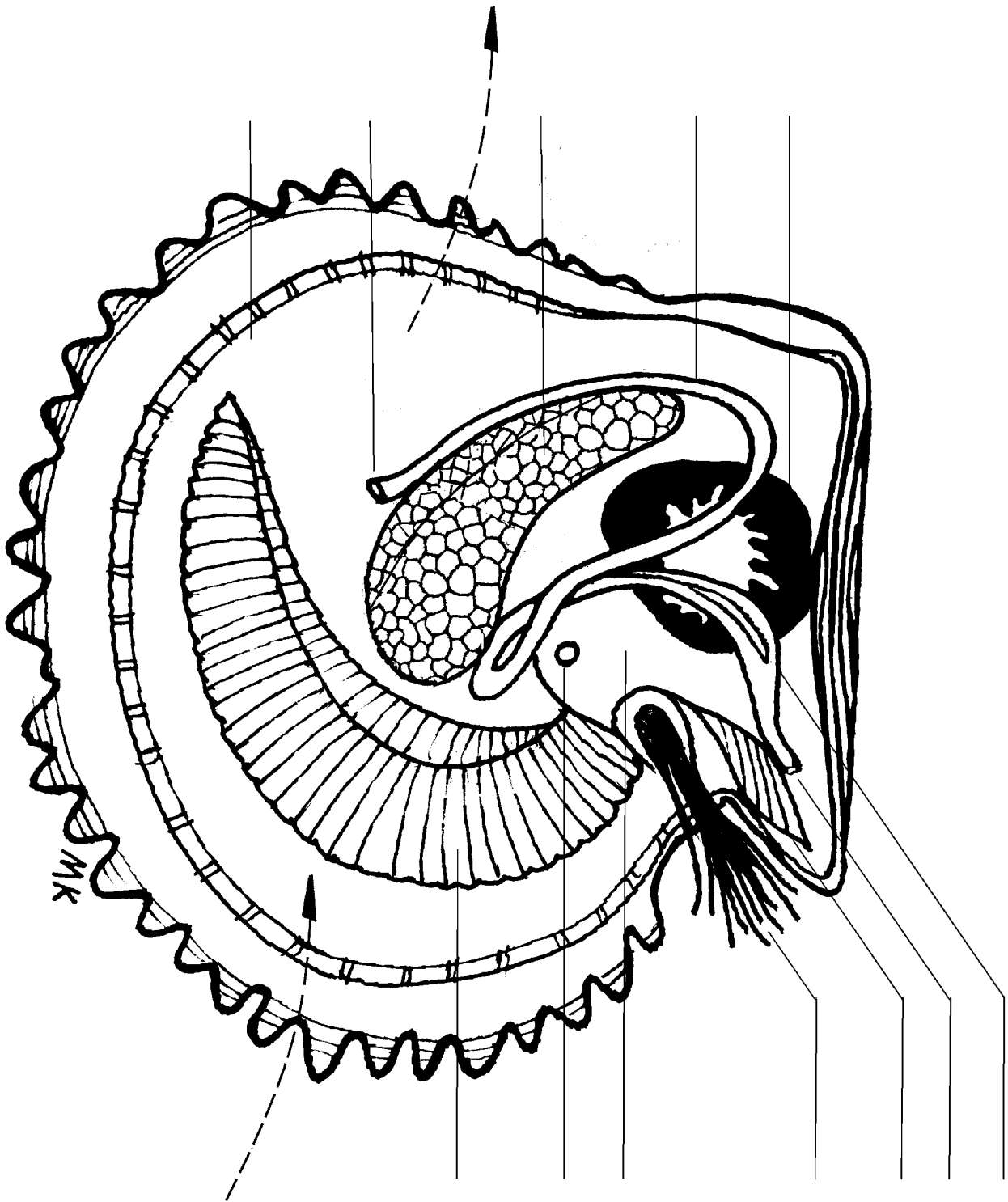

10. Freshwater fisheries

At the completion of studies:

Younger students will be aware of eels and shrimps in the freshwaters of Cook Islands.

Older students will be able to discuss the possible origins of freshwater species in Cook Islands.

A small number of fish and invertebrates that live in fresh water are found in Cook Islands. Eels live in both sea and fresh water and the freshwater fish, tilapia, has been introduced.

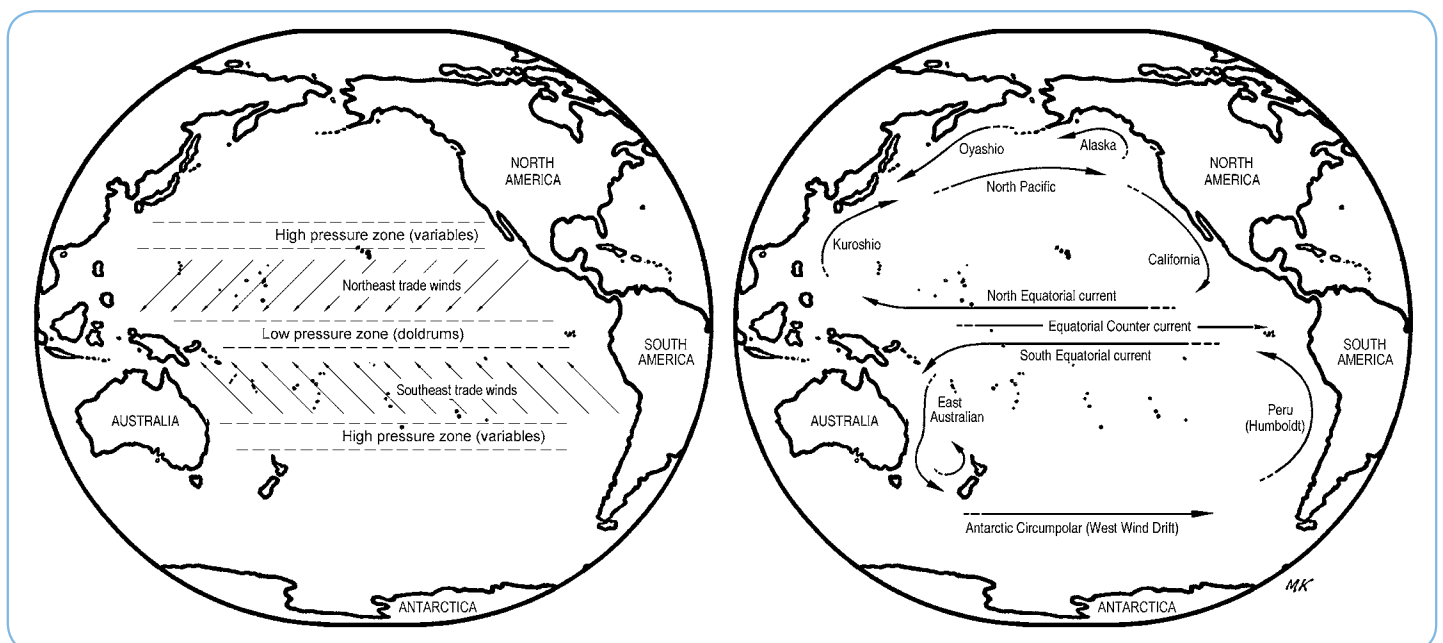

For younger and older students

Social Science. Strand: Cultural Development and Change; Level 2–3

- A. Ask students to talk to older people in their community or extended family about fishing for eels and shrimps. How much is caught? Have catches changed over the years?

For older students

- B. The aquarium built as a student project described in Sheet 11 could be set up as a freshwater aquarium and stocked with shrimps and small tilapia caught by students.
- C. The figure above shows (left) the prevailing winds and (right) the ocean surface currents in the Pacific Ocean. Ask students to discuss where freshwater species could have possibly come from (the origin of freshwater species in Pacific islands is not known but possibilities can be discussed).

11. Aquarium fish

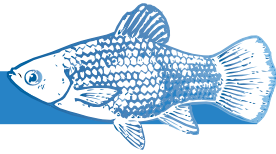

At the completion of studies:

Younger students will be aware that aquarium fish are collected and exported from Cook Islands.

Older students will be aware of the details of the aquarium fish export industry and be able to build and maintain an aquarium.

The commercial exploitation of aquarium fish in Rarotonga began in the late 1980s and their export makes up a small but important component of the country's exports.

Giant clam aquaculture has been conducted since 1990 on Aitutaki at the Araura Marine Research Station operated by the Ministry of Marine Resources. Baby giant clams are exported to be sold on the marine ornamental (aquarium fish) market.

For younger students

Science. Strand: Living World; Aim 3, Level 1–4

- A. Ask students to recognise aquarium fish from Cook Islands fish posters.

For younger and older students

Social Science. Strand: Resources and Economic Organisation; Level 2–5

- B. For students in Rarotonga, arrange a talk from an aquarium fish exporter — how are fish collected on a sustainable basis? How are aquarium fish transported to overseas countries?
- C. For students in Aitutaki, arrange a visit to the MMR giant clam farm — how are giant clams selected, bred and grown? How are they transported to overseas countries?

For older students

Science. Strand: Living World; Aim 4, Level 1–5

- D. Ask students to cooperate in the building of an aquarium. Precut glass, silicone glue and masking tape will be required to build the aquarium. For the filter system, plastic pipe, plastic mesh and an air pump will be required. Details of construction are shown in the accompanying diagram.

A thin line of silicone glue must be carefully squeezed onto the edges of the glass that have to be joined. The glass can be temporarily held together with masking tapes until the glue sets.

The plastic pipe and connecting pieces are fitted together without glue as shown so that the rectangular structure just fits inside the aquarium.

3 to 4 mm holes are drilled along the inner sides of the pipes.

The plastic mesh is placed on top of the pipes and well-washed shell grit or coarse sand is placed on the mesh screen. In the centre of the aquarium, the screen may have to be supported from below with short cut-off lengths of pipe to stop it sagging.

The air-stone must just fit inside the upright pipe. When operating, the air-stone "lifts" and oxygenates the water after it is drawn through the shell-grit and sand, which acts as a filter.

A freshwater aquarium is easier to maintain but less interesting — it can be stocked with freshwater plants, small tilapia and freshwater shrimps.

A saltwater aquarium is more interesting but harder to maintain (the water must be changed every two to three weeks) — stock the aquarium with very small sea cucumbers, small crustaceans and small coral fish such as humbugs and damselfish.

- E. An alternative to building an aquarium would be for students to build a virtual aquarium with virtual fish (several internet site are available).

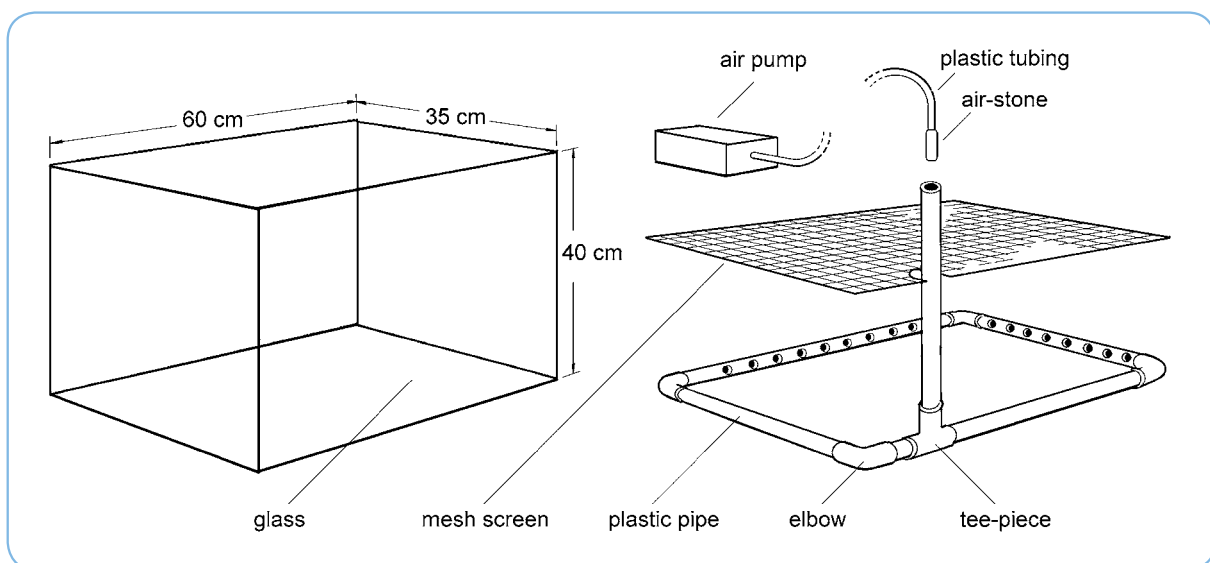

12. Fish spoilage

At the completion of studies:

Younger students will be familiar with bacteria and the need for personal hygiene when handling food.

Older students will be aware of food spoilage caused by the action of bacteria and enzymes.

Most natural foods eventually spoil or become “bad”. Spoilage refers to food items becoming unfit to eat. Seafood, in particular, has to be handled carefully so that it doesn’t make people sick.

For younger students

Health and Physical Well-being. Strand: Me, Safety and Risk Management; Level 1–3

- A. Why is it necessary to wash your hands before handling food?
Introduce the idea of removing contaminants and bacteria from hands before handling food.
- B. Why do we keep food on ice or in a refrigerator?
Introduce the idea of low temperatures slowing (but not stopping) the growth of bacteria on food.

For older students

Science. Strand: Living World; Aim 3, Level 5–6

- C. Have students discuss the fact that honey is the only natural food that doesn’t go bad. Introduce the concept of osmosis* which causes bacteria entering honey to shrivel up and die.

Health and Physical Well-being. Strand: Me, Safety and Risk Management; Level 3–4

- D. Obtain two fresh fish of a similar type and size. Place one fresh fish in a container with ice and one in a container without ice. Ask students to observe the fish each day for several days and note changes in the smell and appearance, particularly in the eyes and gills. What makes the fish without ice begin to smell after a few days? Why would this fish be unsafe to eat?

Health and Physical Well-being. Strand: Me, Safety and Risk Management; Level 5

Science. Strand: Living World; Aim 3, Level 5–6

- E. Have students discuss the difference between spoilage caused by bacteria and that caused by enzymes. What are the causes and symptoms of each type of poisoning?
- F. Arrange to visit a Fish Processing Plant or ask a Fisheries Officer to give a talk on Seafood Handling.

13. Ciguatera and fish poisoning

At the completion of studies:

Younger students will be aware of ciguatera and the fish that cause it.

Older students will be aware of ciguatera and the sequence of events that result in some fish becoming toxic. They will also be aware of other effects of harmful algal blooms.

Not all fish poisoning is caused by poor handling and bacteria. Some forms of poisoning are caused by harmful algal blooms — a dramatic increase in the numbers of very small plants (phytoplankton*) that float in the sea. These microscopic plants produce toxins that can affect humans.

Interestingly, the toxins can become airborne (as toxic aerosols) because of wave action and cause people swimming and walking on the shore-line to suffer respiratory asthma-like symptoms from inhaling the airborne droplets. This has been noted in Rarotonga where sewage-derived nutrients were believed to be responsible for the blooms.

For younger and older students

Science. Strand: Living World; Aim 3, Level 1–3

Health and Physical Well-being. Strand: Me, Safety and Risk Management; Level 1–3

- A. Show students Cook Island fish posters and ask them to identify those fish that are known to cause ciguatera poisoning.

For older students

Health and Physical Well-being. Strand: Me, Safety and Risk Management; Level 3–5

- B. Ask students to interview members of their local community or extended family to identify species in a local area that are known to result in ciguatera poisoning. Find out how many people have suffered from ciguatera poisoning. Speak to someone who has suffered from ciguatera poisoning — which fish caused it? What were the symptoms? Was local medicine used to treat the symptoms?
- C. For students in Rarotonga, interview people who believe they have suffered from exposure to airborne toxins while swimming or walking on the shoreline. What were the symptoms? When and how often did these occur?

Science. Strand: Living World; Aim 4, Level 4–5

- D. Students could hypothesise on conditions that cause harmful algal blooms in their local area.

14. Job opportunities in fisheries

At the completion of studies:

Younger students will be aware of the range of opportunities in the fishing industry.

Older students will be aware of the range of job opportunities in the fishing industry and will be aware of working locations and conditions.

In Cook Islands, job opportunities may occur in pearl farming, fishing, processing, marketing, research and managing or conserving marine resources.

For younger and older students

Social Science. Strand: Social Organisation and Identity; Level 1–3

- A. Arrange for talks by people who work in the fishing industry — from a fisher, a fish trader, a fish exporter and a member of an environmental NGO as well as a fisheries manager from MMR.

Social Science. Strand: Resources and Economic Organisation; Level 1–5

- B. Arrange for visits to potential employment areas — to a tuna fishing vessel, an export factory and MMR.

15. Fish Aggregating Devices (FADs)

At the completion of studies:

Younger students will appreciate the role of fish aggregating devices in Cook Islands.

Older students will be aware of the purpose of fish aggregating devices and be able to discuss possible reasons why they attract oceanic fish.

Many species of fish that inhabit the open sea are attracted to floating objects. FADs are rafts set offshore to attract oceanic fish such as tuna (*a'ai*), wahoo (*paara*) and mahi mahi (*mai mai*) so that they can be more easily caught by fishers. The first FAD in Cook Islands was deployed in the early 1980s. Since that time, they have been constructed and placed around Rarotonga, Aitutaki, Mangaia, Atiu, Mauke, Mitiaro, Palmerston, Manihiki and Penrhyn.

For younger and older students

Science. Strand: Living World; Aim 4, Level 2–5

- A. Build a model FAD using a raft (about 40 cm by 40 cm) made from bamboo or sticks and attached by rope to a brick or other weight; attach short lengths of frayed rope to the underneath of the raft. Set the model FAD (with a small flag) in the shallow water of a lagoon. Have students observe the raft using a diving mask and snorkel at weekly intervals. Note any plant material and other organisms growing on the rope. Are there more small fish near the model FAD than in surrounding bare areas?

For older students

Science. Strand: Living World; Aim 4, Level 4–5

- B. Ask students to suggest why fish of the open sea such as tuna are attracted to FADs. Discussion possibilities include:
- The FAD acts as a visual reference point in an otherwise empty ocean.
 - The FAD works by attracting smaller baitfish on which larger fish feed.
 - Baitfish use the FAD as a hiding place from predators.
 - Baitfish feed on the algae and small organisms that settle on the hanging material.

Social Science. Strand: Resources and Economic Organisation; Level 3–5

- C. Ask MMR to provide a fisheries officer to explain how FADs are used in Cook Islands to enhance food security and livelihoods (increased catches of pelagic fish by subsistence and commercial fishers) and to mitigate impacts of climate change (shifting of fishing pressure from reefs to offshore areas hence increasing the resilience of coral reefs to the negative impacts of climate change).
- D. Ask students to discuss the challenges faced by MMR or local communities in deploying FADs in outer islands (consider the transport, cost, availability of FAD materials from Rarotonga and the use of a vessel large enough to set FADs). How could the fishers using FADs contribute to the high cost of building, setting and maintaining them?

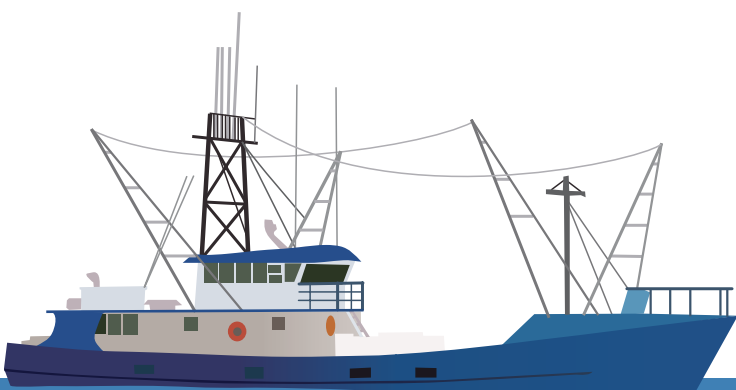

16. Cook Islands traditional fishing methods



At the completion of studies:

Younger students will be familiar with the range of traditional fishing methods used in Cook Islands.

Older students will be aware of the range of traditional fishing methods used in Cook Islands and be able to discuss the advantages and disadvantages of the methods used. They will know about damaging fishing methods used in the past.

For younger and older students

Social Science. Strand: Cultural Development and Change; Level 2–5

- A. Ask students to talk to older people in their community or extended family to discuss traditional fishing. How have fishing methods changed over the years? What were the advantages and disadvantages of traditional fishing methods?
This should be followed up with a discussion in the classroom and a listing of the number and types of traditional fishing methods used by local communities (this could be done in conjunction with exercise A in Sheet 16. Modern fishing methods).
- B. There is a tendency to think that only modern fishing methods are responsible for overfishing and environmental damage. Some are, but some traditional fishing methods can also be damaging. Have students discuss which traditional fishing methods are damaging — what about communal fish drives (leaf sweeps or rau) across a reef?
- C. The fruit of the *utu* or *Barringtonia* tree, *Barringtonia asiatica* and the roots of the *ora papua* or *Derris* vine, *Derris* sp. and dynamite were once used to poison and stun fish. These practices have been banned because they not only kill the target fish, but also other fish, shellfish and coral in the area. Ask students to talk to older people in their community or extended family to ask about these methods of fishing in the past.
- D. Have students discuss why many traditional fishing methods described in Information sheet 17 — hook-and-line methods, *maroro* fishing, *inaki* and *pata* fishing if it is only done during daytime — are sustainable because they are selective and allow, for most of them, to release baby fish alive.

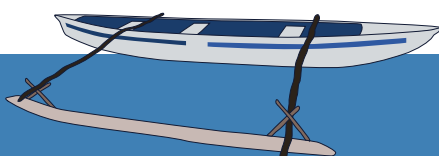

17. Modern fishing methods

At the completion of studies:

Younger students will be familiar with the range of commercial fishing methods used in Cook Islands.

Older students will be aware of the range of commercial fishing methods used in Cook Islands and have practical knowledge of some of the methods used.

For younger students

Social Science. Strand: Cultural Development and Change; Level 2–5

- A. Ask students to talk to people in their extended families or community about modern fishing methods that they use. This exercise should be followed up with a discussion in the classroom and a listing of the number and types of modern fishing methods used by the local community (which could be done in conjunction with exercise A in Teachers' Resource Sheet 17: Cook Islands traditional fishing methods).

For older students

- B. Have students demonstrate that they can tie the commonly used fishing knot (a blood knot) shown in the diagram below.

Social Science. Strand: Resources and Economic Organisation; Level 3–5

- C. If possible, arrange a visit to a local fishing operation; visit a longliner or a game fishing charter boat. Ask students to examine and discuss the value of the operation to the country and the sustainability of the fish stocks targeted.
- D. Ask students to discuss any impacts of a modern fishing method on the resources of their island.

1. Pass the end of the line through the eye of the hook twice to form a double loop.

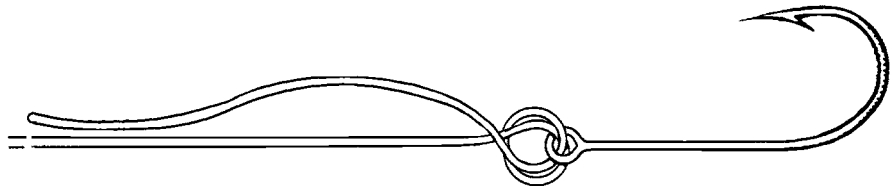

2. Wrap the line back around the main line about five times.

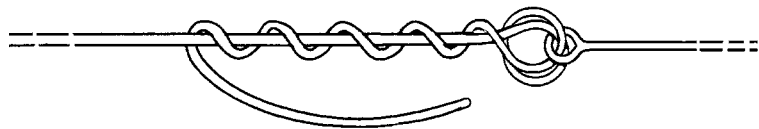

3. Pass the end of the line back through the double loop at the eye and back through the large loop.

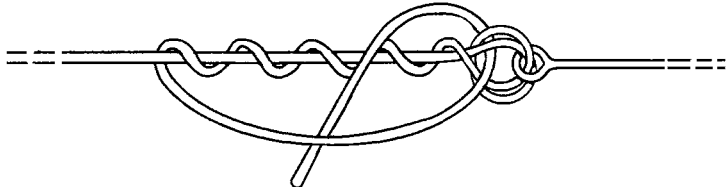

4. Pull the knot tight.

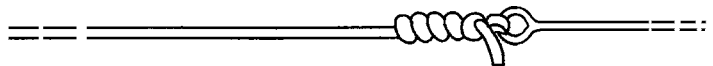

18. Sea safety

At the completion of studies:

Younger students will be aware of the safety equipment that should be carried on all fishing boats.

Older students will be aware of the safety equipment that should be carried on fishing boats including sea anchors and signalling equipment; they will also know how to tie important knots relating to safety and seamanship.

For younger students

Health and Physical Well-being. Strand: Me, Safety and Risk Management; Level 1–3

- Show students a copy of the checklist on safety equipment with one item blanked out — ask students to identify the missing item.
- Make black and white copies of the “Small boat safety checklist” for students to colour in. Why are life-jackets coloured bright yellow or orange? What is more important to carry on board the boat always — food or fresh water and why? In what circumstances can a knife be useful onboard a boat?

For younger and older students

Health and Physical Well-being. Strand: Me, Safety and Risk Management; Level 3–5

- Arrange for a talk from harbour authorities or from someone who has had an accident or been rescued at sea.

For older students

Health and Physical Well-being. Strand: Me, Safety and Risk Management; Level 3–5

- Ask students to interview members of their local community or extended family. How many accidents at sea have occurred? What is the cost of these accidents to families and society? What safety equipment was carried? Did they carry all items shown on the checklist on safety equipment?

Health and Physical Well-being. Strand: Me, Safety and Risk Management; Level 2–3

- How would fishers get information on the local weather before going to sea?
- How does a sea anchor work and why is it useful to have onboard? (It reduces drift speed in case of engine breakdown and keeps the vessel's bow facing the wind and hence improves vessel stability.)
- What are the cheapest options available for signalling devices (torch and mirror), propulsion means (sail or paddles), floating devices (plastic container or fishing buoy)?

Health and Physical Well-being. Strand: Me, Safety and Risk Management; Level 3–4

- Ask students to discuss each of the following signalling devices:
 - flares (good at night but not during daytime, works for passing air planes or boats, short lifespan so need to buy at regular intervals, not accepted on aircraft so difficult to acquire, particularly in the outer islands);
 - VHF (good to alert people on shore or onboard other boats, hand-held models exist, relatively inexpensive, but requires power or A4 batteries to operate, limited range up to 20 nm and some areas are not equipped with VHF receiver/transmitters);
 - mirror, also called heliograph (cheap, good during daytime but requires sun to work, does not work at night);
 - torch or laser (good at night, cheap, but requires batteries to operate — although manually chargeable models exist — best to have waterproof lamp, not useful during daytime);
 - personal locator beacon — PLB (unlimited range as works with satellites, best device to signal distress to international and local authorities, has a built-in GPS so that position is known, but expensive — around NZ\$ 400, lifespan of built-in battery varies).
- Supply each student with two pieces of rope each about one metre long. Have students demonstrate that they can tie a clove hitch, bowline and sheet bend. The clove hitch is commonly used to tie a rope to an object (but it can jam tight under load). The bowline forms a loop that does not slip or tighten (it is used in many rescue operations and is traditionally pronounced BO-LIN). The sheet bend is used to join two ropes together. Show the following figure as a guide.

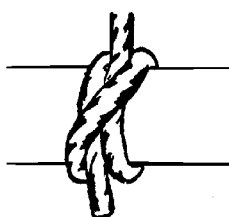

CLOVE HITCH

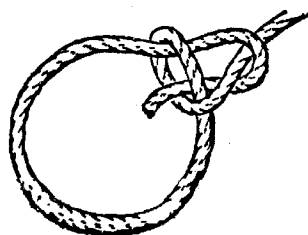

BOWLINE



SHEET BEND

19. Financial management

At the completion of studies:

Younger students will be aware of the range of fish species that are caught.

Older students will be aware of the costs of equipment, gear and supplies required for fishing as well as profits from sales.

For younger students

- A. Ask students to prepare a list of fish that are regularly caught and what the fishers do with the fish (what is the quantity eaten and sold).

For older students

Social Science. Strand: Resources and Economic Organisation; Level 4–5

- B. Ask students to interview someone who makes a living from fishing.
Find out the fisher's average catch from a fishing trip (by species, in kg), how much they sell the fish for (income, in \$) and how many fishing trips they usually complete in one year.
If possible, find out the costs of fishing — ice, bait, food, fuel, replacement of gear etc. Complete a spreadsheet on the costs of fishing and income from selling fish (a basic example is shown in the table below).

Fixed costs per year

Fishing licence	\$ _____
Bank loan repayments	\$ _____
Boat regular maintenance	\$ _____
Insurance	\$ _____
Depreciation of boat and gear value	\$ _____

Total fixed costs per year \$ _____

Running costs per fishing trip

Crew payments	\$ _____
Fishing gear replacement	\$ _____
Fuel and food	\$ _____
Bait	\$ _____
Ice	\$ _____

Total running costs per fishing trip \$ _____

Total annual running costs \$ _____
(fishing trip costs multiplied by the number of fishing trips per year)

Total annual costs \$ _____
(annual fixed costs plus annual running costs)

Annual income or loss \$ _____
(total income from fish sales minus total annual costs)

20. Climate change and fisheries

At the completion of studies:

Younger students will be aware of climate change.

Older students will be aware of the consequences of climate change in Cook Islands.

For younger and older students

Social Science. Strand: People, Place and Environment; Level 4–5

Science. Strand: Living World; Aim 4, Level 4

- A. Ask students to find out all they can about climate change on the internet and from newspaper articles and books. How could climate change affect Cook Islands? Will stocks of fish be affected? Will there be more or fewer or stronger cyclones? Will the amount of rain change? Will sea-levels change? How will coral reefs be affected?

The following section includes suggested student activities and questions relating to the 29 SPC Information Sheets for Fishing Communities; these are included in the SPC Teachers' Resource Kit on Fisheries.

Information Sheet 01: Groupers

- A. Groupers are not shaped like fish that swim fast like tunas. So, how do groupers catch their food?
- B. Most species of groupers start out life as females and change sex to males at 3 to 7 years of age. What are the advantages of changing sex in this way?
- C. What actions could local fishers take to ensure that groupers are not over-fished? Overfishing or overexploitation is the situation in which so many fish are caught, that there are not enough adults left in the sea to reproduce and replace the numbers lost.
- D. Ask students to talk to fishers in their local community or extended family to find out about catches of the fish. Where are they caught? Are they as common as they were 5 years ago? At what time of the year do they contain ripe gonads* (see Teachers' Resource Sheet 5: Fish anatomy)? Do the fishers know if they migrate to gather in a particular place to spawn? (See Information Sheets for Fishing Communities 24: Spawning aggregations.)

(NOTE — C and D can be repeated for many of the species described in the following sheets.)

Information Sheet 02: Rabbitfish

- A. Rabbitfish are herbivores and feed on seaweeds and seagrasses. Ask students to describe how this makes them an important link in tropical marine ecosystems? Refer to Teachers' Resource Sheet 6: Marine food webs.
- B. Ask students to discuss the reasons that rabbitfish are important in maintaining the health of corals.

Information Sheet 03: Emperors

- A. Many emperors are caught by fishers as they gather in large groups to breed (in spawning aggregations). Have students discuss the dangers involved in this type of fishing (refer to Information Sheet 24: Spawning aggregations).
- B. An emperor is one of the fish shown in the food web shown in Teachers' Resource Sheet 6: Marine food webs. Have students discuss its position and role in marine food webs.

Information Sheet 04: Parrotfish

- A. Have students discuss the habits of parrotfish that make them particularly vulnerable to overfishing.
- B. In many places parrotfish have been overfished by people using spears and underwater torches at night to catch the fish as they sleep. Have students discuss the effects their removal has on coral reef ecosystems. What actions could local fishers take to ensure that parrotfish are not over-fished?
- C. Large numbers of parrotfish are caught and exported in one particular island in Cook Islands. Ask student to identify this island and to find out about this fishery? How has it affected the stock on the island? Has it become more difficult to catch them?

Information Sheet 05: Reef snappers

- A. In several Pacific Island countries, some species of snapper are responsible for ciguatera fish poisoning. Ask students to talk to people in their local community or extended family to find out which fish have been responsible for ciguatera.
- B. There are many different species or types of snapper. Ask students to visit markets and talk to fishers to find out how many species are caught locally. Have some species become scarce over time?

Information Sheet 06: Trevallies

- A. Trevallies are fast hunters in the sea. Ask students to compare the shape of a trevally with that of a grouper and discuss the reasons for any difference.
- B. *Ru'i* (black trevally) fishing is a traditional type of fishing carried out in the northern Cook Islands, particularly on Penrhyn and Rakahanga. One fisher stays in the canoe while another dives down and spits ground-up bait (*paru*) from his mouth to entice the *ru'i* to the surface. The *ru'i* is then fed a baited hook and hauled in by another fisher in the boat. According to local fishermen, it is becoming harder to catch a good-sized *ru'i*. Have students in the northern Cook Islands interview *ru'i* fishers and attempt to find out the reasons. Find out if the method of fishing for *ru'i* has changed.

Information Sheet 07: Mulletts

- A. Mulletts often move long distances along the coast before moving to offshore waters where they spawn. Ask students to consider how this behaviour has resulted in their overexploitation in several Pacific island countries.
- B. Mulletts are omnivores, that is, they feed on plants and small animals (invertebrates) as well as by sucking up sediments on the sea floor. Have students discuss the advantages of this type of feeding behaviour.

Information Sheet 08: Surgeonfish

- A. In many Pacific island coastal fisheries, surgeonfish are the most important group of fish taken for food. Ask students to survey their local community to discover the most important local food fish. How are they caught?
- B. Surgeonfish can be dangerous to handle. Have students discuss why this is so.
- C. Ask students to find out which species are regarded as a delicacy or popular on their island and in which month of the year that such species are normally in good condition or fat.

Information Sheet 09: Sea cucumbers

- A. The most common species of sea cucumbers in Cook Islands are the *rori toto* (lollyfish), the *rori matie* (green sea cucumber) and the *rori puakatoro* (red surf fish). Have students talk to people in their local community to discover if these or other species are, or have been, collected.
- B. Fishing for sea cucumbers has occurred at a low level in Cook Islands, where people mostly harvest them for their gonads. Ask students in the northern Cook Islands where sea cucumber fishing does occur or has occurred and ask them to prepare a history of the local fishery.
- C. Ask students to interview people in their communities to find out about traditional methods of preparing sea cucumbers for food? What methods are used for each species?
- D. Ask students to discuss the role of sea cucumbers in coral reef ecosystems. What would happen if their numbers were greatly reduced by fishing (consider their role in “clearing” debris and organic material from the sea floor).

Information Sheet 10: Giant clams

- A. Ask students to discuss how giant clams can “feed” on sunlight. Discuss symbiosis.*
- B. Ask students to discuss the actions that could be taken to ensure that giant clams are not over-fished?
- C. Ask students to select an island and discuss the impacts of airports and regular shipping on local populations of giant clams. Discuss any measures that indicate that the island applies to protect giant clams.

Information Sheet 11: Trochus

- A. Trochus (*Tectus niloticus*) were introduced into Cook Islands in the 1950s from Fiji. They were first released on Aitutaki; then, during the 1970s and 1980s they were taken to most of the other islands in the Cook group. Ask students to prepare a history of the introduction in their local area. Are the stocks managed well? Is the fishery valuable to local people?

- B. MMR has imposed minimum and a maximum size limits on trochus — that is, trochus less than 80 millimetres and greater than 110 millimetres cannot be legally caught. What are the purposes of these regulations? (See Teachers’ Resource Sheet 1: Fisheries management.)
- C. Ask the students to discover if there was an impact of trochus introductions on other species that live in the same habitat?

Information Sheet 12: Mangrove crab

In Cook Islands, mangrove crabs are only caught in Aitutaki, but they are found in many other Pacific islands.

- A. What actions could local fishers in Aitutaki take to ensure that mangrove crabs are not over-fished?

Information Sheet 13: Spiny lobsters

- A. Spiny lobsters are caught in Cook Islands but the development of a large commercial fishery may not be possible. Ask students to discover why this is so.
- B. Spiny lobsters usually live in crevices on reefs and move out at night to feed. Ask students to interview local people who catch lobster. How do they catch them? Where are they caught? Are they as common as they were 5 years ago? At what time of the year do the females carry eggs beneath their bodies?

Information Sheet 14: Coconut crab

- A. Coconut crabs (*unga, kaveu, kavou*) were once found throughout the Pacific. In Cook Islands, coconut crabs have become rare in some islands but can be found in Aitutaki, Atiu, Mangaia, Manihiki, Mauke, Palmerston, Penrhyn, Pukapuka, Suvarrow and Takutea. Ask students to investigate the reasons why they have disappeared from many islands in the Pacific.
- B. Coconut crabs have an unusual and complex life-cycle. Use the illustration in Information Sheet 14 to discuss this with students.

Information Sheet 15: Octopuses

Octopuses are fished locally throughout the Pacific Islands using a variety of fishing methods including the use of lures, baited lines and spears as well as by hand. Some fishing methods result in considerable destruction of corals as the octopuses are removed from their nests. In some countries, traditional lures made of cowry shells are used to attract and catch octopuses.

- A. Ask students to interview local people who catch octopuses. How do they catch them? Where are they caught? Does the method damage corals? Are octopuses as common as they were 5 years ago?

Information Sheet 16: Green snail

Green snails are harvested in other Pacific Islands for their meat and their pearly shells, which are sold to processing factories for making buttons, jewellery and pearl inlays.

- A. Ask student to investigate and discuss the benefits and possible dangers of introducing green snails to Cook Islands.

Information Sheet 17: Reef Sharks

- A. Most fish reproduce by males releasing sperm and females releasing eggs into the water. The sperm fertilises the eggs in the sea. But sharks and rays reproduce differently — by internal fertilisation. Have students list the advantages and disadvantages of internal fertilisation (use the life-cycle illustration on Sheet 17).
- B. Sharks are fished in large numbers for their fins which are used in shark fin soup. Tens of millions of sharks are caught each year and in many cases their fins are removed and the rest discarded. Ask students to discuss why sharks, in particular, are easily overexploited? Hint — think about a shark's method of reproduction and its position on the energy pyramid (see Teachers' Resource Sheet 6: Marine food webs).

Information Sheet 18: Rays and Skates

- A. Rays and skates are related to sharks but feed very differently. Ask students to discuss the feeding of rays including the related manta ray. Why is the manta ray quite different from other rays?
- B. Since December 2012, Cook Islands waters have been declared shark sanctuary. Have students discuss the need to protect sharks. What is the shark position in the marine food chain (see Teachers' Resource Sheet #6)?

Information Sheet 19: Sea urchins

- A. Sea urchins in Cook Islands include *atuke*, *kina* and *vana*. Obtain several sea urchins and have groups of students dissect them, using the illustration as a guide. Observe the external parts of the sea urchin including the tube feet and spines.

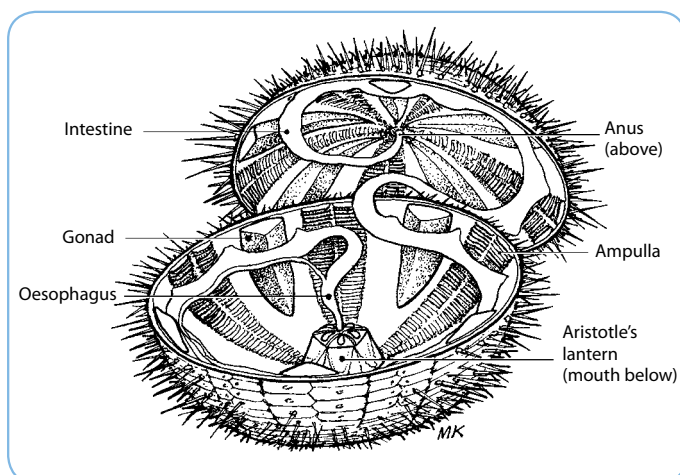

Use scissors to carefully cut around the test (shell) as shown in the figure, without disturbing internal organs. The body is arranged in five parts like its seastar relatives. There are five gonads suspended on the inside of the test.

Sea urchins feed on algae and small animals using a specialised apparatus called Aristotle's lantern which includes five calcareous plates (pyramids) that support five band-like teeth. The mouth leads into an oesophagus and intestine which exits at the anus at the top of the sea urchin.

Information Sheet 20: Crown-of-thorns

- A. Examine past outbreaks of crown-of-thorns in local areas. Were these outbreaks related to factors such as the time of the year? Investigate how local communities dealt with such outbreaks — were the methods used advisable?

Information Sheet 21: Slipper lobsters

- A. Ask students to interview local fishers who catch slipper lobsters. How do they catch them? Where are they caught? Are slipper lobsters as common as they were 5 years ago?
- B. What actions could local fishers take to ensure that slipper lobsters are not over-fished?

Information Sheet 22: Ark clams

In many Pacific Islands and atolls, ark clams and other small clams are important food items, particularly when the weather is too rough for fishing at sea. In densely populated atolls, they may be the most important source of food.

- A. Ask students to investigate and list the types of two-shelled molluscs (such as *pipis*) that are used as food in their island or local community. How important is each species? How do people catch them? Where are they caught? Are they as common as they were 5 years ago?

Information Sheet 23: Edible seaweeds

- A. Have students investigate the types of seaweeds that are collected for food in the Cook Islands.
- B. Sea grapes (*Caulerpa racemosa*) are widespread and are harvested and sold, particularly in Aitutaki. Ask students to interview people who collect this seaweed. Is it as common as it was 5 years ago? What actions could be taken to ensure that seaweeds are not over-collected? (In Fiji, women collecting sea grapes traditionally leave clumps of the plant in crevices to regenerate.)

Information Sheet 24: Spawning aggregations

- A. Many species gather together to form spawning aggregations or migrate in large groups to spawning sites. Have students interview fishers in their community or extended family to find out which fish species are known to form spawning aggregations. List the names of fish. What time of the year does this happen for each species? Where do they normally aggregate? Do fishers go fishing on these spawning aggregations?
- B. Catching fish as they gather in spawning aggregations is destructive as these breeding fish are responsible for producing small fish, many of which will grow and be available to be caught in future years. Ask students to discuss the ways in which aggregations of spawning fish can be managed and protected.

Information Sheet 25: Mangroves

- A. Have students discuss why none of the major species of mangroves (true mangroves) occur in Cook Islands? There are 33 different species of mangroves in Papua New Guinea, 25 in Solomon Islands, seven in Fiji and three in Samoa (consider the fact that true mangroves produce seeds or propagules that drift in the sea).
- B. Have students discuss the possible advantages, disadvantages and dangers of introducing mangroves into Cook Islands.
- C. In Cook Islands, *ngangie raupunupunu* (*Pemphis acidula*) and *ngangie mate* (*Suriana maritima*), which grow at the limit of the high tide line, provide good shore protection, as mangroves do in other countries. Have students discuss how *ngangie* and true mangroves compare and how they differ, and why it is important to protect *ngangie* areas.

Information Sheet 26: Seagrasses

- A. Not many marine species eat seagrasses but they are important in marine ecosystems. Have students discuss the role of seagrasses (discussion could include roles in providing nursery areas and the formation of detritus — particles of material that provide food for a much wider range of marine species).
- B. Organise a field trip in which older students use diving masks and snorkels to survey a shallow area of seagrass. Record the number and types of marine species living on seagrass and in seagrass beds. Students could swim along transects as described in exercise 4C in Teachers' Resource Sheet 4. No-take areas.

Information Sheet 27: Nutrients and sediments

- A. A watershed refers to an area of land over which water, dissolved material and sediments flow to rivers and the sea. This run-off often contains nutrients that cause the excessive growth of seaweeds and the appearance of harmful algal blooms (these are described in SPC Information Sheet 28). Ask students to investigate the sources of nutrients in Cook Islands.
- B. Ask students to examine how nutrients and sediments threaten coral reefs and fisheries?

- C. Sediments can affect corals and therefore coral reef fisheries. The presence of sediments can be easily and cheaply measured using a simple instrument called a Secchi disk.

A Secchi disk is a circular disk, made from marine plywood 40 cm in diameter, weighted to sink with pieces of lead (such as vehicle wheel balancing weights) and painted black and white in quarter segments as shown in the illustration.

The disk is lowered into the water by a cord marked by knots at 1 m intervals, until it is no longer visible and a first depth reading recorded; it is then hauled in until it becomes visible again and a second depth reading is recorded. The mean of these two readings measures the visibility in the water.

Have students complete a field exercise to measure the visibility in water at various coastal locations including those near the mouths of rivers. Complete the exercise before and after rain.

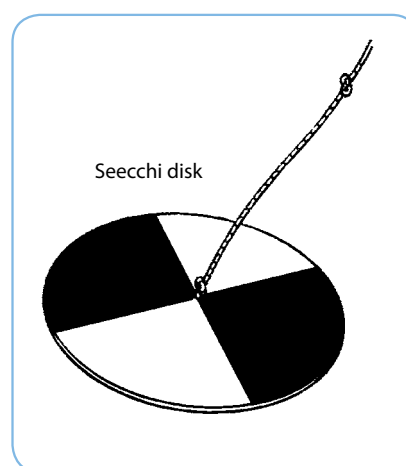

- D. Discuss possible sources of the sediments. Ask students what can be done locally to reduce sediments runoff into the lagoon.

Information Sheet 28: Harmful algal blooms

Student activities and exercises are given in Teachers' Resource Sheet 13: Ciguatera and fish poisoning.

Information Sheet 29: Plant-eating fish

- A. Marine plants create food directly from sunlight, carbon dioxide and nutrients in the water. Ask students to list and discuss the consumers of the main types of marine plants — phytoplankton, algae (seaweeds) and seagrasses.
- B. In many places seaweeds are replacing corals. This is usually caused when the numbers of plant-eating fish have been severely reduced by heavy fishing. Have students discuss the ways in which plant-eating fish are vital to the health and survival of coral reefs.
- C. Ask students to compare the teeth of plant-eating fish with those of coral- or meat-eating fish.

Glossary

Bacterium (plural = bacteria): one of a large group of microscopic, single celled organisms, most of which are crucial to life on earth and some of which can cause disease.

Billfish: a family of fish that includes marlin, sailfish and spearfish (family Istiophoridae).

Biodiversity: the variety of plant and animal life in a particular habitat.

Biomass: the total weight of living things in a population, community or trophic level.

Bioerosion: the breaking down of substrates, usually coral, by the actions of various living organisms referred to as bioeroders.

Bivalve mollusc: an aquatic mollusc which has a body enclosed within two shells hinged together; examples include clams, oysters, mussels and scallops.

Brackish water: a mixture of seawater and fresh water (as occurs near the mouths of rivers).

Camouflage: the colouring or shape of an animal which enables it to blend in with its background or surroundings.

Ciguatera: fish poisoning resulting from the consumption of fish that have accumulated toxins produced by particular very small (microscopic) plants or phytoplankton species, including the benthic dinoflagellate *Gambierdiscus toxicus*, which is found in association with coral reefs.

Commercial fishing: the production of fish primarily for sale.

Community-based fisheries management (CBFM): arrangements under which a community takes responsibility, usually with government or NGO assistance, for managing its adjacent aquatic environment and species.

Critical habitats (or key habitats): habitats that are crucial in the life-cycle of species; for fisheries these may include nursery and spawning areas such as estuaries, mangroves, seagrass meadows and reefs.

Customary marine tenure (CMT): legal, traditional or *de facto* control of land, sea and resources by indigenous people.

Detritus: particles of organic matter resulting from the breaking down of dead plants, animals and faeces.

Dinoflagellate: a small and very abundant member of the marine plankton; it consists of a single cell with two whip-like threads or flagella, which it uses to move through the water.

Ecosystem: a biological community of interacting plants and animals (including humans) and the non-living components of the environment.

Environment: the surroundings or conditions in which an animal, or plant lives.

Enzyme: a protein that is produced by a living organism and promotes a specific biochemical reaction.

Eutrophic (of a body of water): water so rich in nutrients that it encourages a dense growth of plants, the decomposition of which uses up available oxygen and therefore kills animal life.

Evolution: the process by which different kinds of living things have developed from earlier forms, especially by natural selection.

Exotic: originating in a distant foreign country.

Exports: the sale of fish and seafood products to overseas markets.

Fishery: it consists of a population or stock of fish or other aquatic species that is exploited by fishers. A fishery, therefore, includes the exploited species, the fishers and the marketers as well as the ecosystems in which all aquatic species are components.

Fishing effort: the amount of fishing activity on the fishing grounds over a given period of time. Effort is often expressed for a specific gear type, e.g. number of hooks set per day or number of hauls of a beach seine per day.

Fly fishing: a method of fishing or angling using a rod, reel, specialised weighted line and an almost weightless fly or "lure" to encourage the fish to strike.

Food web: a diagram that depicts the feeding connections (what eats what?) in an ecological community.

Fungus (plural = fungi or funguses): spore-producing organisms, including moulds, yeast and mushrooms, that feed on organic matter.

Gross domestic product (GDP): an economic measure of the productivity of an economy.

Genus: a category of living things with many similarities. For example, most giant clams belong to the genus *Tridacna* and, within this genus, the fluted giant clam is a particular species with the name *Tridacna squamosa*.

Gonads: reproductive organs, ovaries in females and testes in males, which produce eggs and sperm respectively.

Histamine poisoning: poisoning due to histamine which is converted from histidine in fish that have naturally high levels of this amino acid; high levels of histamine are indications of a failure to chill fish immediately after capture.

International Game Fish Association (IGFA): a not-for-profit organisation committed to the conservation of game fish and the promotion of responsible, ethical angling practices through science, education, rule making and record keeping.

Indigenous: originating or occurring naturally in a particular place; native.

Invertebrates: animals without backbones, such as worms, molluscs and crabs.

Laminar flow: the streamlines of flow that take place without turbulence around solid objects.

Larvae: the young stages of many marine animals including corals; most larvae are small and drift in the sea before becoming adults.

Maximum legal size: a regulation which specifies the largest captured individual that may be retained; usually justified on the grounds that larger individuals produce a greater number of eggs and are often less marketable than smaller individuals.

Minimum legal size: a regulation which specifies the smallest captured individual that may be retained; usually justified on the grounds that growth of smaller individuals eventually produces a greater harvestable biomass and that the size of the spawning stock is increased.

Natural selection: the process under which living things that are better adapted to their environment tend to survive and produce more offspring.

Niche: the role taken by a type of living thing within its community.

No-take area: an area in which fishing is not allowed.

Nutrients: in the context of the marine environment, dissolved food material (mainly nitrates and phosphates) required by plants to produce organic matter.

Osmosis: a process in which water passes through a membrane (such as the cell wall of a bacterium) from a less concentrated solution into a more concentrated one.

Over-exploitation or over-fishing: the situation in which so many fish are caught, that there are not enough adults left to reproduce and replace the numbers lost.

Pelagic: living things that live in the upper layers of the open sea.

Photosynthesis: the process by which green plants use sunlight, carbon dioxide and nutrients (including nitrates and phosphates) to synthesise proteins, fats and carbohydrates.

Phytoplankton: very small plants, which drift in the sunlit surface layers of the sea.

Plankton: small and microscopic organisms drifting or floating in water; some are permanently small and some are the eggs and larval stages of larger animals.

Pollutant: anything that degrades the environment.

Pollution (marine): the introduction by humans, either directly or indirectly, of any substance (or energy such as heat) into the sea which results in harm to the marine environment.

Predator: an animal that preys on others.

Primary production (in fisheries economics): activities that result in the catching or growing of fish and fish products.

Primary production (in biology): the use of sunlight, carbon dioxide and nutrients by plants to produce tissue through the process of photosynthesis.

Protein: a compound, made up of amino acids, which forms much of the structure in living things.

Quota: a limit on the weight or total number of fish that may be caught from a particular stock or in a particular area.

Recreational fisher: a person who catches fish for fun and sport rather than for food or for selling.

Rigor (Rigor mortis): in medicine and food handling, the stiffening of the joints and muscles a few hours after death.

Rotational closures: a management system in which a fishery, or parts of a fishery, are closed to fishing on a rotational basis.

School (or shoal): a large number of fish swimming together.

Scientific name: a two-part (or binomial) name for a living thing. The first part is the genus to which the species belongs and the second part identifies the species within the genus. For example, most giant clams belong to the genus *Tridacna* and, within this genus, the fluted giant clam is a particular species with the name *Tridacna squamosa*. Note that only the first letter in the genus name is always a capital and the two-part name is written in italics.

Septic tank: an underground tank in which the organic matter in sewage is decomposed through bacterial activity.

Sewage: waste matter, particularly human faeces and urine, conveyed in sewers which are part of a sewerage system.

Shellfish: a general term for edible shelled molluscs (such as clams and sea snails) and crustaceans (such as crabs and shrimps).

Spawning aggregation: a grouping of a single species of reef fish that has gathered together in greater densities than normal for the specific purpose of reproducing.

Spawning: the act of releasing eggs, which in most fish, are fertilised by males releasing sperm into the sea.

Species: a distinct group of animals or plants able to breed among themselves, but unable to breed with other groups.

Subsistence fishing: the production of fish primarily for personal or household consumption.

Swim bladder: a gas-filled sac in a fish's body, used to maintain buoyancy.

Symbiosis: a relationship between two different living things that is of advantage to both.

Target species: the resource species at which a fishing operation is directed.

Total allowable catch (TAC): the total catch permitted to be taken from a fishery, usually in one year.

Toxin: a poisonous substance produced by a living thing.

Traditional fishery: a fishery that has existed in a community for many generations, in which customary patterns of exploitation and management have developed.

Transect: a straight line or band along which observations or measurements are made.

Trophic level: a feeding level containing organisms that obtain their nourishment in a similar way and from a similar source.

Wetlands: low-lying terrestrial areas that are flooded by tides and either contain or are saturated with water; examples include salt marshes, coastal swamps and mangrove forests.

Zooplankton: very small animals that drift in the sea, including the larvae of many marine animals.

© Copyright SPC, 2014

Secretariat of the Pacific Community
BP D5 - 98848 Noumea Cedex - New Caledonia
Telephone: +687 26 20 00
Facsimile: +687 26 38 18
E-mail: cfpinfo@spc.int





What is a fishery? A fishery* consists of a population or stock of fish or other aquatic species* that is exploited by fishers. A fishery, therefore, includes the exploited species, the fishers and the marketers as well as the ecosystems* in which all aquatic species are components.

An ecosystem is a biological community of interacting plants and animals (including humans) and the non-living components of the environment.*

A fishery also includes the people, in both fishing communities and government authorities, who manage the fishery.

Why manage fisheries?

All fisheries need to be managed to ensure that fish stocks are not overexploited* and continue to provide benefits to people in the future. With increasing populations and an increasing demand for seafood, a fishery will inevitably be overexploited if it is not managed.

Who manages fisheries?

Fishing communities, government agencies and fishing cooperatives can all manage fisheries. In many Pacific island countries, fishing communities are managing fisheries and are using traditional knowledge to do so. Most national governments have an agency that is responsible for fisheries management.

What are the aims of fisheries management?

The main aim of fisheries management is to ensure that fishing is sustainable. If management is successful, seafood will continue to be available both now and in the future.

Who assesses fish stocks and fisheries?

Managers rely on receiving assessments of the health of fish stocks. Sometimes this information comes from fishing communities. More technical assessments are made by scientific staff of government and regional fisheries agencies (see Teachers' Resource Sheet 2: Fisheries assessment).

What or who are we managing?

Fisheries management is mainly about managing people. It often involves preventing people from taking too many fish, using damaging fishing methods and harming the marine environment.

How can we ensure we have seafood for the future?

We have to have rules or regulations to protect our seafood species and the places in which they live. Fishing communities and national fisheries authorities impose many rules and these must be supported by all people.

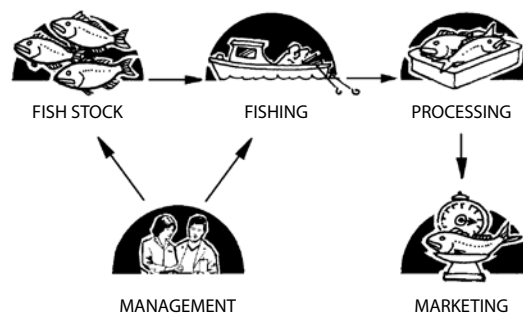

Fisheries management involves controlling catches from the fish stock, restricting the amount or type of fishing and protecting marine ecosystems.

Some general rules are:

- **Leave small individuals in the sea.** This allows adult fish to live long enough to breed and produce young fish, many of which will grow and be available to be caught in future years. Many fisheries authorities ban the catch of fish less than a minimum size.
- **Leave some big fish in the sea.** Larger individuals produce many more eggs. This is because egg carrying capacity is related to fish volume not length.
- **Protect plant-eating fish.** Some fish, such as parrotfish, unicorn fish and surgeonfish, eat seaweeds that would otherwise displace, compete with, or cover corals.
- **Ban or restrict some types of fishing.** Restrict the length of gill nets used and ban the use of small mesh nets. Limit the number of fish traps or fish fences. Ban methods such as using underwater torches and spears at night when fish are sleeping (see SPC Community Information Sheet 29: Plant-eating fish).
- **Ban the use of damaging fishing methods.** People using poisons and explosives are destroying our resources and our future.
- **Ban or reduce fishing on spawning* fish.** Ban fishing in areas where fish are known to gather to spawn* or at times when fish are gathering to spawn. Spawning refers to the act of releasing eggs, which in most fish, are fertilised by males releasing sperm into the sea. Many fish have to gather in large numbers to reproduce successfully (see SPC Community Information Sheet 24: Spawning aggregations)*.
- **Protect critical habitats.*** All species need places to eat, live and grow. Some species use different habitats at different stages of their lives. These important habitats may include mangroves, seagrass beds and corals.
- **Set up permanent reserves to protect fish and places in which they live.** Set up an area where fishing is banned to protect areas including corals and seagrass beds. No-take areas* may allow fish catches to eventually increase in nearby areas.
- **Protect watershed areas.** Seek government support to reduce sediments and nutrients* running off the land into rivers and lagoons; these cause damage to many marine habitats (see SPC Information Sheet 27: Nutrients and sediments).



Not all of the above measures are appropriate for all species. Individual information sheets should be consulted for the management options appropriate for specific species.

Fisheries managers recognise that we must manage not only fisheries but the areas in which fish live — this is called an ecosystem approach to fisheries management.



Eric Clua © SPC

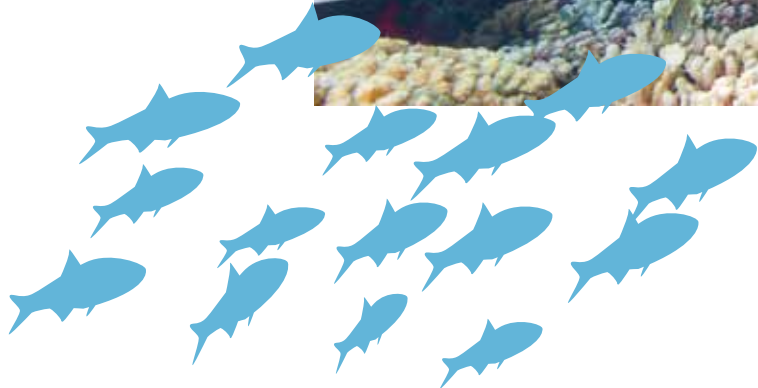



To assess something is to examine its status or standing at a given time. In fisheries assessment we are gathering information on the status or health of a fish stock or fishery. This assessment is used to provide fisheries managers with information that they can use to manage a fish stock.*

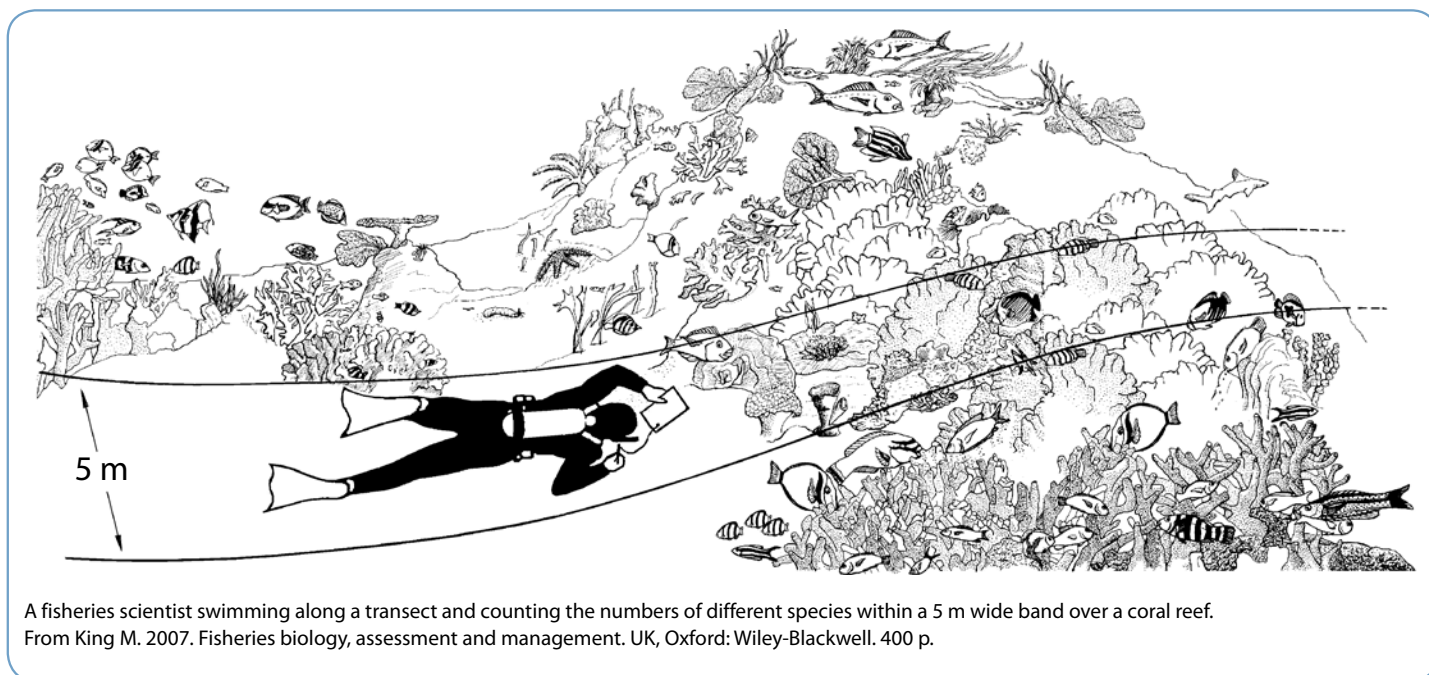

Assessments can range from those made by fishers and fishing communities to more complex analyses made by fisheries scientists. The problem with scientific analyses is that they often require a lot of information and sometimes many years of data collection.

Examples of formal assessments are given in the accompanying guide book. One exercise is based on completing transects* to estimate the size of a population of sea cucumbers on a shallow bank (the diver in the above illustration is completing a transect across a coral reef).

One of most extensive scientific assessments in the Pacific is part of the tuna research programme completed by SPC. Part of this research depends on tagging experiments in which tuna are tagged and released in order to obtain information on their migrations and other biological parameters. An example of using tagging information to estimate the numbers of fish in a population is included in the accompanying guide book. Methods of tagging marine species* are shown in the figure at the back.

However, there are so many species in tropical waters that the individual assessment of each species is a very difficult task. Fisheries managers have to rely on less complex assessments and some of these can be made by fishing communities.

One of the most basic measures of the health or wellbeing of a fishery involves examining changes in fish sizes and catch rates. If fish sizes in catches are decreasing it may suggest that too many large adult fish are being taken from the stock.



Related facts to consider

Coastal waters in the tropics are home to many more species than those in cooler waters. The number of different species decreases with distance away from the equator. For example, big fisheries in New Zealand are based on large numbers of relatively few species whereas a Pacific Island in the tropics has fisheries based on smaller numbers of many more species.

Catch rates refer to the amount of fish caught in a given fishing time; say the number of standard strings of fish, basket of clams, or a number of lobsters caught in an hour of fishing. If catch rates have been decreasing over many years it is likely that too many fish are being taken from the stock.

When seeking this information from fishers or in fishing communities it is often easier to ask about catch rates in terms of time taken to obtain a standard catch rather than catch per standard time. That is, for example, the time taken to catch a standard string of fish, a basket of clams, or a number of lobsters.

- If this fishing time is remaining the same, the numbers of fish are probably remaining the same. In this case, the assessment may be that the fish stock is healthy.
- If this fishing time is increasing, the numbers of fish are probably decreasing and management, if any, is not effective. In this case, different or additional management measures should be applied.

This assessment based on information from local fishers has sometimes been called "data-less management" as it is not based on time-consuming and often expensive surveys by fisheries scientists.

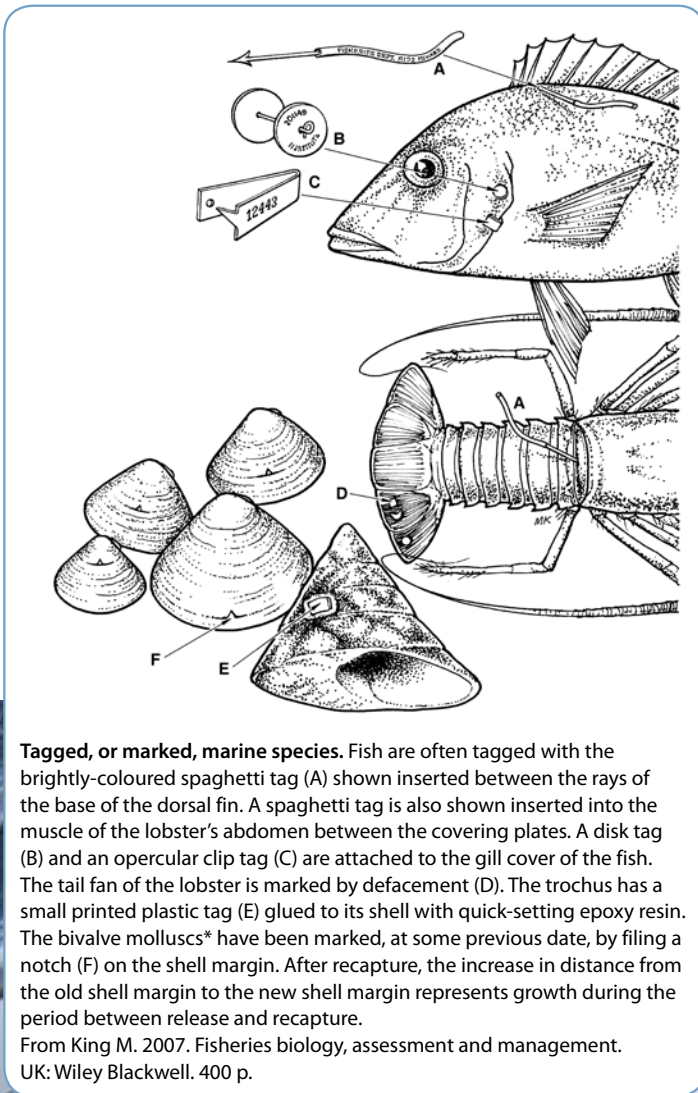

Tagged, or marked, marine species. Fish are often tagged with the brightly-coloured spaghetti tag (A) shown inserted between the rays of the base of the dorsal fin. A spaghetti tag is also shown inserted into the muscle of the lobster's abdomen between the covering plates. A disk tag (B) and an opercular clip tag (C) are attached to the gill cover of the fish. The tail fan of the lobster is marked by defacement (D). The trochus has a small printed plastic tag (E) glued to its shell with quick-setting epoxy resin. The bivalve molluscs* have been marked, at some previous date, by filing a notch (F) on the shell margin. After recapture, the increase in distance from the old shell margin to the new shell margin represents growth during the period between release and recapture. From King M. 2007. Fisheries biology, assessment and management. UK: Wiley Blackwell. 400 p.





What is fisheries economics? Fisheries economics generally refers to the contribution that the fisheries sector makes to an economy. In economics, we typically discuss the value of fisheries products that are captured, produced or traded and what contribution the fisheries sector makes to an economy in terms of value of production, employment, exports* and government income.

Fishing and aquaculture are primary production* activities, but the fisheries sector also includes private sector processing and trading businesses and fisheries-related public sector jobs.

How do fisheries contribute to Pacific Island economies?

Fisheries contribute to the economies of the Pacific Islands:

- i. by adding to the gross domestic product (GDP)* of an economy. Fishing and aquaculture add to total domestic productivity;
- ii. by generating government income from the sale of fishing licences to foreign fishing companies and through taxes that are applied to traded fisheries products;
- iii. by creating employment for Pacific Islanders (see Teachers' Resource Sheet 14: Job opportunities in fisheries);
- iv. by creating opportunities to export, which is an important source of foreign income and contributes to GDP growth. Government income can also be generated from tax on exports.

Three major fisheries that contribute to Pacific economies

In the Pacific, the three main fisheries include:

- i. the industrial tuna fishery*;
- ii. small-scale fisheries; and
- iii. aquaculture.

The industrial tuna fishery

The industrial tuna fishery refers to commercial fishing* vessels that capture large quantities of fish (mostly tuna) that are sold to canneries or high-value foreign markets. There are four main categories of fishing vessels operating in the industrial tuna fishery (Fig. 1).



Figure 1. Four main categories of industrial fishing vessels operating in the Pacific.

Four species* are of major commercial importance in the Pacific's industrial tuna fishery (Fig. 2).

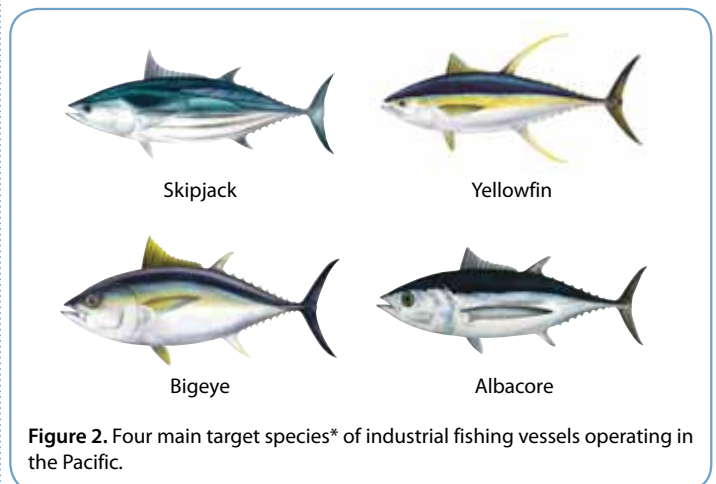

Figure 2. Four main target species* of industrial fishing vessels operating in the Pacific.

Small-scale fisheries

Small-scale fisheries can be subsistence or commercial in nature, supplying fish for local consumption and export markets. They generate income, provide food and make an important contribution to Pacific economies.

In the Pacific, the main small-scale fisheries that provide food and income to Pacific Islanders include:

- i. small-scale pelagic* fisheries capturing tuna, wahoo, mahi mahi and other pelagic fish;
- ii. small-scale coastal fisheries capturing sea cucumber, trochus, reef fish, marine ornamental products and invertebrates*;
- iii. demersal fisheries capturing snapper and other deepwater fish; and
- iv. sport fishing tourism generating income from charter operations.

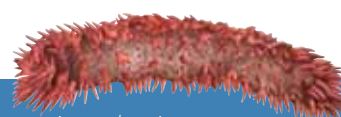

Aquaculture

Aquaculture involves marine and freshwater production systems. Aquaculture plays an important role in food security and income generation for Pacific Islanders. Some of the important aquaculture products that are produced in the Pacific include:

Mariculture	Freshwater aquaculture
Marine shrimp	Tilapia (Nile, Mozambique, or genetically improved farmed tilapia (GIFT))
Pearl oyster	Freshwater prawn
Milkfish	Grass carp
Seaweed	
Marine ornamentals (giant clam, coral, live rock)	
Sea cucumber	

In the Pacific, in terms of income generation, the production of pearls and marine shrimp is the most valuable. In terms of economic contribution, aquaculture plays an important role in boosting domestic productivity (i.e. contributing to GDP), but also by providing foreign income from export of aquaculture products.



Businesses in the fisheries sector

There are many different types of businesses in the fisheries sector — some large and some small. Some businesses are involved in production (e.g. fishing vessels, aquaculture farms), some are involved in processing (e.g. tuna canneries, restaurants), while others are involved in the trade (e.g. local market sellers, exporters) of fisheries products.

Irrespective of the activity or size of a business, collectively fisheries businesses are very important to the Pacific Island economies in the sense that, as outlined above, they positively contribute to GDP, employment, exports, food security and tourism development.





Why should there be areas where we can't go fishing? We need to catch fish for food and to make a living. However, the problem is that catch rates, say the number of fish caught in one hour, is decreasing.

Why is this happening? It could be that we have caught too many and there are not enough adult fish left to reproduce and replace the numbers that we catch. Or it could be that we have damaged the environment* in which the fish live or the ecosystem* of which the fish are a part.

Fisheries authorities and fishing communities are taking steps to manage ecosystems and fishing so that stocks of fish and invertebrates* remain at a sustainable level. Fisheries can be managed in many different ways and these are discussed in Teachers' Resource Sheet 1: Fisheries management.

One of the fisheries management tools commonly used in Pacific Island countries is establishing no-take areas* in which fishing is not allowed. In the Pacific, no-take areas may also be called fish reserves, *tabu* areas or marine protected areas. The term no-take area is preferred because its meaning is clear.

What are no-take areas?

A no-take area is an area in which all fishing or harvesting of marine life is banned, ideally on a permanent basis.

Are there other types of restricted fishing areas?

Other types of closures include an area in which particular fishing methods are banned; for example, the use of nets may be banned even though other less damaging fishing methods, such as line-fishing, are permitted. Another is an area in which the catching of a particular species* is banned; for example, the collection of sea cucumbers may be banned in an area even though the catching of other species is allowed.

In addition there are rotational closures* in which a given fishing area is divided into smaller units which are fished in rotation; for example, if there are three smaller units, fishing is banned in the first area while the other two are open to fishing. The following year, fishing is banned in the second area while the other two are open to fishing — in this example each small unit would have one unfished year to regenerate every third year.

There are also periodic closures, such as those in which fishing is banned for a short time to protect fish during spawning.*

Although these variations are important in managing particular fisheries, it is important to have some permanent no-take areas to provide long-term protection for ecosystems and the species that they support.

What are the purposes of no-take areas?

Most scientists agree that no-take areas provide the following benefits:

- They protect habitats, plants and animals. In scientific terms, they conserve biodiversity*.
- They enhance fisheries in nearby areas. They provide places in which fish can grow, breed and spread to other areas.
- They protect against environmental uncertainty such as global warming. They are more likely to contain less stressed habitats, which would be more resilient to environmental changes.
- They provide unspoilt areas for income generating ecotourism. Tourists will pay to see well-preserved areas of corals and coral reef fish (however, visitors should keep to marked tracks, or snorkelling trails, in order not to damage reef areas).

Point b) is most important to many fishers who have to obtain seafood on a daily basis to feed their families. The basic aim is to ensure that there are undisturbed habitats and a sufficient number of adult fish to produce enough young to replace the numbers caught.



© Francis Hickey

How can no-take areas increase catches?

A fishing community's expectation is that a no-take area will eventually result in improved catches outside the no-take area. In reference to the figure below, the no-take area is represented by the heavy circle.

Fish in the no-take area spawn and produce small larval stages that either A) settle and remain in the no-take area or B) drift with the

currents to settle and grow outside the no-take area. Juveniles and adult fish also C) move out of the no-take area as spillover, perhaps due to crowding.

A permanent no-take area is just one way of managing a fishery* but it is an important tool in a toolbox of management controls, some of which are listed in Teachers' Resource Sheet 1: Fisheries management.

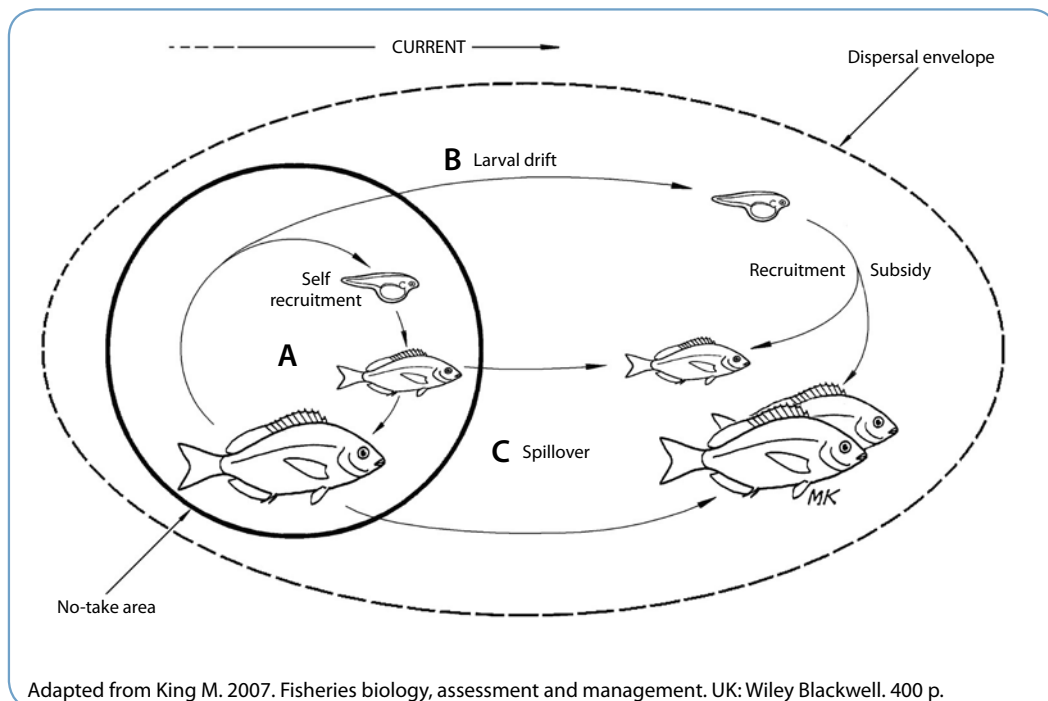

Adapted from King M. 2007. Fisheries biology, assessment and management. UK: Wiley Blackwell. 400 p.



Over half of all animals with backbones (vertebrates*) are fish. There are over 25,000 different species* of fish. Some fish are adapted to eat plants and others to eat meat and they have evolved to fill all available niches* in the marine environment.* Some evolved to hunt on coral reefs and others to swim in the open sea.

External features

Fish have two sets of paired fins, the side or pectoral fins and the pelvic fins. Single fins include the dorsal or back fin, the anal fin and the caudal or tail fin.



Amazing information to think about

Fish appeared on this planet over 400 million years ago. The four limbs of all land-dwelling (terrestrial) animals with backbones that exist today are believed to have evolved from the paired fins of fish.

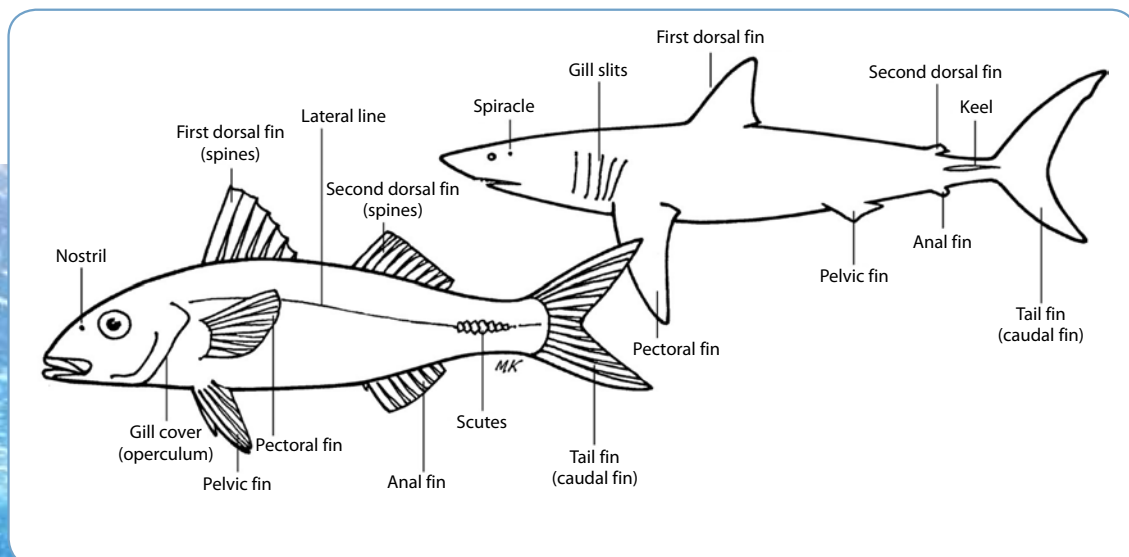

Internal features

How do fish stay afloat? They are heavier than water and tend to sink. The two main evolutionary lines, the cartilaginous and the bony fish, have solved the problem of staying afloat in different ways.

Sharks and rays have a light skeleton of cartilage, a firm but flexible type of tissue. They also have a large liver which is rich in the light oil, squalene and fixed pectoral fins which act as paravanes. As a shark moves forward through the water, pressure on the underside of its pectoral fins provides uplift. Thus many, but not all, species of sharks have to swim continually to stay afloat.

The other evolutionary group, bony fish or teleosts, have heavy bones of calcium, but solved the problem of remaining buoyant in a different way. Ancient fish had lungs which evolved into the air-filled swim bladder* of modern bony fish, most of which obtain oxygen through their gills. A small number of fish can gulp air at the surface.

The evolution* of the swim-bladder allowed fish to move away from speed as a way of life. Pectoral fins, no longer required for aiding flotation, could evolve to allow a greater range of movements. Present-day bony fish use pectoral fins to hover, to swerve, to swim backwards and even, in the case of flying-fish, to glide through the air. The ability to take advantage of a variety of ecological niches, to be either bottom-dwelling or pelagic,* has allowed modern bony fish to dominate the waters of the world.

The gill rakers, comb-like structures in front of the gills, sift particles of food from the water which enters the mouth and flows out through the gill slits. The digestive system includes an S-shaped stomach leading to an intestine which is often longer in herbivores than in carnivores. At the junction of the stomach and the intestine, there are often finger-like sacs, the pyloric caeca, whose function may include aiding food absorption.

Fish have internal ears with no connection to the outside. Sound waves, travelling through the water and the head, strike dense calcium carbonate "earstones" or otoliths which float in the fluid contained in the inner ear. The otoliths vibrate against sensory hairs in the ear. As the fish grows more layers, these are deposited on the otoliths, which enables them to be used by scientists to estimate the age of some fish.

Many fish produce sounds and this is often reflected in their common English names — drums, croakers and grunts.

And, fish have one sense that we don't have. They have a lateral line which runs down each of its sides. The lateral line is believed to be capable of detecting low-frequency vibrations in the water as well as pressure changes due to different depths.

Fish have gonads* which are usually paired. In most fish, females release eggs into the sea where they are fertilised by sperm released from males. The fertilised eggs hatch to small larvae* (often about 5 mm in length) most of which drift with ocean currents.

After a period which varies from species to species, the larvae change — benthic species settle on the sea floor. The juveniles of many fish species grow in nursery areas, including reefs, banks, bays and estuaries.

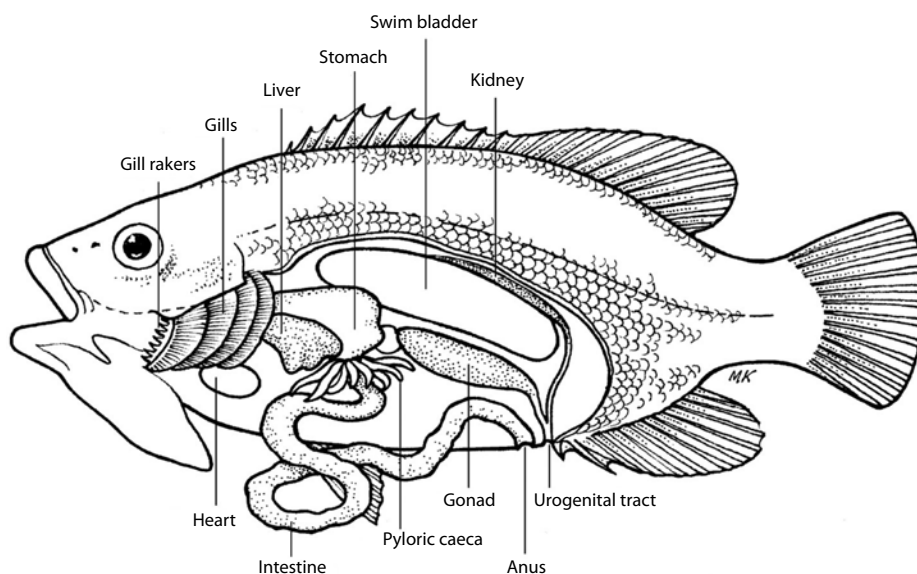

Did you know?

Fish eyes are spherical and have given their name to the photographer's fisheye lens used to take in a field of vision covering up to 180°. The eyes of many fish appear to be capable of distinguishing colours.

The internal organs of a bony (teleost) fish.

Adapted from King M. 2007. Fisheries biology, assessment and management. UK: Wiley Blackwell. 400 p.



In the sea, as on land, plant material is eaten by herbivorous animals which themselves are eaten by other, usually larger, animals. This flow of material from plants to herbivores to carnivores* is often depicted in a diagram called a food web* that shows the feeding connections (what eats what?) in an ecological community.*

What eats what?

In relation to the food web below, plants include mangroves (1), algae and seagrasses (2). Mangroves are not present in all Pacific Island countries — see Community Information Sheet 25: Mangroves.

But the most important plants in the sea are so small that most are invisible to the naked eye. These are the phytoplankton* (shown greatly magnified at point 3) that, as plants, must live in the sunlit surface layers of the sea.

Corals (4) and giant clams (5) can also use sunlight indirectly because of the plant cells, called zooxanthellae* embedded in their tissues. This relationship between two different living things that advantages both is called symbiosis.*

Larger plants in the sea are eaten by herbivorous animals such as rabbitfish (6) and sea urchins (7).

Several larger animals have evolved to take advantage of drifting phytoplankton. Bivalve molluscs,* the cockles and clams, filter out the phytoplankton. But the most important consumers of phytoplankton are the small animals, collectively called zooplankton* (magnified in 8) that drift in the sea and include the larvae* of many marine animals.

Many animals, from barnacles and corals to sardines (9) and baleen whales eat zooplankton. Also, coral polyps trap plankton in sheets of mucus or with their tentacles.

Coral grazers, such as parrotfish (10) feed on algae growing on coral.

Invertebrates* and smaller fish are preyed upon by medium-sized fish including emperors (11) which are preyed upon by large carnivores such as groupers, barracudas and sharks (12).

Bacteria* break down wastes to form detritus* (13), consumed by a wide range of animals such as the sea cucumber (14) and mullet (15).

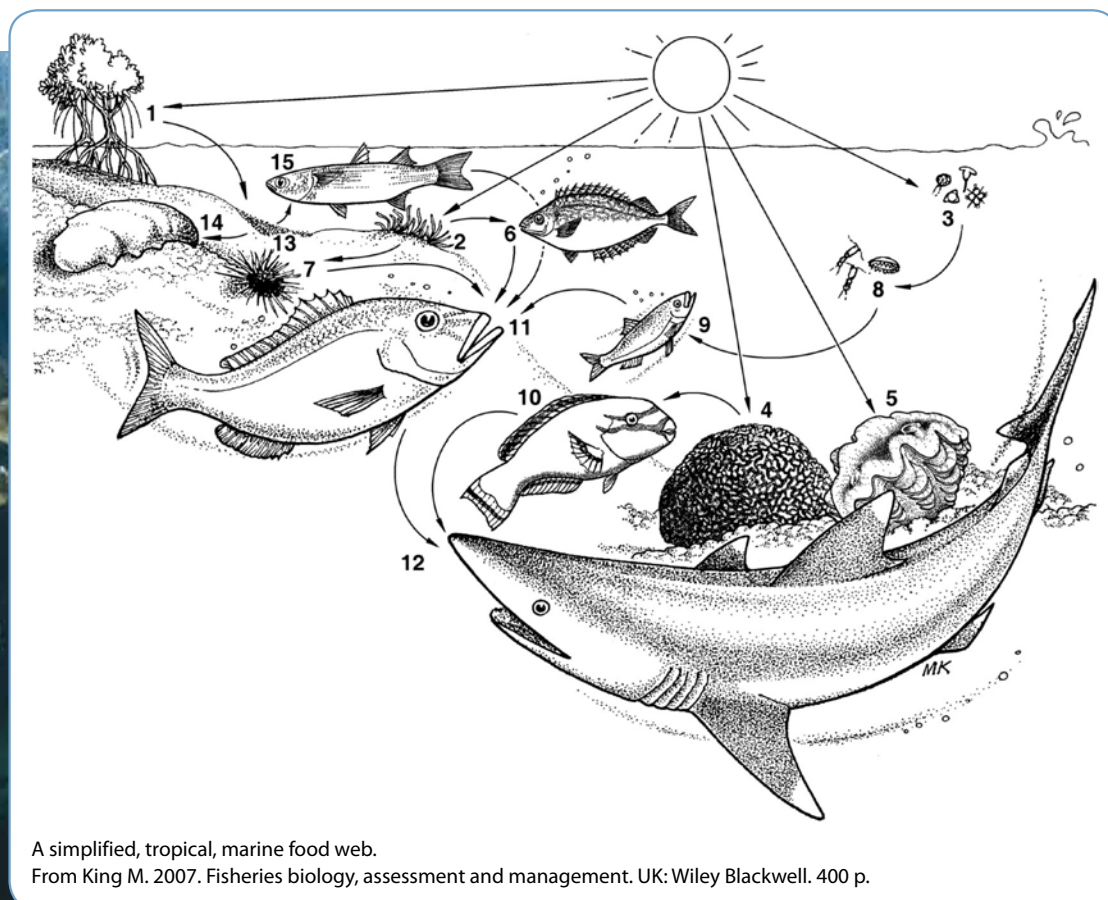

A simplified, tropical, marine food web.

From King M. 2007. Fisheries biology, assessment and management. UK: Wiley Blackwell. 400 p.

Why are there not many sharks on a coral reef?

Organisms can be thought of as gaining nourishment at different trophic levels* and these may be depicted as the energy pyramid shown below. The first or lowest trophic level in the energy pyramid, the primary producer level, consists of marine plant material including seaweeds (algae), seagrasses and phytoplankton.

Plant material is fed upon by animals at the next trophic level (the herbivore level) which become prey species* for carnivores (the carnivore level). And, as some fish feed on other carnivores, there may be several levels of carnivores.

At each level most of the total weight of material or energy (the biomass*) is lost due to the use of energy for respiration, movement and reproduction. As a result, only a small proportion of the food consumed is devoted to flesh growth that may be passed on to the next trophic level. There is, therefore, a large decrease in total biomass of organisms at each succeeding trophic level.

The biomass values shown to the right of the energy pyramid in the figure below arbitrarily assume a 10 per cent level of ecological efficiency — that is, the energy passed from one trophic level to the next. It therefore takes 1,000 kg of plant material to produce one kg of a higher level carnivore such as a snapper.

Because of this loss at each succeeding trophic level, animals at high trophic levels are unable to maintain very large populations. A top carnivore such as a large tiger shark is, perhaps thankfully, not common at all and most sharks need to swim over a huge territory to find all the food that they require.



Why we have to look after the sea and its tiny plants?

Life on earth could not exist without plants. Photosynthesis is the process by which green plants use sunlight, carbon dioxide and nutrients* (including nitrates and phosphates) to synthesise proteins,* fats and carbohydrates. Through photosynthesis, plants produce oxygen and food to support all life. Phytoplankton are responsible for half of all photosynthetic activity and produce much of the oxygen present in the Earth's atmosphere — half of the total amount of oxygen is produced by phytoplankton in the sea.*

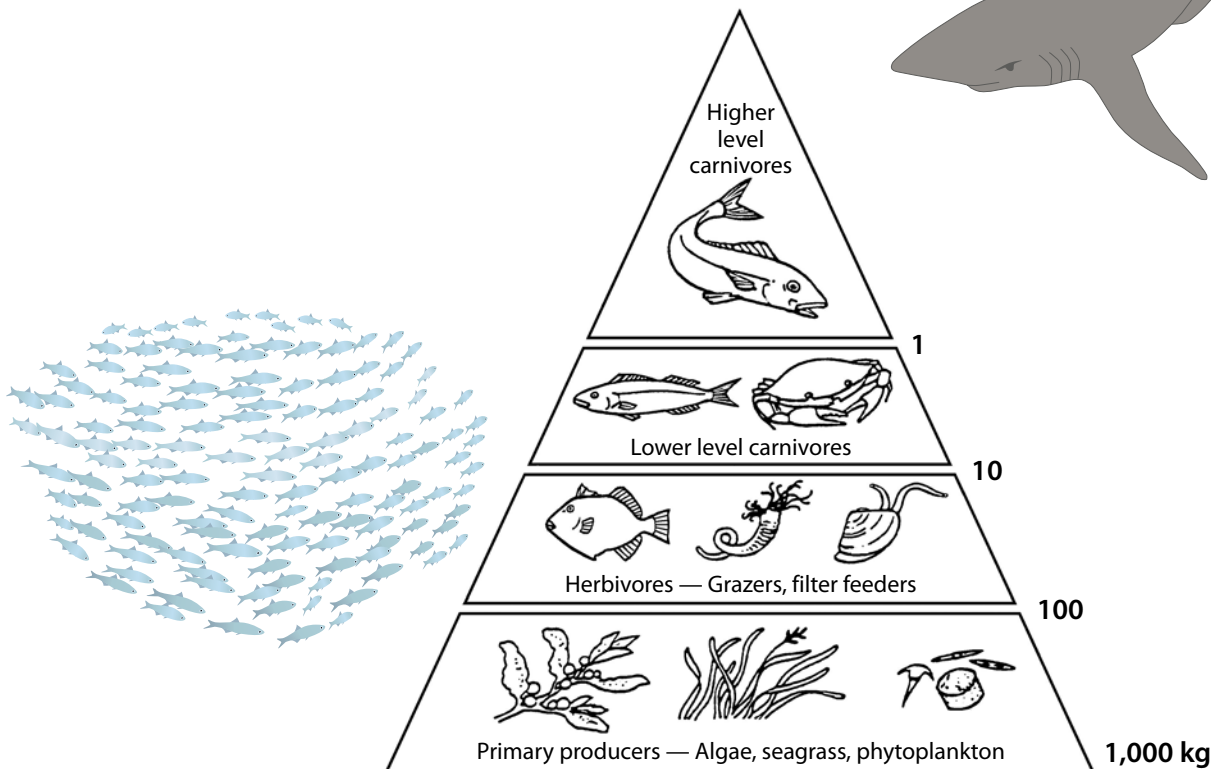
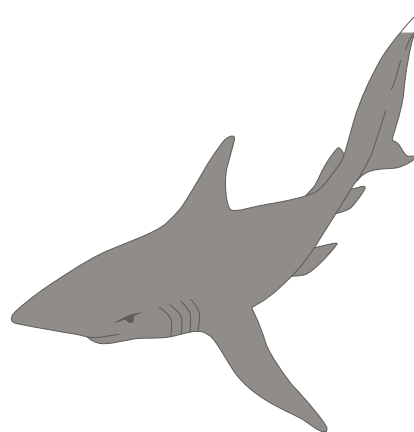

An energy pyramid. Numbers at the right of the pyramid represent the relative biomass at each trophic level assuming an ecological efficiency of 10 per cent. From King M. 2007. Fisheries biology, assessment and management. UK: Wiley Blackwell. 400 p.



Imagine living out on the surface of the open sea — being hunted by birds from above and by larger fish from below - and with no place to hide!

But a few species* have managed to adapt to this difficult pelagic* environment.* The best known of these are the species of tuna, which are distributed over large areas of the Pacific Ocean where they hunt smaller fish. Other oceanic species include billfish*, mahi mahi and wahoo.

Tuna are caught by local fishers often by towing (or trolling) lures behind small boats. Commercial fishing* vessels use longlines and purse seines — these fishing methods are described in Teachers' Resource Sheet 16: Modern fishing methods. Here, we are more concerned with the amazing adaptations of fish that live in the open sea.

Pelagic fish rely on speed to catch their prey and to avoid predators*. And, as water is "thicker" than air (in fact, 800 times more dense* than air), any part of the body that creates friction or turbulence causes a large amount of drag. Compared with travelling through the air, travelling through water is like moving through honey!

In many fast fish, the pectoral or side fins are used as brakes and rudders and fit into depressions in the body when the fish is swimming at speed. The caudal or tail fin, which provides the propulsion, may be shaped like a scythe, with both a long leading edge and a small surface area (a high aspect ratio).

But the shape of the body is most important. The best shape is one of a spindle or tear-drop, called a fusiform shape, as this offers the least resistance or drag when moving through the water. Independently, this fusiform shape has evolved in aquatic mammals such as dolphins and whales. Not so independently perhaps, marine architects have used the shape in designing boats.

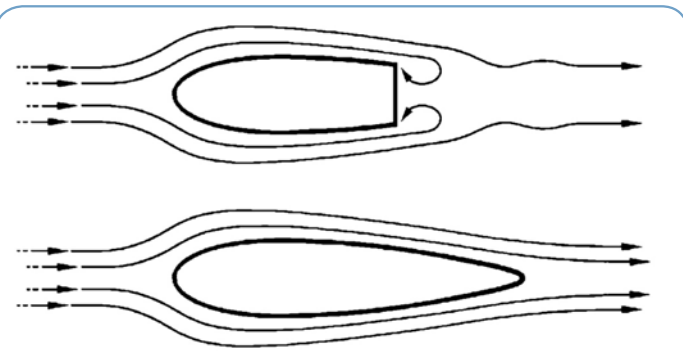

Laminar flow* of water past a blunt-ended shape (top), which creates turbulence and drag and flow past a fusiform shape (bottom) which minimises drag.

From King M. 2007. Fisheries biology, assessment and management. UK: Wiley Blackwell. 400 p.

Life in the fast lane

In addition to their shape, tunas have other adaptations that assist with their fast life. Unlike most other fish, tunas are warm-blooded and keep their bodies at higher temperatures than the surrounding water. A higher body temperature allows increases in muscle power and may account for a tuna's ability to swim at speeds of over 50 kilometres per hour to catch smaller fish. But another oceanic species is much faster.

Which is the fastest animal on the planet?

This is undoubtedly the peregrine falcon, a bird of prey, which can dive at over 300 kilometres per hour. The fastest land animal is the cheetah which can run to catch its prey at over 100 kilometres per hour. But in the sea, the fastest fish is the sailfish.



Bulbous bows?

Have you seen pictures of ocean-going ships below the waterline?

They often have a rounded bulb or bulge sticking out at the bow (or front) just below the waterline. The bulbous bow makes the ship's underwater profile more fusiform and allows water to flow around the hull more easily. Large ships with bulbous bows generally have a 12% to 15% better fuel efficiency than similar vessels without them.

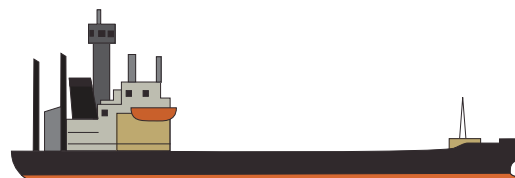

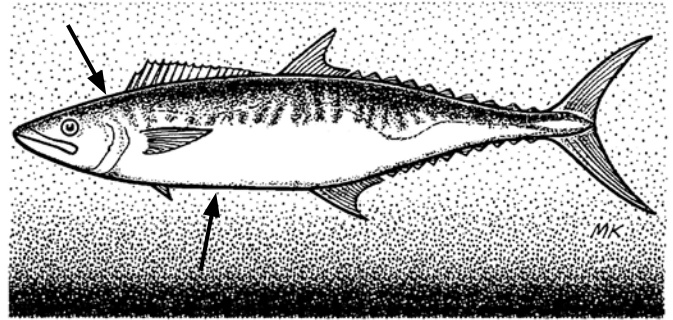
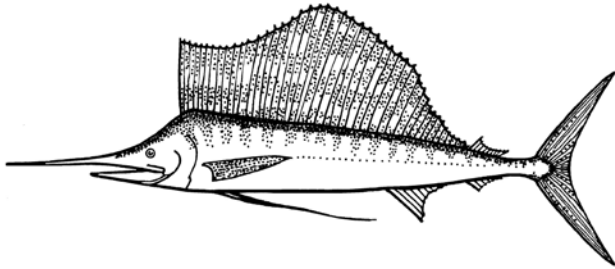

Counter-shading in a pelagic fish.

From King M. 2007. Fisheries biology, assessment and management. UK: Wiley Blackwell. 400 p.

Sailfish, which can grow to reach 100 kilograms, have large, sail-like dorsal fins more than twice as high as the body is deep. They appear to hunt in groups and their tall blue dorsal fins, cutting through the surface of the sea, are used to herd prey species into a tight ball. The sailfish then move through the ball, slashing from side to side with their long bills to kill or maim the smaller fish. With a timed short-burst swimming speed of 110 kilometres per hour, the sailfish may be the fastest non-flying animal on the planet.

In the open sea, you can swim but cannot hide — or can you?

Most pelagic fish have a very subtle form of camouflage* called counter-shading to avoid predators. Fish that habitually swim near the surface often have dark backs that shade to lighter underparts. To a predator swimming below such a fish, the lighter underparts appear the same shade as the sky and the bright surface of the sea. But to a predator such as a sea bird flying above, the dark back of the fish merges in with the deep blue shades of the sea.





What is the most valuable fish in Pacific Islands? Tuna, because of its export value? Or emperors — the most commonly caught reef fish? No, it's a fish that is full of bones and not often caught to eat.

Recreational fishers,* who regard bonefish as prized sportfish because of their fighting ability, are prepared to travel great distances to catch them. The fishers buy local food, stay in local accommodation and often pay for local guides.

And because most fishers release bonefish immediately after capture, one fish can be caught and released many times. One bonefish, therefore, has the potential to bring many thousands of dollars to a local community.

The fish

Are all bonefish the same? Evidently not — there are several different species* of bonefish but the one most commonly caught by fishers in the Pacific has the scientific name* of *Albula vulpes*. Bonefish are silver with darker fins and can reach a length of up to 90 cm. The world International Game Fish Association (IGFA)* record is 8.62 kg for a bonefish caught in South Africa in 1962; since then there have been unconfirmed reports of fish weighing more than 9 kg.

Bonefish are named for the many fine bones they contain or for their elusive habits, with names such as grey ghost. In French Polynesia they are called *o'io*, *albulu* or "sorte de mulet".

Recreational fishers stalk bonefish as they move across shallow sandy areas hunting shrimps, small molluscs and crabs. Bonefish are caught by fly fishing* — a special method in which fishers use a rod and reel with a line and an almost weightless fly or "lure" to encourage the fish to strike.

Although larger bonefish may swim either alone or in small groups, smaller fish often travel in large schools.* As medium-sized predators,* bonefish are an important link between invertebrates* and larger predators in marine food webs* (see Teachers' Resource Sheet 6: Marine food webs).

Bonefish are generally not preferred as food although they are eaten in some countries such as Hawaii, Kiribati, French Polynesia and the Cook Islands. However, they are highly valued by sports fishers and have the potential to be of great economic benefit to countries in which they are found.

Lifecycle

Bonefish reach sexual maturity between 3 and 4 years of age. In the Pacific, bonefish appear to spawn in deeper water over several months of the year around the time of the full moon.

Fertilised eggs hatch into larvae* which drift in the ocean for long periods, perhaps for over two months. Many larvae do not reach areas in which to settle and many others become food for other fish. Only a small number of drifting larvae survive to settle in shallow sandy areas where they grow into juveniles that look like miniature versions of their parents.

Bonefish may live for more than 19 years but are taken by many predators including sharks and barracudas. Their main defences are their cautious behaviour and fast escape speed. For these reasons, fishers find that schools of bonefish are easily frightened or "spooked" and the fish are difficult to catch.

Habitat

Adult bonefish are commonly found in intertidal flats, mangrove areas, river mouths and deeper adjacent waters.

A fish that breathes air? Bonefish can live in waters, such as in warm lagoons and creeks, that contain very little dissolved oxygen — they do this by swimming to the surface and gulping air into a lung-like swim bladder* (see Teachers' Resource Sheet 5: Fish anatomy).

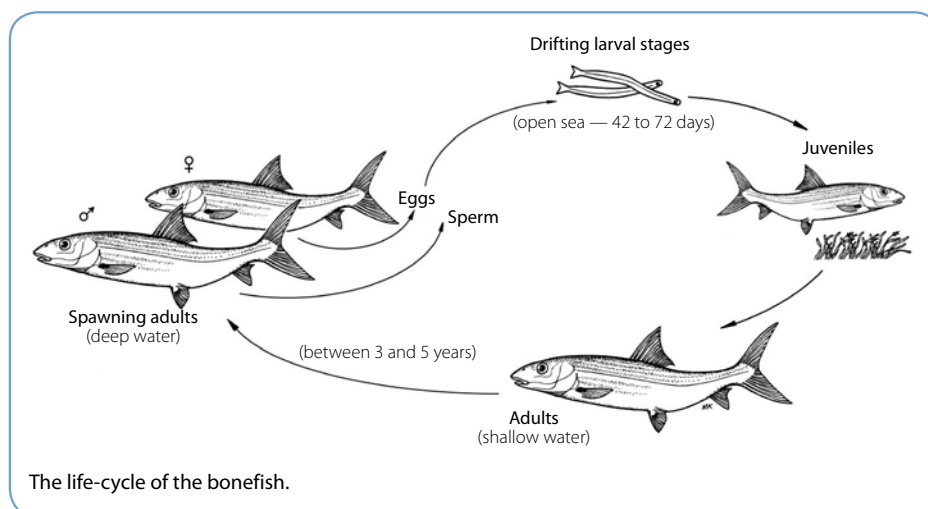

Distribution

Bonefish inhabit tropical and warm temperate waters around the world. They are fished on the east coast of North and South America and the Caribbean. They have been found in several Pacific Islands including New Caledonia, Fiji, Cook Islands, Kiribati and French Polynesia.

Management

All fisheries need to be managed to ensure that fish stocks are not overexploited* and continue to provide benefits to people in the future.

Some managers have imposed direct measures to protect bonefish stocks. In the Cook Islands fishery* in Aitutaki, for example, fishers are required to have a permit and to fish only in designated areas. Fishing in spawning* areas is prohibited from three days before until three days after the full moon.

Most sports fishers release their catch immediately after capture. This type of fishing, called “catch and release”, involves fishers returning caught fish to the water as quickly as possible. This practice is likely to protect bonefish from overexploitation.

However, management actions could include protecting important bonefish habitats* including seagrass beds in lagoons and limiting the number of local guides in a given area.





A pearl oyster is a bivalve (or two-shelled) mollusc and is therefore related to mussels and clams. And a pearl is a pearl oyster's way of protecting itself from damage to its flesh.*

If a parasite or a sharp grain of sand gets inside its shells, the oyster can cover it with layers of smooth pearl. These gleaming layers around the irritant become a blister attached to the inside of the shell or, much less commonly, a free spherical pearl that can be very valuable.

Anatomy

The pearl oyster relies on pumping seawater over its gills. The gills consist of four crescent-shaped flaps covered with fine hairs called cilia, which move water through the inside of the gaping shells. The oyster's gills, like those of a fish, are responsible for extracting oxygen that is dissolved in the water.

The gills also filter food — microscopic floating plants (phytoplankton)* from the water. The cilia pass the food particles to the mouth, which is hidden under two horizontal lips, the labial palps. The mouth leads into the stomach contained within a brown mass called the digestive gland. Used food passes along an intestine to pass out of an anus, conveniently placed where water currents leave the oyster.

Why is it so difficult to open the shells of a living oyster? The largest muscle in the oyster, the adductor, holds the two shells tightly shut if the oyster is exposed at low tide or threatened by a predator* — although many bivalve molluscs have two adductor muscles the pearl oyster has only one.

Oysters usually have separate sexes and the gonads* in both sexes are creamy yellow in colour. Sperm and ova develop in the gonads of males and females respectively.

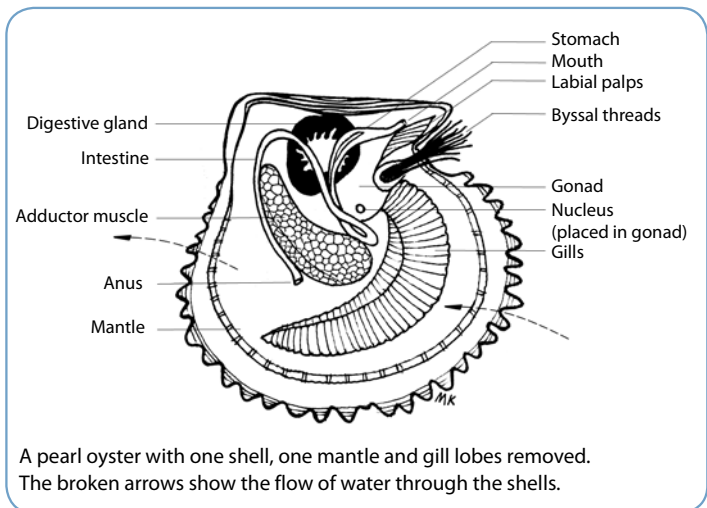

An amazing living filter

When the pearl oyster's two shells gape open it can pump up to 20 litres of water each hour removing food and gaining oxygen from the sea.

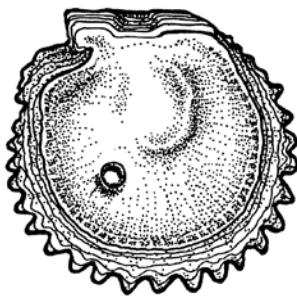

The black-lipped pearl oyster, *Pinctada margaritifera*, with one of its shells removed and a pearl lying on the oyster's mantle.

Shell and pearl formation

How does an oyster with two hard shells grow in size?

The oyster's body is covered by the mantle, a fold of tissue, edged with small tentacles. The mantle has specialised cells that produce additional shell material as the oyster grows and can encase irritants with concentric layers of mother-of-pearl or nacre.

A cross-section of a typical mollusc shell is shown in the figure at the back. The shell consists of three separate layers, an outer periostracum, a middle prismatic layer and an inner nacreous layer made up of thin layers of nacre. Iridescent colours are created by light waves reflected from the thin overlapping layers.

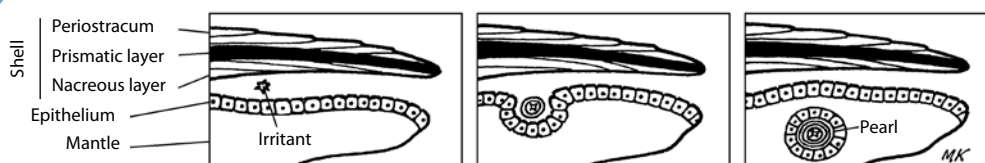

Pearl formation in pearl oysters. An irritant between the shell and the mantle is enveloped by the mantle which produces concentric layers around it. Very rarely, a pearl is formed around the object.

From King M. 2007. Fisheries biology, assessment and management. UK, Oxford: Wiley-Blackwell. 400 p.

Pearl farming

In the Pacific region, the black-lipped pearl oyster, *Pinctada margaritifera*, is grown, often on hanging ropes, to produce dark coloured pearls. After growing in the sea for about two years, each oyster has a small bead inserted in it by a skilled technician — a process called seeding.

It takes another two years for layers of nacre to be laid down around the bead and for the pearl to develop inside the oyster. Within a lifespan of 10 years, an oyster can be seeded and produce pearls several times. Many factors affect the success rate, but out of 100 oysters seeded, typically only five will produce a high quality, round pearl.

Management

Management is necessary to ensure that pearl farms continue to be productive and provide benefits to the farmers and the country.

The sites of pearl farms have to be carefully chosen to ensure that sea currents are sufficient to bring food and remove waste material from the oysters as they grow. Farms must be well spaced to avoid poor growth and the spread of oyster disease. As a healthy oyster is needed to produce a good pearl, it is in the interest of farmers as well as government authorities to maintain good environmental conditions.





Although there are very few freshwater fish and invertebrates in many Pacific Islands, several species* are important food items. Sometimes the production from freshwater fisheries is surprising — in Fiji, for example, the largest fishery* on a single species is based on the freshwater clam, *Batissa violacea* or kai, which women collect from rivers.*

Where are freshwater species distributed?

The greatest number of freshwater fish are found in the west of the Pacific Ocean where the high islands of Melanesia, such as Papua New Guinea, Solomon Islands, Vanuatu, New Caledonia and Fiji, have many rivers and lakes suitable for freshwater species.

Where did freshwater species come from?

Many freshwater fish are believed to have originated from seawater species that have become adapted, perhaps over many thousands of years, for living in fresh water. A less likely possibility is that their ancestors managed to cross the sea from areas in the west. Perhaps larval stages crossed the sea in pockets of fresh water trapped in rafts of trees blown over during cyclones.

Here we discuss four widely distributed freshwater species — one fish, one prawn, an eel that spends part of its life in fresh water and one introduced species of fish.

Flagtails

Several species of fish called flagtails are found in fresh water across the Pacific. These silvery fish have dark stripes on their tails and belong to the family Kuhlidae. They are variously called *aholehole*, *sesele*, *sakelo*, *ika droka*, *mahore*, *umatari*, mountain trout and flagtail perch.

One particularly large species is the jungle perch, *Kuhlia rupestris*, which grows to 45 cm in total length and 3 kg in weight, and is an important subsistence food, particularly in the interior of the large islands.

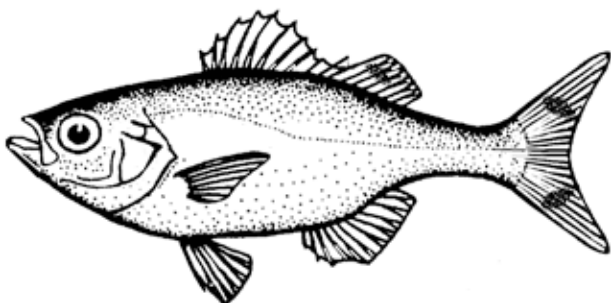

i

A hotspot of biodiversity* — the Coral Triangle

The Coral Triangle (a region comprised of the Philippines, Malaysia, Indonesia, East Timor, Papua New Guinea and Solomon Islands) contains a larger number of different species than most places in the world (it is said to have a large biodiversity).

Many species, including corals and mangroves, appear to have spread out from this area to Pacific Islands. And, because of the difficulty of larval stages reaching far away islands, the number of species decreases across the Pacific from west to east.

Freshwater prawns

Freshwater prawns (*Macrobrachium lar*) are distributed from Africa across the Pacific as far as the Marquesas. Their common names include Tahitian prawn, monkey river prawn, ghost shrimp and glass shrimp.

The prawns are collected as food and there has been some interest in farming them; however, there has been a preference for farming the giant freshwater prawn, *Macrobrachium rosenbergii*.

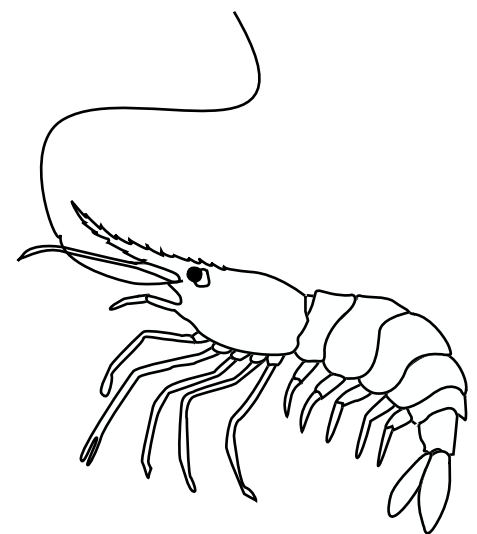

Eels

Eels belonging to the genus* *Anguilla* have a fascinating life-cycle.

The mature adults migrate from the relative safety of freshwater rivers over huge distances to breed in the deep dark sea. Here at the place where they were born, they breed and are then believed to die thousands of kilometres from the rivers where they lived for most of their lives.

The eel larvae* drift with sea currents and change into the colourless small eels known as glass eels as they reach land. After they adjust to fresh water, the eels migrate well into the upper reaches of river systems where they may gain weights of 20 kg.

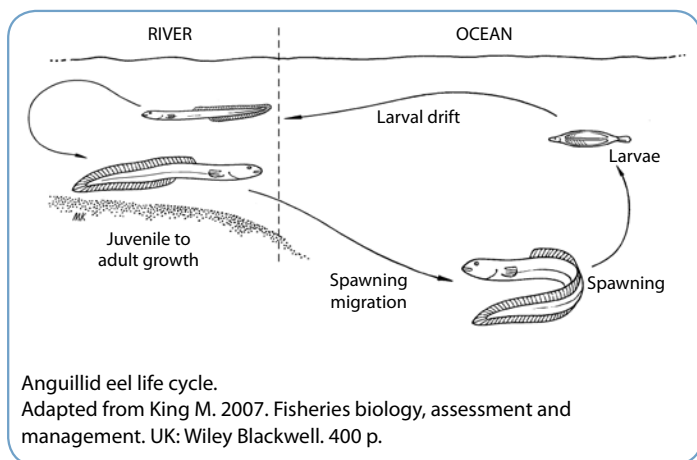
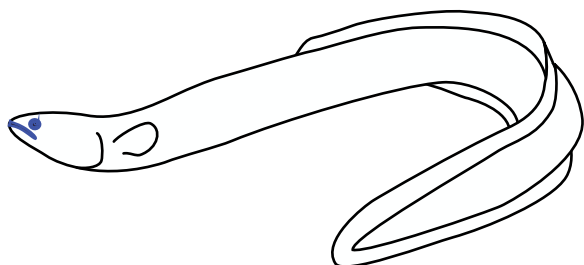

Anguillid eel life cycle.
Adapted from King M. 2007. Fisheries biology, assessment and management. UK: Wiley Blackwell. 400 p.

i Eel confusion?

The eels described here should not be confused with moray eels of which there are many species living in sea water on coral reefs.

i Snake-like eels?

In damp conditions, eels can move around dams and waterfalls by wriggling across land with a movement like snakes.

Tilapia

Tilapia were introduced into several Pacific Island countries from Africa beginning in the 1950s. As the species is easy to breed and eats low-cost foods, the fish was introduced for freshwater fish farming. Tilapia have been farmed in Fiji, Vanuatu, Papua New Guinea and the Cook Islands for many years.

However, the species of tilapia originally introduced to the Pacific was the slow-growing Mozambique tilapia (*Oreochromis mossambicus*) whereas 90% of the tilapia farmed globally today is Nile tilapia (*Oreochromis niloticus*).

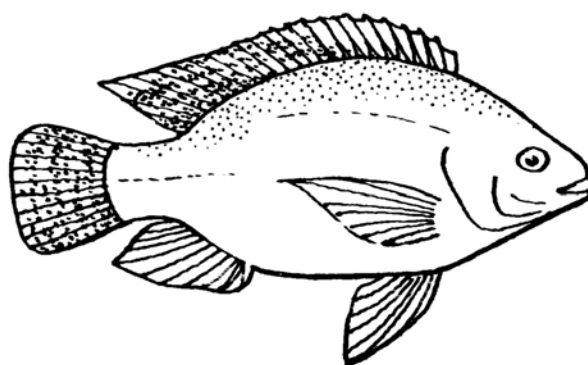

i Friend or foe?

The introduction of exotic* species is not without risk. On one hand, tilapia farming can provide food for local people. On the other hand, introduced tilapia may compete and displace indigenous* freshwater fish.



Many people around the world love to watch colourful fish swimming in a glass tank. And the most popular are those from tropical coral reefs. Many of these fish come from the Pacific Islands.



An aquarium is a tank, usually made of glass, in which people keep aquatic species.* A freshwater aquarium is easier to stock and maintain but a marine aquarium is usually much more spectacular, particularly if it contains colourful tropical species.

Where and what species?

The export of coral reef fish, hard and soft corals, giant clams, live rock and a number of reef invertebrates* (such as sea stars, crabs and shrimps) from Pacific Island countries and territories started in the 1970s. It has since expanded to become an important source of income and employment for a number of communities in the region.



Live rocks?

The rock itself is not alive but made up of the calcium carbonate skeletons of long dead corals. However, over time, this rock has been bored into by worms, sponges and bacteria and other marine species. It is considered useful in that it is porous and has a large surface area for bacteria to colonise. The bacteria improve water quality by using nitrogen waste.*

The trade currently operates from many countries including Fiji, Papua New Guinea, Solomon Islands, Vanuatu, New Caledonia, French Polynesia, Marshall Islands, Tonga, Cook Islands, Federated States of Micronesia, Kiribati and Palau.

According to data collected by SPC, the six most commonly exported species include the following in order of decreasing importance:

- southseas devil (*Chrysiptera taupou*) from Fiji;
- whitetail *Dascyllus* (*Dascyllus aruanus*) from Fiji;
- anemone clownfish (*Amphiprion percula*) from Solomon Islands;
- bicolour angelfish (*Centropyge bicolor*) from Fiji;
- twospined angelfish (*Centropyge bispinosus*) from Fiji;
- sapphire devil (*Chrysiptera cyanea*) from Solomon Islands.

In most countries the collection of marine species for export is a relatively small operation. However, the trade provides employment, mostly in rural communities and contributes to the earning of foreign exchange.



The majority of aquarium fish are caught on the reef slope in depths of less than 35 metres, with occasional specimens taken at depths in excess of 50 metres. The fish are generally caught one at a time by experimented divers using scuba and either a small meshed surround net or a hand-held scoop net.

The standard method of packing live aquarium fish for air freight involves placing the fish in a plastic bag or container with clean sea water. The bag is then inflated with pure oxygen and packed in strong styrofoam containers for transport.

The use of damaging collection techniques such as those based on the use of sodium cyanide, quinaldine and rotenone (all of which are fish anaesthetics) is generally banned both by the aquarium fish collectors and governments. The capture of some fish may involve the removal of selected branches of coral. But this damage is minimal and the branches can be re-planted to grow into another colony.

Management

Many Pacific Island countries have or are in the process of developing management plans to effectively develop, monitor and regulate the aquarium fish trade.

The industry is a non-damaging one as only a few selected species are harvested for export. And the most desirable species are small, brightly coloured fish that are generally not sought after for food by local fishers.

The aquarium keepers who buy the fish are often concerned about the possible impacts of taking large number of fish from coral reefs and may selectively source aquarium fish from well-managed operations and from countries with management plans. Some buyers are looking to stock their aquarium with fish that have been grown in aquaculture facilities.

At the moment SPC is working with industry to develop standard best practices that can be effectively and efficiently applied at the local scale by all. The standards are to achieve the following goals:

- the promotion of sustainable fishery* practices;
- the fostering of good fishing and handling practices prior to export; and
- the promotion of good packing practices at export.





Spoilage refers to food becoming unfit to eat. Like almost any other food, seafood must be handled and stored correctly to maintain its quality and to ensure it is safe to eat.

Seafood not handled correctly goes through changes due to the action of bacteria* and enzymes* that make it taste bad and eventually become dangerous to eat. The food is then said to have "gone off" or "gone bad".

Spoilage by bacteria

Bacteria are the usual cause of seafood spoiling. Surface slime, gills and the gut of a living fish contain millions of bacteria. After the fish is caught, the numbers of bacteria increase dramatically and can cause illness and food poisoning. Cooking will kill bacteria but may not degrade the toxins* that they have produced.



What is the only natural food that doesn't go bad?

Most food goes "bad" because of the growth of bacteria and fungi, neither of which can survive in honey. Why? Honey is a very concentrated solution of sugars which draws water out of cells such as those of bacteria by osmosis* — the bacteria therefore shrivel up and die. The ancient Egyptians used honey for dressing wounds and some doctors have started using it again to kill bacteria.*

Spoilage by enzymes

Enzymes are present in all living things and are important in promoting the building of tissues as well as digesting food. After a seafood species* is caught, enzymes continue to work and start to breakdown and soften the flesh.

Histamine poisoning* is one of the common types of non-bacterial fish poisoning. Histadine occurs naturally in many fish including tuna, mahi mahi, marlin and sardines. If the fish is not chilled immediately after capture and not kept at temperatures less than 16°C, histadine is converted to histamine.

Because histamine is not destroyed by heat, even cooked fish will cause reactions that are often severe. Symptoms include allergic responses, a metallic taste, nausea, vomiting, abdominal cramps, diarrhoea, facial flushing and dizziness. Taking antihistamines (found in many hay-fever tablets) will usually give relief.



What does a properly handled fish look and smell like?

Properly handled fish have eyes that are clear and bright, scales or skin that are shiny and red gills that smell seaweed fresh. When raw, the flesh is firm and does not separate easily; when cooked, the flesh does not have a honeycombed appearance.

Stages of spoilage

After being caught, a fish quickly dies and goes through three stages, sometimes known as the three stages of *rigor*.*

Stage 1: (immediately after death) The fish feels soft to the touch. Fish just caught is very fresh and has a pleasant, seaweedy and delicate taste. The fish flesh begins to be affected by the action of its own enzymes immediately after the fish is caught.



Stage 2: (several hours after death, depending on temperature) The fish becomes stiff to the touch. The action of enzymes continues and histamines develop in some types of fish. There are no bad smells but there is some loss of flavour in the flesh.



Stage 3: (a day or more after death) The fish becomes soft to the touch again. Bacteria and enzymes are more active in this stage. The build up of bacteria causes unpleasant smells and the flesh becomes either watery or tough and dry.

The times taken for fish to go through the above stages are highly dependent on temperature. After these stages the fish becomes rapidly spoiled and is likely to cause food poisoning if eaten.



Twice as nice on a bed of ice

After capture, a fish should be covered with a wet bag or palm leaf, or even better, kept on ice. Ideally, fish should be kept on ice from the moment they are caught. At low temperatures between -1°C and +4°C both the action of enzymes and bacteria are greatly reduced and the edible life of fish can be extended to more than a week.

Keep it clean

In addition to keeping fish on ice from the moment they are caught, cleanliness and hygiene are essential to ensure there is little build-up of harmful bacteria and other micro-organisms.

- Wash all fish baskets or containers;
- wash hands frequently while gutting, gilling and preparing seafood;
- wash all work surfaces and utensils used;
- wash fish fillets in clean drinkable water before putting back on ice.





Eating fish that hasn't been kept on ice can make you very sick! This is because of the build-up of enzymes* and bacteria* — see Teachers' Resource Sheet 12: Fish spoilage.

But there are other forms of fish poisoning that are not caused by poor handling and are not caused by bacteria. These include ciguatera* fish poisoning and what is broadly called shellfish* poisoning. These forms of poisoning are caused by harmful algal blooms — a dramatic increase in the numbers of very small plants (the phytoplankton)* that float in the sea.

Harmful Algal Blooms (HABs)

Populations of phytoplankton periodically go through massive increases in numbers. These increases are referred to as plankton* blooms and a few species* produce strong toxins.*

The main culprits are dinoflagellates,* small and very abundant members of the marine plankton; they consist of single cells with two whip-like threads or flagella, which they use to move through the water.

These blooms of toxic species (called Harmful Algal Blooms or HABs) are responsible for fish and shellfish poisoning in humans in many parts of the world.



Myths about recognising fish with ciguatera

One common belief is that toxic fish can be recognised by exposing a fillet of the fish to flies or ants — the flesh is regarded as poisonous if the flies avoid it. Another belief is that a toxic fish can be recognised by placing a silver coin on the flesh — if the coin turns black, the flesh is not safe to eat. Unfortunately these tests and many other widely trusted ones, do not work.

Ciguatera fish poisoning (CFP)

Ciguatera Fish Poisoning (CFP) is common across the tropical Pacific. CFP results from the consumption of fish that have accumulated toxins produced by several organisms including the bottom-living dinoflagellate, *Gambierdiscus toxicus*. The sequence of events leading to ciguatera is shown in the following figure.

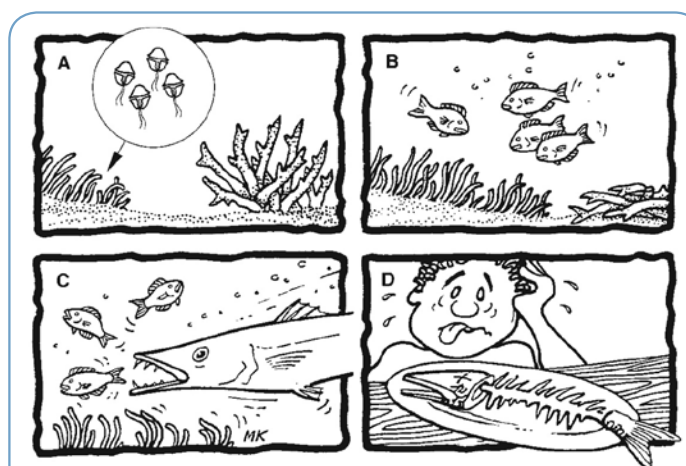

A cartoon used to raise community awareness of ciguatera in Pacific Island countries. The sequence of A) to D) is described in the text. From King M. 2007. Fisheries biology, assessment and management. UK: Wiley Blackwell. 400 p.

- A** The toxic dinoflagellates (shown greatly magnified in the circle) occur as a film on corals and seagrass. Their numbers increase dramatically when there are high levels of nutrients* in the sea — such as during the wet season when nutrients are washed from the land by rain and released from coral reefs damaged during cyclones. Sewage* and agricultural fertilisers entering coastal waters also add to the load of nutrients. Outbreaks of ciguatera have been associated with activities such as harbour dredging and the illegal use of explosives for fishing.
- B** Small grazing fish feed on the dinoflagellates and toxins build up in their flesh.
- C** Large predatory fish eat the smaller fish and the toxins become more concentrated in the flesh of the larger fish. By magnification up the food chain, the toxins reach dangerous levels in top carnivores such as some emperors, snappers, trevallies, barracudas, moray eels and large spanish mackerels.
- D** People eating these usually edible fish suffer from tingling, numbness, muscle pains and a curious reversal of temperature sensations (cold objects feel hot to touch). In extreme cases, death occurs through respiratory failure.

Unfortunately, the toxins cannot be destroyed by cooking or freezing. And in spite of widespread folklore on the subject, there is no reliable, cheap test to determine whether or not a particular fish is ciguatoxic before consumption.

Shellfish poisoning

Other harmful algal blooms cause several conditions collectively called shellfish poisoning. The poisoning is mainly caused by eating filter-feeding shellfish (such as clams, oysters and mussels) that sieve the toxic phytoplankton from the water. Each type of poisoning is caused by different species of toxic phytoplankton and is often named after the symptoms caused.

- The condition called paralytic shellfish poisoning may cause people to stagger about and have trouble talking.
- Neurotoxic shellfish poisoning affects nerves and may cause dizziness, fever and a reduced heart rate.
- Amnesic shellfish poisoning can result in confusion and amnesia (loss of memory).
- Diarrhetic shellfish poisoning is characterised by severe diarrhoea and vomiting.



Marine toxins in the air?

Some HABs toxins can become airborne (as toxic aerosols) because of wave action and cause people swimming and even just walking on the shoreline to suffer respiratory asthma-like symptoms from inhaling the airborne droplets.

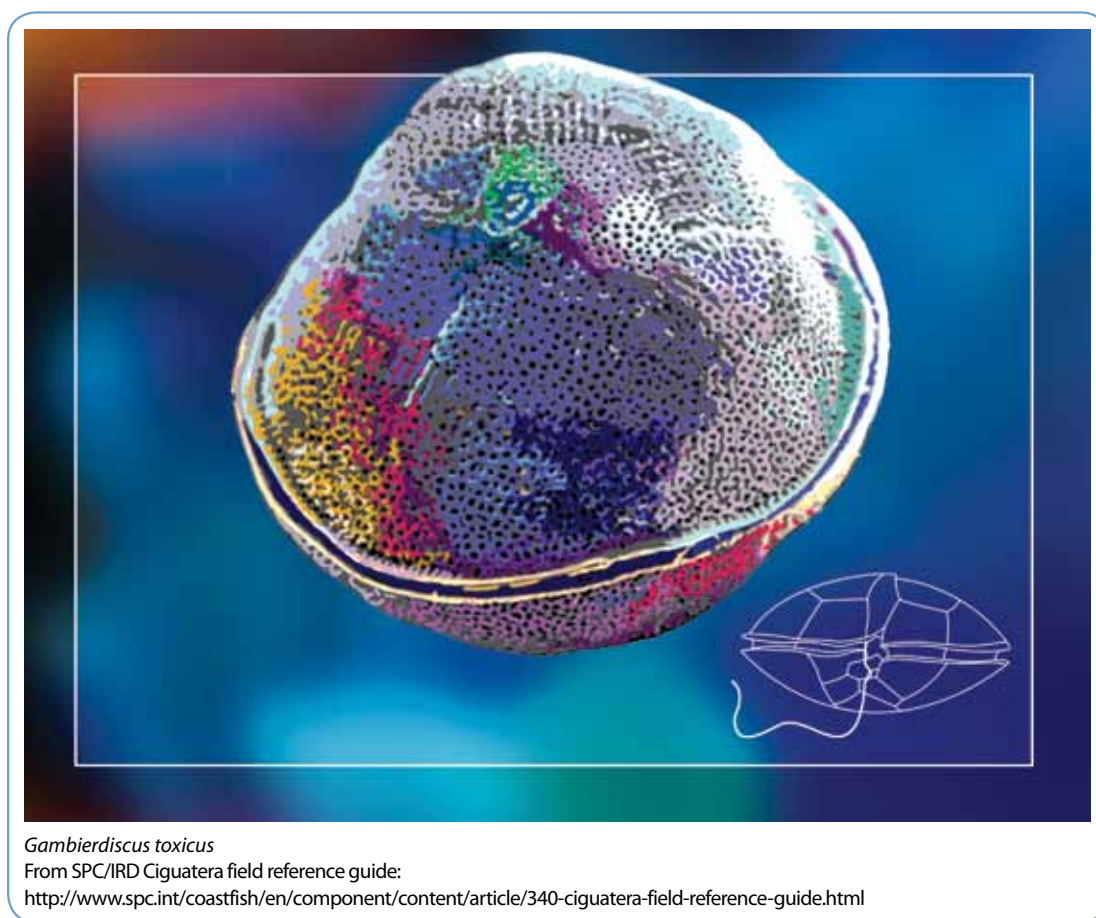



Want a job that is active and interesting? A job that helps to feed families and communities?

Then working in fisheries is for you.

A fishery* is not just about fish. Of course, the fish are most important but there are fishers who catch them, people who process and market the catch and fisheries managers who ensure that fish stocks remain healthy.

Fisheries work is exciting — it can involve inside and outside work depending on your preferences. Some people work at sea and some work in markets and some work on computers. But the work is always varied and interesting. The different types of jobs are discussed under the headings in the above figure.



Management

All fisheries resources need to be managed to ensure that fisheries remain sustainable — that is, they remain capable of providing food forever. Biological and economic data on the resource and the activities of fishers are collected by fisheries scientists, statisticians and economists. These professionals provide information on the status of fisheries resources and suggest policies for development and management.

Fisheries management jobs are available not only with government fisheries authorities but with non-governmental organisations (NGOs). Both of these often work with fishing communities which have much traditional knowledge of fish stocks and the environment.*

Jobs with fisheries authorities are often an exciting mixture of work in the field, the laboratory and the office and usually require university qualifications.

Fishing

Fishers are the people most directly involved in a fishery — both men and women who work on shorelines and at sea on vessels ranging from canoes to large tuna vessels. Any position of responsibility on a larger vessel requires sea-going qualifications.

In more technical fisheries, fishing gear technologists design and build fishing gear and experiment with new methods of catching fish. Some fishing operations, particularly those offshore, are dependent on boat builders providing sound fishing vessels. Trade qualifications are usually required to work with a boat builder.

Young fishers often learn their trade informally from older, more established, fishers. There are, however, training opportunities in many Pacific Island countries — skills in navigation and sea safety are also required. SPC is also involved in fishers training.

Processing

The catch landed by fishers is usually processed — which may range from the simple storage of fish on ice to the technologically more complicated procedures of freezing and canning. In some islands, many people are employed as unskilled or semi-skilled labour in tuna processors and canneries.

Seafood technologists, usually with university training in chemistry, biochemistry or bacteriology, ensure the quality of seafood and work on the development of new products. The development of value-added products, such as smoked fish, is one way of increasing the value of the catch.

Marketing

Marketing may refer to the sale of fish from a local market but, in the case of exported seafood, involves securing overseas sales and transporting the catch to foreign countries. Young people intending to work in this area may require qualifications in small business management and accounting.

Related activities

Other marine activities include aquaculture, sports fishing and ecotourism.

Aquaculture operations, including prawn, fish and pearl farms, require biologists, technicians, engineers and divers as well as marketing and sales specialists.

Tourism-related activities include working on charter fishing vessels, acting as fishing guides and being part of recreational dive and snorkel tour operations.

Training

Fisheries careers are varied and stimulating. They often involve practical skills, such as seamanship and diving, as well as intellectual skills, such as analysing data with computers; perhaps it is this mixture of active, open-air tasks and stimulating office or laboratory work, that makes fisheries work so interesting.

Some careers involve university study while others can be pursued after intensive practical training. Fisheries and marine environmental courses are available at the University of the South Pacific in Fiji and at universities in Hawaii, New Zealand and Australia.

Whichever career in fisheries is decided upon, the student can look forward to entering a life of stimulation and adventure, working with other qualified and highly-motivated individuals surveying, developing, managing and conserving marine resources for the benefit of current and future generations of Pacific Island people.





What are FADs? Fish aggregating devices (FADs) are drifting or anchored buoys or rafts that attract and aggregate pelagic* fish, making them easier to find and catch. Fishers have long known that fish congregate around naturally occurring floating logs or other debris including dead whales. This aggregating phenomenon is not completely understood and there are several theories to explain it. It is believed that floating objects offer a refuge from predators* and a meeting place for schooling companions (like THE tree in the Ténéré desert, in Africa, where every caravan stops even if there is nothing other than a tree — no water, no food and not even enough shade for all members of the caravan). Another theory posits that because floating objects host a variety of small marine animals, a food chain is established around it and it becomes a feeding place for large pelagic fish. Whatever the cause, knowledge about such aggregating behaviour led to the innovative idea of anchoring something similar to a floating log to attract the fish to a place that can be easily found by fishers.

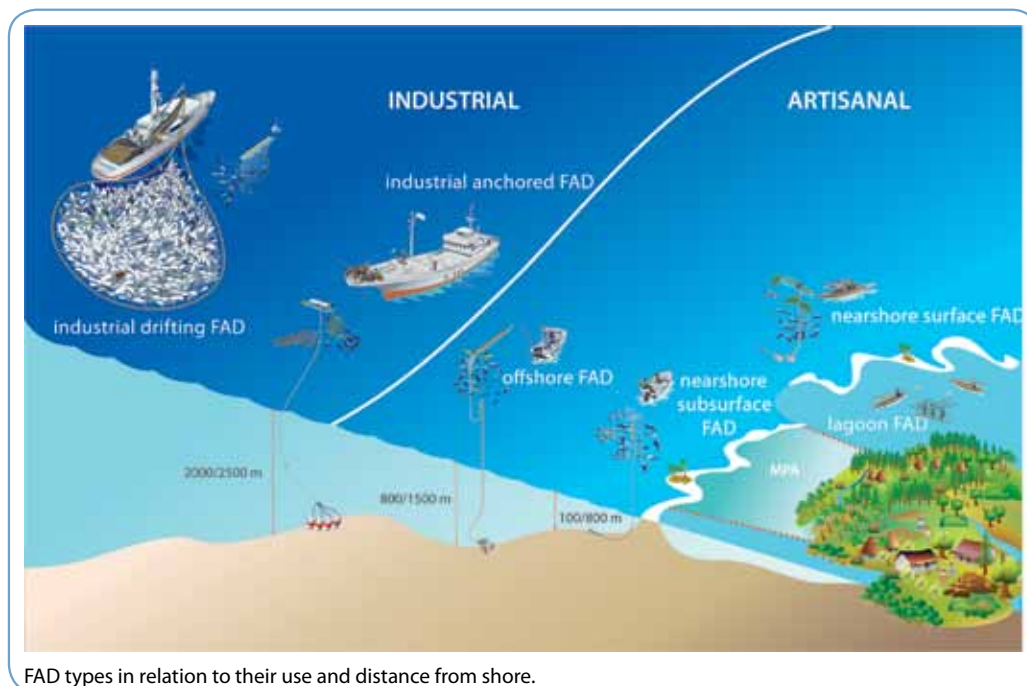

FAD types in relation to their use and distance from shore.

Types of FADs and their use

In coastal areas, local fishers or fisheries departments moor FADs on the sea bottom in depths of 50–2,500 metres in order to encourage tunas to gather not too far offshore, where small artisanal fishing vessels can catch them. Anchored FADs improve the catch rate of people who catch fish to feed their families or sell in small amounts at local markets, as well as people who fish as a hobby. They also allow fishing effort* to be moved away from lagoons and reef areas, where resources are both limited and fragile, towards the open ocean where tuna resources are not as sensitive at such scales. The upper part of these anchored FADs can be set under the sea surface (subsurface FADs) or it can float on the surface (surface FADs). When deployed within the reach of paddled canoes, the device is called a nearshore FAD and when moored further offshore, it is called an offshore FAD and its use is limited to motorised fishing boats. Low-cost FADs can also be moored inside lagoons (lagoon FADs) where they attract small pelagic and bottom fish species.*

In the open ocean, operators of tuna purse-seiners also exploit the tendency of large pelagic fish to aggregate around floating objects. They set their large nets around FADs that have been purposely set adrift and are monitored throughout the ocean by electronic tracking beacons. One purse-seine vessel can have up to 100 drifting

FADs (d-FADs) equipped in this way. These d-FADs are tools that may be considered to be “too efficient” but getting rid of them would strike a heavy blow to the world’s tuna canning industry. In fact, the volume of catches around these d-FADs (by all types of fishing combined) accounts for about 1.8 million tonnes, or 43%, of the 4.2 million tonnes for the three main tuna species worldwide. It has been suggested that purse-seine fishing around d-FADs is leading to catches of small, undersized (juvenile) tunas, unwanted bycatch such as mahi mahi and wahoo and endangered species such as sharks and sea turtles. The use of d-FADs in the Pacific needs to be regulated and monitored to avoid the overfishing of those species.



In 180 AD, the Greek poet Oppian of Corycus included, in his treatise on sea fishing “Halieutika”, a description of mahi-mahi fishing under the first recorded man-made fish aggregating devices. Those FADs were drifting devices made of bundled reeds and set adrift. Much later on, Southeast Asian countries constructed anchored FADs made of bamboo (called “payaos”), and these are still used today in support of industrial fisheries. With assistance from SPC, Pacific Island countries and territories started to use anchored FADs in the early 1980s.

i Artisanal fishers in the Pacific currently catch less than 5% of the tuna caught in the western and central Pacific Ocean and will need to harvest more in future for food security. Anchored FADs are important tools for domestic fisheries development as they can contribute to increasing the share of the tuna catch going to Pacific communities.

A FAD commonly used in the Pacific: the Indian Ocean FAD design

The FAD design illustrated here was first used at Reunion Island, in the Indian Ocean, in the early 1990s. SPC successfully introduced the design in the Pacific during the mid-1990s, with some refinements to the gear configuration. It is still widely used in the region as it is easy to deploy from relatively small boats and is cost-effective (USD 1,500 to 2,500 depending on the anchoring depth, for an average life-span of two years).

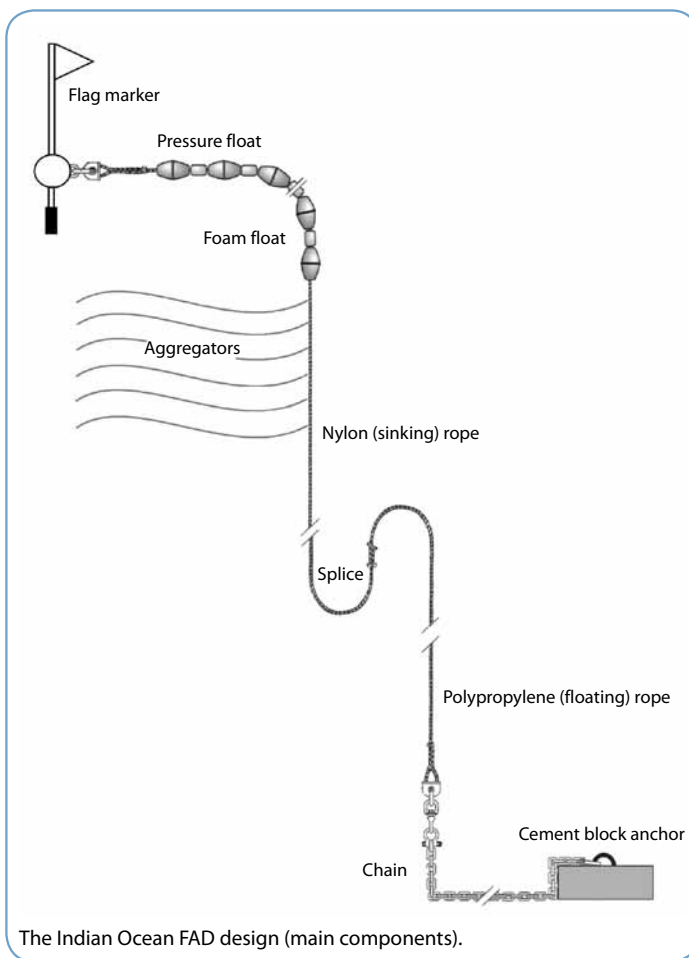

The Indian Ocean FAD design (main components).



Purse-seine catch.

Marc Taquet © FADIO/IRD-Ifremer



Artisanal fisherman displaying a yellowfin tuna caught at a nearshore FAD off Yaren, Nauru.

William Sokimi © SPC

i *A cause for concern: sabotage*
 One of the biggest constraints to successful FAD programmes in artisanal fisheries is vandalism, in which the upper section of a surface FAD is intentionally cut loose by fishers or other boat operators. Jealousy and ignorance are the main causes. To address this problem SPC is promoting the use of subsurface FADs.



Fishing methods used depend on the targeted species* and the area fished (reef flats, lagoons or open sea). Some of the methods described below are still used but some have been replaced by modern techniques and a change in fishing to a more individual and less community-based activity. Gleaning is still a common traditional fishing method and is described in the Guide to information sheets on fisheries management for communities.

1. Hook-and-line

In the Pacific, hook-and-line gear was traditionally made from natural materials (fibres, wood, bones and shells), but modern materials (nylon and steel) are now used.

Two types of hooks are used:

- "J" hook: fishers must jerk the hook when they feel a fish taking the bait;
- circle hooks: fishers let the fish hook itself (hooks are "self hooking").



Matira or Takiri

A line is cast into the water and the baited hook is either kept stationary or shaken. If a lure is used, it is made of shell, feather, metal or plastic. *Matira* is generally done at dawn or dusk.



Target: Small groupers, *ku* (squirrelfish) and *paoa*, *titiara* (trevally)

Tiritiri

A handline ending in a baited hook is thrown in the sea and the fisher waits until a fish bites.



Target: Predatory fish such as *titiara*, *urua* (trevally), *angamea* (snapper), emperors and groupers

// or drop stone fishing

A bait (mackerel scad, bigeye scad or flying fish) and a weight (usually a rock) are wrapped inside a leaf and tied with a slip knot. The package is lowered to the required depth (can be over 300 m) and then the line is jerked upwards. The movement opens the knot and frees the ground bait, also called "chum", around the baited hook.

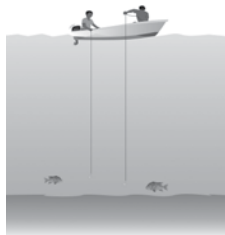

Target: Deep-sea fish (cods, snappers) and pelagic* fish (tuna, wahoo, marlins...)

Tavere or Taverereve ku on canoes

Lines (10 to 15 m long) rigged with three to five hooks are towed or trolled from canoes. *Uru tavake*, or shiny white-strand ropes (made of coconut fiber), are attached to the hooks as lures.

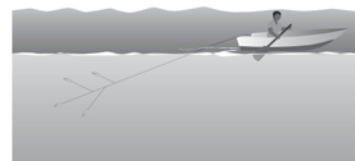

Target: Squirrelfish

Titomo

A small baited hook (using small pieces of fish sometimes mashed and mixed with ground coconut flesh) attached to a short length of line on a rod is used by a diver. Once the fish is hooked it is quickly flicked into a canoe.



Target: *Koperu* (mackerel scad) at dawn or dusk, or small *patuki* (groupers)

Matau tamoe

A thick line is tied to a tree and placed out over the reef. A hook, baited with a live eel, is placed somewhere suitable (such as in a patch of soft coral) to stop it from shifting about with the swell and currents.



Target: Large trevallies

Manga fishing

The gear consists of a monofilament line attached to a bent wire carrying two *tokos* (v-shaped piece of wood), each of them with a straightened steel hook attached to it. Baits consist of fillets of mackerel scad, flying fish or skipjack.

Target: Snake mackerel

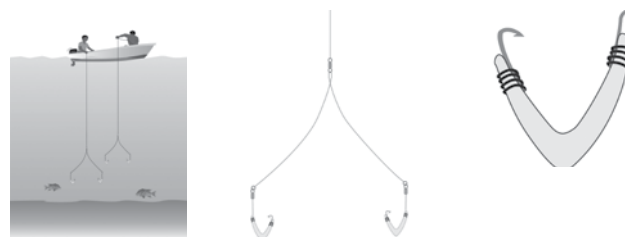

2. Nets

Pokipoki

A V-shaped hand net, made of wild hibiscus bark or coconut fiber, is dipped into the surge channel so that fish swimming past get entangled. The fish are then scooped up using hand nets.

Maroro fishing

At night, flying fish are attracted to a boat by a bright light and caught with a scoop net. Nowadays, fishers use speed boats and a torch attached to a helmet. In the old days, burning dried coconut fronds were used as torches by fishers paddling canoes.

Target: Flying fish or *maroro*



Rau (leaf sweep) fishing

Coconut fronds are tied together to form a "wall" to surround fish schools.* A large number of fishers are involved in this method; some hold the *rau* while others beat the surface of the water with sticks to frighten the fish towards the *rau*. This technique is less and less used due to a shift: 1) towards the use of gill nets and 2) from community to individual fishing methods. The traditional method, involving many people walking on the reef, could cause considerable damage to corals.

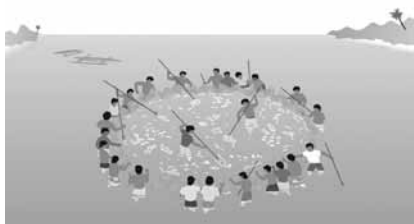

3. Spear fishing

Pata spearing

The gear consists of a Y-shaped piece of wood and rubber bands and a metallic spear. Teenage boys use *pata* to learn how to spear fish; nowadays, this method is, unfortunately, also used at night time, with an underwater torch to catch fish sleeping under corals.

Target: *Morava* (rabbitfish), parrotfish, trevally, drummerfish, surgeonfish, goatfish, mullet, snapper, emperor, squirrelfish, lobsters (occasionally at night)

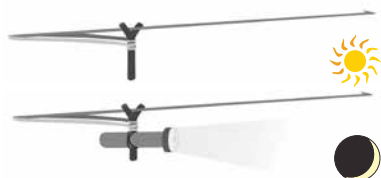

4. Traps

Pa

Stones are piled high and form a wall, which at falling tide intercepts the school and guides it towards a v-shaped apex from which the fish cannot escape.

Target: various types of fish



Inaki

Inaki is a method used to trap freshwater eels. Bait is placed in a plaited basket designed to allow eels to enter the trap but not to exit.

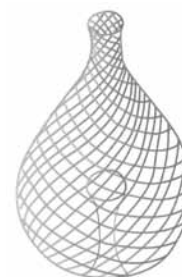

5. Poisoning

Utua or Ora papua fishing

The fruit of the *utu* (*Barringtonia* tree) *Barringtonia asiatica* and the roots of the vine *Derris* sp., *ora papua* were once used to poison fish in coral and enclosed areas. This practice has been banned because it did not only kill the target fish, but also other fish, shellfish,* coral and particularly larvae* in the area.

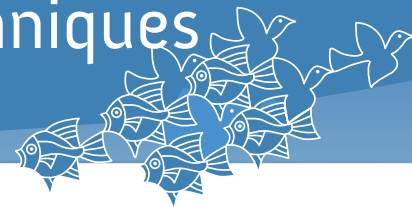

In the Pacific Islands region, large-scale, or industrial, fishing techniques are almost exclusively used to catch tuna and associated species. The only exception is the shrimp trawl net fishery* of Papua New Guinea. The main techniques used to catch tuna are: purse seine, longline, pole-and-line and troll.*

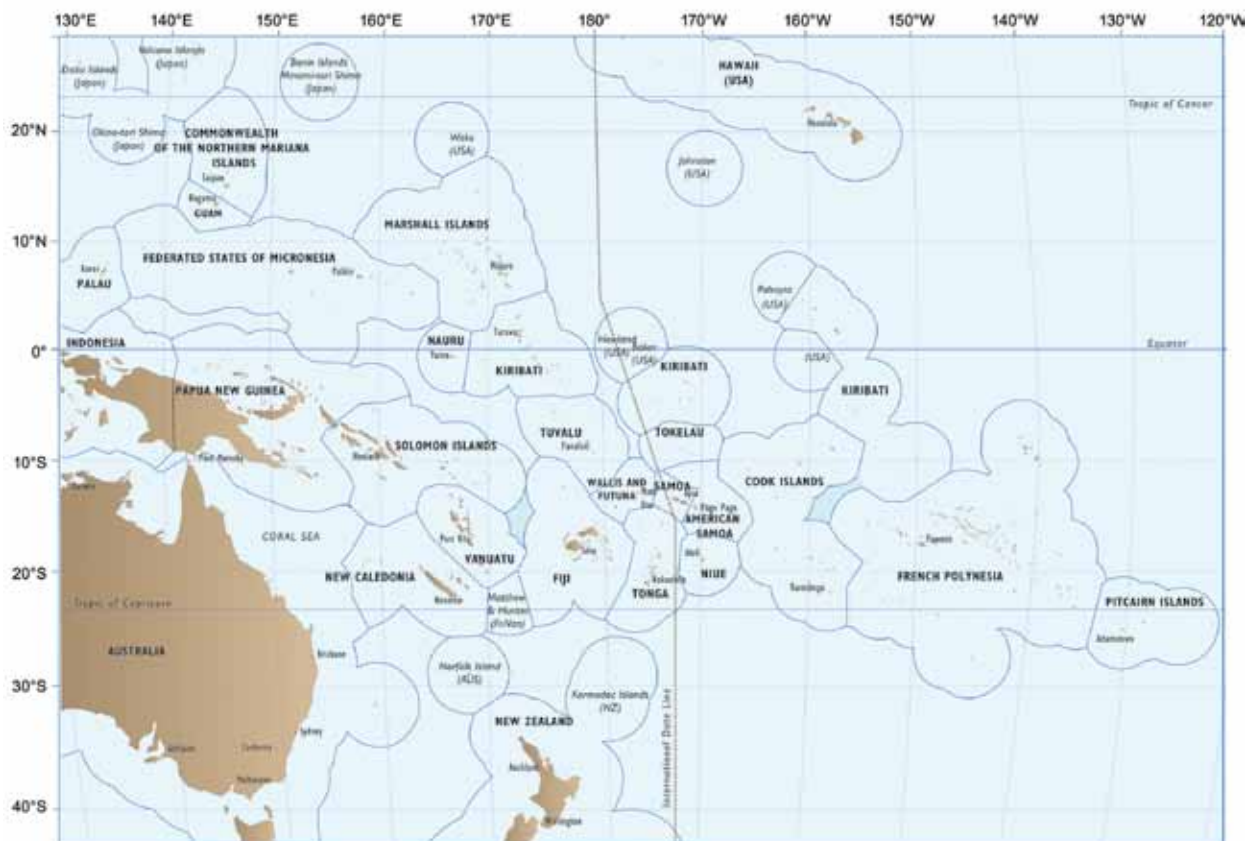

Purse seine

A school* of tuna is spotted while it feeds on schools of baitfish close to the surface. Most of the time, seabirds have also been attracted and dive to feed on the baitfish, making the spotting easier. A huge vertical net (seine) — which can measure up to 1,500–2,000 m long by 120–250 m deep — is quickly set around the school of tuna, and then closed at the bottom to form a purse in which up to 150 tonnes of tuna can be caught at one time.

Target: Mainly skipjack and small yellowfin tuna. Most of the catch is for canning and thus ends up in tuna cans one can find in stores all over the world.

About 65% of the tuna catch in the western and central Pacific Ocean (WCPO) region is caught with purse-seine gear — about 1.5 million tonnes in 2011. Most of the purse-seine catch is taken within 5 degrees of the equator.

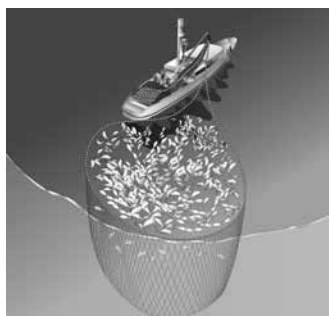

Longline

A long line, called the mainline, with baited hooks attached at intervals by means of branchlines, is set and allowed to drift for several hours. Large tuna longliners can set up to 3,000 hooks on one line that can measure more than 100 nautical miles. The hooks of a longline are set deep (between 80 and 400+ m), so the fishers cannot see the targeted fish. The choice of the location for a set is therefore made by experience, according to sea surface currents and temperature, season, weather, etc.

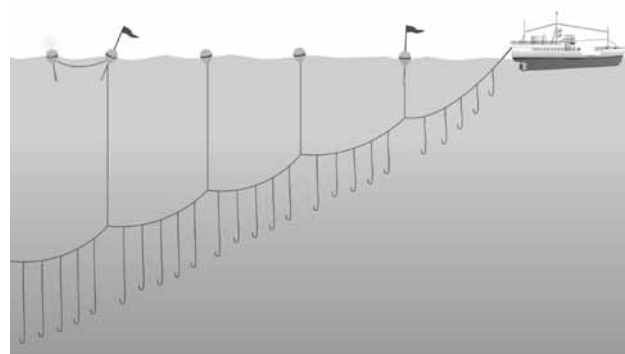

There are two major types of longliners: (1) relatively large (>30 m) vessels that use sophisticated freezing equipment and are often based outside the Pacific Islands, and (2) smaller vessels that use ice or refrigerated sea water to preserve fish and are typically based at a port in the Pacific Islands.

Target: Large yellowfin, bigeye and albacore tunas. The prime-quality yellowfin and bigeyes are often exported chilled to overseas markets for sashimi. Most of the albacore caught by longliners end up in cans.

About 11% of the tuna catch in the WCPO region caught with longline gear — about 265,000 tonnes in 2011. Most of the longline catch is taken within 20 degrees of the equator.

Pole-and-line

As with purse seining, a school of tuna is spotted while it feeds on baitfish close to the surface. The pole-and-line boat is brought close to the school of tuna and left drifting while fishers throw small live bait and spray water to mimic the splashing of the school of bait. The idea is to trigger a feeding frenzy in the school of tuna. Fishers stand on the front deck and haul fish with a pole attached to a line ending with a lure and a barbless hook*.

Target: Mainly skipjack and small yellowfin tunas. Most of the catch is for canning or to make a dried product (called *katsuobushi* in Japan) sold to Asian markets.

About 12% of the tuna catch in the WCPO region is by pole-and-line gear — about 275,000 tonnes in 2011. In the 1980s, several Pacific Island countries had pole-and-line fleets, but most have stopped operating due to competition with the more productive purse-seine gear. In the Pacific now, most of the pole-and-line fishing takes place around Japan, and a few boats are still operating in Solomon Islands.

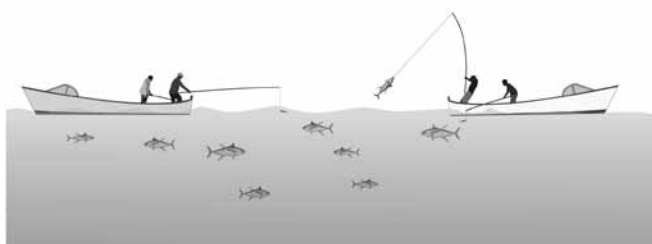

Note:

Several small-scale fishing methods and gear types are described in the 'Guide to information sheets on fisheries management for communities', including reef gleaning; spears; portable traps; barrier and fence traps; baited hooks and lines; lures for trolling; as well as cast nets, scoop nets, gill nets, seine nets and ring nets.

Troll

Several lines are trolled behind the boat with lures at the end.

Target: Large-scale tuna trolling boats target albacore for canning.

Gear types other than the three listed above are responsible for about 13% of tuna catch in the WCPO. Large-scale trolling is one of these. It is carried out in temperate waters to the south and north of the tropical Pacific Ocean (mostly south of 25°S and north of 25°N). Trolling in the south results in a catch of about 3,200 tonnes of albacore annually, which is almost exclusively sent to canneries.

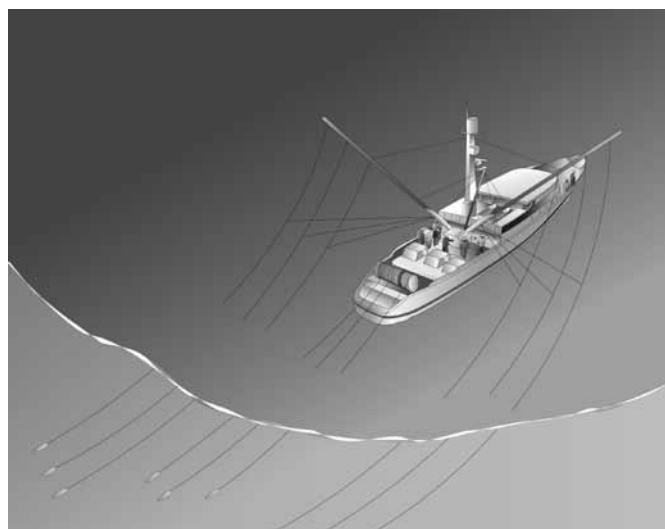

Bottom trawl

A very powerful boat drags a trawl net along the bottom of the sea. The trawling can last from a few minutes to a few hours before the trawl net is hauled and emptied on the deck of the boat where the catch is sorted. Because of its lack of selectivity*, this technique harvests a large proportion of bycatch (unwanted species which are caught and thrown back dead into the sea — for example, up to 90% of catch in the shrimp fishery can be bycatch). It is mostly used in places where the seafloor is all sand or mud. It must not be used in coral reef areas as 1) it would destroy the corals and 2) the trawl net would be damaged by the coral heads.

Target: All type of species that live close to the seafloor, such as shrimps and flatfish.

In the Pacific Islands, this technique is only used in the south of Papua New Guinea to catch shrimps.

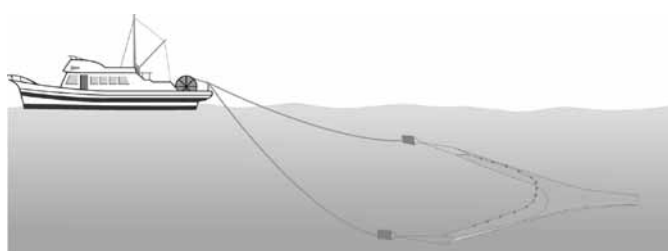



Fishing is considered to be the world's most dangerous occupation — estimated in 1999 by the International Labour Organization (ILO) to cause more than 24,000 deaths per year. Although Pacific Island countries have some of the highest sea accident rates in the world, most government fisheries agencies have limited involvement with safety issues. Data are insufficient to statistically demonstrate which activities are particularly risky, but there is a general perception that offshore trolling for tuna in small outboard-powered skiffs is responsible for many, if not most, of accidents at sea.



Michel Blanc © SPC

A typical trolling skiff from Tarawa in Kiribati, a country with one of highest sea accident rates in the Pacific.

What is sea safety?

Sea safety or boat safety means the ability of a vessel to return to port (or more usually the island or village) at the completion of a voyage or trip. A sea safety accident is an event that may lead to a vessel not returning to port.

The cost of small boat accidents at sea

In addition to the emotional cost experienced by families and friends as a result of accidents on small boats, regional organisations have tried to analyse the financial cost of sea safety accidents and in particular, the cost of search and rescue (SAR) operations. With 22 island states and territories covering more than 25 million square kilometres of ocean and more than 50,000 small fishing vessels working the nearshore waters of these islands, the exact number of accidents occurring each year is impossible to calculate. What is known, however, are the hourly costs of patrol boats, helicopters and planes that are deployed to undertake SAR. Based on this available information and a case study undertaken for New Caledonia, SPC has estimated that the cost of SAR operations to the region is between 5 and 8 million US dollars per annum. Whatever the exact amount, one thing is for sure, it is a cost the Pacific Islands could well do without!

The causes of sea accidents

Various studies have highlighted the importance of human errors in sea accidents. Despite the scarce data available, we know that most sea accidents in Pacific Islands are linked to mechanical breakdowns (lack of knowledge in outboard motor maintenance and trouble-shooting), losing sight of the island — particularly in atoll countries (lack of navigation skills), running out of petrol (negligence) and bad weather (unsuitable boat design and no pre-departure check of the weather forecast). Overloading of vessels and subsequent capsizing is also a common feature of Pacific Islands' small boat safety.



© NFA

Overloading of a small transport vessel in Papua New Guinea.

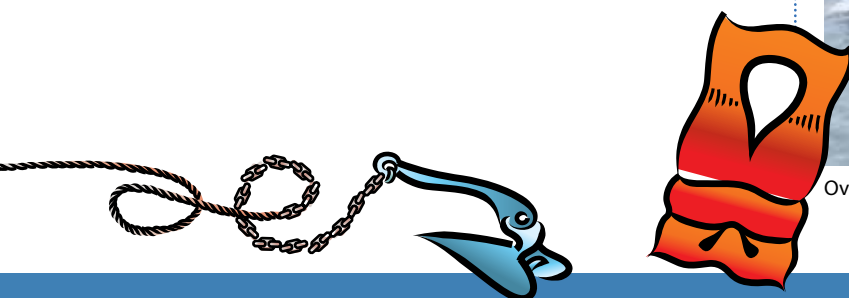

This resource sheet is one of a series produced by the Secretariat of the Pacific Community (SPC) to assist teachers in introducing fisheries topics into school curricula.

Each sheet should be used in conjunction with the *Guide to Teachers' Resource Sheets*, which contains suggestions for student activities and exercises. All words marked with an asterisk (*) are defined in a glossary in this guide.



A world record of survival at sea?

On 18 November 1991, three I-Kiribati fishers left their village on Nikunau for an ordinary fishing trip. Two of them made land again on 11 May 1992... almost six months later, in Samoa! They had survived on rain water and the sharks they could lasso while drifting. This is the longest known drift in the Pacific and possibly in the world. Those two survivors were treated as heroes upon returning home, although the cause of their sea odyssey was pure negligence: they ran out of petrol while fishing. The result was one death and thousands of dollars spent to no avail in searching for their tiny fishing vessel.



A worrisome fact

Most countries in the Pacific do not keep good records of small boat accidents at sea, making it impossible to analyse the extent of the problem and design tailor-made individual responses for countries. The collection and ongoing analysis of data on sea accident should be the first step in the establishment of any national small boat safety programme.

The importance of being prepared

Small boat users, particularly fishers, lack a culture of sea safety. To help change that situation, SPC has released a number of small boat safety awareness materials including two checklists (included in this information package): "Five minutes which can save your life" and a recommended list of safety equipment for small boats. Of particular importance are the things to do before going out to sea:

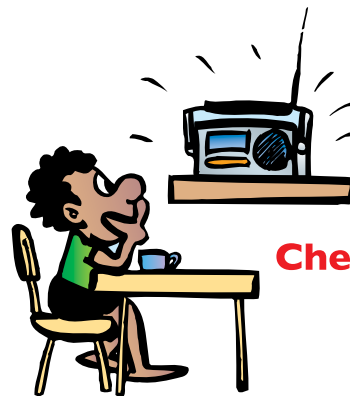

Check the weather forecast



Tell someone who cares where you are going and when you plan to return

Make sure your engine is working well

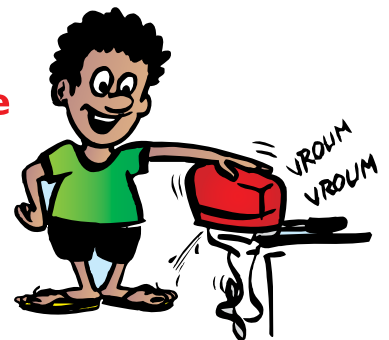

Make sure all safety equipment is on board





What is a fishing business? A fishing business involves capturing fish and marine products with the primary objective of selling them to generate income. Fishing businesses in the Pacific sell many different products¹ in many different forms and in many different markets.² Some markets include selling direct at local fish markets; or selling to restaurants, wholesalers, retailers and processors; or to buyers in international markets (export markets).

Types of fishing businesses

There are two general categories of fishing businesses: commercial and semi-commercial.

Commercial fishing* businesses operate to profit from the sale of fish and other marine products. These enterprises range from small, family-run businesses to large companies that employ staff to help to operate the business.

Semi-commercial fishing businesses are typically informal businesses that usually include fishing for food and income. These businesses are small and are run by a single person or household.

Products sold by a fishing business

Some of the products that are sold by fishing businesses and the form that they're sold are listed in the table below.

Typical products that are sold by small fishing businesses in the Pacific.

Product	Example	Form
Fish	Tuna, wahoo, mahi mahi, grouper, snapper, parrot fish, sardines, mackerel	Fresh (chilled), frozen, whole, filleted, gilled and gutted, cooked, canned, live
Invertebrates*	Prawns, shrimp, sea cucumber, lobster (crayfish), crabs, sponges, trochus	Fresh (chilled), frozen, whole, cooked, shelled, meat, canned
Ornamentals	Angelfish, clownfish, damsels, giant clams, corals, starfish, live rock	Usually live
Seaweed	All types of macroscopic, multicellular and benthic marine algae	Live, dried, chipped, sheets, hydrocolloids
Leisure	Game fishing, fly fishing,* spear fishing	Fishing activities that people participate in for recreation and entertainment

Management of a fishing business

Managers of a fishing business ensure that the business remains viable. A manager of a fishing business is responsible for ensuring that the product being sold meets customer expectations, for ensuring that income is generated and for managing business finances,³ sometimes with the assistance of an accountant.

Financial management of a fishing business

Costs are usually incurred in the process of generating income. Financial management of a business largely involves ensuring that the income received is more than the costs incurred (income is greater than costs), or maximising income while minimising costs.

¹ A product is a good or service that a business sells to generate income.

² The market is the person or business that buys fish and marine products from the fishing business.

³ Finances refer to the money that a business has, receives and pays.

What is income?

Income refers to the money that a fishing business receives for the sale of its goods and services.

$$\text{Income per trip} = \text{Price} \times \text{Quantity}$$

For example, if a fishing business catches 10 yellowfin tuna, each weighing 10 kg, then the total catch (or quantity) is 100 kg of tuna. If the tuna are sold for \$10 per kg, then the income for that fishing trip is \$1,000 (i.e. \$10 × 100 kg = \$1,000).

Annual income is the sum of the income generated from every fishing trip undertaken over a year.

$$\text{Total income} = \text{Income}_1 + \text{Income}_2 + \text{Income}_3 + \dots + \text{Income}_n$$

For example, using the above income per trip of \$1,000 and if we assume that we do 100 fishing trips per year and always catch the same amount of fish, we can calculate total income as \$1,000 × 100 trips = \$100,000. The income per trip is not always the same because the catch changes each trip, which is why we need to add income from all trips individually.

What are the costs of fishing?

As with any business, there are costs incurred when generating income. We broadly define these costs as operating costs and fixed costs.

Operating costs are incurred when going on a fishing trip and can include items such as: fuel, bait, ice, gear, crew payments (labour), rations, etc.

Fixed costs (or overheads) are incurred by the business whether or not fishing occurs. That is, fixed costs are the costs that the business has to pay regardless of the number of fishing trips that are completed. Fixed costs can include items such as fishing licence, bank loan repayments, annual vessel maintenance, insurance and depreciation. For example, the cost of a fishing licence is the same whether a business does 10 or 100 fishing trips each year — the cost is fixed.

$$\text{Total cost} = \text{Total operating costs} + \text{Total fixed costs}$$

For example, if a fishing business does 100 fishing trips each year and each fishing trip costs \$500, then our total annual operating cost is \$50,000 (i.e. 100 × \$500 = \$50,000). To operate as a fishing business, the business has to buy a fishing licence (\$1,000), make loan repayments (\$5,000) and pay boat maintenance (\$5,000), so the total annual fixed cost is \$11,000 (i.e. \$1,000 + \$5,000 + \$5,000 = \$11,000). Putting these together, we calculate our total annual cost to be \$61,000 (i.e. \$50,000 + \$11,000 = \$61,000).

What is profit?

Profit is the money that is left over after total costs are deducted from income over a given period. **For businesses to be viable over the long-run, they must be profitable.** If a business is not profitable, then the business spends more money than it makes. Businesses need money (profit) to operate.

$$\text{Profit} = \text{Total income} - \text{Total costs}$$

For example, using the total income and total cost figures from above, we can calculate profit, as follows:

Profit and loss analysis

Total income (A)	\$100,000	
Total cost (B)	\$61,000	
Profit (C)	\$39,000	$C = A - B$

In this example, profit = \$39,000, which means that after total costs (operating and fixed) are deducted from total income, we have \$39,000 left — this business made a profit for the year.

We can expand the above table to represent a profit and loss statement, as follows:

Detailed profit and loss statement

Total income	Price × Quantity = \$10 × (100 kg per trip × 100 trips) = \$100,000
Operating costs	Cost per trip × number of trips = \$500 × 100 = \$50,000
Fixed costs	Sum of all fixed costs = \$1,000 + \$5,000 + \$5,000 = \$11,000
Total costs	Operating costs + fixed costs = \$50,000 + \$11,000 = \$61,000
Profit	Total income - total costs = \$100,000 - \$61,000 = \$39,000

Other fields to consider in financial management



Profit is one key component of financial management. However there are many other areas of importance beyond the scope of this sheet. They surround investment expense (e.g. purchase of boat, motor, ice box), managing assets and liabilities (or creditors and debtors, such as banks and customers to whom credit is extended), cashflow, financial reporting, budgeting and decision making.





Anyone who fishes will tell you that you don't catch the same number or type of fish every time you go fishing! Catch is influenced by the bait you use, where you fish and the tide. It also depends on whether you fish during the day or at night, the prevailing weather conditions and, importantly, the time of year.

In recent years, scientists have identified another reason why the catches of some fish species* change — climate. They have recorded strong relationships between the El Niño-Southern Oscillation (ENSO) and tuna catch. When the southeast trade winds blow more strongly than usual (La Niña conditions), they push the area of warm water in the western Pacific (the Warm Pool) up against Papua New Guinea (Fig. 1). But when the trade winds are weaker than usual (El Niño conditions), the Warm Pool extends far to the east. Changes in the Warm Pool driven by the trade winds affect the catch of skipjack tuna because this valuable species is caught in greatest numbers near the eastern edge of the Warm Pool and the location of this edge can vary in by 3,000 to 4,000 km depending on the strength of an El Niño or La Niña.

The dramatic effect of ENSO on skipjack tuna demonstrates just how profound the effects of climate on fish can be. Based on these observations, there is every reason to expect that global warming, caused by higher concentrations of carbon dioxide (CO₂) and other greenhouse gases in the atmosphere, will also affect other fish species.

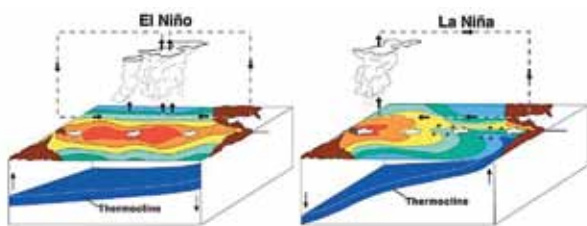

Figure 1. Effects of El Niño and La Niña conditions on the Pacific Ocean (source: SPC).

In considering this, we need to think about two different categories of fish — coastal fish and oceanic fish. Most coastal fish in the tropical Pacific are associated with coral reef habitats (Fig. 2), whereas most oceanic fish are caught offshore (Fig. 3). Most of the oceanic fish we catch are large, highly mobile species like yellowfin, bigeye, skipjack and albacore tuna, but also marlin, wahoo and mahi mahi. These species range widely across the region and are caught as they pass through the exclusive economic zones (EEZs) of Pacific Island countries and territories (the area within 200 nautical miles of the islands).

Coastal fish

The rising sea surface temperature is expected to alter the times of year when coral reef fish spawn and the food available to juvenile coral reef fish during the first few weeks or months of the planktonic (floating) phase of their lives far from shore. Survival during this phase affects how many juvenile fish are available to “settle” back on coral reefs and replenish the fish stocks there. However, climate change is expected to have its greatest effect on coastal fish by altering the coral reefs themselves. As the ocean warms, corals will bleach more frequently — bleaching occurs when warm water stresses corals and they expel the tiny plants (zooxanthellae) within their tissues that provide them with organic compounds (food) by photosynthesis.*

The build-up of CO₂ in the atmosphere also has another negative effect on coral reefs. The CO₂ dissolves in seawater, making the ocean more acidic and reducing the calcium carbonate available to corals to build their skeletons.

The increased coral bleaching and ocean acidification, will progressively degrade coral reefs — they will lose their complex structure and provide fewer places for the fish and prey for fish, to live. Decreases in coastal fish production will follow because not all coral reef fish will be able to adapt to the loss of the shelter and food they need. By 2035, climate change is expected to reduce that catch of coastal fish by 2%–5%, increasing to 20% by 2050.

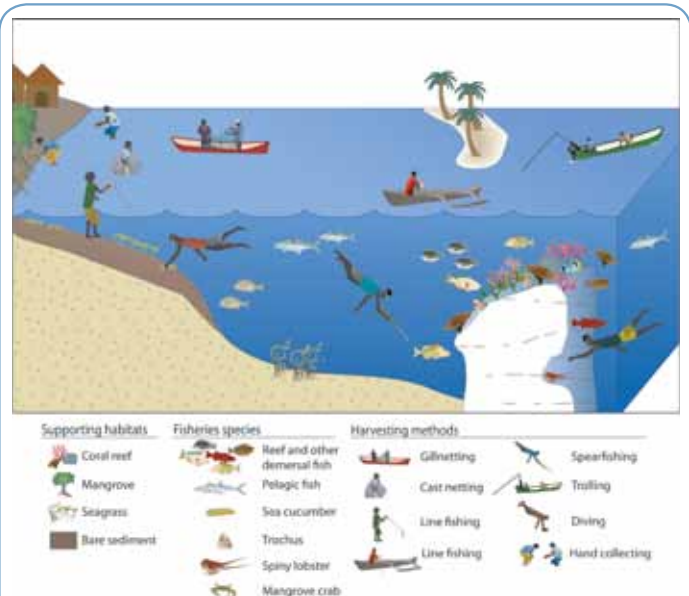

Figure 2. Range of coastal fishing activities in Pacific Islands (source: SPC).



This resource sheet is one of a series produced by the Secretariat of the Pacific Community (SPC) to assist teachers in introducing fisheries topics into school curricula.

Each sheet should be used in conjunction with the Guide to Teachers' Resource Sheets, which contains suggestions for student activities and exercises. All words marked with an asterisk (*) are defined in a glossary in this guide.

Oceanic fisheries

Unlike the effects of climate change on coastal fisheries, some Pacific Island countries and territories may benefit from increased catches of some important oceanic fish as the ocean warms. The reason for this is that there will be a steady increase in the overall size of the Warm Pool — it will extend further to the east under normal conditions. Over time, the distribution of tuna will be more like that observed during strong present-day El Niño conditions.

Pacific Island countries and territories further to the east are likely to receive more requests from purse-seine fishing vessels owned by distant water fishing nations (DWFNs) to fish for skipjack tuna in their EEZs because this fish could well be found in greater abundance there. Increased fishing by DWFNs will add to the revenue the government receives from fishing licence fees. Skipjack tuna could eventually be caught in higher numbers a bit further away from the equator than it does at the moment as sea surface temperature increases to be within the range preferred by this species.

Scientists are still in the process of determining the most likely effects of climate change on the other species of tuna.



Interesting fact

Although the body temperature of most fish is the same as the temperature of the water in which they swim, the body temperature of tuna is warmer than the surrounding water. Tuna have a countercurrent heat exchanger that enables them to retain body heat generated as a by-product of metabolism. http://en.wikipedia.org/wiki/Countercurrent_exchange_system

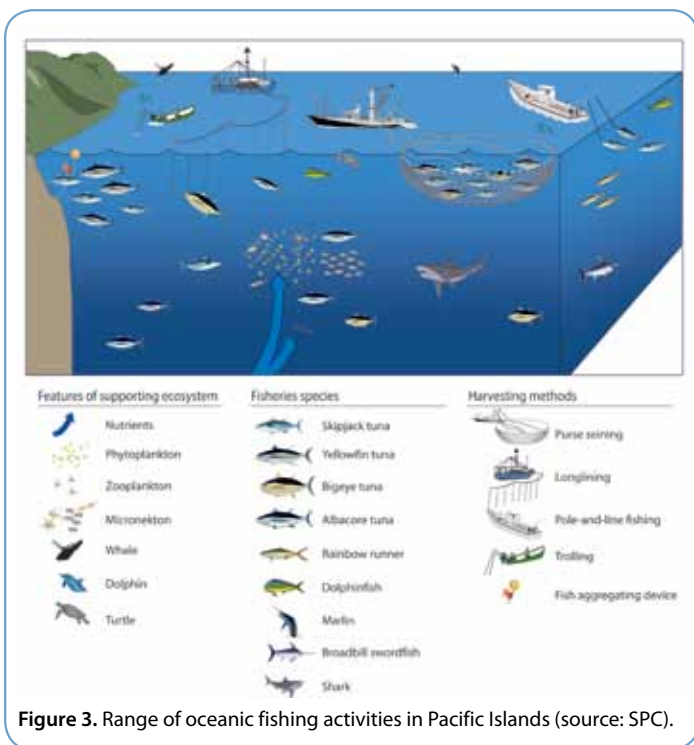
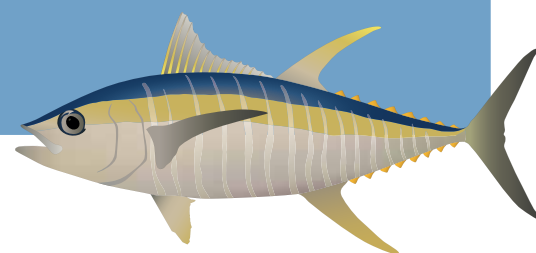

Figure 3. Range of oceanic fishing activities in Pacific Islands (source: SPC).

