



**MANUAL**  
OPERATION



**HOTEL**  
TRACK

## **FOREST CS**<sup>®</sup> *Contract System*

Heavy duty hand drawn curtain track system for medium and heavy draperies.

THE WORLD  
BEHIND  
YOUR  
CURTAINS



# FOREST CS®



## PRODUCT INFORMATION

- Heavy duty hand drawn system for medium and heavy draperies.
- Bendable; it can be curved and reversed curved using a 20 cm (8") radius or continuous curve.
- Heavy duty clickable carriers - 10 carriers on a breakaway strip - UV protected. Can also be used with ball bearing carriers.
- Ideal for use with overlap masters and batons which can be mounted behind or in front of draperies.
- Can also be used for the Forest Wave System (FES) and accordiafold drapery systems.
- Maximum fabric weight: 15 kg per mtr (11,25 LBS per ft).
- Colours available: white, black, silver and brown.
- Track finish: chromated powder coating with a factory applied patented dry lubricant.
- Available lengths: 3.66 m (12'), 4.27 m (14'), 4.88 m (16'), 6.10 m (20')
- Limited lifetime warranty.

- ① CS Track
- ② Carrier
- ③ Master Carrier R/L Overlap
- ④ Master Carrier R/L Underlap
- ⑤ Carrier
- ⑥ Endcap with screw

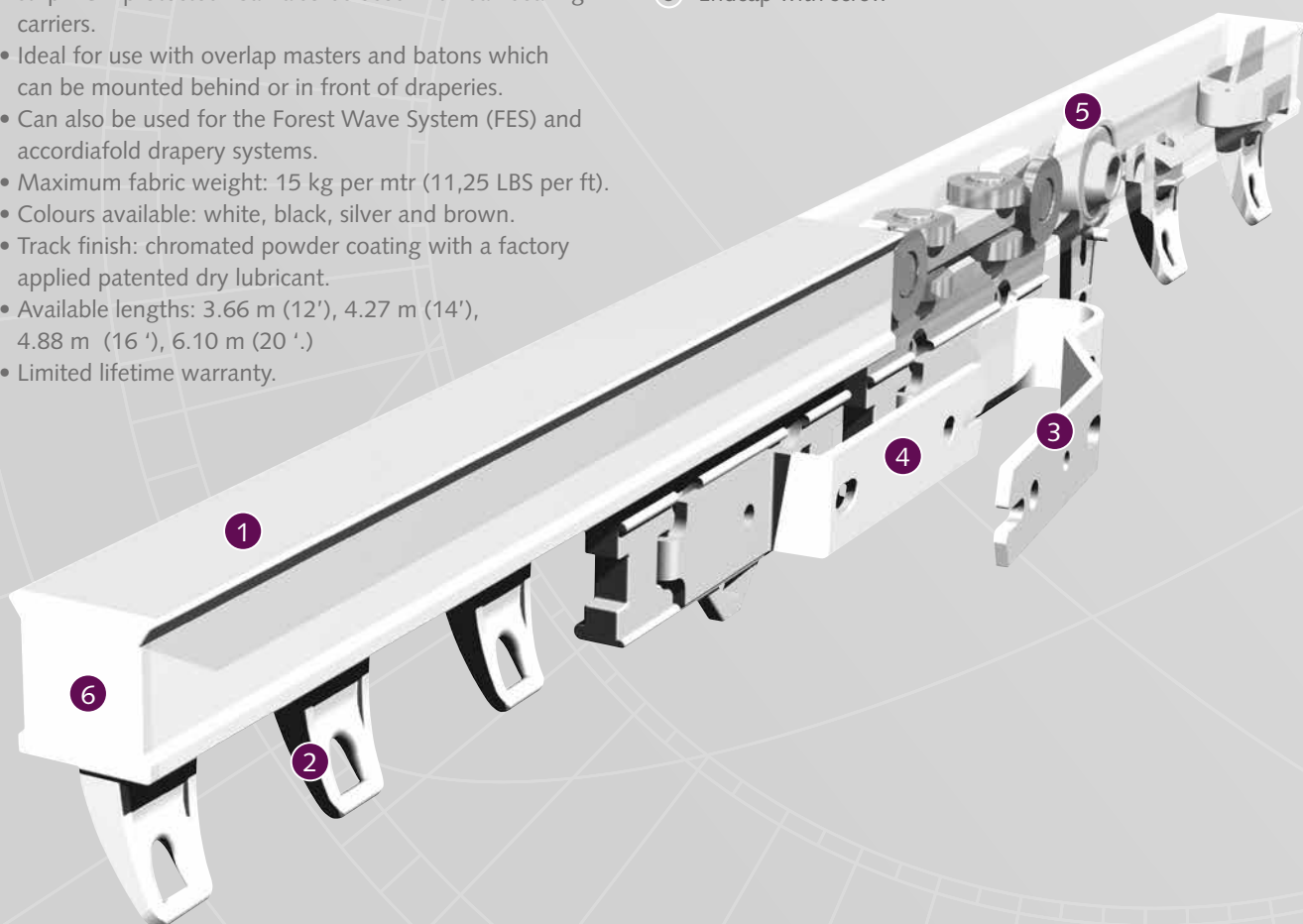



## PROFILE

- Weight: 235 gram p. mtr (2.53 ounce - ft).
- Aluminium Extrusion
- Dimensions: 20 mm x 20 mm (0,8" x 0,8")

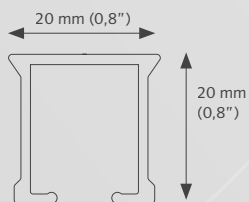

## FOR USE IN

Hotels - Motels - offices - schools - healthcare residential or at any location where a heavy duty hand drawn system is required.

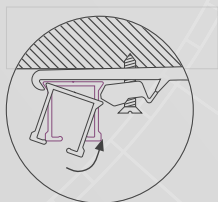

Easy installation  
click - position - tighten



clickable carrier

## BENDING / CURVING

The track can be curved and reversed curved using a 20 cm (8") radius. Continuous curving is also possible with the electrical bending tool.



## APPLICATIONS

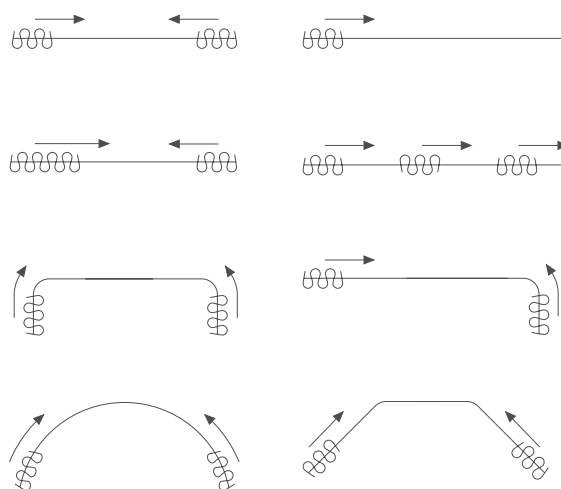

## CLICK-ON STIFFNER

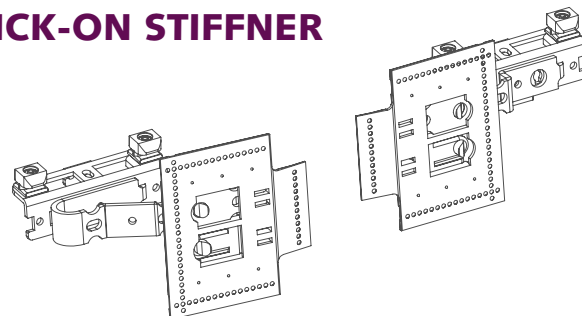

## MOUNTING BRACKETS

### Smart Klick Ceiling bracket

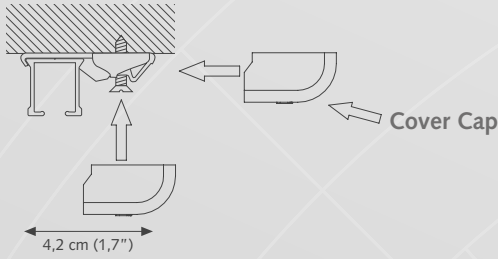

A) Min. 20 cm (8")



A) Min. 20 cm (8")

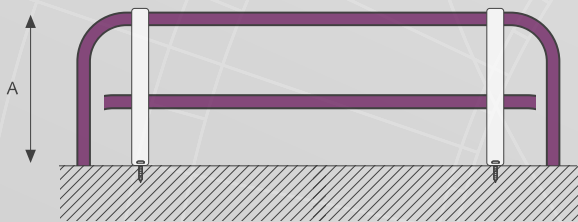

Other brackets are available. Brackets need to be placed every 60 cm (24").

### Aluminium Wall bracket single

- A) 7,5 cm (3")    B) 6,3 cm (2,5")  
 A) 10 cm (4")    B) 8,8 cm (3,5")

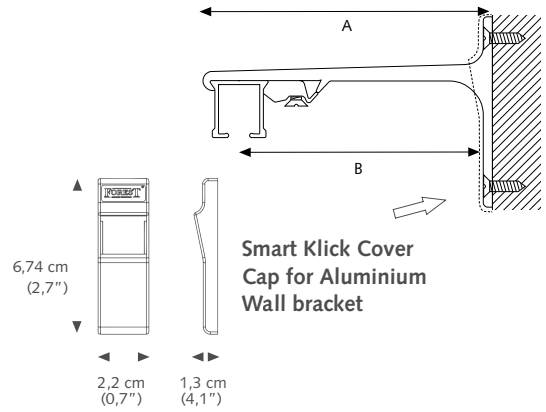

### Aluminium Wall bracket double

- A) 15 cm (6")    B) 9,2 cm (3,6")    C) 4,5 cm (1,8")  
 A) 20 cm (8")    B) 9,2 cm (3,6")    C) 9,5 cm (3,7")

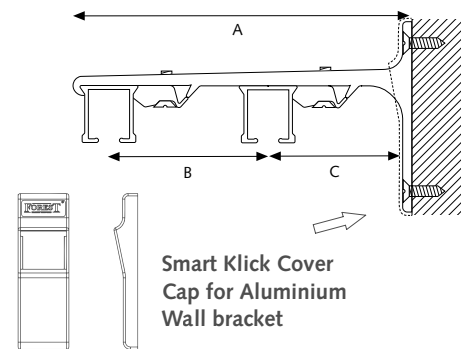





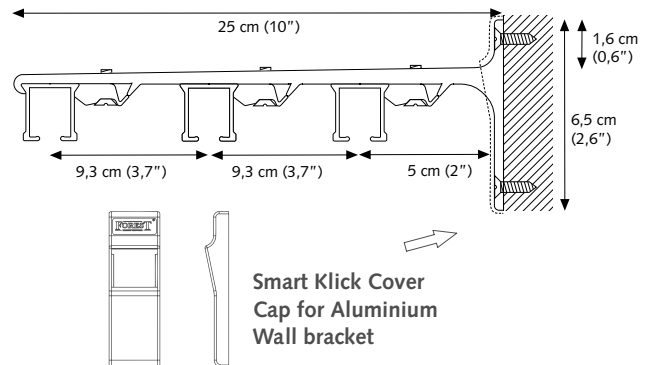

### Aluminium Wall bracket triple

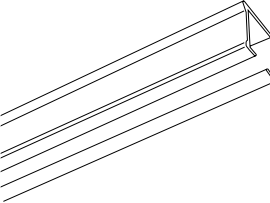
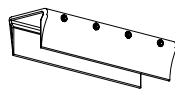
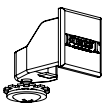
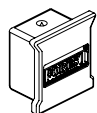
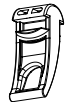

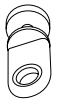

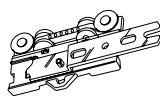
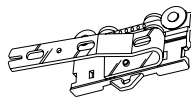
- A) 25 cm (10")

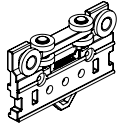
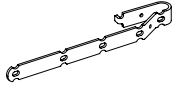
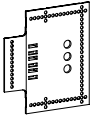
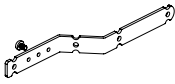
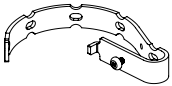
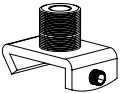
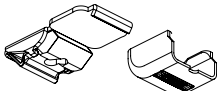
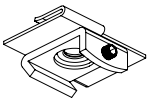
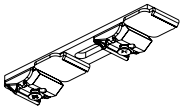
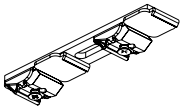

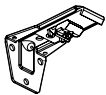
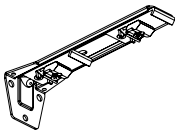

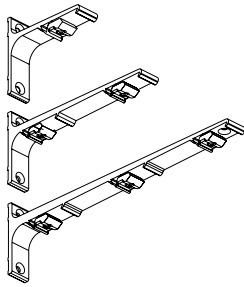
Brackets need to be placed every 50 - 60 cm (24"), depending on fabric weight.

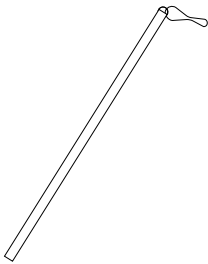
CS	ARTICLE	PACKING UNIT		ART.NR	
●		CS TRACK WHITE Extruded aluminium chromated, powder coating, factory lubricated.	10/bundle	3,66 meter (12') 4,27 meter (14') 4,88 meter (16') 6,10 meter (20')	2501001366 2501001427 2501001488 2501001610
		CS TRACK SILVER Extruded aluminium chromated, powder coating, factory lubricated	10/bundle	4,88 meter (16') 6,10 meter (20')	2501003488 2501003610
		CS TRACK BROWN Extruded aluminium chromated, powder coating, factory lubricated.	10/bundle	4,88 meter (16') 6,10 meter (20')	2501005488 2501005610
		CS TRACK BLACK Extruded aluminium chromated, powder coating, factory lubricated.	10/bundle	6,10 meter (20')	2501006610
●		CS/CCS/FMS TRACK CONNECTOR Used to make a solid connection between two pieces of track.	10/box	white silver brown black	2518401000 2518403000 2518405000 2518406000
●		CS ENDCAP UNIVERSAL LONG WITH SCREW	100/box	white silver brown black	2516400000 2516403000 2516405000 2516406000
●		CS ENDCAP UNIVERSAL SHORT WITH SCREW	100/box	white silver brown black	2516400001 2516403001 2516405001 2516406001
●		CS / CCS AS CARRIER "Clickable", offset, constructed of UV-resistant plastic. 10 Carriers on a break-away strip. Can be clicked in after	250/box	white silver brown black	2510101000 2510103000 2510105000 2510106000
●		CS STOPCARRIER Clickable.	100/box	white silver	2510201000 2510203000
●		CS / CCS CARRIER AS WITH HOOK Clickable.	100/box	white silver	2510501000 2510503000
●		CS ECONOMY SLIDE Can turn in the track.	500/box 500/box	white black	2510601000 2510606000
●		CS BALL BEARING CARRIER 20MM CS BALL BEARING CARRIER 20MM  CS BALL BEARING CARRIER 16MM SMALL CS BALL BEARING CARRIER 16MM SMALL  CS BALL BEARING CARRIER 25MM LARGE	100/box	white black  white black	2512000000 2512006000  2512000016 2512006016  2512100000
●		CS UNDERLAP CARRIER R/L	25/box	white	2514600000
●		CS OVERLAP CARRIER R/L	25/box	white	2514700000

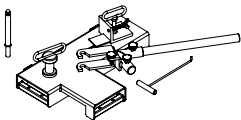
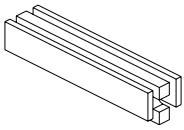
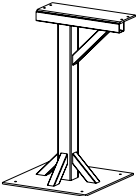
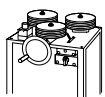
CS	ARTICLE	PACKING UNIT	ART.NR
	 <p>CS MASTER CARRIER BASE R/L WHITE</p>	25/box	white 4814500000
	 <p>PROLONGED OVERLAP ARM 150MM R/L FOR CLICK-ON STIFFNER</p>	15/box	9500001010
	 <p>STIFFNER "CLICK-ON"</p>	15/box	5116001001
	 <p>Z-ARM UNIVERSAL 175MM R/L</p>	15/box	white 9500001030
	 <p>FMS EASYFLEX CURVED ARM R/L WHITE</p>	15/box	Pc. 5135901020
	 <p>SUSPENSION BRACKET CLIP FOR MTS CEILING SUPPORT</p>	50/box	Pc. 1016901000
	 <p>KS SMART KLICK CEILING BRACKET INCL COVER CAP "Klicks" onto track, powder coated.</p>	100/box	white silver brown black 1018201001 1018203001 1018205001 1018206001
	 <p>SUSPENDED CEILING BRACKET, METAL For installation on to a suspended ceiling. The track can be fixed in any angle.</p>	25/box	4519001000
	 <p>KS SMART KLICK CEILING BRACKET DOUBLE LONG Distance between two tracks: 90 mm (3,5")</p>	30/box	white 1018601000
	 <p>KS SMART KLICK CEILING BRACKET DOUBLE SHORT</p>		1018611000
	 <p>MTS SUSPENSION Ceiling Bracket Length: 10 cm (4") - 1 m (3,3') 1 m (3,3') - 1,5 m (4,9')</p>	1/each	4518201000 4518201500
	 <p>KS ADJUSTABLE WALL BRACKET, SINGLE</p>	100/box	white silver 1020801115 1020803115
	 <p>KS ADJUSTABLE WALL BRACKET, DOUBLE</p>	50/box	white silver 1020801195 1020803195

CS	ARTICLE	PACKING UNIT	ART.NR	
	KS SMART KLICK ALUMINIUM WALL BRACKET 7,5 cm	20/box	white silver brown black	1020301075 1020303075 1020305075 1020306075
	KS SMART KLICK ALUMINIUM WALL BRACKET 10 cm	20/box	white silver black	1020301100 1020303100 1020306100
	KS SMART KLICK ALUMINIUM WALL BRACKET 15 cm	15/box	white silver brown black	1020301150 1020303150 1020305150 1020306150
	KS SMART KLICK ALUMINIUM WALL BRACKET 20 cm	15/box	white silver black	1020301200 1020303200 1020306200
	KS SMART KLICK ALUMINIUM WALL BRACKET 25 cm	10/box	white silver black	1020301250 1020303250 1020305250
	COVER CAP FOR KS SMART KLICK ALUMINIUM WALL BRACKET	50/box	white silver black	1021301000 1021303000 1021306000
	KS FLICKSTICK FIBERGLASS	50/box	92 cm 122 cm 152 cm	1065101092 1065101122 1065101152
	KS FLICKSTICK TRANSPARENT	50/box	92 cm 122 cm 152 cm	1065102092 1065102122 1065102152
	KS FLICKSTICK WHITE ALUMINIUM	50/box	92 cm 122 cm 152 cm	1065111092 1065111122 1065111152
	KS FLICKSTICK SILVER ALUMINIUM	50/box	202 cm 92 cm 122 cm	1065111202 1065113092 1065113122
	KS FLICKSTICK BLACK ALUMINIUM	50/box	152 cm 92 cm 122 cm	1065113152 1065116092 1065116122
	KS FLICKSTICK ANTIQUE ALUMINIUM	50/box	152 cm 92 cm 122 cm	1065116152 1065119092 1065119122
	1065119152			
	VELCRO HOTEL PROFILE Inside frame fix, to reduce light leakage in combination with Looptape	120 mtr/bundle		3581601600
	LOOPTAPE	25 mtr/roll		3816202020
	CONTRACT BENDING TOOL BASIC (without bending wheel)	1/each		2560000000
	CS/CCS/FMS BENDING WHEEL	1/each		2561000000
	CS BENDING STRIPS For CS track, length: 90 cm (35,4")	1/set		8500000001
	FOR CS ELECTRIC POWERED BENDER. Length 7 meter (23').	1/set		5160600000
	BENDING STAND Stand for contract bending tool	1/each		2560800000
	ELECTRIC POWERED BENDER Available in 230V or 115V To create continuous curves and arches minimum radius 50 cm (20")	1/each		1060500000

CS	ARTICLE	PACKING UNIT	ART.NR
●	 <p>KS/CKS BENDING WHEELS For Electric Powered Bender. Complete set of 3 wheels.</p>	1/set	1060700000
●	 <p>ELECTRIC POWERED RAILCUTTER 230 Volt EU</p> <p>REPLACEMENT BLADE For electric powered railcutter.</p>	1/each	1061100000 1061200000
●	 <p>FOREST LUBRICANT To lubricate components during assembly.</p>	1/each	5109010000