

SPECIALIZED FABRICATION EQUIPMENT
GROUP

PRODUCT SUMMARY 2026

www.sfe-brands.com



The **Specialized Fabrication Equipment Group** (in short: **S.F.E. Group**) was founded in 2019 after the merger of three world leading OEM's in the field of pipe fabrication tooling and machinery: B&B Pipe and Industrial Tools LLC (USA), Mathey Dearman Inc. (USA) and TAG Pipe Equipment Specialists (UK). In a time span of 5 years, another 4 renowned and market leading companies were acquired and added to the **S.F.E. Group** portfolio: Axxair (France, 2022), Magnatech (USA, 2023), Climax (USA, 2023) and Sumner (USA, 2025).

The vision and philosophy of the **S.F.E. Group** is to offer globally a comprehensive innovative and cost-effective range of specialized fabrication, welding and machining equipment and derived rental solutions, for a wide range of applications within all critical industries, while optimizing performance, efficiency and safety.

Leveraging over 200 years of combined experience in engineering, manufacturing, and field applications, the **S.F.E. Group** is committed to driving innovation. Through continuous product development and strategic acquisitions, the **S.F.E. Group** is actively growing its portfolio and expanding its global presence to meet the demands of industries around the world. Currently, the **S.F.E. Group** consists of 12 complimentary brands, each supporting the others in delivering cutting-edge solutions.

With offices and warehousing on 5 continents, 400+ employees and more than 500 partnerships and distributors worldwide, **S.F.E. Group** prides itself on consistently offering the highest standards of both product quality and service locally to all its customers.

S.F.E. Group looks forward to welcoming you into its global network as a partner, distributor or end user customer and remains at your disposal at any time.

Contact Americas: sales@sfe-brands.com
 Contact International: sales-int@sfe-brands.com

S.F.E. GROUP GLOBAL PRESENCE

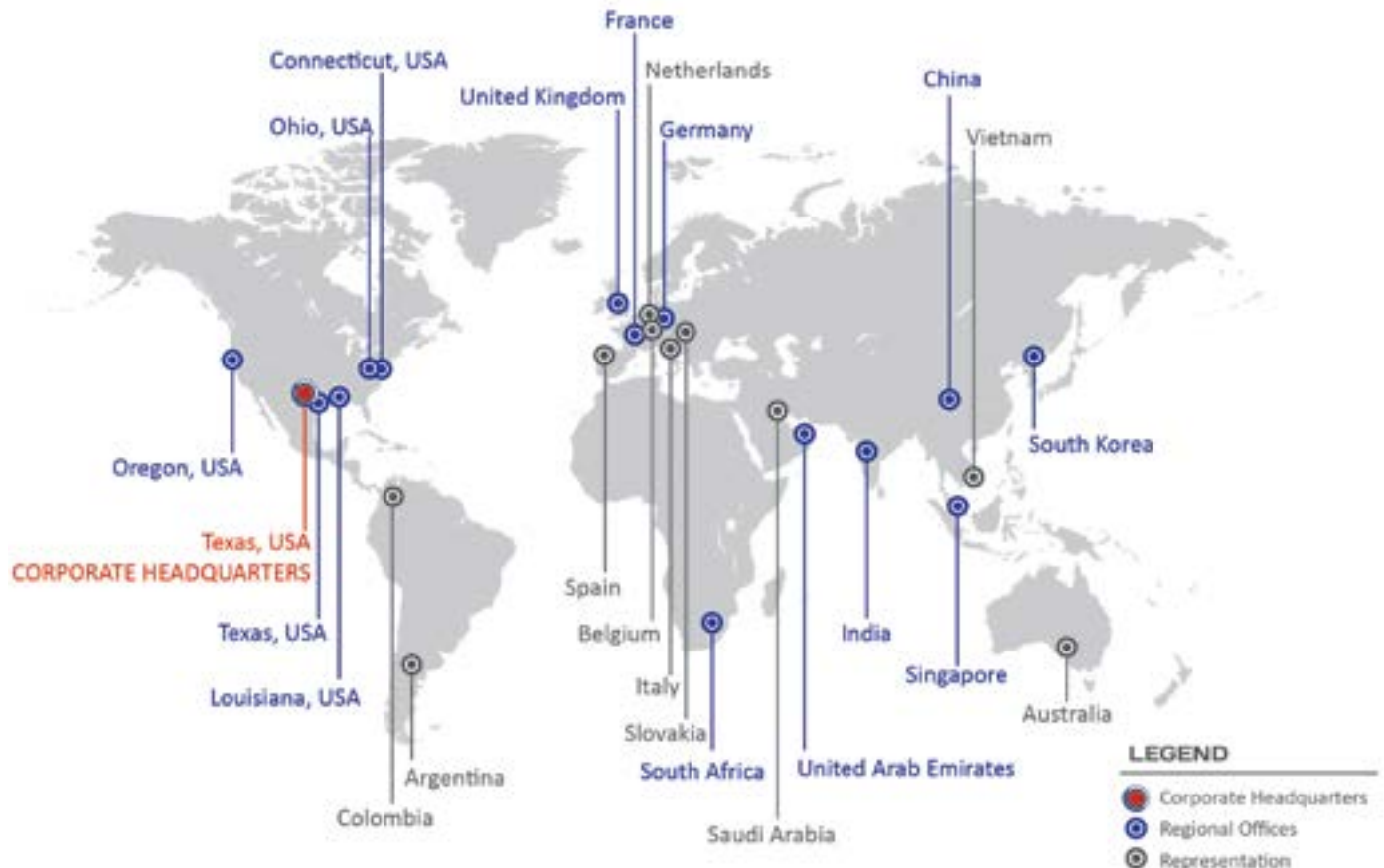

2

INTRODUCING THE S.F.E. GROUP

5

TOOLS & LIFTING EQUIPMENT

B&B SUMNER	6
PIPE JACKS & STANDS	7
MATERIAL HANDLING EQUIPMENT.....	18
MATHEY DEARMAN	22
PIPE FLAME CUTTING & BEVELLING.....	23
PIPE ALIGNMENT & REFORMING CLAMPS.....	24
PIPE RIGGING EQUIPMENT	27
FIT-UP PRO	28
FIT-UP & ALIGNMENT TOOLS	29
LAYOUT & MARKING TOOLS.....	33
SUMNER MATERIAL LIFTS	38
LIFTS	39
GANTRIES	43
HOISTS.....	44
PIPE PURGE MASTERS (PPM)	46
PIPE PURGING SYSTEMS.....	47
PURGE OXYGEN MONITOR.....	48
PIPE STOPPERS	49

51

ORBITAL WELDING & CUTTING

AXXAIR	52
ORBITAL CUTTING & BEVELLING MACHINES.....	53
TUBE FACING & SQUARING MACHINES.....	54
ORBITAL WELDING SOLUTIONS.....	55
MULTI BRAND COMPATIBLE ORBITAL WELDING SOLUTIONS.....	59
MAGNATECH	60
WELDING HEADS & POWER SOURCES	61
PIPELINER PRO	62

65

PIPE BEVELLING & ONSITE MACHINING EQUIPMENT

TAG PIPE	66
PIPE BEVELLING MACHINES	67
ACCESSORIES & OPTIONS - PREP 2 / 3 / 4 / 8.....	68
FLANGE FACING MACHINE	69
PANEL PREP MACHINES.....	69
PIPE COLD CUTTING MACHINES.....	71
ACCESSORIES FOR PNEUMATIC MACHINES ONLY	72
PLATE BEVELLING MACHINES.....	73
H&S TOOL	74
PIPE BEVELLING MACHINES	75
ACCESSORIES & OPTIONS - PREP 2 / 3 / 4 / 8.....	76
FLANGE FACING MACHINE	77
PANEL PREP MACHINES.....	77
PIPE COLD CUTTING MACHINES.....	79
ACCESSORIES FOR PNEUMATIC MACHINES ONLY	80
BORTECH	82
BORE WELDING MACHINES.....	83
CLIMAX	84
LINE BORING MACHINES	85
SERVO MOTOR CONVERSION KITS	88
I/D MOUNT FLANGE FACERS	89
O/D MOUNT FLANGE FACERS	92
I/D OR O/D MOUNT CONFIGURED FLANGE FACERS.....	94
CIRCULAR MILLING MACHINES	95
LATHES.....	96
KEY MILL.....	97
DRILLS.....	97
MILLING MACHINES	98
PLATE EDGE MILLING MACHINES	99
CALDER	100
VALVE TESTERS	101

105

RENTAL SOLUTIONS

 **CLIMAX**

 **TAG**
PIPE EQUIPMENT SPECIALISTS

 **H&S TOOL**

 **MATHEY DEARMAN**

 **AXXAIR**

 **MAGNATECH**

 **B&B SUMNER**

 **CALDER**

 **BORTECH**

 **PPM**
PIPE PURGE MASTERS

 **FIT-UP PRO**

 **SUMNER**
MATERIAL LIFTS





www.BBSUMNER.com



www.MATHEY.com

FIT-UP PRO

www.FIT-UP-PRO.com



www.SUMNER.com



www.PURGEMASTERS.com

TOOLS & LIFTING EQUIPMENT



B&B SUMNER is the newly created global leading brand within the S.F.E. Group portfolio, following the acquisition in 2025 of Sumner Manufacturing, a company with a long-standing reputation for quality and innovation in lifting, material handling, and welding tools.

B&B SUMNER combines the expertise, innovation, and heritage of two strong historical brands and embodies the synergy of decades of experience and industry leadership, offering a broader, more powerful portfolio of solutions to S.F.E. Group's global customer base.

With the **B&B SUMNER** brand, the S.F.E. Group not only wishes to highlight the focus on this particular product line, but also supply the growing demand and diverse applications in the industries it already serves and intertwine with other product applications within S.F.E. Group.

As an OEM, S.F.E. Group prides itself on its innovations, ground-breaking developments, and creative designs within the **B&B SUMNER** product range. The **B&B SUMNER** brand portfolio consists mainly of a comprehensive range of pipe jacks and stands, mega rollers and stands, and material handling carts. With robust engineering capabilities, a customer-oriented focus, and flexibility, the **B&B SUMNER** brand delivers out-of-the-box pipe handling and material handling equipment as well as solutions tailored to meet customers' specific project needs and to serve an ever-evolving industry.

B&B SUMNER products are readily available through the S.F.E. Group's global network and can be consulted on the dedicated website: www.BBSUMNER.com





HI HEAVY DUTY PRO-JACK

Pipe Size Capacity: up to 12" / 300 mm
Pipe Load Capacity: 2,500 lbs / 1,135 kg
Height Adjustable: 28 - 49" / 711.2 - 1,245 mm

The B&B SUMNER Hi Heavy Duty Pro-Jack is a high-capacity, fixed-leg pipe stand built for heavy-duty industrial pipework. With a working height range of 28 - 49" / 711 - 1,245 mm, it supports pipe diameters up to 12" / 300 mm. Its robust steel construction includes oversized square tube legs, bracing, and a 1.5" ACME-threaded rod, the largest in the industry. The V-head is oversized at 10" / 254 mm, ensuring secure pipe seating. The jack has a load capacity of 2,500 lbs / 1,135 kg and a shipping weight of 19.85 lbs / 9.00 kg. Quick-lock height adjustment and optional head styles enhance its adaptability. A third-party certified 2:1 safety ratio and locking safety washer deliver additional operational security.

Available in a crate of 30 pieces (**PART NO 4100x30***)
 Available in a crate of 42 pieces (**PART NO 4100x42***)
*** New crate quantity - availability to be confirmed**

PART NO 4100 (includes V-head)

OLD SUMNER PART NO 780375 or 780471 / OLD BB PART NO 4100

FOR ALL SIZES, HEAD OPTIONS AND PART NUMBERS, PLEASE SCAN THE PRODUCT QR CODE



LO HEAVY DUTY PRO-JACK

Pipe Size Capacity: up to 12" / 300 mm
Pipe Load Capacity: 2,500 lbs / 1,135 kg
Height Adjustable: 20 - 37" / 508 - 939.8 mm

Engineered for low-clearance applications, the B&B SUMNER Lo Heavy Duty Pro-Jack delivers the same durability and features as its Hi counterpart but with a reduced working height of 20 - 37" / 508 - 940 mm. It holds pipe diameters up to 12" / 300 mm and supports a load of 2,500 lbs / 1,135 kg. A V-head ensures secure placement and compatibility with multiple optional heads. Its rigid steel frame includes reinforced legs and a 1.5" ACME adjustment rod, complemented by a quick-lock washer for swift and secure height modifications. Shipping weight is 18.00 lbs / 8.00 kg, making it lightweight yet rugged enough for fabrication, workshop, or field use.

Available in a crate of 80 pieces (**PART NO 4200x80**)

PART NO 4200 (includes V-head) OLD SUMNER PART NO 780385 / OLD BB PART NO 4200

FOR ALL SIZES, HEAD OPTIONS AND PART NUMBERS, PLEASE SCAN THE PRODUCT QR CODE



STUBBY HEAVY DUTY PRO-JACK

Pipe Size Capacity: up to 12" / 300 mm
Pipe Load Capacity: 2,500 lbs / 1,135 kg
Height Adjustable: 16 - 26" / 406.4 - 660.4 mm

The Stubby Heavy Duty Pro-Jack is B&B SUMNER's most compact fixed-leg jack, offering dependable pipe support in space-constrained settings. With a height range of 16 - 26" / 406 - 660 mm, it maintains a sturdy frame while accommodating up to 12" / 300 mm pipe diameters. Despite its smaller size, it matches the load capacity of larger models at 2,500 lbs / 1,135 kg. Its V-head guarantees stable positioning, and the 14.00 lbs / 6.50 kg shipping weight makes it easy to move between locations. Ideal for mechanical shops and low-elevation jobs, it delivers reliability without sacrificing safety.

Available in a crate of 94 pieces (**PART NO 4240x94**)

PART NO 4240 (includes V-head) OLD SUMNER PART NO n/a / OLD BB PART NO 4240

FOR ALL SIZES, HEAD OPTIONS AND PART NUMBERS, PLEASE SCAN THE PRODUCT QR CODE





HI HEAVY DUTY FOLD-A-JACK

Pipe Size Capacity: up to 12" / 300 mm
Pipe Load Capacity: 2,500 lbs / 1,135 kg
Height Adjustable: 28 - 49" / 711.2 - 1,245 mm

This B&B SUMNER Hi Heavy Duty Fold-A-Jack combines portability with power, offering a collapsible leg frame for easy transport. It adjusts between 28 - 49" / 711 - 1,245 mm, supports pipes up to 12" / 300 mm, and carries a load of 2,500 lbs / 1,135 kg. Its rugged steel build features oversized tubing, a 10" V-head, and a 1.5" ACME rod for fine adjustment. Weighing 22.30 lbs / 10.10 kg, it's ideal for fabrication shops where compact storage is key. A locking washer system improves safety and setup speed. Available with multiple head styles for various applications.

Available in a crate of 30 pieces (**PART NO 3900x30***)
 Available in a crate of 75 pieces (**PART NO 3900x75***)
 Available in a crate of 86 pieces (**PART NO 3900x86***)
*** New crate quantity - availability to be confirmed**

PART NO 3900 (includes V-head) OLD SUMNER PART NO 781300 / OLD BB PART NO 3900
FOR ALL SIZES, HEAD OPTIONS AND PART NUMBERS, PLEASE SCAN THE PRODUCT QR CODE



LO HEAVY DUTY FOLD-A-JACK

Pipe Size Capacity: up to 12" / 300 mm
Pipe Load Capacity: 2,500 lbs / 1,135 kg
Height Adjustable: 20 - 37" / 508 - 940 mm

The Lo Heavy Duty Fold-A-Jack from B&B SUMNER offers all the strength of its taller sibling with a shorter profile for tighter setups. Height adjusts from 20 - 37" / 508 - 940 mm, suitable for up to 12" / 300 mm pipe. Its V-head ensures pipe stability during welding or layout. Rated for 2,500 lbs / 1,135 kg, the unit has a shipping weight of 18.00 lbs / 8.00 kg and is equipped with folding legs and oversized bracing for rugged jobsite conditions. The quick-lock ACME-threaded system provides smooth, secure height changes. It's a favorite for compact mechanical spaces and maintenance work.

Available in a crate of 94 pieces (**PART NO 4000x94**)

PART NO 4000 (includes V-head) OLD SUMNER PART NO 781310 / OLD BB PART NO 4000
FOR ALL SIZES, HEAD OPTIONS AND PART NUMBERS, PLEASE SCAN THE PRODUCT QR CODE

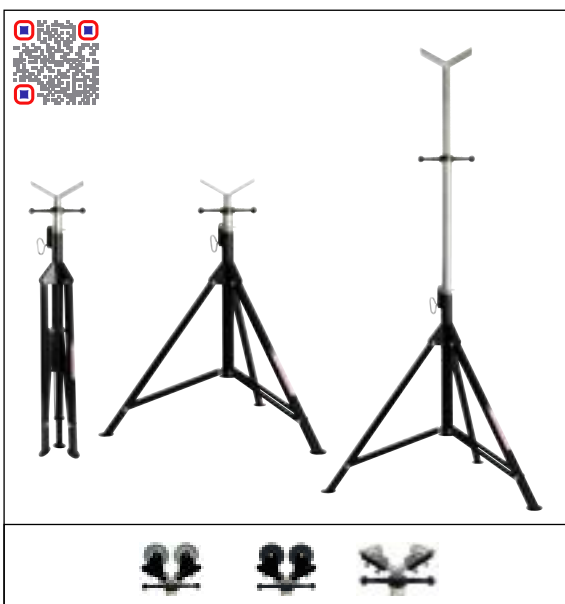

HI BOY™ JACK

Pipe Size Capacity: 1 - 12"
Pipe Load Capacity: 1,000 lbs / 450 kg
Height Adjustable: 39 - 72" / 99.1 - 1,829 mm

Designed for elevated work environments, the B&B SUMNER Hi Boy™ Jack features an extended height range of 39 - 72" / 99.1 - 1,829 mm and a wide 38" / 965 mm footprint. It supports pipes up to 24" / 600 mm in diameter and loads of 1,000 lbs / 450 kg. The unit's V-head accommodates slip-on style attachments, making it adaptable to various project needs. The foldable leg design allows easy transport and setup. It's especially useful for overhead installations and alignment tasks in tight or vertical spaces. Total shipping weight is 33 lbs / 15 kg.

Available in a crate of 60 pieces (**PART NO 3610x60**)

PART NO 3610 (includes V-head) OLD SUMNER PART NO 783250 / OLD BB PART NO 3610
FOR ALL SIZES, HEAD OPTIONS AND PART NUMBERS, PLEASE SCAN THE PRODUCT QR CODE



HOLD-E™ V-HEAD HOLD DOWN

0.75 - 6" / 19 - 152 mm

The B&B SUMNER HOLD-E™ is a precision pipe clamping solution built to anchor pipes on V-head stands. Designed for 0.75 - 6" / 19 - 152 mm pipe diameters, it uses a push-button quick-lock mechanism and fine-threaded adjustment to ensure tight, stable engagement. Weighing 8.7 lbs / 3.9 kg, the HOLD-E™ is crafted in both carbon and stainless steel, making it suitable for harsh or cleanroom environments. It clamps easily to any V-head pipe jack for fit-up, welding, or transport purposes, enhancing safety and efficiency on-site.

PART NO HOLDE OLD SUMNER PART NO 785000 / OLD BB PART NO n/a



HOLD DOWN DEVICE

Up to 36" / 915 mm

B&B SUMNER's Hold Down Device is a rugged, bench - or stand - mounted clamp for securing large workpieces. It handles up to 36" / 915 mm diameter pipes and has a shipping weight of 15.40 lbs / 7.00 kg. The device is ideal for welding, assembly, or machining tasks, delivering stable, repeatable pressure to minimize shifting and vibration. Hardened steel components, a swivel base, and fine-thread control make it adaptable to various surfaces and shapes. It's a must-have in any fabrication or mechanical shop prioritizing safety and precision.

PART NO HDD OLD SUMNER PART NO 781050 / OLD BB PART NO 3506



FAB SAF™ JACK

32 - 52" / 813 - 1,321 mm

The Fab Saf™ Jack from B&B SUMNER is built for maximum strength and safety in fabrication environments. Supporting up to 3,500 lbs / 1,588 kg with its V-head, this stand accommodates pipe diameters up to 36" / 900 mm and adjusts from 32 - 52" / 813 - 1,321 mm. It features the Fall Guard™ system, creating a 1" / 25 mm safety buffer around the adjustment washer. The robust 30" / 762 mm wide base, 1.5" ACME thread, and ergonomic handle ensure stability and smooth operation. Total weight is 26 lbs / 11.8 kg.

Available in a crate of 25 pieces (**PART NO 4800x25**)

PART NO 4800 (includes V-head) OLD SUMNER PART NO 780395 / OLD BB PART NO n/a
FOR ALL SIZES, HEAD OPTIONS AND PART NUMBERS, PLEASE SCAN THE PRODUCT QR CODE



FAT JACK™ MAXI (FOLDING LEG)

36" / 914 mm up to 61" / 1,549 mm

The Fat Jack™ Maxi is the largest in B&B SUMNER's high-capacity pipe jack line. It handles pipes up to 36" / 914 mm with a load capacity of 6,000 lbs / 2,725 kg and adjusts from 36 - 61" / 914 - 1,549 mm. Built from 1.25" steel tubing, it features a double locking pin system, wide stance, and a large ergonomic handle for safe and easy adjustments. The V-head guarantees centered support, and optional roller heads are available. At 47 lbs / 21.4 kg, this jack offers top-tier strength and precision for demanding industrial use.

Available in a crate of 60 pieces (PART NO 4700x60)

PART NO 4700 (includes V-head) OLD SUMNER PART NO 787900 / OLD BB PART NO n/a
FOR ALL SIZES, HEAD OPTIONS AND PART NUMBERS, PLEASE SCAN THE PRODUCT QR CODE



FAT JACK™ MIdI (FOLDING LEG)

26.5" / 673 mm up to 44.5" / 1,130 mm

The Fat Jack™ Midi balances compact design and heavy-duty performance, with a load capacity of 6,000 lbs / 2,725 kg. It adjusts from 26.5 - 44.5" / 673 - 1,130 mm and accommodates pipes up to 36" / 900 mm. Constructed with 1.25" steel tubing, it features a 1.5" ACME-threaded adjustment and a double locking pin system for maximum safety. Ideal for medium-duty industrial use, the Fat Jack™ Midi weighs 37 lbs / 16.8 kg and includes optional roller head configurations to meet various pipe handling needs.

Available in a crate of 75 pieces (PART NO 4701x75)

PART NO 4701 (includes V-head) OLD SUMNER PART NO 787901 / OLD BB PART NO n/a
FOR ALL SIZES, HEAD OPTIONS AND PART NUMBERS, PLEASE SCAN THE PRODUCT QR CODE



FAT JACK™ MIni (FIXED LEG)

16" / 406 mm up to 28.5" / 724 mm

The Fat Jack™ Mini offers powerful support in a compact form factor. Designed for low-profile tasks, it adjusts from 16 - 28.5" / 406 - 724 mm and handles pipe diameters up to 36" / 900 mm. With a maximum load capacity of 6,000 lbs / 2,725 kg, it is perfect for smaller jobs that still demand industrial strength. Featuring a fixed-leg steel frame, double locking pins, and a 1.5" ACME thread, this 28 lbs / 11.4 kg unit is a reliable tool for any shop or job site.

Available in a crate of 65 pieces (PART NO 4702x65)

PART NO 4702 (includes V-head) OLD SUMNER PART NO 787902 / OLD BB PART NO n/a
FOR ALL SIZES, HEAD OPTIONS AND PART NUMBERS, PLEASE SCAN THE PRODUCT QR CODE



THREE LEG MEGA JACK

Pipe Size Capacity: up to 32" / 813 mm
Pipe Load Capacity: 5,000 lbs / 2,265 kg
Height Adjustable: 32 - 44" / 812.8 - 1,117.6 mm

The Three Leg Mega Jack from B&B SUMNER is engineered for enhanced stability and strength, supporting loads up to 5,000 lbs / 2,265 kg. Its oversized 16" V-head and gusseted design allow secure handling of pipes up to 32" / 812 mm. Height adjustable from 32 - 44" / 812.8 - 1,117.6 mm, the jack features a solid 1.75" ACME-threaded rod, eliminating the need for washers or support tubes. This model offers a simplified adjustment mechanism and increased stability for demanding environments.

Available in a crate of 25 pieces (**PART NO 3600x25**)

PART NO 3600 (includes V-head) OLD SUMNER PART NO n/a / OLD BB PART NO 3600
FOR ALL SIZES, HEAD OPTIONS AND PART NUMBERS, PLEASE SCAN THE PRODUCT QR CODE



FOUR LEG MEGA JACK

Pipe Size Capacity: up to 32" / 813 mm
Pipe Load Capacity: 5,000 lbs / 2,265 kg
Height Adjustable: 31 - 49" / 787.4 - 1,244.6 mm

The Four Leg Mega Jack offers unmatched stability and support for heavy-duty pipe work. With a load capacity of 5,000 lbs / 2,265 kg and a pipe diameter capability up to 32" / 812 mm, it is built for strength. The stand features a large 16" V-head, reinforced legs, and a solid 1.75" ACME-thread for smooth and precise height adjustments. Adjustable between 31 - 49" / 787.4 - 1,244.6 mm, it's ideal for use in unstable terrain or industrial applications requiring extra footing.

Available in a crate of 19 pieces (**PART NO 3604x19**)

PART NO 3604 (includes V-head) OLD SUMNER PART NO n/a / OLD BB PART NO 3604
FOR ALL SIZES, HEAD OPTIONS AND PART NUMBERS, PLEASE SCAN THE PRODUCT QR CODE



BIG VEE JAX™

Pipe Size Capacity: up to 36" / 900 mm
Pipe Load Capacity: 5,000 lbs / 2,265 kg
Height Adjustable: 29.5 - 41" / 750 - 1,109 mm

The Big Vee Jax™ stand supports pipe diameters ranging from 4 - 36" / 101.6 - 914.4 mm and loads up to 5,000 lbs / 2,265 kg. Its 12" / 305 mm V-head ensures secure cradling of large pipe sections. A gear-driven ACME-threaded height adjuster enables precision control. Built from 1" steel tubing with a three-legged base, it provides a sturdy stance for field and shop use. Total shipping weight is 64 lbs / 29 kg.

PART NO 3501 (includes V-head) OLD SUMNER PART NO 780260 / OLD BB PART NO 3501
FOR ALL SIZES, HEAD OPTIONS AND PART NUMBERS, PLEASE SCAN THE PRODUCT QR CODE



LO MAX JAX™ 2

Pipe Size Capacity: up to 36" / 900 mm
Pipe Load Capacity: 4,500 lbs / 2,040 kg
Height Adjustable: Low mode: 23 - 34" / 584 - 863.6 mm
 High mode: 23 - 34" / 584 - 863.6 mm

The B&B SUMNER Lo Max Jax™ 2 is a versatile, low-profile fabrication stand ideal for pipe fit-up, rotation, and welding. Supporting pipe diameters from 4 - 36" / 101.6 - 900 mm, it offers a load capacity of up to 4,500 lbs / 2,040 kg. The adjustable height range of 23 - 34" / 584 - 863.6 mm enables ergonomic positioning. Fitted with urethane-over-steel 6" casters, it ensures easy mobility. Optional accessories include stainless steel sleeves, ball transfers, and hold-down chains, enhancing the unit's adaptability for jobsite conditions. Shipping weight is 64 lbs / 29 kg.

Note: parts of the Low Max Jax™ 2 are not interchangeable with the Max Jax™ pipe stand.

Available in a crate of 16 pieces (PART NO 3300x16)

PART NO 3300 (includes V-head and casters)

FOR ALL SIZES, HEAD OPTIONS AND PART NUMBERS, PLEASE SCAN THE PRODUCT QR CODE



MAX JAX™

Pipe Size Capacity: up to 36" / 900 mm
Pipe Load Capacity: 5,000 lbs / 2,265 kg
Height Adjustable: 32 - 44" / 812.8 - 1,117.6 mm

The Max Jax™ by B&B SUMNER is a robust, high-capacity support system designed for large-diameter pipe applications. It handles pipes up to 36" / 914.4 mm with a load capacity of 5,000 lbs / 2,265 kg. The adjustment range is 32 - 44" / 812.8 - 1,117.6 mm, offering flexibility across various applications. With its five-leg base, 1.75" ACME-threaded rod, and 8" casters compatibility, it ensures both stability and mobility. Optional Beam Jax™ heads and wheel kits increase its versatility for beam or pipe work. Shipping weight is 64 lbs / 29 kg.

The B&B SUMNER Max Jax™ is individually available or in a crate of 14 pieces (Part No. 3500x14).

Available in a crate of 11 pieces (PART NO 3500x11*)

Available in a crate of 14 pieces (PART NO 3500x14*)

*** New crate quantity - availability to be confirmed**

PART NO 3500 (includes V-head) OLD SUMNER PART NO 781460 / OLD BB PART NO 3500

FOR ALL SIZES, HEAD OPTIONS AND PART NUMBERS, PLEASE SCAN THE PRODUCT QR CODE



PRO ADJUST-A-ROLL™

Pipe Size Capacity: 2 - 48" / 50.8 - 1,219 mm
Pipe Load Capacity: 5,290 lbs / 2,400 kg
Height Adjustable: 29 - 42.5" / 136.6 - 1,079.5 mm

The B&B SUMNER Pro Adjust-A-Roll™ is a premium pipe roller stand engineered for heavy-duty pipe handling. With a load capacity of 5,290 lbs / 2,400 kg, it accommodates pipe sizes from 2 - 48" / 50.8 - 1,219 mm and adjusts in height from 29 - 42.5" / 736.6 - 1,079.5 mm. The stand includes quick-change heads and locking casters, making it suitable for layout, fit-up, and welding applications. Its robust build and modular head design allow for quick adaptation using steel, stainless steel, phenolic, or ball transfer rollers.

Available in a crate of 20 pieces (PART NO 4375BASEx20*)

Available in a crate of 24 pieces (PART NO 4375BASEx24*)

*** New crate quantity - availability to be confirmed**

PART NO 4375SWH (with steel wheel head) / PART NO 4375BASE (base only)

OLD SUMNER PART NO 780441 / OLD BB PART NO 4375

FOR ALL SIZES, HEAD OPTIONS AND PART NUMBERS, PLEASE SCAN THE PRODUCT QR CODE



HI ADJUST-A-ROLL™

Pipe Size Capacity: 48" / 1,219 mm
Pipe Load Capacity: 5,290 lbs / 2,400 kg
Height Adjustable: 32" / 812.8 mm

B&B SUMNER's Hi Adjust-A-Roll™ is a folding 4-leg roller stand designed for medium to heavy pipe fabrication. With a capacity of 5,290 lbs / 2,400 kg, it supports pipe up to 48" / 1,219 mm in diameter. The standard working height is 32" / 812.8 mm. Its wide footprint of 32 x 24 x 32" / 812.8 x 609.6 x 812.8 mm and quick-change roller head options enhance functionality and safety. It features a T-handle brake, self-centering adjustments, and removable wheel housings for ease of transport.

Available in a crate of 24 pieces (**PART NO 4300BASEx24**)

PART NO 4300SWH (with steel wheel head)

OLD SUMNER PART NO 780365 / OLD BB PART NO 4300

FOR ALL SIZES, HEAD OPTIONS AND PART NUMBERS, PLEASE SCAN THE PRODUCT QR CODE



LO ADJUST-A-ROLL™

Pipe Size Capacity: 0.5 - 36" / 12 - 914 mm
Pipe Load Capacity: 5,290 lbs / 2,400 kg
Height Adjustable: 24" / 610 mm

The B&B SUMNER Lo Adjust-A-Roll™ is a low-profile roller stand built for precision pipe handling in compact setups. Capable of supporting up to 5,290 lbs / 2,400 kg, it features a fixed height of 24" / 610 mm and supports pipes from 0.5 - 36" / 12 - 914 mm. Its compact dimensions 32 x 24 x 24" / 812.8 x 609.6 x 812.8 mm, make it ideal for bench-top or low-clearance operations. Quick-change heads, fine-thread adjustments, and heavy-duty square tubing offer superior safety and adaptability.

Available in a crate of 32 pieces (**PART NO 4400BASEx32**)

PART NO 4400SWH (with steel wheel head)

OLD SUMNER PART NO 780370 / OLD BB PART NO n/a

FOR ALL SIZES, HEAD OPTIONS AND PART NUMBERS, PLEASE SCAN THE PRODUCT QR CODE



MINI ADJUST-A-ROLL™

Pipe Size Capacity: 0.5 - 36" / 12 - 914 mm
Pipe Load Capacity: 3,500 lbs / 1,588 kg

The B&B SUMNER Mini Adjust-A-Roll™ is a compact roller stand designed for space-limited environments. Supporting pipe diameters from 0.5 - 36" / 12 - 914 mm and loads up to 3,500 lbs / 1,588 kg, it features a four-leg base and a quick-change head system for flexible configurations. With a footprint of just 11 x 22" / 279 x 559 mm and a shipping weight of 20 lbs / 9 kg, it's ideal for tight fabrication areas. Fine-thread adjustment allows precise pipe positioning, making it perfect for bench work, small fabrication stations, or field use.

Available in a crate of 60 pieces (**PART NO 4600BASEx60**)

PART NO 4600BASE OLD SUMNER PART NO 785285 / OLD BB PART NO n/a

FOR ALL SIZES, HEAD OPTIONS AND PART NUMBERS, PLEASE SCAN THE PRODUCT QR CODE



TABLE ADJUST-A-ROLL™

Pipe Size Capacity: 2 - 48" / 50.8 - 1,219.20 mm
Pipe Load Capacity: 5,290 lbs / 2,500 kg

The Table Adjust-A-Roll™ by B&B SUMNER is a floor- or bench-mounted roller head designed for stable pipe handling. It supports pipe sizes from 2 - 48" / 50.8 - 1,219.2 mm and loads up to 5,290 lbs / 2,400 kg. This quick-change roller unit enhances efficiency during layout and fit-up processes. Built with rugged components, it fits easily into compact workspaces. Depending on configuration, the shipping weight ranges around 13 lbs / 5.90 kg. It's a versatile addition to welding tables or bench setups.

PART NO 90063 OLD SUMNER PART NO 780500 / OLD BB PART NO 90063

FOR ALL SIZES, HEAD OPTIONS AND PART NUMBERS, PLEASE SCAN THE PRODUCT QR CODE



MEGA ROLLER STAND - 6,000 LBS / 3 US TON

Weight Capacity: 6,000 lbs / 2,720 kg
Pipe Size Capacity: 4 - 48" / 101.6 - 1,219.2 mm
Working Height: 31 - 48" / 787.4 - 1,219.2 mm

The B&B SUMNER Mega Roller Stand (6,000 lbs / 2,720 kg) is built for heavy-duty pipe support. Height range from 31 - 48" / 787.4 - 1,219.2 mm. It accommodates pipe sizes from 4 - 48" / 101.6 - 1,219.2 mm. The urethane-over-steel 6 x 3" wheels enable smooth pipe rotation. The stand's modular design includes quick-release pins and compatibility with additional accessories. Weights range from 105.80 - 118.00 lbs / 48.00 - 54.00 kg.

PART NO 3807



MEGA ROLLER STAND - 10,000 LBS / 5 US TON

Weight Capacity: 10,000 lbs / 4,535 kg
Pipe Size Capacity: 4 - 60" / 101.6 - 1,524 mm
Working Height: 25 - 35" / 635 - 889 mm

Supporting up to 10,000 lbs / 4,535 kg, this B&B SUMNER Mega Roller Stand accommodates pipe diameters from 4 - 60" / 101.6 - 1,524 mm. Its working height adjusts from 25 - 35" / 635 - 889 mm. Four 10 x 3" urethane-over-steel wheels with sealed bearings provide smooth rotation. A 36 x 52" / 914.4 x 1,320.8 mm footprint and four-side forklift access make it ideal for large, heavy jobs. Shipping weight is 264.60 lbs / 120.00 kg.

PART NO 3802



MEGA ROLLER STAND - 15,000 LBS / 7.5 US TON

Weight Capacity: 15,000 lbs / 6,800 kg
Pipe Size Capacity: 4 - 60" / 101.6 - 1,524 mm
Working Height: 25 - 35" / 635 - 889 mm

Built for extreme loads, the 15,000 lbs / 6,800 kg B&B SUMNER Mega Roller Stand features increased headstock width and extra wheels. It supports pipes from 4 - 60" / 101.6 - 1,524 mm with a working height of 25 - 35" / 635 - 889 mm. The base measures 36 x 52" / 914.4 x 1,320.8 mm and includes four heavy-duty 10 x 3" wheels. Powder coating ensures high visibility and durability. Total shipping weight is 349.90 lbs / 158.70 kg.

PART NO 3808



MEGA POWER ROLLER DRIVER

Weight Capacity: 4 tons / 8,000 lbs / 3,628 kg
Pipe Size Capacity: 3 - 48" / 76 - 1,219 mm
Working Height: 31 - 48" / 787.4 - 1,219.2 mm

The B&B SUMNER Mega Power Roller Driver is designed for rotating medium-to-large cylindrical vessels. It supports up to 8,000 lbs / 3,629 kg per unit and accommodates pipe diameters of 3 - 48" / 76 - 1,219 mm. With a torque of 2,000 in-lbs and a speed range of 8 - 80" / 203 - 2,032 mm per minute, it ensures precise, powerful rotation. Powered by a 0.3 HP motor and operating at 110V/60Hz, this unit weighs 240 lbs / 109 kg.

PART NO 3810



POWER ROLLER IDLER

Weight Capacity: 4 tons / 8,000 lbs / 3,628 kg
Pipe Size Capacity: 3 - 48" / 76 - 1,219 mm
Working Height: 31 - 48" / 787.4 - 1,219.2 mm

The Power Roller Idler complements the mega power roller driver, offering balanced support during vessel rotation. It supports up to 8,000 lbs / 3,629 kg and handles pipe diameters from 3 - 48" / 76 - 1,219 mm. Height adjustable from 28 - 40" / 711 - 1,016 mm, it provides flexibility for diverse applications. Matching the driver's torque and speed, this 150 lbs / 68 kg unit ensures steady, controlled movement.

PART NO 3812



MEGA SAWHORSE

Weight Capacity: 12,000 lbs / 5,443 kg
Working Height: 36" / 914.4 mm

Designed for industrial loads, the B&B SUMNER Mega Sawhorse supports up to 12,000 lbs / 5,443 kg. Powder coated and bolt together with a 60 x 37 x 36" / 1,524 x 939.8 x 914.4 mm dimension, it features a 5 x 3" / 120 x 75 mm I-beam top and 1.5 x 3" / 40 x 80 mm legs.

The Mega Sawhorse is offered in a smart flat-pack packaging and is therefore easy to transport and store with a shipping weight of just 172 lbs / 78 kg.

PART NO 3820



TRI-STAND CHAIN VICE

Weight Capacity: 1,000 lbs / 450 kg
Pipe Size Capacity: 0.125 - 6" / 3 - 152 mm
Working Height: 35" / 889 mm

The B&B SUMNER Tri-Stand Chain Vice is a foldable, portable solution for pipe clamping. With a capacity of 1,000 lbs / 450 kg and pipe diameters up to 6" / 152 mm, it stands at 35" / 889 mm with a width of 55" / 1,397 mm. Its cast-aluminum head, heavy-duty legs, and integrated tool shelf provide functionality and stability on uneven surfaces. Shipped fully assembled.

Available in a crate of 20 pieces (**PART NO 6100x20**)

PART NO 6100



PIPE CHAIN VICE BENCH CLAMP

Weight Capacity: 1,000 lbs / 450 kg
Pipe Size Capacity: 0.25 - 6" / 6 - 152 mm

The B&B SUMNER Pipe Chain Vice Bench Clamp offers strong bench-mounted clamping for pipes ranging from 0.25 - 6" / 6 - 152 mm. Supporting loads up to 1,000 lbs / 450 kg, it features hardened jaws and a cast iron body for long-lasting use. Ideal for welding, threading, and cutting, it delivers precision and holding power in a compact form.

PART NO 90041



REEL JACKS

Weight Capacity: 2,500 lbs / 1,135 kg
Reel Diameter Size: 26 - 96" / 660.4 - 2,438.4 mm
Reel Jack Adjustable Height: 13 - 54" / 330 - 1,370 mm

B&B SUMNER Reel Jacks are heavy-duty reel supports with models supporting up to 2,500 lbs / 1,135 kg. Adjustable between 13 - 54" / 330 - 1,370 mm, they include a double locking pin system and 1.5" ACME-thread. Compatible with B&B SUMNER spindles, they offer stability and precision for cable reel handling.

PART NO 4900

Reel Diameter Size: 26 - 56" / 660.4 - 1,422.4 mm
Reel Jack Adjustable Height: 13 - 27" / 330 - 686 mm

PART NO 4901

Reel Diameter Size: 46 - 96" / 1,168.4 - 2,438.4 mm
Reel Jack Adjustable Height: 21 - 54" / 533 - 1,370 mm



WELDERS STOOL

Weight Capacity: 300 lbs / 135 kg
Working Height: 15 - 22" / 380 - 560 mm

The B&B SUMNER Welders Stool is built for comfort and durability during long welding sessions. With a height range of 15 - 22" / 380 - 560 mm and a 300 lbs / 135 kg weight capacity, it features a stamped steel seat with ventilation holes. Its steel frame, quick-adjust height mechanism, and compact design make it ideal for both shop and site use.

Available in a crate of 25 pieces (**PART NO WS1x25**)

PART NO WS1



BABY PIPE BUGGY

Weight Capacity: 1,000 lbs / 450 kg

Pipe Size Capacity: up to 12"

Maximum Transport Length: 20 ft / 6,096 mm

The B&B SUMNER Baby Pipe Buggy transports pipes up to 20' / 6,096 mm long and 12" / 305 mm diameter, with a load capacity of 1,000 lbs / 450 kg. Dimensions are 28 x 28 x 21" / 711.2 x 711.2 x 533.4 mm. Featuring flat-free tires, ratchet strap, and a quick-disconnect handle, it simplifies material handling on-site. Weighs 116.80 lbs / 53 kg.

PART NO 2013 OLD BB PART NO 2013



BIGGY PIPE BUGGY

Weight Capacity: 2,000 lbs / 900 kg

Pipe Size Capacity: up to 20"

Maximum Transport Length: 24 ft / 7,315 mm

The B&B SUMNER Biggy Pipe Buggy is engineered for handling long, heavy pipe loads up to 20' / 6,096 mm in length. It has a load capacity of 2,000 lbs / 900 kg and can carry pipes up to 24" / 610 mm in diameter. Featuring a larger frame than the Baby Pipe Buggy, it provides enhanced balance and durability. Equipped with industrial flat-free tires, heavy-duty ratchet straps, and a quick-attach/detach handle system, this cart is ideal for transporting oversized pipe bundles across job sites safely and efficiently. The rugged steel construction ensures long-lasting use in rough environments.

PART NO 2014 OLD BB PART NO 2014



PIPE STACKER CART

Weight Capacity: 2,000 lbs / 900 kg

Pipe Size Capacity: up to 36"

Maximum Transport Length: 24 ft / 7,315 mm

The Pipe Stacker Cart from B&B SUMNER is designed for efficient storage and transport of multiple pipes on job sites or in shops. It accommodates varying pipe lengths and diameters and is built with multiple steel tiers for vertical stacking. The cart includes locking caster wheels and a rugged steel frame for high load stability and mobility. Its compact, multi-level design improves workflow and minimizes handling time in pipe storage and fabrication settings.

PART NO PSC2 OLD BB PART NO 2015-6F



CONDUIT STACKER CART 1 & 2

Weight Capacity: 1,000 lbs / 450 kg

B&B SUMNER's Conduit Stacker Carts 1 & 2 provide efficient mobile solutions for organizing and moving conduit material. With layered stacking arms and a heavy-duty steel base, these carts are tailored to maintain separation between different conduit sizes. They enhance site efficiency, reduce damage during transport, and allow for clear identification of inventory. Equipped with locking wheels, they are easily maneuvered across shop floors and construction zones.

PART NO CSC1 - WITHOUT MESH FLOOR OLD BB PART NO 2033-4E

PART NO CSC2 - WITH MESH FLOOR OLD BB PART NO 2033-4F



HANGER STACKER CART 1 & 2

Weight Capacity: 1,000 lbs / 450 kg

The Hanger Stacker Cart 1 & 2 from B&B SUMNER are engineered for storing and moving pipe hangers and related components. Built with tiered arms and a solid steel platform, the carts allow quick access and transport of hanging hardware. Their vertical layout optimizes space usage, while heavy-duty casters provide smooth movement even when fully loaded. These carts are critical for mechanical and electrical installations where organization and mobility are key.

PART NO HSC1 - WITHOUT MESH FLOOR OLD BB PART NO 2036-4E

PART NO HSC2 - WITH MESH FLOOR OLD BB PART NO 2036-4F



BUNDLE STACKER CART

Weight Capacity: 1,000 lbs / 450 kg

B&B SUMNER's Bundle Stacker Cart is ideal for transporting grouped pipe or conduit bundles safely and efficiently. Its design includes tiered stacking levels and strong steel supports to prevent material shifting. With a wide footprint for stability and locking casters for control, this cart ensures secure movement of bundled items throughout a worksite. It is an indispensable asset for handling large quantities of piping in fabrication or warehouse environments.

PART NO BSC1 - WITHOUT MESH FLOOR OLD BB PART NO 2031-4E

PART NO BSC2 - WITH MESH FLOOR OLD BB PART NO 2031-4F



STORAGE STACKER CART

Weight Capacity: 1,500 lbs / 680 kg

The Storage Stacker Cart from B&B SUMNER is a versatile and mobile unit for organizing tools, materials, and fittings on job sites. Featuring durable steel shelves and dividers, it allows efficient categorization and transport of various small parts. The cart's compact design, combined with robust casters, enables smooth navigation in busy work environments while maintaining a high load capacity for extended operational use.

PART NO SSC1 OLD BB PART NO 2034-4



STOR CAGE CART

Weight Capacity: 1,000 to 1,500 lbs / 453 to 680 kg

The Stor Cage Cart is a lockable, high-security storage solution from B&B SUMNER for safeguarding tools, equipment, and materials. Its heavy-duty steel mesh frame ensures visibility while deterring unauthorized access. Large caster wheels and reinforced corner braces support high-weight loads. Ideal for both indoor and outdoor use, this cart combines mobility with protection, making it valuable for contractors operating in shared or unsecured environments.

PART NO SCC48 (Stor Cage Cart 48")

PART NO SCC60 (Stor Cage Cart 60")



SINGLE CYLINDER CARTS

Gas cylinder: up to 8" / 203 mm (model 108) and up to 12" / 305 mm (model 112) diameter

B&B SUMNER Single Cylinder Carts are compact and ergonomic transport tools for gas cylinders used in welding and fabrication. Designed for one-cylinder capacity, they feature reinforced frames, solid rubber tires, and secure chain straps to prevent shifting. These carts are lightweight yet rugged, ensuring safe handling of gas cylinders in shops or mobile operations. Perfect for tight workspaces and quick relocation of individual tanks.

FOR ALL WHEEL OPTIONS AND PART NUMBERS, PLEASE SCAN THE PRODUCT QR CODE



DOUBLE CYLINDER CARTS

Gas cylinder: up to 13" / 33cm (Model 213) or 9" / 23 cm (Model 209) diameter

The Double Cylinder Carts by B&B SUMNER offer stable transportation of two gas cylinders. Constructed with a reinforced steel frame, these carts feature dual compartments, heavy-duty rubber wheels, and safety chains to secure tanks. Ideal for operations requiring simultaneous use of oxygen and acetylene or similar combinations, they improve site safety and mobility for welders and pipefitters.

FOR ALL WHEEL OPTIONS AND PART NUMBERS, PLEASE SCAN THE PRODUCT QR CODE



MATHEY DEARMAN was originally founded in the United States in the 1930's and is headquartered in Tulsa, OK. During the first decades, founder C.A Mathey developed patented saddle-type portable pipe cutting and bevelling machines and clamping, pipe alignment and reforming systems for pipes. **MATHEY DEARMAN** rapidly became a worldwide recognized authority in pipe rigging equipment and is still today setting the benchmark and being the point of reference for many applications.

With the merger in 2019 of B&B Pipe and Industrial Tools LLC (USA), **MATHEY DEARMAN Inc.** (USA) and TAG Pipe Equipment Specialists (UK) and the recent addition in 2022 of AXXAIR (France) into Specialized Fabrication Equipment (S.F.E.) Group, the various product groups offered by the original manufacturers have been realigned and integrated into the overall S.F.E. Group range of pipe cutting and pipe alignment equipment while keeping their own brand identity.

The **MATHEY DEARMAN** brand portfolio consists of a comprehensive range of pipe fitting equipment, pipe flame cutting and bevelling machines, pipe alignment and reforming clamps and pipe rigging equipment.

MATHEY DEARMAN products are always nearby available within the S.F.E. Group global network and can be consulted on the dedicated website: www.MATHEY.com





E-Z PIPECUT MANUAL

4.5 - 24" / 114 - 600 mm

The MATHEY DEARMAN E-Z Pipecut Manual is a compact, chain-driven pipe cutter designed for 4.5 - 24" / 114 - 600 mm pipes. Ideal for wall thicknesses from 0.197 - 2" / 5 - 50 mm, it offers smooth manual operation with a quick-release clutch for fast setup. A low gear ratio ensures precise cuts and variable bevel angles up to 45°. Lightweight, durable, and easy to use, it's perfect for site and shop use alike. Machines delivered with a universal nozzle-mix torch suitable for all nozzle-mix cutting nozzles (nozzles not included).

PART NO EZPCM



E-Z PIPECUT AUTO

4.5 - 24" / 114 - 600 mm

The MATHEY DEARMAN E-Z Pipecut Auto offers automated pipe cutting and beveling for 4.5 - 24" / 114 - 600 mm diameters. Powered by 110/230V, it supports hands-free operation with remote speed control and accurate 45° bevels. Suitable for wall thicknesses from 0.197 - 2" / 5 - 50 mm, it can also be adapted for plasma cutting. Built for repetitive, high-volume tasks, MATHEY DEARMAN's Auto model maximizes efficiency while maintaining cut quality across various pipe materials. Machines delivered with a universal nozzle-mix torch suitable for all nozzle-mix cutting nozzles (nozzles not included).

PART NO EZPCA1 (110v) / PART NO EZPCA2 (220v)



E-Z PIPECUT MAGNETIC

9" / 230 mm and up

MATHEY DEARMAN's E-Z Pipecut Magnetic delivers electric-driven cutting precision for pipes from 9" / 230 mm upward. Its magnetic rollers offer over 110 lbs / 50 kg of holding force, ensuring consistent torch tracking. Supporting bevels up to 45° and wall thicknesses from 0.197 - 2" / 5 - 50 mm, this machine is compact yet powerful. It's ideal for both workshop and field use, offering clean, repeatable cuts even on vertical or out-of-position pipes. Machines delivered with a universal nozzle-mix torch suitable for all nozzle-mix cutting nozzles (nozzles not included).

PART NO EZPCMAG1 (110v) / EZPCMAG2 (220v)



BAND CRAWLER CUTTING AND BEVELLING MACHINE

10 - 60" / 254 - 1,524 mm o/d

The MATHEY DEARMAN Band Crawler excels in tight spaces, cutting pipes from 10 - 60" / 254 - 1,524 mm with as little as 10.5" / 267 mm clearance. Its flexible stainless steel band adapts to out-of-round pipe, maintaining uniform cut quality. With manual and PLASMASPEED motorized options, it increases efficiency up to 60%. Easy to operate and highly portable, it's the go-to tool for large-diameter, vertical, or hard-to-access pipe jobs. The machine is delivered without torch (torch carrier assembly for torch diameter of 1.375" / 35 mm) and nozzles.

FOR ALL SIZES AND PART NUMBERS, PLEASE SCAN THE PRODUCT QR CODE



SADDLE MACHINE MOTORIZED / MANUAL

1.5 - 48" / 38 - 1,219 mm o/d

The MATHEY DEARMAN Saddle Machine offers manual or motorized cutting for pipes 1.5 - 48" / 38 - 1,219 mm. Lightweight, durable, and fast, it's perfect for precise pipe cuts and bevels. The manual model is ideal for basic jobs, while the motorized PLASMASPEED version adds speed and control using 110/230V power. Both options cut cleaner and faster than hand tools, with optional torch arms and spacers for added versatility in the field or shop. The machine is delivered without torch (torch carrier assembly for torch diameter of 1.375" / 35 mm) and nozzles.

FOR ALL SIZES AND PART NUMBERS, PLEASE SCAN THE PRODUCT QR CODE

* ACCESSORIES ARE AVAILABLE TO CUT CERTAIN SHAPES (ATTACHMENT + TEMPLATE)



STURDI PIPE CHAIN CLAMP

1 - 72" / 33.4 - 1,827 mm o/d

The MATHEY DEARMAN Sturdi Pipe Chain Clamp is a robust solution for precision pipe alignment and reforming on pipes ranging from 1 - 72" / 33.4 - 1,827 mm. Designed as a lighter-duty counterpart to the Double Jackscrew Pipe Chain Clamp, it excels in aligning and reforming schedule 40 and lighter pipe walls. The clamp's stainless steel jackbars, jackscrews, and main block ensure strength, corrosion resistance, and long service life. Its high-rise jackbars allow welders full access around the pipe, enabling welding with the clamp in place. Adaptable to elbows, tees, flanges, and end caps, it offers versatility across applications. The clamp aligns internal and external pipe diameters within 0.5 mm, ensuring precise fit-up. Available in carbon steel or stainless steel chain options, the MATHEY DEARMAN Sturdi Pipe Chain Clamp provides reliability and consistency, particularly when paired with its optional level and support device for added control during setup. It's an essential tool for pipe fitters and welders seeking performance and dependability.

FOR ALL SIZES AND PART NUMBERS, PLEASE SCAN THE PRODUCT QR CODE



DOUBLE JACKSCREW PIPE CHAIN CLAMP

4 - 72" / 114.3 - 1,827 mm o/d

The MATHEY DEARMAN Double Jackscrew Pipe Chain Clamp is a robust, field-proven solution for aligning and reforming pipe from 4 - 72" / 114.3 - 1,827 mm in diameter. It aligns pipe with wall thicknesses up to Schedule 80 and reforms Schedule 40 pipe by eliminating 'Hi-Lo' conditions through precision-placed double jackscrews. Constructed with stainless steel jackscrews, jackbars, and main blocks, it ensures durability and corrosion resistance. Carbon or stainless steel chain options help prevent material contamination during specialty alloy welding. The clamp supports elbows, tees, and various pipe fittings, offering extra welding clearance so it can remain in place during full weld completion. For enhanced setup accuracy and secure pipe handling, an optional level and support device is available.

FOR ALL SIZES AND PART NUMBERS, PLEASE SCAN THE PRODUCT QR CODE

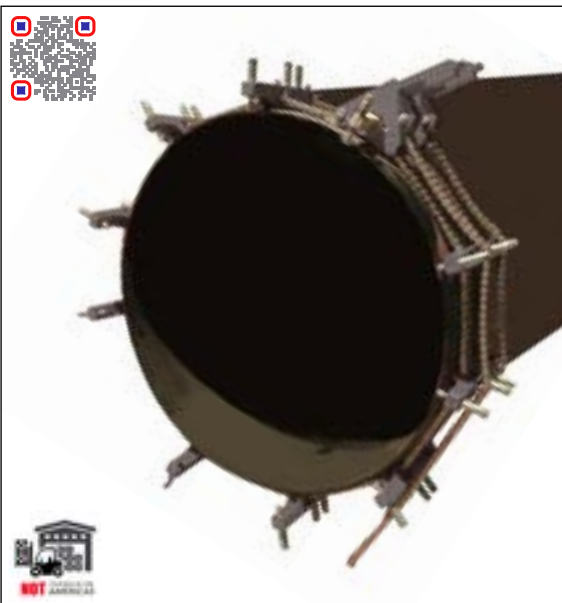

E-Z FIT DOUBLE PIPE CHAIN CLAMP

10 - 240" / 273 - 6,100 mm o/d

The MATHEY DEARMAN E-Z Fit Double Pipe Chain Clamp is engineered for extreme alignment and reforming demands on pipes and vessels from 10 - 240" / 273 - 6,100 mm in diameter. Built for schedule 80 reforming and capable of aligning heavier walls, it features triple jackscrews per jackbar and dual locking chain devices for maximum clamping force and control. Stainless steel models are available to support welding on exotic materials without contamination. This ultra-heavy-duty clamp can align complex pipe fittings - elbows, tees, flanges - with superior precision. Optional torque wrenches ensure consistent chain tension for repeatable results. Larger models incorporate cable hoists, while others include a level and support device. Supplied with heavy-duty storage cases and a range of optional accessories, the E-Z Fit Double Pipe Chain Clamp handles jobs others can't. When the task demands exceptional strength, adaptability, and reliability, MATHEY DEARMAN's E-Z Fit Double Pipe Chain Clamp is the go-to for professional pipefitters across heavy industry.

FOR ALL SIZES AND PART NUMBERS, PLEASE SCAN THE PRODUCT QR CODE



DOUBLE PIPE CHAIN CLAMP

10 - 240" / 273 - 6,100 mm o/d

The MATHEY DEARMAN Double Pipe Chain Clamp is a heavy-duty alignment and reforming tool designed for pipes and vessels ranging from 10 - 240" / 273 - 6,100 mm in diameter. Engineered for tough applications, it aligns pipe up to Schedule 160 and reforms up to Schedule 80 using numerous independent jackbars and high-strength chain. Its robust construction includes stainless steel jackbars, jackscrews, and main blocks, ensuring performance on uneven or out-of-round surfaces. Available in carbon or stainless steel versions, it is ideal for precise alignment of elbows, tees, and fittings. Larger models include a hydraulic closure mechanism or cable hoist for enhanced clamping power. The clamp remains in place during welding, improving efficiency and weld quality.

FOR ALL SIZES AND PART NUMBERS, PLEASE SCAN THE PRODUCT QR CODE



RIM CLAMP

4 - 60" / 114.3 - 1,524 mm

The MATHEY DEARMAN Rim Clamp is a powerful reforming solution for pipes ranging from 4 - 60" / 114.3 - 1,524 mm in diameter. Designed for heavy-duty applications, it delivers high clamping pressure using symmetrically spaced jackscrews to reform pipe out-of-round conditions up to 2" / 51 mm. Ideal for 100% weld and grind jobs, the clamp allows continuous pressure throughout the welding process without removal. All contact surfaces are stainless steel, making it suitable for use on carbon steel, stainless steel, and alloy pipes. Its split-frame, self-latching design ensures quick and safe installation, even on larger pipe diameters. The Rim Clamp is available in standard and Mega sizes, offering exceptional strength and versatility for demanding industrial fabrication tasks.

FOR ALL SIZES AND PART NUMBERS, PLEASE SCAN THE PRODUCT QR CODE



SUPER CLAMP

6 - 36" / 152.4 - 914.4 mm

The MATHEY DEARMAN Super Clamp is a robust, heavy-duty clamp designed for reforming and aligning pipe from 4 - 60" / 114.3 - 1,524 mm. It can correct out-of-round conditions up to 2" / 51 mm, reform pipes up to schedule 40, and align up to schedule 80. This clamp features a split-frame design, multiple jackscrews with swivel pads, and stainless steel contact surfaces - making it compatible with carbon steel, stainless, and alloy materials. Each clamp covers a range of sizes, improving job site flexibility. Whether for new installations or repairs, MATHEY DEARMAN's Super Clamp ensures pipe joints are aligned securely and accurately, every time.

FOR ALL SIZES AND PART NUMBERS, PLEASE SCAN THE PRODUCT QR CODE

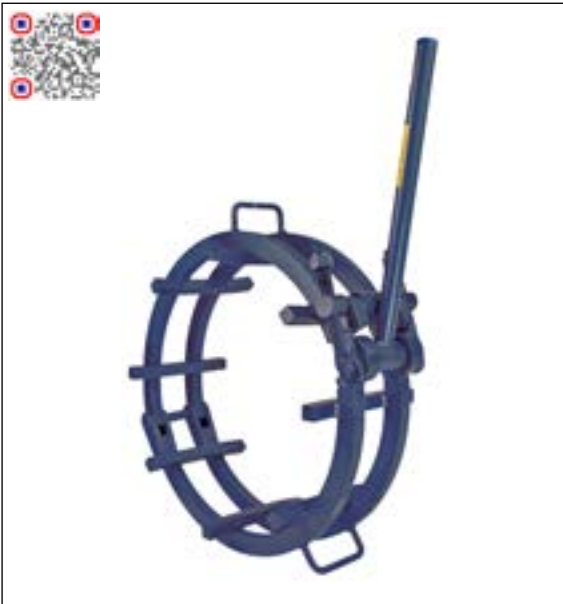

MANUAL LEVER CAGE CLAMP

2 - 60" / 60.3 mm - 1,524 mm

The MATHEY DEARMAN Manual Lever Cage Clamp is an efficient alignment tool for pipes ranging from 2 - 60" / 60.3 - 1,524 mm, suitable for wall thicknesses up to schedule 80. Its lever-driven mechanism allows fast setup, ideal for both field and shop use. Available in tack and no-tack designs, the tack model supports spot welding, while the no-tack version features arched crossbars for full-circle welding access without removal. Each clamp is made for a specific pipe size to ensure precise alignment. Stainless steel models are available for working with specialty alloys. Compact, lightweight, and durable, the Manual Lever Cage Clamp delivers consistent, professional-grade results on every job.

FOR ALL SIZES AND PART NUMBERS, PLEASE SCAN THE PRODUCT QR CODE

2 - 24" INTERNATIONALLY STOCKED

2 - 60" ONLY STOCKED IN THE AMERICAS



RATCHET CAGE CLAMP

6 - 60" / 168.2 mm - 1,524 mm

The MATHEY DEARMAN Ratchet Cage Clamp delivers enhanced clamping force for aligning pipes sized 6 - 60" / 168.2 - 1,524 mm. It's ideal for applications requiring greater torque than manual clamps can provide, making it perfect for heavy-duty pipe fabrication. Supporting wall thicknesses up to schedule 80, this clamp is available in both tack and no-tack configurations. The ratchet mechanism ensures controlled, high-force alignment and is paired with ratchet handles of varying torque sizes (sold separately). Each unit fits a specific pipe diameter, and stainless steel options are available for alloy and corrosion-sensitive work. For precision and reliability in challenging pipe alignment tasks, MATHEY DEARMAN's ratchet model is a dependable industry standard.

FOR ALL SIZES AND PART NUMBERS, PLEASE SCAN THE PRODUCT QR CODE



HYDRAULIC CAGE CLAMP

16 - 60" / 406 - 1,524 mm

The MATHEY DEARMAN Hydraulic Cage Clamp provides powerful, high-pressure pipe alignment for sizes 16 - 60" / 406 - 1,524 mm. Its hydraulic closure system applies uniform clamping force, ideal for aligning pipes up to schedule 80 wall thickness. Designed for large-diameter pipe fit-ups, it's available in tack and no-tack versions - the latter supporting full weld access without removal. The hydraulic system ensures quick clamping and safe, consistent pressure distribution. Each clamp is sized specifically per pipe diameter, and stainless steel versions accommodate exotic or corrosion-sensitive materials. MATHEY DEARMAN's Hydraulic Cage Clamp is a vital solution for industrial installations and demanding field operations where strength and accuracy are essential.

FOR ALL SIZES AND PART NUMBERS, PLEASE SCAN THE PRODUCT QR CODE



SLINGS AND CRADLES

2 - 36" / 50.8 - 914 mm

The MATHEY DEARMAN Slings and Cradles are engineered for safe, efficient pipe handling across diameters from 2 - 36" / 50.8 - 914 mm, making them essential for pipeline construction and jobsite operations. Each unit features high-durability 4" / 101.6 mm urethane wheels with sealed anti-friction bearings, designed to protect pipe coatings while rolling smoothly over uneven terrain. Load capacities range up to 56,700 lbs / 25,700 kg with options including 3 to 7 roller configurations and 2 - or 4 - strand cradle styles. These assemblies are constructed with 3/8" swaged wire rope, and all spreader bar designs are third-party tested for compliance and safety. From lightweight slings to heavy-duty pipe cradles, every MATHEY DEARMAN model supports secure, balanced lifting and stable pipe positioning. Easy to deploy and built for repeated use, MATHEY DEARMAN Slings and Cradles deliver reliability, safety, and efficiency under tough field conditions - making them a go-to solution for pipeline contractors worldwide.

FOR ALL SIZES AND PART NUMBERS, PLEASE SCAN THE PRODUCT QR CODE



PIPE LAUNCHERS

2 - 60" / 50.8 - 1,524 mm

MATHEY DEARMAN Pipe Launchers provide a robust, adaptable platform for safely deploying and supporting pipes from 2 - 60" / 50.8 - 1,524 mm in field welding, fabrication, and directional drilling operations. Built for durability, each launcher features replaceable urethane roller wheels, safety carry handles, and a modular design for easy transformation between launcher and beam roller setups. Standard models accommodate 2,500 - 10,000 lbs / 1,100 - 4,540 kg, while heavy-duty versions handle up to 20,000 lbs / 9,070 kg. Rollers can be quickly reconfigured to meet varied field requirements, and the clamp mechanism fastens securely to I-beams or mounting stands. Launchers nest and stack for efficient storage and transport, saving space between job sites. With compatibility across a wide range of pipe diameters, MATHEY DEARMAN Pipe Launchers ensure productivity and control while minimizing handling risks. Rugged and field-tested, they're ideal for contractors seeking dependable pipe support solutions in high-mobility environments.

FOR ALL SIZES AND PART NUMBERS, PLEASE SCAN THE PRODUCT QR CODE



BEAM CLAMP ROLLERS

2 - 60" / 60.3 - 1,524 mm

The MATHEY DEARMAN Beam Clamp Rollers are designed for quick, stable pipe handling in tight, elevated, or industrial environments. Supporting pipe diameters from 2 - 60" / 60.3 - 1,524 mm, these rollers attach directly to I-beams with secure dual-flange clamping and can be installed or repositioned in seconds. Available in standard and heavy-duty versions, they support loads from 1 - 10 tons / 2,240 - 22,400 lbs / 1,016 - 10,160 kg, depending on model. Urethane-coated wheels protect pipe surfaces while sealed bearings ensure smooth rolling action. Each unit includes safety features like integrated carry handles and a standard safety leash for secure handling at height. Easily replaceable components and modular roller heads make servicing straightforward. Whether used in pipe rack installations, refineries, or plant projects, MATHEY DEARMAN Beam Clamp Rollers offer unmatched flexibility and strength for overhead or elevated pipe support applications, giving operators reliable control with minimal setup time.

FOR ALL SIZES AND PART NUMBERS, PLEASE SCAN THE PRODUCT QR CODE



FIT-UP PRO is a specialized brand within the S.F.E. Group portfolio, dedicated to providing high-quality tools and equipment for welding fit-up, alignment, and pipe fabrication. Known for its precision-engineered solutions and robust performance in the field, **FIT-UP PRO** supports professional welders and fabricators across industries such as oil & gas, shipbuilding, construction, and manufacturing.

Following the strategic acquisition of Sumner Manufacturing in 2025, a renowned name in lifting and welding tools, the **FIT-UP PRO** product portfolio has significantly expanded and strengthened, broadening its offering and enhancing its ability to meet the diverse needs of modern fabrication environments.

Today, **FIT-UP PRO** offers a comprehensive range of pipe clamps, alignment tools, flange spreaders, spacing wedges, and other essential equipment designed to improve job site and workshop productivity, ensure safety, and deliver consistent fit-up accuracy. Every product reflects the S.F.E. Group's commitment to innovation, quality, and supporting tradespeople with the right tools to get the job done right.

With global availability through the S.F.E. Group's extensive distribution network, **FIT-UP PRO** is the go-to brand for fit-up and welding professionals seeking reliable, performance-driven solutions.

FIT-UP PRO's products are always nearby available within the S.F.E. Group global network and can be consulted on the dedicated website: www.FIT-UP-PRO.com





ULTRA CLAMPS

1 - 14" / 25 - 370 mm o/d

The FIT-UP PRO Ultra Clamps offer durable, cost-effective pipe alignment for diameters ranging from 1 - 14" / 25 - 370 mm. Featuring a proven ACME-thread design, they're ideal for pipe-to-pipe, pipe-to-elbow, and pipe-to-flange fit-ups. Each clamp includes stainless steel feet and ball-tipped wing nuts, allowing safe use on stainless steel without additional accessories. Lightweight construction enhances overhead usability, while the robust frame ensures longevity. These clamps are available in three sizes with weights ranging from 4 - 18 lbs / 1.80 - 8.20 kg, making them a versatile and contamination-free solution for reliable pipe alignment in fabrication settings.

1220 * : 1 - 3" / 25 - 90 mm (MATHEY QFC12) OLD SUMNER PART NO 781130

1221 * : 2 - 6" / 50 - 170 mm (MATHEY QFC26) OLD SUMNER PART NO 781150

1222 * : 6 - 14" / 165 - 370 mm (MATHEY QFC512) OLD SUMNER PART NO 781170

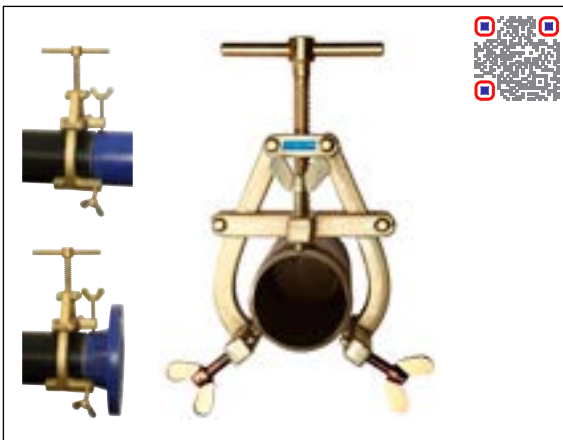

E-Z FIT GOLD PIPE CLAMPS

1 - 14" / 25 - 370 mm o/d

The E-Z Fit Gold Pipe Clamps by FIT-UP PRO are forged for strength and performance in pipe welding applications. Engineered for sizes 1 - 14" / 25 - 370 mm, these heavy-duty clamps feature galvanized forged steel construction for long-lasting durability in the field. Five overlapping size options provide maximum flexibility, while optional stainless steel contact covers eliminate contamination on sensitive jobs. Perfect for pipe-to-pipe, elbow, and flange connections, E-Z Fit Gold stands out as the market's most robust high-low fit-up clamp. These clamps are not lifting devices and should be used with separate supports.

EZG3 : 1 - 3" / 20 - 90 mm

EZG5 : 2 - 5" / 50 - 150 mm

EZG7 : 3 - 7" / 90 - 195 mm

EZG9 : 5 - 9" / 125 - 245 mm

EZG14 : 9 - 14" / 225 - 370 mm

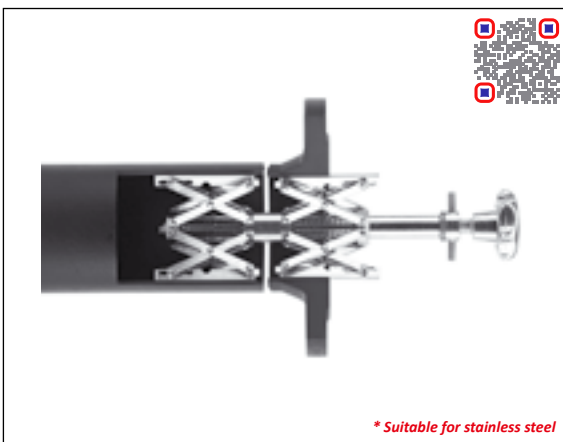

SPIDER CLAMP - SERIES 400

2 - 36" (54 - 940 mm) i/d

FIT-UP PRO's Spider Clamp - Series 400 offers precision alignment for two hollow cylindrical components of different diameters. With independent expanding clamps for each part, the tool ensures secure clamping from 2 - 36" / 54 - 940 mm internal diameter. Made with stainless steel locating rails, it's ideal for heavy components such as flanges and elbows. A bottom knob sets the pipe clamp, while a top hand-bar secures the mating part. The Spider Clamp 400 series is a specialized, stainless-compatible solution for challenging pipe alignment needs, streamlining welding setups and reducing time on heavy jobs.

400-1 SS * : 2 - 6" / 54 - 140 mm OLD SUMNER PART NO 784100

400-2 SS * : 4 - 8" / 85 - 220 mm OLD SUMNER PART NO 784102

400-3 SS * : 6 - 14" / 120 - 350 mm OLD SUMNER PART NO 784103

400-4 SS * : 8 - 20" / 180 - 520 mm

400-5 SS * : 16 - 36" / 400 - 940 mm

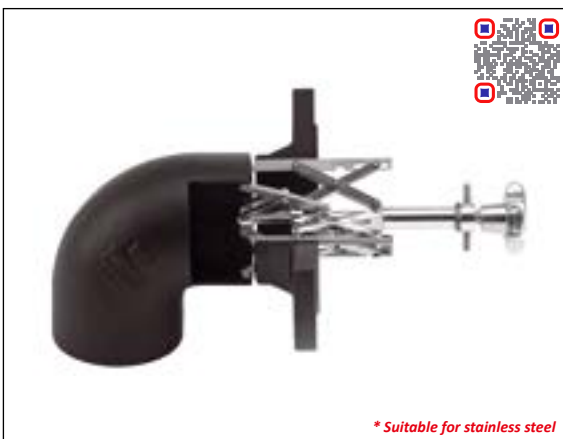

ELBOW SPIDER CLAMP - SERIES 500

2 - 12" (54 - 315 mm) i/d

The FIT-UP PRO Elbow Spider Clamp - Series 500 is engineered for aligning flanges to elbows and pipe bends of varying diameters. It features two independent expanding clamps: the lower secures inside the bend, while the upper aligns the flange using a hand-bar mechanism. Constructed with stainless steel components, it's ideal for use on exotic materials. Available in three sizes, it covers clamping ranges from 2 - 12" / 54 - 315 mm and weighs between 2.53 - 21.16 lbs / 1.15 - 9.60 kg. This tool ensures accurate, stable alignment for complex pipe configurations in industrial settings.

500-1 SS * : 2 - 4" / 54 - 115 mm

500-2 SS * : 4 - 7" / 85 - 195 mm

500-3 SS * : 6 - 12" / 120 - 315 mm



SCISSOR CLAMP - SERIES 100

½ - 12" (10 - 330 mm) i/d

The FIT-UP PRO Scissor Clamp - Series 100 offers fast, accurate alignment for pipes of equal or differing diameters on a common centerline. Designed with automatic diameter compensation, it eliminates the need for manual adjustments, making setup quick and efficient. Its open design keeps all welding areas accessible. Constructed with stainless steel for compatibility with exotic materials, it is available in three sizes covering ½ - 12" / 10 - 330 mm and weighs between 4.85 - 55 lbs / 2.20 - 25.00 kg. This clamp is ideal for field and shop applications requiring reliable and repeatable pipe alignment.

100-1 SS * : ½ - 3" / 10 - 70 mm

100-2 SS * : 1.5 - 5" / 40 - 140 mm

100-3 SS * : 2.5 - 12" / 75 - 330 mm



SPACING WEDGES

FIT-UP PRO Spacing Wedges are designed to create precise weld gaps and improve the overall accuracy of pipe fit-ups. These wedges are essential accessories when using MATHEY DEARMAN clamps. Their case-hardened wedge portion ensures durability, while the softer upper part minimizes the risk of splintering during use. Common dimensions include 4 x 0.75 x 0.25" / 102 x 19 x 6.4 mm, 3.5 x 1.5 x 0.25" / 89 x 38 x 6.4 mm, and 8 x 1.5 x 0.25" / 203 x 38 x 6.4 mm. To use, simply align the pipe ends, secure a chain or cage clamp, and insert the spacing wedge to achieve the desired gap. These wedges allow for efficient and repeatable alignment without compromising material integrity, making them a staple for professional welders seeking precision, speed, and reliability in weld preparation.

PART NO D274

PART NO D272

PART NO D271



ROTARY EARTH CLAMP

The FIT-UP PRO Rotary Earth Clamp is a compact, innovative earthing solution designed to eliminate lead twisting, tangling, and premature wear during welding operations. Ideal for circumferential welding of pipes and fittings, it ensures a reliable ground connection to prevent defects like weld pinholes caused by poor earthing. Weighing only 4.0 lbs / 1.80 kg, the clamp is designed for quick attachment and detachment. It supports three connection methods - lug, clamp-on, and bare cable - providing flexible installation for a wide range of setups. Engineered with anti-arc bearings, the Rotary Earth Clamp handles loads up to 400 amps, offering both safety and performance. Compact enough to hang in your toolbox or clip to a belt, it's a must-have for mobile welding teams or job site fabricators. With its robust build and intuitive operation, this tool helps streamline workflow and improve weld quality in demanding environments.

PART NO REC1



PUSH-BUTTON CARBON STEEL FLANGE LINE UP PINS

The FIT-UP PRO Push-Button Carbon Steel Flange Line Up Pins are built for efficiency and longevity in flange alignment tasks. These innovative tools use a push-button release mechanism, allowing for rapid insertion and removal, which reduces setup time and increases productivity. Constructed from carbon steel with a black oxide coating, they resist corrosion and wear even in harsh environments. These pins accommodate flange holes ranging from $\frac{3}{8}$ - 1.875" / 16 - 47 mm, making them versatile for various flange types and sizes. The rugged ACME-thread design ensures reliable, long-term use, while the compact size allows for easy storage and transport. Supplied in pairs and blister-packaged for convenience, these pins are ideal for professional fabricators and welders who need dependable and quick alignment solutions. Whether on-site or in the workshop, these line up pins simplify the alignment process and reduce the risk of error during flange installations.

PART NO 2121 OLD SUMNER PART NO 781235

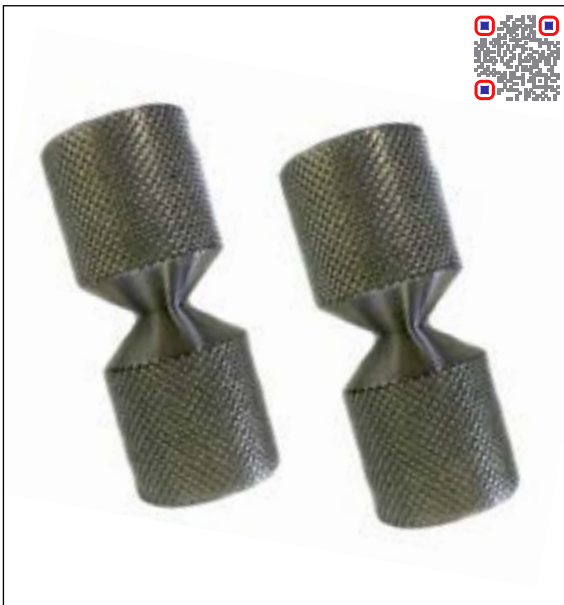

STAINLESS STEEL FLANGE PINS (PAIR)

The FIT-UP PRO Stainless Steel Flange Pins provide accurate and dependable flange alignment for precise fit-ups. Also known as "two hole pins," these tools are crafted from stainless steel, making them ideal for exotic material applications. Designed for flange holes from $\frac{1}{4}$ - $\frac{3}{8}$ " / 6.5 - 22 mm, they feature knurled handles for enhanced grip and tightening. Compact and efficient, they ensure correct flange positioning with minimal effort. These pins come in a convenient blister pack, ready to support professional fabricators on site or in the shop where alignment accuracy and repeatability are key.

This product comes in blister packaging.

PART NO 2124 OLD SUMNER PART NO 780429



FLANGE ALIGNMENT BOLTS (FAB BOLTS)

FIT-UP PRO Flange Alignment Bolts, or FAB Bolts, offer a safe and effective solution for aligning even the toughest flanges. Eliminating the need for hammers or wedges, the tapered shaft of each bolt easily adjusts misaligned bolt holes. Used in pairs, they reduce the risk of flange damage and speed up alignment tasks. The bolts are suited for various flange sizes and are supplied in a comprehensive kit. A must-have for pipefitters, FAB Bolts increase jobsite safety while delivering fast, repeatable results. All components follow imperial standards and are built for heavy-duty use.

PART NO FAB.KIT

* Imperial measurement



FLANGE SPREADER

The FIT-UP PRO Flange Spreader is a rugged, precision-engineered tool designed to safely separate pipe flanges during maintenance, installation, and inspection. It is suitable for flange diameters from 1 - 24" / 25 - 610 mm and supports pressure ratings between 150 - 1,500 lbs / 68 - 680 kg. The tool features a hardened steel wedge that delivers controlled spreading action, reducing the risk of damage to flanges or surrounding components. With four available models (ST-301 to ST-304), spread pin diameters range from 5/8 - 1", making it adaptable for various flange classes. The large feed screw allows smooth operation using either a 1 3/4" wrench or a 1/2" (12 mm) bar, ensuring flexibility even in confined spaces. Built with a compact, robust body for harsh industrial environments, this flange spreader provides repeatable, secure performance. It is a must-have for professionals who prioritize safety, precision, and durability in flange separation tasks.

PART NO 784003 OLD SUMNER PART NO ST-301

PART NO 784002 OLD SUMNER PART NO ST-302

PART NO 784000 OLD SUMNER PART NO ST-304

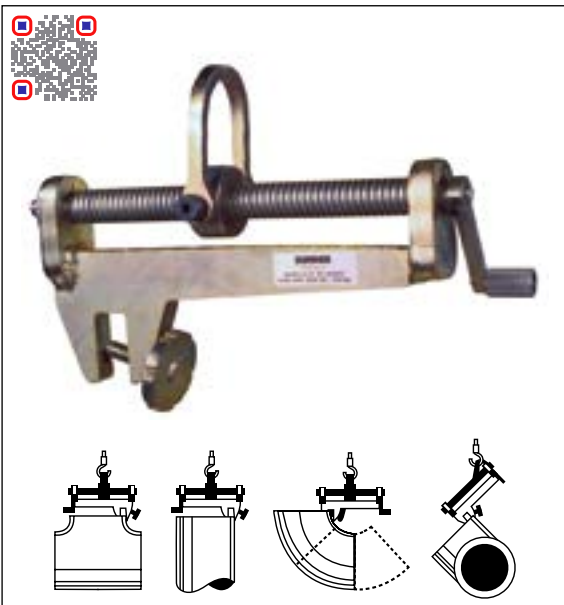

ADJUST-A-FIT™

The FIT-UP PRO Adjust-A-Fit™ is a gravity-assisted alignment tool designed to streamline one-person pipe and fitting alignment tasks, whether in the shop or on-site. Engineered for ease and precision, it can align fittings tilted up to 45 degrees and securely supports components weighing up to 1,000 lbs / 450 kg. Its compact, rugged design fastens directly to fittings, providing hands-free control and reducing the need for complex rigging. A hardened threaded shaft assembly ensures long-lasting durability under heavy use, while the cloverleaf setscrew and side-operable handle allow for flexible manipulation even in tight spaces. Adjust-A-Fit™ is compatible with a wide range of pipe sizes and is an ideal tool for fabrication and maintenance tasks that demand accuracy and repeatability. Whether aligning flanges, elbows, or tees, this tool reduces setup time, improves efficiency, and enhances safety, making it a valuable addition to any professional pipe fitter's toolkit.

Adjust-A-Fit™ can be used with Sumner Material Lifts.

PART NO 780420

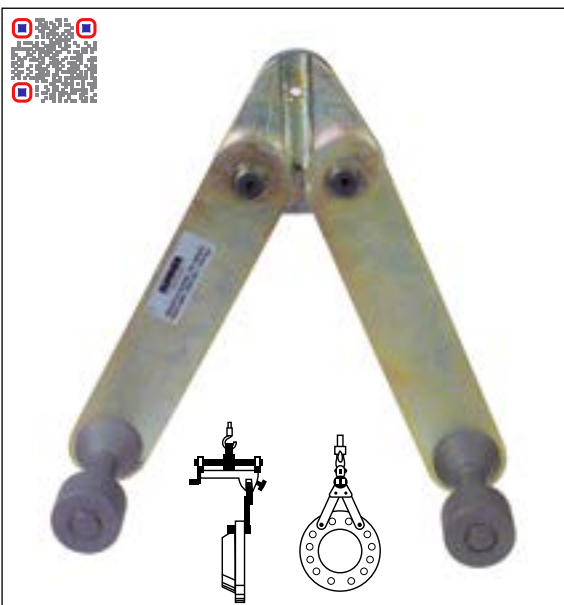

ADJUST-A-FLANGE™

The FIT-UP PRO Adjust-A-Flange™ is an innovative alignment accessory specifically designed to work alongside the Adjust-A-Flange™ system, creating a complete, one-person solution for aligning pipe flanges with accuracy and ease. This gravity-assisted tool simplifies flange positioning for tack welding and final weld-out, making it ideal for industrial and construction environments. It accommodates all flanges on pipes 5" / 127 mm and larger, with bolt hole compatibility ranging from 3/4 - 1 1/4" / 19 - 42 mm. Built to handle loads up to 1,000 lbs / 450 kg, the Adjust-A-Flange™ offers the strength and stability required for heavy-duty applications. Integrated flange nuts provide consistent reference points for fast level checks, helping to maintain plumb and alignment throughout the fitting process. Rugged, reliable, and easy to operate, this tool enhances precision and productivity while minimizing manpower, making it essential for professionals aiming for consistent, high-quality flange alignment.

Adjust-A-Flange™ can be used with Sumner Material Lifts.

PART NO 780425



CENTERING HEAD

The FIT-UP PRO Centering Head is a high-precision layout tool engineered for locating pipe centerlines, marking angles, and defining points around cylindrical surfaces. Suitable for use on pipe diameters from 3 - 40" / 76 - 1,016 mm, this tool features a rotating protractor dial marked in 2.5° increments for accurate point location. Constructed for durability and portability, it includes a built-in punch and a magnetized base for stable positioning during layout. Whether you're working on shafts, tanks, or complex pipe systems, the Centering Head offers unmatched versatility and reliability. Its robust design ensures consistent accuracy, making it an indispensable tool for welders, pipefitters, and layout technicians. Ideal for both field and shop environments, this centering head saves time and improves layout precision, helping professionals execute complex jobs with ease and confidence. Packaged in a convenient blister pack, it's ready for work wherever you are.

PART NO D206 OLD SUMNER PART NO 784520



INCLINOMETER DIGITAL ANGLE FINDER

The Sumner Inclinator is a compact, magnetic digital pocket level designed for fast and accurate angle measurement across a wide range of fabrication, alignment, and layout tasks. Engineered for precision and durability, it functions as both a digital inclinometer and an advanced angle finder, making it ideal for structural and pipe-fitting applications.

The device provides an instant digital readout with a fine resolution of 0.05° and an accuracy of ±0.2°, ensuring dependable performance even in demanding work environments. Its digital gage can be quickly zeroed on any reference surface, allowing users to establish custom baselines and measure angles efficiently during fabrication and installation.

Built for portability and ease of use, the inclinometer includes a data-hold function that enables users to capture and retain measurements while repositioning or marking a workpiece. A long-lasting 9V battery supports extended field use, while the clear, compact digital display offers excellent visibility whether mounted on a flat surface or used handheld.

Designed to interface smoothly with standard fabrication tools ranging from 1 - 2" / 25 - 50 mm in width, the Sumner Inclinator combines accuracy, durability, and convenience. It provides fabricators and technicians with a reliable solution for maintaining precise angles and improving efficiency across a wide variety of jobsite applications.

PART NO 789546



MAGNETIZED POCKET LEVEL

Compact and rugged, the FIT-UP PRO Pocket Level delivers precise leveling and angle verification in confined or mobile work environments. Measuring just 2 × 2.5" / 50 × 63.5 mm, it is a compact yet powerful tool for welders and fabricators. The rotating inclinometer dial allows for fast, intuitive angle reading, while its magnetized base enables hands-free operation on metal surfaces. Made of robust materials for long-term use, it ensures accuracy without compromising portability. Whether you're verifying pipe slopes, flange angles, or structural elements, this pocket level offers speed, convenience, and precision. It is perfect for use in the field or the workshop, especially when space is limited and fast reads are essential. With its durable construction and easy-to-use design, the Pocket Level is a key tool for professionals who value accuracy and efficiency in every job. Supplied in a blister pack, it fits effortlessly into your toolbox or pocket.

PART NO D208 OLD SUMNER PART NO 781947



PLASTIC MAGNET POCKET LEVEL

The Pocket Level from FIT-UP PRO is a high-performance, compact tool designed for precision alignment in demanding environments such as pipe fitting, structural assembly, and machinery installation. Constructed from tough ABS plastic, it offers long-lasting durability and impact resistance. The level features dual high-visibility vials set at 0° and 90°, allowing fast and accurate angular referencing for critical alignments. Its strong magnetic base securely attaches to steel surfaces, enabling hands-free operation on pipes, beams, and equipment. The tool is compact, measuring 4" / 102 mm in length, and ultra-lightweight at under 0.5 lbs / 0.2 kg, making it easy to carry in a pocket or tool pouch. High-impact acrylic vials and etched markings ensure visibility and longevity, even in tough field conditions. Designed for efficiency and reliability, the SUMNER Pocket Level is an essential part of any tradesperson's toolkit, delivering quick, consistent measurements wherever precision is required.

PART NO 781947



TORPEDO LEVEL

The FIT-UP PRO Torpedo Level is a compact, multi-functional leveling tool crafted specifically for pipefitters and welders. Designed with a V-grooved and magnetized base, it securely attaches to pipe surfaces for hands-free alignment. With dimensions of 12 x 4" / 300 x 100 mm, it offers excellent surface coverage while remaining easy to handle. The tool includes two fixed vials for standard level checks and a rotating dial to verify angles quickly and precisely. Laser-etched measurements add durability and readability in all conditions. Whether working on horizontal runs or angled joints, this torpedo level ensures perfect alignment. It's engineered for rugged use in harsh environments, making it an essential part of any professional's toolkit. Ideal for tight spaces and complex setups, this level combines precision, durability, and ease of use to improve quality and speed on the job. Delivered in blister packaging for convenience and protection.

PART NO D207



ACCU-LEVEL

The FIT-UP PRO Accu-Level is a durable, precision leveling tool designed specifically for professionals in pipe fitting and welding. Engineered with a rugged die-cast aluminum body, it provides long-lasting performance even in demanding environments. The tool includes three built-in vials for measuring 0°, 45°, and 90° angles, allowing users to achieve quick, reliable alignments across various applications. Its grooved base fits securely on pipes and conduits, while powerful magnets ensure a stable, hands-free hold on steel surfaces—enhancing both safety and efficiency during fit-up tasks.

Measuring approximately 6" / 152 mm in length and weighing under 1 lbs / 0.45 kg, the Accu-Level is compact and easy to carry, especially with its included belt holster. The combination of portability, durability, and precise measurement capability makes it an essential tool for job sites that require consistent, accurate alignment. Trusted by industry professionals, it streamlines setup time while minimizing alignment errors.

PART NO 781950



RADIUS MARKER

FIT-UP PRO Radius Markers offer welders and fabricators a precise and reliable tool for marking arcs, circles, saddle cuts, and elliptical shapes on pipe and flat surfaces. Available in three sizes - small for up to 22" / 560 mm, medium for up to 50" / 1,270 mm, and large for up to 100" / 2,540 mm circles - these markers suit a wide variety of layout applications. Made from high-grade aluminum, the markers feature tensioned joints that hold their shape yet move smoothly, allowing for consistent, repeatable marking. They are compatible with both rectangular and round soapstones. Ideal for use in the field or workshop, these radius markers improve accuracy and reduce guesswork when laying out complex geometries. Designed with practicality in mind, they are lightweight, durable, and easy to use. Supplied in blister packs, the Radius Marker series is a must-have layout tool for professionals who demand both performance and precision.

D209 : SMALL - RADIUS MARKER UP TO 22" CIRCLE

D210 : MEDIUM - RADIUS MARKER UP TO 50" CIRCLE

D211 : LARGE - RADIUS MARKER UP TO 100" CIRCLE



Q.C. WELDER'S GAUGE WITH PIT DEPTH

The FIT-UP PRO Q.C. Welder's Gauge with Pit Depth attachment is a precision tool designed to streamline weld inspection and quality control. Built to measure internal misalignment (high-low), external mismatch, and pit depths, it supports both pre- and post-weld evaluations. It delivers highly accurate readings in $\frac{1}{64}$ " / 0.4 mm increments, helping welders avoid costly rework and ensuring compliance with strict fabrication standards. The optional stainless steel pit depth gauge enhances functionality, enabling precise measurement of weld crown height, undercut, and corrosion pits. Constructed for durability, the gauge is suited for rugged field conditions while remaining easy to use. Available in both imperial and metric versions, it comes packaged individually or in boxes of ten. Lightweight and compact, this tool is a go-to solution for welders aiming for consistency, reliability, and accuracy during critical inspection phases. Whether in-shop or on-site, it boosts productivity and minimizes the risk of weld rejection.

PART NO D253E (IMPERIAL) - ONLY STOCKED IN THE AMERICAS

OLD SUMNER PART NO 781900

PART NO D253M (METRIC)

OLD SUMNER PART NO 781901



PIPE WRAP

The FIT-UP PRO Pipe Wrap is a versatile tool for marking straight lines, elbow cuts, and angles on pipe diameters from 3 - 26" / 76 - 660 mm. Available in sizes like 4 x 4 ft / 102 x 1,219 mm, 4 x 6 ft / 102 x 1,829 mm, and 4 x 7 ft / 102 x 2,134 mm, the wrap includes a table of tangents, a 45° angle chart, and increment markings in $\frac{1}{8}$ " / 3.2 mm. Constructed of abrasion- and solvent-resistant material, it is double-ruled for convenience and ensures durability in harsh jobsite conditions. A critical aid for layout professionals.

D160 : 3" - 15" / 76 - 381 mm

D170 : 4" - 7" / 76 - 559 mm

D177 : 6" - 12" / 76 - 660 mm

D184 : 4" / 102 mm width x length desired sold in 1 ft / 305 mm increments*

D185 : 5" / 127 mm width x length desired sold in 1 ft / 305 mm increments*

D187 : 7" / 178 mm width x length desired sold in 1 ft / 305 mm increments*

***D184, D185 and D187 - Pipe wrap sold per foot does not have any marking or instructions.**



MUL-T SQUARE

The FIT-UP PRO Mul-T-Square is a versatile alignment and layout tool engineered for pipefitters, welders, and fabricators who require precision and efficiency. Designed with two 45° blades that slide smoothly within a robust plastic handle, it simplifies marking and verifying critical angles. Constructed from lightweight, durable aluminum, it handles flanges up to 8" / 203 mm and fittings up to 14" / 356 mm in diameter. The tool includes standard 10" / 254 mm and 14" / 356 mm blades, with an optional 30" / 762 mm extended blade set available for larger applications. Imperial and metric scale markings ensure accurate measurement and compatibility across global job sites. Compact and portable, the Mul-T-Square allows for quick, repeatable layout in tight spaces or complex configurations. Whether verifying 45° or 90° angles or marking cuts on fittings and pipes, it delivers the reliability and precision essential for consistent, high-quality fabrication work.

PART NO 790000

PART NO 790030

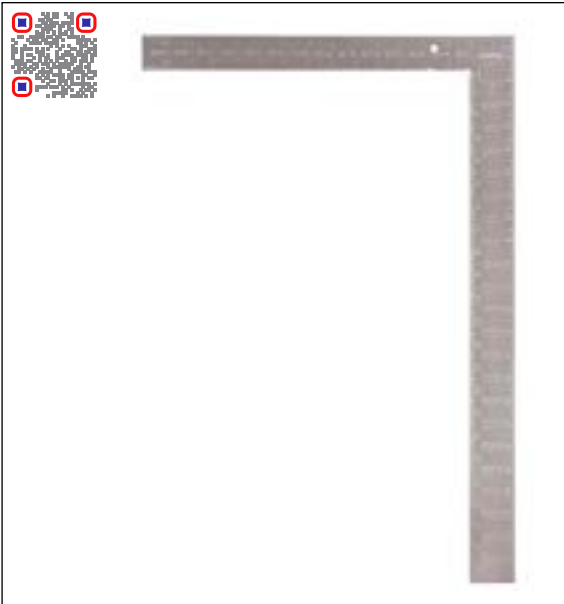

ALUMINIUM SQUARE

The Aluminium Square is a dependable and versatile layout tool designed for precision in fabrication, welding, and general construction tasks. Built from lightweight yet durable aluminum, it combines strength with portability, ensuring ease of use across workshop and jobsite environments. Its corrosion-resistant design guarantees long-lasting performance, even under heavy industrial use. Measuring 24 x 16" / 610 x 406 mm, the Aluminium Square provides a generous surface area for marking and verifying right angles, making it indispensable for accurate layout and assembly work. With etched markings in both imperial and metric units, this tool supports universal applications and maintains clarity over time, ensuring consistent accuracy in every project. Whether used for squaring up large fabrications or double-checking layout lines, the FIT-UP PRO Aluminium Square delivers reliable results. Compact, durable, and easy to handle, it is an essential addition to any professional's toolkit, offering precision and confidence in demanding environments.

PART NO D241

OLD SUMNER PART NO 781921



PIPE FITTER'S SQUARE

The FIT-UP PRO Pipe Fitter's Square is a precision-engineered tool created specifically for pipefitters, welders, layout technicians, and boilermakers. Constructed from stainless steel for durability and corrosion resistance, this square provides multiple measurement features in one compact design. With dimensions of 15.5 x 24 x 0.125" / 394 x 610 x 3 mm, it includes set-back guides for pipe-to-elbow fit-ups, a centerline locator, 1/16" ruled graduations, a tangent chart, decimal chart, and degree markings. Whether used for determining angles, set-backs, or centerlines, the Pipe Fitter's Square simplifies complex layout tasks and increases job efficiency. It's ideal for on-site and workshop environments where precision and speed are essential. This all-in-one layout tool improves productivity and minimizes errors during pipe fit-up and fabrication. Its durable design ensures a long service life, making it a go-to essential for professionals working in demanding industrial settings.

PART NO D248



PROTRACTORS

FIT-UP PRO Protractors are versatile layout tools that offer exceptional accuracy for measuring and verifying pipe angles, squareness, and bevels. Available in multiple sizes to accommodate a range of project needs, the series includes the Mini Protractor at 4" / 102 mm, the Small Protractor with 18" and 12" / 457 mm and 305 mm legs, and the Large Protractor with 48" and 36" / 1,219 mm and 914 mm leg lengths. The large model measures squareness of pipe ends up to 40" / 1,016 mm in diameter and checks miters up to 180°. These tools are essential for layout verification, particularly in complex pipe fitting and welding applications. Made of durable stainless steel or aluminum, each protractor provides precise angle readings in a rugged, jobsite-ready design. Whether used in fabrication shops or field installations, FIT-UP PRO Protractors ensure accuracy, reduce rework, and save time on every pipe layout.

- MINI - DXX-250 : 4" / 102.4 mm**
- SMALL - DK-239 : 18" & 12" / 457 mm & 305 mm**
- LARGE - DK-100 : 48" & 36" / 1,219 mm & 914 mm**



FRAMING SQUARE

The FIT-UP PRO Stainless Steel Framing Square is built for accurate angular measurement and squareness verification in pipefitting and construction tasks. Compact yet precise, it measures 8 x 12 x 1/16" thick / 203 x 305 x 1.6 mm thick and is marked in 1/8" increments on both sides for reliable reading. This square is perfect for checking pipe centerlines, drops, and angles when paired with a level. Ideal for use on small to medium-sized pipe, the tool enhances layout accuracy and reduces guesswork in fabrication and welding projects. Its robust stainless steel construction ensures long-lasting performance under harsh jobsite conditions. Lightweight and easy to handle, the Framing Square is a valuable tool for fabricators, welders, and installers who demand precision in their layout work. Whether you're setting angles or verifying alignment, this framing square delivers consistent, repeatable results that improve fit-up speed and quality.

PART NO D256



FLANGE SQUARES

FIT-UP PRO Flange Squares are heavy-duty tools designed for precise flange alignment and squareness in pipe and tube construction. Available in three models - 12 x 12" / 300 x 300 mm, 16 x 16" / 400 x 400 mm, and 20 x 20" / 500 x 500 mm - each square features a 30 x 5 mm cross-section for added strength and durability. Constructed from high-grade steel, these squares are specifically engineered for adjusting and aligning flanges, ensuring they remain square to the pipe face. Their rigid frame eliminates flexing, allowing fabricators to achieve true 90° angles with confidence. Whether you're assembling pipe spools or installing flanges on-site, these tools streamline the process and reduce misalignment risks. FIT-UP PRO Flange Squares are essential for maintaining the integrity of welded systems in critical industries, offering consistent performance, jobsite reliability, and the precision needed for repeatable, high-quality results.

- TFSQ300 : 12 x 12" / 300 x 300 mm**
- TFSQ400 : 16 x 16" / 400 x 400 mm**
- TFSQ500 : 20 x 20" / 500 x 500 mm**



SUMNER Material Lifts is a world leading brand in the material handling and construction industries, renowned for its innovative, durable, and user-friendly solutions. Founded in 1965 and now a part of the Specialized Fabrication Equipment Group (in short S.F.E. Group), **SUMNER Material Lifts** has built a global reputation for providing high-quality lifting equipment. Designed with safety and efficiency in mind, **SUMNER Material Lifts** products are widely used by professionals in mechanical contracting, plumbing, HVAC, welding, and electrical installation.

SUMNER Material Lifts' product line includes a broad range of lifting tools such as material lifts, duct lifts, Roust-A-Bouts, gantries, and heavy-duty hoists, all engineered to meet the demanding requirements of job sites around the world. All equipment is known for ease of use, robust construction, and industry-leading safety features, making it the preferred choice for both large-scale industrial projects and everyday construction needs.

With a long tradition of quality, reliability and value and a strong commitment to innovation and customer satisfaction, **SUMNER Material Lifts** continues to set the standard in lifting and material handling solutions.

In conjunction with all other S.F.E. Group portfolio's brands, **SUMNER Material Lifts** continues to lead the way in lifting and fabrication solutions, delivering tools that elevate the operator's standard of work.

SUMNER Material Lifts' products are always nearby available within the S.F.E. Group global network and can be consulted on the dedicated website: www.SUMNER.com





EL-405 STACKER LIFT

The EL-405 Stacker Lift is built for use in warehouse and service department settings. It has a maximum lifting height of 53" / 1,346 mm and a capacity of 400 lbs / 181 kg. The unit includes a two-speed winch handle for flexible and efficient operation. Its large lifting platform is ideal for handling boxes and similar materials. A quick-action wheel brake immobilizes the lift for added safety. It is designed to be compact and maneuverable in confined spaces (the lift fits through a standard door size). The EL-405 is compatible with an optional extension strap kit for added versatility. Its lightweight build ensures ease of transport and storage. The stacker is designed with user-friendly ergonomics. Overall, it provides a robust solution for light-duty material handling.

PART NO 784650

FOR ACCESSORIES PART NUMBERS, PLEASE SCAN THE PRODUCT QR CODE



SERIES 1900

The Series 1900 Lift is engineered for lifting heavy materials during shipping, receiving, and HVAC work. It is available in two models: one with an 8 ft / 2.44 m lifting height (400 lbs / 181 kg capacity) and one with a 10 ft / 3.05 m lifting height (350 lbs / 158 kg capacity). Its forks are reversible to allow maximum lift height. A two-speed winch handle offers both leverage and speed. The lift breaks down easily for transport and storage. A two-position straddle base ensures versatility in tight spaces. Equipped with 5-inch wheels, it can roll over uneven terrain. The lift is compact and designed for one-person operation. It features durable construction suitable for daily industrial use. The Series 1900 is a reliable solution for light to mid-range lifting needs.

PART NO 782050 - SERIES 1908

PART NO 782051 - SERIES 1910

FOR ACCESSORIES PART NUMBERS, PLEASE SCAN THE PRODUCT QR CODE



ROUST-A-BOU™

The Roust-A-Bout™ lift allows a single operator to lift and place loads up to 1,500 lbs / 680 kg in challenging locations. It features an innovative design with rugged 8" casters for horizontal movement. Vertical adjustments are controlled by a dual-winch system - one for the load and one for the mast. A variable 4-speed winch offers precise lifting control. The lift is ideal for both shop and on-site jobs. It is available in four models, with lift heights ranging from 15 ft / 4.57 m to 25ft / 7.62 m. Each model is offered in either powder-coated or galvanized finishes. The lift is easily disassembled for transport and storage (the lift fits through a standard door size). Optional accessories like Tee Head Extensions are available for specific tasks. It is well-suited for pipe installation and other tight-space lifting needs.

FOR ALL SIZES, ACCESSORIES AND PART NUMBERS, PLEASE SCAN THE PRODUCT QR CODE



FAB-MATE™ LIFT

The FAB-MATE™ Lift is a single-user solution designed for precise lifting and positioning. It has a maximum lift height of 7 ft / 2.13 m and a 1,000 lbs / 450 kg capacity. The winch is built by SUMNER Material Lifts for reliability and ease of use. Rugged 8" casters ensure smooth mobility across job sites. It is compatible with FIT-UP PRO's Adjust-A-Fit™ and FIT-UP PRO's Adjust-A-Flange™ tools. The lift is compact and easy to maneuver in tight work areas. Its steel frame offers durability for industrial applications. Quick setup and breakdown make it ideal for frequent transport. It is commonly used in fitting and flange alignment tasks. This lift is a versatile choice for fabrication shops and mechanical contractors.

PART NO 783900

FOR ACCESSORIES PART NUMBERS, PLEASE SCAN THE PRODUCT QR CODE



SHORT STACK™ LIFT (SERIES 2000 SHORT STACK)

The Short Stack™ Lift (Series 2000 Short Stack) is part of SUMNER Material Lifts' Series 2000 line, offering a compact footprint without compromising lifting power. It handles loads up to 800 lbs / 362 kg and comes in 12 ft / 3.66 m and 16 ft / 4.88 m models. The lift fits through standard doorways, ideal for indoor use. An integrated lifting eye allows it to be flown into position. A pulley guard offers 360° cable protection for operator safety. Forks can be reversed to optimize lift height. Tool-free setup uses plunger pins, reducing lost parts. The internal mast cable prevents exposure. Accessories include a mast brake kit and fork extension. It's ideal for contractors in confined or elevated spaces.

FOR ALL SIZES, ACCESSORIES AND PART NUMBERS, PLEASE SCAN THE PRODUCT QR CODE



SERIES 2000 MATERIAL LIFT

The Series 2000 Material Lift is designed for heavy-duty lifting in construction and HVAC work. It is available in four models with capacities ranging from 650 - 1,000 lbs / 294 - 450 kg. Lifting heights range from 10 - 25 feet / 3.05 - 7.62 m, providing flexible use cases. The lift fits easily through doorways and includes an integrated lifting eye for aerial transport. A pulley guard ensures full cable coverage, enhancing operator safety. Reversible forks maximize vertical lifting height. Tool-free plunger pins simplify assembly and disassembly. The internal cable routing keeps the lift safe and clean. It supports several accessories including pipe cradles, boom assemblies, and trays. The Series 2000 Material Lift is a versatile and rugged lift for demanding work environments.

FOR ALL SIZES, ACCESSORIES AND PART NUMBERS, PLEASE SCAN THE PRODUCT QR CODE



SERIES 2200 LIL' HOISTER LIFT

The Series 2200 Lil' Hoister Lift is a lightweight, portable material lift built for quick setup, easy transport, and reliable performance on the job. It's perfect for a wide range of applications, including HVAC installations, cabinet mounting, loading and unloading service vehicles, positioning ducts and electrical trays, and handling tools or machine parts. Its dual I-beam mast design delivers exceptional strength, while mast braces provide added support and stability when lifting.

The Lil' Hoister is designed with convenience and safety in mind. The two-speed winch handle lets operators lift or lower at standard or high speed, completing lifts in less than half the time. Fold-out roller wheels make it simple to roll the lift in and out of trucks or vans, and 8-inch non-marring wheels protect floors during use. A 1-inch nylon strap replaces traditional cables, eliminating kinks and keeping the operator safe. With reversible forks and double-row casters for smooth maneuvering, the Lil' Hoister is the perfect choice for contractors, technicians, and maintenance teams who need a compact, strong, and easy-to-use lifting solution.

PART NO 784310 - 2200 LIL HOISTER LIFT

FOR ACCESSORIES PART NUMBERS, PLEASE SCAN THE PRODUCT QR CODE



SERIES 2100 CONTRACTOR LIFT

The Series 2100 Contractor Lift is engineered for job sites requiring strength and portability. It supports up to 650 lbs / 294 kg and offers lift heights of 12ft / 3.66 m, 18 ft / 5.49 m and 24ft / 7.32 m. It comes in both powder-coated and galvanized versions for different environmental needs. The lift is equipped with a pulley guard to protect the cable from damage. Reversible forks provide maximum lifting height flexibility. Integrated lifting eyelets allow it to be hoisted into position with ease. Assembly is streamlined with plunger pins to avoid tool dependency. The internal cable routing improves safety and keeps components out of harm's way. Several add-on tools are available to expand functionality, such as trays and fork extensions. This model is particularly favored by mechanical and industrial contractors.

FOR ALL SIZES, ACCESSORIES AND PART NUMBERS, PLEASE SCAN THE PRODUCT QR CODE



SERIES 2300 DRYLIFT/HAVC LIFT

The Series 2300 lift is tailored for lifting drywall and lightweight HVAC components. It can raise loads up to 150 lbs / 68 kg to heights of either 11 ft 2.75" / 3.42 m or 14 ft 9.75" / 4.42 m. The lift is built from lightweight materials, weighing just 99 lbs / 45 kg for ease of mobility. It includes a two-speed winch for efficient operation. Tool-free setup makes it fast to assemble on-site. It's designed for single-person operation in construction environments. The lifting head tilts 65 degrees to accommodate angled drywall installation. Available in drywall and HVAC-specific versions, it's highly adaptable. It ships with a transport cart for convenience. The Series 2300 is ideal for quick installation tasks where speed and light weight are priorities.

PART NO 784345 - 2311 DRYWALL LIFT

PART NO 784346 - 2315 DRYWALL LIFT

PART NO 784332 - 2315 HVAC LIFT

PART NO 2311HVCA - 2311 HVAC CRADLE LIFT

FOR ACCESSORIES PART NUMBERS, PLEASE SCAN THE PRODUCT QR CODE



SERIES 2400 CONTRACTOR LIFT

The Series 2400 Contractor Lift is a compact yet powerful lift with a load capacity of 450 lbs / 204 kg. It is designed for mobility, breaking down to just over 5 ft / 1.52 m in height for easy vehicle storage. Available in 12 ft / 3.66 m and 16 ft / 4.88 m models, it fits in most vans and SUVs. It features a 360° pulley guard for cable protection. Internal cable routing improves operator safety and tool longevity. Reversible forks help extend the lifting range without additional tools. Its compact frame is suitable for tight job sites and indoor tasks. Accessories like pipe cradles and trays enhance its versatility. The lift includes plunger pins to eliminate the need for extra assembly tools. It's a reliable choice for contractors seeking a space-saving lifting solution.

PART NO 784750 - 2412 CONTRACTOR LIFT

PART NO 784751 - 2416 CONTRACTOR LIFT

PART NO 784752 - 2412 CONTRACTOR LIFT - GALVANIZED

PART NO 784763 - 2416 CONTRACTOR LIFT - GALVANIZED

FOR ACCESSORIES PART NUMBERS, PLEASE SCAN THE PRODUCT QR CODE



SERIES 2500 COUNTERBALANCED LIFT

The Series 2500 Counterbalanced Lift is built for versatility, safety, and efficiency in tight or obstructed spaces. With a lifting capacity of 650 - 1,000 lbs / 300 - 455 kg and heights from 10 - 25 ft / 3 - 7 m, it easily handles tasks like hanging pipe against walls or reaching second-floor levels. Its counterbalanced design eliminates front legs for close-to-wall lifting, while the two-speed winch, fully enclosed pulleys, and side-mounted operation enhance safety and control. The lift breaks down into a cart and mast section for simple transport, fits through standard doorways, and features mast roller wheels for easy vehicle loading. Quick-action plunger pins, adjustable leveling screws for uneven floors, and a hand cart for moving forks and accessories make it a dependable and highly mobile solution for demanding job sites.

PART NO 786510 - 2510 COUNTERBALANCED LIFT

PART NO 786511 - 2515 COUNTERBALANCED LIFT

PART NO 786512 - 2520 COUNTERBALANCED LIFT

PART NO 786513 - 2525 COUNTERBALANCED LIFT

FOR ACCESSORIES PART NUMBERS, PLEASE SCAN THE PRODUCT QR CODE



SERIES 2600 - 'THE BIG LIFT'

The Series 2600 'The Big Lift' is designed for high-capacity lifting in tight job site conditions. It has a maximum load capacity of 1,100 / 498 kg and a lift height of 15 ft / 4.57 m. The lift features a SUMNER Material Lifts' - built two-speed winch for controlled elevation. It can be quickly disassembled for compact storage and transportation. A steering handle allows fast centering and alignment of the lift. Tool-free assembly is achieved with integrated plunger pins. Internal cable routing eliminates exposed components for added safety. Reversible forks help maximize lifting height. Multiple accessories are available, including safety brakes, pipe cradles, and fork extensions. The big lift is perfect for large, heavy jobs in confined spaces.

PART NO 783067 - 2615 THE BIG LIFT

PART NO 783068 - 2615 THE BIG LIFT - GALVANIZED

FOR ACCESSORIES PART NUMBERS, PLEASE SCAN THE PRODUCT QR CODE



EVENTER™ SERIES

The Eventer™ Series is purpose-built for the entertainment and theatrical industries. It comes in models that lift up to 800 lbs / 363 kg and reach heights of 16 ft / 4.88 m, 20 m / 6.10 m and 25 ft / 7.62 m. These lifts are finished in black to blend discreetly into stage environments. Forks are reversible to increase lifting height in tight backstage spaces. Leveling pads ensure stability on uneven surfaces. The telescoping masts are made of anodized aluminum for durability and minimal visibility. The lift is compact and easy to assemble or break down quickly. Available accessories include hook block kits and sound array bars for AV gear. Designed with input from staging professionals, it performs well for lighting, speaker, and truss setup. The Eventer™ is a dependable lift for live production environments.

PART NO 784760 - EVENTER™ 16ft.

PART NO 783801 - EVENTER™ 20ft.

PART NO 783800 - EVENTER™ 25ft.

FOR ACCESSORIES PART NUMBERS, PLEASE SCAN THE PRODUCT QR CODE



GH3/4T GANTRY

The GH3/4T Gantry is a 3/4 ton (1,650 lbs / 748.43 kg) portable gantry crane ideal for industrial and field use. Its aluminum construction keeps it lightweight for transport while maintaining durability. It features a compact 3-piece design for quick assembly. The frame includes two A-frames with casters and an adjustable cross beam. Available caster options include 8" locking or 10" flat-free tires. The gantry's adjustable span accommodates various load widths. It can be assembled by two people with no pinch points. Unassisted height adjustment simplifies setup on-site. The system is compatible with a chain hoist (not included). The GH3/4T is a versatile lifting solution for medium-duty operations.

FOR ALL SIZES, ACCESSORIES AND PART NUMBERS, PLEASE SCAN THE PRODUCT QR CODE



GH2T GANTRY

The GH2T Gantry is designed to lift up to 2 metric tons (4,400 lbs / 1,995.80). It uses a compact 3-piece aluminum frame similar to the GH3/4T model. Its portability makes it easy to transport and set up on job sites. This gantry includes two A-frames with 8" locking casters and an adjustable cross beam. Chain hoists can be added to customize lifting capability. Four different configurations are available based on beam span and height. The structure supports pinch-point-free assembly by two users. It is ideal for material handling in shops or construction zones. The system balances strength with ease of use. The GH2T is a rugged and scalable gantry crane for heavier loads.

FOR ALL SIZES, ACCESSORIES AND PART NUMBERS, PLEASE SCAN THE PRODUCT QR CODE



GH5T GANTRY

The GH5T Gantry is a heavy-duty gantry with a 5-ton (11,000 lbs / 4,989.51 kg) lifting capacity. It is made of lightweight yet strong aluminum components. The gantry is available in three beam span configurations to match various lifting needs. It uses the same user-friendly 3-piece assembly system as other Sumner gantries. Locking casters allow easy positioning and stability. A pinch-free design enhances safety during setup. The unit includes adjustable height and span to accommodate different loads. Chain hoists are not included but can be mounted easily. An optional trolley assembly adds flexibility for moving suspended loads. The GH5T excels in high-capacity lifting scenarios.

FOR ALL SIZES, ACCESSORIES AND PART NUMBERS, PLEASE SCAN THE PRODUCT QR CODE



LEVER HOIST

SUMNER Material Lifts' standard Lever Hoists are designed for rugged, manual lifting operations. They come in models ranging from ¼ to 6 tons. Each hoist includes a steel body with a 360° ratchet handle for easy operation. The design meets ANSI/ASME, OSHA, and CE standards.

Top hooks are removable for rigging flexibility. The units use hard steel sheave rollers to manage load chain movement. Every model is tested to 1.5 times its rated load for safety. They are ideal for lifting, holding, or pulling in workshop and field settings. Available chain falls range from 5 to 20 feet. These hoists offer reliability for day-to-day industrial use.

FOR ALL SIZES AND PART NUMBERS, PLEASE SCAN THE PRODUCT QR CODE



PREMIUM LEVER HOISTS

Premium Lever Hoists by SUMNER Material Lifts offer advanced features and higher performance. Capacities range from 0.8 to 9 tons across multiple models. The hoists use a single fused brake design for smooth operation. Zinc phosphate chains provide high resistance to corrosion. No preload is required before operation, making them user-friendly. The hard steel sheave rollers ensure load security under stress. Each unit is tested to 1.5x safety factors and meets all relevant standards. Removable top hooks allow for flexible anchoring. Chain fall lengths range from 5 to 20 feet. These hoists are built for demanding lifting tasks in harsh environments.

FOR ALL SIZES AND PART NUMBERS, PLEASE SCAN THE PRODUCT QR CODE



PREMIUM LEVER HOISTS WITH OVERLOAD PROTECTION

This version of the Premium Lever Hoist adds overload protection to prevent accidental overloading. It shares all features with the standard premium models, including zinc phosphate chains and a fused brake system. Lifting capacities span from 0.8 to 9 tons. The hoist automatically halts operation when exceeding load limits. This makes it safer for less experienced operators and hazardous conditions.

Like other SUMNER Material Lifts hoists, it meets ANSI/ASME, OSHA, and CE regulations. The body features hard steel components for long-term durability. Removable hooks allow rigging flexibility.

Available with chain falls from 5 to 20 feet. It's a smart choice for safety-critical lifting jobs.

FOR ALL SIZES AND PART NUMBERS, PLEASE SCAN THE PRODUCT QR CODE



CHAIN BLOCK HOISTS

SUMNER Material Lifts' Chain Block Hoists are intended for vertical lifting in light industrial work. Models range in capacity from ½ to 10 tons. They are engineered with hard steel load sheave rollers for high durability. Top hooks are removable to suit a variety of rigging needs. Each hoist is tested to 1.5 times its rated load.

The product line meets ANSI/ASME, OSHA, and CE hoisting standards. Available chain fall lengths include 10, 15, 20, and 30 feet. The hoists are designed for ease of use and long service life. Compact and efficient, they are ideal for fixed-location lifting. These are dependable units for routine lifting operations.

FOR ALL SIZES AND PART NUMBERS, PLEASE SCAN THE PRODUCT QR CODE



PREMIUM CHAIN BLOCK HOISTS

Premium Chain Block Hoists from SUMNER Material Lifts add performance upgrades to the standard model. They feature low headroom design for use in confined spaces. Available capacities range from ¼ ton to 20 tons.

The chain is finished with zinc phosphate for added corrosion resistance. Each hoist includes removable top hooks for rigging convenience. The frame is designed for strength and safety under load. They are tested to 1.5x their rated capacity. Chain fall lengths come in 10, 15, 20, and 30 feet options.

These hoists meet all regulatory standards for industrial lifting. They are well-suited for heavy-duty and long-term lifting tasks.

FOR ALL SIZES AND PART NUMBERS, PLEASE SCAN THE PRODUCT QR CODE



PREMIUM CHAIN BLOCK HOISTS WITH OVERLOAD PROTECTION

These hoists include all the premium features with an added safety mechanism. Overload protection prevents operation if the load exceeds safe limits. They are available in models from 1 to 20 tons.

Zinc phosphate chains and steel frames ensure long-lasting performance. Each hoist undergoes a 1.5x rated capacity test. Removable hooks offer flexibility during use. Headroom is minimized for tight installations. Chain fall lengths vary from 10 to 30 feet.

The product meets ANSI/ASME, OSHA, and CE standards. These hoists are ideal for precision lifting where safety is paramount.

FOR ALL SIZES AND PART NUMBERS, PLEASE SCAN THE PRODUCT QR CODE



INTRODUCING PIPE PURGE MASTERS



Backed by nearly 25 years of development, S.F.E. Group is proud to present its brand dedicated to pipe purging products, applications and solutions: **Pipe Purge Masters (PPM)**. With the **PPM brand**, the S.F.E. Group aims to not only emphasize its focus on pipe purging products but also meet the growing demand for on-site pipe purging equipment across the industries it already serves. Additionally, PPM products integrate seamlessly with other S.F.E. Group offerings, such as the orbital welding solutions provided by the AXXAIR brand.



As an OEM, S.F.E. Group prides itself on being renowned for its innovations, ground-breaking developments and creative designs within the **Pipe Purge Masters'** product range. Leveraging its engineering expertise, customer-centric approach, and flexibility, the PPM brand delivers innovative pipe purging solutions tailored to meet the specific needs of customer projects, while also addressing the demands of ever-evolving industries.

The **PPM** brand portfolio consists of a comprehensive range of pipe purging equipment: inflatable pipe purge bag systems, welding purge plugs, formed double seal purge systems, purge oxygen monitors, inflatable as well as mechanical pipe stoppers and accessories.

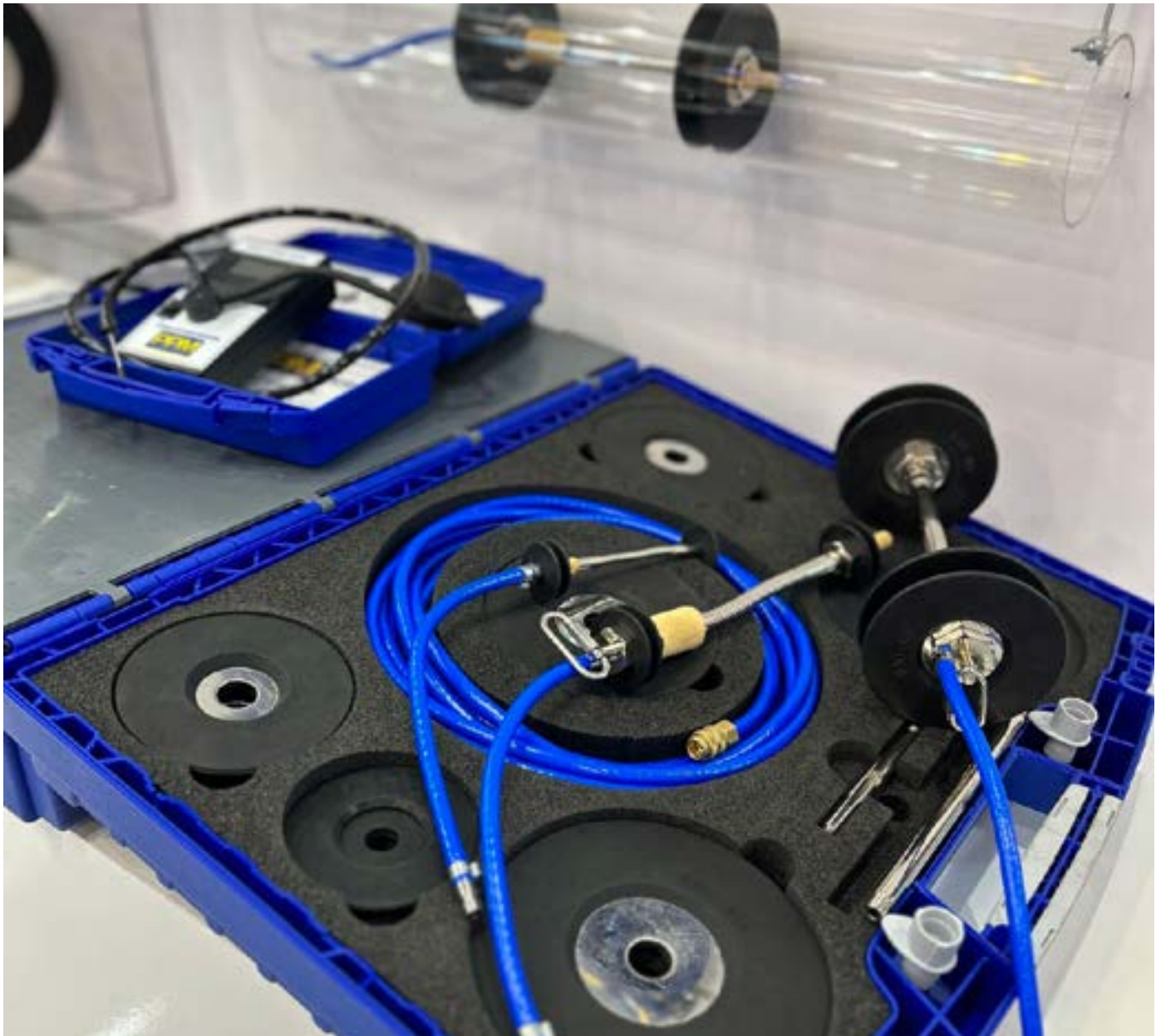
Pipe Purge Masters' products are available from the international S.F.E. Group locations on 5 continents, as well as from S.F.E. Group's extensive and continuously expanding global network of partners and can be consulted on the dedicated website www.PURGEMASTERS.com.



Heat Resistant
up to 70°C

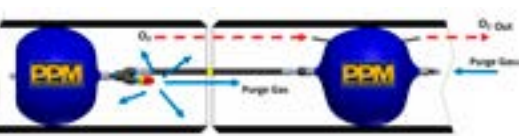

PURGE BAG SYSTEMS

2 - 24" / 50 - 610 mm

The PPM Purge Bag System offers an efficient, reusable solution for purging pipe welds from 2 - 24" / 50 - 610 mm. Using dual inflatable dams connected by an armored tube, it creates a sealed weld chamber that minimizes oxygen content quickly and reliably. It dramatically reduces purging times and inert gas usage - using less than 2% of the volume required by traditional methods. Heat-resistant to 70°C and featuring a luminous alignment strip, this system ensures precise placement, fast setup, and high-quality, oxide-free welds. With simple installation and robust construction, it pays for itself within a few uses and is ideal for stainless steel and corrosion-resistant alloy welding across numerous industries.

FOR ALL SIZES AND PART NUMBERS, PLEASE SCAN THE PRODUCT QR CODE

Heat Resistant
up to 250°C

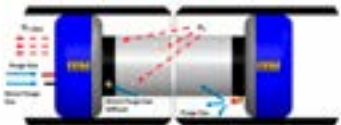

RAPID PURGE™ SYSTEM

8 - 80" / 190 - 2,044 mm

Designed for larger pipes 8 - 80" / 190 - 2,044 mm, the PPM Rapid Purge™ System delivers ultra-fast, efficient weld purging. Its unique design minimizes purge volume, enabling weld areas to reach oxygen levels below 0.1% in less than 10 minutes. Dual inflatable dams and a central sleeve ensure stable, repeatable purging performance. The system is heat-resistant up to 250°C and can be reused repeatedly, saving both time and gas. A luminous strip ensures precise positioning, even around bends. Ideal for high-alloy materials including stainless steel, duplex, titanium, and nickel, the Rapid Purge™ System supports high-integrity welds in demanding environments like power, petrochemical, and aerospace.

FOR ALL SIZES AND PART NUMBERS, PLEASE SCAN THE PRODUCT QR CODE

Heat Resistant
up to 500°C

HEAT RESISTANT PURGING SYSTEMS

3 - 80" / 63 - 2,044 mm

PPM's Heat Resistant Purging Systems are designed for high-temperature welding, capable of continuous operation at 350°C and short-term exposure up to 500°C. Available in both Purge Bag and Rapid Purge™ formats for pipes ranging from 3 - 80" / 63 - 2,044 mm, these systems maintain weld zone integrity throughout the full welding cycle, including preheat and post-weld heat treatment. Built using durable Nomex-Kevlar materials, they provide fast, stable purging and luminous strips for accurate placement. Designed to meet the strict requirements of nuclear, power, and high-alloy fabrication industries, they ensure consistent, oxide-free welds even in the most extreme thermal environments.

FOR ALL SIZES AND PART NUMBERS, PLEASE SCAN THE PRODUCT QR CODE



Combine with AXXAIR & MAGNATECH solutions



(NEW PRODUCT LAUNCHING 2026)

WELDPURE PURGE PLUGS

0.35 - 4.33" / 9 - 110 mm

The PPM WeldPure purge plugs ensure efficient, high-quality weld purging through an optimized gas-flow design. Depending on plug size, selected models feature an off-center gas inlet and outlet to promote progressive, directional oxygen evacuation for faster, more reliable inerting - working in combination with the integrated gas diffuser to deliver stable, uniform gas distribution. Covering pipe diameters from 0.35 - 4.33" / 9 - 110 mm, the 14 plug sizes are clearly marked for quick identification and ease of use. Durable, reusable, and designed for practical on-site operation, the complete kit is neatly organized in a robust, foam-lined transport case. Ideal for demanding applications requiring high-purity welds, it offers a cost-effective, all-in-one solution for consistent, high-performance purging.

Standard kit available: SPSK09-110 (0.35 - 4.33" / 9 - 110 mm)

FOR ALL SIZES AND PART NUMBERS, PLEASE SCAN THE PRODUCT QR CODE



Heat Resistant up to 450°C



DOUBLE SEAL SYSTEMS

0.75 - 12" / 16 - 320 mm

PPM Double Seal Systems (available as individual and standard kits) deliver rapid, gas-efficient weld purging using high-grade silicone discs to form airtight seals. Suitable for pipes from 0.75 - 12" / 16 - 320 mm, they reduce purge times to under two minutes and are reusable, interchangeable, and heat-resistant to 450°C. Their flexible or rigid tube connectors adapt to elbows and fittings, while the compact design enables use in tight or complex geometries. Available individually or as kits - including the Gas Finger range for small diameters - these systems ensure minimal gas use and excellent weld quality. Ideal for pharmaceutical, biotech, food, and high-purity piping, Double Seal Systems are a cost-effective, high-performance purging solution.

Standard kits available:

- DSK16-165 (0.62 - 6.49" / 16 - 165 mm)
- DSK16-220 (0.62 - 8.66" / 16 - 220 mm)
- DSK16-320 (0.62 - 12.59" / 16 - 320 mm) (delivery in two boxes)

FOR ALL SIZES AND PART NUMBERS, PLEASE SCAN THE PRODUCT QR CODE

PURGE OXYGEN MONITOR



HANDY PURGE 100SC SELF CALIBRATING WELD PURGE MONITOR

Measures oxygen down to 0.01% (100 ppm)

The Handy Purge 100SC is a precise, self-calibrating oxygen monitor for weld purging, measuring levels from 20.9% down to 0.01%. It ensures welding starts only when oxygen is sufficiently purged, preventing discoloration or oxidation of the weld. Compact, lightweight, and rugged, it includes a probe, flow adapter, vacuum hand pump, hose, carry case, and calibration certificate. Compatible with all purge systems and argon setups, it provides both continuous monitoring and sampling, making it ideal for welders, QA teams, and field engineers. This essential tool reduces purge gas waste, boosts quality, and removes guesswork from weld environment management.

PART NO HP100SC



EXPANDING PIPE STOPPERS - NYLON

1.5 - 6" / 38 - 150 mm

PPM Nylon Pipe Stoppers are lightweight, corrosion-resistant plugs for sealing and low-pressure testing in 1.5 - 6" / 38 - 150 mm pipes. Featuring a rubber expanding seal and simple wing nut design, they're ideal for plumbing, drainage, and utility work. Available in solid or hollow versions, they support pressure testing and gas purging. These reusable stoppers meet BS8005 standards and offer an affordable, reliable solution for temporary pipe isolation during maintenance or fabrication.

FOR ALL SIZES AND PART NUMBERS, PLEASE SCAN THE PRODUCT QR CODE



EXPANDING PIPE STOPPERS - ALUMINIUM

1.5 - 24" / 40 - 600 mm

PPM Aluminium Pipe Stoppers provide strong, reusable sealing for 1.5 - 24" / 40 - 600 mm pipes. Designed for low-pressure testing and purging, they feature a central shaft and rubber seal for a tight fit. Resistant to corrosion and heat (up to 90°C), they're ideal for industrial and mechanical pipelines. Hollow versions allow gas flow or pressure checks. Built to BS8005 standards, they offer durability and ease of use across frequent sealing applications.

FOR ALL SIZES AND PART NUMBERS, PLEASE SCAN THE PRODUCT QR CODE

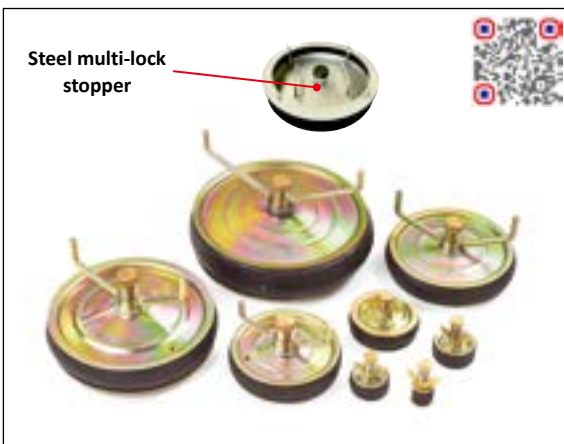

EXPANDING PIPE STOPPERS - STEEL

1.5 - 36" / 40 - 900 mm (Larger sizes available upon request)

PPM Steel Pipe Stoppers deliver heavy-duty sealing and testing in pipes from 1.5 - 36" / 40 - 900 mm. Made with robust steel and rubber seals, they're heat-resistant to 90°C and conform to BS8005 standards. Ideal for industrial environments like power, oil, and gas, they support purging, low-pressure testing, and blocking. Multilock options for larger pipes ensure enhanced sealing. Built for strength and repeat use, they're the top choice for demanding applications.

FOR ALL SIZES AND PART NUMBERS, PLEASE SCAN THE PRODUCT QR CODE



INFLATABLE PIPE STOPPERS

2 - 72" / 50 - 1,800 mm

PPM Inflatable Pipe Stoppers offer flexible, easy-to-use sealing for 2 - 72" / 50 - 1,800 mm pipes. Made from rubber and PU-coated nylon, they inflate via Schrader valve and adapt to tight or curved areas. Available in multiple shapes, they're ideal for temporary blocking, testing, and weld purging. Heat-resistant models withstand up to 500°C. Lightweight and reusable, they're perfect for HVAC, utilities, and fabrication tasks requiring fast, effective sealing.

FOR ALL SIZES AND PART NUMBERS, PLEASE SCAN THE PRODUCT QR CODE





www.AXXAIR.com



www.MAGNATECHLLC.com

ORBITAL WELDING & CUTTING



Originally founded in 1997, the brand **AXXAIR** encompasses within S.F.E. Group the overall tube working processes: orbital cutting, tube bevelling, squaring and orbital GTAW welding.

The **AXXAIR** brand has been in the global market for nearly 30 years and has established itself as a leading and international reference on the field of tube processing applications. **AXXAIR** offers innovative solutions to improve processes, productivity, efficiency and quality in the field of orbital cutting, bevelling and welding on a wide variety of different materials such as stainless steel, titanium, carbon steel, duplex and super duplex stainless steel, nickel alloys and even plastic.

Within the **AXXAIR** range S.F.E. Group not only offers a standard range of products, but also customized solutions for specific target markets: the food and beverage industry, aerospace, pharmaceuticals, the manufacturing of semi-conductors, aeronautics, chemical and petrochemical industry as well as the nuclear industry and many other possible areas of application.

The S.F.E. Group **AXXAIR** brand portfolio consists of a **complete range of orbital cutting machines** (0.25 - 40" / 5 - 1,016 mm), **orbital bevelling machines** (0.6 - 12.75" / 15 - 328 mm o/d), **squaring machines** (0.1 - 8.5" / 3 - 220 mm o/d), as well as **welding machines: prefabrication welding solutions** (0.5 - 12.75" / 12 - 328 mm o/d), **SATO and OX open heads** (0.4 - 8.265" / 10 - 220 mm o/d), **SATFX closed heads** (0.25 - 6.625" / 6 - 170 mm o/d), the **Microfit welding X- and SAMX-ranges** (0.118 - 1" / 3 - 25.4 mm o/d), and finally the **SATP tube to tube sheet** (0.47 - 3.23" / 12 - 82 mm o/d) application.

Being a patented manufacturer of orbital tube and pipe processing machines, **AXXAIR** is constantly exploring new concepts in the field of orbital tube cutting, pipe bevelling, and GTAW orbital welding.

AXXAIR products are always nearby available within the S.F.E. Group global network and can be consulted on the dedicated website: www.AXXAIR.com.

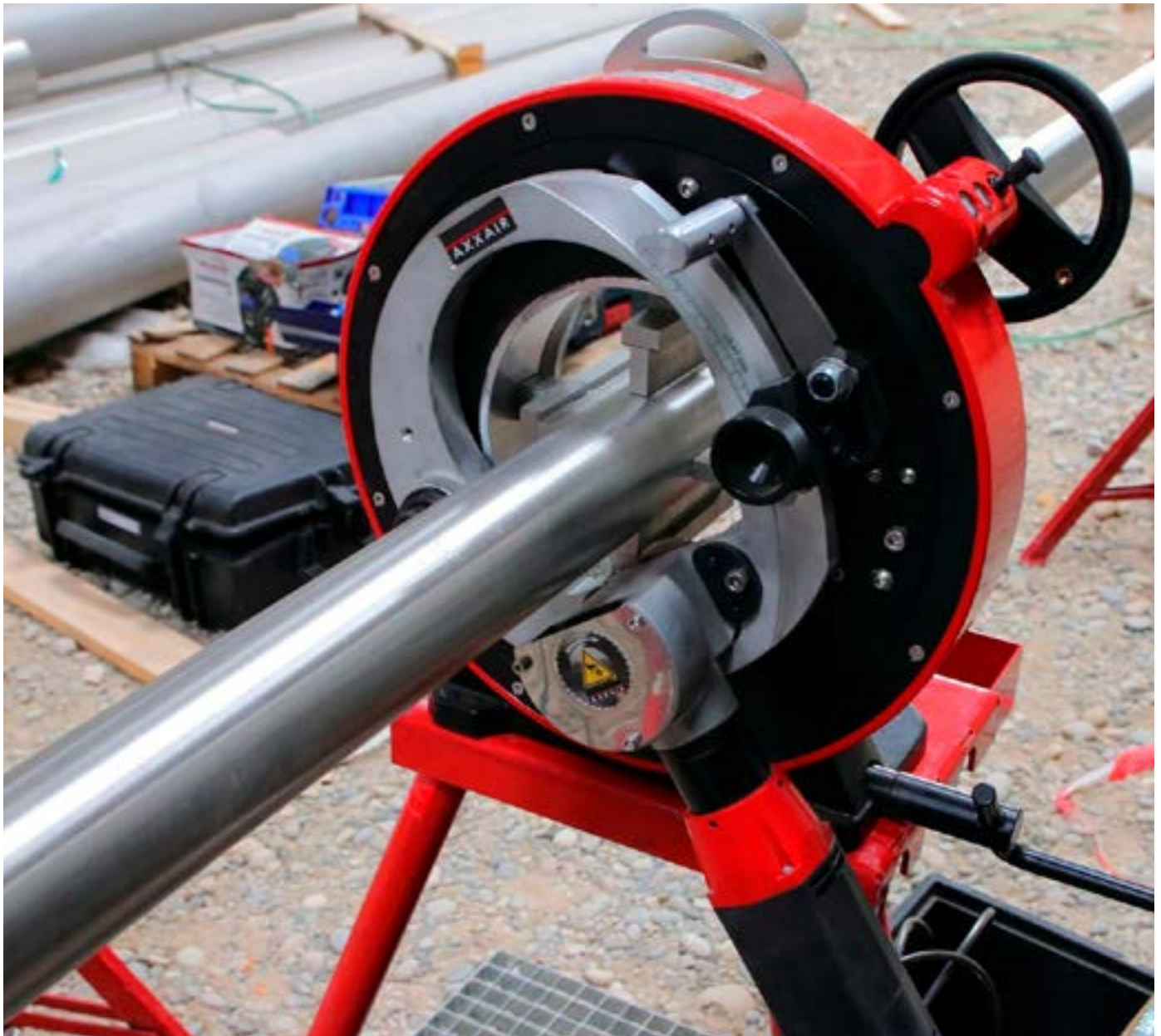



**ECO RANGE 81M / 121ECO / 171 ECO
ORBITAL CUTTING MACHINES**

0.25 - 6.625" / 5 - 170 mm
Power: electric 110v or 220v

AXXAIR's ECO Range - comprising the 81M, 121ECO, and 171ECO orbital cutting machines - is designed to deliver precision, affordability, and efficiency in tube cutting operations. With a cutting capacity of 0.25 - 6.625" / 5 - 170 mm outer diameter, this range ensures burr-free, square cuts across a variety of steel and exotic alloys. Lightweight yet powerful, each machine features a stainless steel concentric clamping system for maximum stability and minimal distortion. Ideal for users who require high-quality orbital cuts without bevelling or welding capabilities, the ECO range stands out as a cost-effective solution for tubing and thin pipe processing.

FOR ALL SIZES AND PART NUMBERS, PLEASE SCAN THE PRODUCT QR CODE



**CC RANGE - MEDIUM DIMENSIONS CC122 / CC172 / CC222 / CC322
ORBITAL CUTTING MACHINES**

0.25 - 12.750" / 5 - 328 mm
Power: pneumatic or electric 110v or 220v

AXXAIR's CC Range for medium dimensions - featuring the CC122, CC172, CC222, and CC322 models - offers versatile orbital cutting machines engineered for precision and adaptability. Covering a cutting range of 0.25 - 12.75" / 5 - 328 mm outer diameter, these machines are ideal for high-performance tube and pipe cutting across all steel types and exotic alloys. Each unit is designed with a modular stainless steel clamping system that ensures burr-free, distortion-free square cuts. Easily upgradeable for bevelling and welding, the CC range excels in demanding environments where flexibility, repeatability, and conversion between cutting, bevelling, and welding are essential for productivity and operational efficiency.

FOR ALL SIZES AND PART NUMBERS, PLEASE SCAN THE PRODUCT QR CODE

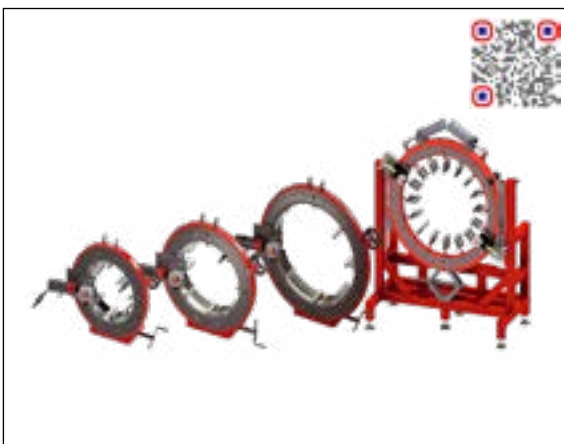

**CC RANGE - LARGE DIMENSIONS CC421 / CC521 / CC721 / CC1100
ORBITAL CUTTING MACHINES**

8.625 - 42.52" / 212 - 1,080 mm
Power: pneumatic or electric 110v or 220v

The AXXAIR CC Range for large dimensions - models CC421, CC521, CC721, and CC1100 - delivers powerful orbital cutting solutions for heavy-duty pipe applications. Designed to handle tube outer diameters from 8.625 - 42.52" / 212 - 1,080 mm, these machines offer unmatched cutting capacity and performance on all steels and exotic alloys. Each unit features a robust stainless steel concentric clamping system to ensure stability, precision, and minimal tube distortion. With burr-free, square cuts and optional automatic rotation, this range is ideal for industrial settings demanding repeatability, high throughput, and superior cut quality on large-diameter tubing and thick-walled pipes.

FOR ALL SIZES AND PART NUMBERS, PLEASE SCAN THE PRODUCT QR CODE

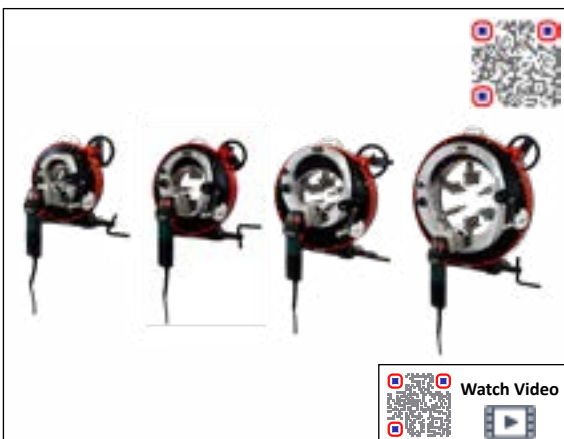

**GA RANGE - GA122 / GA172 / GA222 / GA322
ORBITAL BEVELLING MACHINES**

0.625 - 12.750" / 15 - 328 mm
Power: electric 110v or 220v

The AXXAIR GA Range - comprising models GA122, GA172, GA222, and GA322 - offers high-performance orbital bevelling machines designed for precise and efficient weld preparation. Suitable for tube outer diameters from 0.625 - 12.75" / 15 - 328 mm, these machines are optimized for all types of steel and exotic alloys. Featuring a patented system with high-speed carbide inserts, the GA range achieves clean, consistent bevels up to 0.314" / 8 mm thick - ten times faster than traditional methods. Equipped with stainless steel concentric clamping for distortion-free results and compatible with both V and J bevel geometries, this range is easily upgradeable for cutting and welding - ensuring maximum productivity and safety in demanding industrial applications.

FOR ALL SIZES AND PART NUMBERS, PLEASE SCAN THE PRODUCT QR CODE



DC25 / DC65 TUBE FACING MACHINES

0.1 - 2.5" / 3 - 63.5 mm

Power: battery or electric 110v / 220v

The AXXAIR DC25 and DC65 tube facing machines are precision-engineered solutions designed for the accurate preparation of tube ends prior to welding. Suitable for tube outer diameters ranging from 0.1 - 2.5" / 3 - 63.5 mm, these machines provide burr-free, perfectly square surfaces essential for high-quality, repeatable welds. Whether battery-powered or electric, both models are compact, lightweight, and highly portable - ideal for both workshop and on-site applications. The DC25 is optimal for smaller diameters and microfittings, while the DC65 offers added versatility with the ability to perform simultaneous facing and bevelling. Equipped with stainless steel clamping collets, ergonomic handles, and high-performance HSS TiAlN-coated inserts, these machines deliver exceptional control, precision, and surface finish. Designed for use in critical industries such as pharmaceuticals, semiconductors, aerospace, and biotechnology, the DC25 and DC65 help reduce contamination, improve weld integrity, and streamline productivity, making them indispensable tools in precision tube fabrication workflows.

FOR ALL SIZES AND PART NUMBERS, PLEASE SCAN THE PRODUCT QR CODE



DC115AM / DC221AM TUBE FACING MACHINES WITH CLAMPING JAWS

0.5 - 8.625" / 12 - 220 mm

Power: electric 110v or 220v

The AXXAIR DC115 and DC221 tube facing machines with clamping jaws are high-precision, robust solutions for preparing tube ends in demanding industrial environments. Designed for tube outer diameters from 0.5 - 8.625" / 12 - 220 mm, these machines ensure burr-free, perpendicular finishes that are critical for orbital and manual welding applications. Powered by a 1300W electric motor, both models offer dual-speed operation for optimal control and finish quality. The DC115AM is equipped for smaller diameters, while the DC221AM accommodates larger tube sizes and can simultaneously operate three tools for facing and bevelling in one pass. Featuring rugged stainless steel or aluminum clamping jaws, a graduated vernier scale, and ergonomic operation, they provide fast, repeatable, and precise results. These machines are ideal for industries such as aerospace, pharmaceutical, energy, and semiconductor manufacturing, where high-purity, contamination-free weld prep is essential. Compact yet powerful, the DC115AM and DC221AM are engineered for reliability, portability, and maximum operational efficiency.

FOR ALL SIZES AND PART NUMBERS, PLEASE SCAN THE PRODUCT QR CODE



DC115BM / DC221BM TUBE FACING MACHINES WITH CONCENTRIC CLAMPING

0.5 - 8.625" / 12 - 220 mm

Power: electric 110v or 220v

The AXXAIR DC115BM and DC221BM tube facing machines with concentric clamping are engineered for high-precision end preparation of tubes in critical fabrication environments. Covering outer diameters from 0.5 - 8.625" / 12 - 220 mm, these machines deliver burr-free, square-facing and bevelling up to 3 mm wall thickness, essential for high-integrity welds. Powered by a 1300W electric motor with two-speed operation, they offer optimal control and performance. The concentric clamping system - using 4 stainless steel jaws for the DC115BM and 6 for the DC221BM - ensures uniform pressure, eliminates tube distortion, and enhances operator safety. These machines are ideal for clean-room and high-spec applications in industries such as pharmaceuticals, semiconductors, nuclear, and food processing. Ergonomic design, precision scaling, and optional integration with height-adjustable AXXAIR benches further support accuracy and ease of use. The DC115BM and DC221BM with concentric clamping combine reliability, portability, and superior performance for demanding tube preparation tasks.

FOR ALL SIZES AND PART NUMBERS, PLEASE SCAN THE PRODUCT QR CODE

Combine with Pipe Purge Masters (PPM) solutions

SX RANGE - FUSION / FUSION + WIRE PREFABRICATION ORBITAL WELDING

0.5 - 12.750" / 12 - 328 mm
Air or water-cooled

The SX-range prefabrication orbital welding machine by AXXAIR is a high-precision, multi-functional system for workshop-based tube assembly. It supports TIG welding with or without filler wire and quickly switches to cutting or bevelling with two screws. Suitable for tubes from 0.5 - 12.750" / 12 - 328 mm and all steel types, including exotic alloys, it's powered by the reliable SAXX power source. Key features include concentric clamping to reduce distortion, automatic rotation, and mechanical tube tracking. Stainless steel jaws prevent contamination and corrosion, making it ideal for hygienic applications. The SX-range enhances productivity and weld quality while minimizing on-site labor.

FOR ALL SIZES AND PART NUMBERS, PLEASE SCAN THE PRODUCT QR CODE

Combine with Pipe Purge Masters (PPM) solutions

Watch Video

SX RANGE - WITH AVC / OSC SYSTEM PREFABRICATION ORBITAL WELDING

0.5 - 12.750" / 12 - 328 mm
Water-cooled

The SX-range orbital welding machine with AVC/OSC system offers high-precision pipe prefabrication for diameters from 0.5 - 12.750" / 12 - 328 mm. Integrating motorized Arc Voltage Control and Oscillation, it ensures consistent arc height and optimal weld quality, even for thick-walled pipes. Compatible with various materials, including exotic alloys, it supports multi-pass TIG welding with filler wire. Features like axial sweep, concentric clamping, and stainless steel jaws enhance accuracy and prevent contamination. Powered by the SAXX source, it easily transitions between cutting, bevelling, and welding. Designed for workshop use, it boosts productivity and ensures reliable, hygienic, and repeatable fabrication results.

FOR ALL SIZES AND PART NUMBERS, PLEASE SCAN THE PRODUCT QR CODE

Combine with Pipe Purge Masters (PPM) solutions

Watch Video

X RANGE - X-500 / X-750 ORBITAL WELDING: MICROFIT CLOSED HEADS

0.118 - 0.75" / 3 - 19.05 mm

The AXXAIR X-500 and X-750 are advanced orbital welding heads engineered for precision work in restricted spaces. The X-500, the slimmest closed head in the range, welds tube diameters from 0.118 - 0.5" / 3 to 12.7 mm and delivers up to 30 welds per hour. It is available in air- or water-cooled versions and features a quick-fit cassette system, greaseless design, and cleanroom compatibility - ideal for semiconductor, aerospace, and pharmaceutical uses. The X-750 extends capability up to 0.75" / 19.05 mm, with high-duty water cooling, quick-connect collets, adjustable clamping, and a pivoting welding window. Both heads include integrated remote controls, easy maintenance, and are compatible with SAXX and other power sources for exceptional weld reliability.

FOR ALL SIZES AND PART NUMBERS, PLEASE SCAN THE PRODUCT QR CODE

Combine with Pipe Purge Masters (PPM) solutions

Watch Video

SAMX RANGE - SAMX-17 / SAMX-25 ORBITAL WELDING MICROFIT CASSETTE HEADS

0.118 - 1" / 3 - 25.40 mm

Axxair's SAMX-17 and SAMX-25 are precision orbital TIG weld heads designed for microfit applications. The SAMX-17 supports tubes from 0.118 - 0.625" / 3 - 17.2 mm and is air-cooled, lightweight (12 lbs / 5.5 kg), and cleanroom compatible. It features integrated controls and optimized gas diffusion, offering 100A peak current. The SAMX-25 handles 0.25 - 1" / 6 - 25.4 mm tubes, with air or water cooling options, and up to 120A welding current. It includes similar features with higher duty cycles and a heavier build (14 lbs / 6.5 kg). Both systems use cassette-mounted jaws for optimal tube positioning, have built-in maintenance tools, and are compatible with SAXX power sources. Delivered in shockproof cases, they're ideal for stainless steel and exotic alloy welding in demanding environments.

FOR ALL SIZES AND PART NUMBERS, PLEASE SCAN THE PRODUCT QR CODE





Combine with Pipe Purge Masters (PPM) solutions









Watch Video

SATFX-52 / SATFX-76 / SATFX-115 / SATFX-170
ORBITAL WELDING: CLOSED HEADS

0.25 - 6.625" / 6 - 170 mm
 Water cooled

The SATFX-52, 76, 115, and 170 are water-cooled closed orbital TIG weld heads, designed for precision welding of tubes from 0.25 - 6.625" / 6 - 170 mm O/D. Ideal for stainless steel, nickel, and titanium alloys, they are grease-free and suitable for cleanroom use. These heads provide consistent, high-quality fusion welds without filler metal, making them perfect for demanding industries like pharmaceuticals, semiconductors, and aerospace. Key features include ergonomic handling, adjustable clamping, integrated remote control, optimized gas diffusion, and illuminated status indicators. The SATFX-170, specifically for larger diameters (up to 6.625"), adds dual pivoting windows and enhanced electrode offset adjustment for complex geometries. All models are powered by SAXX sources and compatible with a wide range of accessories.

FOR ALL SIZES AND PART NUMBERS, PLEASE SCAN THE PRODUCT QR CODE





Combine with Pipe Purge Masters (PPM) solutions







Video Coming Soon

(NEW PRODUCT LAUNCHING 2026)

OX-3000 / OX-4500 / OX-6625 (FUSION / FUSION + WIRE)
ORBITAL WELDING: OPEN HEADS

0.75 - 6.625" / 19 - 170 mm
 Water cooled

The OX range of open orbital TIG welding heads, powered by the SAXX power source, offers exceptional performance, versatility, and precision for welding all types of steels and exotic alloys, with or without filler metal. Designed for both on-site and workshop use, the OX heads combine compactness, strength, and modularity, ensuring high productivity even in confined spaces. Available in three models - OX-3000, OX-4500, and OX-6625 - they cover diameters from 0.75 - 6.625" / 19 - 170 mm. Key features include a new water-cooled torch, tool-free setup and adjustment, precise electrode alignment, strong clamping, and an ergonomic handle with remote control. Optional modules such as angle gearhead, clutch, and embedded wire systems further enhance adaptability for diverse industrial applications.

FOR ALL SIZES AND PART NUMBERS, PLEASE SCAN THE PRODUCT QR CODE





Combine with Pipe Purge Masters (PPM) solutions





SATO-220 (FUSION / FUSION + WIRE)
ORBITAL WELDING: OPEN HEAD

1.5 - 8.625" / 38 - 220 mm
 Air or water cooled

The SATO-220 features compact open orbital TIG weld heads designed for tube diameters from 1.5 - 8.625" / 38 - 220 mm. Engineered for use with all steels and exotic alloys, this weld head ensure high-quality results even in tight spaces. Ideal for sectors like power generation and petrochemicals, the SATO range includes both water- and air-cooled versions with straight or angled motors. Key features include dual-axis torch adjustment, precise electrode positioning, quick lever-based tube clamping, and smooth, scratch-free mechanical tracking. Powered by SAXX sources (200A-300A), the system supports both fusion and wire-feed welding. The machine is supplied in a robust, waterproof case for easy transport and protection. A full range of accessories - purging kits, wire feeders, and consumables - completes the solution.

FOR ALL SIZES AND PART NUMBERS, PLEASE SCAN THE PRODUCT QR CODE





Combine with Pipe Purge Masters (PPM) solutions





SATO RANGE (WITH AVC / OSC SYSTEM)
ORBITAL WELDING: OPEN HEADS

0.75 - 8.625" / 19 - 220 mm
 Water cooled

AXXAIR's SATO weld heads with AVC/OSC are high-precision orbital TIG solutions for pipes from 0.75 - 8.625" / 19 - 220 mm. Designed for sectors like power generation and petrochemicals, they enable multipass welding on wall thicknesses up to 12.7 mm. Equipped with motorized arc voltage control (AVC) and torch oscillation (OSC), these heads ensure a consistent arc length and efficient filler wire deposition. The OSC system sweeps the electrode ±10 mm axially, while AVC automatically adjusts electrode-tube distance, improving weld quality. Available in three models (SATO-115, 170, 220), they offer straight or angled motor versions, water cooling, and compatibility with SAXX-210/300 power sources. The machine is supplied in a robust, waterproof case for easy transport and protection. A full range of accessories - purging kits, wire feeders, and consumables - completes the solution.

FOR ALL SIZES AND PART NUMBERS, PLEASE SCAN THE PRODUCT QR CODE



SATP-80X
ORBITAL WELDING: TUBE TO TUBESHEET

0.47 - 3.23" / 12 - 82 mm
 Water cooled

The SATP orbital TIG welding head is designed for tube-to-tubesheet applications, covering tube diameters from 0.47 - 3.23" / 12 - 82 mm. Fully water-cooled, it is ideal for producing heat exchangers in industries like aeronautics, agri-food, and energy. It features a tilting head, built-in wire dispenser, and a spring-loaded centering mandrel system for precise, fast tube alignment. Adjustable positioning stops and a head/wire trolley ensure flexibility and stability during welding. The SATP-80X supports wire feed at speeds up to 200 cm/min and operates with SAXX power sources up to 300 A. Compatible mandrels and spindles accommodate various tube sizes, while AXXAIR's pre-ground tungsten electrodes ensure welding consistency. The system offers reliable, high-quality welds for demanding industrial applications.

PART NO: SATP-80X

PIPE PURGING SYSTEMS



(NEW PRODUCT LAUNCHING 2026)



WELDPURE PURGE PLUGS

0.35 - 4.33" / 9 - 110 mm

The PPM WeldPure purge plugs ensure efficient, high-quality weld purging through an optimized gas-flow design. Depending on plug size, selected models feature an off-center gas inlet and outlet to promote progressive, directional oxygen evacuation for faster, more reliable inerting - working in combination with the integrated gas diffuser to deliver stable, uniform gas distribution. Covering pipe diameters from 0.35 - 4.33" / 9 - 110 mm, the 14 plug sizes are clearly marked for quick identification and ease of use. Durable, reusable, and designed for practical on-site operation, the complete kit is neatly organized in a robust, foam-lined transport case. Ideal for demanding applications requiring high-purity welds, it offers a cost-effective, all-in-one solution for consistent, high-performance purging.

Standard kit available: SPSK09-110 (0.35 - 4.33" / 9 - 110 mm)

FOR ALL SIZES AND PART NUMBERS, PLEASE SCAN THE PRODUCT QR CODE

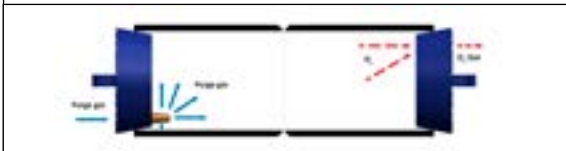

Heat Resistant
 up to 450°C

DOUBLE SEAL SYSTEMS

0.75 - 12" / 16 - 320 mm

PPM Double Seal Systems (available as individual and standard kits) deliver rapid, gas-efficient weld purging using high-grade silicone discs to form airtight seals. Suitable for pipes from 0.75 - 12" / 16 - 320 mm, they reduce purge times to under two minutes and are reusable, interchangeable, and heat-resistant to 450°C. Their flexible or rigid tube connectors adapt to elbows and fittings, while the compact design enables use in tight or complex geometries. Available individually or as kits - including the Gas Finger range for small diameters - these systems ensure minimal gas use and excellent weld quality. Ideal for pharmaceutical, biotech, food, and high-purity piping, Double Seal Systems are a cost-effective, high-performance purging solution.

Standard kits available:

- DSK16-165 (0.62 - 6.49" / 16 - 165 mm)
- DSK16-220 (0.62 - 8.66" / 16 - 220 mm)
- DSK16-320 (0.62 - 12.59" / 16 - 320 mm) (delivery in two boxes)

FOR ALL SIZES AND PART NUMBERS, PLEASE SCAN THE PRODUCT QR CODE

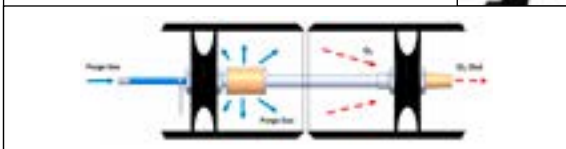



SAXX-200 POWER SUPPLIES

TIG orbital, 200A, autoline 110v to 230v

The SAXX-200 is a 200A orbital TIG welding power source designed for intuitive use and maximum flexibility. It features a 5.7" color touchscreen, multilingual interface, automatic parameter calculation, and integrated printer. Compact and portable, it includes options like dual gas lines with flow control, wire feeder compatibility, and a detachable 700W water-cooling unit. Data acquisition is handled via USB, with real-time monitoring and export to 'WeldReport' software for WPS conversion. Remote access is possible through Ethernet or optional Wi-Fi. Fully compatible with all AXXAIR weld heads, it suits demanding welding applications in industrial environments, with robust alarm systems ensuring operational safety and traceability.

FOR ALL PART NUMBERS, PLEASE SCAN THE PRODUCT QR CODE



SAXX-201 POWER SUPPLIES

TIG orbital, 200A, autoline 110v to 230v

The SAXX-201 is a compact orbital TIG welding power source delivering 200A with intuitive operation. Designed for efficiency, it features a 7" multilingual touchscreen, automatic parameter calculation, and integrated printer. Compatible with all AXXAIR welding heads, it enables real-time data acquisition via USB and remote control through Ethernet, Wi-Fi, or optional pendant. The system supports dual gas lines and wire feed, and can integrate a detachable 700W water-cooling unit for portability. With USB export and 'WeldData' software, users can convert welding logs into WPS formats. The SAXX-201 is ideal for demanding, precise welding tasks across industries, ensuring high performance with user-friendly operation and robust monitoring system.

FOR ALL PART NUMBERS, PLEASE SCAN THE PRODUCT QR CODE



SAXX-210 POWER SUPPLIES

TIG orbital, 210A, autoline 110v to 230v

The SAXX-210 is a 210A orbital TIG power source engineered for precision and ease of use. It offers intuitive programming with a 5.7" touchscreen and remote pendant, multilingual interface, and automatic parameter calculation. The integrated data logging system captures and stores welding parameters every second on USB, compatible with 'WeldReport' software for WPS generation. It includes dual gas line with flow control, wire feeder connectivity, and a powerful 700W water-cooling unit. Wi-Fi connectivity and AVC/OSC support are optional for advanced welding needs. The unit is compatible with all AXXAIR heads, making it highly versatile for industrial applications that demand consistency, traceability, and full control of welding conditions.

FOR ALL PART NUMBERS, PLEASE SCAN THE PRODUCT QR CODE



SAXX-300 POWER SUPPLIES

TIG orbital, 300A, 380v

The SAXX-300 is a robust 300A orbital TIG power source, ideal for high-demand industrial welding. With a user-friendly 5.7" touchscreen, multilingual interface, and a 4-meter remote pendant, it offers intuitive programming and automatic parameter calculation. It features a built-in 700W water-cooling unit, dual gas line management, and wire feeder compatibility. The SAXX-300 provides advanced data acquisition via USB, logging every second, and integrates with 'WeldReport' software for WPS export. Remote monitoring is available through Ethernet or optional Wi-Fi. It supports AVC/OSC axis control and is compatible with all AXXAIR and most third-party weld heads. Designed for precision, repeatability, and ease of use, the SAXX-300 ensures consistent results for complex multi-pass orbital TIG welding applications.

FOR ALL PART NUMBERS, PLEASE SCAN THE PRODUCT QR CODE



(NEW PRODUCT LAUNCHING 2026)

**AMX-52 / AMX-115 / AMX-170
ORBITAL WELDING: CLOSED HEADS**

0.25 - 6.625" / 6 - 170 mm

Compatible with selected AMI/Magnatech power supplies - Water cooled

The AMX-52, 115, and 170 are water-cooled closed orbital TIG weld heads designed for precision welding of tubes from 0.25 - 6.625" / 6 - 170 mm O/D. Built for cleanroom environments and high-spec industries such as pharmaceuticals, semiconductors, and aerospace, they ensure consistent, high-quality fusion welds without filler metal. The AMX heads offers the same precision and performance as the SATFX range, and are cross-compatible with selected orbital welding power sources, from AXXAIR, Magnatech, and AMI, offering unmatched versatility for users upgrading or expanding their systems. Key features include ergonomic handling, adjustable clamping, and optimized gas diffusion.

PART NO: AMX-52 (0.25 - 2" / 6 - 52 mm o/d)

PART NO: AMX-115 (0.5 - 4.5" / 12 - 115 mm o/d)

PART NO: AMX-170 (1.5 - 6.625" / 38 - 170 mm o/d)



**X RANGE - X-500 / X-750
ORBITAL WELDING: MICROFIT CLOSED HEADS**

0.118 - 0.75" / 3 - 19.05 mm

Compatible with selected AMI/Magnatech power supplies - Air or water cooled

The X range combines AXXAIR's precision engineering with enhanced flexibility for integration with selected orbital welding power sources, from AXXAIR, Magnatech and AMI. Ideal for upgrading or expanding existing systems, these microfit closed heads deliver the same high-quality fusion welds and cleanroom performance as the original models. The X-500, AXXAIR's slimmest closed head, handles tube diameters from 0.118 - 0.5" (3 - 12.7 mm) and is available in air- or water-cooled versions. The X-750 extends capacity up to 0.75" (19.05 mm) with a water-cooled high-duty design, quick-connect collets, and adjustable clamping for efficient, repeatable welding. Both models ensure reliable, precise performance across high-spec applications such as semiconductors, aerospace, and pharmaceuticals.

X-500 (0.118 - 0.5" / 3 - 12.7 mm o/d)

PART NO: X-500MIA (air cooled) / X-500MIE (water cooled)

X-750 (0.118 - 0.75" / 3 - 19.05 mm o/d)

PART NO: X-750MIE (water cooled)



ADAPTER KITS FOR MULTIBRAND WELDING HEADS

The AXXAIR SAXX power supplies' versatility offers the flexibility to optionally connect through dedicated adapter kits with a wide range of welding heads from various other brands.

These kits allow existing orbital welding heads to be integrated with and operated seamlessly by the SAXX power supply technology.

This optional feature eliminates the need for functional equipment disposal and ensures a budget friendly alternative when introducing AXXAIR orbital welding solutions.

Contact us for technical compatibility.



Ever since its inception in the late 1960's, **MAGNATECH** has been a class apart in the world of welding, offering top-of-the-line orbital welding systems to numerous critical industries and applications.

In a world with a rapid decline of skilled welders, it is **MAGNATECH's** mission as an original equipment manufacturer of specialized equipment for orbital pipe - and pipeline welding systems, using the GTAW, FCAW, and GMAW welding processes, to provide world-class solutions and know-how, emphasizing on simplicity, reliability, repeatability, productivity, cost-efficiency, and ease-of-use.

The **MAGNATECH** welding equipment uses auto-programming for both fusion-only and multi-pass welding with filler wire addition and reduces the need for onsite technical specialists to laboriously develop the welding parameters by trial and error. All **MAGNATECH's** orbital systems use interfaces to simplify operations and essentially guarantee repeatable welds.

The key products offered today are the D-Head 420 welding head, T-Head 419 welding head, Pipemaster 515 and 516, the Pipeliner Pro welding machine, including the Pipeliner Pro 616 welding head and its multi-level controller.

MAGNATECH machines are always nearby available within the S.F.E. Group global network and can be consulted on the dedicated website: www.MAGNATECHLLC.com.



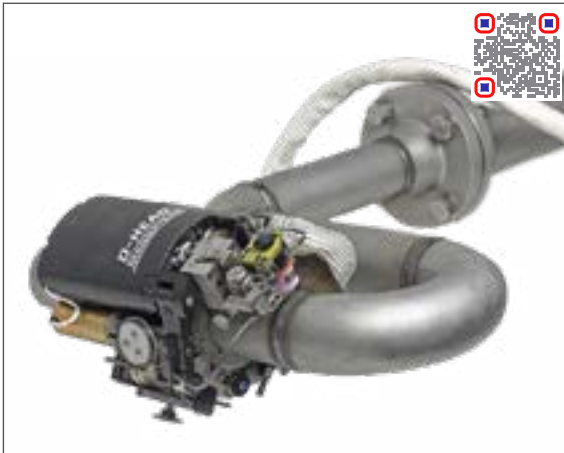

D-HEAD 420
ORBITAL WELDING HEAD FOR MULTI-PASS GTAW PIPE WELDING
 0.84 - 14" / 21.34 - 355.60 mm

The MAGNATECH D-Head 420 is a compact, high precision orbital GTAW weld head designed for multi pass welding of pipes, fittings, and tubesheets. Compatible with Pipemaster 515/516 power supplies, it operates in tight spaces with as little as 2" (51 mm) radial clearance using the low profile version. Interchangeable guide rings cover diameters from 0.84" to 14" (21.34–355.6 mm).

Key features include programmable torch oscillation, precise arc gap control, a multi axis adjustable filler wire aiming, and a head mounted wire feeder with single or dual wire options. Built for extreme conditions, it delivers increased productivity, repeatable weld quality, and reduced repair rates in demanding industrial applications.

D-Head 420 (PART NO: 420PTCB000)
D-Head 420 with dual wire feed (PART NO: 420PTCB0G0) NEW PRODUCT LAUNCHING 2026

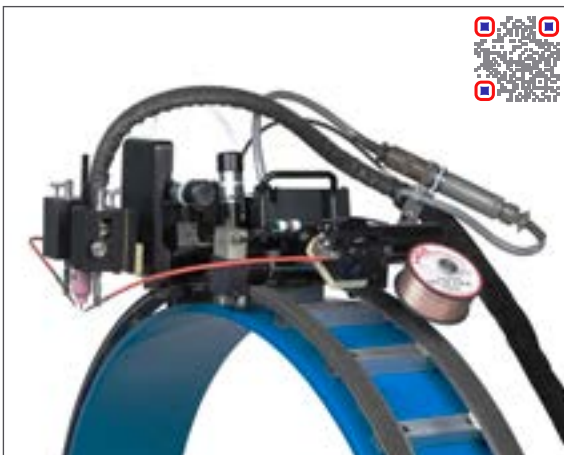

T-HEAD 419
ORBITAL WELDING HEAD FOR MULTI-PASS GTAW PIPE WELDING
 4.5 - 84" / 114.30 - 2,134 mm (larger sizes available)

The MAGNATECH T-Head 419 is a multi-pass orbital GTAW weld head designed for pipe-to-pipe and pipe-to-fitting welding, particularly for large-diameter or heavy-wall applications. Compatible with Pipemaster 515 and 516, it works with carbon-based and exotic alloys. Its interchangeable guide rings and adapter feet support use on preheated pipes and a patented flexible track system allows welds on curved surfaces, including tanks and ductwork. Key features include programmable torch oscillation, real-time arc gap control, a 3-axis adjustable filler wire nozzle, and dual direction wire feeding for large-diameter welds. A patented pneumatic clamping system enables fast mounting without tools, increasing safety and reducing setup time while delivering high welding precision and repeatability.

PART NO: 419AULBPG0



PIPEMASTER 515 POWER SOURCE & CONTROLLER

The Pipemaster 515 is a high-performance orbital welding power supply with a built in controller delivering 200A output with unmatched precision, consistency, and durability. Ideal for multi-pass welding of pipes, tubes, and tubesheets, it offers full weld head control - rotation, wire feed, arc gap, oscillation, and steering. Smart automation includes auto program generation, real-time "teach" mode and programmable limits of welding parameters. A user-friendly color LCD interface with integrated help is built into a waterproof pendant with an internal storage capacity for up to 100 weld programs. With robust construction and intelligent features, the Pipemaster 515 ensures high-efficiency, traceable, and repeatable welds in demanding industrial environments.

PART NO 515GCTBAD0 - AMERICAS
PART NO 515GCTBAH0 - INTERNATIONAL
PART NO 1005832 - WATER COOLER ASSEMBLY



PIPEMASTER 516 POWER SOURCE CONTROLLER

The Pipemaster 516 is a high-output orbital welding power supply controller engineered for demanding environments, offering up to 600A of stable current via an external welding power source delivering the welding current. It enables multi-pass welding on pipes, tubes, and tubesheets, with full control of weld head functions - rotation, filler wire, arc gap, oscillation, and cross-seam steering. Smart automation includes auto program generation, teachmode, and programmable limits of welding parameters. A user-friendly color LCD interface with integrated help is built into a waterproof pendant. Robust design features include an IP65-rated electronic drawer, a coolant recirculator, and safety interlocks. The controller allows seamless head changes, stores up to 100 programs, and offers full data traceability and transfer via USB, ensuring precision and productivity.

PART NO 516EMJB000 - AMERICAS
PART NO 516ENJB000 - INTERNATIONAL
PART NO 1005832 - WATER COOLER ASSEMBLY
** EXTERNAL WELDING POWER SUPPLY REQUIRED*

PIPELINER PRO WELDING MACHINE

The **MAGNATECH Pipeliner Pro** is a mechanized orbital GMAW/FCAW pipe welding system featuring the **TPS400i digital inverter power source** from Fronius. It includes the **Pipeliner Pro Weld Head 616**, which supports high-speed downhill GMAW and uphill FCAW with a 400A water-cooled torch. The system works in collaboration with the **Model 716 controller**, the **Pipeliner Digital Programmer (PDP)** - a 10.4" touchscreen - and remote pendant for precise parameter adjustments. Key features include LSC (Low Spatter Control), pulsed/spray modes, root pass capability with arc penetration stabilizers, and synergic control of output. It supports up to 9 programmable weld passes and is optimized for multi-pass pipe welding.

The Pipeliner Pro configuration consists of the below components:

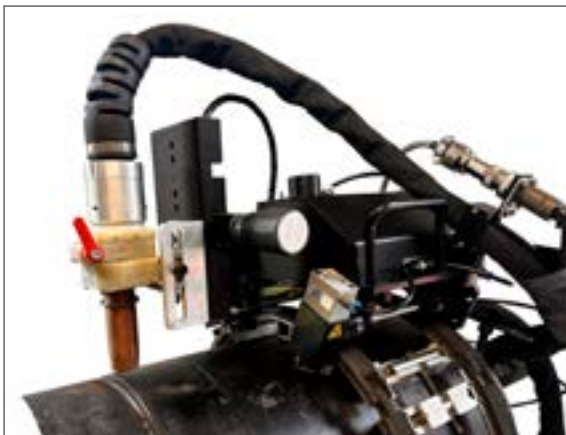

PIPELINER PRO WELD HEAD 616

4.5 - 84" / 114.30 - 2,134 mm

The Pipeliner Pro Weld Head 616 is a high-performance orbital welding head designed for demanding pipe welding applications. It operates with a powerful 400A water-cooled torch mounted on a durable tractor, making it ideal for both FCAW uphill and GMAW high-speed downhill welding, including root pass welding on narrow groove bevels. Its rapid repositioning system provides up to 4" / 101.6 mm of torch motion for quick, accurate recentering. A patented pneumatic clamping system, powered by compressed gas, ensures fast, repeatable, and tool-free installation on the pipe, while the integrated clutch mechanism allows for swift head rotation and positioning, reducing setup time and enhancing field productivity and safety.

PART NO 6160HEB000



DIGITAL INVERTER POWER SOURCE TPS400i

The TPS400i is a digital inverter power source designed for GMAW/FCAW pipe welding. It features synergic control, automatically adjusting output based on electrode wire speed to maintain a stable arc. With Low Spatter Control (LSC), penetration and arc length stabilizers, it ensures uniform penetration and reduced spatter even under variable conditions. The system supports pulsed/spray modes, root pass, and multi-pass welding, offering pre-set programs for standard materials and custom settings for special alloys. Additional components include a wire feeder (10 - 44 lbs / 5 - 20 kg capacity), water cooler with flow sensor, and a cart with bottle rack. The TPS400i delivers high-speed, low-heat input welding with exceptional arc control, minimal manual adjustments, and consistent weld quality even with long torch leads.

PART NO TPS400i



MODEL 716 CONTROLLER AND PIPELINER DIGITAL PROGRAMMER

The Model 716 Controller and Pipeliner Digital Programmer (PDP) offer comprehensive control of weld head parameters for up to 9 passes, optimized for seamless integration with the TPS400i Power Source. The 10.4" HD color touchscreen, mounted on the power source, provides an intuitive, icon-based interface for rapid parameter adjustments. Features include test mode, password protection, a USB port for updates, and a steel enclosure for durability in harsh environments. The system supports both pre-set programs and custom development. The handheld operator pendant enables real-time weld adjustments with a glove-compatible, dust-resistant design and durable cable. With 230 VAC input, this rugged controller ensures reliable, field-ready performance with enhanced flexibility and safety.

PART NO 7160GMB0M0

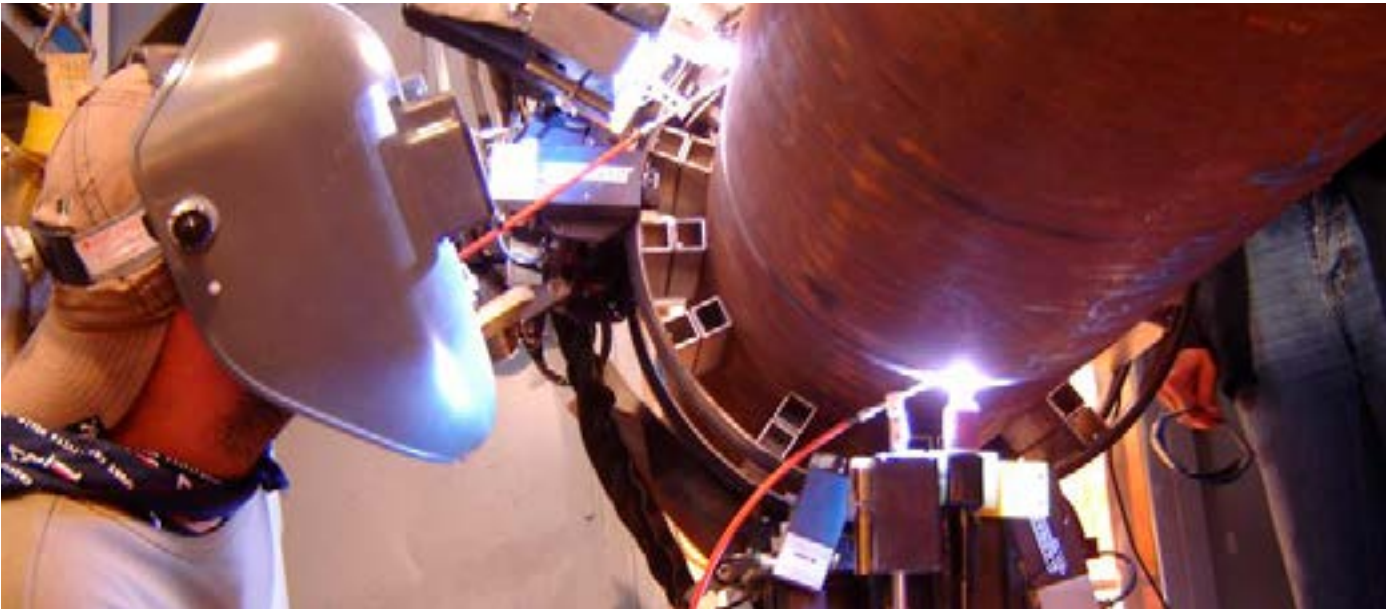



PIPE BEVELLING & ONSITE MACHINING EQUIPMENT



PIPE EQUIPMENT SPECIALISTS

www.TAG-PIPE.com



www.HSTOOL.com



www.BORTECH.com



Portable Machining & Welding Systems

www.CLIMAXPORTABLE.com



www.CALDERTESTERS.com



The S.F.E. Group's brand **TAG Pipe Equipment Specialists LTD** (in short: **TAG PIPE**) has its roots in the 1980's in the United Kingdom with the manufacturing and supplying of pipework fabrication tools and machinery. Over the years TAG PIPE became internationally one of the foremost leaders in its field, and today S.F.E. Group's unrivalled **TAG PIPE** range of cold cutting and bevelling machines is established and recognized as a world class leading brand.

Backed by more than 40 years of development, **TAG PIPE** not only offers the highest quality heavy duty machines utilizing the latest technology, but also stands for an emphasis on continuous R&D and tailor made solutions. As an OEM, S.F.E. Group prides itself being renowned for its innovations, ground-breaking developments and patented designs within the **TAG PIPE** range. With its engineering capabilities, customer-oriented focus and flexibility, the **TAG PIPE** brand provides the possibility to design out-of-the-box machining applications and solutions to fulfil customers' projects' specific needs in particular, and to cater for an ever-evolving industry in general.

The **TAG PIPE** brand portfolio consists of a complete range of portable pipe bevel machines (PREP machines covering 1 - 24"), the **TAG PIPE** cutting and bevelling splitframe clamshell machines (1 - 120"), as well as the stationary, yet moveable E-Z FAB machines (2 - 16") for pipe cutting and bevelling, and finally the PMM plate bevel machines.

TAG PIPE machines are always nearby available within the S.F.E. Group global network and can be consulted on the dedicated website: www.TAG-PIPE.com.

TAG PRODUCTS ARE AVAILABLE IN EUROPE / AFRICA / MIDDLE EAST / ASIA PACIFIC





PREP 2 PORTABLE PIPE BEVELLING MACHINE

0.9 - 1.65" / 23 - 42 mm (optional from 0.5" i/d / 12.5 mm i/d)

The TAG PREP 2 is a compact, precision-engineered portable pipe beveling machine designed for pipework with internal diameters ranging from 0.9 - 1.65" / 23 - 42 mm, optionally down to 0.5" / 12.5 mm (TP2RSK, reduced shaft kit option). As the smallest in TAG's acclaimed PREP series, this unit is ideal for high-volume, repetitive work in heat exchanger and boiler panel applications. Optimized for thin and heavy wall tubes, the PREP 2 is perfect for maintenance professionals who demand portability, precision, and durability in confined or on-site environments.

Despite its lightweight frame, it delivers robust performance using a torque-reactive, through-shaft locking system that eliminates the need to externally fix the pipe. With power options including pneumatic, electric, and battery drives (110v or 220v), the PREP 2 features a 4-jaw chuck allowing up to four tools for simultaneous internal/external beveling and facing. The CNC-machined and nickel-plated aluminum body ensures strength, stability, and long service life.

PREP 2 PNEUMATIC (PART NO TP2P - requires AFL1 or DEFE-FRL5 air filter lubricator)

PREP 2 ELECTRIC (PART NO TP2E110 / TP2E220)

PREP 2 BATTERY (PART NO TP2B110 / TP2B220)

PREP 2 PNEUMATIC AUTO LOCK (PART NO TP2PALD - requires AFL1 air filter lubricator)

PREP 2 COMPLETE LEVER (PART NO TP2PALL - requires AFL1 or DEFE-FRL5 air filter lubricator)

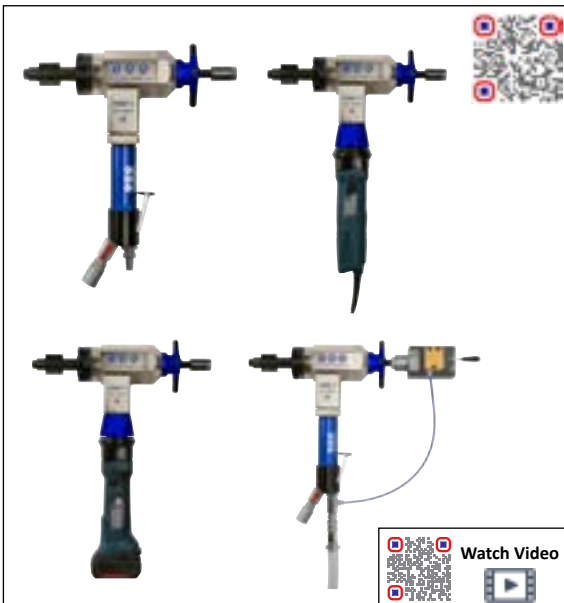

PREP 3 PORTABLE PIPE BEVELLING MACHINE

1.1 - 2.99" / 28 - 76 mm (optional from 0.8" i/d / 20 mm i/d)

The TAG PREP 3 is a high-performance, in-line feed pipe beveling machine designed for internal diameters of 1.1 - 2.99" / 28 - 76 mm, with an optional range starting at 0.8" / 20 mm, optionally down to 0.5" / 12.5 mm (TP3RSKV2, reduced shaft kit option). Renowned for its superior power-to-weight ratio, this tool is ideal for boiler maintenance, weld removal, and J-prepping across various industrial sectors.

Like all TAG PREP machines, it features a torque-reactive design and secure thru-shaft locking system for vibration-free operation without needing external clamping. A robust 4-jaw chuck accommodates multiple tool types for simultaneous operations, including internal/external beveling, facing, and counter-boring. Built with a durable, CNC-machined aluminum body and nickel-plated components, the PREP 3 excels in repeatable, high-precision weld preparations. Powered via pneumatic, electric, or battery (110v/220v) options, it ensures reliable performance in challenging environments. The TAG PREP 3 is a trusted choice for professionals seeking portability, power, and repeatability in compact form.

PREP 3 PNEUMATIC (PART NO TP3P - requires AFL1 or DEFE-FRL5 air filter lubricator)

PREP 3 ELECTRIC (PART NO TP3E110 / TP3E220)

PREP 3 BATTERY (PART NO TP3B110 / TP3B220)

PREP 3 PNEUMATIC AUTO LOCK (PART NO TP3PALD - requires AFL1 or DEFE-FRL5 air filter lubricator)

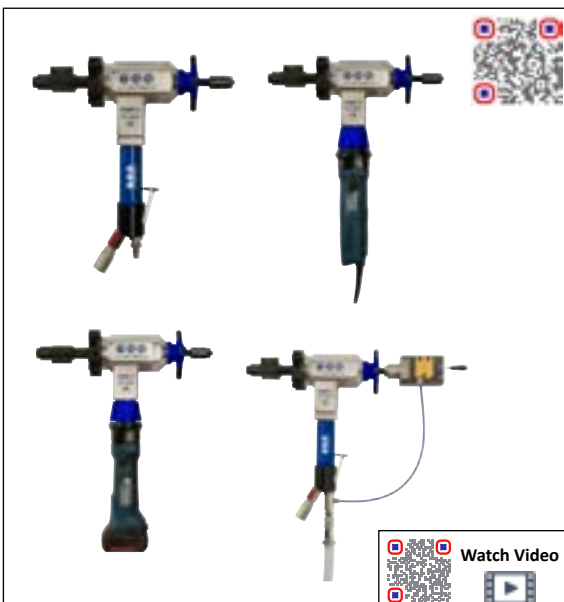

PREP 4 PORTABLE PIPE BEVELLING MACHINE

1.1 - 4.40" / 28 - 112 mm

The TAG PREP 4 is a versatile and powerful pipe beveling machine tailored for pipes with internal diameters of 1.1 - 4.40" / 28 - 112 mm. Designed to deliver optimal performance in industrial settings such as power generation and manufacturing, it is a staple in high-volume boiler repair and maintenance operations.

This machine integrates a 4-jaw tool holder for executing simultaneous internal and external beveling, J-prepping, and counter-boring. Torque-reactive and easily operable without externally fixing the pipe, the PREP 4 uses TAG's proven thru-shaft locking system, ensuring excellent alignment and chatter-free cutting. Users can select from pneumatic, battery, or electric (110v/220v) power sources for adaptability across job sites. Precision-machined aluminum construction with nickel plating ensures durability and structural integrity under load. Whether working with stainless steel or exotic alloys, the PREP 4 offers the strength and flexibility needed for exacting pipe end preparations.

PREP 4 PNEUMATIC (PART NO TP4P - requires AFL1 or DEFE-FRL5 air filter lubricator)

PREP 4 ELECTRIC (PART NO TP4E110 / TP4E220)

PREP 4 BATTERY (PART NO TP4B110 / TP4B220)

PREP 4 PNEUMATIC AUTO LOCK (PART NO TP4PALD - requires AFL1 or DEFE-FRL5 air filter lubricator)

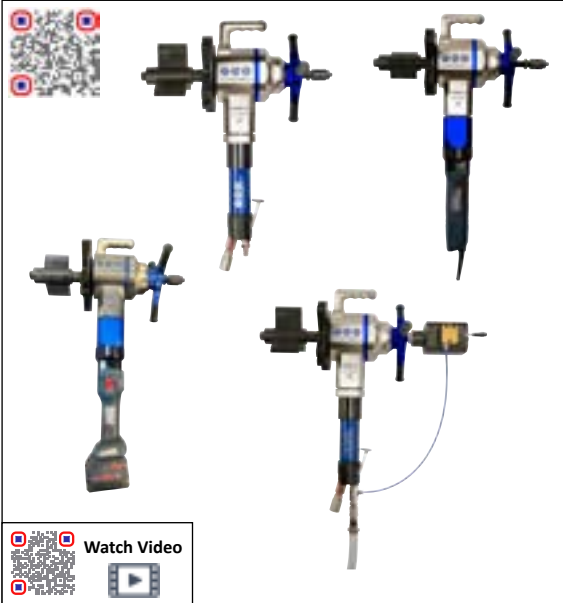

PREP 8 PORTABLE PIPE BEVELLING MACHINE

1.96 - 8.46" / 50 - 215 mm

Engineered for heavy-duty performance, the TAG PREP 8 is a robust pipe beveling machine suitable for internal pipe diameters ranging from 1.96 - 8.46" / 50 - 215 mm. Favoured in both field and workshop environments, it delivers exceptional torque for cutting and prepping thick-walled and exotic alloy pipes.

Featuring TAG's offset 4-jaw tool holder, it accommodates multiple cutting tools for compound bevels, J-prepping, and simultaneous internal/external beveling. Its torque-reactive design eliminates the need to clamp the pipe externally, ideal for on-site use during maintenance shutdowns or pipe fabrication tasks. Offered with pneumatic, electric, or battery-powered drives, the PREP 8 combines power and portability with safety and precision. The CNC-machined, nickel-plated aluminum body ensures structural integrity and long-lasting durability. This workhorse excels in high-volume applications that demand rugged reliability and repeatable accuracy, making the TAG PREP 8 a leader in portable pipe prep solutions.

- PREP 8 PNEUMATIC (PART NO TP8P - requires AFL1 or DEFE-FRL5 air filter lubricator)**
- PREP 8 ELECTRIC (PART NO TP8E110 / TP8E220)**
- PREP 8 BATTERY (PART NO TP8B110 / TP8B220)**
- PREP 8 PNEUMATIC AUTO LOCK (PART NO TP8PALD - requires AFL1 or DEFE-FRL5 air filter lubricator)**

ACCESSORIES & OPTIONS - PREP 2 / 3 / 4 / 8

ACCESSORIES & OPTIONS FOR TAG PREP 2 / 3 / 4 / 8

The TAG PREP series 2 / 3 / 4 / 8 can be fitted with a wide range of options and accessories, enhancing both its capability and versatility. These customisable features allow operators to tailor the machine to specific operational needs, ensuring optimal performance across a variety of applications. Key accessories include:



ELBOW / FITTINGS SHAFT

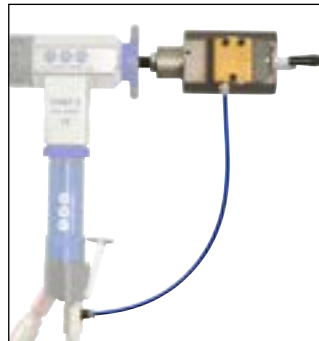

PNEUMATIC AUTO LOCK SYSTEM



RATCHET HANDLES



MILLING HEAD



FEED STOPPER
(ONLY ON PREP 2 / 3 / 4)

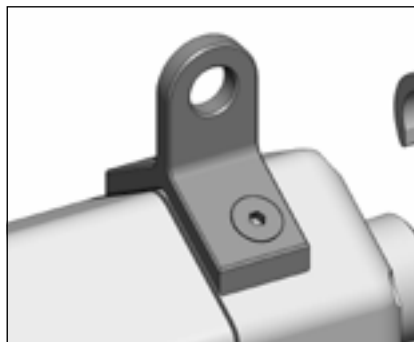

LIFTING EYE
(ONLY ON PREP 2 / 3 / 4)



FLANGE FACER
(ONLY ON PREP 4)

FLANGE FACING MACHINE



(NEW PRODUCT LAUNCHING 2026)



PREP 4 FLANGE FACING MACHINE / ACCESSORY

ID facing diameter: 1.57 - 7" / 40 - 180 mm

ID clamping range: 1 - 4" / 23 - 112 mm

The TAG PREP 4 Flange Facing Machine is a compact, portable solution for precision flange repair and resurfacing. Engineered for flat face, raised face, and spot-facing applications, it delivers accurate, repeatable phonographic finishes for gasket sealing. With an ID facing diameter of 1.57 - 7" / 40 - 180 mm and adjustable RMS surface finish options (63 - 500), the machine combines robust performance with ease of transport, making it ideal for on-site and workshop use. Compatible with carbon steel, stainless steel, and exotic alloys, it offers pneumatic, electric, or battery power options (110v / 220v) for maximum flexibility. Designed to meet ASME / ANSI B16.5 and CE standards, this heavy-duty machine ensures reliability in demanding industries such as oil & gas, petrochemical, power generation, and marine. The PREP 4 flange facing machine also offers an optional elbow kit, enabling flange facing on elbows for complex pipeline configurations.

Available as a standalone unit or as a conversion kit for existing TAG PREP 4 pipe bevelling machines.

FOR ALL PART NUMBERS, PLEASE SCAN THE PRODUCT QR CODE

PANEL PREP MACHINES



PANEL PREP MACHINE

0.3 - 4" / 8 - 108 mm o/d

TAG Panel Prep Machines provide precise and efficient pipe end preparation for panel-mounted tubes, with a working range of 0.3 - 4" / 8 - 108 mm outer diameter. Designed for tough, small-bore pipes in high-pressure or high-temperature systems, they utilize external o/d clamping jaws to ensure minimal vibration and maximum repeatability. With models including the Panel Prep 2, 3, and 4, these machines are offered with pneumatic, battery, or electric power drives. The robust feed system, featuring an ergonomic handwheel, allows smooth control during bevelling, facing, and weld removal. Each model is tailored to a specific pipe diameter, using dedicated jaws for optimal clamping and concentricity. Suitable for materials such as stainless steel, duplex, and exotic alloys, TAG Panel Prep Machines are a staple in heat exchanger manufacturing, boiler repair, and tube sheet refurbishing. Their lightweight build, safety-first design, and repeatable results make them a critical tool in tube panel fabrication.

FOR ALL PART NUMBERS, PLEASE SCAN THE PRODUCT QR CODE





Combine with SUMNER
Material Lifts solutions







Watch Video



PREP 16 PORTABLE PIPE BEVELLING MACHINE

2.9 - 15.75" / 72 - 400 mm

The TAG PREP 16 is a heavy-duty pipe beveling machine designed for demanding applications on internal diameters of 2.9 - 15.75" / 72 - 400 mm. Featuring a ratcheted locking system and multi-position tool holders, it supports a wide range of bevel geometries, J-preps, counter-bores, and compound bevels.

Recommended with a powerful servo-electric motor but also available in pneumatic and hydraulic drive formats, the PREP 16 delivers precise control with minimal operator effort. Its 6-point locking jaw system offers exceptional grip, while optional auto-feed and pipe stand attachments improve setup speed and mobility. With CNC-machined components and nickel-plated finishes, the PREP 16 ensures structural integrity, especially critical in offshore, nuclear, and precision weld environments. Compact for its class yet incredibly powerful, it is ideal for scenarios where both accuracy and output are essential.

The TAG PREP 16 sets a new standard for mid-to-large diameter portable pipe beveling systems.

PREP 16 SERVO ELECTRIC (PART NO TP16SE110 / TP16SE220)

PREP 16 SERVO ELECTRIC WITH AUTO FEED (PART NO TP16SE110AF / TP16SE220AF)

PREP 16 PNEUMATIC (PART NO TP16P - requires AFL2 or DEFE-FRL5 air filter lubricator)

PREP 16 HYDRAULIC (PART NO TP16H)





Combine with SUMNER
Material Lifts solutions







Watch Video



PREP 24 PORTABLE PIPE BEVELLING MACHINE

6.89 - 23.62" / 175 - 600 mm

The TAG PREP 24 is the largest model in the PREP series, designed for pipe diameters from 6.89 - 23.62" / 175 - 600 mm. It excels in challenging environments where accuracy, strength, and repeatability are non-negotiable - such as offshore installations and power station shutdowns.

Like the PREP 16, it features ratcheted locking and feed systems, self-centering six-point locking jaws, and a 4-position tool holder for complex weld preps including J-prepping, compound beveling, and counter-boring. The PREP 24 is compatible with servo-electric (recommended), pneumatic, or hydraulic motors. Its servo models offer remote operation and programmable speed control, improving safety and consistency. Designed with strength in mind, this machine integrates TAG's advanced bearing and drive designs to maximize torque and reduce wear. With durable, precision-machined construction and support for heavy wall applications, the PREP 24 is an industrial-grade solution for large-scale pipe preparation tasks.

PREP 24 SERVO ELECTRIC (PART NO TP24SE110 / TP24SE220)

PREP 24 SERVO ELECTRIC WITH AUTO FEED (PART NO TP24SE110AF / TP24SE220AF)

PREP 24 PNEUMATIC (PART NO TP24P - requires AFL2 or DEFE-FRL5 air filter lubricator)

PREP 24 HYDRAULIC (PART NO TP24H)





Combine with SUMNER
Material Lifts solutions







Watch Video





PREP 16 & 24 ELBOW / FITTING PIPE BEVELLING MACHINES

The TAG PREP 16 and PREP 24 Elbow/Fitting Machines are advanced beveling solutions for curved and shaped components like elbows and pipe fittings. The PREP 16 handles diameters of 5.11 - 16.14" / 130 - 410 mm, while the PREP 24 covers 8.26 - 23.62" / 210 - 600 mm. Designed to address the challenges of non-linear and hard-to-clamp surfaces, these machines feature a compact drive shaft and a 6-jaw locking mechanism that ensures stable, accurate cutting. Available with pneumatic, hydraulic, or servo-electric motors, they are ideal for applications requiring bevels, J-preps, counter-boring, and compound facing on non-straight pipe segments. Their lightweight yet rugged construction enables easy mobility while maintaining exceptional cutting precision. Commonly used in flange preparation, elbow beveling, and custom fitting work, these machines are indispensable for professionals requiring a complete, portable solution for challenging geometry machining.

FOR ALL PART NUMBERS, PLEASE SCAN THE PRODUCT QR CODE



Combine with SUMNER
Material Lifts solutions



Watch Video



SPLIT FRAME CLAMSHELLS COLD CUTTING AND BEVELLING MACHINES

1 - 48" / 33.4 - 1,220 mm o/d

The TAG Split Frame Clamshell series (1 - 48" / 33.4 - 1,220 mm o/d) offers high-precision cold cutting and bevelling for a wide range of pipe sizes. Built from high-grade aluminum with reinforced steel, it's ideal for industrial use. Capable of external/internal bevelling, counter-boring, J-preps, and compound bevelling on all steel types and exotic alloys.

Modular or telescopic jaws ensure fast, concentric setups - even on out-of-round pipes. Power options include pneumatic, hydraulic, electric, and servo drives (110v - 480v), as standard in-line motors, and as well as front drive and elbow motor options. TAG's unique gear-driven slides allow adjustable radial feed. Designed for reliable, repeatable results in the field or workshop.

FOR ALL SIZES AND PART NUMBERS, PLEASE SCAN THE PRODUCT QR CODE



Combine with SUMNER
Material Lifts solutions



Watch Video



SPLIT FRAME CLAMSHELLS COLD CUTTING AND BEVELLING MACHINES

48 - 120" / 1,220 - 3,050 mm o/d

TAG's large-diameter Split Frame Clamshells (48 - 120" / 1,220 - 3,050 mm o/d) provide precision cold cutting and bevelling for large pipes and vessels. Designed as portable lathes, they excel at severing, facing, counter-boring, and prepping in demanding environments. A steel outer frame with a precision inner ring gear and hardened clamping feet ensures repeatable centering.

Drive options include pneumatic, hydraulic, and NC servo electric motors for global use, as standard in-line motors, and as well as front drive and elbow motor options. These machines perform simultaneous cutting and bevelling with tool slides that support multiple configurations and adjustable radial feeds. Ideal for offshore, power, and petrochemical industries.

FOR ALL SIZES AND PART NUMBERS, PLEASE SCAN THE PRODUCT QR CODE



SPLIT FRAME CLAMSHELL CNC CROSSBAR

6.6 - 76" / 168 - 1,930 mm i/d min - o/d max

The TAG Split Frame Clamshell series (6.6 - 76" / 168 - 1,930 mm i/d min - o/d max) can be fitted with a single point fully programmable CNC crossbar.

The CNC crossbar can perform the following functions: external V-J-bevelling / internal bevelling / counter-boring / compound bevelling / weld removal / flange facing flange preparation (flat face, raised face, RTJ groove, male & female) / Norsok compact flange machining / o/d turning / radius preparation / heat exchanger seal face machining.

FOR ALL SIZES AND PART NUMBERS, PLEASE SCAN THE PRODUCT QR CODE



E-Z FAB PIPE CUTTING AND BEVELLING MACHINE

2 - 16" / 60 - 420 mm o/d

The TAG E-Z FAB is a cutting-edge, fully automated pipe cutting and bevelling system for diameters of 2 - 16" / 60 - 420 mm o/d. Designed for high-speed productivity in workshop environments, it combines a robust frame with a touchscreen NC servo electric control unit operating at 110V or 220V. This system supports clockwise/counter-clockwise rotation and multiple automation modes for weld preparation. Suitable for carbon steel, stainless steel, and exotic alloys, E-Z FAB machines can perform cutting and bevels on any material with a minimum pipe length of 9.84" / 250 mm. The tool utilizes the same principles as TAG's split frame clamshells but adds advanced control for consistent, high-quality finishes. Ideal for serial production or custom jobs in high-throughput fabrication shops, E-Z FAB ensures safety, accuracy, and fast turnaround in precision pipe machining.

FOR ALL SIZES AND PART NUMBERS, PLEASE SCAN THE PRODUCT QR CODE



Watch Video



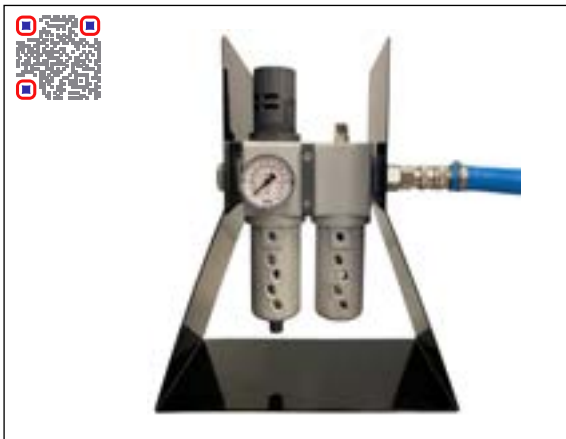

AIR FILTER LUBRICATOR AFL1

Compatible with TAG PREP 2/3/4/8, PANEL PREP RANGE, PREP 4 FLANGE FACING MACHINE

Compatible with TAG Splitframe clamshells: TSFC3 - TSFC24

Designed for compatibility with the indicated TAG range, in both single and double pneumatic drive versions ensuring clean, regulated, and lubricated airflow for maximum machine performance. With a maximum input pressure of 10 bar (145 psi) and an impressive flow rate of 2500 L/min (88,3 CFM), this unit guarantees reliable operation even in demanding environments.

PART NO. AFL1

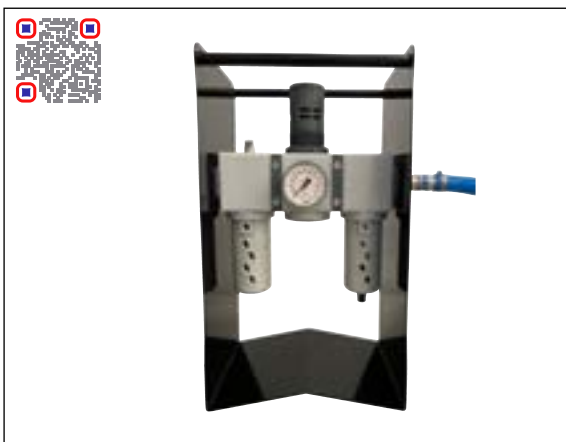

AIR FILTER LUBRICATOR AFL2

Compatible with TAG PREP 16 & 24

Compatible with TAG Splitframe clamshells: TSFC30 - TSFC120

Designed for compatibility with the indicated TAG range, in both single and double pneumatic drive versions ensuring clean, regulated, and lubricated airflow for maximum machine performance. With a maximum input pressure of 10 bar (145 psi) and an impressive flow rate of 5000 L/min (177 CFM), this unit guarantees reliable operation even in demanding environments.

PART NO. AFL2

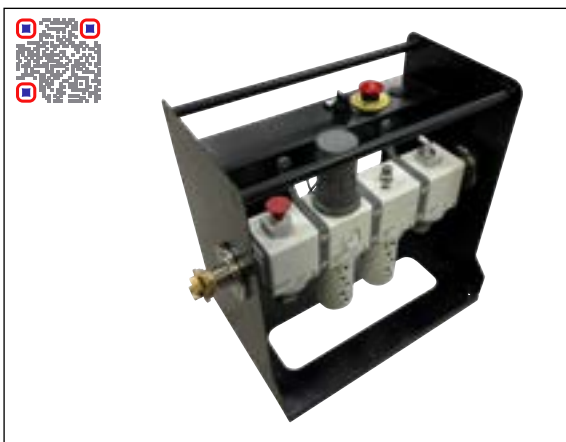

(NEW PRODUCT LAUNCHING 2026)

AIR FILTER LUBRICATOR WITH EMERGENCY STOP

Compatible with complete TAG range

This air filter lubricator unit with integrated emergency stop delivers optimal air preparation and safety for pneumatic systems. Designed for compatibility with the entire TAG range, in both single and double pneumatic drive versions, it ensures clean, regulated, and lubricated airflow for maximum machine performance. With a maximum input pressure of 10 bar (145 psi) and a flow rate of 5000 L/min (177 CFM), this unit guarantees reliable operation even in demanding environments, while the integrated emergency stop provides instant pneumatic power cut-off for enhanced safety.

PART NO. DEFE-FRL5



(NEW PRODUCT LAUNCHING 2026)

AIR FILTER LUBRICATOR WITH EMERGENCY STOP AND AUTOMATIC STRIKER SYSTEM

Compatible with TAG splitframe clamshells

This system is designed for seamless integration with TAG Split Frame machines, supporting both single and double pneumatic drive configurations. This robust accessory ensures precise control and safe operation for cutting and bevelling tasks, featuring a control case with an emergency stop button, an air filter lubricator unit, a pneumatic feed mechanism, and 3-meter connection hoses. Engineered for high performance, it operates at a maximum input pressure of 10 bar (145 psi) and delivers a flow rate of 5000 L/min (177 CFM). The system provides essential functions such as start/stop rotation, accurate tool feed control, and a dedicated emergency stop for complete pneumatic power cut-off, guaranteeing reliability, enhanced safety, and easy integration into your machining process.

PART NO. DEFE-BOX1



PMM155 HANDHELD PLATE BEVELLER

RANGE: thickness 1.5 mm upwards / bevel angle from 22.5° - 60°
Max bevel width 16 mm / Max radius 5 mm

The TAG PMM155 is a lightweight, portable handheld plate bevelling machine built for fast and precise edge prep on steel and stainless steel plates. Ideal for site or workshop use, it performs straight or contoured bevels on flat surfaces, improving weld joint quality. The PMM155 features a single milling head with replaceable indexable inserts, providing smooth and efficient material removal with minimal operator fatigue. With high-speed cutting performance and ergonomic grip, it offers superior control even in extended use. It's suited for a variety of applications, from structural steelwork to pressure vessel manufacturing, and ensures consistent, clean bevels on both thick and thin materials. Designed for durability and ease of use, the PMM155 is a reliable solution for achieving repeatable weld prep in demanding environments where time, precision, and portability matter.

FOR ALL SIZES AND PART NUMBERS, PLEASE SCAN THE PRODUCT QR CODE



PMM200 HANDHELD PLATE BEVELLER

RANGE: thickness 6 - 60 mm / bevel angle from 0° - 60°

The TAG PMM200 is a robust, high-performance handheld plate beveller for heavy-duty plate edge preparation prior to welding. Designed for steel and stainless steel, the PMM200 features a single milling head with 10 square indexable inserts for consistent, clean bevels. Capable of bevelling up to 1.5 meters per minute, it's powered by a 110V or 220V motor, and includes ergonomic guide rollers to reduce vibration and improve control. Ideal for use in fabrication shops or construction sites, the machine enables operators to maintain bevel consistency and operator safety, even over prolonged use. Its vibration-insulated casing protects both electronics and users, while its compact footprint and durable build make it easy to transport and handle. The PMM200 is an essential tool for professionals requiring repeatable, efficient plate bevelling in high-productivity welding environments.

FOR ALL SIZES AND PART NUMBERS, PLEASE SCAN THE PRODUCT QR CODE



The S.F.E. Group's brand **H&S TOOL** has its roots in the 1970's in the United States with the manufacturing and supplying of pipework fabrication machinery. Over the years **H&S TOOL** became internationally one of the foremost leaders in its field, and today S.F.E. Group's unrivalled **H&S TOOL** range of cold cutting and beveling machines is established and recognized as a world class leading brand.

Backed by more than 50 years of development, **H&S TOOL** not only offers the highest quality heavy duty machines utilizing the latest technology, but also stands for an emphasis on continuous R&D and tailor made solutions. As an OEM, S.F.E. Group prides itself being renowned for its innovations, ground-breaking developments and patented designs within the **H&S TOOL** range. With its engineering capabilities, customer-oriented focus and flexibility, the **H&S TOOL** brand provides the possibility to design out-of-the-box machining applications and solutions to fulfil customers' projects' specific needs in particular, and to cater for an ever-evolving industry in general.

The **H&S TOOL** portfolio consists of a complete range of portable pipe bevel machines (PREP machines covering 1 - 24" i/d), panel prep machines (0.3 - 4" o/d) and the **H&S TOOL** cutting and beveling splitframe clamshell machines (1 - 120" o/d) as well as the stationary, yet moveable E-Z FAB machines (2 - 16") for pipe cutting and beveling.

H&S TOOL machines are always nearby available within the S.F.E. Group Americas' network and can be consulted on the dedicated website: www.HSTOOL.com.

H&S TOOL PRODUCTS ARE AVAILABLE IN NORTH / CENTRAL / SOUTH AMERICA



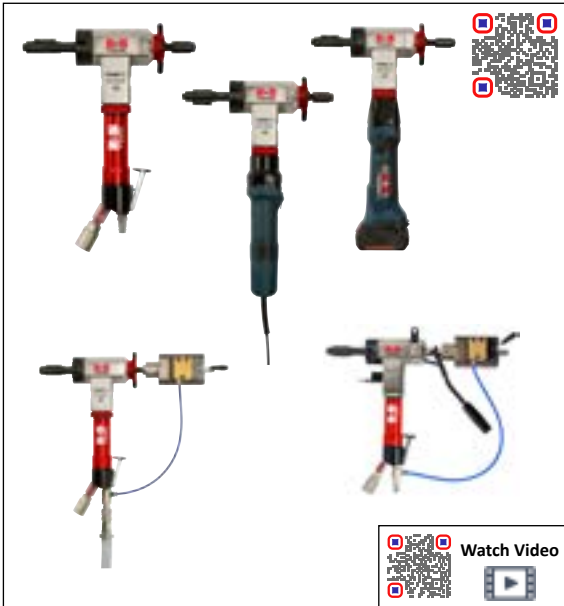

PREP 2 PORTABLE PIPE BEVELLING MACHINE

0.9 - 1.65" / 23 - 42 mm (optional from 0.5" i/d / 12.5 mm i/d)

The H&S TOOL PREP 2 is a compact, precision-engineered portable pipe beveling machine designed for pipework with internal diameters ranging from 0.9 - 1.65" / 23 - 42 mm, optionally down to 0.5" / 12.5 mm (TP2RSK, reduced shaft kit option). As the smallest in H&S TOOL's acclaimed PREP series, this unit is ideal for high-volume, repetitive work in heat exchanger and boiler panel applications. Optimized for thin and heavy wall tubes, the PREP 2 is perfect for maintenance professionals who demand portability, precision, and durability in confined or on-site environments.

Despite its lightweight frame, it delivers robust performance using a torque-reactive, through-shaft locking system that eliminates the need to externally fix the pipe. With power options including pneumatic, electric, and battery drives (110v or 220v), the PREP 2 features a 4-jaw chuck allowing up to four tools for simultaneous internal/external beveling and facing. The CNC-machined and nickel-plated aluminum body ensures strength, stability, and long service life.

PREP 2 PNEUMATIC (PART NO HSP2P - requires AFL1 or DEFE-FRL5 air filter lubricator)

PREP 2 ELECTRIC (PART NO HSP2E110 / HSP2E220)

PREP 2 BATTERY (PART NO HSP2B110 / HSP2B220)

PREP 2 PNEUMATIC AUTO LOCK (PART NO HSP2PALD - requires AFL1 or DEFE-FRL5 air filter lubricator)

PREP 2 COMPLETE LEVER (PART NO HSP2PALL - requires AFL1 or DEFE-FRL5 air filter lubricator)

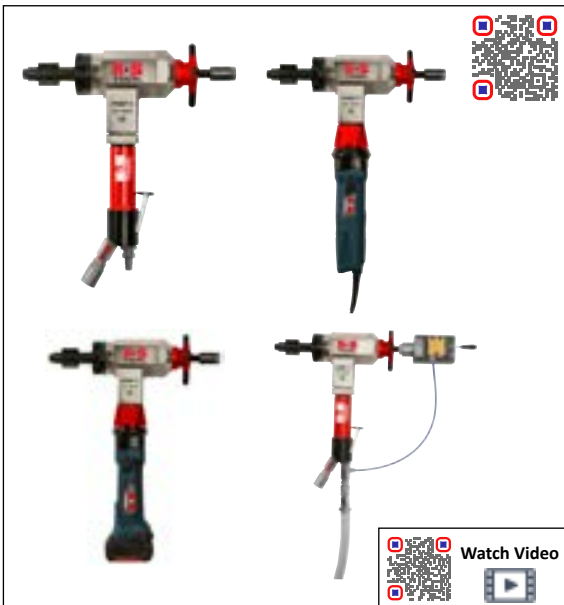

PREP 3 PORTABLE PIPE BEVELLING MACHINE

1.1 - 2.99" / 28 - 76 mm (optional from 0.8" i/d / 20 mm i/d)

The H&S TOOL PREP 3 is a high-performance, in-line feed pipe beveling machine designed for internal diameters of 1.1 - 2.99" / 28 - 76 mm, with an optional range starting at 0.8" / 20 mm, optionally down to 0.5" / 12.5 mm (TP3RSKV2, reduced shaft kit option). Renowned for its superior power-to-weight ratio, this tool is ideal for boiler maintenance, weld removal, and J-prepping across various industrial sectors.

Like all H&S TOOL PREP machines, it features a torque-reactive design and secure thru-shaft locking system for vibration-free operation without needing external clamping. A robust 4-jaw chuck accommodates multiple tool types for simultaneous operations, including internal/external beveling, facing, and counter-boring. Built with a durable, CNC-machined aluminum body and nickel-plated components, the PREP 3 excels in repeatable, high-precision weld preparations. Powered via pneumatic, electric, or battery (110v/220v) options, it ensures reliable performance in challenging environments. The H&S TOOL PREP 3 is a trusted choice for professionals seeking portability, power, and repeatability in compact form.

PREP 3 PNEUMATIC (PART NO HSP3P - requires AFL1 or DEFE-FRL5 air filter lubricator)

PREP 3 ELECTRIC (PART NO HSP3E110 / HSP3E220)

PREP 3 BATTERY (PART NO HSP3B110 / HSP3B220)

PREP 3 PNEUMATIC AUTO LOCK (PART NO HSP3PALD - requires AFL1 or DEFE-FRL5 air filter lubricator)

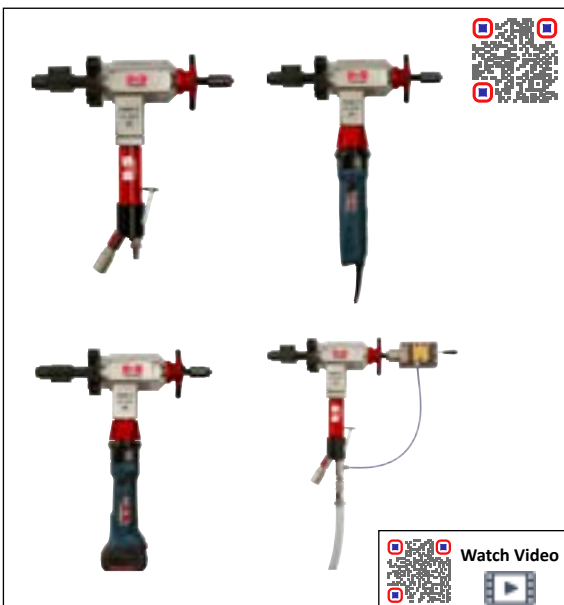

PREP 4 PORTABLE PIPE BEVELLING MACHINE

1.1 - 4.40" / 28 - 112 mm

The H&S TOOL PREP 4 is a versatile and powerful pipe beveling machine tailored for pipes with internal diameters of 1.1 - 4.40" / 28 - 112 mm. Designed to deliver optimal performance in industrial settings such as power generation and manufacturing, it is a staple in high-volume boiler repair and maintenance operations.

This machine integrates a 4-jaw tool holder for executing simultaneous internal and external beveling, J-prepping, and counter-boring. Torque-reactive and easily operable without externally fixing the pipe, the PREP 4 uses H&S TOOL's proven thru-shaft locking system, ensuring excellent alignment and chatter-free cutting. Users can select from pneumatic, battery, or electric (110v/220v) power sources for adaptability across job sites. Precision-machined aluminum construction with nickel plating ensures durability and structural integrity under load. Whether working with stainless steel or exotic alloys, the PREP 4 offers the strength and flexibility needed for exacting pipe end preparations.

PREP 4 PNEUMATIC (PART NO HSP4P - requires AFL1 or DEFE-FRL5 air filter lubricator)

PREP 4 ELECTRIC (PART NO HSP4E110 / HSP4E220)

PREP 4 BATTERY (PART NO HSP4B110 / HSP4B220)

PREP 4 PNEUMATIC AUTO LOCK (PART NO HSP4PALD - requires AFL1 or DEFE-FRL5 air filter lubricator)

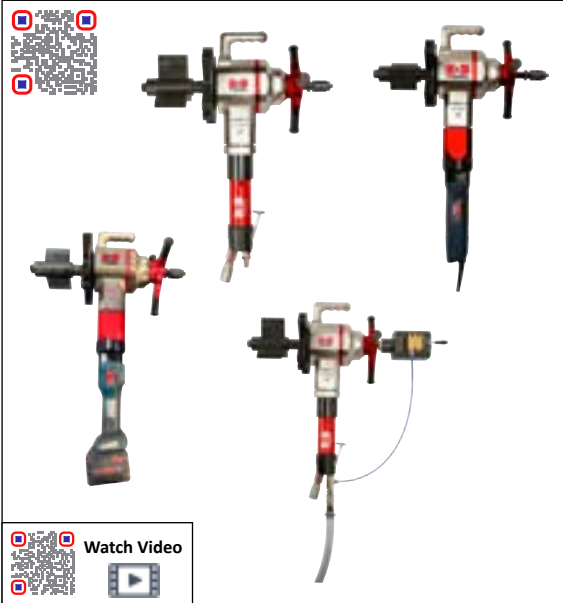

PREP 8 PORTABLE PIPE BEVELLING MACHINE

1.96 - 8.46" / 50 - 215 mm

Engineered for heavy-duty performance, the H&S TOOL PREP 8 is a robust pipe beveling machine suitable for internal pipe diameters ranging from 1.96 - 8.46" / 50 - 215 mm. Favoured in both field and workshop environments, it delivers exceptional torque for cutting and prepping thick-walled and exotic alloy pipes.

Featuring H&S TOOL's offset 4-jaw tool holder, it accommodates multiple cutting tools for compound bevels, J-prepping, and simultaneous internal/external beveling. Its torque-reactive design eliminates the need to clamp the pipe externally, ideal for on-site use during maintenance shutdowns or pipe fabrication tasks. Offered with pneumatic, electric, or battery-powered drives, the PREP 8 combines power and portability with safety and precision. The CNC-machined, nickel-plated aluminum body ensures structural integrity and long-lasting durability. This workhorse excels in high-volume applications that demand rugged reliability and repeatable accuracy, making the H&S TOOL PREP 8 a leader in portable pipe prep solutions.

PREP 8 PNEUMATIC (PART NO HSP8P - requires AFL1 or DEFE-FRL5 air filter lubricator)

PREP 8 ELECTRIC (PART NO HSP8E110 / HSP8E220)

PREP 8 BATTERY (PART NO HSP8B110 / HSP8B220)

PREP 8 PNEUMATIC AUTO LOCK (PART NO HSP8PALD - requires AFL1 or DEFE-FRL5 air filter lubricator)

ACCESSORIES & OPTIONS - PREP 2 / 3 / 4 / 8

ACCESSORIES & OPTIONS FOR TAG PREP 2 / 3 / 4 / 8

The H&S TOOL series 2 / 3 / 4 / 8 can be fitted with a wide range of options and accessories, enhancing both its capability and versatility. These customisable features allow operators to tailor the machine to specific operational needs, ensuring optimal performance across a variety of applications. Key accessories include:



ELBOW / FITTINGS SHAFT

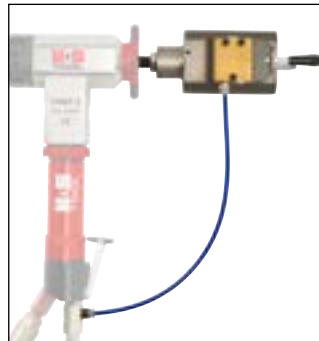

PNEUMATIC AUTO LOCK SYSTEM



RATCHET HANDLES



MILLING HEAD



FEED STOPPER
(ONLY ON PREP 2 / 3 / 4)

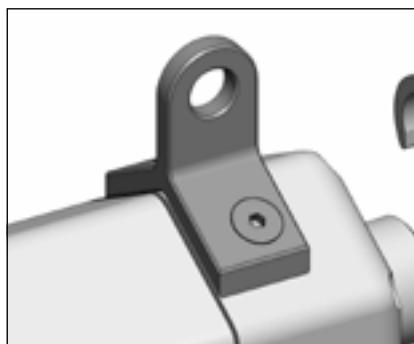

LIFTING EYE
(ONLY ON PREP 2 / 3 / 4)



FLANGE FACER
(ONLY ON PREP 4)

(NEW PRODUCT LAUNCHING 2026)



PREP 4 FLANGE FACING MACHINE / ACCESSORY

ID facing diameter: 1.57 - 7" / 40 - 180 mm

ID clamping range: 1 - 4" / 23 - 112 mm

The H&S TOOL PREP 4 Flange Facing Machine is a compact, portable solution for precision flange repair and resurfacing. Engineered for flat face, raised face, and spot-facing applications, it delivers accurate, repeatable phonographic finishes for gasket sealing. With an ID facing diameter of 1.57 - 7" / 40 - 180 mm and adjustable RMS surface finish options (63 - 500), the machine combines robust performance with ease of transport, making it ideal for on-site and workshop use. Compatible with carbon steel, stainless steel, and exotic alloys, it offers pneumatic, electric, or battery power options (110v / 220v) for maximum flexibility. Designed to meet ASME / ANSI B16.5 and CE standards, this heavy-duty machine ensures reliability in demanding industries such as oil & gas, petrochemical, power generation, and marine. The PREP 4 flange facing machine also offers an optional elbow kit, enabling flange facing on elbows for complex pipeline configurations.

Available as a standalone unit or as a conversion kit for existing H&S TOOL PREP 4 pipe bevelling machines.

FOR ALL PART NUMBERS, PLEASE SCAN THE PRODUCT QR CODE



PANEL PREP MACHINE

0.3 - 4" / 8 - 108 mm o/d

H&S TOOL Panel Prep Machines provide precise and efficient pipe end preparation for panel-mounted tubes, with a working range of 0.3 - 4" / 8 - 108 mm outer diameter. Designed for tough, small-bore pipes in high-pressure or high-temperature systems, they utilize external o/d clamping jaws to ensure minimal vibration and maximum repeatability. With models including the Panel Prep 2, 3, and 4, these machines are offered with pneumatic, battery, or electric power drives. The robust feed system, featuring an ergonomic handwheel, allows smooth control during bevelling, facing, and weld removal. Each model is tailored to a specific pipe diameter, using dedicated jaws for optimal clamping and concentricity. Suitable for materials such as stainless steel, duplex, and exotic alloys, H&S TOOL Panel Prep Machines are a staple in heat exchanger manufacturing, boiler repair, and tube sheet refurbishing. Their lightweight build, safety-first design, and repeatable results make them a critical tool in tube panel fabrication.

FOR ALL PART NUMBERS, PLEASE SCAN THE PRODUCT QR CODE





Combine with SUMNER
Material Lifts solutions







Watch Video



PREP 16 PORTABLE PIPE BEVELLING MACHINE

2.9 - 15.75" / 72 - 400 mm

The H&S TOOL PREP 16 is a heavy-duty pipe beveling machine designed for demanding applications on internal diameters of 2.9 - 15.75" / 72 - 400 mm. Featuring a ratcheted locking system and multi-position tool holders, it supports a wide range of bevel geometries, J-preps, counter-bores, and compound bevels.

Recommended with a powerful servo-electric motor but also available in pneumatic and hydraulic drive formats, the PREP 16 delivers precise control with minimal operator effort. Its 6-point locking jaw system offers exceptional grip, while optional auto-feed and pipe stand attachments improve setup speed and mobility. With CNC-machined components and nickel-plated finishes, the PREP 16 ensures structural integrity, especially critical in offshore, nuclear, and precision weld environments. Compact for its class yet incredibly powerful, it is ideal for scenarios where both accuracy and output are essential.

The H&S TOOL PREP 16 sets a new standard for mid-to-large diameter portable pipe beveling systems.

- PREP 16 SERVO ELECTRIC (PART NO HSP16SE110 / HSP16SE220)**
- PREP 16 SERVO ELECTRIC WITH AUTO FEED (PART NO HSP16SE110AF / HSP16SE220AF)**
- PREP 16 PNEUMATIC (PART NO HSP16P - requires AFL2 or DEFE-FRL5 air filter lubricator)**
- PREP 16 HYDRAULIC (PART NO HSP16H)**





Combine with SUMNER
Material Lifts solutions







Watch Video



PREP 24 PORTABLE PIPE BEVELLING MACHINE

6.89 - 23.62" / 175 - 600 mm

The H&S TOOL PREP 24 is the largest model in the PREP series, designed for pipe diameters from 6.89 - 23.62" / 175 - 600 mm. It excels in challenging environments where accuracy, strength, and repeatability are non-negotiable - such as offshore installations and power station shutdowns.

Like the PREP 16, it features ratcheted locking and feed systems, self-centering six-point locking jaws, and a 4-position tool holder for complex weld preps including J-prepping, compound beveling, and counter-boring. The PREP 24 is compatible with servo-electric (recommended), pneumatic, or hydraulic motors. Its servo models offer remote operation and programmable speed control, improving safety and consistency. Designed with strength in mind, this machine integrates H&S TOOL's advanced bearing and drive designs to maximize torque and reduce wear. With durable, precision-machined construction and support for heavy wall applications, the PREP 24 is an industrial-grade solution for large-scale pipe preparation tasks.

- PREP 24 SERVO ELECTRIC (PART NO HSP24SE110 / HSP24SE220)**
- PREP 24 SERVO ELECTRIC WITH AUTO FEED (PART NO HSP24SE110AF / HSP24SE220AF)**
- PREP 24 PNEUMATIC (PART NO HSP24P - requires AFL2 or DEFE-FRL5 air filter lubricator)**
- PREP 24 HYDRAULIC (PART NO HSP24H)**





Combine with SUMNER
Material Lifts solutions





PREP 16 & 24 ELBOW / FITTING PIPE BEVELLING MACHINES

The H&S TOOL PREP 16 and PREP 24 Elbow/Fitting Machines are advanced beveling solutions for curved and shaped components like elbows and pipe fittings. The PREP 16 handles diameters of 5.11 - 16.14" / 130 - 410 mm, while the PREP 24 covers 8.26 - 23.62" / 210 - 600 mm. Designed to address the challenges of non-linear and hard-to-clamp surfaces, these machines feature a compact drive shaft and a 6-jaw locking mechanism that ensures stable, accurate cutting. Available with pneumatic, hydraulic, or servo-electric motors, they are ideal for applications requiring bevels, J-preps, counter-boring, and compound facing on non-straight pipe segments. Their lightweight yet rugged construction enables easy mobility while maintaining exceptional cutting precision. Commonly used in flange preparation, elbow beveling, and custom fitting work, these machines are indispensable for professionals requiring a complete, portable solution for challenging geometry machining.

FOR ALL PART NUMBERS, PLEASE SCAN THE PRODUCT QR CODE



Combine with SUMNER
Material Lifts solutions



Watch Video

SPLIT FRAME CLAMSHELLS COLD CUTTING AND BEVELLING MACHINES

1 - 48" / 33.4 - 1,220 mm o/d

The H&S TOOL Split Frame Clamshell series (1 - 48" / 33.4 - 1,220 mm o/d) offers high-precision cold cutting and beveling for a wide range of pipe sizes. Built from high-grade aluminum with reinforced steel, it's ideal for industrial use. Capable of external/internal beveling, counter-boring, J-preps, and compound beveling on all steel types and exotic alloys.

Modular or telescopic jaws ensure fast, concentric setups - even on out-of-round pipes. Power options include pneumatic, hydraulic, electric, and servo drives (110v - 480v), as standard in-line motors, and as well as front drive and elbow motor options. H&S TOOL's unique gear-driven slides allow adjustable radial feed. Designed for reliable, repeatable results in the field or workshop.

FOR ALL SIZES AND PART NUMBERS, PLEASE SCAN THE PRODUCT QR CODE



Combine with SUMNER
Material Lifts solutions



Watch Video

SPLIT FRAME CLAMSHELLS COLD CUTTING AND BEVELLING MACHINES

48 - 120" / 1,220 - 3,050 mm o/d

H&S TOOL's large-diameter Split Frame Clamshells (48 - 120" / 1,220 - 3,050 mm o/d) provide precision cold cutting and beveling for large pipes and vessels. Designed as portable lathes, they excel at severing, facing, counter-boring, and prepping in demanding environments. A steel outer frame with a precision inner ring gear and hardened clamping feet ensures repeatable centering.

Drive options include pneumatic, hydraulic, and NC servo electric motors for global use, as standard in-line motors, and as well as front drive and elbow motor options. These machines perform simultaneous cutting and beveling with tool slides that support multiple configurations and adjustable radial feeds. Ideal for offshore, power, and petrochemical industries.

FOR ALL SIZES AND PART NUMBERS, PLEASE SCAN THE PRODUCT QR CODE



Watch Video

SPLIT FRAME CLAMSHELL CNC CROSSBAR

6.6 - 76" / 168 - 1,930 mm i/d min - o/d max

The H&S TOOL Split Frame Clamshell series (6.6 - 76" / 168 - 1,930 mm i/d min - o/d max) can be fitted with a single point fully programmable CNC crossbar.

The CNC crossbar can perform the following functions: external V-J-beveling / internal beveling / counter-boring / compound beveling / weld removal / flange facing flange preparation (flat face, raised face, RTJ groove, male & female) / Norsok compact flange machining / o/d turning / radius preparation / heat exchanger seal face machining.

FOR ALL SIZES AND PART NUMBERS, PLEASE SCAN THE PRODUCT QR CODE



Watch Video

E-Z FAB PIPE CUTTING AND BEVELLING MACHINE

2 - 16" / 60 - 420 mm o/d

The TAG E-Z FAB is a cutting-edge, fully automated pipe cutting and beveling system for diameters of 2 - 16" / 60 - 420 mm o/d. Designed for high-speed productivity in workshop environments, it combines a robust frame with a touchscreen NC servo electric control unit operating at 110V or 220V. This system supports clockwise/counter-clockwise rotation and multiple automation modes for weld preparation. Suitable for carbon steel, stainless steel, and exotic alloys, E-Z FAB machines can perform cutting and bevels on any material with a minimum pipe length of 9.84" / 250 mm. The tool utilizes the same principles as TAG's split frame clamshells but adds advanced control for consistent, high-quality finishes. Ideal for serial production or custom jobs in high-throughput fabrication shops, E-Z FAB ensures safety, accuracy, and fast turnaround in precision pipe machining.

FOR ALL SIZES AND PART NUMBERS, PLEASE SCAN THE PRODUCT QR CODE

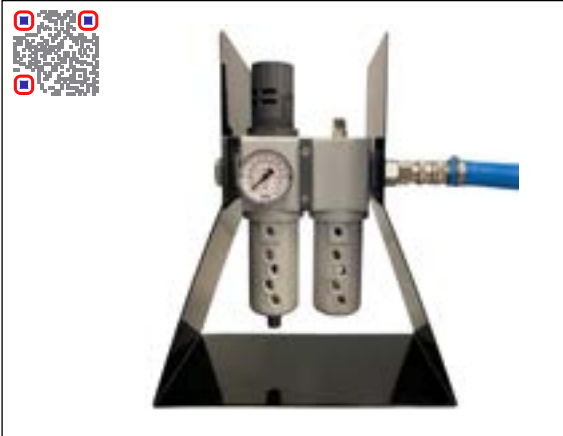

AIR FILTER LUBRICATOR AFL1

Compatible with TAG PREP 2/3/4/8, PANEL PREP RANGE, PREP 4 FLANGE FACING MACHINE

Compatible with TAG Splitframe clamshells: TSFC3 - TSFC24

Designed for compatibility with the indicated TAG range, in both single and double pneumatic drive versions ensuring clean, regulated, and lubricated airflow for maximum machine performance. With a maximum input pressure of 10 bar (145 psi) and an impressive flow rate of 2500 L/min (88,3 CFM), this unit guarantees reliable operation even in demanding environments.

PART NO. AFL1

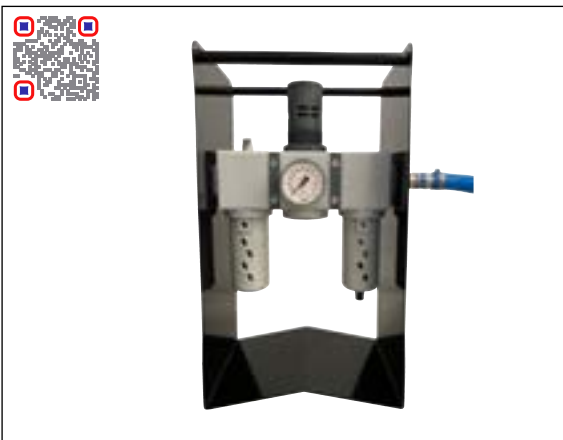

AIR FILTER LUBRICATOR AFL2

Compatible with TAG PREP 16 & 24

Compatible with TAG Splitframe clamshells: TSFC30 - TSFC120

Designed for compatibility with the indicated TAG range, in both single and double pneumatic drive versions ensuring clean, regulated, and lubricated airflow for maximum machine performance. With a maximum input pressure of 10 bar (145 psi) and an impressive flow rate of 5000 L/min (177 CFM), this unit guarantees reliable operation even in demanding environments.

PART NO. AFL2

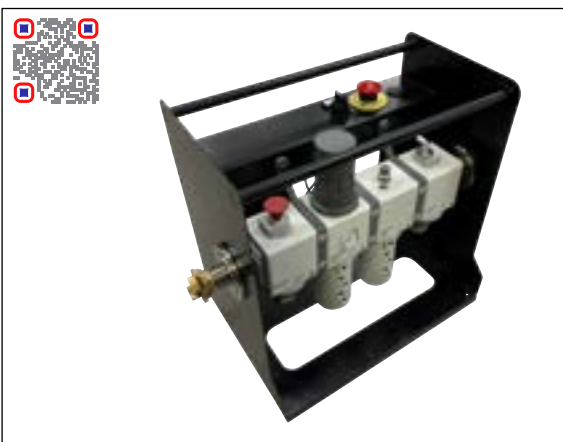

(NEW PRODUCT LAUNCHING 2026)

AIR FILTER LUBRICATOR WITH EMERGENCY STOP

Compatible with complete TAG range

This air filter lubricator unit with integrated emergency stop delivers optimal air preparation and safety for pneumatic systems. Designed for compatibility with the entire TAG range, in both single and double pneumatic drive versions, it ensures clean, regulated, and lubricated airflow for maximum machine performance. With a maximum input pressure of 10 bar (145 psi) and a flow rate of 5000 L/min (177 CFM), this unit guarantees reliable operation even in demanding environments, while the integrated emergency stop provides instant pneumatic power cut-off for enhanced safety.

PART NO. DEFE-FRL5



(NEW PRODUCT LAUNCHING 2026)

AIR FILTER LUBRICATOR WITH EMERGENCY STOP AND AUTOMATIC STRIKER SYSTEM

Compatible with TAG splitframe clamshells

This system is designed for seamless integration with TAG Split Frame machines, supporting both single and double pneumatic drive configurations. This robust accessory ensures precise control and safe operation for cutting and bevelling tasks, featuring a control case with an emergency stop button, an air filter lubricator unit, a pneumatic feed mechanism, and 3-meter connection hoses. Engineered for high performance, it operates at a maximum input pressure of 10 bar (145 psi) and delivers a flow rate of 5000 L/min (177 CFM). The system provides essential functions such as start/stop rotation, accurate tool feed control, and a dedicated emergency stop for complete pneumatic power cut-off, guaranteeing reliability, enhanced safety, and easy integration into your machining process.

PART NO. DEFE-BOX1





The S.F.E. Group's brand **BORTECH** offers a complete suite of automated bore welding systems designed to restore worn internal diameters, outer surfaces, flange faces, and critical sealing areas in industrial components. Known for their portability, reliability, and versatility, these machines are built to handle on-site repair and refurbishment with efficiency and precision. Whether you're welding bores in heavy equipment, repairing shafts, or cladding pressure vessel nozzles, **BORTECH** systems are engineered to improve uptime, reduce repair costs, and deliver high-quality weld overlays consistently.

BORTECH bore welding systems perfectly complement the CLIMAX line boring equipment. Combined, these two S.F.E. Group brands provide a complete solution for precision on-site machining and bore repair - seamlessly integrating boring and welding capabilities for efficient, high-quality results in demanding industrial environments.

At the entry level, the BW1000 is a lightweight, rugged solution ideal for straightforward, repeated bore repairs. It's highly portable and easy to operate, making it perfect for field use, especially in industries like construction and mining. The BW2600 builds on this foundation with added capabilities like automated skip/fill functionality and remote pendant control, offering enhanced weld quality and process control in compact form.

At the top end, the BW3000 and BW5000 provide advanced control systems, multi-axis welding capability, and support for a wide range of exotic alloys support for a wide range of exotic alloy applications on O/Ds, & internal, external tapered & flat faces. These models are designed for professional shops and field service teams needing precision, flexibility, and high deposition rates across a wide range of demanding cladding and buildup applications.

BORTECH machines are always nearby available within the S.F.E. Group network and can be consulted on the dedicated website: www.BORTECH.com.







**COMPATIBLE WITH CLIMAX
LINE BORING MACHINES**



Watch Video



BW1000 AUTO BORE WELDER

Standard Torch Range: 0.88 - 24" / 22.4 - 609.6 mm

The BW1000 Auto Bore Welder is a lightweight, highly portable, and easy-to-use automated welding system designed specifically for bore and flange, that integrates seamlessly with CLIMAX line boring machines. Weighing just 17 lbs / 7.71 kg, it's compact for field work, yet rugged enough to handle demanding industrial environments. It excels in applications requiring repeated buildup of worn bores and large rotating machinery.

The ability to weld in vertical, horizontal, or inverted orientations, the BW1000 ensures flexibility across job types. It features a simple but precise swivel torch head and reverse rotation functionality to alternate uphill and downhill weld passes - ideal for multi-pass applications. Its 9-inch axial travel and modular extension arms allow coverage of long bore surfaces.

The BW1000 dramatically cuts repair time, extends equipment life, and delivers high-quality welds with minimal setup, making it an essential tool for efficient, repeatable bore restoration.

FOR ALL SIZES AND PART NUMBERS, PLEASE SCAN THE PRODUCT QR CODE





**COMPATIBLE WITH CLIMAX
LINE BORING MACHINES**



Watch Video



BW2600 AUTO BORE WELDER

Standard Torch Range: 0.88 - 12" / 22.4 - 304.8 mm

The BW2600 Auto Bore Welder offers a step up in control, flexibility, and precision over the entry-level BW1000. It's ideal when greater automation and weld quality are needed without the size or complexity of a full-featured welding station.

The BW2600 includes enhanced features like automated skip/fill via a mechanical cam system, adjustable step feed, and a user-friendly handheld pendant putting key controls at the operator's fingertips. Multi-pass welds are easier with reverse rotation and manual spindle jog modes, while the step lock-out function supports face welding and custom pass control. It also offers extended torch reach, higher amperage capacity, and improved bead placement accuracy - making it ideal for repeated field work on loader buckets, hydraulic cylinders, gear housings, and valve bodies. The BW2600 strikes a practical balance - compact and rugged for mobile fieldwork, yet refined enough to handle more complex bore welding tasks with confidence and consistency.

FOR ALL SIZES AND PART NUMBERS, PLEASE SCAN THE PRODUCT QR CODE





**COMPATIBLE WITH CLIMAX
LINE BORING MACHINES**



Watch Video



BW3000 AUTO BORE WELDER

Standard Torch Range: 0.50 - 54" / 12.7 - 1,371.6 mm

The BW3000 Auto Bore Welder is the most advanced and capable model in the CLIMAX bore welding lineup. It surpasses both the BW1000 and BW2600 by offering fully digital control over every welding parameter - from step size and wire feed rate to rotation speed and arc voltage - all from a centralized control box. This allows real-time adjustments and consistent, high-quality welds, even on the most challenging surfaces. Features like adjustable step settings, automatic skip zones, pie-mode for localized repair, and carriage return for unidirectional weld passes give operators full command over complex applications, including exotic alloys and large-diameter surfaces.

The BW3000 also integrates seamlessly with CLIMAX line boring systems via a spherical clamp interface. With optional wire straighteners and push-pull feed systems, it's suited for specialty applications involving cast wires or delicate materials. The BW3000 is the top choice for heavy industries where performance, precision, and process repeatability are essential.

FOR ALL SIZES AND PART NUMBERS, PLEASE SCAN THE PRODUCT QR CODE





**COMPATIBLE WITH CLIMAX
LINE BORING MACHINES**



Watch Video



BW5000 AUTO BORE WELDER

Standard Torch Range: 12 - 144" / 304.8 - 3,657.6 mm

The BW5000 Auto Bore Welder stands apart as a specialized solution for weld overlay and cladding applications. Unlike traditional bore welders the BW5000 rotates around the stationary workpiece - an innovative approach that ensures consistent wire placement, optimal weld quality, and precise control on large components that cannot be moved or rotated.

This makes it especially well-suited for applications such as pressure vessel nozzles, turbine housings, large flange faces, and other massive or fixed structures. Supporting short arc, pulsed MIG, and flux-cored welding modes, the BW5000 works with a wide range of materials, including challenging alloys like Inconel™, Hastelloy™, and Monel™. It offers step weld thicknesses up to 0.35" / 8.89 mm and can deposit up to 12 lbs / 5.44 kg of metal per hour with repeatable accuracy. Its modular design enables quick retooling, while the integrated 170 controller delivers full digital control and live monitoring of all welding parameters.

FOR ALL SIZES AND PART NUMBERS, PLEASE SCAN THE PRODUCT QR CODE



The S.F.E. Group's brand **CLIMAX** has been the pioneer and foremost global manufacturer of portable machine tools since 1966, setting the standard with innovative, mission-critical solutions for nearly 60 years. As the original technology leader in portable machining, **CLIMAX** offers an unmatched range of equipment, including line boring, bore welding, flange facing, portable milling, plate bevelling and lathes. With this unrivalled suite of equipment and end-to-end solutions for mission-critical manufacturing and repair work, **CLIMAX** empowers solutions for a wide variety of industries such as Oil & Gas, Mining, Power Generation, Nuclear, Renewable Energy, Transport, Maritime, Aerospace, and Defense.

Embedded within and supported by the strength of 12 complementary brands, S.F.E. Group's global reach, innovative product portfolio, and over 200 years of combined expertise, **CLIMAX** continues to advance the portable machine tool industry with cutting-edge solutions. As the only global OEM that never competes with its customers, **CLIMAX** remains committed to offering the best value while upholding the highest standards of safety and quality. **CLIMAX** is driving innovation, ensuring its continued future global leadership in portable machining.

Known for delivering the highest quality tools and an exceptional customer experience, **CLIMAX** is always nearby and offered via the global S.F.E. Group network with offices and warehousing on five continents and a network of over 350 sales locations and distributors worldwide. The complete **CLIMAX** portfolio is featured on the dedicated website: www.CLIMAXPORTABLE.com.





BB3000 LINE BORING MACHINE

Boring Diameter: 1.5 - 5" / 38.1 - 127 mm

The CLIMAX BB3000 Portable Line Boring Machine features a 1.25" / 31.8 mm diameter bar available in various lengths, a maximum boring stroke of 10" / 254 mm, and a 1.0 HP motor that delivers up to 90 ft-lbs (122 Nm) of torque with bar speeds up to 150 RPM.

Designed for fast, on-site repairs of worn hinge points on heavy equipment, it allows users to weld and re-bore damaged holes to original specifications without dismantling machinery. Its compact, modular design includes quick-install setup cones, spherical bearing mounts, and a fast-mount rotational drive, enabling full setup in under 30 minutes.

The system also offers a reversible, infinitely variable power feed up to 0.018" / 0.457 mm per revolution, ensuring precise, efficient cutting. With flexible configuration options, including electric or pneumatic drives, various mounting systems, and accessories like facing heads, bore welders, and digital measuring tools, the BB3000 delivers a reliable, highly customizable solution for in-field machining.

FOR ALL SIZES AND PART NUMBERS, PLEASE SCAN THE PRODUCT QR CODE



(NEW PRODUCT LAUNCHING 2026)

BB3100 BOREMAX

Boring Diameter: 0.87 - 15.75 / 22 - 400 mm

The CLIMAX BB3100 BOREMAX is a compact, entry-level line boring and welding machine designed for professionals who need versatility and performance in a cost-effective package. With a bore diameter range of 0.87 - 15.75" / 22 - 400 mm, the BB3100 BOREMAX is ideal for use across construction, mining, shipbuilding, power generation, and industrial maintenance sectors.

Powered by a 3.1 kW servo motor, the machine features intuitive touchscreen controls for both boring and welding, simplifying operation while delivering high precision and reliability. It supports bar diameters of 0.75" / 19 mm, 1.25" / 31.8 mm, and 2.25" / 57.15 mm, with speeds ranging from 0 to 300 RPM and a 10:1 RDU reduction for enhanced torque control.

The BB3100 BOREMAX comes with standard 12" axial travel (optional 24"), and bar lengths of 48" / 1,219.2 mm, 72" / 1,828.8 mm, and 96" / 2,438.4 mm. It also includes everything needed for setup: alignment tools, supports, carbide inserts, and contact tips.

Combining line boring and bore welding in one system, the BB3100 BOREMAX is a powerful solution for those seeking professional results without the complexity or high cost of larger machines - making it an ideal choice for both experienced operators and those new to the field.

FOR ALL PART NUMBERS, PLEASE SCAN THE PRODUCT QR CODE



BB4500 LINE BORING MACHINE

Boring Diameter: 1.5 - 10" / 38.1 - 254 mm

The CLIMAX BB4500 Portable Boring Machine is a compact, powerful, and versatile tool designed for precision on-site machining, featuring a 1.75" / 44.45 mm bar with optional 1.25" / 31.8 mm alternatives and stroke lengths up to 36 inches.

It offers multiple power options including electric, servo electric, hydraulic and pneumatic, all supporting a reversible feed mechanism with up to 0.018" / 0.457 mm feed rate. Its modular design allows quick setup - typically in 30 minutes or less - using high-quality cast-iron cones, patented spherical bearing mounts, and a 4:1 worm gear reduction drive unit for increased torque and flexibility in confined spaces.

The machine supports through-bar operation, interchangeable motor mounts, and is compatible with various accessories like facing heads, grooving kits, bore welders, and precision measuring tools, making it an affordable, high-performance solution for demanding field machining applications.

FOR ALL SIZES AND PART NUMBERS, PLEASE SCAN THE PRODUCT QR CODE



BB5000 LINE BORING MACHINE

Boring Diameter: 1.5 - 24" / 38.1 - 609.6 mm

The CLIMAX BB5000 is the most popular and widely used model in the company's line boring range, trusted across industries like construction, mining, power generation, and shipbuilding for its unmatched combination of power, flexibility, and ease of use. Known for its rugged design and quick setup - typically in 30 minutes or less - it features a patented spherical bearing mount system and modular components that allow for maximum versatility, even in tight or complex workspaces.

The BB5000 supports multiple drive options including electric, servo electric, hydraulic, and pneumatic, and is compatible with an extensive range of accessories for operations such as line boring, facing, drilling, valve repair, and bore welding. Its ability to adapt to various machining tasks, combined with through-bar design and multiple mounting configurations, makes it the go-to portable solution for demanding on-site repairs and maintenance work.

FOR ALL SIZES AND PART NUMBERS, PLEASE SCAN THE PRODUCT QR CODE

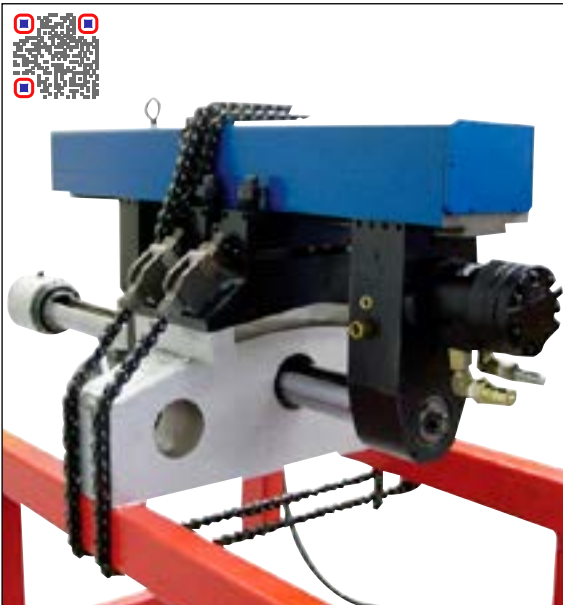

BB5500 COUPLING BORING MACHINE

Boring Diameter: 2.1 - 4.2" / 53.3 - 106.7 mm

The BB5500 Turbine Coupling Boring Machine by CLIMAX is engineered for high-precision boring of fitted bolt holes in turbines and large couplings, minimizing downtime during maintenance. This compact, rigid, and portable tool allows fast setup and accurate on-site machining, making it essential in power generation and heavy industry. Its universal coupling mounting system adapts to various turbine coupling o/d size starting from 27" and onwards, enabling reliable, repeatable machining without time-intensive honing.

The BB5500 supports hydraulic, pneumatic, and electric drives to suit different environments. Key features include reversible mechanical/electric feeds for tight-space work, quick boring bar removal for measurements, and simple tool switching between HSS and carbide bits.

Its design ensures exceptional alignment and perpendicularity with fine lateral/radial adjustments. With minimal clearance needs and a toolset built for confined spaces, the BB5500 offers top-tier performance and adaptability in demanding maintenance operations.

FOR ALL SIZES AND PART NUMBERS, PLEASE SCAN THE PRODUCT QR CODE

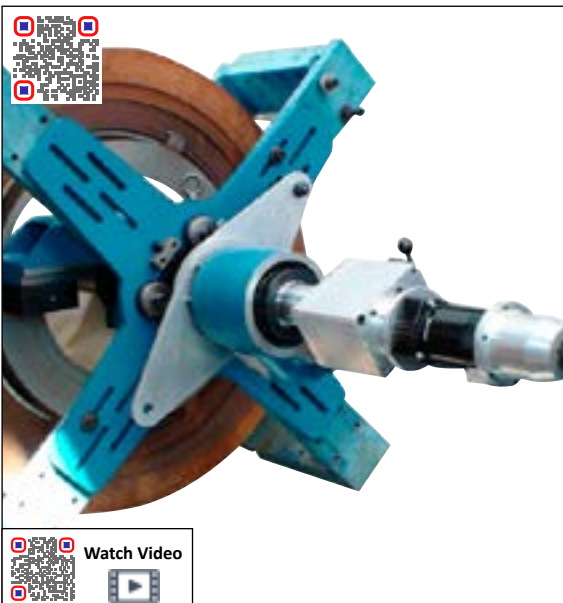

BB6100 LINE BORING MACHINE

Boring Diameter: 6 - 42.1" / 152.4 - 1,069.3 mm

The BB6100 Line Boring Machine is engineered for heavy-duty on-site machining applications, ideal for repairing or modifying large, cylindrical components such as pivot points, bearing housings, and turbine casings in industries like power generation, mining, shipbuilding, and construction.

Its modular, compact design enables fast setup and portability without compromising power or precision, bringing the capabilities of a stationary machine directly to the job site. The BB6100 excels in both boring and facing tasks without the need to switch equipment, thanks to its innovative boring/facing arms and tool carrier that offers exceptional rigidity and stability. Operators can fine-tune alignment with spherical taper-lock roller bearings and benefit from up to 1.5 degrees of misalignment tolerance during setup.

The machine utilizes a high-torque hydraulic motor that delivers up to 1,435 ft-lb of torque for tough jobs. BB6100 provides optional automatic feeding mechanisms, both mechanical and electric. Its versatile tool blocks accept standard 3/4" / 19.05 mm and 1" / 25.4 mm square shank tooling, while features like backlash adjustment and split-frame design enhance flexibility and prolong machine life. With durable chrome-plated bars, fast installation, and adaptable tool configurations, the BB6100 is a high-performance solution for minimizing downtime and maximizing precision across a broad range of industrial maintenance and fabrication projects.

FOR ALL PART NUMBERS, PLEASE SCAN THE PRODUCT QR CODE



BB7100 LINE BORING MACHINE

Boring Diameter: 10.25 - 61.9" / 260.4 - 1,572.60 mm

The BB7100 Line Boring Machine is purpose-built for on-site machining in heavy industrial sectors such as power generation, mining, oil and gas, and large-scale infrastructure, where precision restoration of worn or misaligned bores and flanges is critical.

This machine enables both boring and facing operations without switching equipment, significantly streamlining complex tasks like refurbishing large bearing housings, pivot bores, turbine casings, and structural connection points in critical assets. Its modular, hand-portable components allow rapid setup even in confined or remote environments, minimizing downtime during shutdowns or repairs. Equipped with a high-torque hydraulic drive system delivering up to 2,280 ft-lbs of torque, the BB7100 ensures powerful, accurate cutting under demanding conditions. BB7100 provides optional automatic feeding mechanisms, both mechanical and electric.

The machine features adjustable net fit tool carriers, dual boring head capabilities, and optional boring/facing arms for greater reach and operational flexibility. Advanced alignment tools such as spherical taper-lock roller bearings and fine-adjust mounts ensure precise centering. Its design includes chrome-finished precision bars, a backlash-adjustable tool carrier, and versatile tool holders compatible with industry-standard bits. Whether correcting misalignment, restoring critical tolerances, or performing structural bore repairs, the BB7100 offers unmatched strength, precision, and efficiency for mission-critical field machining applications.

FOR ALL PART NUMBERS, PLEASE SCAN THE PRODUCT QR CODE



BB8100 LINE BORING MACHINE

Boring Diameter: 14.5 - 97.1" / 368.3 - 2,465.34 mm

The BB8100 is the largest standard machine in the CLIMAX line-boring portfolio, purpose-built to tackle the most demanding on-site machining applications across mining, power generation, shipbuilding, and heavy industry.

Engineered for large-scale manufacturing and repairs such as dragline pivots, rudder pins, turbine housings, pump cases, and stamping press bearing seats, the BB8100 brings unmatched power and versatility to the job site. With modular components designed for fast setup and transport, it enables technicians to perform high-precision boring and facing in remote or confined environments with minimal downtime.

The machine delivers exceptional cutting force through a hydraulic drive producing up to 4,783 ft-lbs of torque, while its innovative tool carrier and optional dual-action boring/facing arms allow seamless transitions between operations. BB8100 provides optional automatic feeding mechanisms, both mechanical and electric. Industry-standard tool holders accommodate 1" / 25.4 mm square shank tooling. The BB8100 can support simultaneous leading and trailing boring heads and optional optical alignment systems, making it ideal for restoring tolerances in mission-critical applications. Whether realigning gearbox housings, repairing oversized bores in turbines, or restoring structural components in marine vessels, the BB8100 offers the size, strength, and precision needed for the toughest field machining challenges.

FOR ALL PART NUMBERS, PLEASE SCAN THE PRODUCT QR CODE

(NEW PRODUCT LAUNCHING 2026)

BB 1.5 kW SERVO MOTOR CONVERSION KIT

for BB3000 / BB4500 / BB5000

The CLIMAX 1.5 kW Servo Motor Conversion Kit is an advanced upgrade designed for the CLIMAX BB3000 (adaptor kit required), BB4500, and BB5000 Line Boring Machines. It replaces the traditional drive system with a robust servo motor, delivering enhanced performance, safety, and precision without requiring major equipment changes.

Engineered for easy bolt-on installation, the kit supports working ranges of 1.25 - 5" / 31.8 - 127 mm for BB3000, 1.25 - 10" / 31.8 - 254 mm for BB4500, and 1.25 - 12" / 31.8 - 304.8 mm for BB5000. Available in 110V (32A) and 220V (16A) single-phase versions, it offers clockwise/counterclockwise rotation, variable speed RPM control (up to 400 RPM on BB3000, and up to 130 RPM on BB4500 and BB5000), and low-noise operation.

A handheld pendant provides intuitive controls for speed, direction, start/stop, and emergency stop. Rated IP67 for the motor and IP54 for the control case, the kit is built for harsh environments. It's CE, UKCA, and NFPA 79 compliant, supporting global safety standards and providing a powerful, portable alternative to hydraulic drive systems.

FOR ALL PART NUMBERS, PLEASE SCAN THE PRODUCT QR CODE



(NEW PRODUCT LAUNCHING 2026)

BB 3.1 kW SERVO MOTOR CONVERSION KIT

for BB4500 / BB5000

The CLIMAX 3.1 kW Servo Motor Conversion Kit is an advanced upgrade designed for the CLIMAX BB4500, and BB5000 Line Boring Machines. It replaces the traditional drive system with a robust servo motor, delivering enhanced performance, safety, and precision without requiring major equipment changes.

Engineered for easy bolt-on installation, the kit supports working ranges of 1.25 - 10" / 31.8 - 254 mm for BB4500, and 1.25 - 24" / 31.8 - 609.6 mm for BB5000. Available in 220V (16A) single-phase versions, it offers clockwise/counterclockwise rotation, variable speed RPM control (up to 130 RPM), and low-noise operation.

A handheld pendant features intuitive touchscreen controls for speed, direction, start/stop, and emergency stop. Rated IP67 for the motor, the kit is built for harsh environments. It's CE, UKCA, and NFPA 79 compliant, supporting global safety standards and providing a powerful, portable alternative to hydraulic drive systems.

FOR ALL PART NUMBERS, PLEASE SCAN THE PRODUCT QR CODE





(NEW PRODUCT LAUNCHING 2026)

MFF350 MANUAL FLANGE FACING MACHINE

Flange Facing Diameter Range: 0.53 - 14" / 13.5 - 350 mm
I/D Clamping Range: 0.53 - 13.78" / 13.5 - 250 mm

The CLIMAX Manual Flange Facing Machine, MFF350, is designed for precision flange facing in both workshop and field applications. Built for flat face, raised face, and spot facing, this manually powered machine delivers ASME B16.5-compliant surface finishes without requiring external power. Compact, lightweight, and robust, the MFF350 handles carbon steel, stainless steel, and exotic alloys with ease. Capable of achieving precision surface finishes from 3.2 - 12.5µm (smooth to phonographic), this machine has a facing diameter range of 0.53 - 14" / 13.5 - 350 mm with an inner diameter clamping range of 0.53 - 13.78" / 13.5 - 250 mm (depending on the clamping accessories selected). Ideal for on-site flange repair, pipeline maintenance, and workshop preparation, the MFF350 offers a cost-effective, durable solution for industries such as oil & gas, petrochemical, power generation, marine, and water treatment.

FOR ALL PART NUMBERS, PLEASE SCAN THE PRODUCT QR CODE



FF3000 FLANGE FACER

I/D Facing diameter: 1.5 - 12" / 38.1 - 304.8 mm

The FF3000 Flange Facer is widely favored for its exceptionally lightweight and compact design, making it a top choice for field technicians working in tight or elevated environments across industries such as oil and gas, power generation, and shipbuilding.

Weighing only 35 lbs / 16 kg, it's one of the lightest flange facers available, allowing a single operator to easily transport, mount, and operate the machine without the need for heavy lifting equipment. This portability significantly reduces setup time and increases efficiency, particularly in applications where access is difficult or mobility is crucial.

Despite its small size, the FF3000 delivers impressive performance with bi-directional variable feed and optional Quick-Lock beveling heads that enable seamless transitions between facing and beveling tasks. Its pneumatic motor, integrated lubrication system, and rigid mounting design ensure smooth operation and consistent results. Users value its ability to quickly restore flange sealing surfaces on-site, eliminating the need to remove components for off-site repair.

The intuitive five-step setup process means experienced users can have the machine operational in under ten minutes. Highly durable and easy to handle, the FF3000 is the go-to solution for technicians who need reliable flange machining in locations where weight, space, and speed matters most.

FOR ALL PART NUMBERS, PLEASE SCAN THE PRODUCT QR CODE



FF5000 FLANGE FACER

I/D Facing diameter: 5 - 24" / 127 - 609.6 mm

The FF5000 Flange Facer stands out for its compact, low-profile design, making it a go-to solution for technicians who need powerful flange machining in confined spaces. With a body weighing just 60 lbs / 27 kg and a slim 7.6" / 193 mm height above the flange, it's easily manageable by a single operator and ideal for environments where space and accessibility are limited.

The FF5000 is designed for facing, beveling, and turning pipe, valve, and pump flanges directly on-site. Its two-piece mounting system simplifies setup and alignment, enabling fast deployment with minimal effort. Operators can detach the machine body without disturbing the precise chuck alignment, which is a significant time-saver during outages or multi-flange projects.

The FF5000 features a compound tool head for cutting chamfers and grooves, automatic bi-directional feeds, and intuitive controls that eliminate the need to interact with moving parts. Its pneumatic motor delivers consistent torque, while muffled exhaust routing keeps operation quieter. With its simplified four-step setup and the ability to perform accurate machining in hard-to-reach areas, the FF5000 delivers exceptional value and reliability - making it the preferred choice in the CLIMAX range for field teams prioritizing compactness, efficiency, and safety in flange maintenance tasks.

FOR ALL PART NUMBERS, PLEASE SCAN THE PRODUCT QR CODE



FF5300 FLANGE FACER

I/D Facing diameter: 5.7 - 40" / 144.8 - 1,016 mm

The FF5300 Flange Facer is a high-performance machine designed for precision machining of flanges in industries such as oil and gas, power generation, shipbuilding, and heavy equipment manufacture and repair. Central to its versatility are two interchangeable machining arms which allow operators to tailor the machine to a broad range of facing applications without needing separate units.

The FF5300 can be delivered with a user-selected single arm or with both, with the shorter arm supporting a cutting range up to 32" / 813 mm in diameter or while the longer arm extends the capability to 40" / 1,016 mm, giving users the flexibility to cover more job types with a single tool. This modular approach enhances efficiency by enabling quick adaptation to different flange sizes.

Powered by a robust 2.4 HP pneumatic motor, the FF5300 features automatic, adjustable radial and axial feeds and a 360° rotating tool head capable of producing chamfers, O-ring grooves, RTJ grooves, and other complex profiles. The quick-connect chuck system and user-friendly controls streamline setup, while consistent feed rate control ensures high-quality finishes. The FF5300 is an ideal solution for technicians demanding speed, precision, and flexibility in the field.

FOR ALL PART NUMBERS, PLEASE SCAN THE PRODUCT QR CODE



FF6300 FLANGE FACER

I/D Facing diameter: 11.8 - 60" / 299.7 - 1,524.0 mm

(also available as O/D mount version)

The FF6300 Flange Facer is a high-performance, portable machining solution for flange resurfacing and complex field tasks in industries like oil and gas, power generation, shipbuilding, and heavy equipment maintenance. It can be configured in either i/d, o/d, or surface-mount configurations for a variety of machining applications, with a quick and easy changeover. Built for strength and precision, it features a worm gear drive for smooth, low-backlash operation - even over bolt-hole patterns. Hydraulic or pneumatic drive options adapt power delivery to job conditions, enabling high metal removal rates and consistent finishes.

Its 360° rotating tool head machines features like chamfers, RTJ and O-ring grooves, lens rings, and sealing surfaces. Back-facing capability suits heat exchanger tube sheets and similar applications. Modular design and multiple mounting options ensure adaptability to varied job sites. A remote-controlled feed system improves safety, while quick-change mounts and leveling feet speed setup and alignment. The FF6300 delivers a powerful, efficient solution for demanding machining environments.

FOR ALL SIZES AND PART NUMBERS, PLEASE SCAN THE PRODUCT QR CODE



FF7200 FLANGE FACER

I/D Facing diameter: 30 - 72" / 762 - 1,828.8 mm

Milling diameter: 35 - 72" / 889 - 1,828.8 mm

The FF7200 Flange Facer is a robust, high-performance machine built for heavy-duty flange repair in industries like oil and gas, shipbuilding, and power generation. With oversized components and industrial-grade bearings, it delivers high torque and precision - even on interrupted surfaces. Pneumatic or hydraulic drive powers radial and axial feeds, with remote-controlled speed for safety.

Its 360° tool head machines chamfers, grooves, lens rings, and back-facing features. A modular build and simple chucking system allow fast setup and both i/d/surface mounting. It also supports milling for fine finishes, eliminating the need for additional equipment - making it ideal for demanding field machining.

FOR ALL SIZES AND PART NUMBERS, PLEASE SCAN THE PRODUCT QR CODE



FF8200 FLANGE FACER

I/D Facing & Milling diameter: 45 - 120" / 1,143.0 - 3,048.0 mm
(also available as O/D mount version)

The FF8200 Flange Facer is a heavy-duty, high-torque machine purpose-built for large-scale flange resurfacing and repair in industries such as oil and gas, power generation, shipbuilding, and heavy equipment maintenance. It can be configured in either i/d, o/d, or surface-mount configurations for a variety of machining applications, with a quick and easy changeover. With its robust construction-grade bearings and oversized ring gear, the FF8200 delivers rigid, stable performance even when machining over bolt-hole patterns or dealing with tough materials. Operators benefit from infinitely variable feed rates, remote adjustment capability, and a 360° rotating tool head that supports a wide range of machining operations including chamfers, O-ring grooves, RTJ profiles, lens rings, and other complex cuts. The FF8200 includes a modular chucking system and quick-adjust leveling feet. In addition to single-point machining, the FF8200 is also configurable as a powerful milling machine.

FOR ALL SIZES AND PART NUMBERS, PLEASE SCAN THE PRODUCT QR CODE

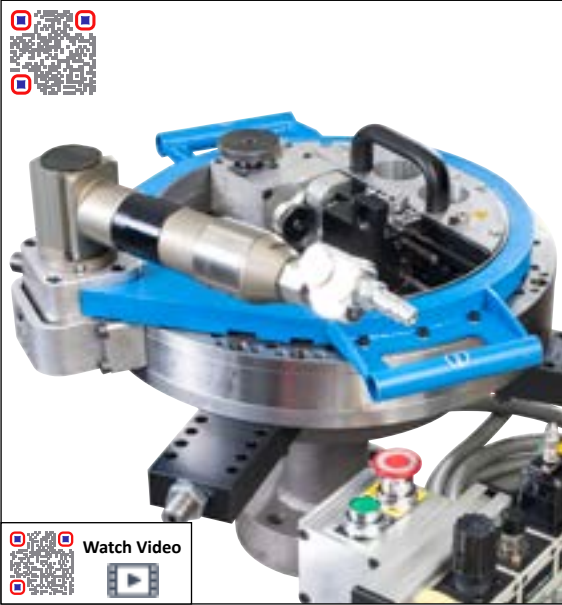

FF1200 OD MOUNT FLANGE FACER

O/D Facing diameter: 0 - 12.5" / 0 - 317.5 mm

The FF1200 o/d Mount Flange Facer is a compact, high-performance machining tool engineered for safe, precise, and efficient resurfacing of a wide variety of flanges across industries such as oil and gas, power generation, and chemical processing.

Favored for its combination of portability and robust performance, the FF1200 is designed to machine all seven common flange types - flat face, raised face, RTJ, tongue and groove, lens ring, Grayloc, and compact flanges - without the need for additional attachments. Its advanced feed system allows automatic and variable control for both radial and axial feeds, enabling time savings while improving surface finishes. Operators can adjust feed rate or start and stop feed on the fly, without halting rotation or replacing components, improving safety and operational efficiency.

A key safety feature is the external feed control and integrated E-stop system, which eliminates the need for reaching inside the machine during operation and prevents unintended restarts from air pressure loss. With its rigid chucking system and smooth-running drive, the FF1200 ensures consistent machining quality and reliability. It supports quick setup and adjustments, making it an ideal solution for high-precision field flange repairs where safety, flexibility, and performance are paramount.

FOR ALL PART NUMBERS, PLEASE SCAN THE PRODUCT QR CODE

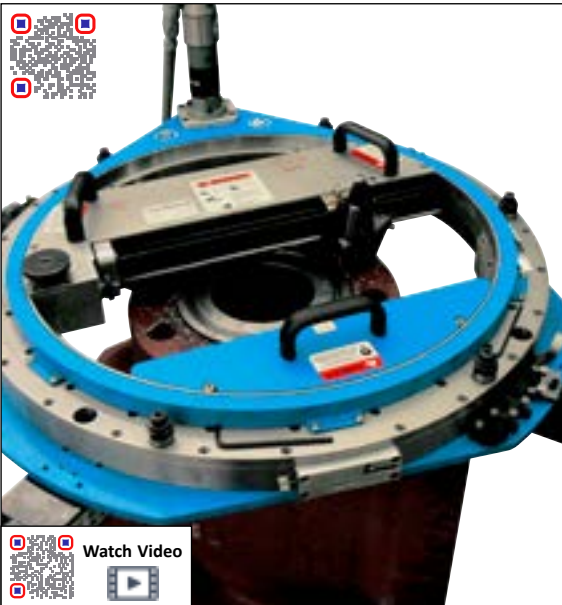

FF2400 OD MOUNT FLANGE FACER

O/D Facing diameter: 0 - 24.5" / 0 - 622.3 mm

The FF2400 o/d Mount Flange Facer is a versatile and dependable field machining tool built for professionals who need to resurface a wide range of flange types with speed, precision, and confidence.

Designed to tackle medium-to-large flange maintenance tasks, the FF2400 handles all standard flange profiles - flat face, raised face, RTJ, tongue and groove, lens ring, Grayloc, and compact flanges - without requiring any changeover parts or attachments. What sets the FF2400 apart is its balance of size and performance: it delivers the rigidity and stability needed for high-quality finishes, while remaining compact enough for easy transport and setup. With automatic, variable-speed radial and axial feeds, operators can make real-time adjustments during cuts to adapt to material conditions or geometry changes - no stopping required.

This flexibility, combined with a high-torque, smooth belt-driven system, ensures consistent results across a range of materials. Safety is built into the core design, featuring external feed controls, emergency stop functions, and low-pressure drop-out to prevent unexpected restarts. Its intuitive setup process and durable construction make the FF2400 a reliable go-to solution for teams who demand both precision and efficiency in on-site flange machining, especially where uptime and finish quality are critical.

FOR ALL PART NUMBERS, PLEASE SCAN THE PRODUCT QR CODE



FF3600 OD MOUNT FLANGE FACER

O/D Facing diameter: 0 - 36.5" / 0 - 927.1 mm

The FF3600 o/d Mount Flange Facer is the heavyweight of the series, purpose-built for large-diameter flange maintenance where durability, control, and finish quality can't be compromised. It's a favorite among field machinists tackling high-stakes jobs on pressure vessels, pipeline flanges, and other critical infrastructure.

Engineered for demanding applications, the FF3600 brings powerful performance with a smooth-running drive system and rugged construction that absorbs vibration and maintains accuracy, even across wider surfaces. Operators benefit from fully adjustable radial and axial feed systems that can be fine-tuned during cutting - ideal for dialing in optimal performance without stopping the machine. Whether working with tough materials or intricate flange geometries, the tool head's rotating and preset angles allow for excellent access and finish flexibility.

Safety is also prioritized, with hands-free feed control, built-in E-stop, and air pressure fail-safes that help prevent accidental restarts. Despite its capacity, setup remains straightforward, and the machine's robust chucking system ensures solid, repeatable mounting every time. For those facing large flange jobs where precision and efficiency must scale with size, the FF3600 delivers a confident, capable solution that's as dependable in the field as it is in performance testing.

FOR ALL PART NUMBERS, PLEASE SCAN THE PRODUCT QR CODE



Watch Video

(NEW PRODUCT LAUNCHING 2026)

EZ FACER™ SERIES: ODF12

4 - 12" / 101.6 - 304.8 mm

The ODF12 flange facing machine is a compact yet powerful solution for on-site flange re-surfacing, designed to machine raised face, flat face, RTJ and conical lens seal. With a machining range of 4 - 12" / 101.6 - 304.8 mm and a 2.5" / 63.5 mm axial travel stroke, it offers flexibility for a variety of flange sizes. Driven by a 1.1 kW pneumatic motor, it operates at 90 psi and consumes 75 CFM, delivering reliable cutting power in demanding environments.

Designed with a ½" / 12.7 mm tool holder and a mounting range of 3 - 12.5" / 76.2 - 317.5 mm, the ODF12 accommodates a wide range of flange diameters. The maximum swing diameter of 16" / 406.4 mm ensures excellent arm clearance, enabling smooth operation even in confined spaces. The machine is capable of machining raised and flat flanges, as well as radial grooves and conical lens profiles, making it suitable for diverse applications.

Supporting horizontal, vertical, and overhead operations, the ODF12 is built for maximum versatility. It operates within a 120 - 160 SFM speed range allowing for 2 hours of operation every 3 hours. Certified to CE and UKCA standards, it also features integrated lifting points and is supplied in a durable metal crate with compartments for safe transport and organized storage.

FOR ALL PART NUMBERS, PLEASE SCAN THE PRODUCT QR CODE



Watch Video

(NEW PRODUCT LAUNCHING 2026)

EZ FACER™ SERIES: ODF24

0 - 24" / 0 - 609.6 mm

The ODF24 flange facing machine is a heavy-duty, portable tool engineered for precision resurfacing of large-diameter flanges in various industrial environments, and designed to machine raised face, flat face, RTJ and conical lens seal. With a machining range of 0 - 24" / 0 - 609.6 mm and an axial travel stroke of 2.5"/63.5 mm, it offers extended reach and flexibility for broader flange applications. Powered by a 1.1 kW pneumatic motor operating at 90 psi and consuming 57 CFM, the ODF24 delivers robust cutting performance for tough jobs.

Its ½" / 12.7 mm tool holder supports standard cutting tools, and the clamping range of 9.7 - 24.5" / 246.4 - 622.3 mm ensures compatibility with a wide array of flange diameters. A generous maximum swing diameter of 28" / 711.2 mm provides ample arm clearance for smooth and unobstructed operation. The machine can machine raised and flat flanges, as well as intricate features like radial grooves and conical lens profiles.

The ODF24 supports multiple positions of operation - horizontal, vertical, and overhead, making it highly adaptable in confined or unconventional working spaces. Operating at 120 - 160 SFM, it maintains efficiency. Fully compliant with CE and UKCA regulations, it includes integrated lifting points and ships in a rugged metal crate with organized compartments for safe handling and storage.

FOR ALL PART NUMBERS, PLEASE SCAN THE PRODUCT QR CODE

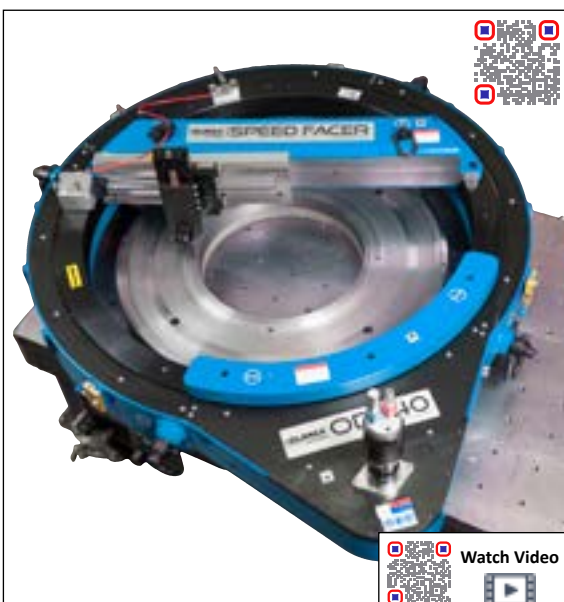

Watch Video

SPEED FACER™ ODF30 - ODF120

0 - 120.5" / 0 - 3,061 mm

The SPEED FACER™ ODF series (consisting of 10 models) is engineered around a smart rotating ring concept that transforms the setup and operation of large flange machining, making it faster, easier, and more intuitive than ever.

Built for high-speed, precision resurfacing of flanges across industries like oil and gas, power generation, and shipbuilding, the ODF models are known for combining serious cutting performance with operator-friendly features. At the heart of the design is the rotating ring structure, which houses the feed and tool slide systems, allowing for 360° tool positioning and quick alignment without complex adjustments.

Setup is streamlined thanks to modular mounting feet, leveling jacks, and setup fingers that lock the unit into place securely and in minutes. The machines feature an auto-feed system, variable-speed drive, and adjustable feed rates up to 0.032" / 0.812 mm rev - all accessible without stopping the cut. With both pneumatic and hydraulic drive options and the ability to perform advanced operations like back-facing, chamfering, and O-ring groove cutting, the SPEED FACER offers unmatched flexibility. The ring-based platform, along with integrated safety features like E-stops and low-pressure interlocks, makes this system a trusted choice for technicians who need fast setup, smooth operation, and precision results in the field.

FOR ALL PART NUMBERS, PLEASE SCAN THE PRODUCT QR CODE



FF6300 FLANGE FACER

O/D Facing diameter: 10 - 60" / 254 - 1,524 mm

The FF6300 Flange Facer offers a high-performance solution for flange resurfacing tasks, and its o/d mount configuration brings a unique advantage for applications where internal access is limited or unsuitable.

With a robust chain-clamp assembly that securely grips the outside diameter of the flange, the o/d mount option eliminates the need for weld-based mounting, speeding up setup and reducing risks to the component. Designed for precision and efficiency, the FF6300 delivers smooth, high-torque machining via its worm gear drive system, maintaining low backlash even when cutting across interrupted surfaces like bolt-hole patterns. Its heavy-duty bearings provide the rigidity needed for consistent results, while the 360° rotating tool head supports the creation of various profiles such as chamfers, RTJ grooves, and o-ring seats.

Operators can safely control the feed remotely, keeping hands away from moving parts, and adjust the radial and axial tool feeds on the fly. Modular components and lighter overall weight make transport and setup easier, while the quick-change chucking system further simplifies mounting. Available with pneumatic or hydraulic drives, the FF6300 o/d mount is ideal for on-site machining of large piping flanges, vessel interfaces, and structural connections where reliable clamping, portability, and surface finish quality are essential.

FOR ALL PART NUMBERS, PLEASE SCAN THE PRODUCT QR CODE

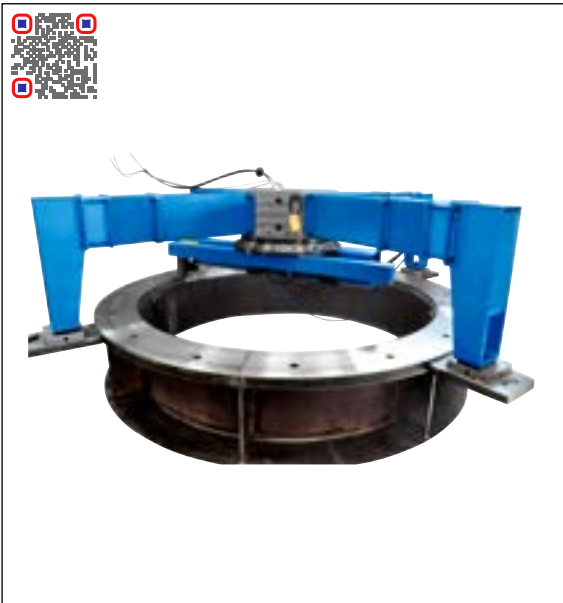

FF8200 FLANGE FACER

O/D Facing diameter: 45 - 120" / 1,143.0 - 3,048.0 mm

The FF8200 Flange Facer is a powerful, large-capacity machine designed to take on the most demanding field machining tasks, and its o/d mount configuration offers a standout advantage for technicians working on oversized or difficult-to-access flange surfaces.

Built with rugged components and construction-grade bearings, the FF8200 delivers reliable, rigid performance even under high torque and across bolt-hole interruptions. Its oversized internal ring gear and durable drive system make it capable of producing precise phonographic finishes on critical flanges. In o/d mount mode, the FF8200 allows secure external clamping around the flange, making it ideal for situations where internal access is restricted or where i/d mounting isn't possible. This design enhances accessibility while maintaining exceptional stability and alignment during cutting. Setup is streamlined thanks to the modular structure and a simplified chucking system, and quick-adjust leveling feet make alignment fast and straightforward.

The machine supports both pneumatic and hydraulic drives, offers remote-controlled radial and axial feed, and features a 360° rotating tool head for machining a variety of surface profiles - including chamfers, o-ring grooves, and lens rings. With optional milling capabilities and back-facing attachments, the FF8200 o/d mount version combines brute strength, versatility, and user-friendly design to handle large flange resurfacing projects with unmatched efficiency and precision.

FOR ALL PART NUMBERS, PLEASE SCAN THE PRODUCT QR CODE

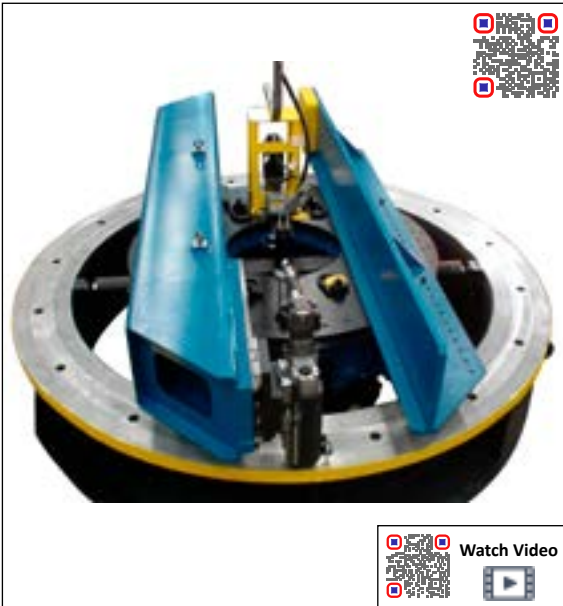

CM6200 CIRCULAR MILL I/D MOUNT FLANGE FACER

Milling range : 73.5 - 199" / 2,004.1 - 4,500.9 mm

The CM6200 Circular Mill is a high-precision, on-site machining tool used across heavy industries, offering multiple mounting options including i/o, o/d or face-mounted configurations. Built for rigidity, it features large-diameter pre-loaded bearings and linear guideways for accurate machining under heavy loads. Precision ball screws enable smooth radial and axial tool movements.

Its milling head handles face mills up to 10" / 254 mm in diameter and offers up to 8" / 203 mm of axial travel for deep, consistent cuts. Configurable for milling or single-point machining, it performs operations like chamfers, phonographic finishes, and seal ring grooves.

The servo drive rotation and hydraulic spindle RPM are all controlled via an advanced touchscreen pendant. A tubular chucking system, leveling feet, and a 360° swiveling tool head simplify setup and increase versatility in tight spaces. Built for fast, reliable field performance, the CM6200 eliminates the need to transport large components for shop work.

FOR ALL SIZES AND PART NUMBERS, PLEASE SCAN THE PRODUCT QR CODE



Watch Video



CM6200 CIRCULAR MILL

O/D Mounting range: 98.4 - 209.9" / 2,499.36 - 5,331.46 mm

The CM6200 Circular Mill is a powerful, precision machining system that stands out for its ability to mount externally to large structures using an o/d mount configuration - ideal when internal access is limited or completely unavailable.

Engineered for large-diameter flange milling and single-point machining, the CM6200's o/d mount setup uses a rugged adjustable chuck and leveling plate system to securely attach to the outer diameter of components like crane pedestals, wind tower bases, and large vessel flanges. This approach not only simplifies setup but also ensures accurate centering and stability for critical resurfacing operations. With a robust frame, large pre-loaded bearings, and precision ball screws on both radial and axial axes, the machine delivers exceptional rigidity and smooth motion for deep, accurate cuts.

Operators can switch between servo powered milling using hydraulic spindles and hydraulic powered single-point machining, to execute chamfers, phonographic finishes, or face milling with cutters up to 10" / 254 mm in diameter. The modular design facilitates transport and setup, while servo control with touchscreen pendant offers precise speed and angular adjustments in real time. The o/d mount configuration of the CM6200 allows field teams to tackle large-scale, high-tolerance machining tasks without removing components from service - maximizing uptime and productivity on site.

FOR ALL PART NUMBERS, PLEASE SCAN THE PRODUCT QR CODE



Watch Video





PL2000 LATHE

Shaft diameter: 1.5 - 9" / 38.1 - 228.6 mm

The PL2000 Portable Lathe is a compact, rugged machine designed for precision on-site turning of small shafts and journals, delivering fast setup, reliable performance, and repeatable results in demanding field environments.

It mounts directly to the end of the shaft, making it ideal for re-machining work where disassembly of surrounding equipment is not practical. The PL2000 is available with either a powerful 1 HP electric motor or a 1.22 HP pneumatic motor, each offering ample torque for a wide range of cutting conditions. Its Criterion-style tool head provides precise depth control in 0.001" / 0.0254 mm increments, while the automatic axial feed system can be infinitely varied for a smooth, controlled cut. With a tool reach of up to 12.5" / 317.5 mm from the shaft end, this lathe is suited for applications such as bearing journal restoration, shaft end repairs, and machining keyways or steps.

Operators can quickly mount the machine using a simple flange or single-bolt adapter, and setup typically takes less than an hour for experienced users. Lightweight and portable, yet built to endure tough industrial use, the PL2000 is a go-to tool for maintenance crews and field machinists needing efficient, accurate, and convenient shaft turning capabilities directly at the job site.

FOR ALL PART NUMBERS, PLEASE SCAN THE PRODUCT QR CODE



PL3000 LATHE

Shaft diameter: 4 - 11.25" / 101.6 - 285.8 mm

The PL3000 Portable Lathe is a rugged, high-powered tool engineered to handle large shaft and roll journal machining tasks directly at the job site, eliminating the need for costly disassembly and off-site repair.

Designed to bolt securely to the end of a shaft, it provides a stable platform for turning operations even under demanding conditions. The PL3000 features a robust turning bar with a reach of up to 16 inches - extendable to 22" / 558.8 mm with an optional extension - and a counterbalanced body that minimizes chatter and ensures smooth cutting throughout the machining cycle. Powered by a 3.08 HP electric motor or an optional 1.22 HP pneumatic motor, it delivers the torque needed to remove significant material quickly, while maintaining precise control through a seven-step variable axial feed system. Setup is fast and straightforward, with experienced operators able to align and begin cutting in under an hour using a precision tapered mounting flange.

The PL3000 is also compatible with a wide range of tool holders and accessories, including ID mounting collets and abrasive finishing attachments, making it ideal for restoring damaged shafts, trunnions, and large journal surfaces. Its combination of power, precision, and portability makes the PL3000 a trusted solution for heavy-duty field turning operations.

FOR ALL PART NUMBERS, PLEASE SCAN THE PRODUCT QR CODE



PL4000 LATHE

Shaft diameter: 8 - 24" / 203.2 - 609.6 mm

The PL4000 Portable Lathe is the largest model in the CLIMAX portable lathe lineup, purpose-built for re-turning large shafts and roll journals directly in the field. Engineered for heavy-duty applications, it mounts securely to the end of a shaft and delivers exceptional power, precision, and reach - eliminating the need for complex disassembly or transport of oversized components.

Its low-profile design requires minimal radial clearance, allowing it to operate in tight, confined spaces while still providing a generous 24.75" cutting range, extendable to 27" with optional accessories. The PL4000's robust pneumatic drive system delivers up to 450 ft-lbs of torque to the tool head, enabling efficient material removal even on hardened surfaces. The machine's automatic, reversible tool feed is adjustable during operation, making it easy to achieve smooth, accurate finishes and even tapered cuts of up to 2.5" per foot.

Setup is straightforward and typically completed in under an hour, thanks to a machined mounting plate and user-friendly alignment system. With its combination of strength, compactness, and versatility, the PL4000 is the ideal solution for field teams tasked with restoring large rotating equipment quickly, safely, and to precise tolerances - anywhere access and time are limited.

FOR ALL PART NUMBERS, PLEASE SCAN THE PRODUCT QR CODE

KEY MILL

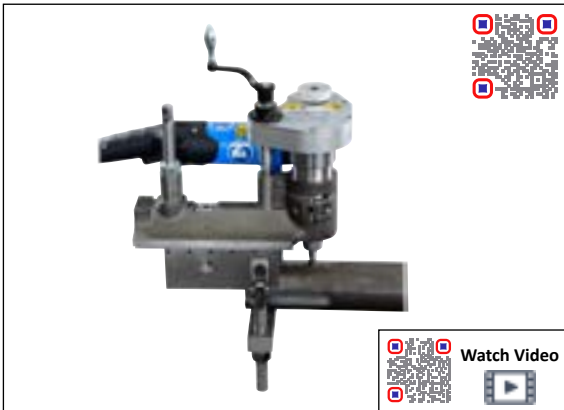

KM3000 KEY MILL

Shaft diameter: 0.75 - 10.5" / 19.1 - 266.7 mm

The KM3000 Key Mill, CLIMAX's original portable machine, is a compact and powerful solution for precision keyway cutting in the field. Designed to avoid major disassembly, it's ideal for industries like power generation, mining, shipbuilding and logging industry.

It mounts quickly with a self-centering V-base and handles shaft diameters from 1.5 - 4.5" / 38.1 - 114.3 mm, or 0.75 - 10.5" / 19.1 - 266.7 mm with optional accessories. Its dovetail slide system and 0.001" / 0.025 mm depth dial ensure smooth, accurate cutting. Compatible with electric or pneumatic drives, it runs from 200 to 530 RPM. Weighing 53 lbs / 24 kg, the KM3000 fits tight spaces and cuts full-depth 6" / 152.4 mm keyways in under four minutes - delivering fast, professional results anywhere.

FOR ALL PART NUMBERS, PLEASE SCAN THE PRODUCT QR CODE



KM4000 KEY MILL

Shaft diameter: 4 - 24" / 101.6 - 609.6 mm

The KM4000 Key Mill is a heavy-duty, portable milling machine engineered for cutting wide keyways, stress relief pockets, motor mount slots, and similar features directly on-site. Built with a compact, rigid frame, it clamps onto shafts from 4 - 24" / 101.6 - 609.6 mm, requiring just 8.5" / 215.9 mm of shaft space. It offers 7.88" / 200.2 mm of longitudinal and 2" / 50.8 mm of lateral travel, enabling wide, extended cuts in one setup. Precision is ensured via machined dovetail slideways and a zeroing depth dial. A high-torque motor maintains speed under load, even on hardened materials. Its self-centering contoured base supports precise, multi-orientation use. Ideal for power and shipbuilding industries, the KM4000 provides fast setup and powerful, portable milling in demanding field conditions.

FOR ALL PART NUMBERS, PLEASE SCAN THE PRODUCT QR CODE

DRILLS



COMPACT DRILL

Drill size: up to 4" / 101.6 mm diameter

The Compact Drilling Machine series delivers powerful performance in tight spaces, with just 2.5" / 63.5 mm side clearance and 15" / 381 mm overhead clearance, making it ideal for wind turbines, ship hulls, and structural frames. Capable of drilling up to 4" / 101.6 mm in a single pass, it also supports reaming, rotabroaching, and back-spot facing. The compact drill is fully reversible and can drill up or down allowing for through hole creation. Available in travel lengths from 7 - 18" / 177.8 - 457.2 mm, it adapts to varied depths and includes precision feed control for accurate cuts. The optional electro-permanent magnetic base ensures strong, safe anchoring without continuous power. Remote pendant operation and ergonomic design improve safety in challenging environments. A built-in interlock system prevents drilling unless the base is fully engaged - ensuring protection during operation.

FOR ALL PART NUMBERS, PLEASE SCAN THE PRODUCT QR CODE



PD3000 PNEUMATIC DRILL

Drill size: 0.69 - 1.5" / 1.75 - 38.1 mm

The PD3000 Pneumatic Drill is a compact, high-power tool designed for fast (thanks to quick lock design allowing for swift (dis)mounting), repeatable drilling in tough environments like shipyards, structural steel work, and heavy equipment maintenance. Its 3.0 HP motor delivers 30% more power than comparable tools, efficiently drilling holes up to 1.5" / 38.1 mm in diameter - even in hard metals like HY80 steel. Ideal for repetitive, precision tasks such as flange or pressure vessel bolt patterns, it features an automatic retract system that cycles up to 10 times faster than the feed rate. Compatible with standard drill bushings, it fits existing templates easily. Lightweight and portable, the PD3000 ensures reliable performance, safety, and precision in demanding applications.

FOR ALL PART NUMBERS, PLEASE SCAN THE PRODUCT QR CODE

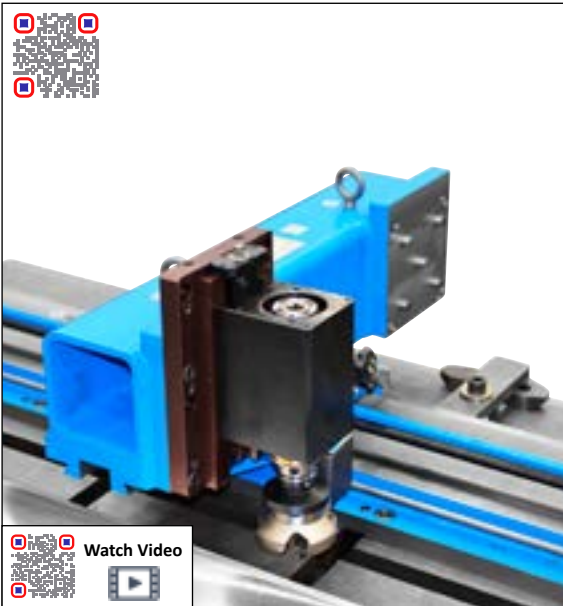

PM4200 MILLING MACHINE

Max. X-Axis Travel: 20, 49, or 78" / 508.0, 1,244.6 or 1,981.2 mm

The PM4200 is a highly adaptable 3-axis portable milling machine designed for on-site machining of large or difficult-to-move components such as pump bases, motor mounts, production press structures, and other welded or worn assemblies. Built for precision and versatility, the PM4200 offers bed travel options of 20" / 508 mm, 49" / 1,244.6 mm, or 78" / 1,981.2 mm and supports multiple feed types - manual, electric, or pneumatic - making it easy to tailor the machine to specific job requirements. With a rigid yet compact frame, the system features precision-machined dovetail ways, adjustable gibs, and sealed components that enable smooth operation in any orientation, even in tight or overhead spaces. The machine can be combined with an extended ram and swivel plate for full 360° angular machining. This flexibility allows users to perform complex milling operations like slotting, surfacing, or cutting mounting pads directly on the workpiece without disassembly. The electric feed option enables infinitely variable feed rates and rapid traverse for improved efficiency, while the heavy-duty drive systems deliver reliable torque and speed control. Whether you're reworking structural frames or performing in-place equipment modifications, the PM4200 delivers the accuracy, power, and adaptability required for professional field milling applications.

FOR ALL PART NUMBERS, PLEASE SCAN THE PRODUCT QR CODE

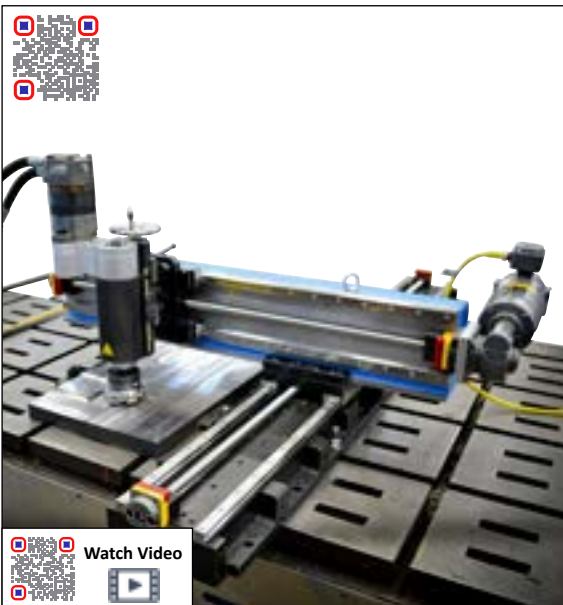

LM5200 LINEAR / GANTRY MILL

Max. X-Axis Travel: 84" / 2,133.6 mm / Max. Y-Axis Travel: 32" / 863.6 mm

The LM5200 is a field-proven portable milling machine with a patented modular bed design, delivering exceptional cutting performance with unmatched flexibility. Whether facing off large pump bases, slotting press frames, or machining structural components on-site, this machine makes it happen with ease. What sets it apart is its modular bed system - built to combine or extend in sections without sacrificing rigidity. When space or orientation demands change, the LM5200 transforms seamlessly between linear and gantry milling modes. It's equipped for power, too, with a heavy-duty 40 taper spindle that can handle large cutters and a choice of hydraulic, electric, or pneumatic drives depending on your needs. The head rotates fully with optional swivel capabilities, and feeds are available on all axes to support smooth, controlled movement during complex milling, boring, or drilling operations. Reduced-friction rail technology keeps things gliding efficiently, minimizing maintenance and maximizing precision. Whether working vertical, overhead, or in a tight spot, this machine is engineered to deliver solid, reliable results. It's tough, adaptable, and designed with the field in mind - perfect for teams who need a solution that performs wherever they take it.

FOR ALL PART NUMBERS, PLEASE SCAN THE PRODUCT QR CODE



LM6200 LINEAR / GANTRY MILL

Max. X-Axis Travel: 176" / 4,470.4 mm / Max. Y-Axis Travel: 106" / 2,692.4 mm

The LM6200 is a heavy-duty, precision milling machine with a patented modular bed design delivering exceptional results in demanding field environments. Whether working in a power plant, shipyard, or structural fabrication setting, this machine is built to handle large-scale milling tasks without the need to remove equipment from service. What sets the LM6200 apart is its flexible, modular design - engineered to switch seamlessly between linear and gantry configurations, allowing users to adapt the setup to the job rather than the other way around. The bed sections are built for extreme rigidity, maintaining tight tolerances even when extended, and the system supports machining in vertical, horizontal, or inverted orientations. With a powerful heavy-duty 50 taper hydraulic spindle capable of driving large face mills up to 10" / 254 mm and a 360° rotating tool head - optionally enhanced with a swivel plate - operators can handle a wide range of complex cuts with confidence. Electric feeds on all axes ensure smooth, controlled motion, and the reduced-friction rail system improves tracking accuracy while reducing wear over time. Whether surfacing structural bases or modifying critical components on-site, the LM6200 offers a combination of precision, adaptability, and field-proven durability that makes it an essential tool for large-scale portable machining projects.

FOR ALL PART NUMBERS, PLEASE SCAN THE PRODUCT QR CODE

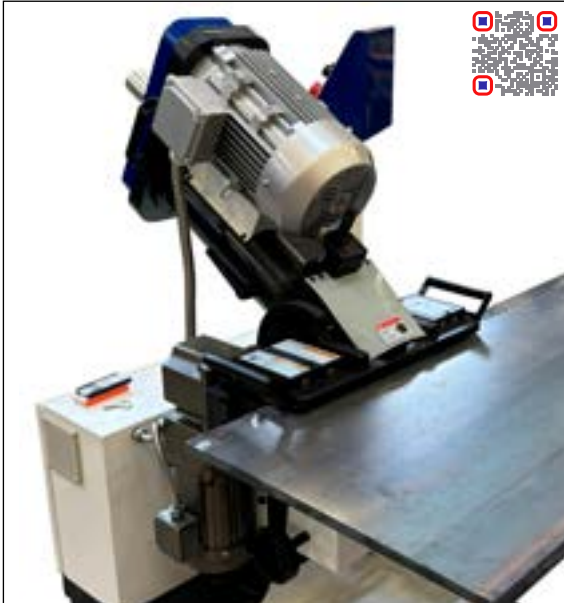

(NEW PRODUCT LAUNCHED 2025)

EM90 PLATE EDGE MILLING MACHINE

Plate thickness: 0.236 - 2.362" / 6 - 60 mm

The EM90 Plate Edge Milling Machine by CLIMAX is a portable, high-precision tool designed for edge milling in industries like fabrication, shipbuilding, pressure vessel manufacturing, and aerospace. Capable of milling steel, stainless steel, aluminum, copper, and alloys, it handles plate thicknesses from 0.236 - 2.362" / 6 - 60 mm. With an adjustable bevel angle of 0° to 90°, it supports facing, V and Y bevels, and clad removal (optional head).

A high-speed milling head and automatic feed reach speeds up to 59" / 1500 mm per minute. Features include electric clamping, manual height adjustment, and swivel castors for mobility. Powered by a 400V or 480V electric motor, it offers real-time speed display and weighs 262 kg, ensuring efficient, safe, and consistent edge milling.

FOR ALL PART NUMBERS, PLEASE SCAN THE PRODUCT QR CODE



(NEW PRODUCT LAUNCHED 2025)

EM60 PLATE EDGE MILLING MACHINE

Plate thickness: 0.236 - 3.150" / 6 - 80 mm

The EM60 Plate Edge Milling Machine by CLIMAX is a powerful, industrial-grade solution for heavy-duty beveling tasks, ideal for shipbuilding, pressure vessel fabrication, and aerospace. It handles plate thicknesses from 0.236 - 3.150" / 6 - 80 mm, offering greater capacity than the EM90. Its standout feature is a reversible milling head that rotates 180°, enabling beveling on both sides without repositioning - boosting efficiency.

It supports bevel angles from 0° to 60°, capable of V, Y, X, and K bevels. The EM60 includes a high-speed milling head with 8 inserts, automatic feed up to 59" / 1500 mm/min, electric clamping, and adjustable angles. Weighing 351 kg, it delivers enhanced stability, precision, and performance for demanding edge preparation tasks.

FOR ALL PART NUMBERS, PLEASE SCAN THE PRODUCT QR CODE



The S.F.E. Group's brand **CALDER** range offers a comprehensive suite of solutions for valve testing, repair, and data acquisition, all built on a foundation of rugged design, modular configurability, and operator-focused usability. At the heart of the range are pressure test systems like the HydroPro™ Console and Universal Straight Valve Tester (USV), which provide highly configurable setups for hydrostatic and air-based valve testing. These platforms are constructed from heavy-duty materials, are CE and ISO 9001:2015 certified, and feature proprietary technologies like Easy-Out™ seal plates and integrated safety interlocks to maximize efficiency and safety in demanding industrial environments.

Complementing the core testing equipment are specialized tools such as the ProSet™ Pilot Valve Tester and the QuickSet™ Safety Relief Valve Tester, each tailored for precise applications like pilot-operated valve performance verification and safety relief valve testing, respectively. These machines are field-ready, shop-compatible, and backed by long warranties, making them practical for both mobile operations and fixed test benches.

To enhance accuracy and documentation, **CALDER** also offers the SmarTest™ DAAS, a digital data acquisition and analysis system that integrates with most of their equipment. It supports real-time pressure monitoring, automatic report generation, and API-standard testing, rounding out a product line that delivers end-to-end solutions for modern valve maintenance professionals.

CALDER machines are always nearby available within the S.F.E. Group's network and can be consulted on the dedicated website: www.CALDERTESTERS.com.





Watch Video

QUICKSET™ SAFETY RELIEF VALVE (SRV) TESTER

Type of Valve: Relief valves

The CALDER QuickSet™ Safety Relief Valve Tester is a robust, modular, and highly configurable system designed for precise and efficient pressure relief valve testing in both shop and field environments. Its compact skid-mounted frame allows for easy transport, yet it houses serious testing power with clamping options up to 60 tons and test pressure capacities exceeding 6,000 PSI. Designed to grow with your operation, QuickSet offers a wide range of seal plate sizes, vessel configurations, and accessories, enabling users to test everything from small utility valves to high-pressure industrial safety valves. A standout feature is the SmartTest™ data acquisition system, which provides digital readouts, auto pass/fail functionality, and integrated bubble counting for API 527 compliance - all of which improve accuracy and documentation. The system's high-flow design ensures smooth pressure delivery and protects valve seats by reducing impact, while hydraulic clamping, intuitive controls, and splash-shield safety features streamline operation and improve operator safety. The interlock system ensures the clamp cannot release until pressure is safely vented, adding another layer of protection. Backed by a 2-year standard warranty, QuickSet is the professional's choice for reliable, repeatable, and scalable safety valve testing - ideal for service shops, refineries, power plants, and valve repair specialists.

FOR ALL PART NUMBERS, PLEASE SCAN THE PRODUCT QR CODE



Watch Video

HYDROPRO™ UNIVERSAL STRAIGHT VALVE TESTER

Type of Valve: Ball, globe, gate, check, & butterfly valves

The HydroPro™ Universal Straight Valve Tester is a rugged, high-capacity testing solution purpose-built for clamping and hydrostatically testing straight-bodied valves with speed, precision, and safety. Available in multiple sizes and tonnage configurations - ranging up to 150 tons - the USV platform supports a wide variety of valve types and pressure classes, making it a smart fit for valve service shops, OEMs, and industries like oil and gas, power generation, and chemical processing. Its standout Easy-Out™ seal plate system allows operators to switch between valve types quickly, without tools or downtime, while the single-cylinder clamp and hydraulic tilt mechanism simplify setup and ensure complete air evacuation for more reliable tests. The USV pairs seamlessly with the HydroPro™ Console, enabling rapid water fill, precise pressure control, and even concurrent valve testing for enhanced productivity. Built from 12-gauge steel and certified ISO 9001:2015 standards, the USV also features an interlock system that ensures test pressure is fully relieved before clamp release - adding critical operator safety. Designed to grow with your operation, its modular architecture and wide range of compatible accessories allow you to expand capabilities without overhauling your setup. The HydroPro™ Universal Straight Valve Tester is a complete, professional-grade solution for high-volume, high-precision valve testing.

FOR ALL PART NUMBERS, PLEASE SCAN THE PRODUCT QR CODE



SAFETY RELIEF VALVE TESTER

Type of Valve: Relief valves

The CALDER Safety Relief Valve Tester (SRV) is a purpose-built, high-performance system for testing pressure safety valves with exceptional accuracy, safety, and ease of use. Designed for service shops, power plants, refineries, and valve OEMs, the SRV tester combines rugged construction with operator-focused features that make it ideal for daily, repeated use. Its 90-ton hydraulic clamping system and durable 12-gauge steel frame ensure long-term reliability in industrial environments, while the test panel's smart layout, viewing window, and integrated splash shield improve operator safety and comfort. The SRV stands out for its unique J-tube design, which cushions valve seating during pressurization to reduce seat damage and improve test consistency. It accommodates a wide range of valve sizes and pressures - up to 6,000 PSI - and integrates quick-connect pressure gauges, stainless steel seal plates, and a safety interlock system that prevents clamp release until internal test pressure is vented. Optional test vessels allow for fast water fill and pressurization, dramatically reducing test cycle times. The SRV platform is field-upgradable and supported by CALDER's renowned customer service and 2-year standard warranty. It's a versatile, operator-friendly solution engineered to deliver consistent results in safety valve verification across multiple industries.

FOR ALL PART NUMBERS, PLEASE SCAN THE PRODUCT QR CODE



TURN-AROUND-TESTER™

Type of Valve: Ball, globe, gate, & check valves

The Turn-Around-Tester™ (TAT) is a fully integrated valve testing system designed for true portability without sacrificing performance, making it equally at home in the field or the workshop. Its compact footprint and rugged frame are engineered to fit securely in the bed of a full-size pickup truck, allowing technicians to perform hydrostatic or gas-over-water pressure tests directly from the vehicle - ideal for on-site valve servicing during plant turnarounds or remote maintenance jobs. Extendable legs transform the TAT into a stable, ergonomic workstation when deployed on the ground or in a shop, and built-in forklift pockets and rigging points make it easy to maneuver using standard handling equipment. The system includes a 25-ton hydraulic clamping fixture, 6,000 PSI test capability, and a self-contained water reservoir for hydrostatic testing without external tanks - enabling use in environments with limited utilities. The test console is positioned at working height whether on a truck or on stands, and features a splash-shielded control panel, viewing window, and intuitive layout for safe, efficient operation. Designed to conform with API 598 testing standards, the TAT is backed by CALDER's industry-leading 2-year warranty and ISO 9001:2015-certified quality. It's a versatile, high-performance tool for mobile valve testing teams and shop-based technicians alike.

FOR ALL PART NUMBERS, PLEASE SCAN THE PRODUCT QR CODE



SMARTEST™ & HYDROPRO™ CONSOLE

The CALDER HydroPro™ Console and SmarTest™ DAAS represent two essential accessories in the CALDER valve testing ecosystem, each offering advanced functionality that enhances efficiency, accuracy, and traceability in pressure testing applications.

The HydroPro™ Console is a rugged, highly configurable test control system capable of managing a wide range of hydrostatic and air-based pressure tests across diverse valve types. Built with 12-gauge steel components, it features dual-port test capability, quick-fill circuits, drip tube leak detection, and support for up to 10,000 PSI. It pairs seamlessly with CALDER valve testers, allowing users to test multiple valves concurrently while ensuring safe, reliable performance.

Complementing this is the SmarTest™ DAAS (Data Acquisition and Analysis System), a touch-screen controlled digital platform that automates test data collection, report generation, and pass/fail analysis. Designed to work with both new and legacy CALDER systems - as well as some third-party testers - SmarTest™ captures hydrostatic decay, set pressure, and seat leakage tests in real-time, with customizable PDF/CSV reporting and optional email delivery. Its intuitive LabVIEW interface, pressure transducer compatibility, and upgrade paths for multiple channels make it an ideal choice for operations demanding traceable, repeatable test records. Together, these two accessories deliver a complete, professional-grade upgrade to any valve testing workflow.

FOR ALL PART NUMBERS, PLEASE SCAN THE PRODUCT QR CODE



PROSET™ PILOT VALVE TESTER

Type of Valve: Pilot valve (pop-action and modulating)

The CALDER ProSet™ Pilot Valve Tester is a specialized, high-precision system engineered to test both modulating and snap-acting pilot valves across a wide pressure range of 15 to 6,000 PSI. Designed for use in valve service shops, refineries, and power plants, the ProSet provides accurate performance validation of pilot-operated pressure relief valves (PORVs), with dedicated features for set-point testing and exhaust leakage verification. The system includes a modular t-slot valve mounting rail, corrosion-resistant components, and a built-in splash shield for safe and ergonomic operation. A standout safety feature is the integrated pressure-sensing flashlight, which activates only when pressure is present and automatically turns off once pressure is released. Operators benefit from intuitive controls, quick-connect gauges, and a clear separation between the control panel and valve mounting area. For digital traceability and automation, the ProSet integrates seamlessly with CALDER's SmarTest™ DAAS, offering real-time performance tracking, data logging, and automatic report generation. With its compact footprint, robust construction, and ISO-certified components, the ProSet is well-suited for high-volume pilot valve testing environments where repeatability, safety, and documentation are critical. Backed by a standard 2-year warranty and optional 5-year coverage, the ProSet is a smart, future-ready addition to any valve testing program.

FOR ALL PART NUMBERS, PLEASE SCAN THE PRODUCT QR CODE







www.SFE-RENTALS.com

RENTAL SOLUTIONS

www.SFE-BRANDS.com



SPECIALIZED FABRICATION EQUIPMENT
GROUP

RENTAL SOLUTIONS

COMPREHENSIVE GLOBAL RENTAL SOLUTIONS BY S.F.E. GROUP

Specialized Fabrication Equipment (in short: S.F.E.) Group proudly offers comprehensive and flexible rental solutions through an expansive and strategically positioned network of rental depots located across North America, Europe, the Middle East, and the Asia Pacific region. This global infrastructure ensures seamless access to an extensive inventory of high-performance rental equipment, tailored to meet the evolving demands of critical industries worldwide.

S.F.E. Group's rental portfolio includes industry-leading technologies and equipment from renowned brands, such as **CLIMAX** portable machining systems, **AXXAIR** orbital tube and pipe cutting and welding machines, **H&S TOOL** and **TAG PIPE** cold cutting and bevelling tools, and **MATHEY DEARMAN** pipe flame cutting and bevelling machines. Each unit is carefully maintained and selected for its proven reliability, enabling precision, efficiency, and safety across diverse field applications.

To ensure optimal performance and support, every S.F.E. Group rental depot is staffed with **OEM-trained technicians** who deliver expert consultation, comprehensive product training, and first-class technical service. S.F.E. Group's commitment to customer success extends beyond tool rental to encompass total lifecycle support, from planning through execution.

With a **global rental fleet exceeding 2,500 specialized tools**, S.F.E. Group continues to invest in expanding and modernizing its rental operations to meet the growing and rapidly shifting needs of its customers. The rental fleet is regularly updated to incorporate the latest advancements in fabrication technology, maintaining the highest standards of quality, reliability, and operational performance.

By partnering with S.F.E. Group, customers gain immediate access to cutting-edge equipment without the burden of capital expenditure - enabling greater agility, reduced project risk, and the assurance that the right tools are always available for the job.

www.SFE-RENTALS.com

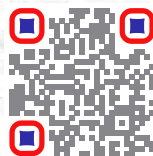

**Looking for an S.F.E. Group
rental solution near you?**

Contact us:

rentals@sfe-brands.com

PRODUCT LINES AVAILABLE FOR RENTAL INCLUDE



Orbital cutting / Cutting accessories / Orbital welding /
Open head welding / Closed head welding



Line boring equipment / Bortech bore welding machines / ID Mount flange facers /
OD Mount flange facers / ODF Speed facers™ / Milling machines /
Key mills / Portable lathes / CM6200 Circular mill / Compact drill



Pipe beveling / Pipe cold cutting and beveling / Cutting and beveling accessories



Saddle machines / Band crawler



Pipe bevelling / Pipe cold cutting and bevelling / Cutting and bevelling accessories

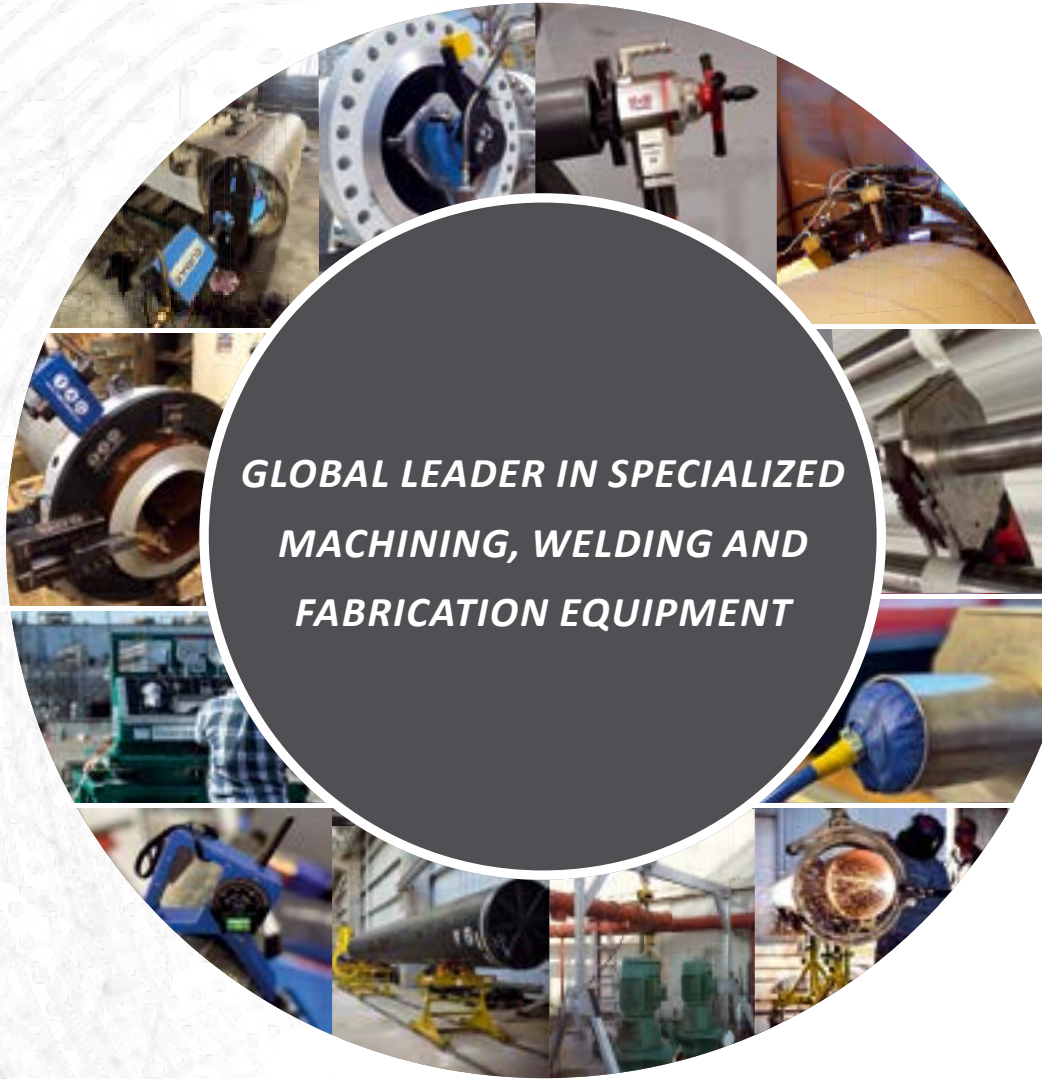

**GLOBAL LEADER IN SPECIALIZED
MACHINING, WELDING AND
FABRICATION EQUIPMENT**



**SPECIALIZED FABRICATION EQUIPMENT
GROUP**

Contact Americas
sales@sfe-brands.com

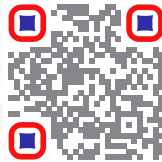

Contact International
sales-int@sfe-brands.com



Our group policy is one of continuous improvements and acquisitions. Products and data tables are subject to change and may vary from those illustrated. Copyright © 2026 Specialized Fabrication Equipment Group, All rights reserved.