

# MATHEY DEARMAN®

JUNE 2023

## COMPLETE BROCHURE (OUTSIDE THE AMERICAS)

### PIPE FLAME CUTTING AND BEVELLING



### PIPE ALIGNMENT AND REFORMING CLAMPS



### PIPE RIGGING EQUIPMENT





## SPECIALIZED FABRICATION EQUIPMENT GROUP

### Introduction to S.F.E. Group

S.F.E. Group was founded in 2019 after the merger of three world leading OEM's in the field of pipe fabrication tooling and machinery: B&B Pipe and Industrial Tools LLC (USA), Mathey Dearman Inc. (USA) and TAG Pipe Equipment Specialists (UK). The most recent acquisition dates back to the start of 2022 when the Axxair Group was added to the S.F.E. Group.

S.F.E. Group offers a wide range of products and is continuously exploring new product design and development, as well as add-on acquisitions to enhance its portfolio and to fulfil increasing industries' demands.

With offices and warehousing on 4 continents, 120 employees and more than 250 partnerships and distributors worldwide, S.F.E. Group prides itself in consistently offering the highest standard of both product quality and service to all its customers.

S.F.E. Group looks forward to welcoming you into its global network as a partner, distributor or end user customer and remains at your disposal at any time.



S.F.E. GROUP HEAD OFFICE - USA



S.F.E. GROUP HEAD OFFICE - FRANCE

### OUR BRANDS

 Where There's Pipe, There's Mathey! PIPE FLAME CUTTING AND BEVELLING PIPE ALIGNMENT AND REFORMING CLAMPS PIPE RIGGING EQUIPMENT <a href="http://www.MATHEY.COM">www.MATHEY.COM</a>	 The Pipe Fabricators Source PIPE JACK AND STANDS MEGA ROLLERS AND STANDS MATERIAL HANDLING EQUIPMENT <a href="http://www.BBPIPETOOLS.COM">www.BBPIPETOOLS.COM</a>	 World Leading Manufacturer of Pipe Beveling and Cutting Machines PIPE BEVELLING MACHINES PIPE COLD CUTTING MACHINES <a href="http://www.TAG-PIPE.COM">www.TAG-PIPE.COM</a>	 Innovative Orbital Solutions ORBITAL CUTTING / BEVELLING AND FINING ORBITAL WELDING <a href="http://www.AXXAIR.COM">www.AXXAIR.COM</a>	 Purging Solutions for the perfect pipe weld! PIPE WELDING SYSTEMS LOGS, CHAMFER MACHINES PIPE CLEANERS <a href="http://www.PURGEMASTERS.COM">www.PURGEMASTERS.COM</a>	 The Pipe Fitters Companion FIT-UP AND ALIGNMENT TOOLS LAYOUT AND MARKING TOOLS <a href="http://www.FIT-UP-PRO.COM">www.FIT-UP-PRO.COM</a>
--	---	---	---	---	--



## Introduction to Mathey Dearman

The company Mathey Dearman was originally founded in the United States in the 1930's. During the first decades its founder C.A Mathey developed patented saddle-type portable pipe cutting and bevelling machines and clamping, aligning and reforming systems for pipes. Mathey Dearman became rapidly a worldwide recognized authority within its field and is still today setting the benchmark and being the point of reference for many applications.

With the merger in 2019 of B&B Pipe and Industrial Tools LLC (USA), Mathey Dearman Inc. (USA) and TAG Pipe Equipment Specialists (UK) and the recent addition in 2022 of AXXAIR (France) into Specialized Fabrication Equipment (S.F.E.) Group, the various product groups offered by the original manufacturers have been re-aligned and integrated into the overall S.F.E. Group product range whilst keeping their own brand identity.

The Mathey Dearman brand portfolio consists of a comprehensive range of pipe equipment: **pipe flame cutting and bevelling machines, pipe alignment and reforming clamps, pipe rigging equipment and Fit-Up Pro's range of fit-up, alignment, layout and marking tools.**

With the Mathey Dearman brand, S.F.E. Group not only wishes to highlight the focus on this particular product line, but also supply the growing demand and diverse applications in the industries that it already serves and intertwine with other product applications within S.F.E. Group.

As an OEM and backed with over 80 years of development, S.F.E. Group prides itself being renowned for its innovations, ground-breaking developments and creative designs within the Mathey Dearman product range. With its engineering capabilities, customer-oriented focus and flexibility, the Mathey Dearman brand provides the possibility to design out-of-the-box pipe machining and tooling solutions to fulfil customers' projects' specific needs in particular and to cater for an ever-evolving industry in general.

Mathey Dearman products are available from the international S.F.E. Group branches on 4 continents, as well as from S.F.E. Group's extensive and continuously expanding global network of partners and distributors.

**Where there's pipe, there's Mathey.  
Get in touch for all your piping applications.**



### PIPE FLAME CUTTING AND BEVELLING



Mathey Dearman manufactures multiple flame and plasma pipe cutters and bevellers and are recognized as the leader in this product category. These machines are used across multiple fabrication projects, most commonly found in the energy construction markets.

### PIPE ALIGNMENT AND REFORMING CLAMPS



With continuous improvement and new additions, Mathey Dearman is now offering the most complete line in the industry of pipe alignment and reforming clamps.

### PIPE RIGGING EQUIPMENT

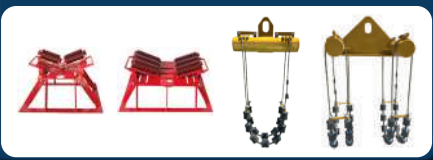

A new line of pipe rigging products is offered under the Mathey Dearman brand. Pipe slings and cradles, pipe launchers and rigging rollers add focus on a complimentary pipeline product category to Mathey Dearman's range of aligning and reforming clamps and flame and plasma pipe cutting and bevelling machines.

# TABLE OF CONTENTS

Introduction to S.F.E. Group.....	2
Introduction to Mathey Dearman .....	3
<b>Mathey Dearman Pipe flame cutting and bevelling.....</b>	<b>5</b>
Saddle machine motorized / manual .....	6
Saddle machine accessories.....	10
E-Z pipecut manual .....	13
E-Z pipecut auto .....	14
E-Z pipecut magnetic .....	15
Band crawler cutting and bevelling machine .....	16
Band crawler better bands.....	18
<b>Mathey Dearman Pipe alignment and reforming clamps.....</b>	<b>19</b>
Sturdi pipe chain clamp.....	20
E-Z Fit Double chain pipe clamp.....	22
Rim clamp .....	24
Manual lever cage clamp .....	26
Ratchet and hydraulic cage clamps .....	27
Super clamp .....	28
Sleeve clamp .....	29
<b>Mathey Dearman Pipe rigging equipment .....</b>	<b>30</b>
Slings and cradles.....	31
Pipe launchers.....	32
Beam clamp rollers .....	33



**SPECIALIZED FABRICATION EQUIPMENT**  
GROUP

*Our group policy is one of continuous improvements and acquisitions.  
Products and data tables are subject to change and may vary from those illustrated.*

**OUR BRANDS**





# MATHEY DEARMAN®

## PIPE FLAME CUTTING AND BEVELLING





The industry standard for over 90 years, the Mathey Dearman saddle machine is versatile, simple to use, and perfect for almost any pipe cutting and beveling application. Lightweight and durable, the Mathey Dearman machine is designed for accurate, quality cuts on 1½" - 48" (48.3 mm - 1,219 mm) pipes.

- Versatile** - Every model works on a range of pipe sizes
- Adaptable** - Works with all standard torches, including plasma
- Portable** - Light and compact, perfect for shop or field applications
- Easy Set-Up** - Mount and begin cutting in as little as 5 minutes
- Proven** - Depended on by professionals for over 70 years
- Fast** - Pipe is ready to weld up to five times quicker than hand cutting and grinding

**Mathey Dearman has been the leader in pipe cutting since its invention of the saddle machine in 1934.**

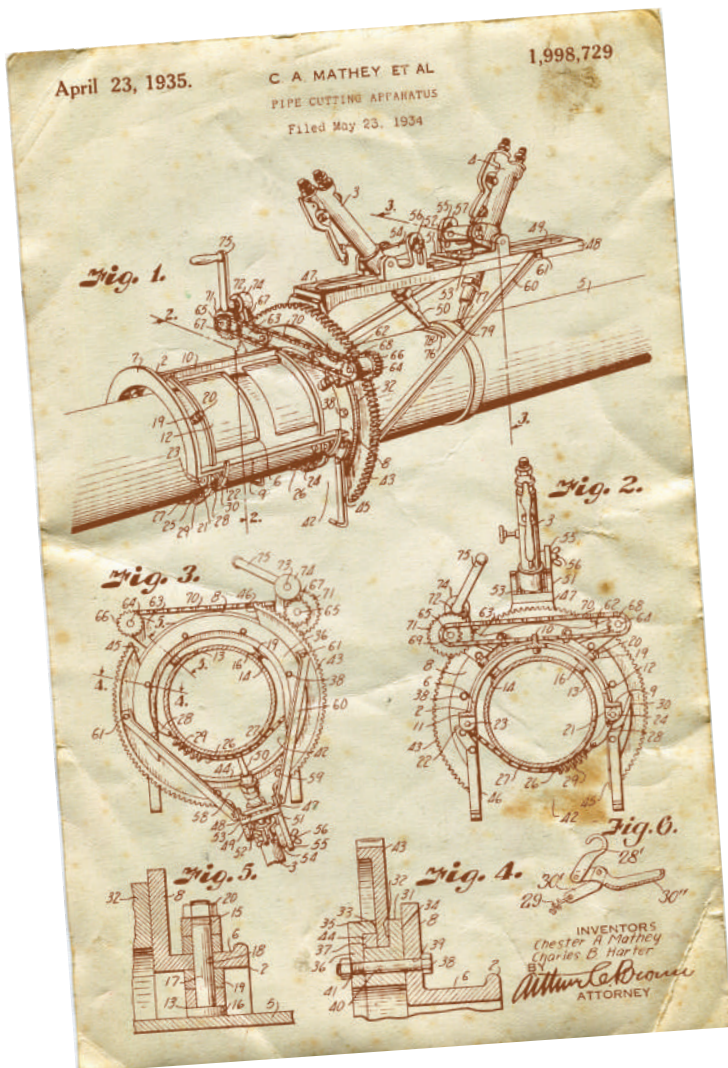

**Manual saddle machine includes:**

- Saddle machine
- Torch arm
- Torch carrier assembly
- Boomer assembly (fastens the machine to the pipe)
- Spacer bolt set
- Parts and operating manual

**Note:** Machine torches sold separately.





Want the easiest way to get a perfect cut every time?

Motorized saddle machines from Mathey Dearman are precise and fast, delivering smooth cuts requiring little or even no grinding.

Both experienced and inexperienced welders can benefit from the increased productivity (up to 5 times quicker!) and cut quality of motorized saddle machines compared to traditional hand-cutting or manual machines.

Motorized PLASMASPEED saddle machines can use 110/230 VAC for pipe sizes 1½" - 48" (48.3 mm - 1,219 mm) and can operate at increased cutting speeds to use powerful plasma torches.

It's what Mathey Dearman calls PLASMASPEED!

**Motorized saddle machine includes:**

- 110/230 VAC motorized saddle machine
- Torch arm
- Torch carrier assembly
- Boomer assembly (fastens the machine to the pipe)
- Spacer bolt set
- Parts and operating manual
- Mounting bracket
- Right-angle precision stepper motor
- Motor control box
- Plasma communication cable

**Note:** Machine torches sold separately - machine shown with optional step spacers and pro model torch.



**Conventional cutting vs saddle cutting time**

**Hand cutting**

**Time: 30 minutes**

- 8" schedule 40 pipe being cut by hand. Time includes measuring, cutting and grinding
- Longer than necessary layout time
- Excessive amount of time to cut the pipe
- Inaccurate/uneven cut requiring grinding
- Extended fit-up time
- Uneven weld gap

**Mathey Dearman cutting**

**Time: 6 minutes**

- 8" schedule 40 Pipe being cut with a 1SA manual saddle machine
- Perfect cut
- No grinding
- Perfect fit-up

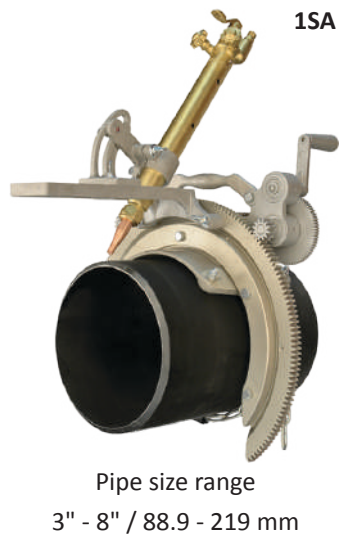

### Manual saddle machines

MACHINE MODEL	MSA	1SA	2SA
Manual with spacer bolts	03.0100.000	03.0101.000	03.0102.000
Manual with step spacers	n/a	03.01S1.000	03.01S2.000

### Motorized saddle machines / PLASMASPEED

MACHINE MODEL	MSA	1SA	2SA
Motorized with spacer bolts 115/230 VAC	03.0100.S01	03.0101.S01	03.0102.S01
Motorized with step spacers 115/230 VAC	n/a	03.01S1.S01	03.01S2.S01

### PLASMASPEED retrofit kits

MACHINE MODEL	MSA	1SA	2SA
PLASMASPEED retrofit kits 115/230 VAC	03.0100.SA1	03.0101.SA1	03.0101.SA1

### General specifications

MACHINE MODEL	MSA	1SA	2SA
Pipe size in (mm)	2" - 4" (60.3 - 114.3 mm)	3" - 8" (88.9 - 219 mm)	6" - 12" (168.2 - 323.8 mm)
Net weight lbs. / kg	10 lbs. / 5.00 kg	16 lbs. / 7.00 kg	26 lbs. / 12.00 kg
Estimated shipping weight lbs. / kg	12 lbs. / 5.40 kg	24 lbs. / 11.00 kg	34 lbs. / 15.50 kg
Shipping dimensions in (mm)	12" x 12" x 10" (305 x 305 x 254 mm)	18" x 18" x 11½" (457 x 457 x 492 mm)	23" x 23" x 12½" (584 x 584 x 318 mm)
Maximum speed (motorized) ipm* / mpm**	141 / 3581	71 / 1803	89 / 2261
Minimum speed (motorized) ipm* / mpm**	4 / 102	4 / 102	6 / 152
Includes spacer bolts to cut pipe sizes	2", 3", 4" (60.3, 88.9, 114.3 mm)	3", 4", 6", 8" (88.9, 114.3, 168.2, 219 mm)	6", 8", 10", 12" (168.2, 219, 273, 323.8 mm)

\* inches per minute | \*\* millimeters per minute





4SA

Pipe size range  
20" - 26" / 508 - 660 mm



5SA

Pipe size range  
24" - 30" / 610 - 762 mm

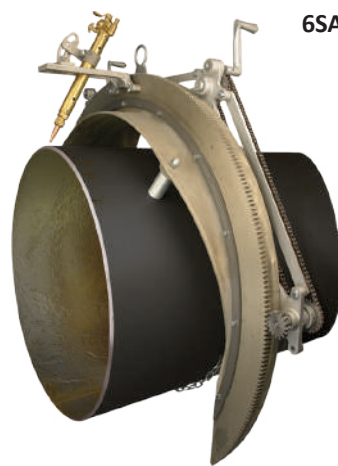

6SA

Pipe size range  
28" - 36" / 711 - 914 mm



8SA

Pipe size range  
36" - 48" / 914 - 1,219 mm

3SA	4SA	5SA	6SA	8SA
03.0103.000	03.0104.000	03.0105.000	03.0106.000	03.0108.000
03.0153.000	n/a	n/a	n/a	n/a

3SA	4SA	5SA	6SA	8SA
03.0103.S01	03.0104.S01	03.0105.S01	03.0106.S01	03.0108.S01
03.0153.S01	n/a	n/a	n/a	n/a

3SA	4SA	5SA	6SA	8SA
03.0103.SA1	03.0103.SA1	03.0105.SA1	03.0105.SA1	03.0105.SA1

3SA	4SA	5SA	6SA	8SA
12" - 20" (323.8 - 508 mm)	20" - 26" (508 - 660 mm)	24" - 30" (610 - 762 mm)	28" - 36" (711 - 914 mm)	36" - 48" (914 - 1,219 mm)
50 lbs. / 22.00 kg	75 lbs. / 34.00 kg	110 lbs. / 50.00 kg	180 lbs. / 82.00 kg	287 lbs. / 130.00 kg
73 lbs. / 33.00 kg	150 lbs. / 68.00 kg	185 lbs. / 84.00 kg	295 lbs. / 134.00 kg	537 lbs. / 244.00 kg
34" x 32" x 12" (864 x 813 x 305 mm)	40½" x 41" x 19" (1,029 x 1,041 x 423 mm)	40½" x 41" x 19" (1,029 x 1,041 x 423 mm)	57" x 43" x 18" (1,488 x 1,002 x 483 mm)	69" x 60" x 21" (1,753 x 1,524 x 533 mm)
47 / 1194	53 / 1346	34 / 864	35 / 889	36 / 914
7 / 178	7 / 178	8 / 203	5 / 127	5 / 127
12", 14", 16", 18", 20" (323.8, 356, 406, 457, 508 mm)	20", 22", 24", 26" (508, 559, 610, 660 mm)	24", 26", 28", 30" (610, 660, 711, 762 mm)	28", 30", 36" (711, 762, 914 mm)	36", 38", 40", 42", 48" (914, 964, 1,016, 1,067, 1,219 mm)

**Contour cutting attachment** - When cutting a 90° saddle on 8" pipe, the combination of the saddle machine and contour cutting attachment reduces cutting and grinding time by up to 80%.



MODEL	PIPE SIZE		PART NO.	PACKAGED WEIGHT		PACKAGED DIMENSIONS	
MSA	1.5" - 4"	48.3 - 114.3 mm	03.0116.MSA	7 lbs.	3.20 kg	23" x 10" x 9"	584 x 254 x 229 mm
1 - 2 SA	3" - 12"	88.9 - 323.8 mm	03.0116.1SA	7 lbs.	3.20 kg	36" x 12" x 12"	914 x 305 x 305 mm
3SA	12" - 20"	323.8 - 508 mm	03.0116.3SA	9 lbs.	4.10 kg	36" x 12" x 12"	914 x 305 x 305 mm
4SA	20" - 26"	508 - 660 mm	03.0116.4SA	9 lbs.	4.10 kg	36" x 12" x 12"	914 x 305 x 305 mm
5SA	24" - 30"	610 - 762 mm	03.0116.5SA	11 lbs.	5.00 kg	48" x 12" x 12"	1,219 x 305 x 305 mm
6SA	28" - 36"	711 - 914 mm	03.0116.6SA	13 lbs.	5.90 kg	48" x 12" x 12"	1,219 x 305 x 305 mm
8SA	36" - 48"	914 - 1,219 mm	03.0116.8SA	16 lbs.	7.20 kg	48" x 12" x 12"	1,219 x 305 x 305 mm

**Contour cutting shape templates** - Produce perfect miter and saddle cuts with the easy to use Mathey Dearman contour cutting attachment. Simply choose the template for the desired type of cut and the torch will follow the template around the pipe. Contour cutting attachments and templates are available for 1½" - 48" (48.3 mm - 1,219 mm) pipe.



**NOTE:** Template form is required prior to order - template cannot be returned

MODEL	SPACERS FOR PIPE SIZES		PART NO	PACKAGED WEIGHT		PACKAGED DIMENSIONS	
MSA	1.5" - 4"	48.3 - 114.3 mm	03.0115.M . .	3.5 - 5 lbs.	1.60 - 2.30 kg	12" x 12" x 9"	305 x 305 x 229 mm
1SA	3" - 8"	88.9 - 219 mm	03.0115.1 . .	4.5 - 6 lbs.	2.00 - 2.70 kg	18" x 18" x 11"	457 x 457 x 279 mm
2SA	8" - 12"	219 - 323.8 mm	03.0115.2 . .	6 - 8 lbs.	2.70 - 3.60 kg	23" x 23" x 13"	584 x 584 x 330 mm
3SA	12" - 20"	323.8 - 508 mm	03.0115.3 . .	11 - 15 lbs.	5.00 - 7.00 kg	36" x 12" x 12"	914 x 305 x 305 mm
4SA	20" - 26"	508 - 660 mm	03.0115.4 . .	18 - 27 lbs.	8.00 - 12.00 kg	36" x 36" x TBD	914 x 914 x TBD mm
5SA	24" - 30"	610 - 762 mm	03.0115.5 . .	22 - 31 lbs.	10.00 - 14.00 kg	42" x 48" x TBD	1,067 x 1,219 x TBD mm
6SA	28" - 36"	711 - 914 mm	03.0115.6 . .	27 - 35 lbs.	12.00 - 16.00 kg	48" x 48" x TBD	1,219 x 1,219 x TBD mm
8SA	36" - 48"	914 - 1,219 mm	03.0115.8 . .	31 - 40 lbs.	14.00 - 18.00 kg	60" x 60" x TBD	1,524 x 1,524 x TBD mm

**Double torch arm** - Reduce set up and cutting time by up to 50% with the double torch arm accessory. By eliminating the need to rotate one torch to obtain a forward or back bevel on the pipe end, the double torch arm dramatically reduces cutting and beveling time.



MODEL	PIPE SIZE		PART NO	PACKAGED WEIGHT		PACKAGED DIMENSIONS	
1SA	3" - 8"	88.9 - 219 mm	03.0101.030	5 lbs.	2.30 kg	20" x 6" x 6"	508 x 152 x 152 mm
2SA	8" - 12"	219 - 323.8 mm	03.0102.015	5 lbs.	2.30 kg	20" x 6" x 6"	508 x 152 x 152 mm
3SA	12" - 20"	323.8 - 508 mm	03.0103.030	5 lbs.	2.30 kg	23" x 10" x 9"	584 x 254 x 229 mm
4SA	20" - 26"	508 - 660 mm	03.0104.021	5 lbs.	2.30 kg	23" x 10" x 9"	584 x 254 x 229 mm
5SA	24" - 30"	610 - 762 mm	03.0105.025	5 lbs.	2.30 kg	23" x 10" x 9"	584 x 254 x 229 mm
6SA	28" - 36"	711 - 914 mm	03.0106.018	5.5 lbs.	2.50 kg	23" x 10" x 9"	584 x 254 x 229 mm
8SA	36" - 48"	914 - 1,219 mm	03.0108.014	5.5 lbs.	2.50 kg	23" x 10" x 9"	584 x 254 x 229 mm

**Pro model torch arm** - Choose the pro model torch arm with the innovative out-of-round roller attachment to create perfect cuts and bevels on oversize, undersize or out-of-round pipe.



DESCRIPTION	PART NO	PACKAGED WEIGHT		PACKAGED DIMENSIONS	
Pro model with out of round	03.0209.000	9.50 lbs.	4.30 kg	16" x 8" x 8"	406 x 203 x 203 mm
Pro model basic assembly	03.0209.001	7 lbs.	3.20 kg	16" x 8" x 8"	406 x 203 x 203 mm
Tracer point	03.0209.012	1.60 lbs.	0.70 kg	12" x 6" x 6"	305 x 152 x 152 mm

Torch holders that can accommodate up to 2" barrel diameter torches are available

## Out-of-round roller attachment

The out-of-round roller attachment kit, that can be fitted on the pro model torch arm, compensates for oversize and undersize pipe, handling out-of-round conditions up to ¼" (6 mm).

This separate attachment comes with all required parts and assembly instructions.

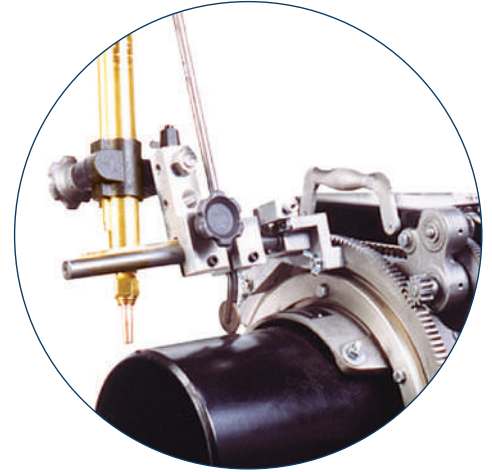

Pro model with out-of-round roller attachment kit installed

DESCRIPTION	PART NO	PACKAGED WEIGHT		PACKAGED DIMENSIONS	
Out of round kit	03.0209.003	2.50 lbs.	1.10 kg	12" x 6" x 6"	305 x 152 x 152 mm

## Cam-adjustable torch carrier

The cam-adjustable torch carrier makes it simple to make perfect, no-notch cuts, every time. Just start the cut away from the desired cut line, use the knurled cam adjustment knob to move the torch into the cut line then start cutting. In addition, the torch holder's large wing screw makes tightening the torch in the torch holder easy, even when wearing gloves. The innovative design even allows forward or back-beveling without the need to reverse the torch holder in the torch arm.

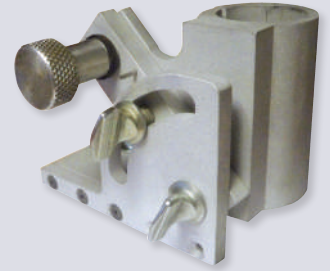

**ITEM NO. 03.0100.052**

## Saddle machine storage box

Store and help protect the saddle machine, torch, torch arm, torch carrier, spacer bolts and parts and operating manual in this specially-designed storage box.

MSA, 1SA, and 2SA storage boxes are made of 16 gauge, powder-coated steel, with attached lifting handles.

Storage boxes for saddle machines larger than the 3SA are made of plywood with reinforced corners and edges.



MODEL	PART NO	DIMENSIONS		MANUAL OR MOTORIZED	BOX TYPE	PACKAGED WEIGHT	
MSA	03.0100.BOX	17" x 17" x 17"	432 x 432 x 432 mm	Manual only	Metal	23 lbs.	11.00 kg
1SA	03.0101.BOX	20" x 18" x 17"	205 x 457 x 432 mm	Manual only	Metal	33 lbs.	15.00 kg
2SA	03.0102.BOX	25" x 22" x 18"	635 x 559 x 457 mm	Manual only	Metal	41 lbs.	19.00 kg
3SA	03.0103.BOX	34" x 34" x 14"	864 x 864 x 356 mm	Manual or motorized	Wood	60 lbs.	27.00 kg
4SA	03.0104.BOX	40" x 38" x 14"	1,016 x 965 x 356 mm	Manual or motorized	Wood	75 lbs.	34.00 kg
5SA	03.0105.BOX	42" x 40" x 14"	1,067 x 1,016 x 356 mm	Manual or motorized	Wood	75 lbs.	34.00 kg
6SA	03.0106.BOX	56" x 48" x 16"	1,422 x 1,219 x 406 mm	Manual only	Wood	175 lbs.	79.00 kg
8SA	03.0108.BOX	70" x 56" x 19"	1,778 x 1,422 x 483 mm	Manual only	Wood	250 lbs.	102.00 kg

\* No spacers required for 4" pipe set up

## Self-storing step-down spacer

Combining multiple spacer bolt sizes into one easy-to-use part, the step-down spacers are machined to the same tolerances as spacer bolts. Each step spacer covers a range of four (4) pipe sizes; eliminating the need to store 16 spacer bolts. No more searching for lost or misplaced spacer bolts with high quality aluminum alloy or stainless steel self-storing step-down spacers.

## Step spacer kit

DESCRIPTION	PART NO	FOR PIPE SIZES		PACKAGED WEIGHT	
1SA Step Spacers	03.0110.1SAKIT	3", 4", 6", 8"	88.9 mm, 114.3 mm, 168.2 mm, 219 mm	1.60 lbs.	0.70 kg
2SA Step Spacers	03.0110.2SAKIT	6", 8", 10", 12"	168.2 mm, 219 mm, 273 mm, 323.8 mm	1.60 lbs.	0.70 kg
3SA Step Spacers	03.0110.3SAKIT	12", 14", 16", 18", 20"	323.8 mm, 356 mm, 406 mm, 457 mm, 508 mm	1.60 lbs.	0.70 kg

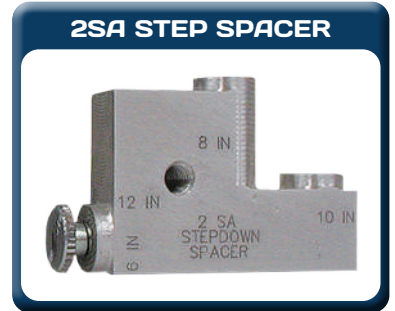

## Step spacers (individual)

DESCRIPTION	PART NO	FOR PIPE SIZES		PACKAGED WEIGHT	
1SA Step Spacer	03.0110.1SA	3", 4", 6", 8"	88.9 mm, 114.3 mm, 168.2 mm, 219 mm	0.40 lbs.	0.20 kg
2SA Step Spacer	03.0110.2SA	6", 8", 10", 12"	168.2 mm, 219 mm, 273 mm, 323.8 mm	0.40 lbs.	0.20 kg
3SA Step Spacer	03.0110.3SA	12", 14", 16", 18", 20"	323.8 mm, 356 mm, 406 mm, 457 mm, 508 mm	0.40 lbs.	0.20 kg



## Saddle machine spacer bolts

Spacer Bolt Kits include the spacer bolts in one handy container available for any Mathey Dearman saddle machine model. An actual-size diagram is located on the lid, making finding the correct Spacer Bolts quick and easy. All spacer bolts are precision-machined for maximum cutting accuracy and labeled with the Mathey Dearman logo and item number for quick identification.

*Actual size is shown on box lid for quick spacer bolt identification.*

*Spacer bolts can be replaced individually or in sets.*

## Step spacers (individual)

DESCRIPTION	PART NO	FOR PIPE SIZES		PACKAGED WEIGHT	
MSA	03.0MSA.KIT	2", 3"	60.3 mm, 88.9 mm	1 lbs.	0.50 kg
1SA	03.01SA.KIT	3", 4", 6", 8"	88.9 mm, 114.3 mm, 168.2 mm, 219 mm	4 lbs.	1.80 kg
2SA	03.02SA.KIT	6", 8", 10", 12"	168.2 mm, 219 mm, 273 mm, 323.8 mm	5 lbs.	2.30 kg
3SA	03.03SA.KIT	12", 14", 16", 18", 20"	323.8 mm, 356 mm, 406 mm, 457 mm, 508 mm	9 lbs.	4.10 kg
4SA	03.04SA.KIT	20", 22", 24", 26"	508 mm, 559 mm, 610 mm, 660 mm	10 lbs.	4.50 kg
5SA	03.05SA.KIT	24", 26", 28", 30"	610 mm, 660 mm, 711 mm, 762 mm	10 lbs.	4.50 kg
6SA	03.06SA.KIT	28", 30", 36"	711 mm, 762 mm, 914 mm	20 lbs.	9.00 kg
8SA	03.08SA.KIT	36", 38", 40", 42", 48"	916 mm, 964 mm, 1,016 mm, 1,069 mm, 1,219 mm	20 lbs.	9.00 kg

\* No spacers required for 4" pipe set up





Mathey Dearman's E-Z Pipecut portable oxy-fuel cutting and bevelling chain driven machines are the economical solution for cutting and bevelling pipe with wall thickness 5 mm up to 50 mm.

The Mathey Dearman E-Z Pipecut Manual is small and compact, strong and reliable, used by contractors, welders and pipe fitters, equally on-site or in the workshop.

The E-Z Pipecut Manual portable is a straight forward hand operated compact chain - driven pipe cutting machine that provides a smooth, accurate cutting action by incorporating a low gear ratio and worm wheel drive.

The machine also features a quick-release clutch, that allows the operator to disengage the chain from the drive cog for rapid set up and positioning.

The bevelling head angle (up to 45°) can be set quickly and accurately by scale on a rack and pinion.

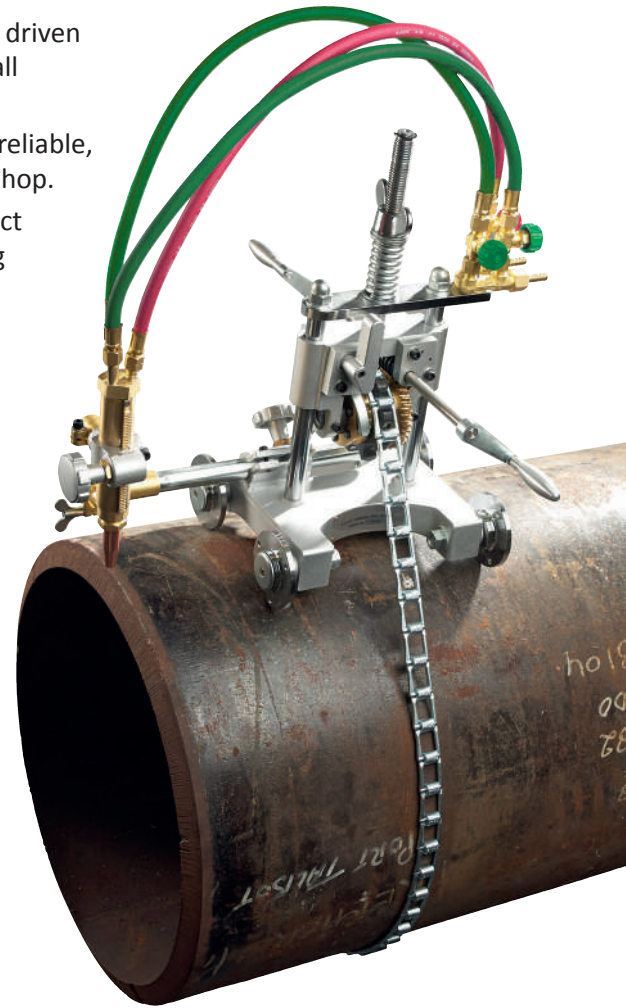
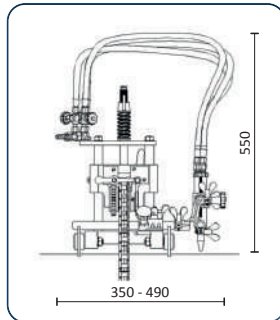
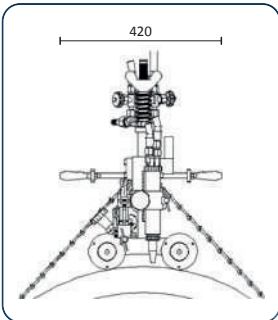

**\* Outside the USA  
the green hoses  
will be blue**



### Guide band

For guaranteed square cuts and bevells on pipe diameters larger than 600 mm, using the optional guide band system to suit the relevant pipe size(s) is recommended.

### E-Z Pipecut Manual includes:

- Cutting machine E-Z Pipecut manual
- Standard chain for cutting pipe diameter of 4½" - 24" / 114 - 600 mm
- Operation instructions

### Technical specification

Part No	EZPCM
Power supply	Manual driven unit
Pipe diameter	Up to 600 mm (in standard configuration)
Wall thickness	5 - 50 mm
Torch	Universal nozzle-mix torch suitable for all nozzle-mix cutting nozzle (nozzles not included)
Cut/bevel angle	Variable up to 45°
Vertical torch +/-	50 mm
Lateral torch +/-	100 mm
Track width	230 mm
Weight	8.50 kg / 18.70 lbs.
Dimensions	350 (l) x 420 (w) x 550 (h) mm

### CHAIN CALCULATION

Pipe diameter (inch) x 3.142 + 8 = (total inch) x 2.54 = (total cm)  
 Eg. 36" x 3.142 = 113.112 + 8 = (121.11 total inch) x 2.54 = (307.62 total cm)

### GUIDE BAND CALCULATION

Pipe diameter (inch) + 2 x 3.142 + 6 = (total inch) x 2.54 = (total cm)  
 Eg. 36" + 2 x 3.142 = 39.284 + 6 = (45.284 total inch) x 2.54 = (115.02 total cm)



The Mathey Dearman E-Z Pipecut Auto is the powered version of the E-Z Pipecut Manual. Once the speed is set correctly to the wall thickness of the pipe the machine can be driven around the pipe with a speed adjustable remote control.

The E-Z Pipecut Auto will cut and bevel the pipe without the need for intervention from the operator.

The E-Z Pipecut Auto portable oxy-fuel cutting machine can also be used for cutting exotic materials such as stainless steel, by converting from oxy-fuel to a plasma system (plasma torch holder available on request).

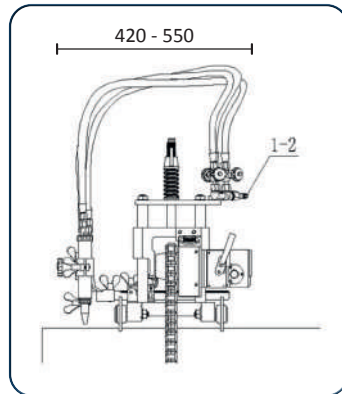
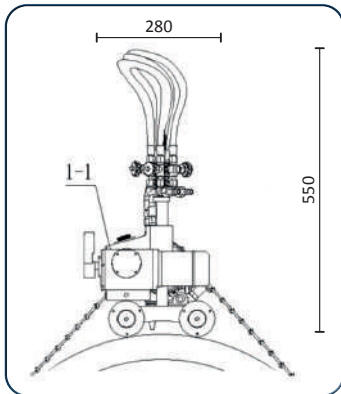

### Guide band

For guaranteed square cuts and bevels on pipe diameters larger than 600 mm, using the optional guide band system to suit the relevant pipe size(s) is recommended.

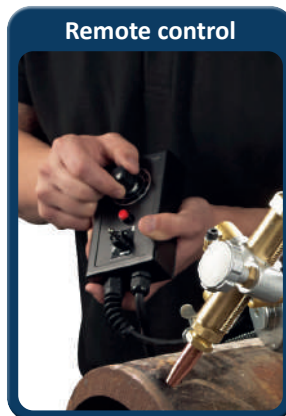

### Remote control

\* Outside the USA the green hoses will be blue

### E-Z Pipecut Auto includes:

- Pipe cutting machine E-Z Pipecut Auto
- Standard chain for cutting pipe diameter of 114 - 600 mm
- Connecting lead (5 m)
- Remote control
- Transformer 110v - 220v
- Operation instructions

## Technical specification

Part No	EZPCA1: 110v / EZPCA2: 220v
Power supply	230v / 110v / 50 - 60Hz
Pipe diameter	Up to 600 mm (in standard configuration)
Wall thickness	5 - 50 mm
Torch	Universal nozzle-mix torch suitable for all nozzle-mix cutting nozzle (nozzles not included)
Cut/bevel angle	Variable up to 45°
Vertical torch +/-	50 mm
Lateral torch +/-	100 mm
Track width	230 mm
Cutting speed	50 - 1,150 mm/min
Weight	16.00 kg / 36 lbs.
Dimensions	420 (l) x 280 (w) x 550 (h) mm

### CHAIN CALCULATION

Pipe diameter (inch) x 3.142 + 8 = (total inch) x 2.54 = (total cm)  
 Eg. 36" x 3.142 = 113.112 + 8 = (121.11 total inch) x 2.54 = (348.26 total cm)

### GUIDE BAND CALCULATION

Pipe diameter (inch) + 2 x 3.142 + 6 = (total inch) x 2.54 = (total cm)  
 Eg. 36" + 2 x 3.142 = 119.393 + 8 = (125.396 total inch) x 2.54 = (318.51 total cm)



The Mathey Dearman E-Z Pipecut Magnetic is the economical solution for cutting and bevelling pipe from 350 mm upwards. The machine is small and compact, strong and reliable, used by contractors, welders and pipe fitters, equally on site as in the workshop.

Two sets of magnetic, electrically driven roller wheels are housed inside the body of the machine. These rollers (offering a magnetic absorbability force of over 50 kg) ensure the machine stays in contact with the pipe as it travels around the circumference, cutting and bevelling as it goes.



### Guide band

For guaranteed square cuts and bevels on pipe diameters larger than 600 mm, using the optional guide band system to suit the relevant pipe size(s) is recommended.

**\* Outside the USA the green hoses will be blue**

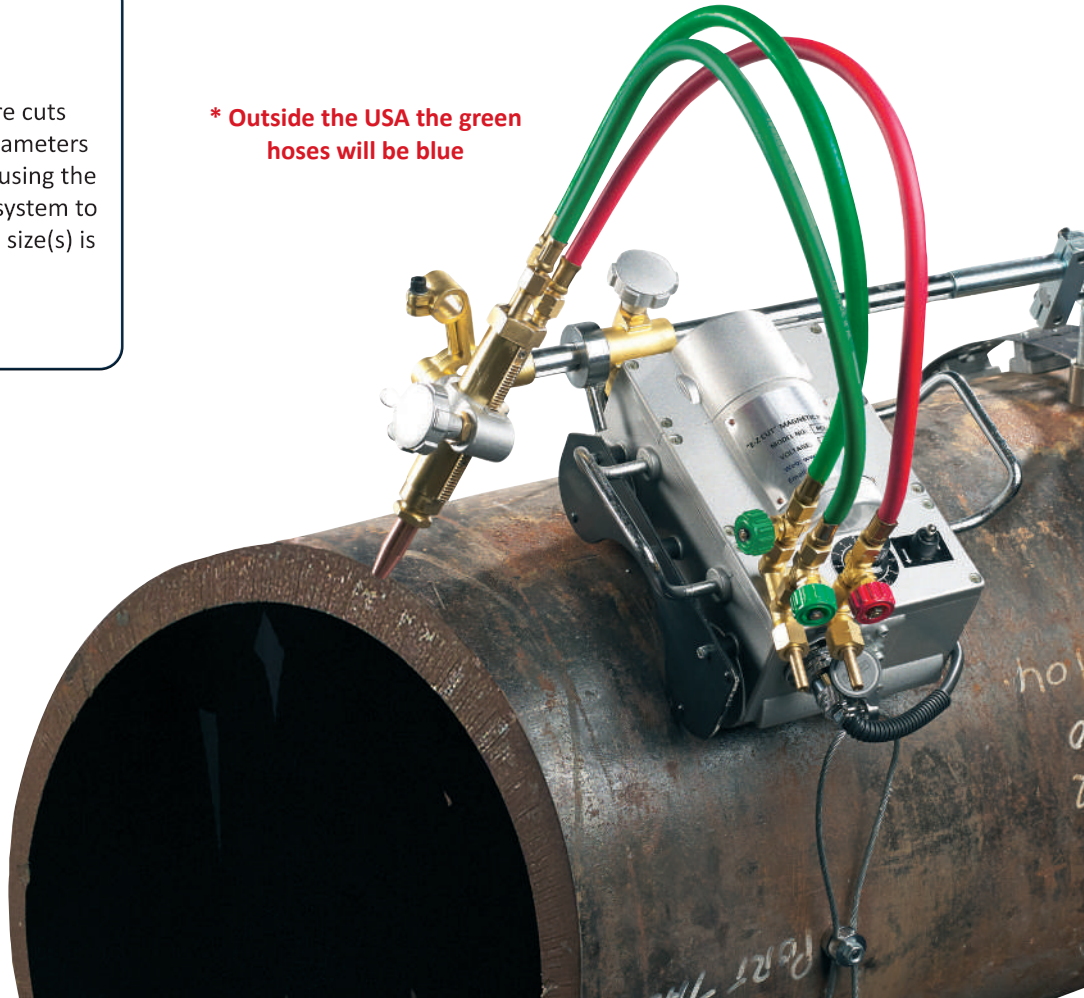

### E-Z Pipecut Magnetic includes:

- Pipe cutting machine E-Z Pipecut Magnetic
- Universal nozzle-mix torch suitable for all nozzle-mix cutting nozzle
- Gas hoses
- Power cable
- Operation instructions

### Technical specification

Part No	EZPCMA1: 110v / EZPCMA2: 220v
Power supply	110v / 220v
Pipe diameter	350 mm upwards
Wall thickness	5 - 50 mm
Torch	Universal nozzle-mix torch suitable for all nozzle-mix cutting nozzle (nozzles not included)
Cut/bevel angle	Variable up to 45°
Vertical torch +/-	50 mm
Lateral torch +/-	100 mm
Track width	50 - 780 mm/min
Weight	20.00 kg / 18.70 lbs
Dimensions	350 (l) x 310 (w) x 280 (h) mm

#### CHAIN CALCULATION

Pipe diameter (inch) x 3.142 + 8 = (total inch) x 2.54 = (total cm)  
 Eg. 36" x 3.142 = 113.112 + 8 = (121.11 total inch) x 2.54 = (307.62 total cm)

#### GUIDE BAND CALCULATION

Pipe diameter (inch) + 2 x 3.142 + 6 = (total inch) x 2.54 = (total cm)  
 Eg. 36" + 2 x 3.142 = 119.393 + 6 = (125.396 total inch) x 2.54 = (318.51 total cm)





# BAND CRAWLER CUTTING AND BEVELING MACHINE



The ideal solution for cutting and beveling in close quarters, the Band Crawler requires as little as 6" (168.2 mm) of clearance around the pipe. Install the stainless steel band anywhere on the pipe and it conforms to the pipe shape, producing a consistent precise bevel, even on severely out-of-round pipe.

The lightweight Band Crawler can be quickly set up and operated by one person on pipe as large as 60" (1,524 mm). Bands 48" (1,219 mm) and larger feature a standard stiffening rib which simplifies one-person set-up.



- Precise** - Band conforms precisely to the out-of-round condition of the pipe to maintain consistent cutting tip distance from pipe surface
- Simple** - One person can set up and cut horizontal or vertical pipes as large as 48" (1,219 mm)
- Low profile** - Requires as little as 10½" (267 mm) of radial clearance
- One size fits all** - One Band Crawler fits all band sizes
- Fast** - 60% faster than hand cutting and grinding
- Motorized** - Available with PLASMASPEED digital motor control

MODEL	PART NO	PACKAGED WEIGHT	
Band crawler with 9' (2.7 m) flexible drive cable	05.0116.009	26 lbs.	11.70 kg
Band crawler with 14' (4.3m) flexible drive cable	05.0116.014	30 lbs.	14.00 kg
Motorized PLASMASPEED band crawler 110/230 VAC	05.0116.S01	26 lbs.	11.70 kg
PLASMASPEED retro fit kit 110/230 VAC	05.0116.SA1	26 lbs.	11.70 kg

## TORCH ANGLE HEAD ADAPTOR



Allows the torch tip to be adjusted for any angle from a square cut (no bevel) to a bevel angle up to 90 degrees while also allowing torch lead or lag angle adjustment.

## RIGHT ANGLE DRIVE ADAPTOR



Permits the flexible drive cable to pivot 180 degrees on the end of the band crawler, lowering the profile of the crawler to 6" (168.2 mm).

## PLASMASPEED



The motorized PLASMASPEED band crawler can increase cutting and beveling efficiency of large diameter pipes up to 60% and is the quickest and easiest cutting tool to set up on vertical pipe.



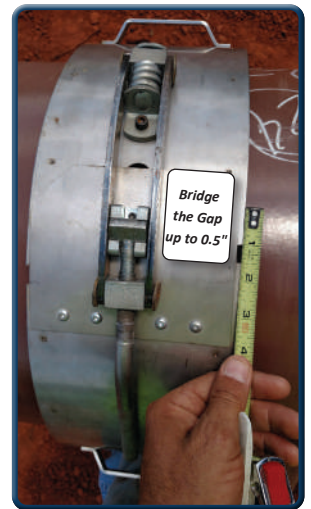
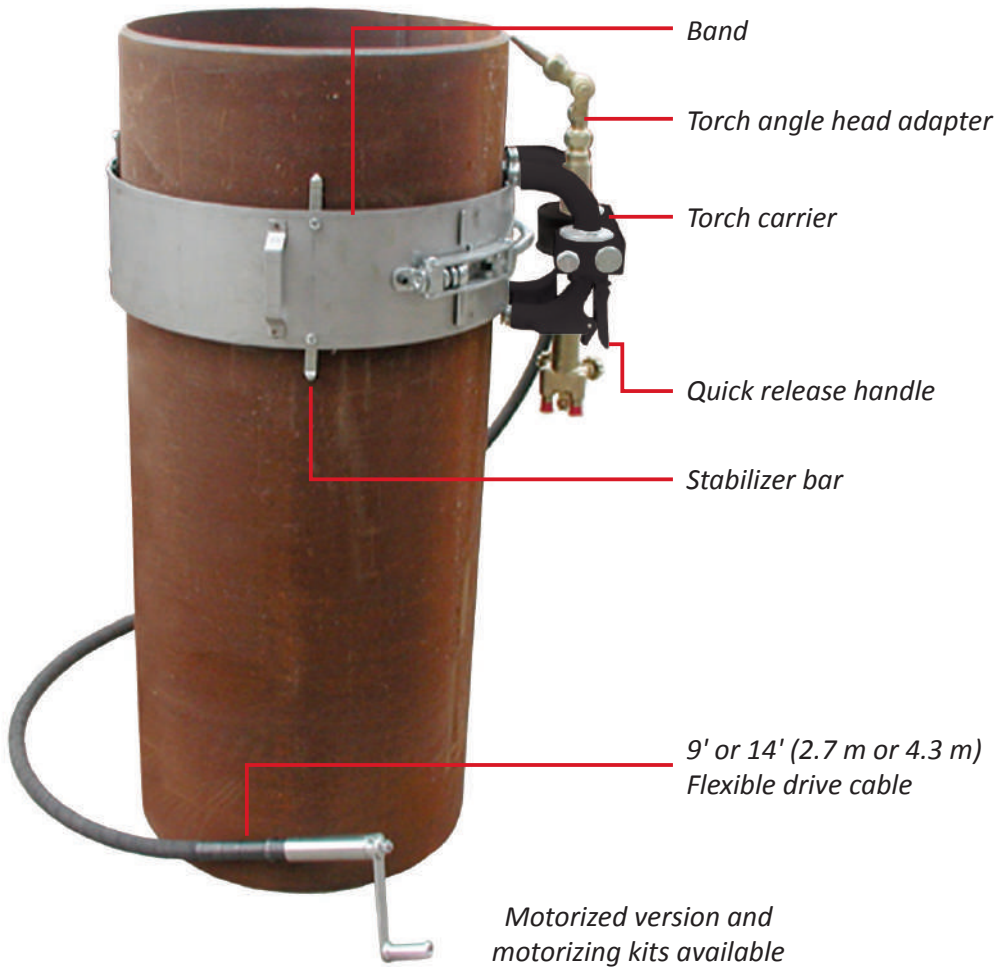

### DRIVE CABLE



Enables the motorized band crawler to be retrofitted to manual operation.

Available in 9' (2.7 m) and 14' (4.3 m) lengths.

### RACK ADJUSTABLE TORCH ARM

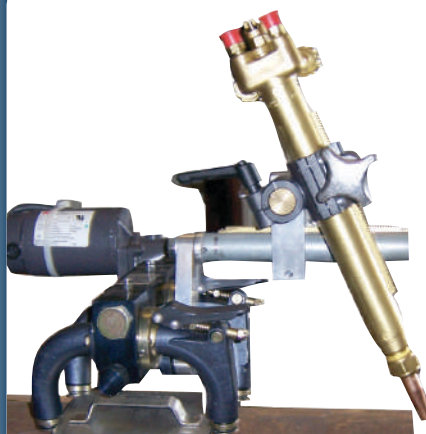

Allows both horizontal and vertical adjustment of the torch in relationship to the pipe surface.

### DOUBLE TORCH ARM

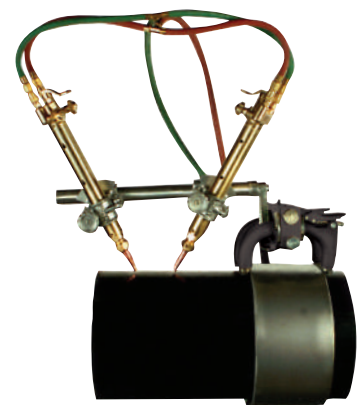

Makes two cuts and bevels simultaneously, reducing cutting time and labor.

- No more special sized bands, Better Bands Bridge the Gap - up to 3 times more gap allowance than any other bands on the market
- Patented 'staggered' latching system for improved setup
- Ensures maximum traction for the machine, maintaining 3 points of contact at all times
- Industry leading gap allowance allows one size to work on coated or out of round pipe
- Consistent speed and travel of the machine equals improved cut quality



Bridge the Gap

## Technical specification

PIPE SIZE		PART NO	PACKAGED WEIGHT	
6"	168.2 mm	05.0204.006	5 lbs.	2.00 kg
8"	219 mm	05.0204.008	6 lbs.	3.00 kg
10"	273 mm	05.0204.010	7 lbs.	3.00 kg
12"	323.8 mm	05.0204.012	7 lbs.	3.00 kg
14"	356 mm	05.0204.014	11 lbs.	5.00 kg
16"	406 mm	05.0204.016	12 lbs.	5.00 kg
18"	457 mm	05.0204.018	14 lbs.	6.00 kg
20"	508 mm	05.0204.020	16 lbs.	7.00 kg
22"	559 mm	05.0204.022	17 lbs.	8.00 kg
24"	610 mm	05.0204.024	18 lbs.	6.00 kg
26"	660 mm	05.0204.026	20 lbs.	9.00 kg
28"	711 mm	05.0204.028	22 lbs.	10.00 kg
30"	762 mm	05.0204.030	25 lbs.	11.00 kg
32"	813 mm	05.0204.032	26 lbs.	12.00 kg
34"	864 mm	05.0204.034	27 lbs.	12.00 kg
36"	914 mm	05.0204.036	29 lbs.	13.00 kg
38"	965 mm	05.0204.038	31 lbs.	14.00 kg
40"	1,016 mm	05.0204.040	33 lbs.	15.00 kg
42"	1,067 mm	05.0204.042	36 lbs.	16.00 kg
44"	1,118 mm	05.0204.044	39 lbs.	18.00 kg
46"	1,168 mm	05.0204.046	43 lbs.	20.00 kg
48"	1,219 mm	05.0204.048	90 lbs.	41.00 kg
50"	1,270 mm	05.0204.050	92 lbs.	42.00 kg
52"	1,321 mm	05.0204.052	96 lbs.	44.00 kg
54"	1,372 mm	05.0204.054	100 lbs.	45.00 kg
56"	1,422 mm	05.0204.056	106 lbs.	48.00 kg
58"	1,473 mm	05.0204.058	110 lbs.	50.00 kg
60"	1,524 mm	05.0204.060	115 lbs.	52.00 kg

## Band crawler accessories

DESCRIPTION	PART NO	PACKAGED WEIGHT	
PLASMASPEED retro fit kit 110/230 VAC	05.0116.SA1	26 lbs.	11.70 kg
Rack-adjustable torch arm	05.0116.032	3 lbs.	1.40 kg
Double torch arm	05.0116.039	4 lbs.	1.80 kg
Right angle drive adapter (for drive cable)	05.0116.030	2 lbs.	0.90 kg
Torch angle head adapter	05.0200.003	1.20 lbs.	0.50 kg
Protective leather cable sleeve	05.0550.SLV	1.50 lbs.	0.70 kg

# MATHEY DEARMAN®

## PIPE ALIGNMENT AND REFORMING CLAMPS







The Mathey Dearman Sturdi Clamp is a chain clamp ideal for schedule 40 and below pipe alignment and reforming. Originally invented in 1930, Mathey Dearman offers the Sturdi Clamp as a lighter duty version of the Mathey Dearman Double Jackscrew pipe chain clamp.

Traditional methods for aligning heavy wall pipe, such as ratchet cable pullers, lugs and bottle jacks are time consuming and inconsistent in the results they achieve, making them unsuitable for the majority of critical alignment applications.

One clamp can fit up a variety of sizes of pipes 1" to 36" (33.4 mm to 914 mm) diameter, elbows, tees, flanges end caps and most other pipe fittings (using the level and support device purchased as an accessory).

The Mathey Dearman Sturdi Clamp is available in carbon steel chain or stainless steel version.

All Mathey Dearman Sturdi Clamps feature stainless steel jackscrews, jackbars and main blocks.

The high rise jackbars and main block provide the strength to reform the pipe either side of the weld gap to eliminate "Hi-Lo", whilst enabling the welder to weld the entire circumference of the pipe with the clamp in situ.

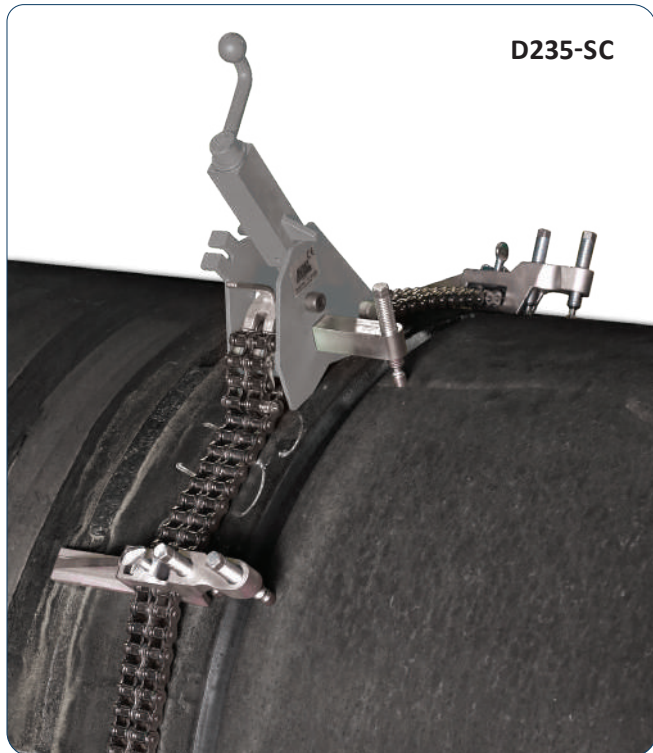
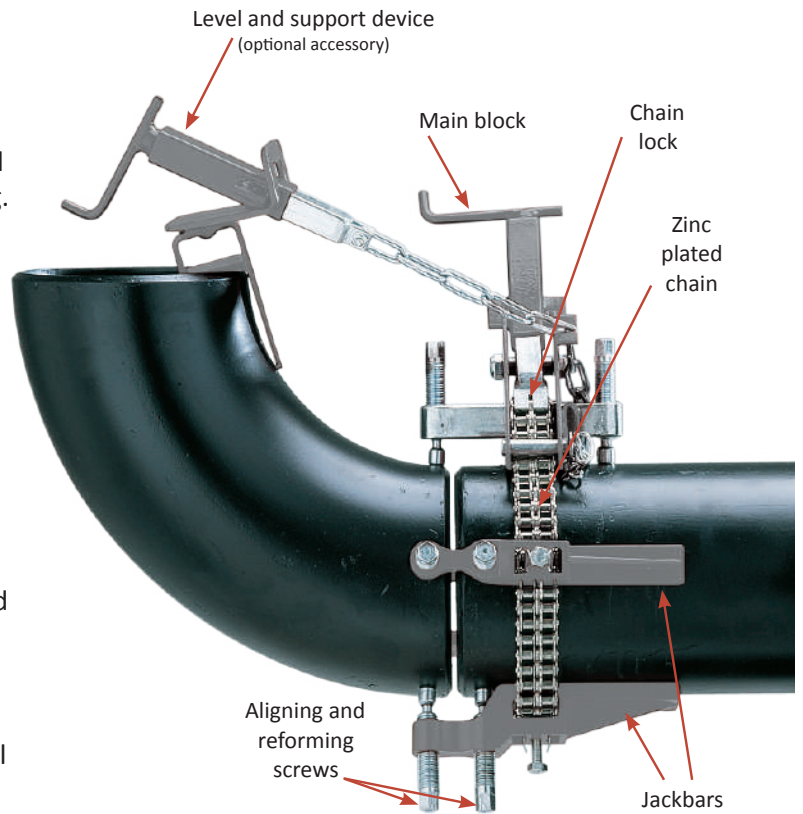

D235-SC

### Features and advantages

- **Precision alignment** - The double jackbars, spaced around the outside diameter of the pipe, provide concise alignment and reforming of the internal or external diameters of both pipes within 0.5mm
- **Reformability** - Reforms pipes on both sides of the weld joint to schedule 40 pipe and aligns any wall schedule of pipe, elbows, tees and other fittings
- **Adaptable** - The chain clamp can be used to align, and reform elbows, tees and other fittings that a cage clamp can not manage. One chain clamp covers the range of eight cage clamps
- **High rise independent jackbars** - Double jackscrew 'high rise' jackbars have extra clearance enabling easy access with welding torch/rod. Each jackscrew has independently pivoting feet to cope with uneven surfaces
- **Wide range** - One chain clamp covers a wide range of pipe sizes
- **Safe** - Elbows, tees and other fittings can be held safely and securely in place during alignment with the level and support device



## Sturdi Clamp pipe chain clamps versatility

Some examples of fit-ups with the Sturdi Clamp. Each clamp is supplied with all accessories to carry out any fit-up and includes a steel storage box.

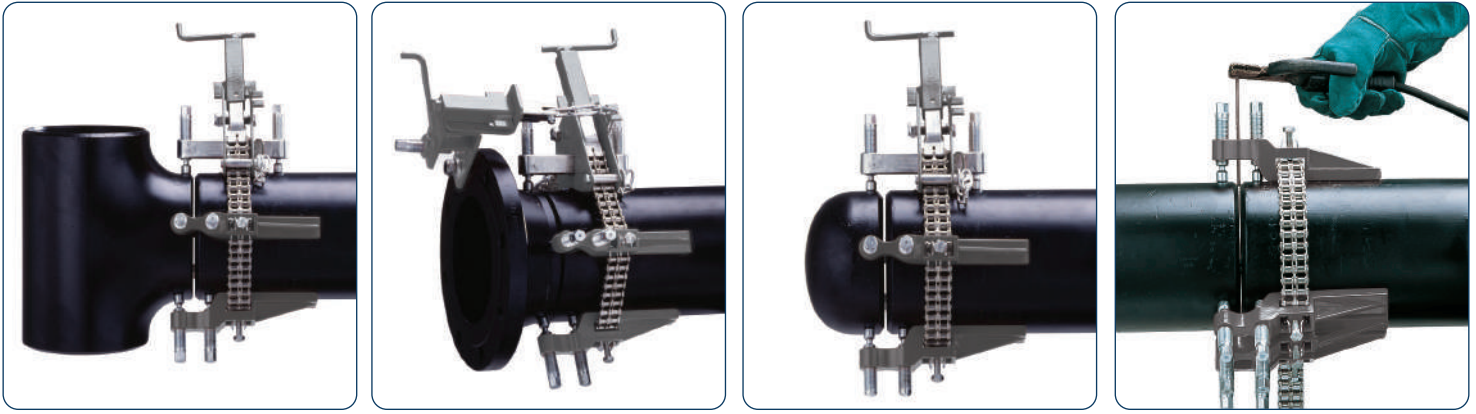

### Mathey Dearman Sturdi Clamp includes:

- Nickel plated carbon steel or stainless steel duplex roller chain
- Stainless steel single or double jackscrew jackbars - quantity as indicated in specifications
- Stainless steel main block
- Jackscrew breaker bar and socket
- Heavy duty storage box
- Parts and operating manual



#### Jackbar model



DA-600S



DB-600S

#### Main block model



DA-100



DB-100

#### Chain model



DA-300/DA-300S



DB-300/DB-300S

### Mathey Dearman Sturdi Clamp chain clamp

OLD PART NO	NEW PART NO	NO OF JACKBARS	PIPE SIZE RANGE		REFORMS/ALIGNS PIPE TO SCHEDULE*	JACKBAR MODEL	MAIN BLOCK MODEL	CHAIN MODEL
EZSCC12	D250-SC	4	1" - 12"	33.4 - 323.8 mm	40 / 80	DA-600S	DA-100	DA-300
* EZSCC12SS	* D250-SCSS	4	1" - 12"	33.4 - 323.8 mm	40 / 80	DA-600S	DA-100	DA-300S
EZSCC20	D249-SC	7	4" - 20"	114.3 - 508 mm	40 / 80	DA-600S	DA-100	DA-300
* EZSCC20SS	* D249-SCSS	7	4" - 20"	114.3 - 508 mm	40 / 80	DA-600S	DA-100	DA-300S
EZSCC36	D235-SC	8	10" - 36"	273 - 914 mm	40 / 80	DB-600S	DB-100	DB-300
* EZSCC36SS	* D235-SCSS	8	10" - 36"	273 - 914 mm	40 / 80	DB-600S	DB-100	DB-300S
EZSCC54	D236-SC	13	10" - 54"	273 - 1,372 mm	40 / 80	DB-600S	DB-100	DB-300
* EZSCC54SS	* D236-SCSS	13	10" - 54"	273 - 1,372 mm	40 / 80	DB-600S	DB-100	DB-300S
EZSCC72	D237-SC	16	10" - 72"	273 - 1,827 mm	40 / 80	DB-600S	DB-100	DB-300
* EZSCC72SS	* D237-SCSS	16	10" - 72"	273 - 1,827 mm	40 / 80	DB-600S	DB-100	DB-300S

\* Suitable for stainless steel

The Sturdi Clamp does not include level and support device.

Calculations are based on pipe with a tensile strength of 45,000 lbs. per square inch (3,168 kg per square centimeter)



*Ultra heavy duty double chain reforming alignment clamp*

**Range: 10" - 240"**

The E-Z Fit Double Chain pipe clamp is an extra heavy duty clamp designed for alignment and reforming of pipes and vessels up to 20' (6M) with up to schedule 80 wall thickness. The double chain clamp will align pipes with any wall schedule.

Our specialised triple jackscrew heavy duty jackbars and double chain lock devices can deal with the most difficult of reforming jobs with operational ease.

The extra heavy duty jackbars and double main block provide the strength to accomplish reforming jobs on pipe wall thicknesses that other clamps simply cannot. Models 10" - 36" to 10" - 54" can use level and support devices and all other models with cable hoists which can all be purchased as an accessory.

The E-Z Fit Double Chain pipe clamps are available as stainless steel models with stainless steel contact points and chain to enable the welding of exotic materials with no risk of contamination. All clamps are supplied in their own durable storage cases.

Clamps can also be supplied with an optional torque wrench to apply the correct tension to the chain (150nm). This allows the exact required tension to be applied to the chain.

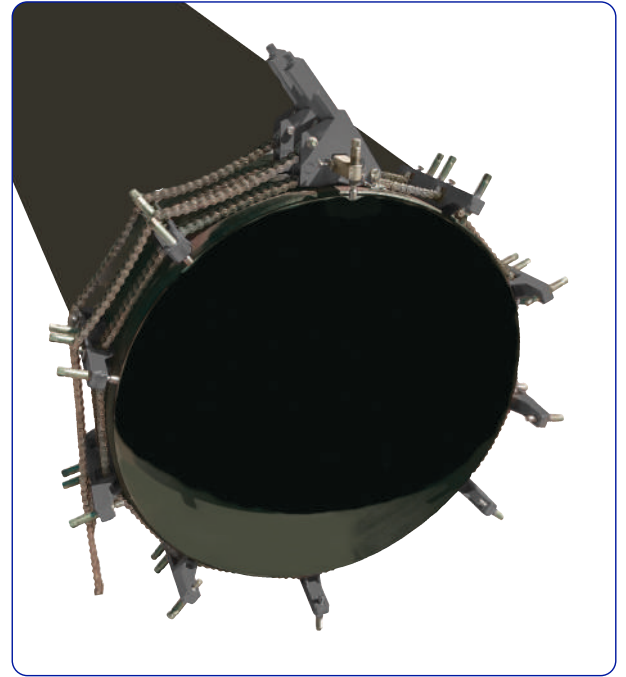

**Features and advantages:**

- **Precision alignment** - The double jackbars, spaced around the outside diameter of the pipe, provide accurate alignment and reforming of the internal or external diameters of both pipes within 0.5 mm
- **Extremely tough** - Reforms pipes on both sides of the weld joint to schedule 80, aligns all wall schedules, elbows, tees and other fittings
- **Adaptable** - The chain clamp can be used to align, and reform elbow, tees and other fittings that a cage clamp cannot cope with. One chain clamp covers the range of up to 100 cage clamps
- **Extra heavy duty independent jackbars** - Enable the operator to form the pipe to the required shape. Each jackbar has three (3) independently pivoting Jackscrews to cope with uneven surfaces
- **Versatile** - Elbows, tees and other fittings can be aligned with the level and support device

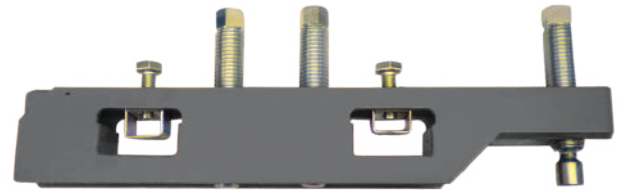

Heavy duty jackbars for arduous aligning and reforming jobs

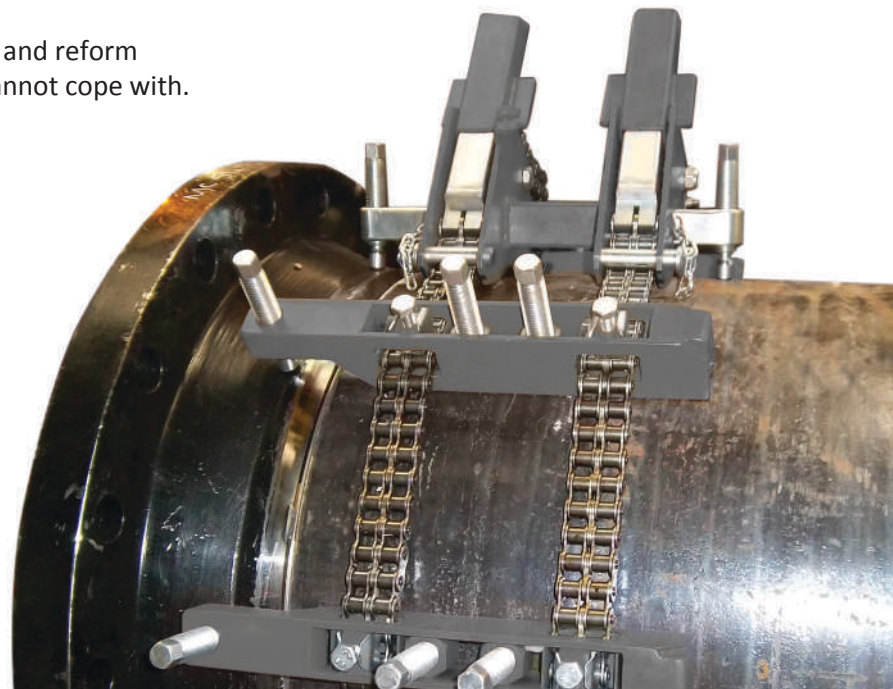

### E-Z Fit Double chain clamp includes:

- Length of chain required for the pipe range
- Extra heavy duty jackbars listed for the pipe range
- Number of main blocks listed for the pipe range
- Two fine adjustments
- Level and support device (larger clamps supplied with cable hoist)
- Jackscrew wrench
- Operating instructions

### Optional:

- Torque wrench
- Carbon or stainless steel spacing screws
- Additional jackbars and jackscrews
- Additional chain

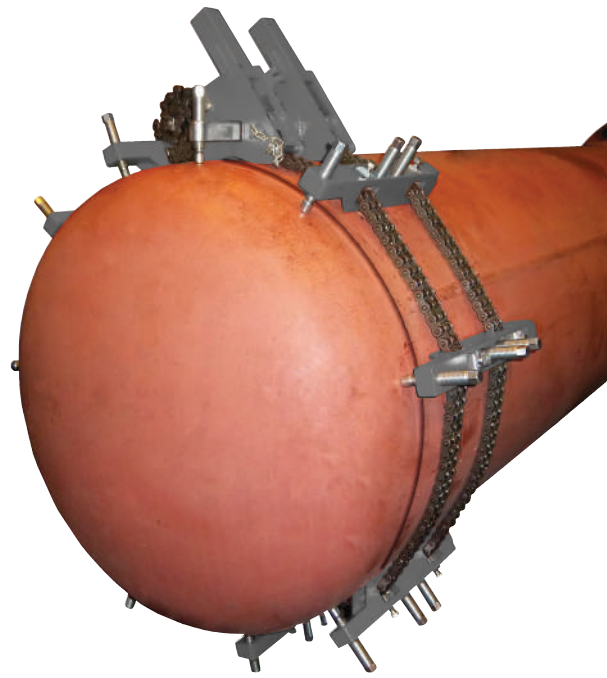

### Sizes available

PART NO.	PIPE DIAMETER RANGE (INCH / MM)		NUMBER OF JACKBARS	NUMBER OF MAIN BLOCKS	SHIPPING WEIGHT (LBS. / KG)	
EZDCC10-36	10 - 36"	273 - 915 mm	9	1	220 lbs.	100 kg
* EZDCC10-36 SS	10 - 36"	273 - 915 mm	9	1	220 lbs.	100 kg
EZDCC10-48	10 - 48"	273 - 1,220 mm	12	1	278 lbs.	126 kg
* EZDCC10-48 SS	10 - 48"	273 - 1,220 mm	12	1	278 lbs.	126 kg
EZDCC10-54	10 - 54"	273 - 1,375 mm	14	1	300 lbs.	136 kg
* EZDCC10-54 SS	10 - 54"	273 - 1,375 mm	14	1	300 lbs.	136 kg
EZDCC10-60	10 - 60"	273 - 1,525 mm	16	1	328 lbs.	149 kg
* EZDCC10-60 SS	10 - 60"	273 - 1,525 mm	16	1	328 lbs.	149 kg
EZDCC10-72	10 - 72"	273 - 1,830 mm	20	1	387 lbs.	176 kg
* EZDCC10-72 SS	10 - 72"	273 - 1,830 mm	20	1	387 lbs.	176 kg
EZDCC10-84	10 - 84"	273 - 2,135 mm	24	2	442 lbs.	200 kg
* EZDCC10-84 SS	10 - 84"	273 - 2,135 mm	24	2	442 lbs.	200 kg
EZDCC10-96	10 - 96"	273 - 2,440 mm	28	2	498 lbs.	226 kg
* EZDCC10-96 SS	10 - 96"	273 - 2,440 mm	28	2	498 lbs.	226 kg
EZDCC10-108	10 - 108"	273 - 2,745 mm	32	2	554 lbs.	251 kg
* EZDCC10-108 SS	10 - 108"	273 - 2,745 mm	32	2	554 lbs.	251 kg
EZDCC10-120	10 - 120"	273 - 3,050 mm	36	2	610 lbs.	277 kg
* EZDCC10-120 SS	10 - 120"	273 - 3,050 mm	36	2	610 lbs.	277 kg
EZDCC10-132	10 - 132"	273 - 3,355 mm	39	2	660 lbs.	299 kg
* EZDCC10-132 SS	10 - 132"	273 - 3,355 mm	39	2	660 lbs.	299 kg
EZDCC10-144	10 - 144"	273 - 3,715 mm	42	2	710 lbs.	322 kg
* EZDCC10-144 SS	10 - 144"	273 - 3,715 mm	42	2	710 lbs.	322 kg
EZDCC10-168	10 - 168"	273 - 4,270 mm	48	3	810 lbs.	367 kg
* EZDCC10-168 SS	10 - 168"	273 - 4,270 mm	48	3	810 lbs.	367 kg
EZDCC10-192	10 - 192"	273 - 4,880 mm	54	3	910 lbs.	410 kg
* EZDCC10-192 SS	10 - 192"	273 - 4,880 mm	54	3	910 lbs.	410 kg
EZDCC10-216	10 - 216"	273 - 5,490 mm	60	3	1,010 lbs.	455 kg
* EZDCC10-216 SS	10 - 216"	273 - 5,490 mm	60	3	1,010 lbs.	455 kg
EZDCC10-240	10 - 240"	273 - 6,100 mm	66	3	1,110 lbs.	500 kg
* EZDCC10-240 SS	10 - 240"	273 - 6,100 mm	66	3	1,110 lbs.	500 kg

\* Suitable for stainless steel

Larger sizes available upon request





## Rim Clamp

The Mathey Dearman Rim Clamp is built for tough reforming jobs and is ideal for applications requiring 100% weld and grind without releasing clamping pressure. Symmetrically placed jackscrews apply pressure on high points to precisely reform and align pipe or shells. All surfaces of the Rim Clamp in contact with the pipe are made of stainless steel enabling the clamp to be used on a variety of materials.

The Mathey Dearman Rim Clamp will reform 45,000 PSI tensile strength pipe up to schedule 80, with out-of-round conditions up to 2" (51 mm), depending on wall thickness.

- Accurate** - Apply reforming pressure exactly where required
- Strong** - Corrects out-of-round conditions up to 2" (51 mm)
- Easy** - Self-latching design, 14" (356 mm) and larger, makes installation simple and safe
- Versatile** - Handles a range of pipe sizes and materials

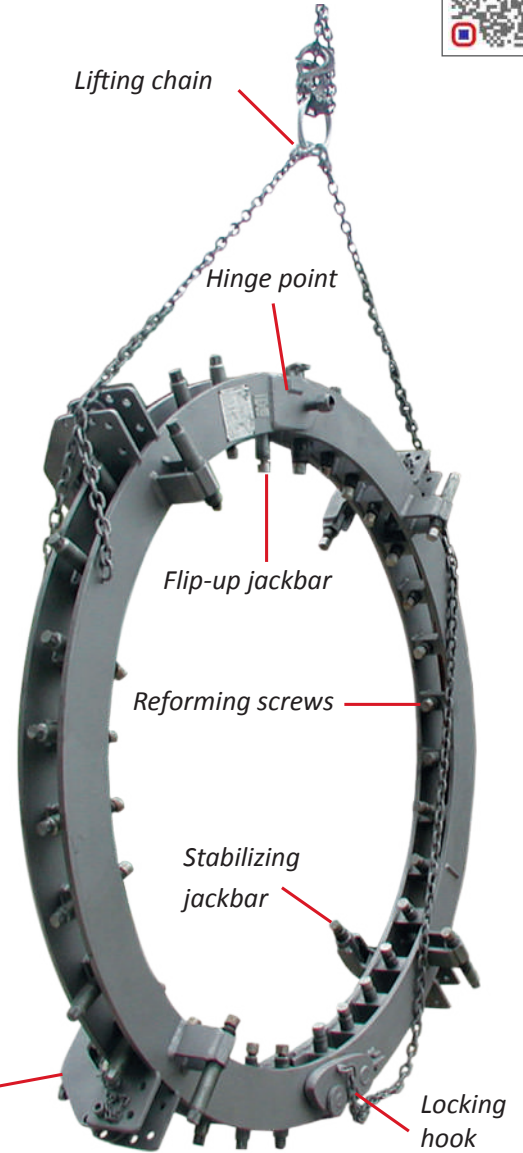



PART NO	DESCRIPTION	PIPE SIZE RANGE		ESTIMATED SHIPPING WEIGHT	
D711-0406	Standard Rim Clamp 4" - 6"	4" - 6"	114.3 - 168.2 mm	118 lbs.	54 kg
D711-0608	Standard Rim Clamp 6" - 8"	6" - 8"	168.2 - 219 mm	122 lbs.	55 kg
D711-0810	Standard Rim Clamp 8" - 10"	8" - 10"	219 - 273 mm	145 lbs.	66 kg
D711-1012	Standard Rim Clamp 10" - 12"	10" - 12"	273 - 323.8 mm	168 lbs.	76 kg
D711-1214	Standard Rim Clamp 12" - 14"	12" - 14"	323.8 - 356 mm	225 lbs.	102 kg
D711-1420M	Mega Rim Clamp 14" - 20"	14" - 20"	356 - 508 mm	586 lbs.	266 kg
D711-1824M	Mega Rim Clamp 18" - 24"	18" - 24"	457 - 610 mm	603 lbs.	273 kg
D711-2632M	Mega Rim Clamp 26" - 32"	26" - 32"	660 - 813 mm	860 lbs.	390 kg
D711-3036M	Mega Rim Clamp 30" - 36"	30" - 36"	762 - 914 mm	974 lbs.	442 kg
D711-3844M	Mega Rim Clamp 38" - 44"	38" - 44"	965 - 1,118 mm	1,112 lbs.	504 kg
D711-4248M	Mega Rim Clamp 42" - 48"	42" - 48"	1,067 - 1,219 mm	1,176 lbs.	533 kg
D711-4652M	Mega Rim Clamp 46" - 52"	46" - 52"	1,168 - 1,321 mm	1,200 lbs.	544 kg
D711-5056M	Mega Rim Clamp 50" - 56"	50" - 56"	1,270 - 1,422 mm	1,280 lbs.	581 kg
D711-5460M	Mega Rim Clamp 54" - 60"	54" - 60"	1,372 - 1,524 mm	1,322 lbs.	600 kg

*Additional sizes available upon request*

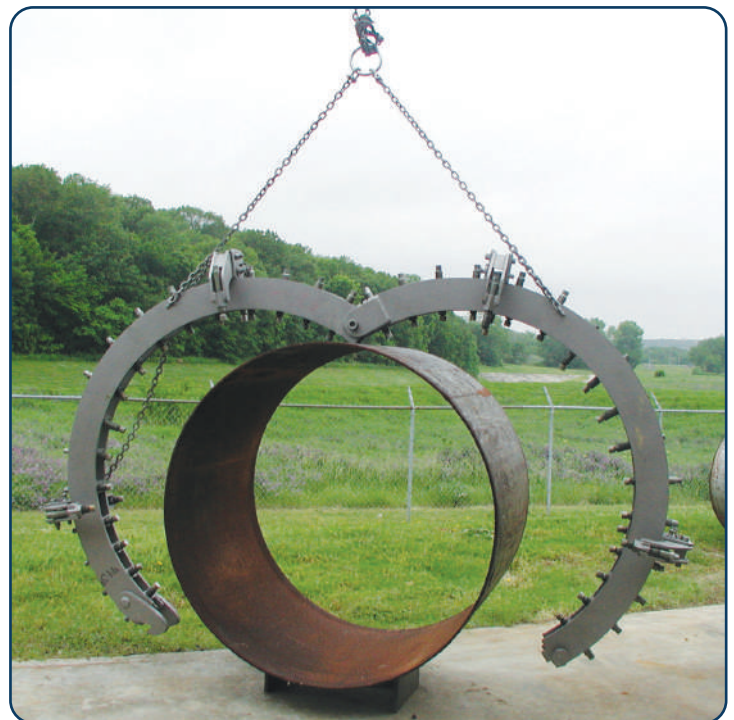



## Cage clamps

Mathey Dearman's cage clamp is available in manual hand lever, ratchet, and hydraulic models in either tack or no-tack versions, ranging in sizes for pipes 2" to 60" (60.3 mm to 1,524 mm). The cage clamps will align pipe through schedule 80. Cage clamps are intended for alignment use only and are not designed to reform pipe. Each size clamp fits one specific pipe diameter. If the O.D. of the pipe varies more than  $\pm \frac{3}{16}$ " (5 mm) from the indicated clamp diameter, pipes may not align accurately.

## Manual Lever cage clamp

MANUAL LEVER TACK MODEL	PIPE SIZE	
01.0505.001	2"	60.3 mm
01.0505.002	3"	88.9 mm
01.0505.003	3.5"	101.6 mm
01.0505.004	4"	114.3 mm
01.0505.005	5"	141.3 mm
01.0505.006	6"	168.2 mm
01.0505.008	8"	219 mm
01.0505.010	10"	273 mm
01.0505.012	12"	323.8 mm
01.0505.014	14"	356 mm
01.0505.016	16"	406 mm
01.0505.018	18"	457 mm
01.0505.020	20"	508 mm
01.0505.022	22"	559 mm
01.0505.024	24"	610 mm
01.0505.026	26"	660 mm
01.0505.028	28"	711 mm
01.0505.030	30"	762 mm
01.0505.032	32"	813 mm
01.0505.034	34"	864 mm
01.0505.036	36"	914 mm
01.0505.038	38"	965 mm
01.0505.040	40"	1,016 mm
01.0505.042	42"	1,067 mm
01.0505.048	48"	1,219 mm
01.0505.054	54"	1,372 mm
01.0505.060	60"	1,524 mm



### Available upon request



No-tack cross bars are arched to permit a full-circle weld without removing the clamp. The no-tack clamp can help increase welding quality and efficiency.

Clamps with stainless steel contact points or for odd-size pipe available on request. Add SS at end of part number for stainless steel.

## Cage clamp cross bar designs



Tack-type straight cross bars have flared ends so pipes can be moved easily into position and clamped. After the pipe is tack welded, the clamp is removed from the pipe and the weld is completed.



Tack and no-tack cross bars are available in stainless steel for stainless and other specialty alloy applications.



# RATCHET AND HYDRAULIC CAGE CLAMPS



RATCHET

HYDRAULIC

## Ratchet cage clamp

The ratchet closure system of the Mathey Dearman Ratchet cage clamp provides the extra force needed to align large pipe diameters. The Ratchet cage clamp is available for 14" to 60" (356 mm to 1,524 mm) pipe.



Ratchet must be ordered separately

## Hydraulic cage clamp

Mathey Dearman's Hydraulic cage clamp utilizes a rugged hydraulic closure mechanism to create the extra force necessary to align large pipe diameters while also permitting the rapid release of the clamp from the pipe. The Hydraulic cage clamp is available for 16" to 60" (406 mm to 1,524 mm) pipe.



12 ton - Hydraulic jack included

RATCHET TACK MODEL	HYDRAULIC TACK MODEL	PIPE SIZE	
01.0505.R06	n/a	6"	168.2 mm
01.0505.R08	n/a	8"	219 mm
01.0505.R10	n/a	10"	273 mm
01.0505.R12	n/a	12"	323.8 mm
01.0505.R14	n/a	14"	356 mm
01.0505.R16	01.0505.H16	16"	406 mm
01.0505.R18	01.0505.H18	18"	457 mm
01.0505.R20	01.0505.H20	20"	508 mm
01.0505.R22	01.0505.H22	22"	559 mm
01.0505.R24	01.0505.H24	24"	610 mm
01.0505.R26	01.0505.H26	26"	660 mm
01.0505.R28	01.0505.H28	28"	711 mm
01.0505.R30	01.0505.H30	30"	762 mm
01.0505.R32	01.0505.H32	32"	812 mm
01.0505.R34	01.0505.H34	34"	864 mm
01.0505.R36	01.0505.H36	36"	914 mm
01.0505.R38	01.0505.H38	38"	965 mm
01.0505.R40	01.0505.H40	40"	1,016 mm
01.0505.R42	01.0505.H42	42"	1,067 mm
01.0505.R48	01.0505.H48	48"	1,219 mm
n/a	01.0505.H54	54"	1,372 mm
n/a	01.0505.H60	60"	1,524 mm

### Available upon request



No-tack cross bars are arched to permit a full-circle weld without removing the clamp. The no-tack clamp can help increase welding quality and efficiency.

## Cage clamp cross bar designs



Tack-type straight cross bars have flared ends so pipes can be moved easily into position and clamped. After the pipe is tack welded, the clamp is removed from the pipe and the weld is completed.



Tack and no-tack cross bars are available in stainless steel for stainless and other specialty alloy applications.







- One clamp works on multiple pipe sizes
- Able to do light reforming to correct ovality in the pipe
- Able to push or pull the pipe joint together to attain the proper gap
- Works on carbon steels, stainless steels, and alloys
- Clamp can work on multiple types of joints
- Splitframe rim style clamp with turnbuckles, solid steel frames

**All super clamps include:**

- Parts and operating manual
- Jackscrews with swivel pads
- Jackscrew breaker bar and socket



**Align, Reform AND SET THE WELD GAP with a few turns of a wrench**



MATHEY DEARMAN SUPER CLAMP - HD

MODEL PART NO.	REFORMS TO SCHEDULE	ALIGNS TO SCHEDULE	PIPE SIZE RANGE
SC-RC-0612HD	40	80	6" - 12" / 168.2 - 323.8 mm
SC-RC-1218HD	40	80	12" - 18" / 323.8 - 457 mm
SC-RC-1824HD	40	80	18" - 24" / 457 - 610 mm
SC-RC-2430HD	40	80	24" - 30" / 610 - 762 mm
SC-RC-3036HD	40	80	30" - 36" / 762 - 914 mm

**Super Clamp reforming abilities**

SUPERCLAMP	PIPE OD	FOR MAX 1/16" OUT OF ROUND CONDITION					FOR MAX 1/8" OUT OF ROUND CONDITION				
		SCHEDULE					SCHEDULE				
		10	20	30	40	STD	10	20	30	40	STD
SC-RC-0612	6	---	---	---	---	---	---	---	---	---	---
SC-RC-0612	8	x	---	---	---	---	---	---	---	---	---
SC-RC-0612	10	x	x	---	---	---	---	---	---	---	---
SC-RC-0612	12	x	x	x	x	x	x	---	---	---	---
SC-RC-1218	12	x	x	---	---	---	---	---	---	---	---
SC-RC-1218	14	x	x	x	---	x	---	---	---	---	---
SC-RC-1218	16	x	x	x	---	x	x	---	---	---	---
SC-RC-1218	18	x	x	x	x	x	x	x	---	---	---
SC-RC-1824	18	x	x	x	---	x	---	---	---	---	---
SC-RC-1824	20	x	x	x	---	x	x	---	---	---	---
SC-RC-1824	22	x	x	x	---	x	x	---	---	---	---
SC-RC-1824	24	x	x	x	x	x	x	x	---	---	x
SC-RC-2430	24	x	x	x	---	x	x	---	---	---	---
SC-RC-2430	26	x	x	---	---	x	x	---	---	---	x
SC-RC-2430	28	x	x	x	---	x	x	---	---	---	x
SC-RC-2430	30	x	x	x	---	x	x	x	---	---	x
SC-RC-3036	30	x	x	x	---	x	x	---	---	---	x
SC-RC-3036	32	x	x	x	x	x	x	---	---	---	x
SC-RC-3036	34	x	x	x	x	x	x	x	---	---	x
SC-RC-3036	36	x	x	x	x	x	x	x	---	---	x



The Mathey Dearman Hydraulic Sleeve clamp is built to handle welded sleeves up to ¾" thick and up to 70,000 PSI tensile strength.

Unlike the common and unsafe application of a bottle jack and chain, this purpose-built clamp provides virtually 360 degrees of clamping force for perfect fit-ups.

The easy to operate hydraulic closure system makes set up and removal easy and quick.

***Why risk the chance for flying jacks and falling sleeves when finally, there's a better solution?***

All models feature a 2-speed hydraulic hand pump for quicker installation and high-strength modular design for safer handling.

There are 4 models of clamps for any specific need and application - 5,000 PSI or 10,000 PSI of clamping pressure and 6" to 24" or 6" to 48" range for sleeves up to ¾" (19mm) thick.

All clamps include a rugged steel transportation and storage box.



- Safe** - No unstable bottle jacks to suddenly slip and disengage
- Precise** - Equal clamping force provides better fit-up
- Easy to Handle** - Engineered to be installed by one person
- Adaptable** - Fits a wide range of pipe sizes and sleeve thicknesses
- Durable** - Rugged corrosion-resistant construction for years of use

**UNSAFE**



**SAFE**



**Mathey Dearman Hydraulic Sleeve clamp includes:**

- Nickel plated carbon steel duplex roller chain (DB models) or nickel plated carbon steel leaf chain (DC models) for pipe size range
- High strength stainless steel main block with hydraulic cylinder
- 2-Speed hand operated hydraulic pump
- Heavy duty transportation and storage box
- Parts and operating manual

**Mathey Dearman Hydraulic Sleeve clamp**

PART NO	PIPE SIZE RANGE		CLAMPING PRESSURE	CHAIN	WEIGHT - SLEEVE CLAMP ONLY		SHIPPING WEIGHT	
DB-724	6" - 24"	168.2 - 610 mm	5,000 p.s.i.	DB-300	31 lbs.	14 kg	76 lbs.	34 kg
DB-748	6" - 48"	168.2 - 1,219 mm	5,000 p.s.i.	DB-300	48 lbs.	22 kg	93 lbs.	42 kg
DC-724	6" - 24"	168.2 - 610 mm	10,000 p.s.i.	DC-300	50 lbs.	23 kg	94 lbs.	43 kg
DC-748	6" - 48"	168.2 - 1,219 mm	10,000 p.s.i.	DC-300	81 lbs.	37 kg	125 lbs.	57 kg



## PIPE RIGGING EQUIPMENT







Mathey Dearman's Pipe Cradles and Slings are an effective way to move pipe, specifically designed for pipeline installation projects. Mathey Dearman currently offers cradles from 2" - 36" and all are equipped with 4 inch urethane "round cut" wheels with sealed anti-friction bearings. All spreader bar designs are third party tested and comply with industry standards. These models are equipped with 5/8" wire rope and all rope is swaged and certified.

### Features and advantages

- Durable 95a urethane coating designed for multiple uses
- Sealed anti-friction bearings
- Measures 4" tread width x 4.5" diameter
- 5/8" wire rope, swaged
- Machined hub for smooth wheel rotation



2001

2002

2003

2004

Sealed bearing wheels with protective metal end flange. Great urethane replacement roller for most other brands. 4" x 6" with radius cutout for pipe shape and designed for 5/8" wire rope.

4" Roller  
PN 90024



ITEM NUMBER	DESCRIPTION	LOAD CAPACITY
2001-3	Roller Sling 2" - 8"	1,300 kg / 3,000 lbs.
2001-4	Roller Sling 2" - 12"	1,300 kg / 3,000 lbs.
2001-5	Roller Sling 2" - 18"	1,300 kg / 3,000 lbs.
2001-7	Roller Sling 2" - 24"	1,300 kg / 3,000 lbs.
2002	2 Strand Roller Cradle 6" - 12"	7,710 kg / 17,000 lbs.
2003	2 Strand Roller Cradle 12" - 24"	7,710 kg / 17,000 lbs.
2004	4 Strand Roller Cradle 12" - 24"	12,700 kg / 28,000 lbs.
2005	2 Strand Roller Cradle 24" - 36"	12,813 kg / 28,250 lbs.
2006	4 Strand Roller Cradle 24" - 36"	25,700 kg / 56,500 lbs.



Mathey Dearman's Pipe Launchers have fully compatible parts that can change from a pipe rack clamping roller to a pipeline launcher in just a few minutes.

The unique clamping system fastens the roller to an I-beam from both sides of the flange.

This option is great for installing and fabricating pipe in pipe racks or other tight and enclosed areas.

Also, the roller mechanism can be attached to a stand better suited for pipeline work and/or directional drilling.



PN 2115 - 2" - 24" - 2,500 lbs.



PN 2115 HD - 2" - 24" - 7,500 lbs.



PN 2126 - 4" - 48" - 10,000 lbs.



PN 2126 HD - 4" - 48" - 20,000 lbs.



PN 2136 - 16" - 60" - 10,000 lbs.

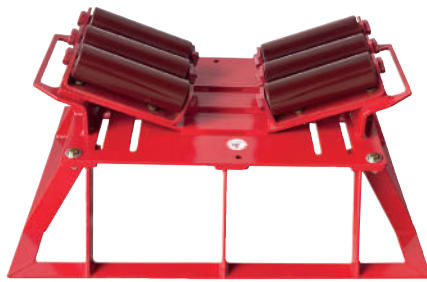

PN 2136 HD - 16" - 60" - 20,000 lbs.

### Specifications

- Replaceable urethane roller wheels unbolt in seconds.
- Convenient and safe carry handles.
- Converts from pipe launcher to beam roller.
- Pipe Launchers nest and stack efficiently for shipping and storage.
- Easy part replacement with modular design.
- Add wheels to convert standard capacity to heavy-duty capacity.
- From 2" - 60" pipe capacity.
- Up to 20,000 lbs. weight capacity.

PART NO.	DESCRIPTION	PIPE CAPACITY	WEIGHT CAPACITY	SHIPPING WEIGHT	DIMENSIONS L X W X H1 - H2
2115	Pipe Launcher (Two Rollers)	2" - 24"	2,500 lbs.	89 lbs.	23" x 26" x 16" - 18"
2115HD	Pipe Launcher HD (Six Rollers)	2" - 24"	7,500 lbs.	125 lbs.	23" x 26" x 16" - 18"
2126	Pipe Launcher (Two Rollers)	4" - 48"	10,000 lbs.	162 lbs.	30" x 36" x 16" - 19"
2126HD	Pipe Launcher HD (Six Rollers)	4" - 48"	20,000 lbs.	213 lbs.	30" x 36" x 16" - 19"
2136	Pipe Launcher (Two Rollers)	16" - 60"	10,000 lbs.	178 lbs.	30" x 36" x 16" - 19"
2136HD	Pipe Launcher HD (Six Rollers)	16" - 60"	20,000 lbs.	229 lbs.	30" x 36" x 16" - 19"



Mathey Dearman's Beam Clamp Rollers are used for a variety of industries and applications, typically for installation of pipes into racks at Refineries, Power Stations and other Industrial Plants.

All the Mathey Dearman Beam Clamp Rollers are designed to be light weight, with I-beam clamps for quick installation and various roller head options so that all sizes and weights of pipe can be easily, safely and efficiently installed.

### Features and advantages

- Six configurations from 1 - 10 tons capacity
- Three sizes for 2" - 60" pipe diameters
- Urethane wheels with sealed bearings
- Easy to replace wheels, bolt off and on in seconds
- Comes ready to use on Stainless Steel
- Convenient and safe carry handles on all models
- Safety leash included with all models



PART NO.	2110	2110HD	2125	2125HD	2135	2135HD
Load Capacity	1 Ton 1,016 kg 2,240 lbs.	3 Tons 3,048 kg 6,720 lbs.	5 Tons 5,080 kg 11,200 lbs.	10 Tons 10,160 kg 22,400 lbs.	5 Tons 5,080 kg 11,200 lbs.	10 Tons 10,160 kg 22,400 lbs.
Pipe Diameter Range	2" - 24" 60.3 - 610 mm	2" - 24" 60.3 - 610 mm	4" - 48" 114.3 - 1,220 mm	4" - 48" 114.3 - 1,220 mm	16" - 60" 400 - 1,530 mm	16" - 60" 400 - 1,530 mm
Complete Unit Weight	27 kg 59 lbs.	43 kg 95 lbs.	59 kg 130 lbs.	82 kg 180 lbs.	66 kg 145 lbs.	91 kg 200 lbs.
Footprint L x W x H	16.5" x 20.5" x 8" 41.9 x 52 x 20.3 cm	16.5" x 20.5" x 8" 41.9 x 52 x 20.3 cm	19" x 30" x 8.75" 48.3 x 76.2 x 22.2 cm	19" x 30" x 8.75" 48.3 x 76.2 x 22.2 cm	21" x 34" x 8.75" 53.3 x 86.4 x 22.2 cm	21" x 34" x 8.75" 53.3 x 86.4 x 22.2 cm
Beam Flange Width Range	6" - 12" 150 x 300 mm	6" - 12" 150 x 300 mm	6" - 12" 150 x 300 mm	6" - 12" 150 x 300 mm	6" - 12" 150 x 300 mm	6" - 12" 150 x 300 mm

Roller Maintains at Center of I Beam

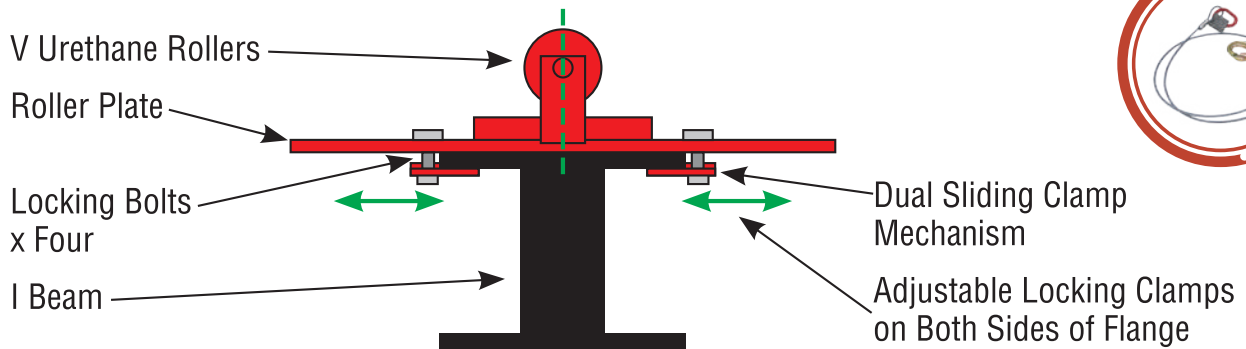



# NOTES

A series of horizontal dotted lines for taking notes.



### Customer service

We work extremely hard supporting and training our team of employees and network of partners and distributors to ensure that from The S.F.E. Group you always receive the:

- Fastest response times
- Quickest delivery times
- Most knowledgeable and accurate advice
- Committed after sales support



### Level of stock

S.F.E. Group carry an unrivalled stock level, meaning no matter how large your order we expect to offer you the fastest delivery time available worldwide.

### Price

You will find our pricing to be very competitive. Give us an opportunity to quote your next project and we are confident you will be pleased! For your convenience we offer our products in the three major currencies: US Dollar, Euro and GB Pound.



### Research and development

Technology is always improving. At S.F.E. Group we firmly intend to move with the times and to be the innovators in our industry with a dedicated team of designers and technicians devoted to improving our existing products as well as innovating the next generation of pipework machinery and tools. All user feedback is passed onto the R&D department to ensure our machines are developed to meet all end user needs. We often hold meetings with customers to ensure the package provided meets all their requirements including custom made machines.



### Production, assembly and quality control

S.F.E. Group is proud to offer the highest quality of components manufactured wholly in Europe/USA. All our machines are assembled in our facilities and undergo vigorous testing and quality control, which is backed by our products being CE Certified, having Certificates of Conformity, Certificates of Origin and our company being ISO9001 accredited.



### Demonstrations, training and exhibitions

We love to show off our products unrivalled performance and are always happy to carry out demonstrations either in our showroom facilities or at your site. In addition we understand the importance of the correct operation of our machinery and tools, so also offer training packages in our training facilities or at your site ensuring safe, efficient and accurate operation. We also participate in all the relevant world wide exhibitions. We also have extremely detailed user manuals and instructional videos.



### Rental division

The S.F.E. Group operates a full, worldwide hire and rental service in cooperation with and supported by its selected and specialized rental partners. S.F.E. Group continuously keeps expanding its rental activities, rental fleet and network and prides itself keeping its renting equipment up to date in order to provide the best possible quality, performance and reliability. S.F.E. Group invites you to share your rental enquiry and will tailor the matching solution to your needs.

**Please contact your local S.F.E. Group branch for all enquiries.  
Details of which can be found on the back cover of this publication.**



SPECIALIZED FABRICATION EQUIPMENT GROUP

# Global Locations:



**S.F.E. GROUP HEAD OFFICE - USA**  
**SPECIALIZED FABRICATION EQUIPMENT GROUP**  
 4433 South Drive,  
 Houston,  
 Texas 77053, USA  
 Tel: +1 713 747 8502  
 E-mail: sales@sfe-brands.com

**S.F.E. GROUP HEAD OFFICE - FRANCE**  
**SPECIALIZED FABRICATION EQUIPMENT GROUP**  
 330B Route de Portes Les Valence,  
 ZI les Bosses,  
 26800 Etoile-sur-Rhône, France  
 Tel: + 33 (0) 475 575 070  
 E-mail: sales-int@sfe-brands.com

**SFE UNITED KINGDOM**  
**SPECIALIZED FABRICATION EQUIPMENT GROUP**  
 Unit 15 & 16 Grendon Industrial Estate,  
 Grendon Underwood, Aylesbury,  
 Buckinghamshire, HP18 0QX England  
 Tel: +44 (0)1869 324 144  
 E-mail: sales-uk@sfe-brands.com

**SFE GERMANY**  
**SPECIALIZED FABRICATION EQUIPMENT GROUP**  
 Ostmarkstrasse 15,  
 76437 Rastatt,  
 Germany  
 Tel: +49 (0)7222 9355100  
 E-mail: sales-germany@sfe-brands.com

**SFE KINGDOM OF SAUDI ARABIA**  
**SPECIALIZED FABRICATION EQUIPMENT GROUP**  
 Warehouse No: EM16-10, Air Base Determinant,  
 Industrial supply scheme, Ash Shulah, Dammam  
 34264, Saudi Arabia  
 Tel: + 966 50 515 8196  
 E-mail: sales-ksa@sfe-brands.com

**SFE MIDDLE EAST**  
**SPECIALIZED FABRICATION EQUIPMENT GROUP**  
 Shams Freezone  
 Sharjah  
 United Arab Emirates  
 Tel: +971 (0)50 217 1376  
 E-mail: sales-me@sfe-brands.com

**SFE INDIA**  
**SPECIALIZED FABRICATION EQUIPMENT GROUP**  
 Plot No. PAP 3, D 3 Block,  
 Chinchwad, Pune 411 019  
 Mob: +91 90 1102 4332  
 Mob: +91 95 5258 4361  
 E-mail: sales-india@sfe-brands.com

**SFE LATIN AMERICA**  
**SPECIALIZED FABRICATION EQUIPMENT GROUP**  
 4433 South Drive,  
 Houston,  
 Texas 77053, USA  
 Tel: +1 713 747 8502  
 E-mail: sales-latam@sfe-brands.com

**SFE SOUTH KOREA**  
**SPECIALIZED FABRICATION EQUIPMENT GROUP**  
 102 - 1301 Bucheon Technopark III  
 421 - 742 Gyeonggi-do-seoul, Taehan-min'guk  
 South Korea  
 Tel: +82 32 624 2870  
 E-mail: sales-asia@sfe-brands.com

**SFE VIETNAM**  
**SPECIALIZED FABRICATION EQUIPMENT GROUP**  
 P1.2.13 Sky-Linked Villa, Diamond Alnata,  
 Celadoncity, 89 Đường N1, P. Sơn Kỳ,  
 Q. Tân Phú, TpHCM.  
 Tel: +84 91 951 70 18  
 E-mail: sales-vietnam@sfe-brands.com

**SFE CHINA**  
**SPECIALIZED FABRICATION EQUIPMENT GROUP**  
 1208, 12F, #D 7001 Zhongchun RD  
 Minhang District  
 Shanghai, China  
 Tel: +86 215 429 1891  
 E-mail: sales-china@sfe-brands.com

Copyright © 2023 Specialized Fabrication Equipment Group, All rights reserved.

## OUR BRANDS

