



StrongHand Tools
RHINO CART
MOBILE FIXTURING STATION

Charge right through your most challenging projects!

Table + Fixture Kit

ALL-IN-ONE

Mobility & Storage

2020 CATALOG

www.Rhino-Cart.com

800.989.5244

The Rhino Cart[®] Mobile Fixturing Station is a turnkey system for fixturing and clamping in welding and fabrication. Clamp and fixture at any point on the **reversible, flat ground, nitrided (heat treated) 48" x 30"** tabletop for accuracy in all of your setups.

Be ready to handle any job with the Rhino Cart[®] package, including: the Rhino Cart[®] Welding Table + 66 pc. Fixture Kit.

Nitrided and black oxide table plate is **REVERSIBLE**. Weld spatter, rust and scratch resistant.

Quickly clamp and fixture at any point on the surface. Accurately setup stock for each new project.

2x LIFE

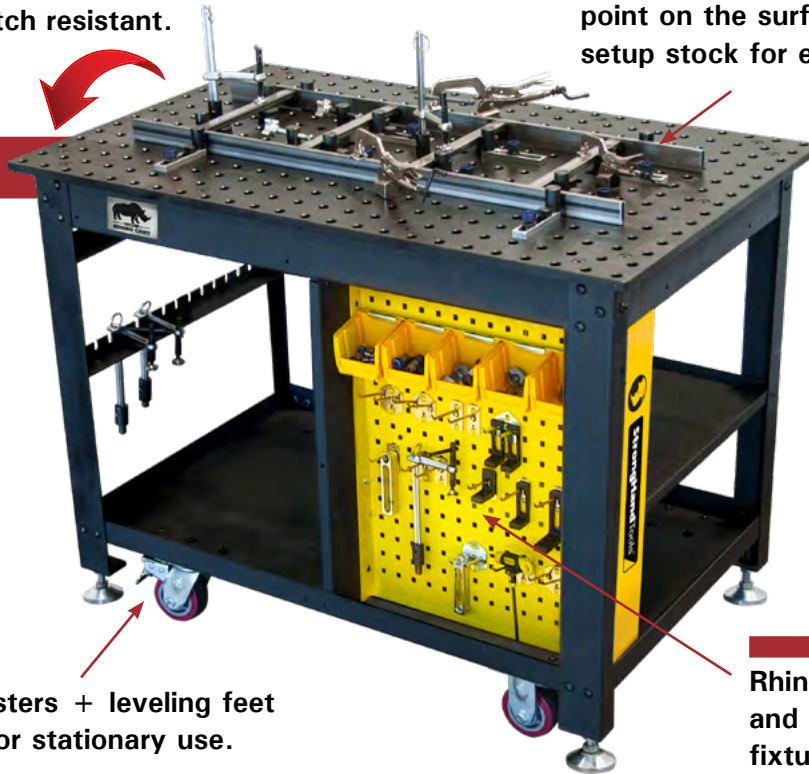
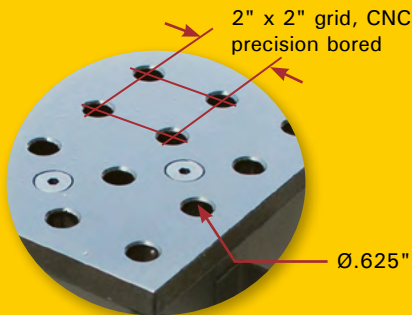

Table + Fixture Kit
ALL-IN-ONE
Mobility & Storage

Locking casters + leveling feet for mobile or stationary use.

Rhino shelves, racks, and pegboard keep your fixturing tools organized and within easy reach!

(Kit content may differ from image.)



Accurately position parts in CNC precision bored 0.625" dia. holes in 2" x 2" spacing pattern.

Tabletop Size:	48" x 30"
Tabletop Thickness:	5/8"
Tabletop Flatness:	0.012"/3 feet
Hole Diameter:	0.625"
Grid Pattern:	2" x 2"
Table Height:	36"
Static Loading Capacity:	1,500 lb

Part No.	Description	Gross Weight
TDQ54830-K1	Rhino Cart + 66 pc. Fixture Kit (TDQ54830 + TDK5100)	515 lb
TDQ54830-TT	Tabletop Only	271 lb
TDQ54830-TF	Tabletop w/ Frame	324 lb



GUIDELINES FOR MODULAR FIXTURING

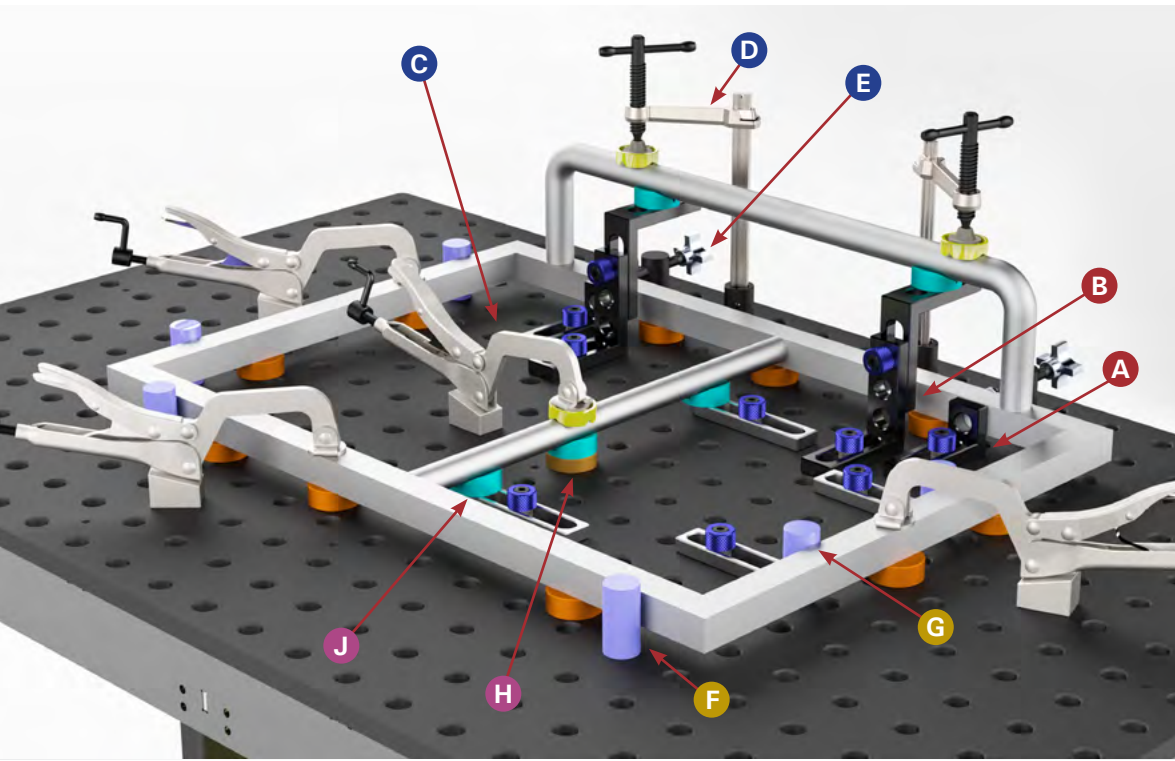

*** Ball Lock Bolts are ESSENTIAL to Modular Fixturing!**



Finger tighten to pre-load, before tightening with hex key.

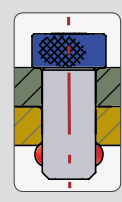

Three locking steel balls move outward to lock the bolt in position.

Stop / Locate / Elevate

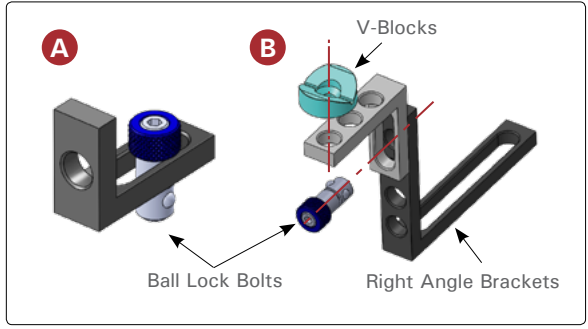

Stop and locate parts.

Stack Right Angle Brackets to elevate and hold round parts.

Clamp

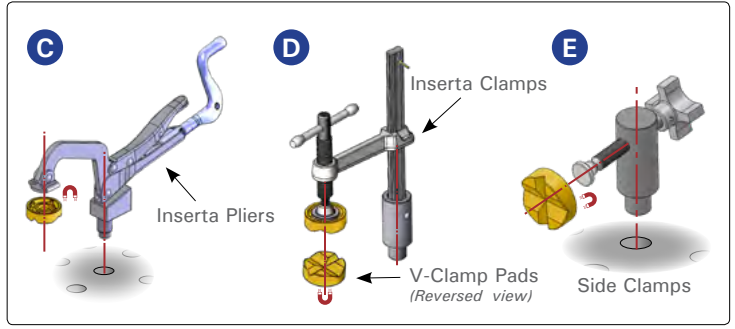

Quick hold-down clamping of flat, square, angled or round parts.

Hold, stop, or locate parts using horizontal clamping force.

Locate / Stop

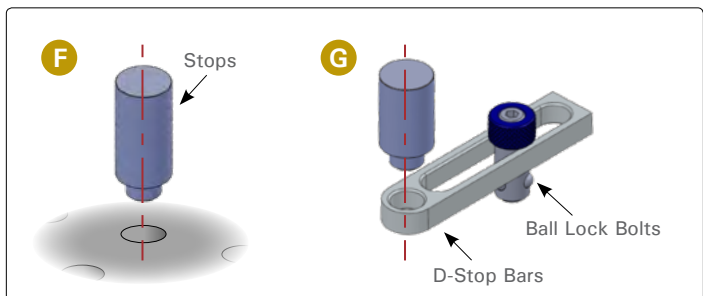

Stop, locate, and position parts.

Support Round Stock

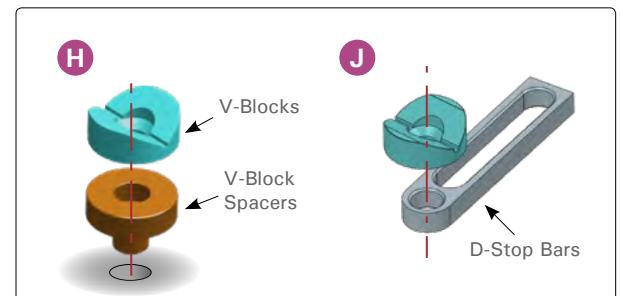

Elevate and hold round parts.

RHINO CART® PACKAGE - Mobile welding table + 66 pc. fixturing kit.

Part No: TDQ54830-K1 Total: 67 pcs Gross Weight: 515 lb



TDQ54830 x1

Welding Table, 48" x 30", 36" height, 5/8" thickness, 0.625" dia. hole, 2" x 2" grid pattern, 1,500 lb static loading capacity, long life **REVERSIBLE** tabletop | 410 lb



UDN5150 x2

Clamp

Inserta Clamp, T-Handle
6.5" opening, 3.25" reach, 0.6" x 0.3" (D Rail) | 1.2 lb

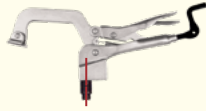

PTT522K x2

Clamp

Inserta Pliers,
2.3" opening, 2" reach
0.7 lb

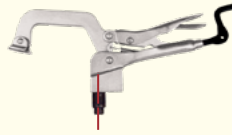

PTT634K x2

Clamp

Inserta Pliers,
4" opening, 3" reach
0.9 lb

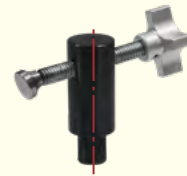

TCX5210 x2

Clamp

Side Clamp,
1.5" stroke | 0.6 lb



T54217 x2

Clamp

Magnetic V-Clamp Pad
0.05 lb

U.S. PAT.10307894



T50632-01 x8

Stop / Extend

Aluminum D-Stop Bar,
4.8" x 1" x 0.47"
0.09 lb



T50304 x2

Stop / Support

Right Angle Bracket,
1.6" x 3.6" x 1.18"
0.5 lb



T50305 x2

Stop / Support

Right Angle Bracket,
3.6" x 3.6" x 1.18"
0.7 lb



T55055 x10

Locate / Lock

Ball Lock Bolt, adjustable
range: 0.88" ~ 1.08"
0.14 lb

Connecting accessories
to tables, and accessories
to accessories.

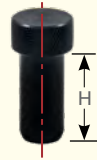

T54201 x2

Locate / Lock

Locating Pin goes into
5/8" holes, 1.3"H,
no locking | 0.2 lb



T54203 x4

Locate

Stop, Ø1" x 1.5"H
0.4 lb

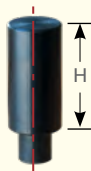

T54205 x4

Locate

Stop, Ø1" x 2"H | 0.5 lb



T50737 x12

Spacer

Magnetic Rest Button,
Ø1.5" x 0.45"H | 0.2 lb



T54216 x8

Locate / Support

V-Block, 120° angle,
Ø1.6" x 0.9" | 0.1 lb



T54211 x4

Locate / Support

V-Block Spacer,
Ø1.58" x 0.47" | 0.2 lb



OPTIONAL EXTRA KITS

Increase your clamping and fixturing capabilities, and be ready to handle new projects with these Rhino Cart® Fixturing Kits. See the full selection of BuildPro® products at: www.StrongHandTools.com.

Part No: T55056 Total: 10 pcs Gross Weight: 1.5 lb





Connecting accessories to tables, and accessories to accessories.

T55055 x10

Ball Lock Bolt, adjustable range: 0.88" ~ 1.08" | 0.14 lb

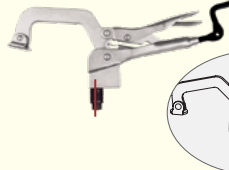
Part No: TMK500-10 Total: 6 pcs Gross Weight: 8 lb

T51670 x2

Pivoting T-Post Clamp, Max. 5" capacity | 1.8 lb

PTT934K x2

Inserta Pliers, 4" opening, 3-3/8" reach | 1.6 lb

T56010 x2

Mounting Adaptor, extended reach of Inserta Pliers | 0.4 lb
U.S. PAT. PENDING

Part No: TMK500-20 Total: 4 pcs Gross Weight: 49 lb





T50231 x1

Malleable Cast Iron Clamping Square, left angle, 2" x 6" x 12" | 6.4 lb

T50230 x1

Malleable Cast Iron Clamping Square, right angle, 2" x 6" x 12" | 6.4 lb

T50130 x2

Riser Block, 4" x 4" x 12" | 17.4 lb

Part No: TMK500-30 Total: 6 pcs Gross Weight: 13 lb





T50310 x2

Right Angle Bracket, 3.6" x 6" x 1.18" | 1 lb

T50320 x2

Right Angle Bracket, 7.6" x 6" x 1.18" | 1.3 lb

T50330 x2

Right Angle Bracket, 12" x 6" x 2" | 4.5 lb

Part No: TMK500-05 Total: 7 pcs Gross Weight: 10 lb







AGH230 x1

Magnetic Grasshopper, 35 lb pull | 1.4 lb
U.S. PAT. PENDING

MSA46-HD x2

Adjust-O Magnet, 90 lb pull | 1.5 lb
U.S. PAT. 7009480

MLD600 x2

Inside/Outside Magnet, fixed angle, 40 lb pull | 1.7 lb
U.S. PAT. 10118277

XPV830 x1

Adjustable V-Pad Magnet, 58 lb pull | 1.3 lb

MVDF42 x1

MagRest V-Pad Kit | 0.7 lb



Add a **Plasma Cutting Tray** to your Rhino Cart® Mobile Fixturing Station

PLASMA CUTTING TRAY

The Plasma Cutting Tray supports 100 lb, on a 18" x 28" cutting surface with 14 reversible / replaceable steel slats. Generous 1.8" width between cutting slats provides ample space for hold-down clamping. Slats remain secured in place when tray is folded.

Cut, clamp and fixture on one convenient mobile work station at the ideal, uniform working height.



The fold-out Plasma Cutting Tray easily folds down flat against the Rhino Cart® when not in use.

Part No.	Cutting Area	Holding Capacity	Weight
TPL3021	18" x 28"	100 lb	33 lb
TPLK3021	14 Reversible / Replaceable Slats		10 lb

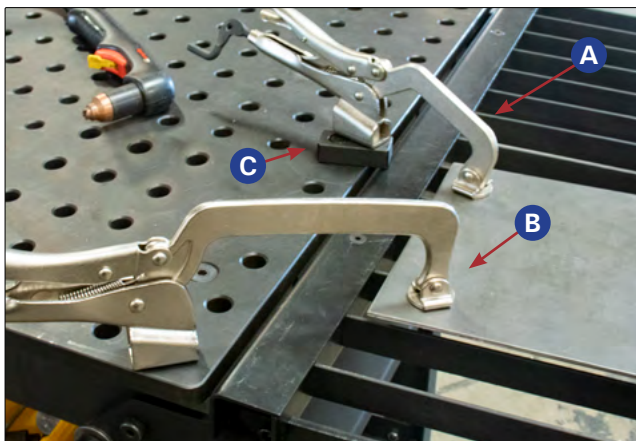

Insert the Inserta Pliers into the 5/8" holes on the Rhino Cart® Tabletop.

We recommend using BuildPro® Inserta Pliers, to clamp down workpieces on the tray.

* See product details at: www.StrongHandTools.com.

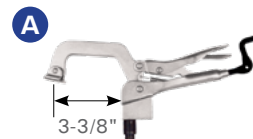

Inserta Pliers
Part No. PTT934K

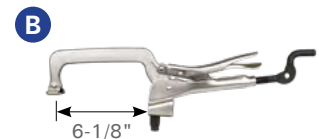

Inserta Pliers
Part No. PTT956K



Mounting Adaptor
Part No. T56010

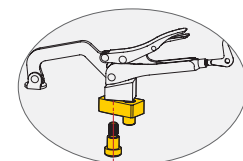

MODULAR BUILDPRO® TUBE & PIPE NOTCHER

Notch tubes and pipes at the accurate angle *and* length.

The 1st notch in a tube or pipe is easily completed with a drill press. The BuildPro® Tube & Pipe Notcher makes alignment, off-set and length control of the 2nd notch easy to complete accurately. Notch 1"– 2-1/2" OD pipes or square tubes at any angle, or off-set.

Part No.	Description	Weight
ATN100	1 pc. BuildPro® Tube & Pipe Notcher 2 pcs. Aluminum V-Blocks for tube locating 1 pc. Clamp with Magnetic V-Pad	20 lb
ATNA20	Adaptor for min cutter size: Ø3/4"	0.2 lb



NEW

The Adaptor Part No. ATNA20 (sold separately) is compatible with: the annular cutter with 3/4" mounting, minimum cutter size: Ø3/4".



Use the reference tube to control the notch angle, off-set and length.

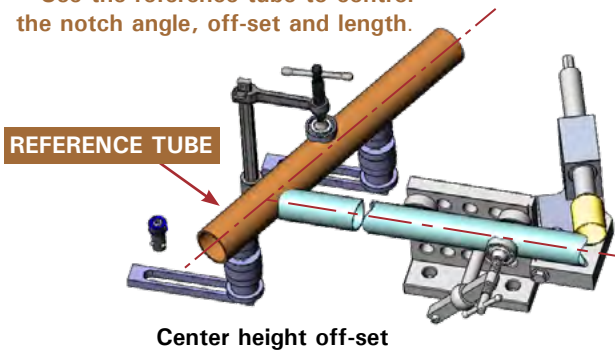

REFERENCE TUBE

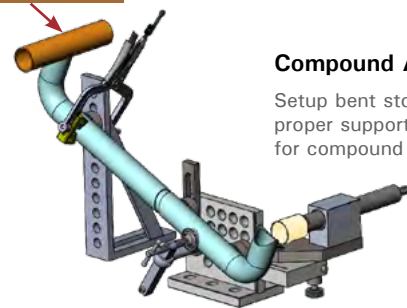

Compound Angles

Setup bent stock with the proper support and alignment for compound angle notching.

FORGED VISE

This forged steel 4" Bench Vise features a 360° swivel base, large machined anvil surface, powder coated finish. Made of 90,000 PSI tensile strength forged steel. Swivel base is patterned to bolt directly to table.

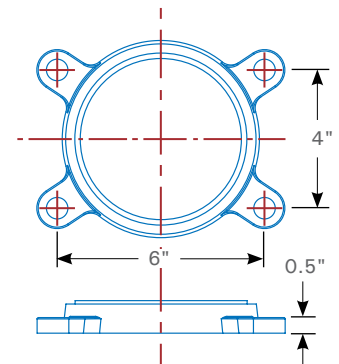
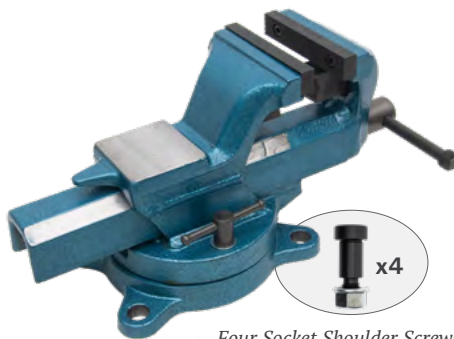

Part No.	Jaw Width	Jaw Opening	Pipe Capacity	Throat Depth	Clamping Force	Handle Dia.	Handle Length	Max Torque	Weight
TXV5-4	4"	5"	0.5" ~ 2"	2.9"	5,000 lb	0.435"	7.125"	118 ft/lb	22 lb



The Rhino Cart® Tabletop is COMPATIBLE WITH all BuildPro® Clamps, Components, and Modular Fixturing Kits.

[The exceptions are: Sliding Channel Clamps and Sliding Channel Bases]

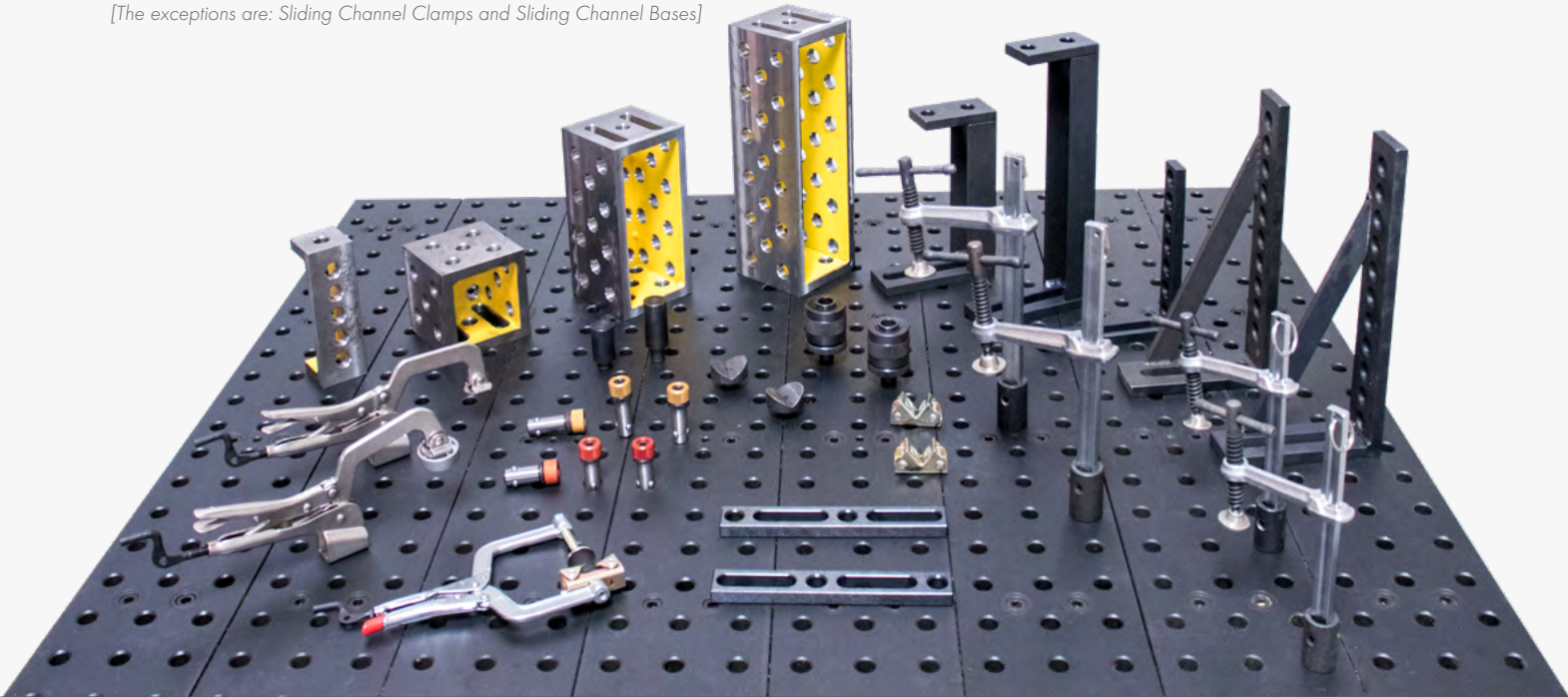

Increase your fixturing options and capabilities by using the BuildPro® Fixturing Elements.



Contact Us:

800.989.5244
www.stronghandtools.com
sales@stronghandtools.com
Santa Fe Springs, CA 90670 U.S.A.

© 2019-2020 Strong Hand Tools.
All Rights Reserved.

** All product, product specifications and data are subject to change without notice to improve reliability, function, design or otherwise. Please check online for updated information and details. Strong Hand Tools is not responsible for typographical or printers' errors.*

