

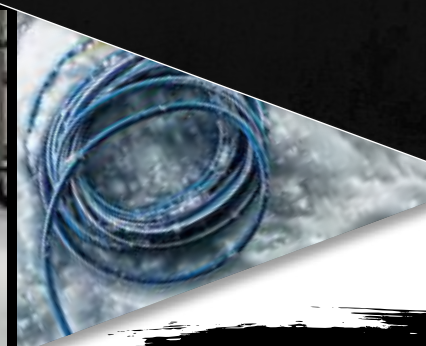

Southwire[™]

TOOLS & EQUIPMENT

2018 JOBSITE SOLUTIONS CATALOG



BUILT FOR DURABILITY.
BUILT FOR RELIABILITY.
BUILT FOR WORK.[™]

SOUTHWIRETOOLS.COM

OUR STORY

For over 60 years, Southwire has provided high quality electrical wire and cable to the commercial and industrial construction industries. Now, the name you trust provides durable, cutting-edge, professional grade tools, designed with safety and productivity in mind. Look to Southwire for solutions to all your electrical needs, from electrician's hand tools, meters, contractor equipment, temporary power and extension cords.

SOUTHWIRE, THE COMPANY

Southwire Company, LLC is North America's leading manufacturer of wire and cable used in the distribution and transmission of electricity. Throughout its history, our company has sought to help provide power through our products, our service and by helping empower our customers, employees, and communities.

SOUTHWIRE, THE PEOPLE

With more than 6,800 people at customer service centers, manufacturing facilities and sales offices throughout North America, we are dedicated to developing the highest-quality products and legendary service.

THE DRIVE FOR EXCELLENCE

Driving for excellence starts with being responsive to our customers and the markets we serve. By creating business units, Southwire Company enables each to foster an entrepreneurial spirit, innovative solutions, and responsiveness required in today's business. At the same time each division can leverage the resources and rich history of Southwire Company as a whole.

THE PRODUCTS

To be successful requires products that give you solutions no matter what stage of the project cycle you are in. Our product teams and dedicated resources work together to listen to and work with our customers, creating solutions that deliver unparalleled value through product innovation, safety and efficiency.

THE SERVICE

Service is more than a word or a phone number; it's a tangible support system that assists you through the entire project cycle. Starting with our own knowledgeable customer service team, to our National Field Sales team, and our District Merchandising Specialists. In the office or in the field, we're there to lend a hand, just when you need it most. Feel free to reach us at 1-855-SWTOOLS (855-798-6657)

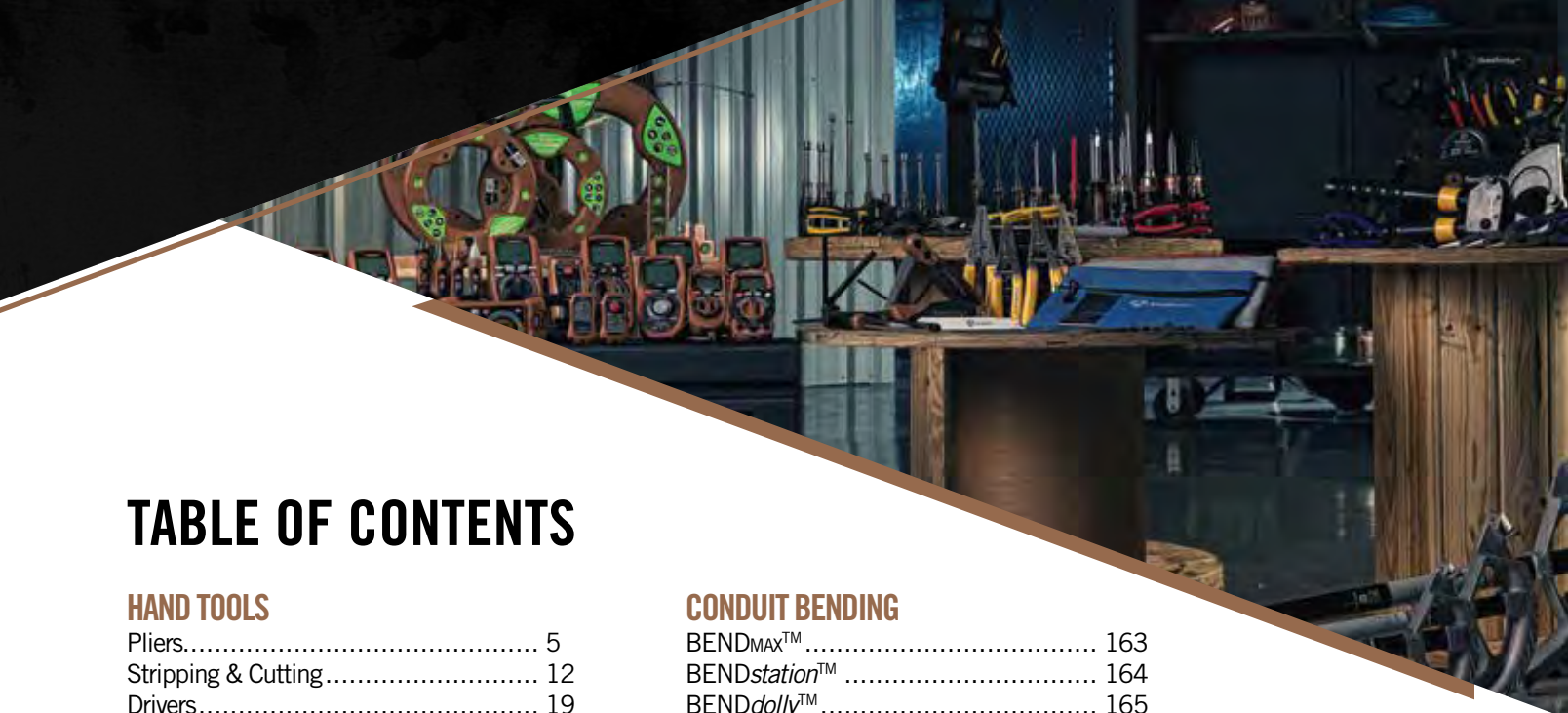

TABLE OF CONTENTS

HAND TOOLS

Pliers.....	5
Stripping & Cutting.....	12
Drivers.....	19
Measuring & Levels.....	35
Tool Bags, Pouches, & Gloves.....	37
Cable Management.....	42
Kits & Accessories.....	44

TEST & MEASUREMENT

Multimeters.....	53
Clamp Meters.....	65
Voltage Detectors & Testers.....	72
IR Thermometers.....	83
Imaging.....	87
Circuit Testers.....	88
Test Kits.....	90

VOICE • DATA • VIDEO

Cutters.....	92
Prep & Strip.....	95
Terminate.....	98
Test.....	105

CABLE PULLING

Pullers.....	115
Pulling Accessories.....	119
Pulling Rope.....	122
Pulling Grips.....	125
Fishing.....	129
Accessories.....	135

TERMINATION

Wire Strippers.....	139
Seatek™.....	141
Cutting.....	154
MAXTERM™ Crimping.....	158

CONDUIT BENDING

BENDMAX™.....	163
BENDstation™.....	164
BENDdolly™.....	165
PVC Benders.....	166
Hand Benders.....	169
Cable Benders.....	170

HOLE MAKING

Knockouts.....	173
Hole Saws.....	182
Auger Bits.....	183
Wood Boring Bits.....	186
Drill/Tap Bits.....	187
Carbide Tipped Hole Cutters.....	188

MATERIAL HANDLING

Reel Jacks.....	191
SIMpull™ Carts.....	197
Wire Wagon® Carts.....	199
Wire Carts.....	203
Wire Dollies.....	204
Wire Dispenser.....	206
Storage Containers.....	207
Weldboxes.....	212
Storage Boxes.....	214

SUMNER®

Lifts, Gantries, Stands, Dollies.....	219
---------------------------------------	-----

ELECTRICAL

Cords.....	231
Work Lights.....	239
Portable Lights.....	246
GFCI.....	248
Automotive.....	251

HAND TOOLS

Your hands are your most important tools, the ones you need for every job. Equip them with high-quality, durable hand tools from Southwire. With a strong yet comfortable design and no-hassle lifetime warranty*, you can rely on these tools to make your life easier and last through years of hard work.

- Pliers
- Cable Management
- Stripping & Cutting
- Drivers
- Measuring & Levels
- Tool Bags, Pouches, & Gloves
- Kits & Accessories

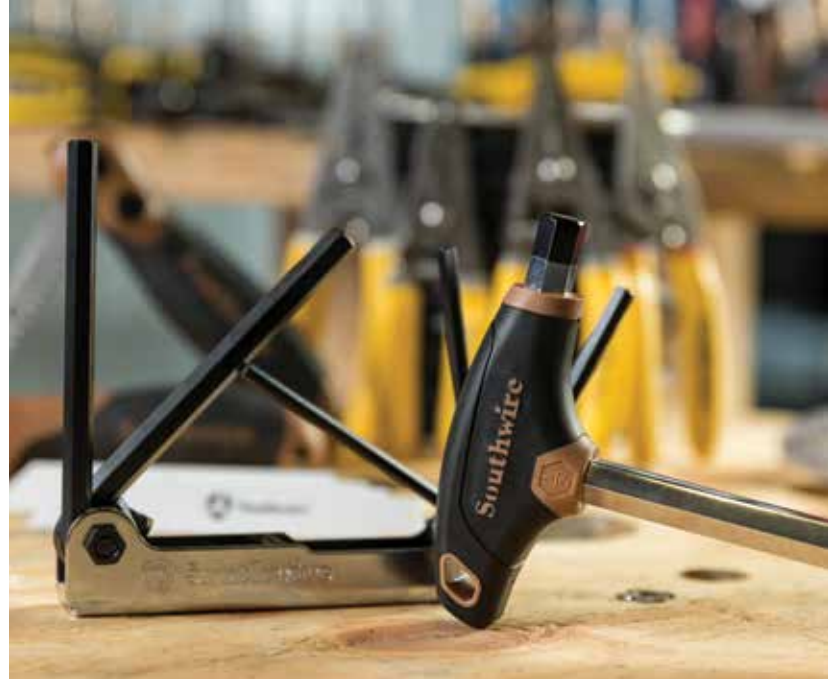

HIGH LEVERAGE SIDE CUTTING PLIERS

SCP9TPC



SCP9C



SCP9



SCP9CD



SCP9D



Our high leverage side cutting pliers offer a streamlined design with sure-gripping, cross-hatched knurled jaws.

- Induction-hardened cutting blades ensure efficient and lasting cutting surfaces for hard and soft wire
- Drop forged CRV steel for durability
- File teeth on jaws help remove burrs in conduit
- Curved ergonomic handle for comfortable use

SPECIFICATIONS

COMFORT GRIP

MODEL #	STOCK #	DESCRIPTION		
SCP9TPC	US: 589931	High Leverage Side Cutting Pliers w/ Fish Tape Puller & Crimper		
SCP9TPC	CAD: 589945	High Leverage Side Cutting Pliers w/ Fish Tape Puller & Crimper		
SCP9C	US: 589930	High Leverage Side Cutting Pliers w/ Crimper		
SCP9C	CAD: 589944	High Leverage Side Cutting Pliers w/ Crimper		
SCP9	US: 589929	High Leverage Side Cutting Pliers		
SCP9	CAD: 589943	High Leverage Side Cutting Pliers		
	HEIGHT	WIDTH	DEPTH	WEIGHT
SCP9TPC	9.5"	2.5"	0.88"	19 oz
SCP9C	9.5"	2.5"	0.88"	19 oz
SCP9	9.5"	2.5"	0.88"	19 oz

DIPPED GRIP

MODEL #	STOCK #	DESCRIPTION		
SCP9D	582898	High Leverage Diagonal Cutting Pliers w/ Dipped Handle		
SCP9CD	587491	High Leverage Diagonal Cutting Pliers w/ Crimper Dipped Handles		
	HEIGHT	WIDTH	DEPTH	WEIGHT
SCP9D	9.5"	2.13"	0.75"	19 oz
SCP9CD	9.5"	2.13"	0.75"	19 oz



PLIERS

LONG NOSE PLIERS

LNP8S



Southwire long nose pliers provide a better grip without sacrificing tool strength or durability.

- Knurled jaws for sure-gripping
- Drop forged CRV steel for durability
- High leverage, hot rivet design for smooth action and no handle wobble
- Long nose design for forming and looping wire and handling small parts
- Precision induction-hardened cutting knives for long-lasting cutting edge
- 12 AWG solid wire stripping feature on LNP8S and LNP8SD models

LNP7



LNP6



LNP8SD



LNP7D



LNP6D



SPECIFICATIONS

COMFORT GRIP

MODEL #	STOCK #	DESCRIPTION		
LNP8S	US: 589928	8" Heavy Duty Long Nose Pliers w/ Side Cutting Stripper		
LNP8S	CAD: 589942	8" Heavy Duty Long Nose Pliers w/ Side Cutting Stripper		
LNP7	US: 589927	7" Long Nose Pliers w/ Side Cutter		
LNP7	CAD: 589941	7" Long Nose Pliers w/ Side Cutter		
LNP6	US: 589926	6" Long Nose Pliers w/ Side Cutter		
LNP6	CAD: 589940	6" Long Nose Pliers w/ Side Cutter		
	HEIGHT	WIDTH	DEPTH	WEIGHT
LNP8S	8.5"	2.13"	0.88"	10.3 oz
LNP7	7.13"	2.25"	0.75"	5.7 oz
LNP6	7"	2.25"	0.75"	5.5 oz

DIPPED GRIP

MODEL #	STOCK #	DESCRIPTION		
LNP8SD	582897	8" Hvy. Dty. Long Nose Pliers Side Cutting Stripper Dipped Handle		
LNP7D	587490	7" Long Nose Pliers w/ Side Cut Dipped Handle		
LNP6D	582896	6" Long Nose Pliers w/ Side Cut Dipped Handle		
	HEIGHT	WIDTH	DEPTH	WEIGHT
LNP8SD	8.38"	2.13"	0.63"	10.3 oz
LNP7D	7.38"	2.13"	0.63"	6 oz
LNP6D	6.88"	2.13"	0.63"	5 oz



HIGH LEVERAGE DIAGONAL CUTTING PLIERS

DCP8



The high leverage design of these diagonal cutting pliers provides greater cutting power while the hot riveted joint ensures smooth action with no handle wobble.

- Drop forged CRV steel for durability
- Induction hardened cutting blades ensure efficient and lasting cutting surfaces
- High leverage design provides maximum cutting power
- Hot riveted pivot joint provides smooth action and no wobble
- Effectively cuts most hardened wire, ACSR, bolts, screws, and nails
- Available in dual molded comfort grips and plastic dipped handles

DCPA8



DCP8D



DCPA8D



DCP6D

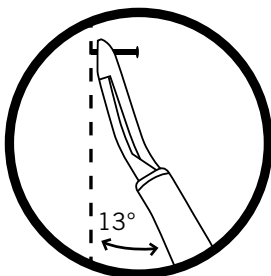

*DCPA8 and DCPA8D

SPECIFICATIONS

COMFORT GRIP

MODEL #	STOCK #	DESCRIPTION		
DCP8	US: 589933	8" High Leverage Diagonal Cutting Pliers		
DCP8	CAD: 589947	8" High Leverage Diagonal Cutting Pliers		
DCPA8	US: 589932	8" High Leverage Diagonal Cutting Pliers w/ Angled Head		
DCPA8	CAD: 589946	8" High Leverage Diagonal Cutting Pliers w/ Angled Head		
	HEIGHT	WIDTH	DEPTH	WEIGHT
DCP8	8.25"	2.25"	0.75"	11.6 oz
DCPA8	8.25"	2.25"	0.75"	11.6 oz

DIPPED GRIP

MODEL #	STOCK #	DESCRIPTION		
DCP8D	582894	8" High Leverage Diagonal Cutting Pliers w/ Dipped Handle		
DCPA8D	582895	8" High Leverage Diagonal Cutting Pliers w/ Angled Head and Dipped Handle		
DCP6D	587399	6" High Leverage Diagonal Cutting Pliers Dip Handle		
	HEIGHT	WIDTH	DEPTH	WEIGHT
DCP8D	8"	2"	0.63"	9.8 oz
DCPA8D	8"	2"	0.63"	9.8 oz
DCP6D	6"	2"	0.63"	6.4 oz



PLIERS

CABLE CUTTING PLIERS

CCP9



The shear type hook jaws grab and hold cable while the shear cutting action allows for clean cuts.

- Heat treated, precision ground blades ensure clean cuts
- Comfortable cushion grips reduce hand fatigue
- Forged steel with black-oxide finish for long life
- High leverage pivot joint ensures smooth action and no handle wobble

CCP9DE



SPECIFICATIONS

COMFORT GRIP

MODEL #	STOCK #	DESCRIPTION		
CCP9	US: 589935	9" High Leverage Cable Cutters		
CCP9	CAD: 589949	9" High Leverage Cable Cutters		
CCP6	US: 589934	6 1/2" Cable Cutting Shears		
CCP6	CAD: 589948	6 1/2" Cable Cutting Shears		
	HEIGHT	WIDTH	DEPTH	WEIGHT
CCP9	9.38"	2.13"	0.63"	15 oz
CCP6	6.75"	2"	0.75"	8.6 oz

CCP6



DIPPED GRIP

MODEL #	STOCK #	DESCRIPTION		
CCP9DE	643230	9" High-Leverage Cable Cutters w/ Ergonomic Dipped Handle		
CCP6D	587489	6 1/2" Cable Cutting Shears w/ Dipped Handle		
	HEIGHT	WIDTH	DEPTH	WEIGHT
CCP9DE	9.25"	1.8"	0.62"	1 lb.
CCP6D	6.75"	2"	0.75"	8.2 oz

CCP6D



PUMP PLIERS

PP10



PP6



Our tongue-and-groove design provides a firm and secure grip in a wide range of versatile jaw positions.

- V-jaw design allows for greater holding force and better surface contact
- Undercut tongue-and-groove design resists slipping
- Smoothly adjusts between jaw positions
- Right angle, laser heat-treated teeth grip better and last longer
- High-carbon, CRV polished steel for increased durability
- Molded comfort grip for comfortable use

SPECIFICATIONS

MODEL #	STOCK #	DESCRIPTION		
PP10	US: 589937	10" Pump Pliers w/ Comfort Grip Handle		
PP10	CAD: 589951	10" Pump Pliers w/ Comfort Grip Handle		
PP6	US: 589938	6 1/2" Pump Pliers w/ Comfort Grip Handle		
PP6	CAD: 589952	6 1/2" Pump Pliers w/ Comfort Grip Handle		
	HEIGHT	WIDTH	DEPTH	WEIGHT
PP10	10.5"	2.5"	0.44"	15.5 oz
PP6	7"	2"	0.5"	7.6 oz

TERMINAL CRIMPING/CUTTING PLIERS

TCC9



TCC9D



These high leverage crimping pliers have two die positions that permit the tool to crimp insulated and non-insulated terminals and ferrules.

- Tapered nose for working in confined spaces
- Crimps 10-22 AWG solderless terminals and connectors
- Specially hardened wire cutter in nose
- Curved handle and ergonomic molded grip for comfortable use
- Crimps insulated and non-insulated terminals and connectors

SPECIFICATIONS

MODEL #	STOCK #	DESCRIPTION		
TCC9	US: 589936	Terminal Crimper Cutter w/ Comfort Grip Handle		
TCC9	CAD: 589950	Terminal Crimper Cutter w/ Comfort Grip Handle		
TCC9D	582899	Terminal Crimper Cutter w/ Dipped Handle		
	HEIGHT	WIDTH	DEPTH	WEIGHT
TCC9D	9.75"	2.38"	0.63"	12.7 oz
TCC9	9.38"	1.88"	0.75"	13.7 oz

PLIERS

5-IN-1 MULTI-TOOL PLIERS

S5N1



This versatile pair of spring action pliers performs multiple functions.

- Multi-functional pliers: grips, strips, crimps, reams, and cuts
- Narrow knurled jaw allows access to tight spaces
- Cuts small gauge copper wire and communication cables
- Crimps common size wire ferrules
- Reams and smooths thin-wall conduit ends
- Easily strips 10-14 AWG solid wire
- Durable forged construction for lasting performance
- Comfortable grips minimize hand wear and fatigue



SPECIFICATIONS

MODEL #	STOCK #	DESCRIPTION	HEIGHT	WIDTH	DEPTH	WEIGHT
S5N1	US: 589939	5-in-1 Multi-Tool Pliers w/ Comfort Grip				
S5N1	CAD: 589953	5-in-1 Multi-Tool Pliers w/ Comfort Grip				
S5N1			8.25"	2.5"	0.63"	5.6 oz

MULTI-PURPOSE SIDE CUTTING PLIER

MPSCP



Multi-Purpose Side Cutting Plier cuts ACSR, screws, nails, and most hardened wire.

- Drop forged construction for durability
- High-leverage pivot joint for easier cuts
- Strips 8-14 AWG solid wire and 10-16 stranded wire
- 6-32 and 8-32 screw shearing

SPECIFICATIONS

MODEL #	STOCK #	DESCRIPTION	HEIGHT	WIDTH	DEPTH	WEIGHT
MPSCP	597244	Multi-Purpose Side Cutting Plier				
MPSCP			11.38"	3.75"	1.50"	0.6 lb.

MADE IN USA PLIERS

SCP9TPCD-US



DCPA8D-US



Made from American forged steel, these tools are built to withstand jobsite wear and tear. Assembled with hot rivet technology, these pliers are designed to be the livelihood of every professional.

- Hot riveted pivot joint for smooth action
- Induction hardened
- Hand sharpened blades
- Drop forged USA steel for durability

CCP9D-US



TCC9D-US



SPECIFICATIONS

MODEL #	STOCK #	DESCRIPTION		
SCP9TPCD-US	648073	Made in USA 9" High-Leverage Side Cutting Pliers w/ Fish Tape Puller, Crimper, & Dipped Grip Handles		
DCPA8D-US	648075	Made in USA 8" Angled Head High-Leverage Diagonal Cutting Pliers w/ Dipped Handles		
CCP9D-US	648076	Made in USA 9" High-Leverage Cable Cutters w/ Dipped Grip Handles		
TCC9D-US	648077	Made in USA 9" Terminal Crimper/Cutter w/ Dipped Grip Handles		
	HEIGHT	WIDTH	DEPTH	WEIGHT
SCP9TPCD-US	11.75"	3.88"	11.75"	1.1 lb
DCPA8D-US	10.13"	3.88"	10.13"	0.6 lb
CCP9D-US	11.75"	3.88"	11.75"	1.05 lb
TCC9D-US	11.75"	3.88"	11.75"	0.9 lb

STRIPPING & CUTTING

WIRE STRIPPERS & CUTTERS

S1018SOL



S612STR



S1018STR



S1626STR



Made of stainless steel, these wire strippers have precision ground stripping holes and are fitted with comfortable double-dipped plastic grips.

- Stainless steel construction is durable and rust-proof
- Serrated nose grasps the cable for easy twisting and pulling
- Double-dipped grip provides comfortable feel
- Spring loaded for self-opening action
- Specially designed cutting blades provide fast and clean wire stripping and cutting

SPECIFICATIONS

MODEL #	STOCK #	DESCRIPTION	HEIGHT	WIDTH	DEPTH	WEIGHT
S1018SOL	582780	Wire Stripper Cutter 10-18SOL;12-20 Stranded Ergonomic Handle	7.63"	8.38"	0.69"	5.3 oz
S1018STR	582781	Compact Stripper Cutter 10-18 AWG Solid	6.25"	2.38"	0.69"	4.6 oz
S612STR	582779	Wire Stripper Cutter 6-12 AWG Stranded Ergonomic Handle	7.38"	2.5"	0.63"	5.3 oz
S1626STR	582782	Compact Stripper Cutter 16-26 AWG Stranded	6.25"	2"	0.69"	4.5 oz

MADE IN USA WIRE STRIPPERS & CUTTERS

S1020SOL-US



Made from durable, heat-treated steel, the Made in USA Wire Strippers & Cutters are equipped to handle day-to-day jobsite demands.

- Made from durable heat-treated steel for longer life
- Double-dipped grip for comfortable fit
- Serrated nose holds cable for easy twisting and pulling
- Spring-loaded for self-opening action
- Not intended for cutting bolts or steel wire

S1018SOL-US



SPECIFICATIONS

MODEL #	STOCK #	DESCRIPTION		
S1020SOL-US	648079	Made in USA 10-20 AWG SOL & 12-22 AWG Compact Wire Stripper/Cutter		
S1018SOL-US	648080	Made in USA 10-18 AWG SOL & 12-20 AWG STR Ergo Wire Stripper/Cutter		
	HEIGHT	WIDTH	DEPTH	WEIGHT
S1020SOL-US	8.63"	3.88"	8.63"	0.32 lb
S1018SOL-US	9.34"	3.88"	9.34"	0.37 lb.

AUTOMATIC WIRE STRIPPER

SA822



With this wire stripper, insert a wire, squeeze the handles, and you're finished.

- Strips 8-22 AWG wire quickly and easily
- Removes up to 1" of jacket layer with single step
- Spring design returns wire to ready position after stripping

SPECIFICATIONS

MODEL #	STOCK #	DESCRIPTION		
SA822	582786	Automatic Wire Stripper 8-22 AWG		
	HEIGHT	WIDTH	DEPTH	WEIGHT
SA822	7"	3.38"	1.13"	13 oz

STRIPPING & CUTTING

WIRE STRIPPERS & CUTTERS

SNM1012



Made of stainless steel, these wire strippers have precision ground stripping holes and are fitted with comfortable double-dipped plastic grips.

SNM1214



- Stainless steel* construction is durable and rust-proof
- Serrated nose grasps the cable for easy twisting and pulling
- Specially designed cutting blades provide fast and clean wire stripping and cutting
- Double-dipped grip provides comfortable fit
- Spring loaded for self-opening action (on models SNM1012, SNM1214)

MP61



MPLN



SVN



SPECIFICATIONS

MODEL #	STOCK #	DESCRIPTION		
SNM1012	582784	NM Cable Stripper Cutter 10-12 AWG Ergonomic Handle		
SNM1214	582785	NM Cable Stripper Cutter 12-14 AWG Ergonomic Handle		
MP61	582789	6-in-1 Multipurpose Stripper		
MPLN	582788	Long Nose Multipurpose Tool		
SVN	582787	Wire Stripper V-Notch		
	HEIGHT	WIDTH	DEPTH	WEIGHT
SNM1012	8.13"	2.19"	0.69"	6 oz
SNM1214	7.88"	2.19"	0.69"	5.8 oz
MP61	9"	2.38"	0.69"	6.8 oz
MPLN	8.5"	2.38"	0.75"	5.8 oz
SVN	5.25"	2.31"	0.44"	2.3 oz

*Excludes SVN

CABLE RIPPER TOOL

CRT



This NM-B cable ripper makes cable jacket removal quick and easy. It slits the cable jacket with one easy stroke.

- Makes end or mid-run slits to expose insulated wires
- Easily slits the outer jacket on NM-B cable
- Accurate wire measuring gauge holes from 6 to 14 AWG solid wire

SPECIFICATIONS

MODEL #	STOCK #	DESCRIPTION	HEIGHT	WIDTH	DEPTH	WEIGHT
CRT	582933	Cable Ripper Tool				
CRT			3.68"	1.88"	1.38"	.05 lb.

ELECTRICIAN'S HACKSAW

HSAW



An essential tool for plumbers, electricians and HVAC professionals.

- Cushioned, ergonomic grip for performance and comfort
- Extra blade storage in frame
- Blades can be adjusted to 55 degree angle for flush cutting
- Forward handle can be removed and used as jab saw

SPECIFICATIONS

MODEL #	STOCK #	DESCRIPTION	HEIGHT	WIDTH	DEPTH	WEIGHT
HSAW	582827	Electrician's Hacksaw				
HSAW			17"	6"	1"	2.1 oz

STRIPPING & CUTTING

TRIFOLD DRYWALL SAW

FDWSAW



Ideal for flush cutting applications or when a hacksaw is not available.

- Ergonomic handle for greater comfort
- Blade locks in three positions for safer operation
- Includes three blades 5"x18 TPI, 5"x6 TPI, 5"x9 TPI; accepts standard reciprocating

SPECIFICATIONS

MODEL #	STOCK #	DESCRIPTION	HEIGHT	WIDTH	DEPTH	WEIGHT
FDWSAW	582885	Trifold Drywall Saw				
FDWSAW			7"	1.5"	1.13"	11 oz

DRYWALL JAB SAW

DESAW



Our Drywall Jab Saw is designed with a triple cut blade for a fast and efficient cut. The sharp tip excels at plunge cutting, and its aggressive tooth design cuts fast.

- Hardened and tempered steel blade for long lasting durability and strength
- Sharp cross-ground teeth cut through drywall, wood, or plastic
- Over molded cushion handle for comfort and firm grip
- 7" blade with cross-grained teeth cuts drywall in both directions

SPECIFICATIONS

MODEL #	STOCK #	DESCRIPTION	HEIGHT	WIDTH	DEPTH	WEIGHT
DESAW	582824	Drywall Jab Saw				
DESAW			12"	1.63"	1.13"	4.7 oz

CONDUIT SCORER AND CUTTER

CONCUT



Cut copper, aluminum, and brass tubing as well as galvanized thin wall conduit in a few revolutions.

- Scores and cuts EMT conduit
- Cutting wheel can be changed quickly and easily

SPECIFICATIONS

MODEL #	STOCK #	DESCRIPTION	HEIGHT	WIDTH	DEPTH	WEIGHT
CONCUT	582820	Conduit Scorer and Cutter				
CONCUT			5.25"	2"	1.5"	15.4 oz

ELECTRICIAN'S SCISSORS

ES001



Unlike regular scissors or shears, the serrated blades keep wire from slipping out of the jaws, so that cutting through hardware cloth, cable, wire netting, and other difficult-to-cut materials becomes an easy task.

- Durable nickel-plated steel for resistance from rust and corrosion
- Strips 19 AWG & 23 AWG
- Scraper and file on outside of both blades
- Cuts up to 16 AWG solid and 12 AWG stranded wire

SPECIFICATIONS

MODEL #	STOCK #	DESCRIPTION		
ES001	582835	Electrician's Scissors		
	HEIGHT	WIDTH	DEPTH	WEIGHT
ES001	5.38"	2.19"	0.38"	3 oz

PLASTIC PIPE CUTTER

PLACUT



Our plastic pipe and tubing cutter has non-slip grips and a strong stainless steel blade that makes cutting plastic tubing easy.

- Easily performs flush cuts on rigid plastic tubing
- Durable design for rugged use
- Locking latch allows easy one-handed operation
- Cuts up to 3/4" PVC and 1-5/8" flexible tubing

SPECIFICATIONS

MODEL #	STOCK #	DESCRIPTION		
PLACUT	582821	Plastic Pipe Cutter		
	HEIGHT	WIDTH	DEPTH	WEIGHT
PLACUT	8.75"	1.83"	1.17"	5.6 oz

STRIPPING & CUTTING

BOOT KNIFE

BN01



Our tough boot knife cuts electronic wire, telephone cables, and skins cable jackets.

- Tough forged steel blade for durability
- Used to cut electronic wire, telephone cables, & skin cable jackets
- Comes with protective storage cap

SPECIFICATIONS

MODEL #	STOCK #	DESCRIPTION		
BN01	582884	Boot Knife		
	HEIGHT	WIDTH	DEPTH	WEIGHT
BN01	6.38"	1"	0.5"	2 oz

KEYSTONE TIP SCREWDRIVERS

SD5/16K6HD



SD1/4K4HD



SD1/4K1-1/2



Southwire's screwdrivers are designed for the professional with durability, quality and comfort in mind.

- Integral flanges provide a solid, twist-resistant blade anchor
- Comfortable cushion grip handle offers slip resistance and greater torque
- Heavy duty models include bolster on shaft to provide additional torque
- Handle end is marked for easy identification of tip type and size
- Chrome-plated, steel shaft for application of maximum torque with less shaft twisting

SPECIFICATIONS

MODEL #	STOCK #	DESCRIPTION		
SD5/16K6HD	582846	5/16" Keystone Tip Screwdriver w/ 6" Heavy Duty Square Shank		
SD1/4K4HD	582854	1/4" Keystone Tip Screwdriver w/ 4" Heavy Duty Shank		
SD1/4K1-1/2	582860	1/4" Keystone Tip Stubby Screwdriver		
	HEIGHT	WIDTH	DEPTH	WEIGHT
SD5/16K6HD	11"	1.25"	1.25"	6.5 oz
SD1/4K4HD	8.38"	1.25"	1.25"	3.2 oz
SD1/4K1-1/2	3.73"	1.25"	1.25"	2.4 oz
	HEAD CLASS	SHANK TYPE	SHANK LENGTH	
SD5/16K6HD	Keystone	HD Square	6"	
SD1/4K4HD	Keystone	HD Square	4"	
SD1/4K1-1/2	Keystone	Round	1 1/2"	

DRIVERS

CABINET TIP SCREWDRIVERS

SD3/16C4



SD3/16C6



SD1/4C4



SD1/4C6



SDI1/4K4



Southwire's screwdrivers are designed for the professional with durability, quality, and comfort in mind.

- Integral flanges provide a solid, twist-resistant blade anchor
- Comfortable cushion grip handle offers slip resistance and greater torque
- Heavy duty models include bolster on shaft to provide additional torque
- Handle end is marked for easy identification of tip type and size
- Chrome-plated, steel shaft for application of maximum torque with less shaft twisting

SPECIFICATIONS

MODEL #	STOCK #	DESCRIPTION		
SD3/16C3	583015	3/16" Cabinet Tip Screwdriver with 3" Shank		
SD3/16C4	582852	3/16" Cabinet Tip Screwdriver w/ 4" Round Shank		
SD3/16C6	582850	3/16" Cabinet-Tip Screwdriver w/ 6" Round Shank		
SD3/16C8	583016	3/16" Cabinet Tip Screwdriver with 8" Shank		
SD3/16C10	583017	3/16" Cabinet Top Screwdriver with 10" Shank		
SD1/4C4	582937	1/4" Cabinet Tip Screwdriver w/ 4" Round Shank		
SD1/4C6	582853	1/4" Cabinet Tip Screwdriver w/ 6" Round Shank		
SDI1/4K4	582844	1/4" Flat Tip Screwdriver w/ 4" Insulated Shank		
	HEIGHT	WIDTH	DEPTH	WEIGHT
SD3/16C3	6.88"	1.12"	1.12"	.15 lb.
SD3/16C4	6.5"	1.13"	1.13"	3.2 oz
SD3/16C6	9.6 3"	1.13"	1.13"	7 oz
SD3/16C8	11.75"	1.12"	1.12"	.22 lb.
SD3/16C10	13.75"	1.12"	1.12"	.25 lb.
SD1/4C4	8.38"	1.25"	1.25"	3.9 oz
SD1/4C6	10.25"	1.25"	1.25"	3.9 oz
SDI1/4K4	8.38"	1.25"	1.25"	3.9 oz
	HEAD CLASS		SHANK TYPE	SHANK LENGTH
SD3/16C3	Cabinet		Round	3"
SD3/16C4	Cabinet		Round	4"
SD3/16C6	Cabinet		Round	6"
SD3/16C8	Cabinet		Round	8"
SD3/16C10	Cabinet		Round	10"
SD1/4C4	Cabinet		Round	4"
SD1/4C6	Cabinet		Round	6"
SDI1/4K4	Flat		Round/Insulated	4"

ROTARY SCREWDRIVERS



Rotary action screwdrivers facilitate fast and easy screw installation and removal.

- Chrome-plated, steel shaft spins to permit faster one-handed screwing than conventional screwdrivers
- Precision-machined tips reduce slipping
- Comfortable cushion grip handle offers slip resistance and greater torque
- Handle end is marked for easy identification of tip type and size

SPECIFICATIONS

MODEL #	STOCK #	DESCRIPTION		
SD3/16CRD	582855	3/16" Cabinet Tip Crank Screwdriver		
SDC2P	582848	#2 Phillips Crank Screwdriver		
	HEIGHT	WIDTH	DEPTH	WEIGHT
SD3/16CRD	10.5"	2"	1"	4.2 oz
SDC2P	10.5"	2"	1"	4.2 oz

DRIVERS

PHILLIPS TIP SCREWDRIVERS

SD2P6HD



SD2P4HD



SD2P1-1/2



SD1P3



SDI2P4



SD2P7



SD2P10



Southwire's screwdrivers are designed for the professional with durability, quality and comfort in mind.

- Comfortable cushion grip handle offers slip resistance and greater torque
- Integral flanges provide a solid, twist-resistant blade anchor
- Handle end is marked for easy identification of tip type and size
- Chrome-plated, steel shaft for maximum torque with less shaft twisting
- Precision-machined, black phosphate coated tip reduces slipping

SPECIFICATIONS

MODEL #	STOCK #	DESCRIPTION			
SD2P6HD	582851	#2 Phillips Screwdriver w/ 6" Heavy Duty Round Shank			
SD2P4HD	582847	#2 Phillips Screwdriver w/ 4" Heavy Duty Round Shank			
SD1P3	582849	#1 Phillips Screwdriver w/ 3" Round Shank			
SD2P1-1/2	582861	#2 Stubby Screwdriver w/ 1-1/2" Shank			
SDI2P4	582843	#2 Phillips Screwdriver w/ 4" Insulated Shaft			
SD2P7	583017	#2 Phillips Tip Screwdriver w/ 7" Shank			
SD2P10	583016	#2 Phillips Tip Screwdriver w/ 10" Shank			
	HEIGHT	WIDTH	DEPTH	WEIGHT	
SD2P6HD	10.25"	1.25"	1.25"	7 oz	
SD2P4HD	6.5"	1.25"	1.25"	4.2 oz	
SD1P3	6.5"	1.13"	1.13"	2.4 oz	
SD2P1-1/2	3.75"	1.25"	1.25"	1.8 oz	
SDI2P4	8.5"	1"	1"	3.9 oz	
SD2P7	11.25"	1.25"	1.25"	0.3 lb.	
SD2P10	14.25"	1.25"	1.25"	0.3 lb.	
	SHANK TYPE		SHANK LENGTH		
SD2P6HD	Round w/ Bolster		6"		
SD2P4HD	Round w/ Bolster		4"		
SD1P3	Round		3"		
SD2P1-1/2	Round		1 1/2"		
SDI2P4	Insulated		4"		
	TIP TYPE	TIP SIZE	SHANK TYPE	SHANK LENGTH	
SD2P7	Phillips	#2	Round	7"	
SD2P10	Phillips	#2	Round	10"	

SCREW HOLDING SCREWDRIVERS



Protective sheath holds screws in place to allow one-handed operation.

- Precision-machined, black phosphate coated tip reduces slipping
- Comfortable cushion grip handle offers slip resistance and greater torque
- Integral flanges provide a solid, twist-resistant blade anchor
- Handle end is marked for easy identification of tip type and size

SPECIFICATIONS

MODEL #	STOCK #	DESCRIPTION			
SDSH1/4	582840	1/4" Slotted Screwholding Screwdriver			
SDSH2P6	582839	#2 Phillips Screwholding Screwdriver			
	HEIGHT	WIDTH	DEPTH	WEIGHT	HEAD SIZE
SDSH1/4	11.25"	1.25"	1.25"	4.9 oz	1/4"
SDSH2P6	11.25"	1.25"	1.25"	4.9 oz	#2
	HEAD CLASS		SHANK TYPE		SHANK LENGTH
SDSH1/4	Slotted		Screwholding		6"
SDSH2P6	Phillips		Screwholding		6"

DRIVERS

SQUARE TIP SCREWDRIVERS

SDQ2P1-1/2



SDQ2P4



Southwire's screwdrivers are designed for the professional with durability, quality and comfort in mind.

- Chrome-plated, steel shaft for maximum torque with less shaft twisting
- Precision-machined, black phosphate coated tip reduces slipping
- Comfortable cushion grip handle offers slip resistance and greater torque
- Integral flanges provide a solid, twist-resistant blade anchor
- Handle end is marked for easy identification of tip type and size

SPECIFICATIONS

MODEL #	STOCK #	DESCRIPTION		
SDQ2P1-1/2	582842	#2 Square Recessed Tip Screwdriver w/ 1.5" Shank		
SDQ2P4	582862	#2 Square Recessed Tip Screwdriver w/ 4" Shank		
	HEIGHT	WIDTH	DEPTH	WEIGHT
SDQ2P1-1/2	3.75"	1.25"	1.25"	1.8 oz
SDQ2P4	8.5"	1.25"	1.25"	3.8 oz
	HEAD CLASS	SHANK TYPE	SHANK LENGTH	
SDQ2P1-1/2	Square	Round	1 1/2"	
SDQ2P4	Square	Round	4"	

CUSHION-GRIP SCRATCH AWL

AWL001



Our heavy-duty, hard-pointed awl is perfect for scribing metal, starting screw holes and a variety of other piercing and punching jobs.

- Heavy duty chrome plated steel shaft
- Comfortable cushion grip handle offers slip resistance and greater torque

SPECIFICATIONS

MODEL #	STOCK #	DESCRIPTION		
AWL001	582836	Scratch Awl		
	HEIGHT	WIDTH	DEPTH	WEIGHT
AWL001	6.75"	1.13"	1.13"	3 oz

CONDUIT FITTING REAMING SCREWDRIVER

SDCFR



Removable conduit reaming screwdriver deburs thin wall conduit with speed and ease.

- Reams and smooths 1/2", 3/4", and 1" thin-wall conduit ends to protect wire and permit correct installation of fittings
- Reams inside and outside of conduit simultaneously
- Cushion grip handles for comfort and use
- Detachable head can also be used in a drill

SPECIFICATIONS

MODEL #	STOCK #	DESCRIPTION		
SDCFR	582837	Conduit Fitting Reaming Screwdriver		
	HEIGHT	WIDTH	DEPTH	WEIGHT
SDCFR	7.5"	1.25"	1.25"	9.5 oz

STAR TIP SCREWDRIVER

SD15T4 SD20T4



SD25T4 SD27T4



SPECIFICATIONS

MODEL #	STOCK #	DESCRIPTION		
SD15T4	583003	#15 Star Tip Screwdriver w/ 4" Shank		
SD20T4	583004	#20 Star Tip Screwdriver w/ 4" Shank		
SD25T4	583006	#25 Star Tip Screwdriver w/ 4" Shank		
SD27T4	583007	#27 Star Tip Screwdriver w/ 4" Shank		
	HEIGHT	WIDTH	DEPTH	WEIGHT
SD15T4	7.75"	1.12"	1.12"	0.15 lb.
SD20T4	7.75"	1.12"	1.12"	0.2 lb.
SD25T4	8.25"	1.25"	1.25"	0.25 lb.
SD27T4	8.375"	1.25"	1.25"	0.25 lb.
	TIP TYPE	TIP SIZE	SHANK TYPE	SHANK LENGTH
SD15T4	Star	#15	Round	4"
SD20T4	Star	#20	Round	4"
SD25T4	Star	#25	Round	4"
SD27T4	Star	#27	Round	4"

DRIVERS

8-PIECE CUSHION GRIP SCREWDRIVER SET

SDSET8



All-purpose assortment of frequently used screwdrivers.

- Comfortable cushion grip handle offers slip resistance and greater torque
- Precision tips for an exact fit
- Handles marked for easy identification
- Includes 8 pieces: 3/16"x4", 3/16"x6" and 1/4"x4" slotted tip, 1/4"x4" and 5/16"x6" keystone tip, #1x3", #2x4", Phillips tip, and #2x4" square tipped screwdrivers

4-PIECE MINI SCREWDRIVER SET

SDSET4MINI



Versatile mini drivers for precise applications.

- Comfortable cushion grip handle offers slip resistance and greater torque
- Precision tips for an exact fit
- Includes 1/16", 3/32", and 1/8" slotted and #0 Phillips tipped screwdrivers
- Handles marked for easy identification

2-PIECE STUBBY SCREWDRIVER SET

SDSET2-3



Drivers for accurate fits in tight spaces.

- Comfortable cushion grip handle offers slip resistance and greater torque
- Precision tips for an exact fit
- Handles marked for easy identification
- #2 Phillips and 1/4" keystone
- 1-1/2" shank

SPECIFICATIONS

MODEL #	STOCK #	DESCRIPTION	HEIGHT	WIDTH	DEPTH	WEIGHT	INCLUDES
SDSET8	582845	8-Piece Cushion Grip Screwdriver Set	11"	1.25"	1.25"	2.3 oz	SD3/16C4, SD3/16C6, SD1/4K4HD, SD1/4C4, SD5/16K6HD, SD1P3, SD2P4HD, SDQ2P4
SDSET4MINI	582857	4-Piece Mini Screwdriver Set	5.5"	0.75"	0.75"	3.5 oz	Slotted: 1/16 X 2-1/2", 3/32 X 3", 1/8 X 3" Phillips: #0 X 3"
SDSET2-3	582859	2-Piece Stubby Screwdriver Set	3.75"	1.25"	1.25"	3.6 oz	SD1/4K41-1/2, SD2P1-1/2

SCREWDRIVER WITH INTEGRATED WIRE STRIPPER

SDWS



Driver with integrated wire stripper provides two applications in one tool.

- Integrated 10-20 AWG wire stripper in handle
- Two double sided bits: #1 & #2 Phillips, 3/16" & 1/4" slotted
- Comfortable cushion grip handle offers slip resistance and greater torque
- Constructed of durable, heavy duty materials

5-IN-1 MULTI-BIT LIGHTED SCREWDRIVER

SSD5N1LITE



Convenient multi-bit screwdriver with five tools in one.

- Comfortable cushion grip handle offers slip resistance and greater torque
- Three LEDs illuminate work surface for better visibility
- Requires 3 AAA batteries (not included)
- Two double-sided quick change bits: #1 Phillips, #2 Phillips, 3/16" slotted and 1/4" slotted

9-IN-1 MULTI TOOL SCREWDRIVER

SD9N1



Convenient multi-tool screwdriver with nine tools in one.

- Three double sided quick change bits and three hex head nut drivers
- Includes 3/16", and 1/4" slotted, #1 & #2 Phillips, #1 & #2 square tips, 1/4", 5/16", 3/8" hex drivers
- Comfortable cushion grip handle offers slip resistance and greater torque

SPECIFICATIONS

MODEL #	STOCK #	DESCRIPTION	HEIGHT	WIDTH	DEPTH	WEIGHT	INCLUDES
SD5N1LITE	582939	5-in-1 Multi-Bit Lighted Screwdriver	8"	1.38"	1.238"	4 oz	Slotted Tips: 3/16", 1/4" Phillips Tips: #1, #2
SD9N1	582856	9-in-1 Multi-Tool Screwdriver	8.25"	1.25"	1.25"	9 oz	Slotted Tips: 3/16", 1/4" Phillips Tips: #1, #2 Hex Tips: 1/4", 5/16", 3/8" Square Tips: #1, #2
SDWS	582864	Screwdriver with Wire Stripper	8.5"	1.5"	1.5"	4.91 oz	10-20 AWG Solid Wire Stripper Slotted Tips: 3/16", 1/4" Phillips Tips: #1, #2

DRIVERS

12-IN-1 MULTI-BIT SCREWDRIVER

SD12N1



The 12-in-1 Multi-Bit Screwdriver has precision-machined, quick change bits.

- Precision-machined, quick change bits for driving hex, Phillips, slotted, and square head screws
- Handles 3/16", 1/4", 5/16" slotted; #1, #2, #3 Phillips; #1, #2, square recessed; and 1/4", 5/16", 3/8", 1/2" hex drive
- Cushion grip handle provides extra comfort and maximum torque
- Premium chrome-plated shaft is durable as well as rust and corrosion resistant
- Meets ANSI/ASME specifications

SPECIFICATIONS

MODEL #	STOCK #	DESCRIPTION			
SD12N1	59723901	12-in-1 Multi-Bit Screwdriver			
		HEIGHT	WIDTH	DEPTH	WEIGHT
SD12N1	11.75"	3.25"	1.38"		0.85 lb.

9-IN-1 RATCHETING SCREWDRIVER

SDR9N1



9-in-1 Ratcheting Multi-Tool Screwdriver allows for quick driving of screws and nuts.

- Precision-machined, quick change bits for driving hex, Phillips, slotted, and square head screws
- Handles 1/4", 3/8", 5/16" hex; #1 and #2 Phillips; 1/2" and 3/16" slotted; #1 and #2 square
- Cushion grip handle provides extra comfort and maximum torque
- Premium chrome-plated shaft is durable as well as rust and corrosion resistant
- Meets ANSI/ASME specifications

SPECIFICATIONS

MODEL #	STOCK #	DESCRIPTION			
SDR9N1	59724001	9-in-1 Ratcheting Screwdriver			
		HEIGHT	WIDTH	DEPTH	WEIGHT
SDR9N1	11.38"	3.75"	1.50"		0.6 lb.

6-IN-1 STUBBY MULTIBIT SCREWDRIVER

SDS6N1



The 6-in-1 Multi-Bit Screwdriver features precision-machined, quick change bits.

- Includes 2 double sided screwdriver bits and 1 double sided nut driver
- Sizes include 5/16" & 1/2" hex, #1 & #2 Phillips, & 3/16" & 1/4" slotted tips
- Cushion grip handles for added comfort and improved torque
- Durable chrome-plated shaft is rust and corrosion resistant

SPECIFICATIONS

MODEL #	STOCK #	DESCRIPTION		
SDS6N1	587397	6-in-1 Stubby Multi-Bit Screwdriver		
	HEIGHT	WIDTH	DEPTH	WEIGHT
SDS6N1	3.50"	1.25"	1.25"	.20 lb.

REVERSIBLE-SHANK SCREWDRIVER

SDREV-1



This reversible screwdriver has the two screwdriver sizes needed to work on wall plates and outlets.

- Phillips #1, Cabinet Tip #2
- Shank is easily reversed



SPECIFICATIONS

MODEL #	STOCK #	DESCRIPTION
SDREV-1	587460	Reversible-Shank Screwdriver

DRIVERS

NUT DRIVERS

Get to those hard to reach nuts/bolts with our hex head nut driver. The hollow shaft fits over long bolts and studs for most applications.

- Comfortable cushion grip handle offers slip resistance and greater torque
- Internal flanges provide solid, twist-resistant shaft anchor
- Chrome plated shanks are corrosion resistant
- Hollow 3" shafts for additional screw clearance

ND1/2-3



ND7/16-3



ND3/8-3



ND5/16-3



ND1/4-3



SPECIFICATIONS

MODEL #	STOCK #	DESCRIPTION			
ND1/2-3	582870	1/2" Nut Driver with 3" Shank			
ND7/16-3	582868	7/16" Nut Driver with 3" Shank			
ND3/8-3	582871	3/8" Nut Driver with 3" Shank			
ND5/16-3	582869	5/16" Nut Driver with 3" Shank			
ND1/4-3	582872	1/4" Nut Driver with 3" Shank			
ND9/16-4	583022	9/16" Hex Nut Driver with 4" Shank			
ND4.5-3	583025	4.5mm Hex Nut Driver with 3" Shank			
ND7-3	583028	7mm Hex Nut Driver with 3" Shank			
ND8-3	583029	8mm Hex Nut Driver with 3" Shank			
ND1/4-6	583034	1/4" Hex Nut Driver with 6" Shank			
ND5/16-6	583035	5/16" Hex Nut Driver with 6" Shank			
ND11/32-6	583036	11/32" Hex Nut Driver with 6" Shank			
ND3/8-6	583037	3/8" Hex Nut Driver with 6" Shank			
ND7/16-6	583038	7/16" Hex Nut Driver with 6" Shank			
ND1/2-6	583040	1/2" Hex Nut Driver with 6" Shank			
ND9/16-6	583041	9/16" Hex Nut Driver with 6" Shank			
	HEIGHT	WIDTH	DEPTH	WEIGHT	SHANK LENGTH
ND1/2-3	7.5"	1.25"	1.25"	4.2 oz	3"
ND7/16-3	7.5"	1.28"	1.25"	4.2 oz	3"
ND3/8-3	6.75"	0.38"	0.13"	4.2 oz	3"
ND5/16-3	6.75"	0.38"	0.13"	2.8 oz	3"
ND1/4-3	6.75"	0.38"	0.13"	2.8 oz	3"
ND9/16-4	9"	1.3"	1.3"	0.45 lb.	4"
ND4.5-3	6.75"	1.12"	1.12"	0.2 lb.	3"
ND7-3	6.75"	1.12"	1.12"	0.2 lb.	3"
ND8-3	6.75"	1.12"	1.12"	0.2 lb.	3"
ND1/4-6	9.75"	1.1"	1.1"	0.25 lb.	6"
ND5/16-6	9.75"	1.12"	1.12"	0.25 lb.	6"
ND11/32-6	9.75"	1.12"	1.12"	0.3 lb.	6"
ND3/8-6	9.75"	1.12"	1.12"	0.3 lb.	6"
ND7/16-6	10.25"	1.25"	1.25"	0.35 lb.	6"
ND1/2-6	10.25"	1.25"	1.25"	0.35 lb.	6"
ND9/16-6	11"	1.3"	1.3"	0.5 lb.	6"
	TIP TYPE		TIP SIZE		SHANK TYPE
ND1/2-3	Hex		1/2"		Round
ND7/16-3	Hex		7/16"		Round
ND3/8-3	Hex		3/8"		Round
ND5/16-3	Hex		5/16"		Round
ND1/4-3	Hex		1/4"		Round
ND9/16-4	Hex		9/16"		Round
ND4.5-3	Hex		4.5mm		Round
ND7-3	Hex		7mm		Round
ND8-3	Hex		8mm		Round
ND1/4-6	Hex		1/4"		Round
ND5/16-6	Hex		5/16"		Round
ND11/32-6	Hex		11/32"		Round
ND3/8-6	Hex		3/8"		Round
ND7/16-6	Hex		7/16"		Round
ND1/2-6	Hex		1/2"		Round
ND9/16-6	Hex		9/16"		Round

MAGNETIC NUT DRIVERS

ND3/16-3M



ND1/4-3M



ND5/16-3M



ND11/32-3M



ND3/8-3M



ND1/2-3M



Get to those hard to reach nuts/bolts with our magnetic hex nut drivers. The hollow shaft fits over long bolts and studs for most applications.

- Comfortable cushion grip handle offers slip resistance and greater torque.
- Internal flanges provide solid, twist-resistant shaft anchor
- Chrome plated shanks are corrosion resistant
- Hollow 3" shafts for additional screw clearance

SPECIFICATIONS

MODEL #	STOCK #	DESCRIPTION		
ND1/4-1-1/2M	583043	1/4" Magnetic Hex Nut Driver with 1-1/2" Shank		
ND3/8-1-1/2M	583045	3/8" Magnetic Hex Nut Driver with 1-1/2" Shank		
ND3/16-3M	583046	3/16" Magnetic Hex Nut Driver with 3" Shank		
ND1/4-3M	583048	1/4" Magnetic Hex Nut Driver with 3" Shank		
ND5/16-3M	587369	5/16" Magnetic Hex Nut Driver with 3" Shank		
ND11/32-3M	587370	11/32" Magnetic Hex Nut Driver with 3" Shank		
ND3/8-3M	587371	3/8" Magnetic Hex Nut Driver with 3" Shank		
ND1/2-3M	587373	1/2" Magnetic Hex Nut Driver with 3" Shank		
ND3/16-6M	587374	3/16" Magnetic Hex Nut Driver with 6" Shank		
ND11/32-6M	587377	11/32" Magnetic Hex Nut Driver with 6" Shank		
ND3/8-6M	587379	3/8" Magnetic Hex Nut Driver with 6" Shank		
ND7/16-6M	587380	7/16" Magnetic Hex Nut Driver with 6" Shank		
ND1/2-6M	587381	1/2" Magnetic Hex Nut Driver with 6" Shank		
	HEIGHT	WIDTH	DEPTH	WEIGHT
ND1/4-1-1/2M	3.71"	1.25"	1.25"	0.05 lb.
ND3/8-1-1/2M	3.71"	1.25"	1.25"	0.05 lb.
ND3/16-3M	6.75"	1.12"	1.12"	0.2 lb.
ND1/4-3M	6.75"	1.12"	1.12"	0.2 lb.
ND5/16-3M	6.75"	1.12"	1.12"	0.2 lb.
ND11/32-3M	6.75"	1.12"	1.12"	0.2 lb.
ND3/8-3M	6.75"	1.12"	1.12"	0.2 lb.
ND1/2-3M	7.375"	1.25"	1.25"	0.3 lb.
ND3/16-6M	9.625"	1.12"	1.12"	0.25 lb.
ND11/32-6M	9.75"	1.12"	1.12"	0.3 lb.
ND3/8-6M	9.75"	1.12"	1.12"	0.3 lb.
ND7/16-6M	10.25"	1.25"	1.25"	0.35 lb.
ND1/2-6M	10.25"	1.25"	1.25"	0.35 lb.
	TIP TYPE	TIP SIZE	SHANK TYPE	SHANK LENGTH
ND1/4-1-1/2M	Hex	1/4"	Round	1.5"
ND3/8-1-1/2M	Hex	3/8"	Round	1.5"
ND3/16-3M	Hex	3/16"	Round	3"
ND1/4-3M	Hex	1/4"	Round	3"
ND5/16-3M	Hex	5/16"	Round	3"
ND11/32-3M	Hex	11/32"	Round	3"
ND3/8-3M	Hex	3/8"	Round	3"
ND1/2-3M	Hex	1/2"	Round	3"
ND3/16-6M	Hex	3/16"	Round	6"
ND11/32-6M	Hex	11/32"	Round	6"
ND3/8-6M	Hex	3/8"	Round	6"
ND7/16-6M	Hex	7/16"	Round	6"
ND1/2-6M	Hex	1/2"	Round	6"

DRIVERS

7-PIECE NUT DRIVER SET

NDSET7



The 7-piece Nut Driver Set has a compact design and is ideal for use in tight spaces and hard-to-reach fasteners.

- Hollow shafts for screw clearance
- Comfortable cushion grip handle offers slip resistance and greater torque
- Seven nut driver sizes for all applications
- Internal flanges provide solid, twist-resistant shaft anchor

SPECIFICATIONS

MODEL #	STOCK #	DESCRIPTION	HEIGHT	WIDTH	DEPTH	WEIGHT	SET INCLUDES
NDSET7	582873	7-Piece Nut Driver Set					
NDSET7	7.5"	1.25"	1.25"	32 oz		3/16", 1/4", 5/16", 11/32", 3/8", 7/16" and 1/2" Nut Drivers w/ 3" Shanks	

2-PIECE MAGNETIC NUT DRIVER SET

NDSET2-6M



2-Piece Magnetic Nut Driver Set with 6" shanks for screw clearance.

- Hollow 6" shaft for screw clearance
- Includes 1/4" and 5/16" magnetic nut drivers
- Handles marked for easy identification
- Cushion grip handles for added comfort and improved torque

SPECIFICATION

MODEL #	STOCK #	DESCRIPTION			
NDSET2-6M	597238	2-piece Magnetic Nut Driver Set			
	HEIGHT	WIDTH	DEPTH	WEIGHT	
NDSET2-6M	4.33"	12.60"	1.18"	0.56 lb.	

2-PIECE STUBBY NUT DRIVER SET

NDSET2-1-1/2



2-Piece Stubby Nut Driver Set is made for 1/4" and 5/16" hex nut and hex screw sizes. Their compact designs are ideal for use in tight spaces and hard-to-reach fasteners.

- Hollow 1-1/2" shaft for screw clearance
- Handles marked for easy identification
- Comfortable cushion grip handle offers slip resistance and greater torque

SPECIFICATIONS

MODEL #	STOCK #	DESCRIPTION				
NDSET2-1-1/2	582865	2-Piece Stubby Nut Driver Set				
	HEIGHT	WIDTH	DEPTH	WEIGHT	SET LENGTH	
NDSET2-1-1/2	3.75"	1.25"	1.25"	3.6 oz	1/4" and 5/16" Nut Driver with 1-1/2" Shanks	

DRIVERS

T-HANDLE HEX KEYS



Designed to efficiently tighten and loosen hex screws.

- T-handle design allows for greater torque application
- Hex key blade - long and short for flexible use
- Forged heavy duty steel blade for durable usage
- Over molded grip for comfortable feel

SPECIFICATIONS

MODEL #	STOCK #	DESCRIPTION			
THEX6-1/2	582878	1/2" T-Handle Hex Key w/ 8" Shank			
THEX6-3/8	582877	3/8" T-Handle Hex Key w/ 6" Shank			
	HEIGHT	WIDTH	DEPTH	WEIGHT	SET LENGTH
THEX6-1/2	9.75"	4.75"	1"	14.5 oz	8"
THEX6-3/8	7.25"	4.75"	1"	8.2 oz	6"

FOLDING HEX KEY SETS

HEX-8



Convenient and reliable, these folding hex key sets will help you get the job done quickly and easily.

- Precision made hex keys reduce slipping and stripping
- Set easily stores in metal case to reduce lost keys and damage
- Strong durable body doubles as a handle

HEX-5



SPECIFICATIONS

MODEL #	STOCK #	DESCRIPTION			
HEX-8	582876	8-Piece Folding Hex Key Set			
HEX-5	582875	5-Piece Folding Hex Key Set			
	HEIGHT	WIDTH	DEPTH	WEIGHT	KEY SIZES
HEX-5	5.25"	1.5"	0.75"	10.8 oz	3/32", 7/64", 1/8", 9/64", 5/32", 3/16", 7/32", & 1/4"
HEX-8	5.25"	1.5"	0.75"	14.3 oz	3/16", 7/32", 1/4", 5/16", & 3/8"

TORPEDO LEVEL

LVLTOR9



This professional grade, hands-free level is perfect for pipe and conduit work.

- Integrated light illuminates vials for better visibility
- Three leveling vials set at 0°, 45°, and 90°
- Lightweight and durable aluminum construction
- Easy-to-read, high impact, acrylic bubble vials
- V-grooved edge helps hold the level in place on pipe or conduit
- Four powerful magnets for hands-free operation
- Requires 2 AAA batteries (not included)

SPECIFICATIONS

MODEL #	STOCK #	DESCRIPTION			
LVLTOR9	582818	9" Torpedo Level			
	HEIGHT	WIDTH	DEPTH	WEIGHT	INCLUDES
LVLTOR9	9"	1.5"	0.75"	8.7 oz	Magnets and lighted vials

CONDUIT BENDING LEVEL

MCBLEVEL



High visibility vials are easy to read and set for measurements at 0°, 30°, 45°, and 90°.

- Set screw secures level to conduit
- Four powerful magnets for hands free operation
- Easy-to-read, high impact, acrylic bubble vials
- V-grooved edge helps hold the level in place on pipe or conduit
- Lightweight and durable aluminum construction

SPECIFICATIONS

MODEL #	STOCK #	DESCRIPTION			
MCBLEVEL	582816	6" Conduit Bending Level			
	HEIGHT	WIDTH	DEPTH	WEIGHT	INCLUDES
MCBLEVEL	6.31"	1.88"	0.63"	4.9 oz	Magnets, thumb screw for attaching to conduit

MEASURING & LEVELS

SPEEDSET™ CONDUIT LEVEL

SS01



Multi-function conduit level: conduit spacer, torpedo level, and dog-leg preventer.

- Equipped with strong magnets for easy leveling
- Create perfect bends every time
- Will easily attach to any 3/4", 1", and 1-1/4" bender head
- Multiple conduit bends exactly the same every time without comparing them to each other

SPECIFICATIONS

MODEL #	STOCK #	DESCRIPTION	HEIGHT	WIDTH	DEPTH	WEIGHT
SS01	582815	SPEEDSET™ Conduit Level				
SS01	0.5"	2.38"	2"	3.2 oz		

25' TAPE MEASURE WITH CONDUIT HOOK

ETAPE



Great for measuring pipe, conduit, sheet metal, siding, drywall and much more.

- Tough, impact resistant case
- Printed scale on the front and back sides of the blade for easier measurements
- Double-sided end hook allows for easier measuring
- Extra-wide, high-visibility blade with oversized scale printed on the front and back
- Nylon coating on blade provides improved durability and corrosion resistance
- Exclusive V-notched bottom allows tape measure to balance on curved surfaces
- Heat-treated spring provides for long life and smooth blade recoil
- Impact-resistant, rubberized case protects end hook and button

SPECIFICATIONS

MODEL #	STOCK #	DESCRIPTION	HEIGHT	WIDTH	DEPTH	WEIGHT	LENGTH
ETAPE	582883	25' Tape Measure with Conduit Hook					
ETAPE	3.13"	3.38"	1.63"	14.7 oz	25'		

TOOL BAGS, POUCHES, & GLOVES

OPEN TOP TOOL BAG

BAGOT15



15" Open Top Tool Bag has a weather protected rubberized bottom and comes with removable dividers so that you may customize the interior compartment to fit your needs. Numerous storage pockets and tool loops allow for ample vertical storage locations. Also features a rotatable handle that can be rotated to the side to allow better access to bag contents.

- Constructed from 1680D ballistic weave for durability
- 3 removable interior organization dividers with 6 pockets and 4 tool loops
- Convenient rotatable handle

SPECIFICATIONS

MODEL #	STOCK #	DESCRIPTION		
BAGOT15	587389	15" Open Top Tool Bag		
	HEIGHT	WIDTH	DEPTH	INTERNAL CAPACITY
BAGOT15	14.75"	15"	9"	1,194 Cubic Inches/19.6 Liters

ELECTRICIAN'S SHOULDER POUCH

BAGESP



Convenient shoulder bag provides a lightweight, durable tool carrier that can be hand-carried, slung over your shoulder, or attached to a belt. Features 16 storage pockets and the patented Flip Lid™ Spill Guard.

- Multiple carrying options: shoulder strap, padded handle, belt loop tunnel
- Constructed from 2400D ballistic weave for durability
- 16 tool storage pockets

SPECIFICATIONS

MODEL #	STOCK #	DESCRIPTION		
BAGESP	587387	Electrician's Shoulder Pouch		
	HEIGHT	WIDTH	DEPTH	INTERNAL CAPACITY
BAGESP	12"	8.5"	6.5"	247 Cubic Inches/4 Liters

TOOL BAGS, POUCHES, & GLOVES

MESSENGER STYLE TOOL BAG

BAGMSGR



Messenger Style Tool Bag is a convenient carrying solution with ample storage capacity. It features easy-to-access internal storage loops and several internal and external mounted zippered pockets.

- Constructed from 2400D ballistic weave for durability
- Grommets on the outer flap for hanging bag
- Padded mesh shoulder straps and breathable EVA padded back offers protection and carrying comfort

SPECIFICATIONS

MODEL #	STOCK #	DESCRIPTION	HEIGHT	WIDTH	DEPTH	INTERNAL CAPACITY
BAGMSGR	587388	Messenger Style Tool Bag				
BAGMSGR			13"	7"	0.25"	708 Cubic Inches/11.6 Liters

TOOL BAGS, POUCHES, & GLOVES

TOOL BAG BACKPACK

BAGBP



Our tool bag backpack allows you to comfortably carry your tools on your back or by hand. Easy opening zippers allow access to the numerous tool storage compartments. Enclosed pouches are located on both external and internal surfaces to provide additional tool storage security.

- Constructed from 2400D ballistic weave for durability
- 58 storage pockets, zippered pouches, and tool loops
- Non-tipping rubber base is wear and water resistant

SPECIFICATIONS

MODEL #	STOCK #	DESCRIPTION		
BAGBP	587384	Tool Bag Backpack		
	HEIGHT	WIDTH	DEPTH	INTERNAL CAPACITY
BAGBP	18"	15"	6"	1,404 Cubic Inches/23 Liters

5-POCKET LEATHER TOOL POUCH

POUCH4



The 5-Pocket Leather Tool Pouch with electrical tape chain is designed for easy storage and tool access.

- Saddle leather resistant to fade and stain
- Washer rivets for extra strength
- Fits belts up to 3" wide

SPECIFICATIONS

MODEL #	STOCK #	DESCRIPTION		
POUCH4	582831	5 Pocket Tool Pouch		
	HEIGHT	WIDTH	DEPTH	MATERIAL
POUCH4	9.25"	7"	3"	Leather

TOOL BAGS, POUCHES, & GLOVES

ELECTRICIAN'S WORK GLOVES

GLOVE1L

High dexterity electrician's gloves with anti-slip fingertips.

- Anti-slip finger tips for secure holding of wire and tools
- Padded palm for protection and secure grip
- Wrapped index finger for durability
- Breathable spandex back for comfortable fit and feel
- Touchscreen compatible index finger and thumb

SPECIFICATIONS

MODEL #	STOCK #	DESCRIPTION
GLOVE1L	587390	Electrician's Work Gloves - Large
PRIMARY MATERIAL		SECONDARY MATERIAL
GLOVE1L	Breathable Spandex	Synthetic Leather



TOOL BAGS, POUCHES, & GLOVES

CANVAS ZIPPER BAG

BAG12

Our canvas zipper bag is a very convenient storage place for pliers, wrenches, and other tools that you use daily.



- Durable, heavy-duty cotton canvas bag
- Sturdy plastic resin zipper

SPECIFICATIONS

MODEL #	STOCK #	DESCRIPTION	HEIGHT	WIDTH	DEPTH	WEIGHT
BAG12	582828	12" Canvas Zipper Bag				
BAG12			12"	7"	0.25"	2 oz

POLYESTER ZIPPERED BAG 4-PACK

BAG4P

Durable heavy duty polyester bags. Perfect for storing pliers, screwdrivers, staples, or electrical connectors.



- 4-pack, durable, heavy duty polyester bags
- Sturdy composite zipper

SPECIFICATIONS

MODEL #	STOCK #	DESCRIPTION	HEIGHT	WIDTH	DEPTH	WEIGHT
BAG4P	597241	Polyester Zippered Bag 4-Pack				
BAG4P			13.25"	7.88"	1"	.35 lb.

CABLE MANAGEMENT

HEAVY DUTY CABLE TIES

CABLE TIES



Easily mount to any standard surface with a screw or nail without splitting the tie itself using the evenly spaced pre-molded holes.

- Offered in 8", 11", and 14" lengths
- 50 & 90 pound tensile strength available
- UV resistant; UL 62275 Plenum Rated , NEMA classification AH-2 (Type 21)
- Molded from 6/6 Nylon
- Working temperature: -40°F (40°C) to 185°F (85°C).

SPECIFICATIONS

MODEL #	STOCK #	DESCRIPTION	PACK	COLOR	LENGTH	BUNDLE SIZE
CT0850100	582982	UVB cable tie 50 lb.	100PK	Black	8"	2"
CT1150100	582983	UVB cable tie 50 lb.	100PK	Black	11"	3"
CT1450100	582984	UVB cable tie 50 lb.	100PK	Black	14"	4"
CT0890100	582985	UVB cable tie 90 lb.	100PK	Black	8"	2"
CT1190100	582986	UVB cable tie 90 lb.	100PK	Black	11"	3"
CT1490100	582987	UVB cable tie 90 lb.	100PK	Black	14"	4"
CT0850015	582988	UVB cable tie 50 lb.	15PK	Black	8"	2"
CT1150015	582989	UVB cable tie 50 lb.	15PK	Black	11"	3"
CT1450015	582990	UVB cable tie 50 lb.	15PK	Black	14"	4"
CT8111412	582991	Sample Pack - Asst.	12PK	Black	8" - 11" - 14"	2-4"

RELEASABLE HEAVY DUTY CABLE TIES



The Releasable Heavy Duty Cable Ties hold tightly and are easy to release. They are UL AH-62275 Plenum Rated, making them ideal in air handling spaces. The releasable cable ties are also UV resistant and come with our patented mounting holes. Perfect for low voltage and general electrical applications.

- Releasable clasps
- Patented mounting holes
- Available in 50 and 90 pound tensile strengths
- 4" max. bundle diameter
- UL 62275 AH-2 Plenum Rated
- UV resistant

SPECIFICATIONS

MODEL #	STOCK #	DESCRIPTION	BUNDLE SIZE
CT0850100R	595069	8" Release Mntd Cable Tie 50 lb. (Burg)100PK	2"
CT1150100R	595070	11" Release Mntd Cable Tie 50 lb. (Burg) 100PK	3"
CT1450100R	595071	14" Release Mntd Cable Tie 50 lb. (Burg) 100PK	4"

MODEL #	LENGTH	TENSILE STRENGTH
CT0850100R	8"	50 lb.
CT1150100R	11"	50 lb.
CT1450100R	14"	50 lb.

CLAMP TIES



Organize, carry, and store cords, ropes, hoses, wire, and more with the Southwire Clamp Tie featuring a 360° rotating handle and easy-release trigger.

- Heavy duty handle for carrying or hanging
- 360° rotating handle built for heavy duty work
- Easy release trigger and flexible tie design

SPECIFICATIONS

MODEL #	STOCK #	DESCRIPTION	PACK QTY	COLOR
CLPT02	582992	2" Clamp Tie	25	Brown
CLPT03	582993	3" Clamp Tie	25	Brown
CLPT04	582994	4" Clamp Tie	20	Brown
CLPT02GR	589732	2" Clamp Tie	25	Green
CLPT03GR	589733	3" Clamp Tie	25	Green
CLPT04GR	589734	4" Clamp Tie	20	Green

KITS & ACCESSORIES

4-PIECE ELECTRICIAN'S TOOL KIT

EKIT-4



Complete with 10-18 AWG wire stripper, 9-in-1 multi-bit screwdriver, high leverage side cutting pliers, and nylon carrying pouch.

10-18 AWG Wire Stripper - Model # S1018STR

- Strips and cuts 10-18 AWG solid and 12-20 AWG stranded wire
- Stainless steel construction is durable and corrosion resistant
- Double-dipped grip provides comfortable fit
- Specially designed stainless steel cutting blades provide fast and clean wire stripping
- Serrated nose grasps the cable for easy twisting and pulling
- Spring loaded for self-opening action
- Not intended for cutting bolts or steel cable

High Leverage Side Cutting Pliers - Model # SCP9

- Induction hardened cutting blades ensure efficient and lasting cutting surfaces for hard and soft wire
- File teeth on jaws help remove burrs in conduit
- Cuts ACSR, screws, nails, and most hardened wire
- Curved handle and ergonomic molded grip for comfortable use
- Drop forged CRV steel for durability

9-in-1 Multi-Bit Screwdriver - Model # SD9N1

- Includes 6 bits and 3 nut drivers for multi-purpose use
- Cushion grip handle for comfortable use and maximum torque application

SPECIFICATIONS

MODEL #	STOCK #	DESCRIPTION			
EKIT-4	US: 591587	4-Piece Electrician's Tool Kit			
EKIT-4	CAD: 591588	4-Piece Electrician's Tool Kit			
	HEIGHT	WIDTH	DEPTH	WEIGHT	INCLUDES
EKIT-4	4.25"	9.75"	2.25"	2.5 oz	S1018STR, SCP9, and SD9N1

CABLE SPLICERS KIT

CSK5



Cable Splicers Kit is ideal for prepping category cable installation.

- Lock holds blades closed for storage
- Serrated lower blades grip wire for non-slip cutting action
- Includes marking pen
- Includes leather carrying pouch
- Includes boot knife for sheathing and removing cable jackets

SPECIFICATIONS

MODEL #	STOCK #	DESCRIPTION		
CSK5	597242	Cable Splicers Kit		
		HEIGHT	WIDTH	DEPTH
CSK5		8.25"	8.63"	12.25"
				WEIGHT
				4.40 lb.



BEKIT-3 BASIC ELECTRICIAN'S KIT

BEKIT-3



The perfect start to your electrical work tool box. These three tools are exactly what you need to get started on any simple electrical work.

- The S1018STR stainless steel wire stripper is rust resistant
- The SD9N1 Multi-Bit Screwdriver includes #1 & #2 Phillips tips, 1/4", 5/16", & 3/8" hex drivers, 3/16" & 1/4" slotted tips, and #1 & #2 square tips
- The 40116N NCV has a detection range of 100-600V AC

SPECIFICATIONS

MODEL #	STOCK #	DESCRIPTION		
BEKIT-3	631368	Basic Electrician's Kit		
		HEIGHT	WIDTH	DEPTH
BEKIT-3		10.25"	7.88"	0.75"
				WEIGHT
				2 lb

KITS & ACCESSORIES

FLEXIBLE LED FLASHLIGHT

FLITE1



A flexible, compact light, designed to illuminate hard-to-reach places.

- 9" flexible cable will bend and hold desired position
- Heavy duty LED light
- On/Off button on cap
- Strong aluminum housing
- Requires 2 AA batteries (not included)

SPECIFICATIONS

MODEL #	STOCK #	DESCRIPTION	HEIGHT	WIDTH	DEPTH	WEIGHT
FLITE1	582829	Flexible LED Light				
FLITE1			14.5"	3.25"	3.25"	3.9 oz

TEST & MEASUREMENT

When there's no room for error, depend on our reliable test and measurement tools to get the job done. Backed by a five year warranty, these tools withstand the elements and provide accurate, versatile, and professional results that every electrician can count on.

- Multimeters
- Clamp Meters
- Voltage Detectors & Testers
- IR Thermometers
- Imaging
- Circuit Testers
- Test Kits



MApp™ MOBILE APP

MAPP™ MOBILE APP



Mobile app for connecting to Southwire Bluetooth® enabled meters.

- View readings from a safe distance right from your mobile phone
- Set up recording sessions
- Add photos and notes to create a detailed report
- Pop-up menu to modify meter settings remotely
- Communicate critical equipment issues by email



MAPP™ | TEST & MEASUREMENT



» VIEW READINGS AND SET UP RECORDING SESSIONS FROM MOBILE DEVICE



» JOB VALIDATION: ADD PHOTOS, NOTES AND GPS LOCATION



» POP-UP MENU MODIFIES METER SETTINGS REMOTELY



» E-MAIL REPORTS TO MAINTENANCE TEAM ON CRITICAL EQUIPMENT ISSUES

MULTIMETER COMPARISON

	15190T	14090T	14070T	14060S	13090T	13070T
BLUETOOTH®	●	●			●	
TrueRMS	●	●	●		●	●
AC/DC VOLTAGE	1000V	1000V	1000V	1000V	600V	600V
LOW-Z		●	●		●	●
AC + DC VOLTAGE	●	●				
AC/DC CURRENT	10A	10A	10A	10A	10A	10A
RESISTANCE	50MΩ	60MΩ	60MΩ	60MΩ	40MΩ	40MΩ
CONTINUITY	●	●	●	●	●	●
DIODE TEST	●	●	●	●	●	●
CAPACITANCE	5000μF	6000μF	6000μF	4000μF	4000μF	4000μF
FREQUENCY	10MHZ	10KHZ	10KHZ	10KHZ	10MHZ	10MHZ
DUTY CYCLE	●	●	●	●	●	●
TEMPERATURE	2462° (1350°C)	1400°F (760°C)	1400°F (760°C)	1400°F (760°C)	1400°F (760°C)	1400°F (760°C)
DISPLAY COUNT	50,000	6000	6000	6000	4000	4000
BACKLIT DISPLAY	COLOR	●	●	●	●	●
BAR GRAPH	●	●	●	●	●	●
NCV (NON-CONTACT AC VOLTAGE)						
WORKLIGHT		●	●	●	●	●
MAX/MIN	●(AVG)	●(AVG)	●(AVG)	●	●	●
PEAK HOLD	●	●	●			
AUTO HOLD						
AUTO POWER OFF	●	●	●	●	●	●
MAGNETIC HANGER	●	●	●	●		
IP67 (WATER/DUST PROOF)		●	●	●	●	●
SAFETY RATING	CAT IV 600V CAT III 1000V	CAT IV 600V CAT III 1000V	CAT IV 600V CAT III 1000V	CAT IV 600V CAT III 1000V	CAT III 600V	CAT III 600V
CARRYING CASE	●	●	●	●	●	●

TEST & MEASUREMENT | Multimeter Table

MULTIMETER COMPARISON

	13050S	16040T	16020N	16030A	10040N	10030S
BLUETOOTH®		•				
TrueRMS		•		•		
AC/DC VOLTAGE	600V	600V	600V	600V	600V	600V
LOW-Z						
AC + DC VOLTAGE						
AC/DC CURRENT	10A	10A	200MA		10A	10A (DC)
RESISTANCE	40MΩ	40MΩ	40MΩ	400KΩ	40MΩ	2000KΩ
CONTINUITY	•	•	•	•	•	•
DIODE TEST	•	•	•		•	•
CAPACITANCE	4000μF	4000μF	100μF		100μF	
FREQUENCY	10MHZ	10KHZ	10KHZ		10MHZ	
DUTY CYCLE	•	•	•		•	
TEMPERATURE	1400°F (760°C)				1400°F (760°C)	
DISPLAY COUNT	4000	4000	4000	4000	4000	2000
BACKLIT DISPLAY	•	•	•	•	•	•
BAR GRAPH	•					
NCV (NON-CONTACT AC VOLTAGE)			•	•	•	
WORKLIGHT	•	•	•	•		
MAX/MIN	•	•				
PEAK HOLD						
AUTO HOLD				•		
AUTO POWER OFF	•	•	•	•	•	
MAGNETIC HANGER						
IP67 (WATER/DUST PROOF)	•			•		
SAFETY RATING	CAT III 600V	CAT III 600V	CAT IV 600V	CAT IV 600V	CAT III 600V	CAT III 300V CAT III 600V

CLAMP METER COMPARISON

	23090T	23070T	23030T	22070T	21050T	21030T	21010N
BLUETOOTH®	●						
TrueRMS	●	●	●	●	●	●	
AC CURRENT	1000A	1000A	1000A	1000A	400A	400A	400A
DC CURRENT	1000A	1000A		1000A	400A		
AC + DC VOLTAGE	1000V	1000V	1000V	600V	600V	600V	600V
RESISTANCE	50MΩ	60MΩ	60MΩ	60MΩ	40MΩ	40MΩ	40MΩ
CONTINUITY	●	●	●	●	●	●	●
DIODE TEST	●	●	●	●	●	●	●
CAPACITANCE	5mF	6000μF	6000μF	4000μF	100μF	100μF	100μF
FREQUENCY	10MHZ	10MHZ	10MHZ	10KHZ	10KHZ	10KHZ	10KHZ
DUTY CYCLE	●	●	●	●	●	●	●
TEMPERATURE	1832°F (1000°C)	1400°F (760°C)	1400°F (760°C)	1400°F (760°C)	1400°F (760°C)	1400°F (760°C)	1400°F (760°C)
DISPLAY COUNT	50,000	6000	6000	6000	4000	4000	4000
BACKLIT DISPLAY	●	●	●	●	●	●	
BAR GRAPH	●	●	●	●			
NCV (NON-CONTACT AC VOLTAGE)	●	●	●	●	●	●	●
WORKLIGHT	●	●	●				
INRUSH	●						
MAX/MIN	●	●	●	●			
PEAK HOLD	●						
AUTO POWER OFF	●	●	●	●	●	●	●
SAFETY RATING	CAT IV 600V CAT III 1000V	CAT IV 600V CAT III 1000V	CAT IV 600V CAT III 1000V	CAT III 600V	CAT III 600V	CAT III 600V	CAT III 600V
CARRYING CASE	●	●	●	●	●	●	●

TEST & MEASUREMENT | Multimeter Table

NON-CONTACT VOLTAGE COMPARISON

	40116N	40126N	40136N	40150N
SAFETY CATEGORY	CAT IV 600V	CAT IV 600V	CAT IV 600V	CAT IV 600V
FORWARD FACING LIGHT				X
REAR FACING WORLIGHT	X	X	X	X
LOW VOLTAGE MODE		X		X
WATERPROOF (IP67)				X
DROP RATING	6FT	6ft	6FT	6ft
ON/OFF BUTTON	X	X	X	X
LOW BATTERY & SELF TEST	X	X	X	X
AUTO POWER OFF	X	X	X	X
SILENT MODE			X	X
VARIABLE BEEP RATE				X
AC DETECTION RANGE	100V-600V	24V-600V 100V-600V	50V-600V	12V-1000V 100V-1000V
FREQUENCY RANGE	50HZ/60HZ	50Hz/60Hz	50HZ/60HZ	50Hz/60Hz

MAINTENANCEPRO™ DATA LOGGING CAT IV MULTIMETER

15190T



Southwire's new Bluetooth® enabled 15190T MaintenancePRO™ multimeter and MApp™ mobile app are taking test and measurement to a whole new level. When used together, this system provides one of the safest and most convenient ways for electrical professionals to get the job done.

- Features automatic power off
- Bluetooth® interface for downloading, viewing, recording and sharing using Southwire's Mapp™ mobile app
- Onboard memory allows data logging even when Bluetooth™ wireless is not connected
- Hi-Res color display with graphing feature
- On board memory for saving and viewing measurements and recordings
- Intuitive Menu navigated by function keys
- Use as stand-alone unit or pair to cell phone via Bluetooth™ and MApp™ mobile app
- Rugged meter with CAT IV 600V/CAT III 1000V safety rating, UL listed
- Includes
 - Test leads
 - Type K temperature probe with banana plug adapter
 - Magnetic hanging strap
 - Canvas bag
 - Rechargeable Li-ion battery and battery charger

SPECIFICATIONS

MODEL #	STOCK #	DESCRIPTION		
15190T	596865	MaintenancePRO™ Data Logging CAT IV Multimeter		
FUNCTION	RANGE	MAX. RESOLUTION	MAX. ACCURACY (% OF READING)	
AC Voltage	1000V	0.01mV	±0.5%	
DC Voltage	1000V	0.01mV	±0.1%	
AC + DC Voltage	1000V	0.1mV	±1.2%	
AC Current	10A	0.01µA	±0.8%	
DC Current	10A	0.01µA	±0.2%	
Resistance	50MΩ	0.01Ω	±0.2%	
Capacitance	5000µF	1pF	±1.5%	
Frequency	10MHz	0.001Hz	±0.01%	
Duty Cycle	0.1 to 99.9%	0.01%	±1.2%	
Temperature	-328°F to 2462°F	0.1°	±1.0%	
	-200°C to 1350°C	0.1°	±1.0%	
Continuity	Audible threshold approx. 30Ω			
Diode Test	Yes			
Dimensions	6.6 x 3.1 x 2 in.			
Weight	0.90 lb.			

MULTIMETERS

TECHNICIANPRO™ BLUETOOTH® CAT IV MULTIMETER

14090T



This Bluetooth® enabled multimeter in combination with Southwire's MApp™ mobile app allows you to view, record, and share readings on your smartphone. It is designed for demanding environments. Features include a CAT IV safety rating, a rugged IP67 waterproof and dust tight housing, TrueRMS and Low-Z readings, backlit controls, and a powerful built-in work light.

- Features automatic power off
- Bluetooth® interface for viewing, recording and sharing using Southwire's MApp™ mobile app
- Lighted controls and backlit display allow use in dimly lit areas
- TrueRMS readings provide higher accuracy on AC circuits
- Low-Z function eliminates false readings from "ghost" voltage
- Includes magnetic hanging strap for hands-free operation
- Powerful LED work light for added convenience
- CAT IV 600V/CAT III 1000V safety rating and IP67 waterproof and dust tight housing
- Includes
 - Test leads
 - Type K temperature probe with banana plug adapter
 - Magnetic hanging strap
 - Carrying case
 - Four AAA batteries

SPECIFICATIONS

MODEL #	STOCK #	DESCRIPTION	
14090T	630184	TechnicianPRO™ Bluetooth® CAT IV Multimeter	
FUNCTION	RANGE	MAX. RESOLUTION	MAX. ACCURACY (% OF READING)
AC Voltage	1000V	1mV	±1.0%
Low-Z (AC Voltage)	600V	1mV	±3.0%
DC Voltage	1000V	0.1mV	±0.9%
Low-Z (DC Voltage)	600V	0.1mV	±3.0%
AC + DC Voltage	1000V	1mV	±2.0%
AC Current	10A	0.1µA	±1.0%
DC Current	10A	0.1µA	±1.0%
Resistance	60MΩ	0.1Ω	±1.5%
Capacitance	6000µF	10pF	±3.0%
Frequency	10kHz	0.001Hz	±1.0%
Duty Cycle	20 to 80%	0.1%	±1.2%
Temperature	-4°F to 1400°F	0.1°	±1.5%
	-20°C to 780°C	0.1°	±1.5%
Continuity	Audible threshold approx. 50Ω		
Diode Test	Yes		
Dimensions	6.7 x 3.0 x 1.9 in.		
Weight	0.85 lb.		

TECHNICIANPRO™ TRUERMS CAT IV MULTIMETER

14070T



This built-tough multimeter offers a CAT IV safety rating and an IP67 waterproof and dust tight housing. With TrueRMS readings, a Low-Z measurement function, backlit controls, and a powerful built-in work light, it has the features needed for the professional electrician.

- Features automatic power off
- Lighted controls and backlit display allow use in dimly lit areas
- Low-Z function eliminates false readings from "ghost" voltage
- TrueRMS readings provide higher accuracy on AC circuits
- Includes magnetic hanging strap for hands free operation
- Powerful LED work light for added convenience
- CAT IV 600V/CAT III 1000V safety rating and IP67 waterproof and dust tight housing
- Built-in test lead storage
- Includes
 - Test leads
 - Type K temperature probe with banana plug adapter
 - Magnetic hanging strap
 - Carrying case
 - Four AAA batteries

SPECIFICATIONS

MODEL #	STOCK #	DESCRIPTION	
14070T	630182	TechnicianPRO™ TrueRMS CAT IV Multimeter	
FUNCTION	RANGE	MAX. RESOLUTION	MAX. ACCURACY (% OF READING)
AC Voltage	1000V	1mV	±1.0%
Low-Z (AC Voltage)	600V	1mV	±3.0%
DC Voltage	1000V	0.1mV	±1.0%
Low-Z (DC Voltage)	600V	0.1mV	±3.0%
AC Current	10A	0.1µA	±1.5%
DC Current	10A	0.1µA	±1.0%
Resistance	60MΩ	0.1Ω	±1.5%
Capacitance	6000µF	10pF	±3.0%
Frequency	10kHz	0.001Hz	±1.0%
Duty Cycle	20 to 80%	0.1%	±1.2%
Temperature	-4°F to 1400°F	0.1°	±2.0%
	-20°C to 780°C	0.1°	±2.0%
Continuity	Audible threshold approx. 50Ω		
Diode Test	Yes		
Dimensions	6.7 x 3.0 x 1.9 in.		
Weight	0.85 lb.		

MULTIMETERS

TECHNICIANPRO™ AUTO RANGING CAT IV MULTIMETER

14060S



This built-tough multimeter offers a CAT IV safety rating and an IP67 waterproof and dust tight housing. With 11 measuring functions, backlit controls, and a powerful built-in work light, it's fully equipped for a wide range of applications.

- Features automatic power off
- 11 measuring functions plus MAX/MIN
- Lighted controls and backlit display allow use in dimly lit areas
- Powerful LED work light for added convenience
- Includes magnetic hanging strap for hands free operation
- Rugged IP67 waterproof and dust tight housing
- CAT IV 600V/CAT III 1000V safety rating, UL listed
- Built-in test lead storage
- Includes
 - Test leads
 - Type K temperature probe with banana plug adapter
 - Magnetic hanging strap
 - Carrying case
 - Four AAA batteries

SPECIFICATIONS

MODEL #	STOCK #	DESCRIPTION	
14060S	630287	TechnicianPRO™ Auto-ranging CAT IV Multimeter	
FUNCTION	RANGE	MAX. RESOLUTION	MAX. ACCURACY (% OF READING)
AC Voltage	1000V	1mV	±1.0%
DC Voltage	1000V	0.1mV	±1.0%
AC Current	10A	0.1µA	±1.5%
DC Current	10A	0.1µA	±1.0%
Resistance	60MΩ	0.1Ω	±1.5%
Capacitance	4000µF	10pF	±3.0%
Frequency	10kHz	0.001Hz	±1.0%
Duty Cycle	1 to 99.9%	0.1%	±1.2%
Temperature	-4°F to 1400°F	0.1°	±3.0%
	-20°C to 780°C	0.1°	±3.0%
Continuity	Audible threshold approx. 30Ω		
Diode Test	Yes		
Dimensions	6.7 x 3.0 x 1.9 in.		
Weight	0.85 lb.		

Multimeters | TEST & MEASUREMENT

RESIDENTIALPRO™ BLUETOOTH® CAT III MULTIMETER

13090T



This Bluetooth® enabled multimeter in combination with Southwire's MApp™ mobile app allows you to view, record, and share readings on your smartphone. With TrueRMS and Low-Z readings, a rugged waterproof and dust proof housing, and built-in flashlight, this compact multimeter can be used in a wide range of applications.

- Features automatic power off
- Bluetooth® interface for viewing, recording and sharing using Southwire's MApp™ mobile app
- TrueRMS readings provide higher accuracy on AC circuits
- Low-Z function eliminates false readings from "ghost" voltage
- Powerful LED work light for added convenience
- Rugged IP67 waterproof and dust tight housing
- CAT III 600V safety rating, UL listed
- Built-in test lead storage
- Includes
 - Test leads
 - Type K temperature probe with banana plug adapter
 - Three AAA batteries

SPECIFICATIONS

MODEL #	STOCK #	DESCRIPTION	
13090T	630160	ResidentialPRO™ Bluetooth® CAT III Multimeter	
FUNCTION	RANGE	MAX. RESOLUTION	MAX. ACCURACY (% OF READING)
AC Voltage	600V	1mV	±1.0%
Low-Z (AC Voltage)	300V	1mV	±1.5%
DC Voltage	600V	0.1mV	±1.0%
Low-Z (DC Voltage)	300V	0.1mV	±1.5%
AC Current	10A	1mA	±2.5%
DC Current	10A	1mA	±2.0%
Resistance	40MΩ	0.1Ω	±1.5%
Capacitance	4000μF	10pF	±3.0%
Frequency	10kHz	0.001Hz	±1.0%
Duty Cycle	1.0 to 99.9%	0.1%	±1.2%
Temperature	0°F to 1400°F	0.1°	±2.0%
	-18°C to 760°C	0.1°	±2.0%
Continuity	Audible threshold: approx. 50Ω		
Diode Test	Yes		
Dimensions	5.8 x 2.7 x 2.0 in.		
Weight	0.70 lb.		

MULTIMETERS

RESIDENTIALPRO™ TRUERMS CAT III MULTIMETER

13070T



With 11 measurement functions including TrueRMS readings, Low-measurement features, and a rugged waterproof and dust proof housing, this compact multimeter has the features needed to get the job done. A built-in flashlight provides added convenience.

- Features automatic power off
- TrueRMS readings provide higher accuracy on AC circuits
- Low-Z function eliminates false readings from "ghost" voltage
- 11 measuring functions plus MAX/MIN
- Powerful LED work light for added convenience
- Rugged IP67 waterproof and dust tight housing
- CAT III 600V safety rating, UL listed
- Built-in test lead storage
- Includes
 - Test leads
 - Type K temperature probe with banana plug adapter
 - Three AAA batteries

SPECIFICATIONS

MODEL #	STOCK #	DESCRIPTION	
13070T	630150	ResidentialPRO™ TrueRMS CAT III Multimeter	
FUNCTION	RANGE	MAX. RESOLUTION	MAX. ACCURACY (% OF READING)
AC Voltage	600V	1mV	±1.5%
Low-Z (AC Voltage)	300V	1mV	±1.5%
DC Voltage	600V	0.1mV	±0.8%
Low-Z (DC Voltage)	300V	0.1mV	±0.8%
AC Current	10A	1mA	±3.0%
DC Current	10A	1mA	±2.5%
Resistance	40MΩ	0.1Ω	±1.2%
Capacitance	4000μF	10pF	±3.0%
Frequency	10kHz	0.001Hz	±1.2%
Duty Cycle	0.1 to 99.9%	0.1%	±1.2%
Temperature	-4°F to 1400°F	0.1°	±3.0%
	-20°C to 760°C	0.1°	±3.0%
Continuity	Audible threshold approx. 40Ω		
Diode Test	Yes		
Dimensions	5.8 x 2.7 x 2.0 in.		
Weight	0.70 lb.		

RESIDENTIALPRO™ AUTO RANGING CAT III MULTIMETER

13050S



With 11 measuring functions, an easy-to-read backlit display, and a rugged IP67 waterproof and dust proof housing, this compact multimeter is perfect for general use. A built-in flashlight provides added convenience.

- Features automatic power off
- 11 Measuring functions plus MAX/MIN
- Backlit 4,000-count display with bar graph
- Powerful LED work light for added convenience
- Rugged IP67 waterproof and dust tight housing
- CAT III 600V safety rating UL listed
- Built-in test lead storage
- Includes
 - Test leads
 - Type K temperature probe with banana plug adapter
 - Three AAA batteries

SPECIFICATIONS

MODEL #	STOCK #	DESCRIPTION	
13050S	630145	ResidentialPRO™ Auto ranging CAT III Multimeter	
FUNCTION	RANGE	MAX. RESOLUTION	MAX. ACCURACY (% OF READING)
AC Voltage	600V	1mV	±1.5%
DC Voltage	600V	0.1mV	±0.8%
AC Current	10A	1mA	±3.0%
DC Current	10A	1mA	±3.0%
Resistance	40MΩ	0.1Ω	±1.2%
Capacitance	4000μF	10pF	±3.0%
Frequency	10kHz	0.001Hz	±1.2%
Duty Cycle	0.1 to 99.9%	0.1%	±1.2%
Temperature	-4°F to 1400°F	0.1°	±3.0%
	-20°C to 760°C	0.1°	±3.0%
Continuity	Audible threshold approx. 50Ω		
Diode Test	Yes		
Dimensions	5.8 x 2.7 x 2.0 in.		
Weight	0.70 lb.		

MULTIMETERS

COMPACT BLUETOOTH® CAT III MULTIMETER

16040T



This compact Bluetooth® enabled multimeter in combination with Southwire's MApp™ mobile app allows you to view, record, and share readings on your smartphone. With TrueRMS readings and 10 measuring functions, it can be used in a wide range of applications.

- Features automatic power off
- Bluetooth® interface for viewing, recording and sharing readings using Southwire's MApp™ mobile app
- TrueRMS readings provide higher accuracy on AC circuits
- 10 measuring functions plus MAX/MIN
- Powerful LED work light for added convenience
- Rugged double-molded housing
- CAT III 600V safety rating, UL listed
- Built-in test lead storage
- Includes
 - Test leads
 - Two AAA batteries

SPECIFICATIONS

MODEL #	STOCK #	DESCRIPTION		
16040T	630194	Compact Bluetooth® CAT III Multimeter		
FUNCTION	RANGE	MAX. RESOLUTION	MAX. ACCURACY (% OF READING)	
AC Voltage	600V	1mV	±1.0%	
DC Voltage	600V	0.1mV	±1.0%	
AC Current	10A	0.1µA	±2.0%	
DC Current	10A	0.1µA	±1.0%	
Resistance	40MΩ	0.1Ω	±1.0%	
Capacitance	4000µF	10pF	±3.0%	
Frequency	10kHz	0.001Hz	±1.0%	
Duty Cycle	20 to 80%	0.1%	±1.2%	
Continuity	Audible threshold approx. 50Ω			
Diode Test	Yes			
Dimensions	4.8 x 2.6 x 1.4 in.			
Weight	0.32 lb.			

AUTOSELECTING CAT IV MULTIMETER

16030A



Easy-to-use TrueRMS CAT IV multimeter automatically selects AC or DC voltage when connected to live circuits. Added features include a rugged IP67 waterproof and dust tight housing, a built-in flashlight and non-contact AC voltage detector, and auto hold for fast touch-and-hold readings.

- Features automatic power off
- Automatically selects AC or DC voltage
- Auto hold function for quick touch and hold readings
- TrueRMS readings provide higher accuracy on AC circuits
- Easy-to-read 4,000-count backlit display
- Built-in, non-contact AC voltage detector and powerful work light
- Rugged IP67 waterproof/dust tight housing
- CAT IV 600V safety rating, UL listed
- Built-in test lead storage
- Includes
 - Test leads
 - Two AAA batteries

SPECIFICATIONS

MODEL #	STOCK #	DESCRIPTION	
16030A	630191	Autoselecting CAT IV Multimeter	
FUNCTION	RANGE	MAX. RESOLUTION	MAX. ACCURACY (% OF READING)
AC Voltage	600V	0.1V	±1.0%
DC Voltage	600V	0.1V	±1.0%
Non-Contact AC Voltage	100 to 600V AC	—	—
Resistance	400kΩ	0.1Ω	±2.0%
Continuity	Audible threshold approx. 50Ω		
Dimensions	5.5 x 3.0 x 1.6 in.		
Weight	0.50 lb.		

MULTIMETERS

COMPACT 3-IN-1 CAT IV MULTIMETER

16020N



Designed for the electrician on the go, this compact CAT IV 3-in-1 combination multimeter with built-in flashlight and non-contact AC voltage detector is a great fit for a crowded tool bag.

- Features automatic power off
- 3-in-1 Combination: multimeter, work light and non-contact AC voltage detector
- Compact size with integrated test leads is perfect for crowded tool bag
- 10 measuring functions
- Fuse automatically resets itself
- Rugged double-molded housing
- CAT IV 600V safety rating, UL listed
- Built-in test lead storage
- Includes:
 - Multimeter with integrated test leads
 - Two AAA batteries

SPECIFICATIONS

MODEL #	STOCK #	DESCRIPTION	
16020N	630186	Compact 3-in-1 CAT IV Multimeter	
FUNCTION	RANGE	MAX. RESOLUTION	MAX. ACCURACY (% OF READING)
AC Voltage	600V	0.1mA	± 1.0%
DC Voltage	600V	0.1mA	± 0.5%
Non-Contact AC Voltage	100 to 600V AC	—	—
AC Current	200mA	0.1µA	±2.5%
DC Current	200mA	0.1µA	±2.0%
Resistance	40MΩ	0.1Ω	±0.8%
Capacitance	100µF	10pF	±3.0%
Frequency	10kHz	0.001Hz	±2.0%
Duty Cycle	0.5 to 99%	0.1%	±2.0%
Continuity	Audible threshold approx. 100Ω		
Diode Test	Yes		
Dimensions	4.6 x 2.3 x 1.4 in.		
Weight	0.32 lb.		

AUTO-RANGING MULTIMETER

10040N



This compact multimeter is the perfect fit for the crowded tool bag. Features include a CAT III safety rating, built-in non-contact AC voltage (NCV) detector, and capacitance and temperature functions.

- Features automatic power off
- 12 Functions including: capacitance, frequency, duty cycle, and temperature
- Built-in, non-contact AC voltage detector
- Easy-to-read, backlit, 4,000-count digital display
- Impact resistant double-molded housing also provides comfortable grip
- CAT III 600V safety rating, UL listed
- Includes:
 - Test leads
 - Type K temperature probe with banana plug adapter
 - 9 volt battery

SPECIFICATIONS

MODEL #	STOCK #	DESCRIPTION	
10040N	582910	Auto-Ranging Multimeter	
	RANGE	MAX. RESOLUTION	MAX. ACCURACY (% OF READING)
AC Voltage	600V	1.0mV	±1.2%
DC Voltage	600V	0.1mV	±0.5%
NCV (Non-Contact AC Voltage)	100 to 600V	-	-
AC Current	10A	0.1µA	±1.5%
DC Current	10A	0.1µA	±1.0%
Resistance	40MΩ	0.1Ω	±1.0%
Capacitance	100µF	10pF	±3.0%
Frequency	10MHz	0.001Hz	±1.2%
Duty Cycle	99.9%	0.1%	±1.2%
Temperature	-4 to 1400°F -20 to 760°C	0.1°F 0.1°C	±3.0% ±3.0%
Continuity	Audible threshold approx. 30Ω		
Diode Test	Yes		
Dimensions	5.4 x 2.7 x 1.5 in.		
Weight	0.46 lb.		



MULTIMETERS

MANUAL RANGING MULTIMETER

10030S



This general purpose multimeter features a CAT III safety rating, rugged double-molded housing, and a backlit display.

- 7 functions with 20 ranges:
 - AC Voltage
 - DC Voltage
 - DC Current,
 - Resistance
 - Battery Test
 - Continuity
 - Diode Test
- Tests AAA, AA, C, D, and 9 volt batteries
- Impact resistant double-molded housing also provides comfortable grip
- Easy-to-read, backlit digital display
- CAT III 300V/CAT II 600V safety rating, UL listed
- Includes:
 - Test leads
 - 9 volt battery

SPECIFICATIONS

MODEL #	STOCK #	DESCRIPTION		
10030S	582908	Manual Ranging Multimeter		
	RANGE	MAX. RESOLUTION	MAX. ACCURACY (% OF READING)	
AC Voltage:	600V	0.1V	±1.2%	
DC Voltage:	600V	0.1mV	±0.5%	
DC Current:	10A	1µA	±1.0%	
Resistance:	2000kΩ	0.1Ω	±0.8%	
Battery Test:	1.5V and 9V	10mV	±1.0%	
Continuity:	Audible threshold approx. 30Ω			
Diode Test:	Yes			
Dimensions:	5.9 x 2.8 x 1.9 in.			
Weight:	0.56 lb.			



Test in low-light areas



MAINTENANCEPRO™ SMART 1000A CLAMP METER

23090T



Southwire's new MaintenancePRO™ 23090T adds Bluetooth® connectivity to a rugged, high-end clamp meter. Used with our MApp™ mobile app, the 23090T lets electricians safely get the measurements they need even in hostile environments. The app can be used to view readings, set up recording sessions, and assemble complete reports right from your mobile phone. The feature set of the 23090T make this the optimal choice for the professional electrician.

- Features automatic power off
- Bluetooth® interface for viewing, saving and sharing using Southwire's MApp™ mobile app
- Inrush function captures motor start-up current
- 11 measuring functions, plus MAX/MIN
- Precision TrueRMS meter
- Hi-Res 50,000-count backlit display with bargraph
- Built-in, non-contact AC voltage detector and powerful LED work light
- Rugged meter with CAT IV 600V / CAT III 1000V safety rating, UL listed
- Includes:
 - Test leads
 - Type K temperature probe with banana plug adapter
 - Carrying case
 - 9 volt battery

SPECIFICATIONS

MODEL #	STOCK #	DESCRIPTION	
23090T	596868	MaintenancePRO™ Bluetooth® 1000A Clamp Meter	
FUNCTION	RANGE	MAX. RESOLUTION	MAX. ACCURACY (% OF READING)
AC Current	1000A	10mA	±2.5%
DC Current	1000A	10mA	±2.5%
Jaw Opening	1.9" (48mm)	—	—
AC Voltage	1000V	0.01mV	±1.0%
DC Voltage	1000V	0.01mV	±1.0%
Non-Contact AC Voltage	110 to 1000V AC	—	—
Resistance	50MΩ	0.01Ω	±1.0%
Capacitance	5mF	10pF	±3.5%
Frequency	10MHz	0.001Hz	±0.3%
Duty Cycle	5 to 95%	0.01%	±1.0%
Temperature	-148°F to 1832°F	0.1°	±1.0%
	-100°C to 1000°C	0.1°	±1.0%
Continuity	Audible threshold approx. 50Ω		
Diode Test	Yes		
Dimensions	9.0 x 3.0 x 1.6 in.		
Weight	0.69 lb.		

TEST & MEASUREMENT | Clamp Meters

CLAMP METERS

MAINTENANCEPRO™ 1000A AC/DC CLAMP METER

23070T



The MaintenancePRO™ 23070T clamp meter is a rugged, high-end AC/DC clamp meter for the professional electrician who needs both AC and DC current measurements. With a UL listed safety rating of CAT IV 600V/CAT III 1000V, this clamp meter is built to get the tough jobs done.

- Features automatic power off
- 11 measuring functions plus MAX/MIN
- TrueRMS readings provide higher accuracy on AC circuits
- Measures both AC and DC current
- Built-in, non-contact AC voltage detector and powerful LED work light
- 6,000-count backlit display with bar graph
- Rugged meter with CAT IV 600V/CAT III 1000V safety rating, UL listed
- Includes:
 - Test leads
 - Type K temperature probe with banana plug adapter
 - Carrying case
 - 9 volt battery

SPECIFICATIONS

MODEL #	STOCK #	DESCRIPTION	
23070T	596867	MaintenancePRO™ 1000A AC/DC Clamp Meter	
FUNCTION	RANGE	MAX. RESOLUTION	MAX. ACCURACY (% OF READING)
AC Current	1000A	10mA	±2.5%
DC Current	1000A	10mA	±2.5%
Jaw Opening	1.9" (48mm)	—	—
AC Voltage	1000V	1mV	±1.5%
DC Voltage	1000V	0.1mV	±1.0%
Non-Contact AC Voltage	100 to 1000V AC	—	—
Resistance	60MΩ	0.1Ω	±1.0%
Capacitance	6000μF	10pF	±3.0%
Frequency	10MHz	0.001Hz	±1.0%
Duty Cycle	0.5 to 99.9%	0.01%	±1.2%
Temperature	-4°F to 1400°F	0.1°	±3.0%
	-20°C to 760°C	0.1°	±3.0%
Continuity	Audible threshold approx. 50Ω		
Diode Test	Yes		
Dimensions	9.0 x 3.0 x 1.6 in.		
Weight	0.69 lb.		

MAINTENANCEPRO™ 1000A AC CLAMP METER

23030T



The MaintenancePRO™ 23030T clamp meter is a rugged, high-end AC clamp meter. With a UL listed safety rating of CAT IV 600V/CAT III 1000V, this clamp meter is built to get the tough jobs done. The feature set of the 23030T make it the new standard in residential, commercial, and maintenance clamp meters.

- Features automatic power off
- 10 measuring functions plus MAX/MIN
- TrueRMS readings provide higher accuracy on AC circuits
- Powerful LED work light for added convenience
- Built-in, non-contact AC voltage detector
- 6,000-count backlit display with bar graph
- Rugged meter with CAT IV 600V/CAT III 1000V safety rating, UL listed
- Includes:
 - Test leads
 - Type K temperature probe with banana plug adapter
 - Carrying case
 - 9 volt battery

SPECIFICATIONS

MODEL #	STOCK #	DESCRIPTION	
23030T	596866	MaintenancePRO™ 1000A AC Clamp Meter	
FUNCTION	RANGE	MAX. RESOLUTION	MAX. ACCURACY (% OF READING)
AC Current	1000A	10mA	±2.5%
Jaw Opening	1.9" (48mm)	—	—
AC Voltage	1000V	1mV	±1.5%
DC Voltage	1000V	0.1mV	±1.0%
Non-Contact AC Voltage	100 to 1000V AC	—	—
Resistance	60MΩ	0.1Ω	±1.0%
Capacitance	6000μF	10pF	±3.0%
Frequency	10MHz	0.001Hz	±1.0%
Duty Cycle	0.5 to 99.9%	0.01%	±1.2%
Temperature	-4°F to 1400°F	0.1°	±3.0%
	-20°C to 760°C	0.1°	±3.0%
Continuity	Audible threshold approx. 50Ω		
Diode Test	Yes		
Dimensions	9.0 x 3.0 x 1.6 in.		
Weight	0.69 lb.		

CLAMP METERS

1000A AC/DC TRUERMS CLAMP METER

22070T



1000A AC/DC clamp meter combines the features needed for the professional electrician including TrueRMS readings, a built-in non-contact AC voltage detector, multimeter, capacitance and temperature functions.

- Features automatic power off
- 11 measuring functions plus Max/Min
- TrueRMS for accurate AC voltage and current readings
- Measures both AC and DC current
- Built-in, non-contact AC voltage detector
- Easy-to-read, backlit, 6,000-count digital display with bar graph
- Impact resistant double-molded housing provides comfortable grip
- CAT III 600V safety rating, UL listed
- Includes:
 - Test leads
 - Type K temperature probe with banana plug adapter
 - Carrying case
 - 9 volt battery



SPECIFICATIONS

MODEL #	STOCK #	DESCRIPTION		
22070T	582903	1000A TrueRMS AC/DC Clamp Meter		
FUNCTION	RANGE	MAX. RESOLUTION	MAX. ACCURACY (% OF READING)	
AC Current	1000A	0.1A	±2.8%	
DC Current	1000A	0.1A	±2.8%	
Jaw Opening	1.5" (40mm)	—		
AC Voltage	600V	1mV	±1.8%	
DC Voltage	600V	0.1mV	±0.8%	
Non-Contact AC Voltage	100 to 600V AC	—		
Resistance	60MΩ	0.1Ω	±1.0%	
Capacitance	4000μF	10pF	±3.0%	
Frequency	10kHz	0.001Hz	±1.5%	
Duty Cycle	0.5 to 99%	0.1%	±1.2%	
Temperature	-4°F to 1400°F	0.1°	±3.0%	
	-20°C to 760°C	0.1°	±3.0%	
Continuity	Audible threshold < 30Ω with beeper on, Audible threshold > 150Ω with beeper off			
Diode Test	Yes			
Dimensions	9.1 x 3.0 x 1.5 in.			
Weight	0.60 lb.			

400A AC/DC TRUERMS CLAMP METER

21050T



The 21050T is a feature-packed TrueRMS AC/DC compact clamp meter. TrueRMS is especially valuable for current measurements on circuits with harmonic distortion. The addition of DC current testing makes this even more versatile than the 21030T.

- Features automatic power off
- 11 measuring functions including capacitance, frequency, duty cycle, and temperature
- TrueRMS for accurate AC voltage and current readings
- Measures both AC and DC current
- Built-in, non-contact AC voltage detector
- Easy-to-read, backlit, 4,000-count digital display
- Impact resistant double-molded housing provides comfortable grip
- CAT III 600V safety rating, UL listed
- Includes:
 - Test leads
 - Type K temperature probe with banana plug adapter
 - Carrying case
 - Two AAA batteries



SPECIFICATIONS

MODEL #	STOCK #	DESCRIPTION		
21050T	582902	400A TrueRMS AC/DC Clamp Meter		
FUNCTION	RANGE	MAX. RESOLUTION	MAX. ACCURACY (% OF READING)	
AC Current	400A	10mA	±2.8%	
DC Current	400A	10mA	±2.5%	
Jaw Opening	1.2" (30mm)	—	—	
AC Voltage	600V	1mV	±1.5%	
DC Voltage	600V	0.1mV	±0.8%	
Non-Contact AC Voltage	100 to 600V AC	—	—	
Resistance	40MΩ	0.1Ω	±1.0%	
Capacitance	100μF	10pF	±3.0%	
Frequency	10kHz	0.001Hz	±1.5%	
Duty Cycle	0.5 to 99%	0.1%	±1.2%	
Temperature	-4°F to 1400°F	0.1°	±3.0%	
	-20°C to 760°C	0.1°	±3.0%	
Continuity	Audible threshold < 30Ω with beeper on, Audible threshold > 150Ω with beeper off			
Diode Test	Yes			
Dimensions	7.9 x 2.6 x 1.5 in.			
Weight	0.45 lb.			

CLAMP METERS

400A AC TRUE RMS CLAMP METER

21030T



The 21030T has all the features of the 21010N, plus TrueRMS for accuracy and a backlit LCD screen for better visibility in dark work environments.

- Features automatic power off
- 10 measuring functions including capacitance, frequency, duty cycle, and temperature
- TrueRMS for accurate AC voltage and current readings
- Built-in, non-contact AC NCV detector
- Easy-to-read, backlit, 4,000-count digital display
- Impact resistant double-molded housing also provides comfortable grip
- CAT III 600V safety rating, UL listed
- Includes:
 - Test leads
 - Type K temperature probe with banana plug adapter
 - Carrying case
 - Two AAA batteries



SPECIFICATIONS

MODEL #	STOCK #	DESCRIPTION	
21030T	582901	400A TrueRMS AC Clamp Meter	
FUNCTION	RANGE	MAX. RESOLUTION	MAX. ACCURACY (% OF READING)
AC Current	400A	10mA	±2.8%
Jaw Opening	1.2" (30mm)	—	—
AC Voltage	600V	1mV	±1.8%
DC Voltage	600V	0.1mV	±0.8%
Non-Contact AC Voltage	100 to 600V AC	—	—
Resistance	40MΩ	0.1Ω	±1.0%
Capacitance	100μF	10pF	±3.0%
Frequency	10kHz	0.001Hz	±1.5%
Duty Cycle	0.5 to 99%	0.1%	±1.2%
Temperature	-4°F to 1400°F	0.1°	±3.0%
	-20°C to 760°C	0.1°	±3.0%
Continuity	Audible threshold < 30Ω with beeper on, Audible threshold > 150Ω with beeper off		
Diode Test	Yes		
Dimensions	7.9 x 2.6 x 1.5 in.		
Weight	0.45 lb.		

400A AC CLAMP METER

21010N



The 21010N is our entry-level clamp meter. It is a 400A AC clamp with a very useful mix of functions including a built-in, non-contact AC voltage detector. It also has 10 measuring functions.

- Features automatic power off
- 10 measuring functions including capacitance, frequency, duty cycle, and temperature
- Built-in, non-contact AC NCV detector
- Easy-to-read, backlit, 4,000-count digital display
- Impact resistant double-molded housing also provides comfortable grip
- CAT III 600V safety rating, UL listed
- Includes:
 - Test leads
 - Type K temperature probe with banana plug adapter
 - Carrying case
 - Two AAA batteries



SPECIFICATIONS

MODEL #	STOCK #	DESCRIPTION	
21010N	582900	400A AC Clamp Meter	
FUNCTION	RANGE	MAX. RESOLUTION	MAX. ACCURACY (% OF READING)
AC Current	400A	10mA	±2.8%
Jaw Opening	1.2" (30mm)	—	—
AC Voltage	600V	1mV	±1.8%
DC Voltage	600V	0.1mV	±0.8%
Non-Contact AC Voltage	100 to 600V AC	—	—
Resistance	40MΩ	0.1Ω	±1.0%
Capacitance	100μF	10pF	±3.0%
Frequency	10kHz	0.001Hz	±1.5%
Duty Cycle	0.5 to 99%	0.1%	±1.2%
Temperature	-4°F to 1400°F	0.1°	±3.0%
	-20°C to 760°C	0.1°	±3.0%
Continuity	Audible threshold < 30Ω with beeper on, Audible threshold > 150Ω with beeper of		
Diode Test	Yes		
Dimensions	7.9 x 2.6 x 1.5 in.		
Weight	0.45 lb.		

VOLTAGE DETECTORS & TESTERS

VOLTAGE/CONTINUITY/PHASE ROTATION TESTER

41170S



This versatile tester features a built-in flashlight, single probe AC voltage check, and phase rotation on three phase circuits. It also features automatic indication of continuity as well as AC and DC voltage up to 600 volts.

- LED indication of AC voltage from 24 to 600V and DC voltage from 6 to 400V in 8 steps
- One-probe live voltage check
- Indicates phase rotation on three phase circuits
- Audible and visual continuity test
- Built-in, LED flashlight
- Includes 41170S tester with integrated test leads & two AAA batteries
- CAT III 600V safety rating, UL listed



SPECIFICATIONS

MODEL #	STOCK #	DESCRIPTION
41170S	582935	Voltage/Continuity/Phase Rotation Tester
AC Voltage Indication	24, 48, 120, 208, 240, 277, 480, 600V AC	
DC Voltage Indication	6, 12, 24, 36, 48, 110, 220, 400V DC	
Tolerances	-30% to 0% of reading	
Single Pole Voltage Test	100 to 480V AC	
Rotary Field Indication	100 to 400V AC	
AC Operating Frequency	50/60Hz	
Continuity	Audible threshold approx. 300kΩ	
Overload Protection	600V AC/DC	
Dimensions	9.46 x 2.07 x 1.45 in.	
Weight	0.50 lb.	

VOLTAGE DETECTORS & TESTERS

VOLTAGE/CONTINUITY TESTER

41160S



Simple-to-use tester automatically indicates polarity as well as AC and DC voltage up to 600 volts in 7 steps.

- Checks continuity of wires, light bulbs and fuses
- Automatic selection: AC, DC, or continuity
- Indicates polarity and seven levels of AC/DC voltage
- Automatically turns on and off
- UL listed, CAT III 600V
- Includes 41160S Tester with integrated test leads and two AA batteries



SPECIFICATIONS

MODEL #	STOCK #	DESCRIPTION
41160S	582916	Voltage/Continuity Tester
AC Voltage Indication	24, 120, 208, 240, 277, 480, 600V	
DC Voltage Indication	6, 12, 24, 36, 48, 110, 220V	
Tolerances	-30% to 0% of reading	
AC Operating Frequency	50/60Hz	
Continuity	Audible threshold approx. 85kΩ	
Maximum Input	600V AC/DC	
Dimensions	7.25 x 3.00 x 1.55 in.	
Weight	0.65 lb.	

VOLTAGE DETECTORS & TESTERS

AC/DC VOLTAGE TESTER

41150S



Simple-to-use tester automatically indicates polarity as well as AC and DC voltage up to 240 volts in 7 steps.

- Indicates polarity and voltage up to 240V in 7 steps
- No batteries required, simple automatic operation
- GFCI - verifies operation of GFCI protected outlets
- CAT II 300V and UL listed
- Includes 41150S Tester with integrated test leads
- No batteries required

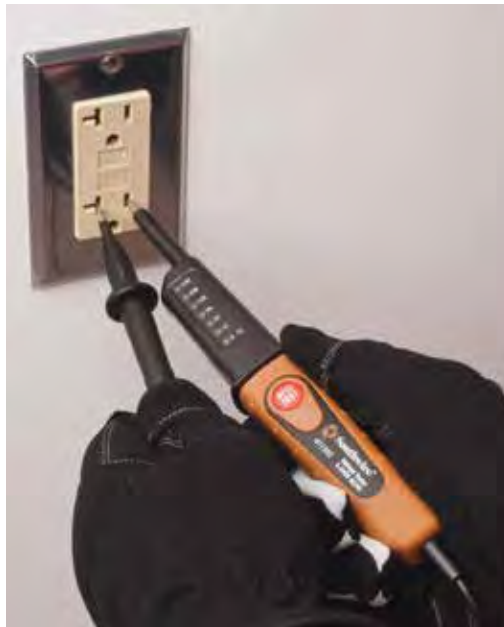

SPECIFICATIONS

MODEL #	STOCK #	DESCRIPTION
41150S	582917	AC/DC Voltage Tester
AC/DC Voltage Indication	6, 12, 24, 48, 120, 208, 240V	
Tolerances	-30% to 0% of reading	
AC Operating Frequency	50/60Hz	
Overload Protection	250V AC/DC <5s	
Dimensions	9.46 x 1.25 x 0.95 in.	
Weight	0.20 lb.	

VOLTAGE DETECTORS & TESTERS

ADVANCED DUAL RANGE NCV 12-1000V AC

40150N



Advanced Dual Range NCV 12-1000V & 100-1000V AC

- Features automatic power off
- High power rear flashlight and forward facing flashlight
- Thinner probe tip for working with wall outlets
- Power switch (standard)
- Green LED means Power on
- Flashing red LED with beeper means voltage is detected
- Low-Battery self test
- High voltage and low voltage modes
- Silent mode
- IP67 Waterproof



SPECIFICATIONS

MODEL #	STOCK #	DESCRIPTION
40150N	630207	40150N Advanced Dual Range NCV 12-1000V AC
AC Detection Range	12-1000V & 100-1000V AC	
GENERAL SPECIFICATIONS		
Safety Rating	CAT IV 1000V	
Frequency Range	50/60Hz	
Batteries	Two AAA	
Operating Temperature	32°F to 104°F (0°C to 40°C)	
Storage Temperature	14°F to 140°F (-10°C to 60°C)	
Dimensions	6.23 x 0.83 x 0.99 in (158 x 21 x 25 mm)	
Humidity	80% max	

VOLTAGE DETECTORS & TESTERS

NCV DETECTOR 50-600V AC PRO

40136N



NCV Detector 50-600V AC Pro

- Features automatic power off
- Flashlight now 2X brighter
- Thinner probe tip for working with wall outlets
- Power switch (standard)
- Green LED means Power on
- Flashing red LED with beeper means voltage detected
- Low battery self test
- Silent mode
- Flash and beep rate increase as the detector gets closer to the voltage source helping the user pinpoint live circuits



SPECIFICATIONS

MODEL #	STOCK #	DESCRIPTION
40136N	599924	40136N NCV Detector 48-600V AC Pro
AC Detection Range	50-600V AC	
GENERAL SPECIFICATIONS		
Safety Rating	CAT IV 600V	
Frequency Range	50/60Hz	
Batteries	Two AAA	
Operating Temperature	32°F to 104°F (0°C to 40°C)	
Storage Temperature	14°F to 140°F (-10°C to 60°C)	
Dimensions	6.23 x 0.83 x 0.99 in (158 x 21 x 25 mm)	
Humidity	80% max	

VOLTAGE DETECTORS & TESTERS

40126N NCV DUAL RANGE 24-600V AC

40126N



NCV Dual Range 24-600V & 100-600V AC

- Flashlight now 2X brighter
- Thinner probe tip for working with wall outlets
- Power switch (standard)
- Green LED means Power on
- Flashing red LED with beeper means voltage detected
- Low battery self test
- High voltage and low voltage mode



SPECIFICATIONS

MODEL #	STOCK #	DESCRIPTION
40126N	599922	40126N NCV Dual Range 24-600V AC
AC Detection Range	24-600V & 100-600V AC	
GENERAL SPECIFICATIONS		
Safety Rating	CAT IV 600V	
Frequency Range	50/60Hz	
Batteries	Two AAA	
Operating Temperature	32°F to 104°F (0°C to 40°C)	
Storage Temperature	14°F to 140°F (-10°C to 60°C)	
Dimensions	6.23 x 0.83 x 0.99 in (158 x 21 x 25 mm)	
Humidity	80% max	

TEST & MEASUREMENT | Voltage Detectors & Testers

VOLTAGE DETECTORS & TESTERS

NCV DETECTOR 100-600V AC

40116N



NCV Detector 100-600V AC

- Flashlight now 2X brighter
- Thinner probe tip for working with wall outlets
- Power switch (standard)
- Green LED means power on
- Flashing red LED with beeper means voltage detected
- Low battery self test



SPECIFICATIONS

MODEL #	STOCK #	DESCRIPTION
40116N	599920	40116N NCV Detector 100-600V AC
AC Detection Range	100-600V AC	
GENERAL SPECIFICATIONS		
Safety Rating	CAT IV 600V	
Frequency Range	50/60Hz	
Batteries	Two AAA	
Operating Temperature	32°F to 104°F (0°C to 40°C)	
Storage Temperature	14°F to 140°F (-10°C to 60°C)	
Dimensions	6.23 x 0.83 x 0.99 in (158 x 21 x 25 mm)	
Humidity	80% max	

VOLTAGE DETECTORS & TESTERS

GFCI RECEPTACLE TESTER

40020S-A



The 40020S-A quickly identifies the most common wiring faults in standard 3-wire outlets and verifies operation of GFCI protected outlets.

- LED indicators and wiring legend identify fault
- For use on 120V AC outlets
- GFCI Test verifies operation of GFCI protected outlets
- UL listed



SPECIFICATIONS

MODEL #	STOCK #	DESCRIPTION
40020S-A	582926	40020S-A GFCI Receptacle Tester
Receptacle is wired correctly	Fault	Reason for Wiring Fault
○●○	Open Ground	Ground terminal is not connected
○○●	Open Neutral	Neutral terminal is not connected
○○○	Open Hot	Hot terminal is not connected
●○●	Reversed Hot Ground	Hot and ground connections are interchanged
●●○	Reversed Hot Neutral	Hot and neutral connections are interchanged
○●●	Correct	Receptacle is wired correctly
Dimensions	3.43 x 1.73 x 0.95inch (87 x 44 x 24mm)	

VOLTAGE DETECTORS & TESTERS

RECEPTACLE TESTER

40010S-A



The 40010S-A quickly identifies the most common wiring faults in standard 3-wire outlets.



- LED indicators and wiring legend identify fault
- For use on 120V AC outlets
- UL listed

Voltage Detectors & Testers | TEST & MEASUREMENT

SPECIFICATIONS

MODEL #	STOCK #	DESCRIPTION																								
40010S-A	582925	40010S-A Receptacle Tester																								
<table border="1"> <thead> <tr> <th>Receptacle is wired correctly</th> <th>Fault</th> <th>Reason for Wiring Fault</th> </tr> </thead> <tbody> <tr> <td>○●○</td> <td>Open Ground</td> <td>Ground terminal is not connected</td> </tr> <tr> <td>○○●</td> <td>Open Neutral</td> <td>Neutral terminal is not connected</td> </tr> <tr> <td>○○○</td> <td>Open Hot</td> <td>Hot terminal is not connected</td> </tr> <tr> <td>●○●</td> <td>Reversed Hot Ground</td> <td>Hot and ground connections are interchanged</td> </tr> <tr> <td>●●○</td> <td>Reversed Hot Neutral</td> <td>Hot and neutral connections are interchanged</td> </tr> <tr> <td>○●●</td> <td>Correct</td> <td>Receptacle is wired correctly</td> </tr> <tr> <td>Dimensions</td> <td colspan="2">3.43 x 1.73 x 0.95inch (87 x 44 x 24mm)</td> </tr> </tbody> </table>			Receptacle is wired correctly	Fault	Reason for Wiring Fault	○●○	Open Ground	Ground terminal is not connected	○○●	Open Neutral	Neutral terminal is not connected	○○○	Open Hot	Hot terminal is not connected	●○●	Reversed Hot Ground	Hot and ground connections are interchanged	●●○	Reversed Hot Neutral	Hot and neutral connections are interchanged	○●●	Correct	Receptacle is wired correctly	Dimensions	3.43 x 1.73 x 0.95inch (87 x 44 x 24mm)	
Receptacle is wired correctly	Fault	Reason for Wiring Fault																								
○●○	Open Ground	Ground terminal is not connected																								
○○●	Open Neutral	Neutral terminal is not connected																								
○○○	Open Hot	Hot terminal is not connected																								
●○●	Reversed Hot Ground	Hot and ground connections are interchanged																								
●●○	Reversed Hot Neutral	Hot and neutral connections are interchanged																								
○●●	Correct	Receptacle is wired correctly																								
Dimensions	3.43 x 1.73 x 0.95inch (87 x 44 x 24mm)																									

VOLTAGE DETECTORS & TESTERS

PRO CONTINUITY TESTER WITH REMOTE

40040S



The Southwire 40040S provides a simple way of checking continuity on wire and cables. The bright LEDs and loud pulsating beeper provide a positive indication of continuity and polarity. A detachable remote indicator is included for tracing multiple cable runs.

- Bi-color LEDs determine polarity
- Color coded alligator clips for easy connection
- Wiring legend on tester provides simple operation
- Rugged double-molded housing



SPECIFICATIONS

MODEL #	STOCK #	DESCRIPTION
40040S	597248	Pro Continuity Tester with Remote
FUNCTION	RANGE	
Dimensions	4.0 x 2.1 x 1.3 inch	
Weight	0.42 lb. (191g)	

VOLTAGE DETECTORS & TESTERS

4-WAY VOLTAGE TESTER

40140S



Handy pocket size tester checks live AC voltage from 120 to 480 volts in four steps.



- Indicates live voltage from 120 to 480V AC and 160 to 600V DC
- Works on AC or DC voltage
- Compact design
- Probes spaced to fit standard AC outlets
- CAT III 600V and UL listed
- Compact size with pocket clip and durable double-molded enclosure
- Includes:
 - 40140S Voltage Tester
 - Built-in test leads



Test leads in storage position

SPECIFICATIONS

MODEL #	STOCK #	DESCRIPTION
40140S	582927	4-Way Voltage Tester
AC Voltage Indication	120V, 240V, 277V, 480V	
AC Operating Frequency	60Hz	
DC Voltage Indication	160V, 330V, 380V, 600V	
Dimensions	5.79 x 1.30 x 1.02 in.	
Weight	0.23 lb.	

IR THERMOMETERS

1500°F 20:1 INFRARED THERMOMETER WITH DUAL LASERS AND COLOR ALERT

31040S



The 31040S features 20:1 distance-to-spot ratio and a broad temperature range. This device truly stands out because of its fast response, high/low alarms and dual laser pointer. It is used by maintenance professionals to quickly locate worn machinery, hot spots in electrical panels, and defective HVAC equipment.

- Dual lasers pinpoint target area
- 20:1 distance to spot size ratio allows measurements at greater distance
- High/Low temperature alarms and color alert
- Fast 150 millisecond response time
- Backlit display
- Adjustable emissivity for use on reflective surfaces
- Max hold captures highest reading
- Lock-on feature for continuous measurement



SPECIFICATIONS

MODEL #	STOCK #	DESCRIPTION
31040S	582915	1500°F 20:1 Infrared Thermometer with Dual Lasers and Color Alert
Range	-58° to 1500°F (-50° to 815°C)	
Resolution	0.1°F/°C <1000° 1°F/°C >1000°	
Max. Accuracy	±1% ±1.8°F (1°C)	
Response Time	150ms	
Emissivity	Adjustable from 0.10 to 1.0	
Distance to Spot Ratio	20:1 (at 20" distance measures 1" spot)	
Dimensions	5.75 x 4.10 x 1.69 in.	
Weight	0.58 lb.	

TEST & MEASUREMENT | IR Thermometers

IR THERMOMETERS

1000°F 12:1 INFRARED THERMOMETER WITH DUAL LASERS

31030S



Includes features, such as fast response, high and low alarms and a dual laser pointer that can help the maintenance professional quickly locate problems in electrical panels, motors, bearings, machinery and HVAC equipment.

- Features automatic power off
- Dual lasers pinpoint target area
- 12:1 distance to spot size ratio allows measurements at greater distance
- High/Low temperature alarms
- Backlit display
- Adjustable emissivity for use on reflective surfaces
- Max hold captures highest reading
- Fast 150 milli-second response time
- Lock-on feature for continuous measurement



SPECIFICATIONS

MODEL #	STOCK #	DESCRIPTION
31030S	582934	1000°F 12:1 Infrared Thermometer with Dual Lasers
Range:	-58° to 1000°F (-50° to 537°C)	
Resolution:	0.1°F/°C <1000°	
Max. Accuracy:	±1% ±1.8°F (1°C)	
Response Time:	150ms	
Emissivity:	Adjustable from 0.10 to 1.0	
Distance to Spot Ratio:	12:1 (at 12" distance measures 1" spot)	
Dimensions:	5.75 x 4.10 x 1.69 in.	
Weight:	0.58 lb.	

IR THERMOMETERS

30020S



With 10:1 distance to spot, back-lit display and a temperature range of -58 to 900°F, the 30020S is a versatile addition to any toolbox.

- Features automatic power off
- Laser pointer quickly identifies target
- 10:1 distance to spot size ratio allows measurements at greater distance
- Easy-to-read backlit display
- Max/Min captures highest and lowest readings



SPECIFICATIONS

MODEL #	STOCK #	DESCRIPTION
30020S	582914	900°F 10:1 Infrared Thermometer
Range	-58° to 900°F (-50° to 482°C)	
Resolution	0.1°F/°C	
Max. Accuracy	±2% of reading or ±4°F/±2°C, whichever is greater	
Response Time	< 1 sec	
Emissivity	Fixed at 0.95	
Distance to Spot Ratio	10:1 (at 10" distance measures 1" spot)	
Dimensions	5.75 x 4.10 x 1.69 in.	
Weight	0.44 lb.	

IR THERMOMETERS

700°F INFRARED THERMOMETER

30010S



Provides quick surface temperature measurements without contact. The ideal service tool for HVAC, mechanical, and electrical maintenance.

- 8 to 1 distance to spot ratio
- Max/Min captures highest and lowest readings
- Laser pointer identifies target
- Backlit display
- Simple operation



SPECIFICATIONS

MODEL #	STOCK #	DESCRIPTION
30010S	582913	700°F Fahrenheit Infrared Thermometer
Range	-22°F to 700°F (-30° to 371°C)	
Resolution	0.1°F/°C	
Max. Accuracy	± 2% of reading or ±4°F/± 2°C, whichever is greater	
Response Time	Less than 1 second	
Emissivity	Fixed at 0.95	
Distance to Spot Ratio	8:1 (at 8" distance measures 1" spot)	
Dimensions	5.16 x 3.78 x 1.38 in.	
Weight	0.44 lb.	

BORESCOPE INSPECTION CAMERA

51010S



Borescope inspection camera with 1 meter long flexible gooseneck allows the user to probe behind walls, inside ventilation ducts, and difficult to reach areas that are not otherwise accessible.



- Features automatic power off
- Great tool for maintenance and repair
- High resolution color display
- Four powerful and adjustable LED lights illuminate dark spaces
- Flexible gooseneck can be configured for best viewing
- Up to 2X digital zoom
- Image Rotation
- Includes (3) accessories that clip on to camera head
 - mirror
 - hook
 - magnet



SPECIFICATIONS

MODEL #	STOCK #	DESCRIPTION
51010S	582923	Borescope Inspection Camera
Camera		
Maximum Resolution	640 x 480	
Maximum Frame Rate	30 frames per second	
Depth of Field	0.4" (10mm) to infinity	
Gooseneck Length	39" (1m)	
Camera Diameter	0.66" (17mm)	
TFT-LCD Display		
LCD Size	2.4" (61mm)	
Display Resolution	480 (W) x 234 (H)	
Power Supply	(4) "AA" Batteries (Included)	
Dimensions	9.46 x 6.30 x 3.94 in.	

CIRCUIT TESTERS

41210S CIRCUIT BREAKER FINDER WITH GFCI

41210S



The circuit breaker finder pinpoints the specific breaker powering the circuit being worked on. Eliminates guessing and unwanted power outages caused by tripping the wrong breaker.

- Advanced design quickly and reliably pinpoints single breaker without service interruption
- Tests GFCI outlets
- For use on energized circuits
- Includes:
 - 41210S Transmitter and Receiver
 - 3-prong to 2-prong adapter
 - 9 volt battery
- Available accessory: 60030S Adapter Kit



MODEL #	STOCK #	DESCRIPTION
41210S	582921	Circuit Breaker Finder with GFCI
Dimensions	7.56 in. x 2.52 in. x 1.65 in.	

TYPE K TEMPERATURE CLAMP

60020S



The 60020S Type K Temperature Clamp allows quick maintenance checks on heating and air-conditioning systems. It's the perfect accessory for clamp meters and multimeters with a temperature function.

- For multimeters, clamp meters and thermometers that accept a type K temperature probe
- Spring-loaded jaw clamps around heating/cooling pipes up to 1.5" in diameter
- Temperature range: -4° to 200°F (-20° to 93°C)

MODEL #	STOCK #	DESCRIPTION
60020S	582931	Type K Temperature Clamp

TEST LEAD KIT

60010S



60010S Test Lead Kit includes universal replacement leads for all Southwire meters except for the 10010S Analog Multimeter.

- UL listed
- CAT IV 600V/CAT III 1000V
- Includes alligator clip attachments (CAT III 600V)

MODEL #	STOCK #	DESCRIPTION
60010S	582929	Test Lead Kit

ADAPTER KIT FOR CIRCUIT BREAKER FINDER

60030S



This adapter kit includes a light socket adapter that allows for rapid location of circuit breakers connected to lighting fixtures. Also includes alligator clips that allow the transmitter to be connected to unterminated branch circuit wiring.

- For use with 41210S Circuit Breaker Finder

MODEL #	STOCK #	DESCRIPTION
60030S	582922	Adapter Kit for Circuit Breaker Finder

TEST KITS

ELECTRICAL TEST KIT

10036K



Combines the 3 most commonly used electrical testers in one convenient kit. Ideal for household repairs and electrical troubleshooting.

- Manual ranging multimeter features a CAT III 300V/CAT II 600V safety rating, easy-to-read backlit display, and battery test function
- Non-contact AC voltage detector checks for live voltage from 100 to 600V AC and features a built-in flashlight
- Receptacle tester quickly checks for miswired outlets

Kit Includes:

- 10030S Manual Ranging Multimeter with test leads
- 40116N Non-Contact AC Voltage Detector
- 40010S-A Receptacle Tester
- One 9 volt and two AAA batteries

SPECIFICATIONS

MODEL #	STOCK #	DESCRIPTION
10036K	599925	Electrical Test Kit

MODEL #	STOCK #	DESCRIPTION	
10030S	582908	Manual Ranging Multimeter CAT III 300V	
FUNCTION	RANGE	MAX. RESOLUTION	MAX. ACCURACY (% OF READING)
AC Current	600V	0.1V	±1.2%
DC Current	600V	0.1mV	±0.5%
DC Voltage	10A	1μA	±1.0%
Resistance	2000kΩ	0.1Ω	±0.8%
Battery Test	1.5V, 9V	10mV	±1.0%
Continuity	Audible threshold approx. 50Ω		
Diode Test	Yes		
Dimensions	5.9 x 2.8 x 1.9 in.		
Weight	0.56 lb.		

MODEL #	STOCK #	DESCRIPTION	
40116N	599920	NCV Detector 100-600V AC	
FUNCTION	RANGE	RESOLUTION	ACCURACY (% OF READING)
AC Detection Range	100-600V AC	—	—
Safety Rating	CAT IV 600V		
Frequency Range	50/60Hz		
Dimensions	6.2 x 0.8 x 1 in.		

MODEL #	STOCK #	DESCRIPTION
40010S-A	582925	Receptacle Tester
Identifies	Open Ground, Open Neutral, Open Hot, Reversed Hot Ground, Reversed Red Hot Neutral, Correct Wiring	
Dimensions	3.4 x 1.7 x 1 in.	

VOICE • DATA • VIDEO

Southwire offers a full line of VDV tools including cable cutters, strippers, crimpers and punchdown tools, as well as cable tracers and testers. Our goal is to provide professional tools that exceed customers' expectations for quality, performance and features — tools that make a difference on the real-world jobsite.

- VDV Cutters
- VDV Prep & Strip
- VDV Terminate
- VDV Test

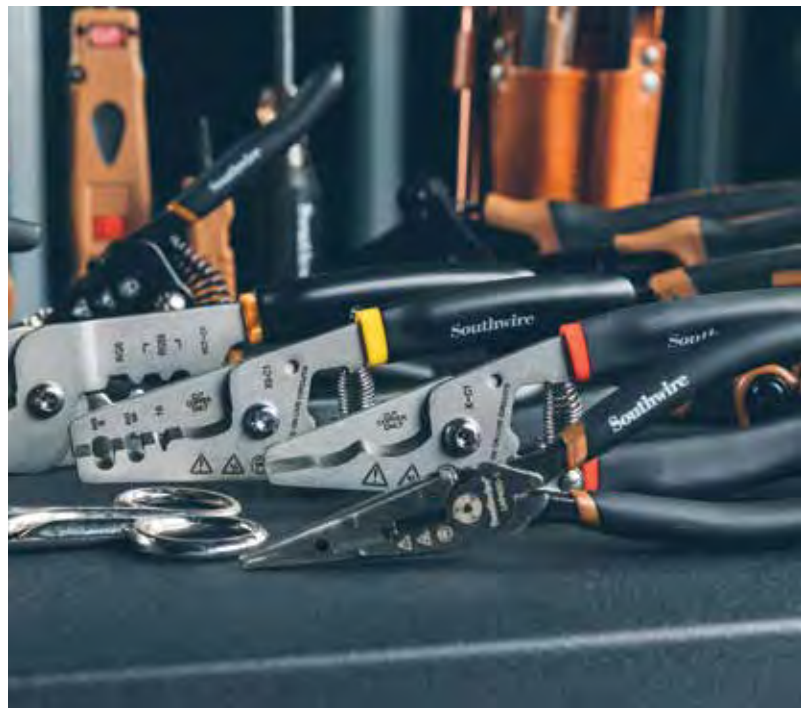

CUTTERS

PROFESSIONAL DATACOMM SNIPS

ESP-1



These snips provide very precise control and offer a patented design with unique spring-loaded action.

- Ergonomic, spring-loaded design for precise control
- Lock holds snips closed for storage
- Double-dipped, textured grip
- Strips 19 AWG and 23 AWG
- Serrated blade grips wire as it cuts

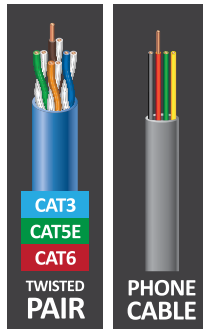

MODEL #	STOCK #	DESCRIPTION
ESP-1	587437	Professional DataComm Snips

ELECTRICIAN'S SCISSORS

ESS-1



Unlike regular scissors or shears, the serrated blades of this powerful scissor keeps wire from slipping out of the jaws. Cutting through hardware cloth, cable, wire netting, and other difficult-to-cut materials becomes as easy task.

- Strips 19 AWG & 23 AWG
- Strong, tempered steel
- Nickel-plated finish resists corrosion
- Scraper and file on outside of both blades

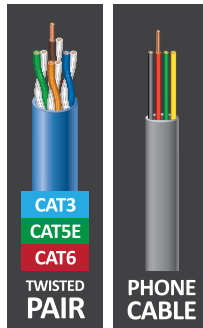

MODEL #	STOCK #	DESCRIPTION
ESS-1	587438	Electrician's Scissors

ELECTRICIAN'S SPLICING KIT

ESP-KIT



This 5 piece kit includes ESP scissors, a boot knife, a marker, and an LED pen-light in a rugged leather pouch.

- Spring-loaded scissors for precise cuts
- Serrated blade grips wires as it cuts
- Stripping notches for 19 and 22 AWG wire
- Double-dipped texture grip
- LED pen-light illuminates work space

MODEL #	STOCK #	DESCRIPTION	HEIGHT	WIDTH	DEPTH	WEIGHT
ESP-KIT	597242	Electrician's Splicing Kit				
ESP-KIT			8.25"	8.63"	12.25"	4.40 lb.



CUTTERS

COAX CCS CUTTER

CCSX-C1



Many coax cables today have a copper clad steel (CCS) center conductor. This specially designed cutter is made to reliably cut CCS coax that might damage standard cable cutters.

- Reliably cuts copper-clad steel coax without blade damage
- V-notch blade doesn't deform cable
- Forged steel
- Double-dipped textured grip

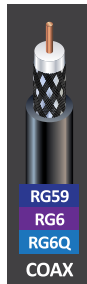

RG59
RG6
RG6Q
COAX



MODEL #	STOCK #	DESCRIPTION
CCSX-C1	587433	CCSX-C1 Coax CCS Cutter

ROUND CABLE CUTTER

X-C1



The stainless steel X-C1 has two cable cutting profiles: a long nose for cutting in confined spaces and a cable tie cutting tip. This is perfect for coax and twisted pair cabling.

- Curved blade profile for clean cuts
- Elongated nose to reach and cut in tight places
- Stainless steel for corrosion resistance
- Double-dipped textured grip
- Cutting areas for small and large round cable

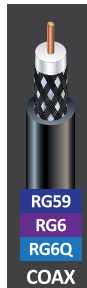

RG59
RG6
RG6Q
COAX



CAT3
CAT5E
CAT6
TWISTED
PAIR



MODEL #	STOCK #	DESCRIPTION
X-C1	587467	X-C1 Round Cable Cutter

RADIAL CUTTER/STRIPPER FOR TWISTED PAIR

XSR-T1



Cut and strip twisted pair cabling quickly and easily with one tool.

- Rotate knob to adjust depth of the cut
- Strips outer jacket without nicking wires



MODEL #	STOCK #	DESCRIPTION
XSR-T1	587470	Radial Cutter/Stripper for Twisted Pair

KEY STRIP TOOL FOR TWISTED PAIR

SK-T1



The Key Strip Tool for Twisted Pair quickly strips outer cable jackets from CAT 3, 5, 5e and 6 data cable.

- Quickly removes outer cable jacket
- Three positions for different size cables
- Cost effective

MODEL #	STOCK #	DESCRIPTION
SK-T1	587461	SK-T1 Key Strip Tool for Twisted Pair

COAX TRIGGER STRIP TOOL

ST-C1

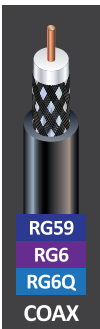

The rotary-style coax stripper performs a fast and precise two-level strip in one easy step.

- Standard two-level strip exposes 1/4" of center conductor and 1/4" of shield braid
- Innovative "trigger" design improves control and fits comfortably in hand
- Use with RG59, RG6 and RG6 quad shield coax



MODEL #	STOCK #	DESCRIPTION
ST-C1	587462	Coax Trigger Strip Tool

PREP AND STRIP

AUTOMATIC WIRE STRIPPER FOR COAX

SA-C1

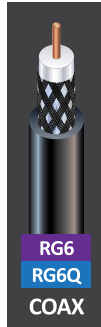

The SA-C1 Automatic Wire Stripper for Coax allows for quick, two-step stripping of RG6 and RG6Q cable.

- Traditional automatic design preferred by many installers
- 2-level strip: Center conductor and outer jacket



MODEL #	STOCK #	DESCRIPTION
SA-C1	587459	Automatic Wire Stripper for Coax

COAX CUTTER/STRIPPER

XS-C1

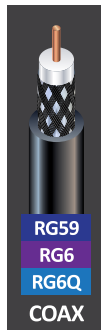

The XS-C1 Coax Cutter/Stripper cuts and strips coax cable and features a cable tie cutting tip.

- Cuts and strips RG59, RG6, and RG6Q quad shield coax
- Stainless steel for corrosion resistance
- Textured double dip handles for better grip and comfort
- Tip is designed to cleanly cut cable ties



MODEL #	STOCK #	DESCRIPTION
XS-C1	587468	Coax Cutter/Stripper

COAX PREP TOOL

CPT-CF1

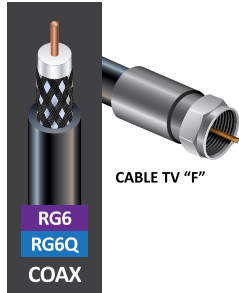

The time-saving Coax Prep Tool is a 3-in-1 tool for loosening/tightening cable TV "F" connectors from jacks. It also flares the cable jacket and holds the connector during assembly.

- Easily loosens stubborn connectors
- Flares coax jacket for easy connector insertion
- Holds cable TV "F" connector during cable insertion
- Double-molded grip for long-lasting comfort



MODEL #	STOCK #	DESCRIPTION
CPT-CF1	587434	Coax Prep Tool

TERMINATE

PROFESSIONAL IMPACT PUNCHDOWN TOOL

PDTP-K1

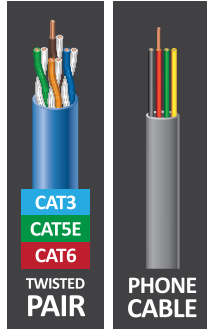

BLADES AVAILABLE SEPARATELY :

- B1 Reversible 66 Punch/110 Cut-Only Punchdown Blade
- B2 Reversible 110 Cut/Punch Punchdown Blade
- B3 Reversible 66 Cut/Punch Punchdown Blade

The Professional Impact Punchdown Tool includes 110 & 66 twist-to-lock blades and features unique pull out accessory tools in a comfortable, durable tool body.

- Terminates twisted pair category cable into wall jacks and patch panels for phone and data communications
- Includes both 110 and 66-style, long life, metal injection molded blades
- Comfortable double-molded tool body
- Wire hook and spudger accessory tools pull out one-handed with easy-to-use thumb studs
- Covered blade storage



Includes both 110 and 66 style blades



Easy to pull out wire hook and spudger tools

MODEL #	STOCK #	DESCRIPTION
PDTP-K1	587455	Professional Impact Punchdown Tool

COMFORT GRIP 110-STYLE PUNCHDOWN TOOL

PDTC-1



The Comfort Grip 110-Style Punchdown Tool easily terminates 110-style blocks on patch panels and wall jacks.

- Punch down 110-style jacks or patch panels
- Soft rubber comfort grip
- 110-style blade terminates cable and trims excess wire



MODEL #	STOCK #	DESCRIPTION
PDTC-1	587454	Comfort Grip 110-Style Punchdown Tool

RATCHETING PHONE & DATA CRIMP TOOL

RJCR-T1

The RJCR-T1 Ratcheting Phone & Data Crimp Tool cuts and strips voice and data cable. It also crimps RJ45 data connectors as well as RJ11/RJ12 phone modular plugs.

- Ratcheting tool cuts, strips, and crimps phone and data cable
- Comfortable double-molded grips help to orient the tool
- Compatible with standard RJ45, RJ11/RJ12, and RJ22 modular plugs
- Locks closed for easy storage



MODEL #	STOCK #	DESCRIPTION
RJCR-T1	587458	Ratcheting Phone & Data Crimp Tool

COMPACT VOICE & DATA CRIMP TOOL

RJCC-T1

This all-in-one tool cuts and strips both phone and data cable. It also crimps RJ45 (data) as well as RJ11/RJ12, and RJ22 (phone) modular plugs.

- Cuts, strips, and crimps data and voice cable
- Compact and versatile design
- Compatible with RJ45, RJ11/RJ12 and RJ22 plugs
- Convenient handle lock for easy storage
- For network and phone applications

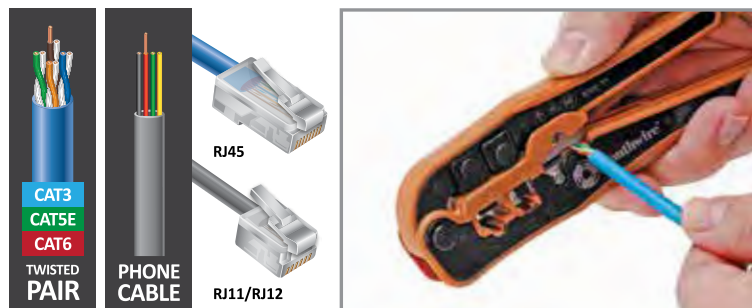

MODEL #	STOCK #	DESCRIPTION
RJCC-T1	587457	Compact Voice & Data Crimp Tool

TERMINATE

RATCHET CRIMP TOOL – COAX CABLE TV “F” HEX CONNECTORS

RCT-D1



The compound leverage design delivers high crimp force with low hand force, and the near-parallel jaw action delivers precision crimps. The RCT-D1 is where power meets precision.

- Compound leverage design provides powerful crimping with low hand force
- Near-parallel travel crimping jaw for precise crimps
- Precision ratchet with release
- Convenient handle lock for easy storage
- Die set available separately:
 - D1 Die Set - Cable TV F Coax

MODEL #	STOCK #	DESCRIPTION
RCT-D1	587456	RCT-C1 Ratchet Crimp Tool - Coax

NETWORK TOOL KIT

KIT-TP1

This 13-piece Network Tool Kit includes the tools you need to cut, strip, terminate, and install data cabling.



- Complete 13 piece kit for terminating data cable
- Make custom length patch cables
- Includes tools to cut, strip, and terminate data cabling
- Kit includes:
 - Compact 3-in-1 Cut/Strip/Crimp Tool
 - Comfort Grip Punchdown Tool
 - Reversible Screwdriver
 - 10 RJ45 Connectors
 - Rugged Tool Case



MODEL #	STOCK #	DESCRIPTION
KIT-TP1	587441	Network Tool Kit

CRIMPING LONG NOSE PLIERS- UR/UY/UG

LNP6DC-1

Long Nose Pliers for crimping IDC (insulation displacement) UR, UY, and UG type connectors.



- Crimps UR/UY/UG connectors
- Strips 22-24 AWG wire
- Induction hardened cutting blade
- Hot-rivet joint for smooth action and long life
- 6" length



MODEL #	STOCK #	DESCRIPTION
LNP6DC-1	587442	Crimping Long Nose Pliers - UR/UY/UG

TERMINATE

MULTI-CONNECTOR COMPRESSION COAX CRIMP TOOL

CCM-C1



When you need versatility, Multi-Connector Compression Coax Crimp Tool is 3-way adjustable to work with F, BNC, and RCA compression connectors as well as RG59/6/6Q and RG7/11 coax cable.

- 3-way chuck can be positioned for cable TV "F", RCA, and BNC connectors
- Rotatable connector cradle accommodates RG59, RG6Q, RG6 as well as larger RG7 and RG11 cable
- Thumb-wheel for fine-tuning crimping length
- For cable TV, satellite, security, and home theater applications
- Comfortable double-molded grips are indexed to help orient the tool

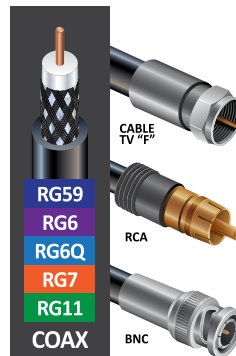

COMPACT COMPRESSION COAX CRIMP TOOL FOR "F" CONNECTORS

CCF-C1



The CCF-C1 Compact Compression Coax Crimp Tool securely attaches "F" type connectors to coax cable in one easy step. CCF-C1 features double-molded handles to provide a comfortable grip and powerful crimping force.

- Compatible with RG59, RG6, and RG6Q coaxial cable
- Simple, compact, and powerful
- Double-molded handles for durability and grip

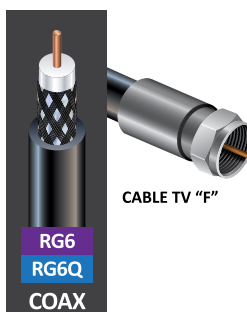

RATCHETING CRIMP TOOL

RCT-D1



The Ratcheting Crimp tool is where power meets precision. Its compound leverage design delivers high crimp force, and the near-parallel jaw action provides precision crimps. Made for coax cable TV "F" hex connectors.

- Compound leverage design - powerful crimping with low hand force
- Near-parallel travel crimping jaw for precise crimps
- Precision ratchet with release
- Convenient handle lock for easy storage
- Die Set Available Separately

SPECIFICATIONS

MODEL #	STOCK #	DESCRIPTION
RCT-D1	587456	RCT-C1 Ratchet Crimp Tool - Coax
D1	587435	D1 Replacement Die Set - Cable TV "F" Coax

TERMINATE

CABLE TV TOOL KIT

KIT-C1

This 13-piece Cable TV Tool Kit includes all the tools you need to cut, strip, crimp, and install "F" connectors onto coax cable.

- Complete 13-piece kit for terminating coax
- Make custom length coax patch cables
- All 3 tools included to cut, strip, and crimp coax
- Kit includes:
 - Round Cable Cutter
 - Radial "Trigger" Stripper
 - Compression Crimper for "F" Connectors
 - 10 "F" Connectors for RG6 Coax
 - Rugged Tool Case

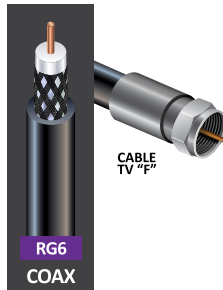

MODEL #	STOCK #	DESCRIPTION
KIT-C1	587440	Cable TV Tool Kit

COAX 3-IN-1 CRIMP TOOL

HCT-C1

The stainless steel Southwire 3-in-1 Crimp Tool cuts and strips coax as well as crimps Cable TV "F" hex-style connectors.

- One tool cuts, strips, and crimps coax cable
- Crimps "F" connectors
- Stainless steel for corrosion resistance
- Double-dipped textured grip

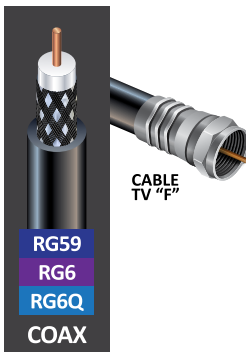

MODEL #	STOCK #	DESCRIPTION
HCT-C1	587439	Coax 3-in-1 Crimp Tool

PROFESSIONAL VDV CABLE MAPPER

M300P



The M300P Professional VDV Cable Mapper quickly tests voice, data, and video cabling for common wiring faults including split pairs. Rugged, double-molded body includes silicone port covers to protect the ports and an easy-to-read backlit LCD screen.

- Quickly checks for faults on voice, data, and video cables
- Identifies correct wiring, opens, shorts, reversals, miswires, split pairs, and shielded cables
- Test patch cables or installed cables
- Built for durability: Double injection-molded housing provides a soft, impact absorbing rubber over a strong ABS frame
- Maps multiple cable runs with included RJ45 & Coax "F" ID remotes (5 of each are included)
- Remote ID kits available separately:
 - M310 Replacement Kit of ID Remotes (5 RJ45 and 5 Coax "F", Remote Numbers 1 - 5)
 - M310-F Expansion Kit of 11 "F" Coax ID Remotes (Remote Numbers 6-16)
 - M310-RJ Expansion Kit of 11 RJ45 ID Remotes (Remote Numbers 6-16)
- Built-in tone generator for cable tracing (separate amplifier probe required)

SPECIFICATIONS

Cable Types:	Shielded or Unshielded: Cat 7, Cat 7a, Cat 6a, Cat 6, Cat 5e, Cat 5, Cat 3, Coax
Minimum Cable Length for Split Pair Detection	1.6 feet (0.5m)
Maximum Coax Cable Length	1000 feet (305m)
Maximum Coax Cable Resistance	100 ohms maximum DC
Dimensions	7.13" x 2.86" x 1.61" (18.1cm x 7.3cm x 4.1 cm)
Weight	0.78 lb. (353g)

MODEL #	STOCK #	DESCRIPTION
M300P	587443	Professional VDV Cable Mapper



Built-in tone generator for cable tracing (separate amplifier probe required)



Port covers protect RJ45 and RJ11 ports from dust and debris



Remote stores securely in tester body



Easy-to-read backlit display

PROFESSIONAL MAPPER FOR DATA CABLE

M400TP

The M400TP Professional Mapper for Data Cable quickly tests twisted pair data cable for common wiring faults including split pairs. It even sends a tone and features a backlit LCD screen, double-molded housing, and silicone port cover.



- Easy-to-read LCD display with backlight
- Port cover protects RJ45 port from dust and debris
- Rugged double-molded housing with snap-in remote
- Identifies correct wiring, opens, shorts, reversals, miswires, split pairs, and shielded cables
- Built-in tone generator for tracing cables (separate amplifier probe required)



Built-in tone generator for cable tracing
(separate amplifier probe required)



Port covers protect RJ45 ports from dust and debris



Remote stores securely in tester body



Easy-to-read backlit display

SPECIFICATIONS

Cable Types	Shielded or Unshielded: Cat 7, Cat 7a, Cat 6a, Cat 6, Cat 5e, Cat 5, Cat 3
Minimum Cable Length for Split Pair Detection	1.6 feet (0.5m)
Batteries	Two "AAA" 1.5V
Dimensions	4.80" X 2.05" X 1.30" (12.2cm X 5.2cm X 3.3 cm)
Weight	4.5 oz (129.4g)

MODEL #	STOCK #	DESCRIPTION
M400TP	587448	Professional Mapper for Data Cable

DATA/VIDEO CABLE TESTER

M550

The M550 gives instant continuity status for both twisted pair and coaxial cables. Features rugged, double-molded tester body with on-board remote storage and an easy-to-interpret LED display.

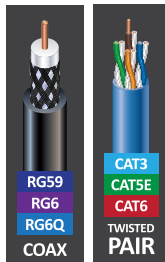

- Quickly detects wiring faults in network and coax cables
- Test patch cables or installed cables
- Identifies correct wiring, opens, shorts, reversals, miswires, split pairs, and shielded cables
- Auto power off
- Tests shielded and unshielded twisted pair and coax
- Includes adapter cables



Includes adapter cables



Quickly detects wiring faults in network and coax cables



Remote stores securely in tester body



Easy-to-interpret LED display

SPECIFICATIONS

Cable Types	Shielded or Unshielded: Cat 7, Cat 7a, Cat 6a, Cat 6, Cat 5e, Cat 5, Cat 3, Coax
Minimum Cable Length for Split Pair Detection	1.6 feet (0.5m)
Maximum Coax Cable Length	1000 feet (305m)
Batteries	Two "AAA" 1.5V
Dimensions	5.11" x 2.05" x 1.30" (13.0cm x 5.2cm x 3.3cm)
Weight	4.5 oz (129.4g)

MODEL #	STOCK #	DESCRIPTION
M550	587450	M550 Data/Video Cable Tester

CONTINUITY TESTER FOR DATA CABLE

M555TP

Provides a quick check for common wiring faults on data cables and includes a handy color wiring guide right on the tester.



- LEDs illuminate in sequence identifying correct wiring and misconnections
- Intuitive color wiring reference chart included
- Checks data cables for simple miswires (tests patch cables and installed cables)
- Double-molded housing for durability and grip
- Remote stores securely in tester body
- Includes adapter cables



Includes adapter cables



Quickly detects wiring faults in data cables



Tests patch cables and installed cables



Illuminated LEDs and color wiring reference chart

SPECIFICATIONS

Cable Types	Shielded or Unshielded: Cat 7, Cat 7a, Cat 6a, Cat 6, Cat 5e, Cat 5, Cat 3
Batteries	Two "AAA" 1.5V
Dimensions	4.72" x 2.05" x 1.30" (12.0 cm x 5.2cm x 3.3cm)
Weight	4.81 oz (136.5g)

MODEL #	STOCK #	DESCRIPTION
M555TP	587452	Continuity Tester for Data Cable

COAX CONTINUITY TESTER/MAPPER

M500CX4



The M500CX4 speeds troubleshooting and installation by testing and identifying up to four cable TV remote wall outlets at a time. It includes four color-coded remotes.

- Easy-to-understand LED display
- Test patch cables or installed cables
- Identify up to four coax cable remote locations - includes 4 color-coded ID remotes
- Double-molded housing for durability and grip
- Auto power off



Includes 4 color-coded ID remotes



Double-molded housing for durability and grip



Test patch cables or installed cables



Easy-to-understand LED display

SPECIFICATIONS

Max. Testing Length	10,000 feet (3km) maximum
Batteries	Four LR44 Batteries
Case Dimensions	5.4" x 1.26" x 0.98" (13.7cm x 3.2cm x 2.5cm)
Weight	3.14 oz (89g)

MODEL #	STOCK #	DESCRIPTION
M500CX4	587449	Coax Continuity Tester/Mapper

PHONE OUTLET TESTER

P700



The P700 checks phone outlets - Lines 1 and 2 - for correct wiring, line reversed, AC ring voltage, and dead line conditions.

- Quickly checks phone outlets for correct wiring
- Identifies correct wiring, line reversed, AC ring voltage, and dead line conditions
- Tri-color LED display
- Color legend printed on tester makes interpreting results simple
- Tests both Line 1 and Line 2
- Double-molded housing for durability and grip

MODEL #	STOCK #	DESCRIPTION
P700	587453	Phone Outlet Tester

PROFESSIONAL TELEPHONE TEST SET

B600



Rugged and cost-effective, the B600 Professional Telephone Test Set features Hi-Z monitoring, Pulse and Tone (DTMF), 10 number speed dial, and polarity indication in a rugged, double-molded housing.

- Hi-Z monitoring will not disrupt network traffic
- High and low volume settings, polarity LED, tone & pulse modes
- ABN (angled bed of nails) clips with rugged RJ45 and RJ11 plugs
- Last number redial and memory to store up 10 phone numbers
- Double-molded housing for comfort and durability



SPECIFICATIONS

ELECTRICAL	
Humidity	10% to 90% non-condensing
Loop Limit	2.4K Ω maximum at 48VDC (nominal 15 mA minimum loop current)
DC Resistance (Talk Mode)	150 Ω typical at 80mA current
AC Impedance (Monitor Mode)	HI-Z: 100k Ω @ 1KHz RING: 600 Ω @ 1KHz
ROTARY DIAL OUTPUT	
Pulsing Rate	20pps +/-0.5pps
Percent Break	60% +/-2%
Interdigit Interval	500 ms typical
Leakage During Break	>50K Ω
DTMF OUTPUT	
Tone Frequency Error	+/-1% maximum
Level per Tone Pair	+2dBm maximum, -8dBm minimum
High versus Low Tone Difference	4dBm maximum
PHYSICAL	
Dimensions	10.12" x 2.43" x 2.49" (25.7cm x 6.17cm x 6.33 cm)
Weight	11.0oz (312.8g)
Battery	CR2032 (included)

MODEL #	STOCK #	DESCRIPTION
B600	587429	Professional Telephone Test Set
B610C	587430	B610C Replacement Leads for Buttset

PROFESSIONAL TONE & PROBE KIT

T100PK



The T100PK Professional Tone & Probe Kit quickly traces non-energized cabling. It is powerful enough to trace cables behind walls but sensitive enough to identify individual conductors.

- Quickly trace non-energized cables - even behind walls
- Positive cable detection: tone changes when wires are shorted
- Toner features on-board test lead storage
- Probe features replaceable tip, LED flashlight, LED signal strength indicator, rear facing speaker, and stereo headphone jack

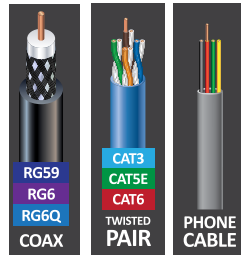

Speaker faces up and back for clear sound. Stereo headphone jack is compatible with standard headphones



Test leads wrap around racetrack in toner and snap securely in place



Lock-in Test leads with cable management



Built-in LED flashlight for dark wiring closets

SPECIFICATIONS

T100PK includes T110TG and T120AP

T110TG Tone Generator Specifications	
Continuous Tone Frequency	1.06kHz nominal
Over Voltage Protection	60VDC in Toner/Polarity Mode
Output Power in Tone Mode	+9.65 dbm into 600 ohms
Auto-Off	30 minutes
Open Circuit Voltage in Continuity Mode	8.2VDC with fresh battery
Battery	One 9V battery
Case Dimensions	4.02" x 2.58" x 2.36" (10.2cm x 6.5cm x 6cm)
Weight	8 oz (230g)
T120P Analog Probe Specifications	
Battery	One 9V battery
Case Dimensions	9.33" x 1.70" x 1.51" (23.7cm x 4.3cm x 3.8cm)
Weight	5 oz (143g)

MODEL #	STOCK #	DESCRIPTION
T100PK	587463	Professional Tone & Probe Kit

MULTIPURPOSE WIRE TRACING KIT

T200K

The T200K is a self-contained kit for tracing a variety of cable types. It includes a belt-mount case with five adapter cables, separate toner, and probe. The probe features an LED flashlight for cable tracing in low-light areas.



- Belt-mount, rugged carrying case
- Double-molded housings for durability and grip
- Provides audible and visual indication
- Five adapter cables can be stored in the case and plugged into RJ11 jack on transmitter
- Traces non-energized low-voltage cables

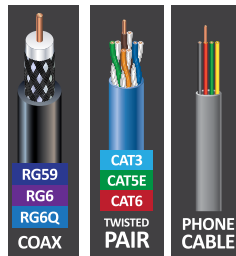

- Five adapter cables store in case:
- Coax adapter with F connector
 - Data adapter with RJ45 connector
 - Phone adapter with RJ11 connector
 - Automotive fuse adapter
 - Alligator clip adapter



Double-molded tester housing for durability and grip



Traces non-energized low-voltage cables/speaker wires



Traces a variety of cable types



Built-in LED flashlight for dark wiring closets

SPECIFICATIONS

T200K SPECIFICATIONS	
Tone Signal Frequency	2.72kHz nominal
Tone Output Power	+24dbm into 600 ohms
Tone Auto-Off	30 minutes
Battery (Transmitter and Receiver)	Two "AAA" 1.5V Batteries in each unit
Case Dimensions	7.06" x 3.19" x 2.04" (17.9cm x 8.1cm x 5.2cm)
Tone Dimensions	5.17" x 0.94" x 1.32" (13.2cm x 2.4cm x 3.4cm)
Probe Dimensions	6.18" x 0.94" x 1.32" (15.7cm x 2.4cm x 3.4cm)
Weight	0.7 lb. (322g)

MODEL #	STOCK #	DESCRIPTION
T200K	587466	Multipurpose Wire Tracing Kit

CABLE PULLING

Southwire cable pulling equipment sets the industry standard. We've revolutionized these tools to make them faster, safer, and smarter than ever before. With Southwire cable pulling equipment on your jobsite, you can see an increase in safety, efficiency, and profitability.

- Pullers
- Pulling Accessories
- Pulling Rope
- Pulling Grips
- Fishing
- Accessories



MAXIS® XD10 EXTREME DUTY CABLE PULLER

XD10



The MAXIS® XD10 EXTREME Duty Cable Puller is designed to get the job done, thriving in the most extreme pulling conditions. The XD10 allows you to pull faster and safer up to 10,000 lb.

- Smooth Elevation Control: Operates with handle or 18V cordless drill helping to eliminate any lifting
- Pulls up to 10 ft. of extra wire without extending the boom
- Gear reducer design allows for increased efficiency, durability and power while maintaining low operating temperature
- 10,000 lb. peak pulling force with a continuous pulling rate of 7,000 lb.
- Conduit adapter sizes 2" - 4" included, 5" & 6" adapters sold separately
- Self Contained: ready to pull with no need for additional parts or equipment for set up
- Single person set up and operation: Quickly adapts from underground to overhead pulls
- Collapsible down to 40"H x 26"W x 70"L to fit through standard doorways and ease of transport



SPECIFICATIONS

MODEL #	STOCK #	DESCRIPTION		
XD10	591904	MAXIS® XD10 EXTREME Duty Cable Puller		
HEIGHT	LENGTH	WIDTH	WEIGHT	WARRANTY
40"	70"	26"	598 lb.	1 year
CAPACITY				
Pulling Speed Low:		Pulling Speed High:		
at 2,000 lb.	11 feet per minute	at 2,000 lb.	21 feet per minute	
at 4,000 lb.	10 feet per minute	at 4,000 lb.	18 feet per minute	
at 6,000 lb.	9 feet per minute	-	-	
at 8,000 lb.	8 feet per minute	-	-	
at 10,000 lb.	7 feet per minute	-	-	

XD10 BOLT DOWN ADAPTER

XD10BD



Floor mount adapter for XD10

- Easily attaches to the XD10
- Does not require disassembly of cable puller
- Simple bolt down adapter for when overhead pulling is required

SPECIFICATIONS

MODEL #	STOCK #	DESCRIPTION		
XD10BD	597270	Maxis® XD10 Bolt Down Kit		
HEIGHT	WIDTH	DEPTH	WEIGHT	
XD10BD	18"	14"	16"	35 lb.

PULLERS

MAXIS® 6K CABLE PULLER

M6K-M
M6K
PC100



A 6,000 pound cable puller that sets up in less than 2 minutes.

- One person, 2 minute set up
- 2 pulling speeds: 12 feet per minute on low (at no load) and 44 feet per minute on high (at no load)
- Quickly adapts from underground to overhead pulls
- No need to bolt to the ground on most pulls
- 6,000 lb. peak capacity with continuous rating of 3,500 lb. on low
- Can adapt to virtually any wire pull
- Can be anchored to most trucks' standard 2" receiver hitch
- Able to pull up to 9 ft. of wire out of the conduit
- Includes 5 conduit adapters 2" - 4" Included, 5" and 6" sold separately
- Includes puller cart with tool bag

SPECIFICATIONS

MODEL #	STOCK #	DESCRIPTION		
M6K-M	576485	MAXIS® 6K (with motor) - includes conduit adapters 2" - 4" and PC100		
M6K	571429	MAXIS® 6K (no motor) - includes conduit adapters 2" - 4" and PC100		
PC100	568296	Puller cart for M3K and M6K pullers		
	LENGTH	WIDTH	DEPTH	WEIGHT
M6K-M	45"	21"	20"	194.5 lb.
PC100	50" (height)	21"	17.5"	40 lb.



MAXIS® 3K CABLE PULLER

M3K-M
PC100
M3K



A high speed, lightweight 3,000 lb. cable puller.

- One person, 2 minute set up
- 2 pulling speeds: 25 feet per minute on low (at no load) and 100 feet per minute on high (at no load)
- Quickly adapts from underground to overhead pulls
- No need to bolt to the ground on most pulls
- Able to pull up to 8 ft. of wire out of the conduit
- 3,000 lb. peak capacity with continuous rate of 1,500 lb. on low
- Can adapt to virtually any wire pull
- Can be anchored to most trucks' standard 2" receiver hitch
- Includes 8 conduit adapters: 2" - 4"
- Puller cart with tool bag

SPECIFICATIONS

MODEL #	STOCK #	DESCRIPTION			
M3K-M	576484	MAXIS® 3K (with motor) - includes conduit adapters 1" - 4" and PC100			
M3K	571431	MAXIS® 3K (no motor) - includes conduit adapters 1" - 4" and PC100			
PC100	568296	Puller cart for M3K and M6K pullers			
		LENGTH	WIDTH	DEPTH	WEIGHT
M3K-M		45"	20"	20"	148.5 lb.
PC100		50" (height)	21"	17.5"	40 lb.



PULLERS

MAXIS® CABLE FEEDER

MCF01



Designed and built specifically to accommodate Southwire® SIMpull® wire, the Maxis® Cable Feeder is a revolutionary way to feed wire quickly and efficiently.

- Designed and built specifically to accommodate Southwire® SIMpull™ wire
- Quick 1 person, 2 minute set up and operate
- Forward and reverse, variable speed, and feeds up to 30 feet per minute
- May be used with Triggers® Safety system for simultaneous feeder/puller control
- Easily adjust wire tension, even during operation
- Feeds wire sizes from 1/2" - 3 1/2" cable
- Solid rubber tires and swivel casters that will never go flat for easy job site maneuverability
- Digital footage meter allows easy monitoring of approximate conductor length being fed
- Uses grooved roller design with increased surface area for greater traction force (no pneumatic tires)
- Dual anchoring mechanism
- Maximum traction force: single conductor 800 lb., 4 SIMpull™ THHN 500 MCM conductors 1,600 lb. capacity
- Cable capacity: 8 x 250 MCM, 6 x 500 MCM, 5 x 750 MCM

SPECIFICATIONS

MODEL #	STOCK #	DESCRIPTION		
MCF01	581333	MAXIS® Cable Feeder		
	LENGTH	WIDTH	DEPTH	WEIGHT
MCF01	35"	26"	44"	366 lb.



TRIGGERS® WIRELESS SAFETY SWITCH SYSTEM

TSS01



Safety system designed to control the input power of any piece of jobsite equipment.

- Works with all brands of electrically driven equipment
- Saves time by avoiding unnecessary stops and restarts
- High visibility LED status lights
- Monitors amperage draw indicating when to switch puller to low speed
- Triggers® Wireless Safety Switch System is UL and FCC Certified and carries an IP55 rating
- Foot controls contain dual redundant activation switches
- Military grade 3.4 amps per hour lithium ion battery packs
- Handheld remotes can control pull from any location
- High range: communicates up to 1500' between walls and 1.5 miles line of sight

SPECIFICATIONS

MODEL #	STOCK #	DESCRIPTION		
TSS01	597132	Triggers® Wireless Safety Switch System		
	LENGTH	WIDTH	DEPTH	WEIGHT
TSS01	12.54" (height)	21.5"	16.42"	30 lb.

LOW VOLTAGE FOOT SWITCH

LVFS01



- Works with all brands of electrically driven equipment
- Shuts off equipment when over amperage condition is indicated
- Monitors for under voltage condition which can cause an over amperage condition
- Bright LED lights for easy viewing in bright sunlight
- Redundant switches for added reliability
- Impact resistant metal construction
- Low voltage indicator light for detecting low voltage situations
- Built-in over amperage protection to protect equipment and motors

SPECIFICATIONS

MODEL #	STOCK #	DESCRIPTION		
LVFS01	64602801	Low Voltage Foot Switch		
	HEIGHT	WIDTH	DEPTH	WEIGHT
LVFS01	4.25"	6.25"	12.25"	4 lb.

PULLING ACCESSORIES

SIMPULL™ CABLE GUIDE SYSTEM

CGS01

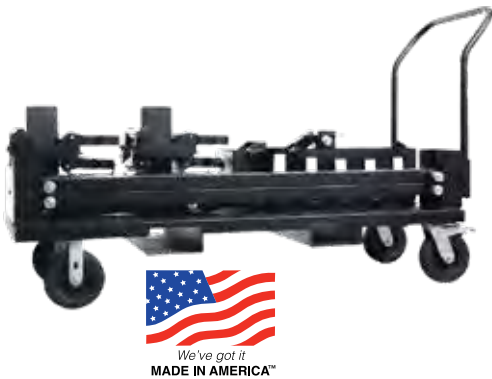

Integrated guidance system allowing wire and cable to be routed from a reel into a conduit or cable tray without human intervention.

- Designed to eliminate the manual handling of service and feeder conductors during wire pulls
- Completely customizable for any wire and cable installation
- Minimizes labor effort during installation
- Reduces the risk of jobsite injuries
- Specialized storage cart for ease of transportation
- Roller guides direct and protect wire and cable along any desired path
- Universal clamps attach the system to the reel jacks, switch gear or panel box

SPECIFICATIONS

MODEL #	STOCK #	DESCRIPTION	LENGTH	WIDTH	DEPTH	WEIGHT
CGS01	598931	SIMPull™ Cable Guide System				
CGS01			43" (height)	25"	67"	300 lb.



PULLING ACCESSORIES

TRIPODS

P3T01
P6T02

M3K and M6K Tripods attach to MAXIS® cable pullers to make underground wire pulls simple and easy.



- Easily attaches to the M3K or M6K cable pullers
- Helps when pulling from transformer pads, vaults and meter bases
- Setup in two minutes
- Helps to pull out extra wire

SPECIFICATIONS

MODEL #	STOCK #	DESCRIPTION
P3T01	568222	Tripod for MAXIS® 3K
SIZE		WEIGHT
Adjustable height: 3ft - 6ft		Adjustable leg width: 13in - 50in
		43 lb.

MODEL #	STOCK #	DESCRIPTION
P6T02	568294	TRIPOD FOR MAXIS® 6K
SIZE		WEIGHT
Adjustable height: 3ft - 6ft		Adjustable leg width: 13in - 50in
		45 lb.



Pulling Accessories | CABLE PULLING

PULLING ROPE

QWIKROPE®



An innovative, high performance pulling rope that is UV resistant, lightweight, and ultra low stretch for all of your feeder and circuit wire needs.

- High performance pulling rope made from ultra high molecular weight polyethylene fibers
- 12 Strand single braided 9/16" pulling rope with a breaking strength of 32,000 lb., pound for pound stronger than steel
- 2 Sizes for all your circuit wire pulls: 1/8" pulling rope with 1,100 lb. of breaking strength, and 1/4" pulling rope with 7,500 lb. of breaking strength
- 24% reduction in the coefficient of friction, as compared to traditional pulling ropes
- Dual factory installed pulling eyes
- Does not absorb water, no rope rot
- Need only one size rope (9/16") for feeder conductor that pulls up to 10,000 pounds
- 1/8" QWIKrope® can easily be vacuumed into any conduit run up to 290 ft.
- 9/16" QWIKrope® recommended for use with all MAXIS® cable pullers

SPECIFICATIONS

MODEL #	STOCK #	DIAMETER	LENGTH	AVG. BREAKING STRENGTH	TOTAL WEIGHT
SPR183	583874	1/8"	300 ft.	1,100 lb.	2.5 lb.
SPR143	583875	1/4"	300 ft.	7,500 lb.	6.5 lb.
SPR146	585263	1/4"	600 ft.	7,500 lb.	11 lb.
SPR963	583056	9/16"	300 ft.	32,000 lb.	26 lb.
SPR966	583057	9/16"	600 ft.	32,000 lb.	52 lb.
SPR969	583058	9/16"	900 ft.	32,000 lb.	77 lb.
SPR9612	583059	9/16"	1,200 ft.	32,000 lb.	103 lb.

DOUBLE BRAIDED PULLING ROPE



Cable pulling rope designed for high breaking strength. The double braid weave provides enhanced strength and increased pulling capability.

- Polyester double braid
- High strength

SPECIFICATIONS

MODEL #	STOCK #	DIAMETER	LENGTH	AVG. BREAKING STRENGTH	TOTAL WEIGHT
P-963	568235	9/16"	300 ft.	14,000 lb.	50 lb.
P-966	568236	9/16"	600 ft.	14,000 lb.	75 lb.
P-583	568237	5/8"	300 ft.	18,000 lb.	63 lb.
P-586	568239	5/8"	600 ft.	18,000 lb.	85 lb.
P-786	568240	7/8"	600 ft.	31,000 lb.	240 lb.
P-789	577913	7/8"	900 ft.	31,000 lb.	269 lb.
P-7812	568241	7/8"	1200 ft.	31,000 lb.	298 lb.

HIGH TENSILE STRENGTH QWIKLINE™ POLY LINE



PL500

Tangle resistant poly line for light duty cable or rope pulling applications.

PL6500



- Ready-to-use storage containers quickly dispense a tangle free line
- Line is resistant to rot and mildew
- Used to pull electrical and communication wire
- 210 lb. tensile strength
- Made in the USA

SPECIFICATIONS

MODEL #	STOCK #	DESCRIPTION			
PL6500	582805	QWIKline™ POLY LINE 6500' 210 Tensile Strength			
PL500	582806	QWIKline™ POLY LINE 6500' 210 Tensile Strength			
	LINE LENGTH	WIDTH	DEPTH	WEIGHT	TENSILE STRENGTH
PL6500	6500'	11"	13"	11.3 lb.	210 lb.
PL500	500'	3"	8"	0.5 lb.	210 lb.



PULLING ROPE

CONDUIT MEASURING TAPE

SWCMT160-3000S



The Conduit Measuring Tape measures 3,000 ft. and has easy-to-read markings in sequential, one-foot increments.

- Provides quick and accurate measurement of conduit runs
- Printed with accurate sequential footage markings
- Will not rot or mildew

SPECIFICATIONS

MODEL #	STOCK #	DESCRIPTION	
SWCMT160-3000S	645849	Conduit Measuring Tape - 160 lb., 3,000 ft. Spool	
	LENGTH	WIDTH	AVG. BREAKING STRENGTH
SWCMT160-3000S	3,000 ft.	3/16"	160 lb.

QWIKTAPE™ PULL TAPE



This pulling tape increases pulling and installation efficiency on jobsites. It allows you to thread, measure, and pull with a single product.

- Durable, low-friction polyester tape
- Printed with accurate sequential footage markings
- Replaces pull line, conduit measuring tape, and rope in most applications
- Low coefficient of friction minimizes duct melting
- Easily blown through conduit

SPECIFICATIONS

MODEL #	STOCK #	DESCRIPTION	
SWMT400-4500P	645850	QWIKtape™ 400 lb. 4,500 ft. Pail	
SWMT1250-3000S	645851	QWIKtape™ 1,250 lb. 3,000 ft. Spool	
SWMT1800-3000S	645852	QWIKtape™ 1,800 lb. 3,000 ft. Spool	
SWMT2500-3000S	645854	QWIKtape™ 2,500 lb. 3,000 ft. Spool	
MODEL #	LENGTH	WIDTH	AVG. BREAKING STRENGTH
SWMT400-4500P	4,500 ft.	1/4"	400 lb.
SWMT1250-3000S	3,000 ft.	1/2"	1,250 lb.
SWMT1800-3000S	3,000 ft.	5/8"	1,800 lb.
SWMT2500-3000S	2,500 ft.	3/4"	2,500 lb.

PULLING GRIPS

MAXIS® GRIPS PULLING HEADS



The MAXIS® GRIPS PULLING HEADS are a dual lock pulling system that uses both a cam lock head and a double braided wire to quickly secure cable to rope without the fear of losing a conductor. These pulling heads provide increased efficiency with 2 minute head preparation.

- Rated at 4,000 lb per conductor.
- Holds securely to NO-LUBE® wire
- Disconnect wire from pulling heads in 2 minutes without cutting the wire
- No cutting, stripping or weaving of wire to make pulling head
- Easily moves through conduit and around 90° bends
- Staggered lengths for easier movement
- Keeps pulling head tight for easier movement through conduit

SPECIFICATIONS

MODEL #	STOCK #	MAXIS GRIPS	GRIPS	WIRE	PULLING JACKET		ROPE SWIVEL		CARRYING	DOUBLE LOCKING HEAD
					MED.	LRG.	LRG.	SML.	BAG	
GP110	568227	Complete Set	Complete Set	1/0 - 750MCM	X	X	X	X	X	
GP00AA	568228	Group AA	4 Grips	1/0 - 4/0						
GP101A	568229	Group A	4 Grips	3/0 - 4/0				X	X	X
GP102B	568230	Group B	4 Grips	250 - 350MCM	X			X	X	X
GP103C	568231	Group C	4 Grips	400 - 500MCM		X	X		X	X
GP104D	568232	Group D	4 Grips	600 - 750MCM		X	X		X	X

PULLING GRIPS

SIMPULL HEAD® PULLING DEVICE



Available in sizes from 8 AWG to 1000 KCMIL the SIMpull™ Pulling head eliminates the need to make up a pulling head on the job site and reduces waste.

- Factory and Field installable pulling grip
- Eliminates the need to make up a pulling head on the job site and reduces waste
- Low profile head eliminates the problem of the head not fitting in the conduit or around a tight turn
- Saves time making pulling heads
- Patented gripping system — factory installed conductors guaranteed not to pull loose during your pull
- Available in 6", 12", 18", 24", and 30" staggered lengths

SPECIFICATIONS

MODEL #	DESCRIPTION
8 AWG SIMpull™ Head Pulling Device	Available in 6", 12", 18", 24", & 30" staggered lengths
6 AWG SIMpull™ Head Pulling Device	Available in 6", 12", 18", 24", & 30" staggered lengths
4 AWG SIMpull™ Head Pulling Device	Available in 6", 12", 18", 24", & 30" staggered lengths
3 AWG SIMpull™ Head Pulling Device	Available in 6", 12", 18", 24", & 30" staggered lengths
2 AWG SIMpull™ Head Pulling Device	Available in 6", 12", 18", 24", & 30" staggered lengths
1 AWG SIMpull™ Head Pulling Device	Available in 6", 12", 18", 24", & 30" staggered lengths
1/0 AWG SIMpull™ Head Pulling Device	Available in 6", 12", 18", 24", & 30" staggered lengths
2/0 AWG SIMpull™ Head Pulling Device	Available in 6", 12", 18", 24", & 30" staggered lengths
3/0 AWG SIMpull™ Head Pulling Device	Available in 6", 12", 18", 24", & 30" staggered lengths
4/0 AWG SIMpull™ Head Pulling Device	Available in 6", 12", 18", 24", & 30" staggered lengths
250 KCMIL SIMpull™ Head Pulling Device	Available in 6", 12", 18", 24", & 30" staggered lengths
300 KCMIL SIMpull™ Head Pulling Device	Available in 6", 12", 18", 24", & 30" staggered lengths
350 KCMIL SIMpull™ Head Pulling Device	Available in 6", 12", 18", 24", & 30" staggered lengths
400 KCMIL SIMpull™ Head Pulling Device	Available in 6", 12", 18", 24", & 30" staggered lengths
500 KCMIL SIMpull™ Head Pulling Device	Available in 6", 12", 18", 24", & 30" staggered lengths
600 KCMIL SIMpull™ Head Pulling Device	Available in 6", 12", 18", 24", & 30" staggered lengths
700 KCMIL SIMpull™ Head Pulling Device	Available in 6", 12", 18", 24", & 30" staggered lengths
750 KCMIL SIMpull™ Head Pulling Device	Available in 9", 15", 21", 27", & 33" staggered lengths
900 KCMIL SIMpull™ Head Pulling Device	Available in 9", 15", 21", 27", & 33" staggered lengths
1000 KCMIL SIMpull™ Head Pulling Device	Available in 9", 15", 21", 27", & 33" staggered lengths

*Individual SIMpull™ head model #'s begins with SPH.
Visit www.southwiretools.com for full product listing.

PULLING GRIPS

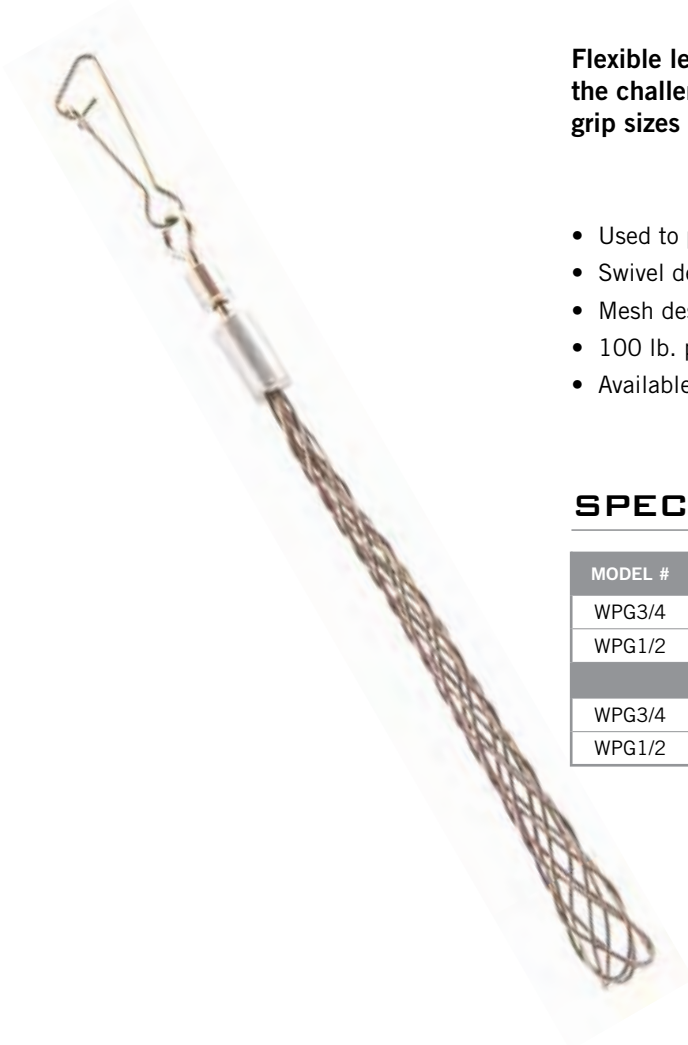

Flexible leader guides steel tapes through conduit and helps reduce the challenge of pulling wire and cable. Available in two separate grip sizes to meet your pulling requirements.

- Used to pull wire and cable through walls and conduit
- Swivel design minimizes cable twisting
- Mesh design holds wire or cable securely during pull
- 100 lb. pulling force capacity
- Available in 1/2" and 3/4" diameters

SPECIFICATIONS

MODEL #	STOCK #	DESCRIPTION				
WPG3/4	582808	3/4" Pulling Grip				
WPG1/2	582810	1/2" Pulling Grip				
	HEIGHT	WIDTH	DEPTH	WEIGHT	DIAMETER	LOAD
WPG3/4	14.25"	0.5"	0.5"	2 oz	3/4"	100 lb.
WPG1/2	14.25"	0.5"	0.5"	2 oz	1/2"	100 lb.

PULLING GRIPS

INDUSTRIAL GRIPIT[®] PULLING DEVICE

Gript[™] Circuit Management System can help make every branch circuit and home run pull safer, easier, and more productive.



- Reusable pulling head
- No need to strip the wire
- Low profile head eliminates the problem of the head not fitting in the conduit or around a tight turn
- Easily attach and remove wires without cutting
- Save time making pulling heads
- Usable on solid and stranded wires from sizes 14AWG to 10AWG
- Staggered lengths (6", 12", 18", 24", & 30" lengths available)

SPECIFICATIONS

MODEL #	STOCK #	DESCRIPTION	LANYARD LENGTH
IG-06	648015	Industrial Gript [™] 6" Pulling Device	6" length
IG-12	648016	Industrial Gript [™] 12" Pulling Device	12" length
IG-18	648017	Industrial Gript [™] 18" Pulling Device	18" length
IG-24	648018	Industrial Gript [™] 24" Pulling Device	24" length
IG-30	648019	Industrial Gript [™] 30" Pulling Device	30" length
IG-KIT	648020	Industrial Gript [™] Pulling Device Kit	Staggered lengths (6", 12", 18", 24", & 30" lengths included)

SIMPULL™ GRIPIT™ CIRCUIT SIZED PULLING HEAD

CSPH1HD

The SIMpull™ GRIPit™ Circuit Sized Pulling Head can help make every branch circuit and home run pull safer, easier, and more productive.



- Easily connects to fish tape, string, or rope
- 14 AWG - 10 AWG solid or stranded conductors
- 600 lb pulling force
- Reusable pulling head for circuit wire
- Easily attach up to 7 wires of 10-14 AWG solid or stranded wires per pulling head
- No cutting, stripping, taping, or weaving wire to make pulling head

SPECIFICATIONS

MODEL #	STOCK #	DESCRIPTION		
CSPH1HD	58294505	SIMpull™ GRIPit™ Circuit Sized Pulling Head		
		WIDTH	DEPTH	WEIGHT
CSPH1HD	1.5"	0.06"	1.3 oz	

FISHING

SIMPULL™ NON-CONDUCTIVE TIP FISH TAPE



The SIMpull™ Non-Conductive Tip Fish Tape has a spiral extruded polymer design that reduces the amount of effort required to push or pull the fish tape through EMT or PVC conduit. It also features a non-conductive leader.

- 75', 100', 125' non-conductive tip fish tape
- High impact, durable case for lasting durability and use
- Non-conductive leader reduces risk of damage to wire jackets
- Leader glows in the dark for easier tracking on low-light conditions
- Spiral extruded polymer allows for faster install time
- Spiral extruded polymer does not rust and will not break when folded
- Weighs less than steel
- 40% lower coefficient of friction than Southwire steel fish tape



Does not break when folded



Weighs less than steel



Does not rust



Faster install time



Glows in the dark

SPECIFICATIONS

MODEL #	STOCK #	DESCRIPTION			
FTSP45-75NCT	630298	SIMpull™ Fish Tape 4.5mm 75'/22.8M, Large Case			
FTSP45-125NCT	631637	SIMpull™ Fish Tape 4.5mm 125'/38.1M, Large Case			
FTSP3-100NCT	630299	SIMpull™ Fish Tape 3mm 100'/30.4M, Medium Case			
	LENGTH	WIDTH	DEPTH	DIAMETER	WEIGHT
FTSP45-75NCT	75'	13"	1.75"	4.5 mm	3.10 lb.
FTSP45-125NCT	125'	13"	1.75"	4.5 mm	2.50 lb.
FTSP3-100NCT	100'	8.75"	1.25"	3 mm	1.20 lb.

SIMPULL™ FLEXIBLE METAL LEADER FISH TAPE



The SIMpull™ Flexible Metal Leader Fish Tape has a spiral extruded polymer design that reduces the amount of effort required to push or pull the fish tape through EMT or PVC conduit.

- 75', 100', 125' flexible metal leader tip fish tape
- High impact, durable case for lasting durability and use
- 360° swiveling leader for ease of guidance through turns
- Spiral extruded polymer allows for faster install time
- Spiral extruded polymer does not rust and will not break when folded
- Weighs less than steel
- 40% lower coefficient of friction than Southwire steel fish tape



Does not break when folded



Weighs less than steel



Does not rust



Faster install time



Swiveling leader

SPECIFICATIONS

MODEL #	STOCK #	DESCRIPTION			
FTSP45-75FML	598970	SIMPull™ Fish tape 4.5mm 75'/22.8M, Large Case			
FTSP45-125FML	598969	SIMPull™ Fish tape 4.5mm 125'/38.1M, Large Case			
FTSP3-100FML	598972	SIMPull™ Fish tape 3mm 100'/30.4M, Medium Case			
	LENGTH	WIDTH	DEPTH	DIAMETER	WEIGHT
FTSP45-75FML	75'	13"	1.75"	4.5 mm	2.2 lb.
FTSP45-125FML	125'	13"	1.75"	4.5 mm	2.5 lb.
FTSP3-100FML	100'	8.75"	1.25"	3 mm	1.20 lb.

SIMPULL™ FISH TAPE TUBE

FTSP45-240FMLT



The 4.5mm 240' SIMpull™ Fish Tape Tube is designed to offer superior performance on long runs. With the same features and benefits as previous models, the fish tape tube is designed for longer runs of up to 240 feet. It also includes both a glow-in-the-dark, non-conductive leader and a flexible metal leader on opposite ends, allowing for usage in both empty and filled conduit.

- Spiral extruded polymer design reduces the amount of effort required to push or pull the fish tape through EMT or PVC conduit
- Combines the strength of a steel fish tape with greater flexibility than fiberglass fish tapes
- Flexible metal leader on one end and non-conductive leader on the opposite end
- 40% lower coefficient of friction than Southwire steel fish tape

SPECIFICATIONS

MODEL #	STOCK #	DESCRIPTION		
FTSP45-240FMLT	631647	SIMPull™ Fish Tape 4.5mm 240' Flexible Metal Leader/Non Conductive, Tube		
	LENGTH	WIDTH	DEPTH	WEIGHT
FTSP45-240FMLT	240'	22.75"	3.4"	3.4 lb.

STEEL FISH TAPE



Southwire's steel fish tape reaches easily above ceilings, under carpets, and through walls to install wire. The fish tape is available in multiple lengths.

- Available in the following lengths: 25', 50', 65', 125', and 240'
- Laser etched footage markings to help identify length of pull
- High impact, durable case for long lasting performance and use
- Specially treated steel fish tape for longer life and easier pulling

SPECIFICATIONS

MODEL #	STOCK #	DESCRIPTION			
FTS1/8-240	582798	1/8" Fish Tape Steel 240'			
FTS1/8-125	582799	1/8" Fish Tape Steel 125'			
FTS1/8-65	582800	1/8" Fish Tape Steel 65'			
FTS1/8-50	582801	1/8" Fish Tape Steel 50'			
FTS1/8-25	582802	1/8" Fish Tape Steel 25'			
FTS1/4-25	582797	1/4" Flat Fish Tape 25', flat plastic tip			
	LENGTH	WIDTH	DEPTH	WEIGHT	TAPE WIDTH
FTS1/8-240	240'	7"	1.75"	7.4 lb.	1/8"
FTS1/8-125	125'	13"	1.75"	4.4 lb.	1/8"
FTS1/8-65	65'	8.75"	1.13"	2.4 lb.	1/8"
FTS1/8-50	50'	8.75"	1.13"	1.6 lb.	1/8"
FTS1/8-25	25'	7"	1.00"	0.8 lb.	1/8"
FTS1/4-25	25'	7"	1.00"	0.8 lb.	1/4"

FISH TAPE LEADER

FTFL13



Flexible leader guides steel tapes through conduit and helps reduce the challenge of pulling and pushing.

- Flexible 13" leader easily attaches to 1/8" steel fish tapes
- Assists in guiding steel fish tapes through conduit turns and bends

SPECIFICATIONS

MODEL #	STOCK #	DESCRIPTION				
FTFL13	582807	Fish Tape Leader 13" for Steel Fish Tapes				
	LENGTH	WIDTH	DEPTH	WEIGHT	DIA.	EYELET CAPACITY
FTFL13	14.25"	0.38"	0.25"	2 oz	3/16"	5 X 12 AWG Unstripped, 7 X 10 AWG Bare

SIMPULL™ FISH TAPE LEADER REPLACEMENT KIT



The SIMpull™ Fish Tape Leader Replacement Kit keeps you from having to purchase another fish tape should your leader need replacing.

- Allows for quick replacement of fish tape leaders in the field
- Includes both flexible metal leaders and non-conductive leaders
- 2 non-conductive leaders, 2 flexible metal leaders, threading die, and adhesive included.

SPECIFICATIONS

MODEL #	STOCK #	DESCRIPTION			
FTSP4.5FML-LRKIT	642776	4.5MM NCT/FML SIMpull™ Fish Tape Leader Replacement Kit			
FTSP3.0FML-LRKIT	642779	3.0MM NCT/FML SIMpull™ Fish Tape Leader Replacement Kit			
MODEL #	HEIGHT	WIDTH	DEPTH	WEIGHT	
FTSP4.5FML-LRKIT	4"	9.75"	5.75"	1.05 lb.	
FTSP3.0FML-LRKIT	4"	9.75"	5.75"	1.05 lb.	
MODEL #	INCLUDES				
FTSP4.5FML-LRKIT	(2) non-conductive leaders, (2) flexible metal leaders, (1) sharpener, (1) threading die, adhesive				
FTSP3.0FML-LRKIT	(2) non-conductive leaders, (2) flexible metal leaders, (1) sharpener, (1) threading die, adhesive				

GLOW-IN-THE-DARK FISH STICK



Make fishing through walls or over ceilings easier with our Glow-in-the-Dark Fish Sticks.

- Luminescent fiberglass rods glow in the dark and recharge with most available light sources
- 3/16" flexible rods resist splintering and cracking
- Individual sections easily screw together to form single rod
- Includes bullet nose with eyelet and hook attachments

SPECIFICATIONS

MODEL #	STOCK #	DESCRIPTION			
FS15	582793	15' Glow-in-the-Dark Fish Stick (Includes Bullet Nose with Eyelet & Hook Attachments)			
FS12	582794	12' Glow-in-the-Dark Fish Stick (Includes Bullet Nose with Eyelet & Hook Attachments)			
FS8	582795	8' Glow-in-the-Dark Fish Stick (Includes Bullet Nose with Eyelet & Hook Attachments)			
	ASSEMBLED LENGTH	WIDTH	DEPTH	WEIGHT	STICK LENGTH
FS15	180"	0.19"	0.19"	13.3 oz	3x5' Pieces
FS12	144"	0.19"	0.19"	13.9 oz	3x4' Pieces
FS8	96"	0.19"	0.19"	8 oz	4x2' Pieces

SLIDE-IT

SFB01



Slide-It is made for pulling applications to protect cable and rope as it enters the conduit.

- Embedded magnets for quick set up on panels
- Made from durable material
- Tapered end for fast set up in conduit
- Protects rope and cable from sharp panel edges and openings

SPECIFICATIONS

MODEL #	STOCK #	DESCRIPTION		
SFB01	591589	Slide-it		
	LENGTH	WIDTH	DEPTH	WEIGHT
SFB01	1/8" (height)	12"	40.5"	1.25 lb.

ACCESSORIES

GUIDEIT™ CIRCUIT ROUTER

WG01



A wire router for circuit panel and junction boxes.

- Universal adapter for hands free circuit wire feeding
- Routes circuit wire in enclosures up to 32"
- Helps to prevent any damage to wire during installation
- Reduces the need to route circuit wire into a raceway or conduit

SPECIFICATIONS

MODEL #	STOCK #	DESCRIPTION		
WG01	583873	GUIDE IT™ Circuit Router		
	HEIGHT	WIDTH	DEPTH	WEIGHT
WG01	2.5"	7.5"	23"	2 lb.

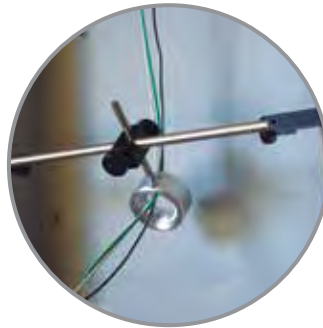

TERMINATION

Southwire™ Termination Line of tools sets a new industry Standard. We've revolutionized these tools to make them faster, safer, and smarter than ever before. With Southwire cable stripping, cutting and crimping tools on your job site you can see an increase in safety, efficiency, and profitability.

- Wire Strippers
- Seatek™ Series
- Cutting
- MAXTERM™ Crimping



WIRE STRIPPERS

XT CABLE STRIPPER

XTS01
XTS01RB



The XTS-01 Cable Stripper is made for end and mid-span terminations of 600 volt 1/0 AWG to 1000 KCMIL or outside diameters from .33"-1.284". Works on THHN, XHHW, RHH, RHW, and USE jackets.

- Cutting depth is adjustable to precisely match insulation thickness for fast stripping while eliminating cable scoring
- Adjustable 4" depth gauge provides consistent repeatable strips
- Replaceable, precision razor sharp blade that is safely enclosed within the tool, eliminates stripping cables with a knife
- Capacity : wire 1/0 AWG (.33" in diameter) in size to 1000 KCMIL (approx. 1.284" diameter)

SPECIFICATIONS

MODEL #	STOCK #	DESCRIPTION		
XTS-01	649849	XT Cable Stripper		
XTS01RB	593689	XTS-01 Cable Stripper Replacement Blade Kit		
	HEIGHT	WIDTH	DEPTH	WEIGHT
XTS-01	8.5"	2.5"	2.25"	1.30 lb.
XTS01RB	1"	3/8"	3/8"	3gm



WIRE STRIPPERS

XT MINI STRIPPER

XTS02
XTS02RB



XT Mini Stripper for sizes #6 AWG through 1/0 AWG

- For end termination on THHN/XHHW 600V insulation types
- Cutting depth is self setting to eliminate cable scoring
- Replaceable blade that is safely enclosed within the housing
- Capacity: Wire sizes #6 AWG through 1/0 AWG

SPECIFICATIONS

MODEL #	STOCK #	DESCRIPTION	LENGTH	WIDTH	HEIGHT	WEIGHT
XTS02	598946	XT Mini Stripper	1.2"	1.38"	5"	.38 lb.
XTS02RB	599735	XT Mini Stripper Replacement Blade Kit	1/2"	1/4"	5/16"	2.34 gm

XT CABLE STRIPPER COMBO KIT

XTC100

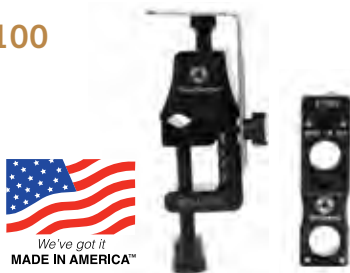

XTC100 Combination Stripper Kit Includes XTS01 and XTS02. Strips wire and cable from #6 AWG-1000 KCMIL

SPECIFICATIONS

MODEL #	STOCK #	DESCRIPTION	LENGTH	WIDTH	HEIGHT	WEIGHT
XTC100	598945	XT Cable Stripper Combo Kit	10"	10"	3"	2.9 lb.

ORIGINAL ROTO-SPLIT® CUTTER

RS-101



The Seatek™ RS-101 will become your everyday cutter for MC Cable. It features a thumb screw to clamp and release the cable. It is simple, straight forward, and easy to use. You'll never do another MC Cable job without it. Proudly made in the USA.

- Cuts and strips any armored cable from AWG 14-2 to 10-4 as well as AC, MC & HCF cables
- After initial setting only a half turn of the thumb screw is needed to clamp or release the cable
- Make cuts quickly and easily in tight quarters
- Durable die cast epoxy-enameled body

SPECIFICATIONS

MODEL #	STOCK #	DESCRIPTION		
RS-101	598165	Original RS-101 Roto-Split® Cutter		
WEIGHT	MIN OPENING	MAX OPENING	FLEX (TRADE SIZE)	AWG (SOLID) OR MC RANGE
1.2 lb.	0.375	0.75	3/8"	14-2 to 8-4

SUPER ROTO-SPLIT® CUTTER

RS-101A



The Seatek™ RS-101A works great, and provides clean cuts with no sharp edges. There is a blade storage cartridge in the knob with room for up to 6 spare blades. It is durable and perfect for the electrician. Proudly made in the USA.

- Cuts and strips any armored cable from AWG 14-2 to 10-4 as well as AC, MC, BX & HCF cables
- No adjustment after initial setting - quick clamp lever does it all
- Make cuts quickly and easily in tight quarters
- Durable die cast epoxy-enameled body
- Blade storage cartridge in knob with storage for 6 blades

SPECIFICATIONS

MODEL #	STOCK #	DESCRIPTION		
RS-101A	598166	RS-101A Super Roto-Split® Cutter		
WEIGHT	MIN OPENING	MAX OPENING	FLEX (TRADE SIZE)	AWG (SOLID) OR MC RANGE
1.2 lb.	0.375	0.75	3/8"	14-2 to 8-4

SEATEK™ SERIES

AUTOMATIC ROTO-SPLIT® CUTTER

RS-101AC



The Seatek™ RS-101AC features a clamping system that covers the complete cable size range without using a thumb screw. The self-tightening blade system prevents you from damaging the cable. There is a blade storage cartridge in the knob with room for up to 6 spare blades. Everyone who works with MC cable should own one of these. The RS-101AC is durable and great for the electrician. Proudly made in the USA.

- Automatically adjusts the clamping pin to the correct diameter
- Safely cut any type of armored cable by automatically adjusting to the cable diameter
- Self-tightening blade system and ergonomic crank handle with offset for maximum hand clearance
- Depth of cut adjustment for standard MC cable and smaller diameter MC cable

SPECIFICATIONS

MODEL #	STOCK #	DESCRIPTION		
RS-101AC	598167	RS-101AC Automatic Roto-Split® Cutter		
WEIGHT	MIN OPENING	MAX OPENING	FLEX (TRADE SIZE)	AWG (SOLID) OR MC RANGE
1.2 lb.	0.375	0.75	3/8"	14-2 to 8-4

ROTARY CABLE CUTTER

MCCUT



Easily handles all common MC, BX, and flex cables. Securely holds cable in place and releases quickly.

- Quickly splits the armored jacket on 14-2 to 10-4 armored cables and 3/8" flexible conduit with a few turns of the handle
- Adjustable cutting depth for standard and reduced diameter BX/MC cables
- Stores up to 6 extra blades in handle knob
- Durable die cast epoxy enameled construction

SPECIFICATIONS

MODEL #	STOCK #	DESCRIPTION		
MCCUT	582822	BX MC Rotary Cutter w/Lever		
MCBLADE	582823	BX MC Replacement Blade (1 blade/pack)		
	HEIGHT	WIDTH	DEPTH	WEIGHT
MCCUT	7.5"	1.75"	3.5"	19 oz
MCBLADE	1"	1"	0.06"	0.1 oz

1/2" – 3/4" ROTO-FLEX™ CUTTER

RF-120A



The Seatek™ RF-120A provides clean cuts and does not require adjustments after the initial setting. Cutting in tight quarters is easy and fast. The self-tightening blade system prevents you from damaging the cable. The RF-120A includes a blade storage cartridge in the knob with room for up to 6 spare blades. Great for the electrician. Proudly made in the USA.

- Cuts 1/2" to 3/4" O.D. flex
- Strips large AC, BX, MC cables ranging from AWG 2-3, 3-4, & 4-3
- Blade storage cartridge in knob with storage for 6 blades
- Requires no adjustment after initial setting - quick clamp lever does it all
- Die cast epoxy-enamel body

SPECIFICATIONS

MODEL #	STOCK #	DESCRIPTION		
RF-120A	598162	RF-120A 1/2" – 3/4" Roto-Flex™ Cutter		
WEIGHT	MIN OPENING	MAX OPENING	FLEX (TRADE SIZE)	AWG (SOLID) OR MC RANGE
1.25 lb.	0.75	1.13	1/2" - 3/4"	4-4 to 2-4

SEATEK™ SERIES

GIANT ROTO-FLEX™ CUTTER

RF-170



The Seatek™ RF-170 cuts up to 1-1/2" flex or armored cable in seconds leaving a clean end. It is light weight to keep in your side pouch and heavy enough to last for years. It makes cutting BX and Greenfield conduit easy and precise. Cutting in tight quarters is easy and fast. The self-tightening blade system prevents you from damaging the cable. The RF-170 includes a blade storage cartridge in the knob with room for up to 6 spare blades. Perfect for the electrician. Proudly made in the USA.

- Cuts 1/2" – 1-1/2" O.D. flex and cuts 4-2 to 2-4 MC cable
- Sliding top with three cutting positions to cut across the convolutions of large diameter cables
- Unique adjustable cable clamping bracket with 1 inch
- Blade storage cartridge in knob with storage for 6 blades
- Die cast epoxy-enameled body
- B-102 blade can be used with steel casing

SPECIFICATIONS

MODEL #	STOCK #	DESCRIPTION		
RF-170	598164	RF-170 Giant Roto-Flex™ Cutter		
WEIGHT	MIN OPENING	MAX OPENING	FLEX (TRADE SIZE)	AWG (SOLID) OR MC RANGE
1.2 lb.	0.82	1.13	1/2" - 1-1/2"	4-2 to 2-4

STRIP-ALL® STRIPPER WITH KNIFE

SA-200SK



The Seatek™ SA-200SK is perfect for stripping flat cable. It is a very helpful tool that makes stripping cable faster. It can straight cut jacketed cables up to 5/8" and ring cut cables up to 1/2". Great for the electrician. The best part? This tool is proudly made in the USA.

- Extremely accurate
- Calibrated micrometer dial for precise depth of cut adjustment
- Handy, built-in wire stripper on all models
- Equipped with an extra-sharp, surgical type blade cartridge which easily slices through cable jackets

SPECIFICATIONS

MODEL #	STOCK #	DESCRIPTION	WEIGHT	MIN OPENING	MAX OPENING	OVERALL LENGTH	AWG (SOLID) OR MC RANGE
SA-200SK	598173	SA-200SK Strip-All® Stripper with Knife	0.25 lb.	1/4	5/8	5-1/4"	4/0

STRIP-ALL® STRIPPER WITHOUT KNIFE

SA-200S



The Seatek™ SA-200S is perfect for stripping flat cable. It is a very helpful tool that makes stripping cable faster. It can straight cut jacketed cables up to 5/8" and ring cut cables up to 1/2". Great for the electrician. The best part? This tool is proudly made in the USA.

- Extremely accurate
- Calibrated micrometer dial for precise depth of cut adjustment
- Handy, built-in wire stripper on all models
- Equipped with an extra-sharp, surgical type blade cartridge which easily slices through cable jackets

SPECIFICATIONS

MODEL #	STOCK #	DESCRIPTION	WEIGHT	MIN OPENING	MAX OPENING	OVERALL LENGTH	AWG (SOLID) OR MC RANGE
SA-200S	598172	SA-200SK Strip-All® Stripper without Knife	0.25 lb.	1/4	5/8	5-1/4"	4/0

SEATEK™ SERIES

LARGE STRIP-ALL® STRIPPER

SA-200L



The Seatek™ SA-200L is a handy tool to keep in your tool bag. It is great for cutting welding cable and cuts up to 7/8" cables. The SA-200L is a safer alternative to hook knives on the jobsite. Great for the electrician. Proudly made in the USA.

- Make straight or ring cuts
- Calibrated micrometer dial for precise depth of cut adjustment
- Ships with replacement blade cartridge stored in top housing

SPECIFICATIONS

MODEL #	STOCK #	DESCRIPTION		
SA-200L	598171	SA-200L Large Strip-All® Stripper		
WEIGHT	MIN OPENING	MAX OPENING	FLEX (TRADE SIZE)	AWG (SOLID) OR MC RANGE
0.25 lb.	3/8	7/8	5-1/4"	14-2 to 6-3

JACKET RIPPER

JR-128



We've got it
MADE IN AMERICA™

The Seatek™ JR-128 Jacket Ripper does just that - it makes removing cable jackets an easy process. Our lightweight Jacket Ripper prevents the nicking of internal conductors while precisely cutting through layers of medium and large multi conductor cable. This tool is a safer alternative to razor blades or knives, and can help you get the job done. The JR-128 is made in the USA.

- Used on entrance cable, Plenum, multi-pair, and tray cables
- Used to strip plastic jackets from liquid-tight, flex, or MC
- Works best on cables with loose jackets of 1/2" O.D. and larger
- Blade can be easily replaced
- Body is nickel plated steel for increased durability

SPECIFICATIONS

MODEL #	STOCK #	DESCRIPTION		
JR-128	59816001	JR-128 Jacket Ripper		
	WEIGHT	HEIGHT	WIDTH	DEPTH
JR-128	0.02 lb.	5.75"	2.25"	.25"

VEE-TWIN™ STRIPPER

VT-270



We've got it
MADE IN AMERICA™

The Vee-Twin™ Stripper makes it easy to strip difficult rubber cable as well as plastic jacket cables with its 90° rotating blade, which can be used for ring-cutting and straight-cutting. The VT-270 is perfect for precise cuts in thick cable. It is also great for stripping bulk amounts of cable. Proudly made in the USA.

- Depth of cut setting is extremely accurate to .001" due to a precision micrometer
- Useful for cable sizes ranging from 5/16" to 2-1/8" O.D.
- Used on entrance cable, plenum, multi-pair, and tray cables
- Strips plastic jackets from liquid-tight, flex, or MC
- Blade can be easily replaced
- Body is nickel plated steel for increased durability

SPECIFICATIONS

MODEL #	STOCK #	DESCRIPTION		
VT-270	598177	VT-270 Vee-Twin™ Stripper		
WEIGHT	MIN OPENING	MAX OPENING	MAX CUT DEPTH	AWG (SOLID) OR MC RANGE
0.7 lb.	5/16"	2-1/8"	1/4"	14-2 to 4/0

SEATEK™ SERIES

ROTO-SPLIT® AND ROTO-FLEX™ STANDARD BLADE

B-102



The Seatek™ B-102 Standard Blade is the replacement blade for all Roto-Split® and Roto-Flex™ models. This is an essential when installing MC cable. The B-102 is the perfect backup blade for your Roto-Split® and Roto-Flex™ cutters. Great for the electrician. Proudly made in the USA.

- Sold in packs of 2
- Blade used to cut steel casing
- Replacement blade for all Roto-Split® and Roto-Flex™ models

SPECIFICATIONS

MODEL #	STOCK #	DESCRIPTION	WEIGHT	HEIGHT	WIDTH	DEPTH
B-102	598144	B-102 Roto-Split® and Roto-Flex™ Standard Blade				
B-102			0.025 lb.	1.22"	1.22"	.02"

OFFSET TEETH BLADE

B-107



The Seatek™ B-107 is a heavy-duty, universal blade that can be used on all Roto-Flex™ tools. It cuts through aluminum armor clad with minimal effort. It can also cut through steel armor on 1/2" and larger trade size flex. Need a backup blade? This is a great replacement blade for aluminum casing. Perfect for the electrician. Proudly made in the USA.

- Offset teeth to prevent clogging
- Used to cut aluminum casing
- For use with all Roto-Flex™ models
- Not for use with the RS-101AC

SPECIFICATIONS

MODEL #	STOCK #	DESCRIPTION	WEIGHT	HEIGHT	WIDTH	DEPTH
B-107	598149	B-107 Offset Teeth Blade				
B-107			0.025 lb.	1.25"	1.25"	.02"

MOTORIZED TOOL BLADE

B-108



The Seatek™ B-108 is a heavy-duty blade that can be used on all Roto-Split® and Roto-Flex™ power tools and automatic machines. Perfect for the electrician. Proudly made in the USA.

- Blade for all Rotomatic power tools and machines

SPECIFICATIONS

MODEL #	STOCK #	DESCRIPTION		
B-108	59815101	B-108 Motorized Tool Blade		
	WEIGHT	HEIGHT	WIDTH	DEPTH
B-108	0.025 lb.	1.25"	1.25"	.02"



SA-200 BLADE

B-202

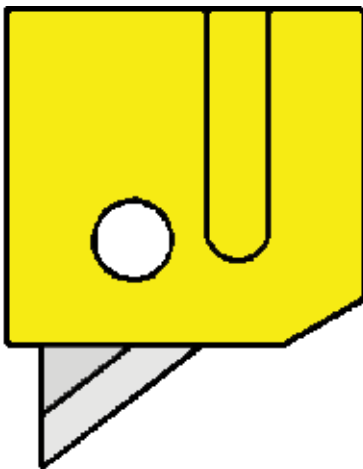

The Seatek™ B-202 is a heavy-duty replacement blade for the SA-200 Strip-All® stripper. The blade is easy to replace and makes a great backup. Perfect for the electrician. Proudly made in the USA.

- B-202 blade cartridge for the Strip-All® stripper
- Used with Strip-All® models
- Sold in packages of two

SPECIFICATIONS

MODEL #	STOCK #	DESCRIPTION		
B-202	598154	B-202 SA-200 Blade		
	WEIGHT	HEIGHT	WIDTH	DEPTH
B-202	0.025 lb.	.75"	.19"	1.50"



SEATEK™ SERIES

JR-128 BLADE

B-228



The Seatek™ B-228 is a heavy-duty replacement blade for the JR-128 Jacket Ripper. The blade is easy to replace and is a necessity for your JR-128. Great for the electrician. Proudly made in the USA.

- B-228 blade cartridge for the JR-128 Jacket Ripper
- Easy to install
- Sold in packages of two

SPECIFICATIONS

MODEL #	STOCK #	DESCRIPTION		
B-228	598156	B-228 JR-128 Blade		
	WEIGHT	HEIGHT	WIDTH	DEPTH
B-228	0.05 lb.	.88"	.25"	.50"

VT-270 BLADE

B-272



The Seatek™ B-272 is a heavy-duty replacement blade for the VT-270 Vee-Twin™ stripper. It is concealed in the tool for safety. The blade is easy to replace and is a necessity for your VT-270. Great for the electrician. Proudly made in the USA.

- B-272 blade for the VT-270 Vee-Twin™ stripper
- Easy to install
- Sold in packages of two

SPECIFICATIONS

MODEL #	STOCK #	DESCRIPTION		
B-272	598158	B-272 VT-270 Blade		
	WEIGHT	HEIGHT	WIDTH	DEPTH
B-272	0.025 lb.	.75"	.25"	.06"

SA-200 ADAPTER

A-201



The Seatek™ A-201 is the adapter that makes stripping and cutting cable simple. This easy to use tool is perfect for when you need to quickly strip and ring cut small cables from sizes 1/8" to 1/4" in diameter. With its accommodating size, this hand-held tool is a helpful tool for electricians. This adapter was proudly made in the USA.

- For use on the Strip-All® SA-200S and SA-200SK
- Not compatible with Strip-All® SA-200L
- Not for use on the Strip-All® SA-200L

SPECIFICATIONS

MODEL #	STOCK #	DESCRIPTION			
A-201	598142	A-201 SA-200 Adapter			
		MIN. OPENING	MAX. OPENING	OVERALL LENGTH	WEIGHT
A-201	5	.50"	.13"	.13"	0.02 lb.

WISE MOUNT ADAPTER

A-271



This Seatek™ Vise Mount Adapter pairs enables you to collect and recover scrap material as it gathers. It pairs with the Vee-Twin™ stripper and makes removing cable jackets easy. This product is proudly made in America.

- Adapter for the Vee-Twin™ stripper
- Attach the A-271 to the Vee-Twin™ stripper and clamp it in a vise
- Pull the cable through the Vee-Twin™ stripper to remove long lengths of cable jackets
- Simply remove long lengths of cable jackets

SPECIFICATIONS

MODEL #	STOCK #	DESCRIPTION			
A-271	598143	A-271 Vise Mount Adapter			
		WEIGHT	HEIGHT	WIDTH	DEPTH
A-271	0.02 lb.	2"	2.25"	0.38"	

SEATEK™ SERIES

LUBRICANT STICK

LS-105



The Seatek™ LS-105 is a lubricant stick for all Roto-Split®, Roto-Flex™, and Rotomatic model blades. It is not to be used when cutting aluminum.

- Lubricant stick for all Roto-Split® cutter, Roto-Flex™ cutter, and Rotomatic blades. It is not to be used when cutting aluminum.
- Not for use when cutting aluminum

SPECIFICATIONS

MODEL #	STOCK #	DESCRIPTION
LS-105	598161	Lubricant Stick
INCLUDES		
LS-105		Lubricant Stick

HANDLE KIT

101-110



Handle assembly for all models of the Roto-Split® and Roto-Flex™ models with blade storage knob.

- Blades not included

SPECIFICATIONS

MODEL #	STOCK #	DESCRIPTION
101-110	598181	Handle Kit
INCLUDES		
101-110		Full handle assembly

RETROFIT HARDWARE KIT

101-106

Spare parts kit for the Roto-Split® & Roto-Flex™ cutters.



Includes:

- 1 shaft
- 1 nut
- 1 #4-40 screw
- 1 thumb screw for the RS-101

SPECIFICATIONS

MODEL #	STOCK #	DESCRIPTION
101-106	598180	Retrofit Hardware Kit
INCLUDES		
101-106	One shaft, one nut, one #4-40 screw, one thumb screw for the RS-101	

POWER CONVERSION KIT

101-107

Motorize any Roto-Split® and Roto-Flex™ cutter.



Includes:

- B-108 blade
- Shaft
- Screw
- Washers
- Hex nut
- Hex wrench

SPECIFICATIONS

MODEL #	STOCK #	DESCRIPTION
101-107	598179	Power Conversion Kit
INCLUDES		
101-107	B-108 blade, shaft, screw, washers, hex nut, hex wrench	

CUTTING

MAXTERM™ 6-TON CUTTER & BLADES

SCU6-S



SCU6-AL



STJB-CUAL



STJB-ACSR



Powerful 6-Ton hydraulic cutting platform.

- Brushless motor
- Milwaukee M18 REDLITHIUM™ 2.0AH battery delivers 250+ cuts on 500 MCM per charge
- ACSR Blade cuts up to 477 hen and rebar up to 3/8"
- CU/AL blade cuts up to 750MCM copper and 1000MCM aluminum
- Multiple cutting kits available
- Fully balanced to reduce user fatigue
- Hydraulic system is optimized for consistent performance from 0°F to 122°F
- LED lights illuminates work area
- Hydraulic pressure relief button for manual return
- Single trigger operation, cut in the most confined spaces
- Interchangeable jaws for different cutting applications
- Fully balanced design for improved control and ergonomics
- Weather protected electronics keep dirt, dust, and moisture out
- Each kit includes 1 platform, 1 cutter jaw, 1 battery charger, 1 battery, 1 cutting blade

SPECIFICATIONS

MODEL #	STOCK #	DESCRIPTION
SCU6-S	595227	MAXTERM™ 6-Ton Cutter w/ ACSR Blades
		LENGTH WIDTH HEIGHT WEIGHT
SCU6-S		16.5" 23" 5.5" 18 lb.

MODEL #	STOCK #	DESCRIPTION
SCU6-AL	595226	MAXTERM™ 6-Ton Cutter w/ CU/AL Blades
		LENGTH WIDTH HEIGHT WEIGHT
SCU6-AL		16.5" 23" 5.5" 18 lb.

MODEL #	STOCK #	DESCRIPTION
STJ6-CUAL	595228	6-Ton CU/AL Jaw
STJB-CUAL	595230	Replacement Blades CU/AL
		LENGTH WIDTH HEIGHT WEIGHT
STJ6-CUAL		6.18" 6.93" 3.23" 3.13 lb.
STJB-CUAL		1" 6" 8" 1 lb.

MODEL #	STOCK #	DESCRIPTION
STJ6-ACSR	595229	6-Ton ACSR Jaw
STJB-ACSR	595231	Replacement Blades ACSR
		LENGTH WIDTH HEIGHT WEIGHT
STJ6-ACSR		6.18" 6.93" 3.23" 2.76 lb.
STJB-ACSR		1" 6" 8" 1 lb.

TELESCOPIC RATCHETING CABLE CUTTER

CCPR1K



The Telescopic Ratcheting Cable Cutter cuts up to 1,000 MCM copper and aluminum cables. Telescoping handles extend for added leverage.

- Optimized blade design cuts cables without crushing them
- Cuts up to 1,000 MCM copper and aluminum cables
- Cuts 1.75" armored cable
- Heavy duty, replaceable cutting blade

SPECIFICATIONS

MODEL #	STOCK #	DESCRIPTION			
CCPR1K	587383	CCPR1K Ratcheting Cable Cutters 1000 Cu/Al w/Telescoping Handles			
	HEIGHT	WIDTH	DEPTH	WEIGHT	
CCPR1K	1.38"	4.5"	15.5"	4.95 lb.	

CABLE CUTTERS

CCPR400



The blades on these heavy duty cutters ensure consistent cuts and long-term durability while the rounded blade design minimizes cable distortion during cutting.

- Replaceable, hardened steel blades provide long lasting cutting of copper and aluminum cables
- Two-step ratcheting mechanism for fewer strokes per cut

SPECIFICATIONS

MODEL #	STOCK #	DESCRIPTION			
CCPR400	582777	Ratcheting Cable Cutter			
	HEIGHT	WIDTH	DEPTH	WEIGHT	
CCPR400	10.25"	5.5"	1.25"	31 oz	
*MAXIMUM CUTTING POWER (COPPER)			*MAXIMUM CUTTING POWER (ALUMINUM)		
750 MCM			1000 MCM		

*Note: Maximum cutting capacity is for single conductor wires

CUTTING

COMPACT RATCHETING CABLE CUTTER

CCPR400S



The CCPR400S Compact Ratcheting Cable Cutter is designed for smaller cutting applications. It cuts up to 600 MCM copper and aluminum cables.

- Hardened steel-cutting blades provide sharpness and lasting strength
- Cuts up to 600 MCM copper and aluminum cables
- Two-step ratcheting mechanism for few strokes per cut
- Quick-release lever opens blade at any time during operation

SPECIFICATIONS

MODEL #	STOCK #	DESCRIPTION		
CCPR400S	595562	CCPR400S 600 MCM Ratcheting Cable Cutter		
	HEIGHT	WIDTH	DEPTH	WEIGHT
CCPR400S	9.25"	4"	9.25"	1.5 lb.

31-1/2" UTILITY CABLE CUTTER WITH FIBERGLASS HANDLES

CCP750



This heavy duty cable cutter is strong and lightweight. It features fiberglass handles and cuts up to 750 MCM copper cables.

- Adjustable pivot bolt provides for easy blade adjustment
- Strong fiberglass handles for easy cutting
- Curved blade jaws hold cable while blades make efficient clean cuts
- Cuts up to 750 MCM copper, 1000 MCM aluminum, and 1-1/2" diameter communications cables

SPECIFICATIONS

MODEL #	STOCK #	DESCRIPTION		
CCP750	587382	31-1/2" Utility Cable Cutter 750 Cu w/ Fiberglass Handles		
	HEIGHT	WIDTH	DEPTH	WEIGHT
CCP750	31.5"	6.75"	0.2"	4 lb.

16" UTILITY CABLE CUTTER WITH COMFORT GRIP HANDLES

CCP350



With a cutting capacity of 350 MCM on copper cables, these cable cutters are jobsite ready.

- Heat-treated, precision-ground blades ensure clean cuts
- Comfortable cushion grips reduce hand fatigue
- Cuts up to 350 MCM copper
- Hinge bolt with pin-set nut for proper blade tension
- Drop forged 6150 steel with black-oxide finish for long life

SPECIFICATIONS

MODEL #	STOCK #	DESCRIPTION		
CCP350	US: 591585	16" Utility Cable Cutter 350 Cu/Alv w/ Comfort Grip Handles		
CCP350	CAD: 591586	16" Utility Cable Cutter 350 Cu/Alv w/ Comfort Grip Handles		
	HEIGHT	WIDTH	DEPTH	WEIGHT
CCP350	17"	5"	1.15"	2.75 lb.

MAXTERM™ CRIMPING

MAXTERM™ 6-TON UTILITY CRIMPER

SCR6-BG
SCR6-O
SCR6-SN



Powerful 6-Ton hydraulic cutting platform.

- Brushless Motor
- Milwaukee M18 REDLITHIUM™ 2.0AH battery deliver 250+ crimps on 500 MCM per charge
- 350 degree rotation
- Autorelease once complete crimp is accomplished
- Hydraulic system is optimized for consistent performance from 0°F to 122°F
- LED Lights illuminates work area
- Hydraulic pressure relief button for manual return
- Single trigger operation, crimps in the most confined spaces
- Interchangeable jaws for different crimping and cutting applications
- Fully balanced design for improved control and ergonomics
- Weather protected electronics keep dirt, dust, and moisture out
- Kit includes 1 platform, 1 crimper jaw, 1 battery charger, 2 batteries

SPECIFICATIONS

MODEL #	STOCK #	DESCRIPTION		
SCR6-BG	595171	MAXTERM™ 6-Ton Utility Crimper w/ BG Jaw		
LENGTH	WIDTH	HEIGHT	WEIGHT	
SCR6-BG	16.5"	23"	5.5"	18 lb.

MODEL #	STOCK #	DESCRIPTION		
SCR6-O	595172	MAXTERM™ 6-Ton Utility Crimper w/ O Jaw		
LENGTH	WIDTH	HEIGHT	WEIGHT	
SCR6-O	16.5"	23"	5.5"	18 lb.

MODEL #	STOCK #	DESCRIPTION		
SCR6-SN	595173	MAXTERM™ 6-Ton Utility Crimper w/ Snub Nose Jaw		
LENGTH	WIDTH	HEIGHT	WEIGHT	
SCR6-SN	16.5"	23"	5.5"	18 lb.

"W" STYLE DIES

SDW-TREE



Individual "W" Style Dies

- Clearly marked for easy identification
- Stainless steel resists rust
- Compatible with all crimping tools that accept "W" style Dies
- Easily storable on "W" Die Tree

SPECIFICATIONS

INDIVIDUAL "W" DIES

PART#	STOCK#	DESCRIPTION
SDW-TREE	595179	W Die Tree
SDW-BG	595180	W Style Die: W-BG
SDW-O	595181	W Style Die: W-O
SDW-C	595182	W Style Die: W-C
SDW-K840	595183	W Style Die: W-K840
SDW-161	595184	W Style Die: W-161
SDW-162	595185	W Style Die: W-162
SDW-163	595186	W Style Die: W-163
SDW-164	595187	W Style Die: W-164
SDW-165	595188	W Style Die W-165
SDW-166	595189	W Style Die: W-166
SDW-237	595190	W Style Die: W-237
SDW-239	595191	W Style Die: W-239
SDW-243	595192	W Style Die: W-243
SDW-247	595193	W Style Die: W-247
SDW-249	595194	W Style Die: W-249

UTILITY CRIMPER JAWS

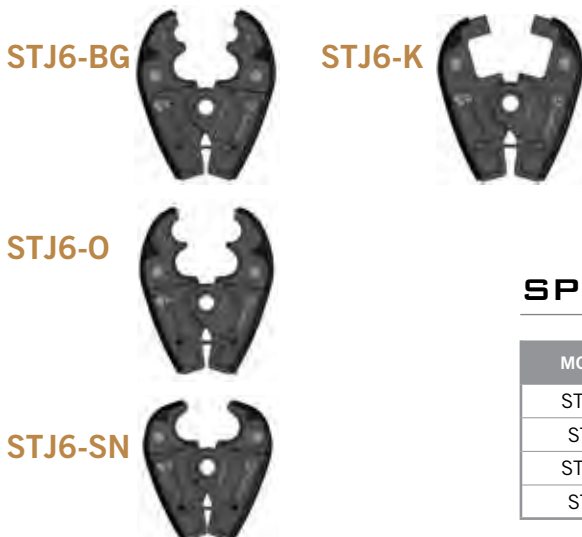

SPECIFICATIONS

MODEL #	STOCK #	DESCRIPTION
STJ6-BG	595175	Seated BG Jaw
STJ6-O	585176	Seated O Jaw
STJ6-SN	595177	Snub-Nosed Jaw
STJ6-K	595178	Kearny Jaw

MAXTERM™ CRIMPING

MAXTERM™ 6-TON COMMERCIAL CRIMPER W/ U JAW

SCR6-C



Powerful 6-Ton hydraulic crimping platform.

- Brushless Motor
- Milwaukee M18 REDLITHIUM™ 2.0AH battery delivers 250+ crimps on 500 MCM per charge
- Southwire Crimpers & Southwire Dies produce UL classified connections across most major connector manufacturers
- 350 degree rotation
- Auto release once complete crimp is accomplished
- Hydraulic system is optimized for consistent performance from 0°F to 122°F
- LED lights illuminate work area
- Hydraulic pressure relief button for manual return
- Single trigger operation, crimps in the most confined spaces
- Fully balanced designed for improved control and ergonomics
- Weather protected electronics keep dirt, dust, and moisture out
- Each kit includes 1 platform, 1 crimper jaw, 1 battery charger, 2 batteries

SPECIFICATIONS

MODEL #	STOCK #	DESCRIPTION		
SCR6-C	595195	MAXTERM™ 6-Ton Commercial Crimper w/ U Jaw		
LENGTH	WIDTH	HEIGHT	WEIGHT	
SCR6-C	16.5"	23"	5.5"	18 lb.

6-TON COMMERCIAL U JAW

STJ6-CU



STJ6-CU Commercial U Jaw

SPECIFICATIONS

MODEL #	STOCK #	DESCRIPTION		
STJ6-CU	595196	6-Ton Commercial Crimper U Jaw		
LENGTH	WIDTH	HEIGHT	WEIGHT	
STJ6-CU	6.18"	6.93"	3.23"	2.76 lb.

ALUMINUM & COPPER "U" DIES

SDU-KITA



Individual Aluminum & Copper Kits & "U" Dies

- Clearly marked for easy identification
- Stainless steel resists rust
- Compatible with all crimping tools that accept "U" Dies
- Comes in storable case that fits in product container
- Imprints size die used on termination lug

SPECIFICATIONS

ALUMINUM "U" DIE KIT & DIES

PART#	STOCK#	DESCRIPTION
SDU-KITA	595197	#8 AWG-350 MCM Aluminum U Die Kit
SDU-A8	595202	#8 Aluminum U Die
SDU-A6	595203	#6 Aluminum U Die
SDU-A4	595201	#4 Aluminum U Die
SDU-A2	595200	#2 Aluminum U Die
SDU-A1	595199	#1 Aluminum U Die
SDU-0A1	595204	1/0 Aluminum U Die
SDU-0A2	595205	2/0 Aluminum U Die
SDU-0A3	595206	3/0 Aluminum U Die
SDU-0A4	595207	4/0 Aluminum U Die
SDU-A250	595208	250 Aluminum U Die
SDU-A300	595209	300 Aluminum U Die
SDU-A350	595210	350 Aluminum U Die

SDU-KITC



COPPER "U" DIE KIT & DIES

PART#	STOCK#	DESCRIPTION
SDU-KITC	595198	#8 AWG-350 MCM Copper U Die Kit
SDU-C8	595215	#8 Copper U Die
SDU-C6	595214	#6 Copper U Die
SDU-C4	595213	#4 Copper U Die
SDU-C2	595212	#2 Copper U Die
SDU-C1	595211	#1 Copper U Die
SDU-0C1	595216	1/0 Copper U Die
SDU-0C2	595217	2/0 Copper U Die
SDU-0C3	595218	3/0 Copper U Die
SDU-0C4	595219	4/0 Copper U Die
SDU-C250	595220	250 Copper U Die
SDU-C300	595221	300 Copper U Die
SDU-C350	595222	350 Copper U Die
SDU-C400	595223	400 Copper U Die
SDU-C500	595224	500 Copper U Die
SDU-C600	595225	600 Copper U Die

CONDUIT BENDING

We don't just help you bend conduit, we change the way you do it. In addition to offering traditional conduit bending tools, Southwire has designed bending platforms that allow you to bend 1/2" to 2" EMT, IMC, and GRC conduit more efficiently, helping you do more work faster and stay fresh longer.

- BEND_{MAX}[™]
- BEND_{station}[™]
- BEND_{dolly}[™]
- PVC Benders
- Hand Benders
- Cable Benders



BENDMAX™ POWER BENDER

PB2000



Power Bender 3/4" - 2" EMT, IMC, GRC Conduit

- Easily adjustable to ergonomic working height
- 3/4" - 2" EMT, IMC/GRC Conduit Bender
- 2 degree leveling adjustment
- Industrial grade DC drive, and electrical components
- Push cart mounted platform
- Includes free standing conduit roller support
- Total lock casters
- Programmable spring back incorporated into digital readout
- Large analog protractor for accurate bends
- Backlit digital display
- Manual operation in the event of electronics failure
- Billet aluminum hand pendant
- Easily replaceable control cable

SPECIFICATIONS

MODEL #	STOCK #	DESCRIPTION				
PB2000	598406	Powered Bender 3/4"- 2" EMT,IMC, GRC Conduit				
			DEPTH	WIDTH	HEIGHT	WEIGHT
PB2000			38"	30"	50"	600 lb.

BENDMAX™ COMPACT POWER BENDER

BML2000



Compact Power Bender for 3/4"- 2" EMT, IMC, GRC Conduit

- Bends 3/4" - 2" EMT, IMC/GRC Conduits
- Double sided shoe for EMT and IMC/GRC Conduit
- Large analog protractor for accurate bends
- Push cart mounted platform
- Industrial-grade DC drive and electrical components
- Adjustable squeeze setting for wrinkle-free bends on EMT/IMC conduit
- Durable locking casters
- Fits through finished 30" door frames
- Durable two-position hand pendant
- Completely assembled, no gang boxes to deal with

SPECIFICATIONS

MODEL #	STOCK #	DESCRIPTION	CAPACITY			
BML2000	646012	BENDMAX™ Compact Power Bender	3/4"-2" EMT, IMC, GRC Conduit			
			HEIGHT	WIDTH	DEPTH	WEIGHT
BML2000			42.94"	27.125"	29.625"	500 lb.

BENDSTATION™ COMMON CART WORK STATION

RB1000



BENDSTATION™ COMMON CART WORK STATION

- More accurate measurements, bends, and cuts
- Measure, bend, clamp and cut at a comfortable 36" work table height for reduced labor fatigue
- Store up to 900 feet of conduit or strut dependent on size
- Extra shelf for storage of tools and materials
- Heavy duty casters for easy transportation and mobility
- Requires up to 40% less effort than other mechanical benders
- Built-in 60" ruler for quick and accurate measuring
- Eliminates the need to bend over to get a closer look at hand bends
- Unique speed vice designed specifically to hold conduit and unistrut, helps make cutting quicker and safer
- Speeds up the entire bending process up to 30%

SPECIFICATIONS

MODEL #	STOCK #	DESCRIPTION	LENGTH	WIDTH	HEIGHT	WEIGHT
BSCC01	598407	BENDSTATION™ GRC for 3/4" and 1" GRC and IMC				
RB1000	598407	BENDSTATION™ for 3/4" and 1" GRC and IMC				
MB1250	647951	BENDSTATION™ for 1" and 1.25" EMT				
MB1000	643069	BENDSTATION™ for 3/4" and 1" EMT				
MB750	583152	BENDSTATION™ for 1/2" and 3/4" EMT				
MODEL #	STOCK #	DESCRIPTION	LENGTH	WIDTH	HEIGHT	WEIGHT
BSCC01	69"	29"	38.5"	170 lb.		
RB1000	69"	29"	38.5"	180 lb.		
MB1250	69"	29"	38.5"	185 lb.		
MB1000	69"	29"	38.5"	150 lb.		
MB750	69"	29"	38.5"	132 lb.		

MODEL #	STOCK #	DESCRIPTION	CAPACITY	LENGTH	WIDTH	HEIGHT	WEIGHT
RBCCH-1000	643166	Head Kit for 3/4" - 1" GRC and IMC	3/4" - 1" GRC and IMC				
MBCCH-750	646010	Head Kit for 1/2" - 3/4" EMT	1/2" - 3/4" EMT				
MBCCH-1000	643167	Head Kit for 3/4" - 1" EMT	3/4" - 1" EMT				
MBCCH-1250	647953	Head Kit for 1" - 1.25" EMT	1" - 1.25" EMT				
MODEL #	STOCK #	DESCRIPTION	CAPACITY	LENGTH	WIDTH	HEIGHT	WEIGHT
RBCCH-1000	9.20"	17.45"	20.80"	80 lb.			
MBCCH-750	7.60"	16.13"	14.87"	32 lb.			
MBCCH-1000	8.70"	16.63"	16.61"	49 lb.			
MBCCH-1250	10"	12.75"	15.23"	86 lb.			

BENDDOLLY™ BENDING PLATFORM

BD1000R

Mechanical Bending Platform



- Light weight bending platform
- Interchangeable shoe mounting plate
- Large dolly wheels for easy maneuverability
- Stable bending platform
- Interchangeable EMT shoes and IMC/GRC shoes
- Durable black powder coating for increased corrosion resistance
- Accepts four different Southwire bending shoes
- Upright storage position

SPECIFICATIONS

MODEL #	STOCK #	DESCRIPTION	CAPACITY	
BD1000R	646025	BENDdolly™ 3/4" - 1" GRC IMC Bender	3/4" - 1" IMC/GRC conduit	
BD-01	646011	BENDdolly™ Bending Platform	EMT, IMC/GRC bending shoe sizes 1/2" - 1.25"	
BD750E	646023	BENDdolly™ 1/2" - 3/4" EMT Bender	1/2" - 3/4" EMT conduit	
BD1000E	646024	BENDdolly™ 3/4" - 1" EMT Bender	3/4" - 1" EMT conduit	
BD1250E	646024	BENDdolly™ 1" - 1.25" EMT Bender	1" - 1.25" EMT conduit	
	LENGTH	WIDTH	HEIGHT	WEIGHT
BD1000R	55"	26"	28.75"	140 lb.
BD-01	55"	26"	28.75"	60 lb.
BD750E	55"	26"	28.75"	92 lb.
BD1000E	55"	26"	28.75"	110 lb.
BD1250E	55"	26"	28.75"	145 lb.

BENDING SHOE HEAD KITS

MODEL #	STOCK #	DESCRIPTION	CAPACITY	
MBCCH-750	646010	Head Kit for 1/2"-3/4" EMT	1/2"-3/4" EMT	
MBCCH-1000	643167	Head Kit for 3/4"-1" EMT	3/4"-1" EMT	
MBCCH-1250	647953	Head Kit for 1"-1.25" EMT	1"-1.25" EMT	
RBCCH-1000	643166	Head Kit for 3/4"-1" GRC/IMC	3/4"-1" GRC/IMC	
	HEIGHT	WIDTH	DEPTH	WEIGHT
MBCCH-750	14.87"	16.13"	7.60"	32 lb.
MBCCH-1000	16.61"	16.63"	8.70"	49 lb.
MBCCH-1250	15.23"	12.75"	10"	85 lb.
RBCCH-1000	20.80"	17.45"	9.20"	80 lb.

PVC BENDERS

1/2' TO 6' PVC MOTORIZED BENDER

PVCB-06M



6300 WATTS, 230 VAC, 28 Amp PVC Bender

- Durable black powder coating for increased corrosion resistance
- Solid 6" wheels for easy maneuverability
- Chrome plated reflectors for maximum reflection of infrared energy for a faster bend
- Label includes NEC bending tables
- Bright red indicator light to advise when unit is turned "ON"

SPECIFICATIONS

MODEL #	STOCK #	DESCRIPTION	DEPTH	WIDTH	HEIGHT	WEIGHT
PVCB-06M	643013	1/2' to 6' PVC Motorized Bender				
PVCB-06M			11.75"	73"	16.5"	81 lb.

1/2' TO 6' PVC BENDER

PVCB-06



6300 WATTS, 230 VAC, 28 Amp PVC Bender

- Durable black powder coating for increased corrosion resistance
- Solid 6" wheels for easy maneuverability
- Chrome plated reflectors for maximum reflection of infrared energy for a faster bend
- Label includes NEC bending tables
- Bright red indicator light to advise when unit is turned "ON"

SPECIFICATIONS

MODEL #	STOCK #	DESCRIPTION	DEPTH	WIDTH	HEIGHT	WEIGHT
PVCB-06	643012	1/2' to 6' PVC Bender				
PVCB-06			11.75"	73"	16.5"	80 lb.

1/2' TO 4' PVC BENDER

PVCB-04



2400 WATTS, 120 VAC, 20 Amp PVC Bender

- Durable black powder coating for increased corrosion resistance
- Solid 6" wheels for easy maneuverability
- Chrome plated reflectors for maximum reflection of infrared energy for a faster bend
- Label includes NEC bending tables
- Bright red indicator light to advise when unit is turned "ON"

SPECIFICATIONS

MODEL #	STOCK #	DESCRIPTION		
PVCB-04	643011	1/2' to 4' PVC Bender		
		DEPTH	WIDTH	HEIGHT
PVCB-04		8.5"	56"	13"
				WEIGHT
				50 lb.

1/2' TO 2' PVC BENDER

PVCB-02



1700 WATTS, 115 VAC, 15 Amp PVC Bender

- Durable black powder coating for increased corrosion resistance
- Chrome plated reflectors for maximum reflection of infrared energy for a faster bend
- Label includes NEC bending tables
- Bright green indicator light to advise when unit is turned "ON"

SPECIFICATIONS

MODEL #	STOCK #	DESCRIPTION		
PVCB-02	64812201	1/2' to 2' PVC Bender		
		DEPTH	WIDTH	HEIGHT
PVCB-02		32"	10"	11"
				WEIGHT
				19 lb.

PVC BENDERS

PLUG KITS

PVCP-01



Plug kits for PCVB-03/PVCB-06/PVCB-06M

- Rugged carrying case to store and transport plugs
- Durable long lasting neoprene gaskets
- Twist lock design for easy installation and removal
- Provides air tight seal
- Prevents conduit from collapsing when heated



PVCP-02



SPECIFICATIONS

MODEL #	STOCK #	DESCRIPTION
PVCP-01	643014	2" to 4" Bending Plug Kit
PVCP-02	643016	2" to 6" Bending Plug Kit

CONDUIT BENDERS



Reliably and repeatedly perform common bends, such as stub-ups, offsets, back-to-back, and saddle bends. Available in 1", 3/4", and 1/2" sizes.

- Durable cast metal heads
- Swaged steel handle permits insertion of conduit to correct overbends
- Raised and highly visible bender markings are cast on both sides of the bender head
- Large serrated step provides greater control and helps prevent slipping when applying force

SPECIFICATIONS

MODEL #	STOCK #	DESCRIPTION			
MCB1	582814	1" EMT Conduit Bender with Handle (Ductile Iron Head)			
MCB3/4	582812	3/4" EMT Conduit Bender with Handle (Aluminum Head)			
MCB1/2	582813	1/2" EMT Conduit Bender with Handle (Aluminum Head)			
	HEIGHT	WIDTH	DEPTH	WEIGHT	CONDUIT SIZE
MCB1	1.75"	12"	45"	13 lb.	1" EMT, 3/4" Rigid
MCB3/4	1.25"	9"	39"	9 lb.	3/4" EMT, 1/2" Rigid
MCB1/2	1.25"	8"	39"	7 lb.	1/2" EMT

CABLE BENDERS

12" HAND CABLE BENDER

CB12-350

The CB12-350 has a forged, one-piece, steel design for quick and easy bending. It is ideal for bending 350 MCM cables.



- Black oxide finish for corrosion resistance
- Dipped grip handles
- Forged one-piece design
- High strength steel
- 350 MCM cable capacity

SPECIFICATIONS

MODEL #	STOCK #	DESCRIPTION		
CB12-350	587391	CB12-350 12" 350 MCM Hand Cable Bender		
	HEIGHT	WIDTH	DEPTH	WEIGHT
CB12-350	12"	1.86"	.85"	0.95 lb.

14" HAND CABLE BENDER

CB14-500

The CB14-500 has a forged, one-piece, steel design for quick and easy bending. It is ideal for bending 500 MCM cables.



- Black oxide finish for corrosion resistance
- Dipped grip handles
- Forged one-piece design
- High strength steel
- 500 MCM cable capacity

SPECIFICATIONS

MODEL #	STOCK #	DESCRIPTION		
CB14-500	587392	CB14-500 14" 500 MCM Hand Cable Bender		
	HEIGHT	WIDTH	DEPTH	WEIGHT
CB14-500	14.25"	2.22"	1.35"	1.6 lb.

HOLE MAKING

Southwire™ has developed industry leading tools for electrical contractors, including a comprehensive line of hole making solutions. With tools ranging from cutting dies to the original drill-powered knockout punch, you can make quick, accurate holes every time without the muscle or mess.

- Knockouts
- Hole Saws
- Auger Bits
- Wood Boring Bits
- Drill/Tap Bits
- Carbide Tipped Hole Cutters

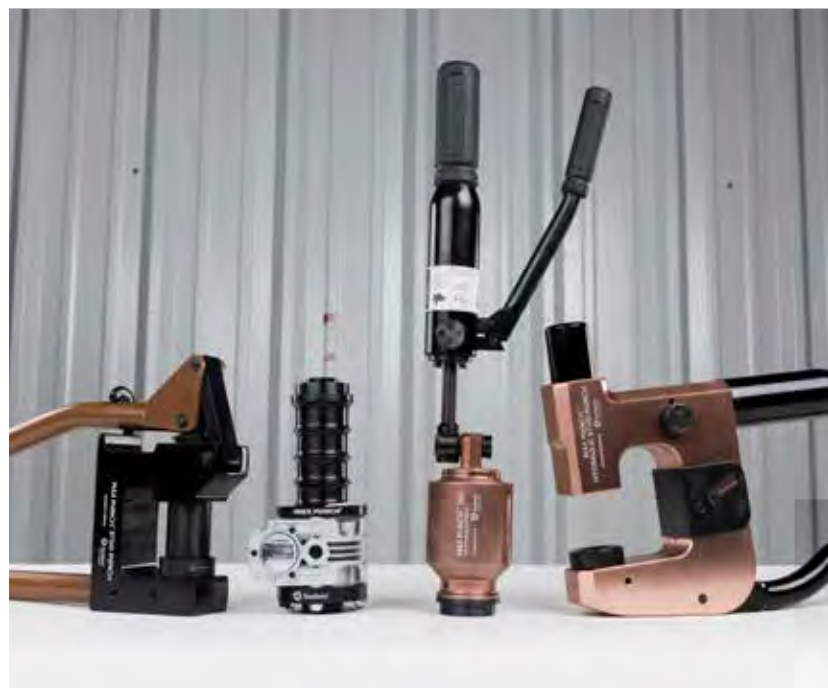

MAX PUNCH® XD

MPXD



Heavy duty knockout punch driver for stainless and mild steel.

- No hydraulics, no ratcheting, no mess!
- Thread-in/thread-out removable drawstuds (universal to fit most common KO dies)
- Rated to cut 10 gauge mild and stainless steel up to 4"
- Minimum drill recommendations: 18v cordless, equivalent of 550 in. lbs. torque rated

MPXD-SD

Includes:

- MAX PUNCH® XD drive unit
- 1/2" – 2" MAX PUNCH® Pro cutting dies (rated for stainless steel)
- 2 drawstuds sizes 3/4" & 7/16"
- Marksman™ conduit layout tool
- Step drill bit (3/16" – 7/8", 2 nut drivers) (7/16")
- Heavy duty carrying case

MPXD-SD



MP-03PRO

Includes:

- 2 1/2" - 4" MAX PUNCH® Pro cutting dies
- 1 1/8" drawstud
- Heavy duty carrying case

MP-03PRO



SPECIFICATIONS

MODEL#	STOCK #	DETAILS		
MPXD	631597	MAX PUNCH® XD: drive unit only (no case)		
MPXD-SD	631599	MAX PUNCH® XD w/ stainless steel rated dies - 1/2" - 2" set (1 case)		
MP-03PRO	571772	MAX PUNCH® PRO STAINLESS STEEL 2 1/2" - 4" SET		
MODEL#	LENGTH	WIDTH	DEPTH	WEIGHT
MPXD	5.5"	11.5"	4.25"	5.5 lb.
MPXD-SD	16.5"	8.5"	13"	14.5 lb.
MP-03PRO	16.5"	13"	5"	22.5 lb.

KNOCKOUTS

MAX PUNCH™ 360 HYDRAULIC KNOCKOUT TOOL

MP360HP



Heavy duty 12-ton hydraulic knockout with 360 degree articulation.

- Full 360 degree articulating head for tight spaces
- Lightweight aluminum head
- Compact pump with padded handle

SPECIFICATIONS

MODEL#	STOCK #	DETAILS		
MP360HP	591590	MAX PUNCH™ 360 DRIVE UNIT ONLY		
MP360SDPRO	589738	MAX PUNCH™ 360 STAINLESS STEEL 1/2" - 2" SET		
MP-03PRO	571772	MAX PUNCH™ PRO STAINLESS STEEL SET 2 1/2" - 4" SET		
MODEL#	LENGTH	WIDTH	DEPTH	WEIGHT
MP360HP	4.5"	5.25"	3.75"	5.5 lb.
MP360SDPRO	21"	12"	4"	15 lb.
MP-03PRO	16.5"	13"	5"	22.5 lb.

MP360SDPRO



MP-03PRO



MAX PUNCH™ HSP HYDRAULIC STUD PUNCH

MPHSP

4 tools in 1 and is adjustable for 3 5/8" and 6" studs, punches 7/8" or 1 11/32" holes.

- Punches holes in 16 gauge structural steel studs
- Compact design fits in tight spaces
- Padded handles provide gripping comfort and greater control
- Heavy duty carrying case



SPECIFICATIONS

MODEL #	STOCK #	DESCRIPTION		
MPHSP	589465	MAX PUNCH™ Hydraulic Stud Punch		
MODEL #	LENGTH	WIDTH	WEIGHT	
MPHSP	17.5"	10.5"	11 lb.	



Knockouts | HOLE MAKING

KNOCKOUTS

MAX PUNCH™ MANUAL STUD PUNCH

MSP01



2 tools in 1, punches $\frac{7}{8}$ " and $1\frac{11}{32}$ " holes.

- Sizes include - $\frac{7}{8}$ " (22.5mm) & $1\frac{11}{32}$ " (34.1mm)
- MAX PUNCH™ Manual Stud Punch is intended to punch round holes in 20 gauge steel studs
- Lock to keep handle in place when not in use
- Lightweight punch makes accurate location of holes easier
- Cushioned handle gives more leverage and makes it easier to punch in tight spaces, meaning less operator fatigue and more comfortable handling

SPECIFICATIONS

MODEL #	STOCK #	DESCRIPTION		
MSP01	575762	MAX PUNCH™ MANUAL STUD PUNCH		
MODEL #	HEIGHT	WIDTH	LENGTH	WEIGHT
MSP01	2.25"	8.55"	18.5"	7.5 lb.



MAX PUNCH™ RATCHET SET WITH 1/2" - 2" CUTTING DIES

MPR-01SD

Flex head ratchet wrench allows for easy maneuverability around obstacles.



- Cuts through 12 gauge mild steel as well as aluminum, fiberglass, and plastics
- Unique 3-point cup cutting surface provides a clean, quick, and easy cut for 1" through 2" dies
- Cup design creates crimping effect on slug for easy removal for 1" through 2" dies
- Ball bearing draw stud for reduced friction
- Includes Southwire Marksman® (Model # MM01) Conduit Layout Tool
- Includes 1/2", 3/4", 1", 1 1/4", 1 1/2", and 2" dies

SPECIFICATIONS

MODEL #	STOCK #	DESCRIPTION		
MPR-01SD	582892	MAX PUNCH™ Ratchet Set with 1/2"-2" Dies		
	HEIGHT	WIDTH	LENGTH	WEIGHT
MPR-01SD	14.17"	10.43"	2.76"	11.57 lb.

KNOCKOUTS

MAX PUNCH® STAINLESS STEEL CUPS & CUTTERS

Stainless steel cups and cutters.

- Unique 3 point cutting surface provides a cleaner, quicker and easier cut for 1" through 4" dies
- Rated for 10 gauge stainless steel (3.5mm) as well as mild steel, aluminum, fiberglass and plastics
- Will not bow panel or leave jagged edges
- Crimping effect on slug for easy removal



SPECIFICATIONS

MODEL #	STOCK #	DESCRIPTION	CONDUIT & PIPE SIZE	HOLE SIZE ACTUAL "	MM	CAPACITY S.S. GA
MPK050PRO	571746	MAX PUNCH® Cutter for Stainless Steel 1/2"	1/2"	.89	23	10
MPC50PRO	571761	MAX PUNCH® Cup for Stainless Steel 1/2"	1/2"	.89	23	10
MPK075PRO	571747	MAX PUNCH® Cutter for Stainless Steel 3/4"	3/4"	1.12	28	10
MPC75PRO	571762	MAX PUNCH® Cup for Stainless Steel 3/4"	3/4"	.12	28	10
MPK0100PRO	571748	MAX PUNCH® Cutter for Stainless Steel 1"	1"	1.36	35	10
MPC100PRO	571763	MAX PUNCH® Cup for Stainless Steel 1"	1"	1.36	35	10
MPK0125PRO	571749	MAX PUNCH® Cutter for Stainless Steel 1 1/4"	1 1/4"	1.70	43	10
MPC125PRO	571764	MAX PUNCH® Cup for Stainless Steel 1 1/4"	1 1/4"	1.70	43	10
MPK0150PRO	571750	MAX PUNCH® Cutter for Stainless Steel 1 1/2"	1 1/2"	1.95	50	10
MPC150PRO	571765	MAX PUNCH® Cup for Stainless Steel 1 1/2"	1 1/2"	1.95	50	10
MPK0200PRO	571751	MAX PUNCH® Cutter for Stainless Steel 2"	2"	2.42	62	10
MPC200PRO	571766	MAX PUNCH® Cup for Stainless Steel 2"	2"	2.42	62	10
MPK0250PRO	571753	MAX PUNCH® Cutter for Stainless Steel 2 1/2"	2 1/2"	2.92	74	10
MPC250PRO	571767	MAX PUNCH® Cup for Stainless Steel 2 1/2"	2 1/2"	2.92	74	10
MPK0300PRO	571754	MAX PUNCH® Cutter for Stainless Steel 3"	3"	3.55	90	10
MPC300PRO	571768	MAX PUNCH® Cup for Stainless Steel 3"	3"	3.55	90	10
MPK0350PRO	571755	MAX PUNCH® Cutter for Stainless Steel 3 1/2"	3 1/2"	4.04	103	10
MPC350PRO	571769	MAX PUNCH® Cup for Stainless Steel 3 1/2"	3 1/2"	4.04	103	10
MPK0400PRO	571756	MAX PUNCH® Cutter for Stainless Steel 4"	4"	4.54	115	10
MPC400PRO	571770	MAX PUNCH® Cup for Stainless Steel 4"	4"	4.54	115	10
MP02PRO*	571771	Small Die Set 1/2"-2" in case (drive unit not included)	1/2" - 2"	.89-2.42	23-62	10
MP03PRO*	571772	MAX PUNCH® PRO STAINLESS STEEL SET 2 1/2" - 4"	2 1/2" - 4"	2.92-4.54	74-115	10

OILTIGHT PUNCHES WITH NOTCHES

MPOPN78



Special application punches.

- Model #MPOPN78, Stock #58142201, 7/8" (22.5mm) oiltight punch with notches
- Model #MPOPN1732, Stock #58142301, 1 7/32" (30.5mm) oiltight punch with notches
- Includes: Punch, die, draw stud and nut

SPECIFICATIONS

MODEL #	STOCK #	DESCRIPTION	
MPOPN78	581422	7/8" OILTIGHT PUNCH	
MPOPN1732	581423	1 7/32" OILTIGHT PUNCH	
HOLE SIZE INCH	A	B	C
MPOPN78	.875	.125	1.000
MPOPN1732	1.210	.190	1.380
HOLE SIZE MM	A	B	C
MPOPN78	22.5	3.2	25.4
MPOPN1732	30.5	4.8	36.0
MAXIMUM CAPACITY MILD STEEL		GA	MM
MPOPN78		14	2.0
MPOPN1732		10	3.5

MPOPN1732

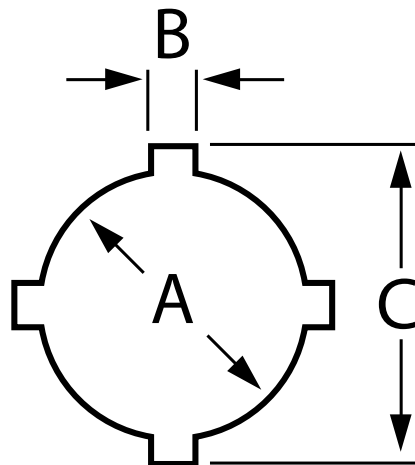

KNOCKOUTS

MARKSMAN® CONDUIT LAYOUT TOOL

MM01



A conduit layout tool that will pinpoint a center knockout in seconds. The Marksman® Layout Tool also features a panel schedule showing the branch circuit number and its corresponding phase.

- Easy to use
- No math
- For KO sizes 1/2" to 4"
- Underground and overhead
- The Southwire® Marksman® conduit layout tool is constructed of tough durable anodized aluminum
- Markings are etched for maximum durability

SPECIFICATIONS

MODEL #	STOCK #	DESCRIPTION			
MM01	582819	Marksman Conduit Layout Tool			
	HEIGHT	WIDTH	DEPTH	WEIGHT	KNOCKOUT SIZES
MM01	6.5"	2"	0.25"	2.5 oz	1/2" - 4"

DRAW STUDS FOR MAX PUNCH® DRIVE UNITS

XDDS34
PRDS716
PRDS118
MPDS12



MAX PUNCH® PRO DRAW STUDS

- 3/4" - Main Draw Stud - Stock #648640 Model #XDDS34
- 7/16" - Medium Draw Stud - Stock #577179 Model #PRDS716
- 1 1/8" - Large Draw Stud (for 2 1/2" – 4" MAX PUNCH® and MAX PUNCH® PRO Dies) Stock #583061 Model #PRDS118

MAX PUNCH® DRAW STUDS

- 3/4" - Main Draw Stud - Stock #568259 Model #MPDS12

SPECIFICATIONS

MODEL #	STOCK #	DESCRIPTION	LENGTH	WEIGHT	DIAMETER
XDDS34	648640	3/4" MAIN DRAW STUD MAX PUNCH® PRO	5"	8.7 oz	3/4"
PRDS716	577179	7/16" MEDIUM DRAW STUD - MAX PUNCH® PRO	4.25"	4.6 oz	7/16" - 3/4"
PRDS118	583061	LARGE DRAW STUD - 1 1/8" (FOR MILD STEEL OR STAIN- LESS STEEL LARGE DIES)	4.4371"	15.6 oz	1 1/8"
MPDS12	568259	1/2" MAIN DRAW STUD - MAX PUNCH®	11.5"	4.4 oz	15/16"

MANUAL KNOCKOUTS

Manual knockout sets with unique 3-point cup cutting surface provide clean, quick, and easy cuts.



- Optimized design reduces wrench effort
- Unique 3-point cup cutting surface provides a clean, quick, and easy cut
- Cup design creates crimping effect on slug for easy removal

SPECIFICATIONS

MODEL #	STOCK #	DESCRIPTION
KOKIT6	582978	Manual Knockout Kit
KODRAW1/2	582979	Knockout Set
KODRAW3/4	582980	Knockout Set
MODEL #	STOCK #	INCLUDES
KOKIT6	582978	(4) Maxis® MAX PUNCH® Cups & Cutters 1/2" to 1-1/4", (1) 7/16" Draw Stud, (1) 3/4" Draw Stud
KODRAW1/2	582979	(1) 1/2" Knockout Draw Stud
KODRAW3/4	582980	(1) 3/4" Knockout Draw Stud

HOLE SAWS

BI-METAL HOLE SAWS

These bi-metal hole saws are heavy duty and allow for fast cutting of steel, aluminum, brass, wood, plastic, and drywall.

- Increased plug ejection slots for easy removal of cutting materials
- Larger hole saw depth limits blocked ejection slots
- Custom steel body and M42 teeth for improved performance
- Lifetime tooth breakage warranty

BMHSKIT9



SPECIFICATIONS

MODEL #	STOCK #	DESCRIPTION
BMHSKIT9	582976	9-Piece Bi-Metal Hole Saw Kit
BMHS4-3/8	642781	Bi-Metal Hole Saw 4-3/8" (111mm) (4" Recessed Lights)
BMHS5-3/8	642782	Bi-Metal Hole Saw 5-3/8" (137mm) (5" Recessed Lights)
BMHS6-3/8	582975	Bi-Metal Hole Saw 6-3/8" (162mm) (6" Recessed Lights)
ABS1/2	582953	Large Quick Connect Arbor
ABS3/8	646054	Small Arbor 3/4" to 1-1/8"
MODEL #	STOCK #	INCLUDES
BHMSKIT9	582976	(6) Bi-metal hole saws: 7/8", 1-1/8", 1-3/8", 1-3/4", 2", 2-1/2", (1) 3/8" hex shank mandrel, (1) 3/8" qck. chg. mandrel, (2) pilot bits
BMHS4-3/8	642781	(1) 4-3/8" Hole Saw
BMHS5-3/8	642782	(1) 5-3/8" Hole Saw
BMHS6-3/8	582975	(1) 6-3/8" Hole Saw
ABS1/2	582953	(1) 1/2" Arbor bit shank
ABS3/8	646054	(1) 3/8" Arbor bit shank

ADJUSTABLE CAN LIGHT HOLE SAW

ACLHS



Adjustable hole saw featuring black oxide blades cleanly and efficiently cuts precise holes in drywall and ceiling tiles.

- 19 blade adjustment positions ranging from 2-1/2" to 7"
- 1/4" increments
- Black oxide blades cut cleanly through drywall and ceiling tiles
- Hex key adjustment allows for easy movement of blade
- Includes two dust shields

SPECIFICATIONS

MODEL #	STOCK #	DESCRIPTION	
ACLHS	597054	Adjustable Can Light Hole Saw	
	HEIGHT	WIDTH	WEIGHT
ACLHS	2.17"	8.27"	2.08 lb.

FLEX AUGER BITS

FAB9/16X54



54" flex auger bits with screw point tips easily drill clean holes through wood inside walls.

FAB3/8X54



- Pilot feed-screw draws bit into wood
- Spring steel shaft resists deformation
- Hole in tip for use with wire and cable pulling grips

FAB1x54



FAB3/4X54



SPECIFICATIONS

MODEL #	STOCK #	DESCRIPTION
FABK9/16X54	582977	9/16" Flex Bit Kit
FAB9/16X54	582969	9/16" Flex Bit
FAB3/8X54	582968	3/8" Flex Bit
FAB3/4X54	582967	3/4" Flex Bit
FAB1x54	582970	1" Flex Bit
MODEL #	STOCK #	INCLUDES
FABK9/16X54	582977	(1) 9/16" X 54" Flex Bit, (1) Cable Pulling Grip, (1) Folding Placement Tool
FAB3/8X54	582968	(1) 3/8" Flex Bit
FAB9/16X54	582969	(1) 9/16" Flex Bit
FAB3/4X54	582967	(1) 3/4" Flex Bit
FAB1x54	582970	(1) 1" Flex Bit

FLEX AUGER BIT EXTENSION

FAE3/16X54



For use with bits to extend length to easily drill clean holes through wood inside walls.

- Extends auger bit lengths
- Spring steel shaft resists deformation
- 54" overall length
- Tapered back for easy bit retrieval

SPECIFICATIONS

MODEL #	STOCK #	DESCRIPTION		
FAE3/16X54	597053	Flex Auger Bit Extension		
	HEIGHT	WIDTH	DEPTH	WEIGHT
FAE3/16X54	54"	0.91"	0.91"	.11 lb.

AUGER BITS

FLEXIBLE QUICK CONNECT EXTENSION KIT

FQCKIT



Perfect for installing wire in existing walls and ceilings.

- Kit includes everything needed to drill and pull light to medium wire
- Multiple extensions can be joined for increased versatility
- Convenient 1/4" quick connect receivers
- Auger bit with self-feeding screw tip draws bit through wood
- Quick connect accepts bits up to 3/4" in diameter
- Includes:
 - (1) 1/2" O.D. pulling grip
 - (1) 18" Flexible Quick Connect Extension
 - (1) 36" Flexible Quick Connect Extension
 - (1) 3/4" x 4-1/2" auger bit

SPECIFICATIONS

MODEL #	STOCK #	DESCRIPTION	INCLUDES	
FQCKIT	597050	Flexible Quick Connect Extension Kit	(1) 1/2" O.D. pulling grip, (1) 18" Flexible Quick Connect Extension, (1) 36" Flexible Quick Connect Extension, and (1) 3/4" x 4-1/2" auger bit	
	HEIGHT	WIDTH	DEPTH	WEIGHT
FQCKIT	59.5" Assembled	3/4" (max bit width)	1"	0.66 lb.

FLEXIBLE QUICK CONNECT EXTENSION

FQCE36



36" flexible quick change extension is perfect for installing wire in existing walls and ceilings.

- Flexible shaft allows easy access to difficult and confined areas
- Quick connect accepts bits up to 3/4" in diameter
- Multiple extensions can be joined for increased versatility
- Convenient 1/4" quick connect receivers

SPECIFICATIONS

MODEL #	STOCK #	DESCRIPTION		
FQCE36	597049	Flexible Quick Connect Extension		
	HEIGHT	WIDTH	DEPTH	WEIGHT
FQCE36	36"	1/4" (shank)	0.86"	0.33 lb.

SHIP AUGER BITS

SAB3/4X18



Heavy-duty ship auger bit, featuring a self-feeding screw tip, drills clean holes through nails, wood, vinyl, plastic, and heavy timber.

- Screw tip draws bit through wood
- Polished and coated flutes increase removal of cutting material
- 18" length allows deep drilling without an extension

SAB7/8X18



SPECIFICATIONS

MODEL #	STOCK #	DESCRIPTION
SAB3/4x18	582955	3/4" Ship Auger Bit
SAB7/8X18	582956	7/8" Ship Auger Bit
SAB1X18	582954	1" Ship Auger Bit
MODEL #	STOCK #	INCLUDES
SAB3/4x18	582955	(1) Ship Auger Bit
SAB7/8X18	582956	(1) Ship Auger Bit
SAB1X18	582954	(1) Ship Auger Bit

SAB1X18



WOOD BORING BITS

WOOD BORING BITS

WAB3/4x4-1/2



Heavy-duty, self-feeding wood boring bits cut clean holes in wood.

- Screw tip draws bit through wood
- Polished and coated flutes increase removal of cutting material
- 4.5" length for drilling in tight spaces

WAB7/8x4-1/2



WAB1X4-1/2



SPECIFICATIONS

MODEL #	STOCK #	DESCRIPTION
WAB3/4X4-1/2	582960	3/4" Wood Auger Bit
WAB7/8X4-1/2	582961	7/8" Wood Auger Bit
WAB1X4-1/2	582959	1" Wood Auger Bit
MODEL #	STOCK #	INCLUDES
WAB3/4X4-1/2	582960	(1) Wood Auger Bit
WAB7/8X4-1/2	582961	(1) Wood Auger Bit
WAB1X4-1/2	582959	(1) Wood Auger Bit

DRILL / TAP BITS



Our drill/tap bits feature a one-piece drill and tap design that saves time by drilling, tapping, countersinking, and deburring in one smooth operation.

- Made of high-speed steel for durability
- Tapered design prevents thread damage
- For use with steel, copper, brass, aluminum, and plastic

SPECIFICATIONS

MODEL #	STOCK #	DESCRIPTION
CDTBKIT	582963	Combination Drill and Tap Set
MODEL #	STOCK #	INCLUDES
CDTBKIT	582963	(6) Drill/Tap Bits: 6-32 NC, 8-32 NC, 10-24 NC, 10-32 NC, 12-24 NC, 1/4-20 NC, (1) Quick Change Adapter

STEP DRILL BITS

SB3/16-7/8



Step drill bits for clean hole drilling in metals.

- Laser etched sizes for easy identification
- Tri-lobe shank reduced reduces slipping and provides a firm grip in the chuck
- Double flute design for a true, round hole every time

SB1/4-1-3/8



SPECIFICATIONS

MODEL #	STOCK #	DESCRIPTION
SB3/16-7/8	582974	3/16"-7/8" Step Drill Bit
SB1/4-1-3/8	582972	1/4"- 1-3/8" Step Drill Bit
MODEL #	STOCK #	INCLUDES
SB3/16-7/8	582974	(1) Step Drill Bit
SB1/4-1-3/8	582972	(1) Step Drill Bit

CARBIDE TIPPED HOLE CUTTERS

CARBIDE TIPPED HOLE CUTTERS



The carbide tipped hole cutters have a durable cutting design specifically for stainless steel and sheet metal.

- Precision ground teeth for fast cutting of clean, round holes
- Double helix grooves for faster starts
- Grooved edge design to prevent extended penetration

SPECIFICATIONS

MODEL #	STOCK #	DESCRIPTION
CHCKIT4	582951	Carbide Tipped Hole Cutter Kit
CHC7/8	582950	7/8" Carbide Tipped Hole Cutter
CHC1-1/8	582949	1-1/8" Carbide Tipped Hole Cutter
MODEL #	STOCK #	INCLUDES
CHCKIT4	582951	(3) Carbide Tipped Hole Cutters: 7/8", 1-1/8", 1-3/8" ; (4) Pilot drill bits; (1) Allen wrench
CHC7/8	582950	(1) 7/8" Carbide tipped hole cutter: For use with 1/2" fittings
CHC1-1/8	582949	(1) 1-1/8" Carbide tipped hole cutter: For use with 3/4" fittings

MATERIAL HANDLING

As one of the most innovative tool lines in the industry, Southwire Tools and Equipment has provided material handling solutions that move material quickly, easily, and safely. With a product line that includes reel jacks, SIMpull™ CoilPAK™ carts, and Wire Wagon® carts, you can complete the job better than ever before while saving time and energy.

- Reel Jacks
- SIMpull™ Carts
- Wire Wagon® Carts
- Wire Carts
- Wire Dolly's
- Wire Dispenser
- Storage Containers
- Weldbox's
- Storage Boxes



SIMPULL™ FLANGE

SF-01



The SIMpull™ Flange's patented shaft less design, safely allows one person to turn a wooden or plastic reel up to 34 in. and 2000 lbs into a time saving, field-installable solution that removes the need to handle heavy jack stands. Each flange rotates independently, and allows free movement of loaded wooden or plastic reels. The SIMpull™ Flange is reusable in the field and can be installed on multiple reels throughout the jobsite.

U.S. PATENT #: US9617112

SPECIFICATIONS

MODEL #	STOCK #	DESCRIPTION
SF-01	64864901	SIMPULL™ FLANGE



REEL JACKS

PROJAX™ REEL STANDS

MPJ01
MPJ02



A 10,000 lb. capacity portable reel stand.

- One person can easily transport through most jobsite environments
- Minimum drill recommendations: 18V cordless, equivalent of 1000 in. lb. torque rated, for reels up to 10,000 lb.
- Easy adjustment for uneven surfaces on jobsite
- Axle rests on steel rollers for easy wire pay off
- Axle safety guard ensures that reel will not fall off of jack stands
- Uses an 18V cordless drill to lift wire reels
- PRO-JAX™ stands can lift up to 10,000 lb. as a pair (4545 kg)
- Can be used with 1 1/4" - 3" axle
- Includes axle storage assembly

SPECIFICATIONS

MODEL #	STOCK #	DESCRIPTION		
MPJ01	581332	PROJAX™ (Single)		
MPJ02	585264	PROJAX™ (Pair)		
	LENGTH	WIDTH	HEIGHT	WEIGHT
MPJ01 (single)	41"	17"	43"	118 lb.



QWIKJAX™ REEL STANDS

QJ-01



QWIKJAX™ 3,000 lb. collapsible reel stand (Single)

- 6,000 lb. capacity per pair (2727 kg)
- One person can easily transport through most jobsite environments
- Axle safety catch hook ensures that reel will not fall off of jack stands
- Axle rests on steel rollers for easy wire pay off
- Maximum reel height: up to 72" reel
- Quick folding feature for compact storage
- Sliding cradle for quick adjustments on large reels
- Easy-to-use, one person setup and operation
- Easy adjustment for uneven surfaces on jobsites

SPECIFICATIONS

MODEL #	STOCK #	DESCRIPTION			
QJ-01	642378	QWIKJAX™ Portable Reel Stand (Single)			
		DEPTH	WIDTH	HEIGHT	WEIGHT
QJ-01	29	17"	29" - 42"	35 lb.	



REEL JACKS

MAXISJAX® REEL STANDS

MJ707

A unique reel stand that will quickly set up and lift wire reels safely and efficiently without the hassle of conventional stands.



- Easy to store and transport
- Breaks down into a compact storable tool
- Jaw clamps onto axle so that wire reels won't come off or fall over
- Multiple steel rollers make it easy for one person to roll off heavy wire
- Max lever allows one person to lift wire reels off the ground with minimal effort
- Uses either a 1-1/2" to 2" rigid pipe for an axle
- Works on reels up to 48" tall

SPECIFICATIONS

MODEL #	STOCK #	DESCRIPTION		
MJ707	568245	MAXISJAX® - 3,000 lb. Reel Stands (Pair)		
	HEIGHT	WIDTH	LENGTH	WEIGHT
MJ707	37"	7"	9.5"	54 lb.



SCREWJAX™

CJ01



Screw-Type reel jacks 22"-54" (single)

- Roller bearing incorporated into Jax rollers
- Powder-coat finish for superior durability and corrosion resistance
- Rollers fit inside axel grooves to prevent axle running
- Wide welded steel base for added strength and stability
- Telescoping mid section for adjustability
- Strut lock pin for added strength and stability
- 2,500 lb. capacity (Each) 5,000 lb. pair (2272 kg)

SPECIFICATIONS

MODEL #	STOCK #	DESCRIPTION		
CJ01	598929	SCREWJAX™ (Single)		
	LENGTH	WIDTH	HEIGHT	WEIGHT
CJ01	21"	24"	54" Max Height	42 lb.

SCREWJAX™

CJ02



Screw-Type reel jacks 13"-27" (single)

- Roller bearing incorporated into Jax rollers
- Powder-coat finish for superior durability and corrosion resistance
- Rollers fit inside axel grooves to prevent axle running
- Wide welded steel base for added strength and stability
- Telescoping mid section for adjustability
- Strut lock pin for added strength and stability
- 2,500 lb. capacity (Each) 5,000 lb. pair (2272 kg)

SPECIFICATIONS

MODEL #	STOCK #	DESCRIPTION		
CJ02	598930	SCREWJAX™ (Single)		
	LENGTH	WIDTH	HEIGHT	WEIGHT
CJ02	15"	15"	28" Max Height	22 lb.

REEL JACKS

AXLES

PJA-01



Axle

- Heavy duty 10,000 lb. capacity
- Low deflection high strength steel
- Available in 60" and 72" lengths



PJA-02



SPECIFICATIONS

MODEL #	STOCK #	DESCRIPTION
PJA-01	589487	10,000 lb. capacity 72" reel axle
PJA-02	591619	10,000 lb. capacity 60" reel axle

PROJAX™ RISERS

PJS-01



Risers

- Enables PROJAX™ reel stands to be used with 104" reels



SPECIFICATIONS

MODEL #	STOCK #	DESCRIPTION
PJS-01	589553	Riser attachment for PROJAX™ reel stands (Pair)

SIMPULL™ COILPAK™ CART

CK01



The best material handling solution for SIMpull™ CoilPAK™ Payoffs.

- Rugged transport system for (8) SIMpull™ CoilPAK™ Payoffs with an integrated pay off system
- Allows SIMpull™ CoilPAK™ Wire Payoffs to be added or changed easily without impacting other SIMpull™ CoilPAK™ Wire Payoffs
- Innovative staging springs allow you to secure and organize up to 8 wires
- Best for scenarios where conductors are frequently changing, adding or dropping
- Cart includes 8" total lock casters
- Easy to use in hallways and fits through standard doors
- Individual wire feeds similar to a wire cart

SPECIFICATIONS

MODEL #	STOCK #	DESCRIPTION		
CK01	583869	SIMpull™ CoilPAK™ CART		
		LENGTH	WIDTH	HEIGHT
CK01		52"	24"	90"
				WEIGHT
				178 lb.

SIMPULL™ COILPAK™ UTILITY CART

UC100



Multipurpose cart designed for SIMpull™ CoilPAK™ solutions.

- Can hold and transport a variety of materials, tools, supplies, and SIMpull™ CoilPAK™ Payoffs
- Ability to hold up to 8 SIMpull™ CoilPAK™ Payoffs
- Incorporated low payoff height for easy circuit wire pulling at any angle
- Compact cart design for easy storage and transport
- Cart includes 8" total lock casters

SPECIFICATIONS

MODEL #	STOCK #	DESCRIPTION		
UC100	586172	SIMpull™ CoilPAK™ UTILITY CART		
		LENGTH	WIDTH	HEIGHT
UC100		46"	24"	45"
				WEIGHT
				107 lb.

SIMPULL™ CARTS

SIMPULL™ BARREL™ HAND TRUCK



The SIMPULL™ BARREL™ Hand Truck makes it easy to handle and transport your SIMPULL BARREL™ Drum.

- The SIMPULL™ BARREL™ Hand Truck, when used with the SIMPULL™ BARREL™ package, replaces the old wire cart and reels and the issues associated with them
- The hand truck includes a wire payoff feature, and is designed to transport the SIMPULL™ BARREL™ package anywhere on the jobsite - through narrow electrical room doors, over cords on the floor or construction gravel
- Solid rubber tires for no-flat jobsite peace of mind
- Rugged steel frame with unique design



SPECIFICATIONS

MODEL #	STOCK #	DESCRIPTION		
SBT01	58133001	SIMPULL™ BARREL™ HAND TRUCK		
	LENGTH	WIDTH	HEIGHT	WEIGHT
SBT01	27"	24.5"	61"	145 lb.

SIMPULL™ BARREL™ TRIPOD



The SIMPULL™ BARREL™ Tripod is a circuit wire payoff accessory used in connection with your new SIMPULL™ BARREL™ Drum.

- The SIMPULL™ BARREL™ Tripod is a circuit wire guide that mounts easily on the rim of the SIMPULL™ BARREL™
- This wire guide system provides unique means for guiding the paralleled conductors out of the barrel when it is not on the SIMPULL™ BARREL™ Hand Truck.



SPECIFICATIONS

MODEL #	STOCK #	DESCRIPTION			
SBT02	58133101	SIMPULL™ BARREL™ TRIPOD			
	LENGTH	WIDTH	HEIGHT	WEIGHT	TAP OUTSIDE DIAMETER
SBT02	36.5"	6.25"	6.25"	5.5 lb.	4.98"

WIRE WAGON® 510

WW510



Conduit and wire cart.

- Holds up to 14 - 2,500' spools or a combination of 2,500' and 1,000' spools
- Holds several hundred feet of conduit as well as all the additional materials and tools needed for your entire work day
- Designed with a full 24"x60" metal top shelf for storage and assembly
- Cart includes 8" total lock casters
- 2,000 lb. capacity

SPECIFICATIONS

MODEL #	STOCK #	DESCRIPTION		
WW510	568248	Wire Wagon® 510		
	LENGTH	WIDTH	HEIGHT	WEIGHT
WW510	60.5"	29.5"	46.25"	191 lb.

WIRE WAGON® 520

WW520



MC cable and conduit cart.

- Holds 4 spools of 1,000' MC cable
- Allows for different sizes and colors on one rack
- Comes standard with two sets of axles for wider than normal spools
- Eliminate spool jacks and the unnecessary set up and tear down time between pulls
- Cart includes 8" total lock casters
- Holds up to 1,000 ft. of conduit or strut
- 2,000 lb. capacity

SPECIFICATIONS

MODEL #	STOCK #	DESCRIPTION		
WW520	568250	Wire Wagon® 520		
	LENGTH	WIDTH	HEIGHT	WEIGHT
WW520	60"	52"	13"	125 lb.

WIRE WAGON® CARTS

WIRE WAGON® 530

WW530



Large spool cart.

- Holds 8 spools up to 16" in diameter
- Storage for extra tools, spools and materials
- Easy to load and unload
- Cart includes 8" total lock casters
- 1,000 lb. capacity

SPECIFICATIONS

MODEL #	STOCK #	DESCRIPTION			
WW530	568251	Wire Wagon® 530			
		LENGTH	WIDTH	HEIGHT	WEIGHT
WW530	50"	29.5"	42"	155 lb.	

WIRE WAGON® 535

WW535



Large capacity wire cart.

- Holds up to 20 – 500' spools of 12 AWG and 14 AWG or 6 -2500' spools of 12 AWG and 14 AWG
- Will hold up to 9 boxes of data cable or 6 - 1,000 ft. spools
- Extra storage shelf for tools, spools and materials
- Easy to load and unload, there are no axles or pins to remove
- Cart includes 8" total lock casters
- 1,000 lb. capacity

SPECIFICATIONS

MODEL #	STOCK #	DESCRIPTION			
WW535	568252	Wire Wagon® 535			
		LENGTH	WIDTH	HEIGHT	WEIGHT
WW535	50"	29.5"	42"	142 lb.	

WIRE WAGON® 538

WW538



Service cart.

- Holds up to 12 – 500' spools of 12 AWG and 14 AWG
- Constructed with 5/8" solid steel bar to support almost any combination of wire spools
- Easy movement around the jobsite
- Folds flat in seconds for minimal storage
- Great for service trucks or vans

SPECIFICATIONS

MODEL #	STOCK #	DESCRIPTION		
WW538	568254	Wire Wagon® 538		
	LENGTH	WIDTH	HEIGHT	WEIGHT
WW538	32.5"	26.5"	36.5"	25.5 lb.

WIRE WAGON® 550

WW550



Mobile print table and work station.

- No wasting time looking around the jobsite for something to use as a print table
- No wasting time back and forth to a stationary print table
- Move your plans and materials right to the work area
- 1,000 lb. capacity
- Cart includes 8" total lock casters
- Multiple uses:
 - Mobile print table
 - Material shelf
 - Conduit rack
 - Portable work bench

SPECIFICATIONS

MODEL #	STOCK #	DESCRIPTION		
WW550	568255	Wire Wagon® 550		
	LENGTH	WIDTH	HEIGHT	WEIGHT
WW550	54"	32"	42"	180 lb.



WIRE WAGON® CARTS

WIRE WAGON® 560

WW560



Conduit rack.

- Cart includes 6" casters
- Fast and simple collapsible design for storage and transportation
- Multipurpose conduit, pipe, and strut rack
- 1,000 lb. capacity



SPECIFICATIONS

MODEL #	STOCK #	DESCRIPTION			
WW560	589868	Wire Wagon® 560			
			LENGTH	WIDTH	HEIGHT
WW560			58.5"	34"	19"
					WEIGHT
					140 lb.

SIX PACK MAC™ WIRE CART

PM06



Compact wire dispensing cart.

- Stores in one-third of the space of conventional dispensers
- Reel spindles fold and lock for convenient storage
- Fits through a 30" doorway
- Two 10" wheels with one 8" locking swivel caster for easy maneuverability
- Welded wire guides for easy payoff
- Stores up to (6) 2,500' spools (18" diameter) of wire
- Travels through a 36" doorway
- Can be shipped via UPS

SPECIFICATIONS

MODEL #	STOCK #	DESCRIPTION		
PM06	783350	SIX PACK MAC™ Wire Cart		
		LENGTH	WIDTH	HEIGHT
PM06		28.75"	39.5"	31.5"
				WEIGHT
				81 lb.

TEN PACK MAC™ WIRE CART

PM10



Mobile wire dispensing cart.

- Handle/guide loop position controlled by plunger: 4-positions, no loose parts
- Spindles fold up & lock
- Mast swivels 360 degrees, but can be locked in fixed positions
- Mast may be removed for compact storage
- 4-heavy duty, locking 8" swivel casters
- Feed handle and guide loops are built into one part

SPECIFICATIONS

MODEL #	STOCK #	DESCRIPTION		
PM10	783366	TEN PACK MAC™ Wire Cart		
		LENGTH	WIDTH	HEIGHT
PM10		33"	41"	56.5"
				WEIGHT
				250 lb.

WIRE DOLLIES

CADDY MAC™ #1 DOLLY

CM01



Transports spools on spindles and works as a dolly. Wire is dispensed while laying flat.

- 1/2" solid spindles are attached to cart.
- No loose pieces. Spindles lock into place, even during transport.
- Spindles swing out to set position for convenient loading of wire spools
- Can be used with Handi Mac for extra storage

SPECIFICATIONS

MODEL #	STOCK #	DESCRIPTION			
CM01	783398	CADDY MAC™ #1 Dolly			
		LENGTH	WIDTH	HEIGHT	WEIGHT
CM01	20"	26"	49"	50 lb.	

CADDY MAC™ #2 DOLLY

CM02



CADDY MAC™ #2 Dolly holds 16 spools of #10 AWG or 24 spools of #12 AWG.

- Spindles can be easily removed for the occasional use of larger spools
- Inner spindles store in special loops which can hold four pieces and will not fall out during transportation.
- Hinge design allows easy access to all spools for wire dispensing and folds for compact storage.

SPECIFICATIONS

MODEL #	STOCK #	DESCRIPTION			
CM02	783395	CADDY MAC™ #2 Dolly			
		LENGTH	WIDTH	HEIGHT	WEIGHT
CM02	14"	26"	49.5"	63 lb.	

CADDY MAC™ #3 DOLLY

CM03



CADDY MAC™ #3 Dolly is a versatile wire cart that doubles as a dolly.

- Uses five 5/8" diameter spindles
- Unique spindle locking system, no loose clips
- Storage loops retain up to 5 spindles
- Dual wire guides
- Large spool capacity

SPECIFICATIONS

MODEL #	STOCK #	DESCRIPTION		
CM03	783400	CADDY MAC™ #3 Dolly		
	LENGTH	WIDTH	HEIGHT	WEIGHT
CM03	21.5"	26.5"	47.25"	78 lb.

SPOOL MAC™ CART

SM-01



Wire payoff cart.

- All steel frame construction
- 10" wheels for easy transport over rough terrain
- Rollers on spool arm allow for smooth reel rotation and easy payoff
- No loose pieces to account for
- Folding design allows for compact storage
- Fits through 32" doorways
- 350 lb. (160 kg) load capacity

SPECIFICATIONS

MODEL #	STOCK #	DESCRIPTION		
SM-01	783444	SPOOL MAC™ Cart		
	LENGTH	WIDTH	HEIGHT	WEIGHT
SM-01	16"	31.5"	63.5"	80 lb.

WIRE DISPENSER

HANDI MAC™

HM-01



Wire dispenser.

- Provides extra spool storage for Caddy Mac™ 1 or as a free standing wire dispenser
- Holds up to 8 additional spools
- Spindles are made of sturdy 3/8" steel bar

SPECIFICATIONS

MODEL #	STOCK #	DESCRIPTION		
HM-01	783490	HANDI MAC™ Wire Dispenser		
	LENGTH	WIDTH	HEIGHT	WEIGHT
HM-01	22.5"	12.5"	10"	7.5 lb.



STOR MAC™ 60

SM60



Security storage cabinet.

- Tough steel wire mesh
- Four 6" heavy duty casters (standard)
- For high visibility storage
- Reinforced frame & door
- Removable shelves
- Lockable doors
- Load capacity 1,500 lb.

SPECIFICATIONS

MODEL #	STOCK #	DESCRIPTION		
SM60	784920	STOR MAC™ 60		
	LENGTH	WIDTH	HEIGHT	WEIGHT
SM60	33.75"	63.5"	58"	345 lb.

STOR MAC™ 48

SM48



Security storage cabinet.

- Tough steel wire mesh
- Four 6" heavy duty casters (standard)
- For high visibility storage
- Reinforced frame & door
- Removable shelves
- Lockable doors
- Load capacity 1,500 lb.

SPECIFICATIONS

MODEL #	STOCK #	DESCRIPTION		
SM48	785921	STOR MAC™ 48		
	LENGTH	WIDTH	HEIGHT	WEIGHT
SM48	33.75"	51.5"	58"	310 lb.

STORAGE CONTAINERS

STOR MAC™ 30

SM30



A mobile, heavy-duty stacking container.

- Tough steel wire mesh
- Four 6" heavy duty casters (standard)
- For high visibility storage
- Reinforced frame & door
- Removable shelves
- Lockable doors
- Load capacity 1,500 lb.

SPECIFICATIONS

MODEL #	STOCK #	DESCRIPTION		
SM30	785920	STOR MAC™ 30		
	LENGTH	WIDTH	HEIGHT	WEIGHT
SM30	33.75"	31.5"	58"	210 lb.



TAINER MAC™ 60

TM60B



A mobile, heavy-duty stacking container.

- Transports 1,500 lb. / 680 kg of material
- Large storage capacity
- Four 6" heavy-duty lockable casters
- Posts for stacking & steering
- Fits through 36" (91 cm) doorway
- Stacks with other Sumner Stacking Macs

SPECIFICATIONS

MODEL #	STOCK #	DESCRIPTION		
TM60B	784990	TAINER MAC™ 60		
	LENGTH	WIDTH	HEIGHT	WEIGHT
TM60B	56"	32"	40"	200 lb.

TAINER MAC™ 40

TM45B



A mobile, heavy-duty stacking container.

- Transports 1,500 lb. / 680 kg of material
- Large storage capacity
- Four 6" heavy-duty lockable casters
- Posts for stacking & steering
- Fits through 36" (91 cm) doorway
- Stacks with other Sumner Stacking Macs

SPECIFICATIONS

MODEL #	STOCK #	DESCRIPTION		
TM45B	784986	TAINER MAC™ 40		
	LENGTH	WIDTH	HEIGHT	WEIGHT
TM45B	45"	30"	37"	190 lb.

STORAGE CONTAINERS

TAINER MAC™ 30

TM30B



A mobile, heavy-duty stacking container.

- Transports 1,500 lb. / 680 kg of material
- Large storage capacity
- Four 6" heavy-duty lockable casters
- Posts for stacking & steering
- Fits through 36" (91 cm) doorway
- Stacks with other Sumner Stacking Macs

SPECIFICATIONS

MODEL #	STOCK #	DESCRIPTION		
TM30B	784988	TAINER MAC™ 30		
	LENGTH	WIDTH	HEIGHT	WEIGHT
TM30B	30"	30"	37"	145 lb.

KD TAINER MAC™ 60

KM60



The knockdown version of Sumner's Tainer Mac™.

- Breaks down for easy storage
- Large storage capacity
- Four 6" heavy-duty lockable casters
- Posts for stacking & steering
- Fits through 36" (91 cm) doorway

SPECIFICATIONS

MODEL #	STOCK #	DESCRIPTION		
KM60	784987	KD TAINER MAC™ 60		
	LENGTH	WIDTH	HEIGHT	WEIGHT
KM60	56"	32"	40"	200 lb.

KD TAINER MAC™ 45

KM45



The knockdown version of Sumner's Tainer Mac™.

- Breaks down for easy storage
- Large storage capacity
- Four 6" heavy-duty lockable casters
- Posts for stacking & steering
- Fits through 36" (91 cm) doorway

SPECIFICATIONS

MODEL #	STOCK #	DESCRIPTION		
KM45	784986	KD TAINER MAC™ 45		
	LENGTH	WIDTH	HEIGHT	WEIGHT
KM45	45"	30"	37"	190 lb.

KD TAINER MAC™ 30

KM30



The knockdown version of Sumner's Tainer Mac™.

- Breaks down for easy storage
- Large storage capacity
- Four 6" heavy-duty lockable casters
- Posts for stacking & steering
- Fits through 36" (91 cm) doorway

SPECIFICATIONS

MODEL #	STOCK #	DESCRIPTION		
KM30	784985	KD TAINER MAC™ 30		
	LENGTH	WIDTH	HEIGHT	WEIGHT
KM30	30"	30"	37"	145 lb.

WELDBOXES

WELDBOX™ 3617

WB3617



The ideal storage chest for all welders & electricians.

- Two-point latching system requires only one lock
- Caster ready
- 16-gauge steel construction
- Powder-coat finish for superior durability and corrosion resistance

SPECIFICATIONS

MODEL #	STOCK #	DESCRIPTION	LENGTH	WIDTH	HEIGHT	WEIGHT
WB3617	779928	WELDBOX™ 3617				
WB3617			22.5"	36"	17"	97.9 lb.

WELDBOX™ 2812

WB2812



Storage chest.

- 16-gauge steel construction
- Powder-coat finish for superior durability and corrosion resistance

SPECIFICATIONS

MODEL #	STOCK #	DESCRIPTION	LENGTH	WIDTH	HEIGHT	WEIGHT
WB2812	779911	WELDBOX™ 2812				
WB2812			11"	28.375"	12"	30.8 lb.

WELDBOX™ 2008

WB2008



Tool storage box.

- Powder-coat finish for superior durability and corrosion resistance

SPECIFICATIONS

MODEL #	STOCK #	DESCRIPTION	LENGTH	WIDTH	HEIGHT	WEIGHT
WB2008	779910	WELDBOX™ 2008				
WB2008			9.5"	20.125"	8.5"	12.1 lb.

COMMAND HQ

CMD-HQ



Command HQ Jobsite office w/ Monitor and uninterruptible power supply.

- Fits through a standard 28 in. wide steel door frame
- Includes 32" monitor, back-up power supply, wiring harness, and power strip
- Includes UPS back-up power supply for at least 30 minutes of emergency power
- Powder-coat finish for superior durability and corrosion resistance, steel thickness: 16-gauge (14-gauge floor)
- Welded fork tubes for easy transport
- Includes wheel casters (with casters installed 39.3" long, 26.79" wide, 48.25" high)

SPECIFICATIONS

MODEL #	STOCK #	DESCRIPTION			
CMD-HQ	64812301	Command HQ Jobsite office w/Monitor and uninterruptible power supply			
	LENGTH	WIDTH	HEIGHT	WEIGHT	
CMD-HQ	48.25"	39.5"	27"	320 lb.	



STORAGE BOXES

BI-FOLD CABINET



CB603065

Bi-Fold Cabinet gives you unrestricted access to your tools. With heavy duty shelves and a single locking point.

- Recessed lock housing for protection against theft with one-time lock installation
- Powder-coat finish for superior durability and corrosion resistance
- Heavy duty 16 gauge box construction
- Welded shelves
- Heavy duty hinges to resist break in
- Casters included

SPECIFICATIONS

MODEL #	STOCK #	DESCRIPTION	LENGTH	WIDTH	HEIGHT	WEIGHT
CB603065	598227	Bi-Fold Cabinet	14"	120"	65"	470 lb.

TWO DOOR CABINET



CB602460

Two Door Cabinet gives you two ways to store your tools. With heavy duty shelves and a large vertical storage area, you can easily organize and secure your tools.

- Recessed lock housing for protection against theft with one-time lock installation
- Four-way skids allow access from any side, making it easier and faster to transport
- Powder-coat finish for superior durability and corrosion resistance
- Caster-ready 7 gauge steel skids
- Heavy duty 16 gauge box construction
- Welded shelves
- Heavy-duty hinges to resist break in
- Casters not included

SPECIFICATIONS

MODEL #	STOCK #	DESCRIPTION	LENGTH	WIDTH	HEIGHT	WEIGHT
CB602460	598228	Two Door Cabinet	24"	60"	60"	385 lb.

PIANO BOX



PB603049



Piano Boxes offer, at a glance, storage for both small and large tools, making it possible to organize and secure your livelihood, save time, and reduce costs on the jobsite.

- Recessed lock housing for protection against theft with one-time lock installation
- Four-way skids allow access from any side, making it easier and faster to transport
- Powder-coat finish for superior durability and corrosion resistance
- Caster-ready 7 gauge steel skids
- Heavy-duty 16 gauge box construction
- Welded shelves
- Heavy-duty hinges to resist break in
- Casters not included

SPECIFICATIONS

MODEL #	STOCK #	DESCRIPTION		
PB603049	598224	Piano Box		
	LENGTH	WIDTH	HEIGHT	WEIGHT
PB603049	30"	60"	48.5"	337 lb.

PIANO BOX



PB483048



Piano Boxes offer, at a glance, storage for both small and large tools, making it possible to organize and secure your livelihood, save time, and reduce costs on the jobsite.

- Recessed lock housing for protection against theft with one-time lock installation
- Four-way skids allow access from any side, making it easier and faster to transport
- Powder-coat finish for superior durability and corrosion resistance
- Caster-ready 7 gauge steel skids
- Heavy-duty 16 gauge box construction
- Welded shelves
- Heavy-duty hinges to resist break in
- Casters not included

SPECIFICATIONS

MODEL #	STOCK #	DESCRIPTION		
PB483048	598223	Piano Box		
	LENGTH	WIDTH	HEIGHT	WEIGHT
PB483048	20"	48"	48"	287 lb.

STORAGE BOXES

PIANO BOX



PB603034



Piano Boxes offer, at a glance, storage for both small and large tools, making it possible to organize and secure your livelihood, save time, and reduce costs on the jobsite.

- Recessed lock housing for protection against theft with one-time lock installation
- Four-way skids allow access from any side, making it easier and faster to transport
- Powder-coat finish for superior durability and corrosion resistance
- Caster-ready 7 gauge steel skids
- Heavy-duty 16 gauge box construction
- Welded shelves
- Heavy-duty hinges to resist break in
- Casters not included

SPECIFICATIONS

MODEL #	STOCK #	DESCRIPTION		
PB603034	598222	Piano Box		
	LENGTH	WIDTH	HEIGHT	WEIGHT
PB603034	30"	60"	34"	282 lb.

FIELD OFFICE



F0604482



Field Office offers a large workstation with shelved storage and a single locking point, allowing you to control and secure any jobsite.

- Recessed lock housing for protection against theft with one-time lock installation
- Four-way skids allow access from any side, making it easier and faster to transport
- Powder-coat finish for superior durability and corrosion resistance
- Caster-ready 7 gauge steel skids
- Heavy-duty 16 gauge box construction
- Welded shelves
- Heavy-duty hinges to resist break in
- Casters not included

SPECIFICATIONS

MODEL #	STOCK #	DESCRIPTION		
F0604482	598225	Field Office		
	LENGTH	WIDTH	HEIGHT	WEIGHT
F0604482	44"	60"	82"	678 lb.

COMPACT CHEST

CC482423



Compact Chest is a highly mobile storage vault. With the perfect profile for a truck bed and steel fork lift skids, this box will become your workhorse.

- Recessed lock housing for protection against theft with one-time lock installation
- Four-way skids allow access from any side, making it easier and faster to transport
- Powder-coat finish for superior durability and corrosion resistance
- Caster-ready 7 gauge steel skids
- Heavy-duty 16 gauge box construction
- Welded shelves
- Heavy-duty hinges to resist break in
- Casters not included

SPECIFICATIONS

MODEL #	STOCK #	DESCRIPTION		
CC482423	598226	Compact Chest		
	LENGTH	WIDTH	HEIGHT	WEIGHT
CC482423	24"	48"	22.5"	145 lb.

MINI COMPACT CHEST

CC191932



Mini Compact Chest is a highly mobile storage solution that stores easily in about any location.

- Recessed lock housing for protection against theft with one-time lock installation
- Four-way skids allow access from any side, making it easier and faster to transport
- Powder-coat finish for superior durability and corrosion resistance
- Caster-ready 7 gauge steel skids
- Heavy-duty 16 gauge box construction
- Welded shelves
- Heavy-duty hinges to resist break in
- Casters not included

SPECIFICATIONS

MODEL #	STOCK #	DESCRIPTION		
CC191932	630360	Mini Compact Chest		
	LENGTH	WIDTH	HEIGHT	WEIGHT
CC191932	32"	19"	19"	73 lb.

SUMNER

Sumner, A Southwire Company, is a recognized leading manufacturer of material lifts, jack stands, welding tools, material carts and other tools and equipment for the construction market. We are a key supplier to the welding and mechanical contracting industries and have a market presence in more than 50 countries around the world. Sumner maintains manufacturing and sales operations in Houston, Canada, China, the UK and the Netherlands.

- Lifts
- Gantries
- Stands
- Dollies



SPECIALTY LIFTS

EL-405 Stacker Lift

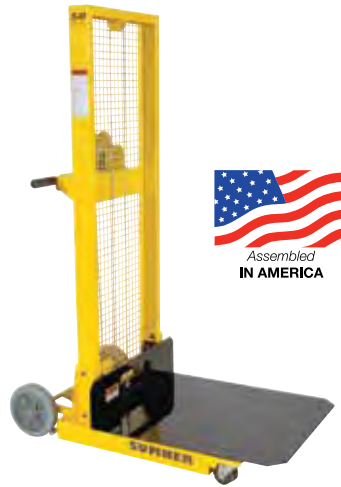

784650

Roust-A-Bout™



780300

Fab-Mate™



783900

MATERIAL LIFTS

Series 1900 Material Lift (8' - 10' / 2.4 - 3 m), 350 - 400 lb. (160 - 180 kg) Capacity

Series 2000 Material Lift (10' - 25' / 2.9 - 7.7 m), 650 - 1,000 lb. (300- 455 kg) Capacity

Series 2100 Contractor Lift (12' - 24' / 3.9 - 7.2 m), 650 lb. (300 kg) Capacity

Series 2200 Lil' Hoister™ Lift (9' - 11' / 2.7 - 3.4 m), 300 lb. (135 kg) Capacity

Series 2300 Drywall/HVAC Lift (11' - 15' / 3.4 m - 4.5 m), 150 lb. (70 kg) Capacity

Series 2400 Contractor Lift (13' - 17' / 4.0 - 5.2 m), 450 lb. (200 kg) Capacity

Series 2500 Counter Weight Lift (10 - 25' / 3.0 - 7.7 m), 650 - 1,000 lb. (300-455 kg) Capacity

Series 2600 "Axel" The Big Lift™ (10 - 15' / 3.0 - 4.6 m), 1,100 lb. (500 kg) Capacity



Series 2400 Contractor Lift

The ideal lift for:

- HVAC contractors
- Electrical contractors
- Industrial maintenance
- Steel erectors
- Facility management

784750

Series 2100 Contractor Lift

Model 2118 pictured here.



783651

For a full range of material lifts see the Sumner Material Lift Catalog or visit sumner.com.

ALL ALUMINUM GANTRIES

GH3/4 Gantry

GH2T Gantry

GH5T Gantry



*Chain hoist
not included*

**5 Ton
5 Metric Ton
11,000 lb.
785805**

**2 Ton
2 Metric Ton
4,400 lb.
785100**

**3/4 Ton
3/4 Metric Ton
1,650 lb.
785301**



For a full range of material lifts see the Sumner Material Lift Catalog or visit sumner.com.

**Trademark of Sumner Manufacturing, LLC.*

Gantries | SUMNER®

EVENTER™ STAGE LIFT

Standard Features:

- Blackened anodized mast
- Fits through standard doorways in stowed position
- No winch cable in operator's face
- Forks reverse for added height
- Large, rubber-padded leveling jacks
- Built-in safety brakes



All EVENTER stage lifts are designed for compact storage.

Ideal for small to medium venues:

- Hotel Ballrooms
- Churches
- Schools
- Clubs

EVENTER 16
pictured here.



784760

The EVENTER 16
is easily transportable



For a full range of material lifts see the Sumner Material Lift Catalog or visit sumner.com.

**Trademark of Sumner Manufacturing, LLC.*

PIPE STANDS

Standard Features on all Sumner Jacks:

- 1-1/2" (38 mm) Acme fine adjustment thread — the largest in the industry
- Large, convenient adjustment handle
- Quick-action lock washer
- Fall Guard™ support
- Set screw can the lock jack head to the stand — no loose pieces
- Backed by over forty years of jack stand manufacturing experience

Sumner Jacks:

Heavy Duty Jack

Heavy Duty Jack Plus

"Pro Jack"™

Fold-A-Jack™

FAB SAF™ Jack

Fat Jack™

Hi Boy™ Jack

Midi Fat™ Jack
w/Vee Head
785251

FAB SAF™ Jack
w/Vee Head
780395

Hi Fold-A-Jack™
781300



For a full range of material lifts see the Sumner Material Lift Catalog or visit sumner.com.

**Trademark of Sumner Manufacturing, LLC.*

PRO ROLLS™ & ADJUST-A-ROLL™

Hi Adust-A-Roll™

Lo Adust-A-Roll™

Table Adjust-A-Roll™

Mini-Roll™

Pro Roll™



Hi Adjust-A-Roll
with roller wheels
780565

Pro Roll with roller wheels
780441

Mini-Roll with roller wheels
785283



For a full range of material lifts see the Sumner Material Lift Catalog or visit sumner.com.

**Trademark of Sumner Manufacturing, LLC.*

SUMNER® | Adjust-A-Roll™

MAX-JAX™ I & II AND BEAM-JAX™

Max-Jax™ (Kit #1 shown)

The versatile Max-Jax stand is the ideal fabricator stand. The large 12" (30 cm) vee head and heavy duty five-leg design offers the welder a larger margin of safety on pipe up to 36" (90 cm).



781403

Max-Jax™ 2 (Kit #2 with Rocking Rollers shown)

The Max-Jax 2 stand has the unique capability of being either a low or high moveable jack stand for 4 - 36" (100 - 915 mm) pipe. By removing the jack head and casters from the base, it can be rotated from a Lo to a Hi stand.



786451

Beam-Jax™ (Basic Beam-Jax™ shown)

Used as a stand, the basic Beam-Jax base safely supports 24" range (61 cm) and beams up to 2,500 lb (1,135 kg).



781485

For a full range of material lifts see the Sumner Material Lift Catalog or visit sumner.com.

**Trademark of Sumner Manufacturing, LLC.*

FIT-UP-TOOLS

PFAST™

PIPE FITTING ALIGNMENT SYSTEM TECHNIQUE

A Professional Fit-Up System For The Fabricator



- ✓ Fit-up 1" to 8" flanges, fittings, reducers, caps and pup joints
- ✓ Capable of 300 lb. pressure-rated flanges
- ✓ Handles 600 lb. / 270 kg loads
- ✓ Exceptionally accurate
- ✓ Fit and tack 75 to 90 joints during an 8 hour shift
- ✓ Now in stainless steel

With the purchase of each PFAST system, Sumner provides optional in-house set up and training to ensure that your team is comfortable in operating and maintaining your PFAST system. Each unit comes complete with all accessories to perform most fit up applications and a mounted electronic tablet that provides a step-by-step pictorial instruction on how each assembly is set up.

Built for years of use, the Sumner PFAST system will quickly help fabricators be a production leader in their industry.

Other Fit-Up Tools

Adjust-A-Fit™	Fit Kits	Mul-T-Square*	Ultra Qwik Clamp™
Adjust-A-Flange™	Flange Leveler	Purge Star*	Ultra Fit™
Center Punch	Flange Pins	Qwik Pins*	Ultra Qwik Fit™
Clamp Champ™	Flange Spreaders	Ring Purge	Universal Center Punch
DX Clamp	Internal Fit-Up Clamp	Rotary Ground Clamp	Welder's Stool
Expansion Plugs	Levels	Standard Square	Welding Gage
Fab Mate™	Magnetic Holder	Ultra Clamp*	

For a full range of material lifts see the Sumner Material Lift Catalog or visit sumner.com.

**Trademark of Sumner Manufacturing, LLC.*

PIPE DOLLIES

CRICKET* Pipe Buggy

Uses leverage
to lift pipe!



GRASSHOPPER™ Texas Pipe Dolly

Enables
one man to lift up to
2,000 lb. (900 kg)
unassisted!



For a full range of material lifts see the Sumner Material Lift Catalog or visit sumner.com.

**Trademark of Sumner Manufacturing, LLC.*

MATERIAL HANDLING

Bundle Mac™

Handi-Bench™

Hanger Mac™

Mac Rack I & II™

Pipe Mac™

Weldbox™



Mac Rack I™
783317

For a full range of material lifts see the Sumner Material Lift Catalog or visit sumner.com.

**Trademark of Sumner Manufacturing, LLC.*

WELDING CYLINDER CARTS

Small Single

Heavy Duty Single

Small-Medium High Rail

Medium Range High Rail

Full Range High Rail



**Medium Range, High Rail
Cylinder Cart w/Chain
Model #209
209-14S**

**Small-Med High Rail
Cylinder Carts
(Model #207)
2017-10S**



**Full Range, High Rail
Cylinder Cart w/ Lifting Eye
& Firewall
(Model #213)
213-16FB-LF**



For a full range of material lifts see the Sumner Material Lift Catalog or visit sumner.com.

**Trademark of Sumner Manufacturing, LLC.*

Welding Cylinder Carts | SUMNER®

ELECTRICAL

Southwire's electrical products have what you need to get the job done right. Our products have been trusted by contractors and electricians for more than 40 years and have raised the standards for quality and innovation. Our product categories include: the broadest assortment of indoor and outdoor cords sets, portable lighting, GFCI, and automotive products. Count on these products to create your complete project solutions for today's toughest applications.

- Cords
- Work Lights
- Portable Power
- GFCI
- Automotive



PREMIUM OUTDOOR EXTENSION CORDS

1428



Premium TPE Polar/Solar® cords, made with Southwire's exclusive T*Prene® insulation, stay flexible under the most extreme temperatures. They are highly abrasion resistant and provide outstanding oil and chemical resistance.

SPECIFICATIONS

POLAR/SOLAR® STANDARD EXTENSION CORDS



PART#	WIRE GA/COND	WIRE TYPE	COLOR	125V RATING	LENGTH
1287SW0002	16/3	SJEOOW	Yellow	13A	25 ft.
1288SW0002	16/3	SJEOOW	Yellow	13A	50 ft.
1289SW0002	16/3	SJEOOW	Yellow	10A	100 ft.
1427SW0008	14/3	SJEOOW	Black	15A	25 ft.
1428SW0008	14/3	SJEOOW	Black	15A	50 ft.
1429SW0008	14/3	SJEOOW	Black	13A	100 ft.
1487SW0002	14/3	SJEOOW	Yellow	15A	25 ft.
1488SW0002	14/3	SJEOOW	Yellow	15A	50 ft.
1489SW0002	14/3	SJEOOW	Yellow	13A	100 ft.
1628SW0008	12/3	SJEOOW	Black	15A	50 ft.
1629SW0008	12/3	SJEOOW	Black	15A	100 ft.
1687SW0002	12/3	SJEOOW	Yellow	15A	25 ft.
1688SW0002	12/3	SJEOOW	Yellow	15A	50 ft.
1689SW0002	12/3	SJEOOW	Yellow	15A	100 ft.
1787SW0002	10/3	SJEOOW	Yellow	15A	25 ft.
1788SW0002	10/3	SJEOOW	Yellow	15A	50 ft.
1789SW0002	10/3	SJEOOW	Yellow	15A	100 ft.
1769SW0002	12/3	SEOOW†	Yellow	15A	100 ft.

Extreme cold performance, the Polar/Solar® Supreme Extension Cord is made with our exclusive T*Prene insulation jacket. T*Prene is formulated to offer superior jobsite performance in extremely cold weather. Polar/Solar® Supreme cord is abrasion, chemical, and oil resistant for survival in the toughest of environments.

1439



SPECIFICATIONS

POLAR/SOLAR® SUPREME EXTENSION CORDS



PART#	WIRE GA/COND	WIRE TYPE	COLOR	125V RATING	LENGTH
1437SW0061	14/3	SJEOW	Blue/White	15A	25 ft.
1438SW0061	14/3	SJEOW	Blue/White	15A	50 ft.
1439SW0061	14/3	SJEOW	Blue/White	13A	100 ft.
1637SW0061	12/3	SJEOW	Blue/White	15A	25 ft.
1638SW0061	12/3	SJEOW	Blue/White	15A	50 ft.
1639SW0061	12/3	SJEOW	Blue/White	15A	100 ft.

CORDS

PREMIUM OUTDOOR EXTENSION CORDS



Premium TPE Polar/Solar® cords, made with Southwire's exclusive T*Prene® insulation, stay flexible under the most extreme temperatures. They are highly abrasion resistant and provide outstanding oil and chemical resistance.

SPECIFICATIONS

POLAR/SOLAR® SEOWW EXTENSION CORDS



PART#	WIRE GA/COND	WIRE TYPE	COLOR	125V RATING	LENGTH
1567SW0002	14/3	SEOWW	Yellow	15A	25 ft.
1568SW0002	14/3	SEOWW	Yellow	15A	50 ft.
1569SW0002	14/3	SEOWW	Yellow	13A	100 ft.
1767SW0002	12/3	SEOWW	Yellow	15A	25 ft.
1768SW0002	12/3	SEOWW	Yellow	15A	50 ft.
1769SW0002	12/3	SEOWW	Yellow	15A	100 ft.

POLAR/SOLAR® THREE-WAY POWER BLOCKS

PART#	WIRE GA/COND	WIRE TYPE	COLOR	125V RATING	LENGTH
3482SW0002*	12/3	SEOWW†	Yellow	15A	2 ft.
3487SW0002	12/3	SJEOOW	Yellow	15A	25 ft.
3488SW0002	12/3	SJEOOW	Yellow	15A	50 ft.
3489SW0002	12/3	SJEOOW	Black	15A	100 ft.
3588SW0002	10/3	SJEOOW	Yellow	15A	50 ft.
3589SW0002	10/3	SJEOOW	Yellow	15A	100 ft.

*Import †600V



ROYAL® PREMIUM OUTDOOR EXTENSION CORDS



Thermoset rubber jacketed cords have superior resistance to high temperature environments without losing the chemical and abrasion resistance. Harsh applications may include heavy industrial work, welding, and metal fabrication.

- Flexible in a wide range of temperatures
- Royal® SJ00W jacket

SPECIFICATIONS

ROYAL® SJ00W EXTENSION CORDS



PART#	WIRE GA/COND	WIRE TYPE	COLOR	125V RATING	LENGTH
3677SW0008	12/3	SJ00W	Black	15A	25 ft.
3678SW0008	12/3	SJ00W	Black	15A	50 ft.
3679SW0008	12/3	SJ00W	Black	15A	100 ft.
3687SW0002	12/3	SJ00W	Yellow	15A	25 ft.
3688SW0002	12/3	SJ00W	Yellow	15A	50 ft.
3689SW0002	12/3	SJ00W	Yellow	15A	100 ft.



OUTDOOR EXTENSION CORDS

2407



Vinyl jacket resists moisture, abrasion, and prolonged exposure to sunlight.

- Power indicator light in female receptacle to show that power is on
- Power block provides additional outlets for power distribution

SPECIFICATIONS

THREE CONDUCTOR



PART#	WIRE GA/COND	WIRE TYPE	COLOR	125V RATING	LENGTH
2211SW8808	16/3	SJOW	Black	13A	10 ft.
2304SW8803	16/3	SJTW	Orange	13A	10 ft.
2305SW8803	16/3	SJTW	Orange	13A	15 ft.
2306SW8808	16/3	SJTW	Black	13A	15 ft.
2307SW8803	16/3	SJTW	Orange	13A	25 ft.
2308SW8803	16/3	SJTW	Orange	13A	50 ft.
2309SW8803	16/3	SJTW	Orange	10A	100 ft.
2407SW8804	14/3	SJTW	Red	15A	25 ft.
2408SW8804	14/3	SJTW	Red	15A	50 ft.
2409SW8804	14/3	SJTW	Red	13A	100 ft.
2618SW8802*	10/3	SJTOW	Yellow	20A	50 ft.

*T-SLOT cord

2687



THREE CONDUCTOR - LIGHTED ENDS



PART#	WIRE GA/COND	WIRE TYPE	COLOR	125V RATING	LENGTH
2367SW8806	16/3	SJTW	Light Blue	13A	25 ft.
2368SW8806	16/3	SJTW	Light Blue	13A	50 ft.
2487SW8804	14/3	SJTW	Red	15A	25 ft.
2488SW8804	14/3	SJTW	Red	15A	50 ft.
2489SW8804	14/3	SJTW	Red	13A	100 ft.
2587SW8802	12/3	SJTW	Yellow	15A	25 ft.
2588SW0002	12/3	SJTW	Yellow	15A	50 ft.
2589SW0002	12/3	SJTW	Yellow	15A	100 ft.
2687SW8802	10/3	SJTW	Yellow	15A	25 ft.
2688SW8802	10/3	SJTW	Yellow	15A	50 ft.
2689SW8802	10/3	SJTW	Yellow	15A	100 ft.
2457SW0003	14/3	STW	Orange	15A	25 ft.
2458SW0003	14/3	STW	Orange	15A	50 ft.
2459SW0003	14/3	STW	Orange	13A	100 ft.
2557SW0003	12/3	STW	Orange	15A	25 ft.
2558SW0003	12/3	STW	Orange	15A	50 ft.
2559SW0003	12/3	STW	Orange	15A	100 ft.

CORDS

OUTDOOR EXTENSION CORDS

Vinyl jacket resists moisture, abrasion, and prolonged exposure to sunlight.

- Power indicator light in female receptacle to show that power is on
- Power block provides additional outlets for power distribution



SPECIFICATIONS

THREE-WAY POWER BLOCK

PART#	WIRE GA/COND	WIRE TYPE	COLOR	125V RATING	LENGTH
4004SW8803	14/3	SJTW	Orange	15A	6 ft.
4217SW8804	14/3	SJTW	Red	15A	25 ft.
4218SW8804	14/3	SJTW	Red	15A	50 ft.
4219SW8804	14/3	SJTW	Red	13A	100 ft.

THREE-WAY POWER BLOCK WITH LIGHTED ENDS

PART#	WIRE GA/COND	WIRE TYPE	125V RATING	LENGTH
4112SW8802*	12/3	STW(600V)	15A	2 ft.
4187SW8802	12/3	SJTW	15A	25 ft.
4188SW8802	12/3	SJTW	15A	50 ft.
4189SW8802	12/3	SJTW	15A	100 ft.
4388SW8802	10/3	SJTW	15A	50 ft.
4389SW8802	10/3	SJTW	15A	100 ft.

*not lighted

TWIST-TO-LOCK (NEMA L5-20P TO NEMA L5-20R)

PART#	WIRE GA/COND	WIRE TYPE	COLOR	125V RATING	LENGTH
9208SW8802	12/3	SJTW	Yellow	20A	50 ft.
9209SW8802	12/3	SJTW	Yellow	15A	100 ft.



TWIST-TO-LOCK (NEMA L5-20P TO NEMA L5-20R)

PART#	WIRE GA/COND	WIRE TYPE	COLOR	125V RATING	LENGTH
9208SW8802	12/3	STW(600V)	Yellow	20A	50 ft.
9209SW8802	12/3	STW(600V)	Yellow	15A	100 ft.



STRIPES & COOL COLORS® EXTENSION CORDS

2548USA1



2579



2548



Display America's colors on the jobsite with the rugged, striped, contractor grade extension cords dedicated to hard working contractors. They are highly visible red, with patriotic stripe colors. Contractor grade extension cords all have molded water resistant connectors with reinforced blades that make them suitable for all weather use. Increase safety awareness and help to prevent jobsite loss or theft with STRIPES and Cool Colors outdoor extension cords. Each extension cord features a dominate high-visibility color. Other cords feature a stripe that runs the length of the jacket. All Stripes and Cool Color cords feature a power indicator light in the receptacle to show power is on.

- Variety of colors for added safety and theft deterrence on the jobsite
- Power indicator light in the female receptacle to show that power is on



SPECIFICATIONS

STRIPES OUTDOOR EXTENSION CORDS

PART#	WIRE GA/COND	WIRE TYPE	COLOR	125V RATING	LENGTH
2548SWUSA1	12/3	SJTW	Red,Wht,Blue	15A	50 ft.
2549SWUSA1	12/3	SJTW	Red,Wht,Blue	15A	100 ft.
2548SW00XX	12/3	SJTW	See Color Options Below*	15A	50 ft.
2549SW00XX	12/3	SJTW		15A	100 ft.
2648SW00XX	10/3	SJTW		15A	50 ft.

* 12/3: Color (XX): 54=Lime Green/Red, 22=Yellow/Purple, 52=Dark Green/Yellow, 64=Blue/Red, 41=Red/White, 77=Pink/Lime Green, 3V=Orange/Blue
10/3: 54=Lime Green/Red, 64=Blue/Red

COOL COLORS OUTDOOR EXTENSION CORDS

PART#	WIRE GA/COND	WIRE TYPE	COLOR	125V RATING	LENGTH
2577SW00XX	12/3	SJTW	See Color Options Below*	15A	25 ft.
2578SW00XX	12/3	SJTW		15A	50 ft.
2579SW00XX	12/3	SJTW		15A	100 ft.

* Color (XX): 0A=Pink, 0H=Blue, 0X=Green

CORDS

HIGH VISIBILITY - LOW TEMP CORDS

2467

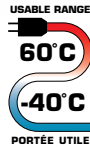

Bright blue cord is easily identified on the job site. High Vis/Low Temp vinyl cords provide super flexibility at temperatures down to -40°F.

- Jacket resists deterioration from moisture, abrasion and extended exposure to sunlight
- Power indicator light in the female receptacle to show that power is on

SPECIFICATIONS

THREE CONDUCTOR WITH LIGHTED ENDS

PART#	WIRE GA/COND	WIRE TYPE	COLOR	125V RATING	LENGTH
2367SW8806	16/3	SJTW Premium	Blue	13A	25 ft.
2368SW8806	16/3	SJTW Premium	Blue	13A	50 ft.
2467SW8806	14/3	SJTW Premium	Blue	15A	25 ft.
2468SW8806	14/3	SJTW Premium	Blue	15A	50 ft.
2469SW8806	14/3	SJTW Premium	Blue	13A	100 ft.
2568SW0006	12/3	SJTW Premium	Blue	15A	50 ft.
2569SW0006	12/3	SJTW Premium	Blue	15A	100 ft.

CORD + RV ADAPTERS

9906



9020



SPECIFICATIONS

15 AMP "W", 3 & 5 WAY, RV, & OTHER ADAPTERS

PART#	WIRE GA/COND	WIRE TYPE	COLOR	125V RATING	LENGTH
9020SW8802*	12/3	STW(600V)	Yellow	-	9 in.
9021SW8802†	12/3	STW(600V)	Yellow	-	9 in.
15AMP "W" ADAPTER					
9019SW8802	12/3	STW(600V)	Yellow	15A	2 ft.
5 WAY ADAPTER					
997362	-	-	Yellow	15A	-
3 WAY ADAPTER					
9906SW8803	T-S		Orange	15A	-
9906SW8808	T-S		Black	15A	-
RV ADAPTERS 125/250 VOLT					
9552SW9008	10/3	STW(600V)	Black	30A to 50A	-
POWER SUPPLY CORDS					
9527SW0008	6/3-8/1	STW(600V)	Black	50A	25 ft.
9561SW0008	6/3-8/1	SEW(600V)	Black	50A	36 ft.
9536SW0008	6/3-8/1	STW(600V)	Black	50A	36 ft.

*15A S/B PLUG 20A T/L Conn †20A T/L Plug 15A S/B Conn

‡30A RV Plug 50A RV Conn

RANGE & DRYER CORDS

9044



Thick vinyl insulation with right angle male plug. Strain relief clamp helps prevent cord damage. Hardware included.

- Reinforced blades help prevent accidental bending or breaking
- Heavy duty strain relief protects electrical connections

SPECIFICATIONS

RANGE & DRYER CORDS

PART#	WIRE GA/COND	WIRE TYPE	COLOR	125V RAT.	LENGTH
9014SW8809	6/2-8/1	SRDT Flat	Gray	50A	4 ft.
9016SW8809	6/2-8/1	SRDT Flat	Gray	50A	6 ft.
9044SW8808	6/2-8/2	SRDT Round	Black	50A	4 ft.
9046SW8808	6/2-8/2	SRDT Round	Black	50A	6 ft.
9124SW8809	10/3	SRDT Flat	Gray	30A	4 ft.
9126SW8809	10/3	SRDT Flat	Gray	30A	6 ft.
9154SW8808	10/4	SRDT Round	Black	30A	4 ft.
9156SW8808	10/4	SRDT Round	Black	30A	6 ft.

POWER SUPPLY CORDS

9854



Professional grade replacement power cords designed for use in rough or dirty indoor environments, shops, garages, etc.

- Heavy duty strain relief protects electrical connections
- Reinforced blades help prevent accidental bending or breaking
- SJEOW rating is water and oil resistant

SPECIFICATIONS

WATER & OIL RESISTANT CORDS

PART#	WIRE GA/COND	WIRE TYPE	COLOR	125V RAT.	LENGTH
9011SW0008*	12/3	SE00W/600V	Black	20A	25"
9012SW0008†	12/3	SE00W/600V	Black	15A	25"
9846SW0008	16/3	SE00W/600V	Black	13A	13.24 ft.
9853SW0008	16/2	SJE00W	Black	13A	6 ft.
9854SW0008	16/2	SJE00W 5-15P	Black	13A	9 ft.
9855SW0008	16/3	SJE00W 5-15P	Black	13A	6 ft.
9856SW0008	16/3	SJE00W 5-15P	Black	13A	9 ft.
6503SW0008	16/3	SJE00W 5-15P	Black	13A	20 ft.
9857SW0008	14/3	SJE00W 5-15P	Black	15A	6 ft.
9858SW0008	14/3	SJE00W 5-15P	Black	15A	9 ft.

*Twist to Lock

†Straight Blade

CORDS

POWER SUPPLY CORDS

9709



Replacement cords are designed for easy use on appliances, power tools, air conditioners, refrigerators, etc.

- Heavy duty strain relief protects electrical connections

SPECIFICATIONS

VINYL CONSTRUCTION

PART#	WIRE GA/COND	WIRE TYPE	COLOR	125V RAT.	LENGTH
3953	14/3	SJEW	Black	15A	10 ft.
9702SW8808	16/2	SJTW	Black	13A	6 ft.
9703SW8808	16/3	SJTW	Black	13A	3 ft.
9706SW8808	16/3	SJTW	Black	13A	6 ft.
9709SW8808	16/3	SJTW	Black	13A	9 ft.
9716SW8808	14/3	SJTW	Black	15A	6 ft.
9719SW8808	14/3	SJTW	Black	15A	9 ft.

9736



FLAT SPT-3 CONSTRUCTION

PART#	WIRE GA/COND	WIRE TYPE	COLOR	125V RAT.	LENGTH
9723SW8809	16/3	SPT-3	Grey	13A	3 ft.
9724SW8809	16/3	SPT-3 -R/Angle	Grey	13A	4 ft.
9726SW8809	16/3	SPT-3 -R/Angle	Grey	13A	6 ft.
9733SW8809	16/3	SPT-3 -Straight	Grey	13A	3 ft.
9734SW8809	16/3	SPT-3 -Straight	Grey	13A	4 ft.
9736SW8809	16/3	SPT-3 -Straight	Grey	13A	6 ft.
9743SW8823	14/3	SPT-3 -Straight	Beige	15A	3 ft.
9746SW8823	14/3	SPT-3 -Straight	Beige	15A	6 ft.

MAJOR APPLIANCE CORD

PART#	WIRE GA/COND	WIRE TYPE	COLOR	125V RAT.	LENGTH
3531SW3323	14/3	SPT-3	Beige	15A	3 ft.
3532SW3323	14/3	SPT-3	Beige	15A	6 ft.
3533SW3323	14/3	SPT-3	Beige	15A	9 ft.
3535SW3323	14/3	SPT-3	Beige	15A	12 ft.
3536SW3323	14/3	SPT-3	Beige	15A	15 ft.
3537SW8809*	12/3	SPT-3	Grey	20A	9 ft.

*6-20 P/R

HALOGEN WORK LIGHTS

L14SLEDSW



These work lights offer robust designs constructed in heavy duty die casting. The extra large housings run cooler for longer bulb life. These lights include the bulbs, have shadow fighter grills and grounded power cords. Suitable for residential construction, commercial, construction, or maintenance projects.

- All metal construction
- Tempered glass for safety with UV protection
- Shadow Fighter™ grill frames
- Easy grip adjustment nuts
- Comfort grip heavy duty handles
- UL and CUL listed

SPECIFICATIONS

HALOGEN WORK LIGHTS

PART#	STOCK#	BULBS	DESCRIPTION	CORD LENGTH
L20SW	58991501	1 - 500W	Economy with S-base	5 ft.
L33SW	58990901	1 - 500W	Contractor Grade with Switch	5 ft.
L845SW	59189601	1 - 250W	Clamp Lamp	5 ft.
L10SLEDSW	-	1 - 500W	Single Head - Detachable Sled with Tripod	5 ft.
L13SW	59180301	2 - 500W	Twin Head - No Detachable Sled with Tripod	5 ft.
L113SW	-	1 - 500W	Contractor Grade - Spring Supported Head*	10 ft.
L14SLEDSW	58844901	5 - 500W	Contractor Grade Twin Head - Detachables†	5 ft.
L41HDSW	59181401	1 - 500W	Dock Swing Arm - 40° Extension from Wall	10 ft.

*Comes with Roll Cage

†Comes with Bulb Storage Tube and Tripod

L20SW



L113SW



L33SW



WORK LIGHTS

LED TASK LIGHTS

L1407SW



Handheld task lighting provides tough, convenient lights for smaller work spaces. These LED lights provide long life, convenient portability and outstanding features.

- LEDs offer years of maintenance free operation
- Shock resistant durable construction
- Non-slip grip
- Batteries included
- Many with magnets for hands-free use
- On/Off push button switches
- Polycarbonate lens

SPECIFICATIONS

BATTERY POWERED LED TASK LIGHTS

PART#	STOCK#	LUMENS	DESCRIPTION	BULB
L1925SW	58842001	180	72 LED Rechargeable Task Light (charger included)	LED
L1407SW	58843501	32	24 LED (16 LED Area + 8 LED Spot) with laser pointer and magnet + base*	LED
L1240SW	58991101	42	21 LED Head Light with adjustable. Lycra Head Band*	LED
1437SW	-	97	37 LED (36 LED Task + 1 LED Spot) with Back Magnet*	LED

*Batteries Included

L1925SW



1437SW



L1240SW



INCANDESCENT TROUBLE LIGHTS

691SW



Trouble lights feature durability and practicality. Constructed from tough PVC with power switch, metal guard and grounded outlets. The choices in SJEOW cord are oil and chemical resistant and stay flexible under temperature extremes to -67°F.

- Metal reflective shield with protective grill
- Tough PVC construction makes handling effortless
- Dual hook permits hanging by either the guard or handle
- Standard with power switches and bulb cages
- 75 watt bulb maximum
- UL listed

053378802SW



SPECIFICATION

INCANDESCENT TROUBLE LIGHTS

PART#	STOCK#	GAUGE	WIRE TYPE	DESCRIPTION	LENGTH
OIL AND WATER RESISTANT - LOW TEMP					
53378802SW	-	18/3	SJEOW	Metal Guard with Outlet	25 ft.
58578802SW	-	16/3	SJEOW	Metal Guard with Outlet	25 ft.
58588802SW	-	16/3	SJEOW	Metal Guard with Outlet	50 ft.
56578802SW	58986101	14/3	SJEOW	Metal Guard with Outlet	25 ft.
56588802SW	-	14/3	SJEOW	Metal Guard with Outlet	50 ft.
WOODS BRANDED					
0691SW	-	16/3	SJTW	Metal Guard with Outlet	25 ft.
0692SW	-	16/3	SJTW	Metal Guard with Outlet	50 ft.

WORK LIGHTS

LED STRING LIGHTS

7164SW/7165SW



Southwire's LED String Light is the perfect LED solution for any jobsite application. Available in 50ft and 100ft lengths, this light features LEDs on the top and bottom of the module giving full job-site coverage.

- IP65 Rated
- Zero maintenance with no need to change bulbs
- Daisy Chain up to 10 Strings of the 100' Model and 20 String of the 50' model for longer lengths.

SPECIFICATIONS

MODEL #	LENGTH	LUMENS	WATTAGE	CORD TYPE	INPUT VOLTAGE
7164SW	50'	4000	39W	14/3 SJTW	120V
7165SW	100'	8000	78W	14/3 SJTW	120V

STRING LIGHTS AND GUARDS

7538SW



String lights are durable indoor/outdoor temporary lighting systems available in 50 and 100 ft lengths, 12 and 14 gauge. Each is provided with either a wire-form coated metal guard or easy-to-open, snap-on plastic guards to meet OSHA regulations. Molded lamp sockets spaced 10 feet apart. Lamps not included.

- NEC, OSHA Compliant, UL listed
- Sturdy molded-on lamp holder sockets and electrical connectors

SPECIFICATIONS

PART#	STOCK#	GAUGE	WIRE TYPE	DESCRIPTION	LENGTH
7538SW	-	12/3	SJTW	Coated Metal - 5-15 P&R	50 ft.
7539SW	-	12/3	SJTW	Coated Metal - 5-15 P&R	100 ft.
7548SW	-	12/3	SJTW	Plastic - 5-15 P&R	50 ft.
7549SW	-	12/3	SJTW	Plastic - 5-15 P&R	100 ft.
7145SW	-	14/2	SJTW	Plastic - 1-15P	100 ft.
7155SW	-	14/3	SJTW	Plastic - 5-15 P&R	100 ft.

7145SW



LED LOW BAY TEMPORARY JOB SITE LIGHT

T50078



The Southwire 78W Temporary LED Light with 3-foot power cord and integral hook for easy install is perfect for any jobsite/construction site. The frosted lens not only helps to reduce glare, but also improves beam angle. No maintenance required. Available in Hardwire version as well!

- Input Voltage of 120Vac 50/60Hz
- LED light source consumes less power and lasts longer
- Rugged die cast aluminum body
- cULus, FCC/ICES certified

SPECIFICATIONS

MODEL #	DESCRIPTION	WATTAGE	LUMENS	CORD LENGTH	INPUT VOLTAGE
T50078	LED Low Bay	78	8200	3 FT	120V
T50079	Hardwire LED Low Bay	78	8200	Hardwire	120V/277V

WORK LIGHTS

METAL HALIDE TEMPORARY LIGHT - PULSE START

7605SW



NEC compliant pulse start lamp with up to 36,000 initial lumens, 20,000 hours of bulb life and 50% faster warm-up. Fast plug-in installation, and spring-loaded hook. Knock-outs for hard wire and local codes. EISA 2007 compliant

- Includes fixture, hook, guard and bottom cover
- UL listed, exclusionary ex-39 (pink) socket, Type O Lamp

SPECIFICATIONS

SECURITY LIGHTING

PART#	STOCK#	WATT	WIRE TYPE	DESCRIPTION	LENGTH
7605SW	-	400	18/3 SJTW	10" Wire Guard, Type "o" incl.	3 ft.

CLAMP LIGHTS

151SW



These lights are designed to meet the needs of contractors, farmers, and painters. These economical products provide convenient temporary light.

- Aluminum shades
- Non-Slip vinyl grip clamp
- Heat resistant sockets rated 150 watt or 300 watt for brooders

SPECIFICATIONS

CLAMP LIGHTS

PART#	STOCK#	GAUGE	WIRE TYPE	DESCRIPTION	LENGTH
151SW	-	18/2	SPT-2	8.5" Reflector	6 ft.
160SW	-	18/2	SPT-2	5.5" Reflector	6 ft.
BROODER LAMPS					
166SW	-	18/2	SJTW	Brooder 10.5" Shade	6 ft.
324SW	-	18/2	SJTW	Porcelain Socket with Grill Protector	6 ft.

LED WORK LIGHTS

L1320SW



LED Work Lights use cutting edge LED technology and offer high quality. These functional, portable designs furnish residential, and commercial customers with cool running safety, energy efficiency, long lasting LED's, and years of maintenance free use.

- 120 Volt corded or rechargeable models available
- Cool to the touch safety
- Durable polymeric or die cast housing with steel H-frame bases
- Comfort grip heavy duty handle
- Non-skid feet on H-frame base
- Weather proof on/off switch

SPECIFICATIONS

LED WORK LIGHTS

PART#	STOCK#	LUMENS	DESCRIPTION	CORD LGTH.
L1320SW	58841501	779	24 High-Intensity LED(SMD) Rechargeable	Battery
L1323SW	-	779	24 High-Intensity LED(SMD) Portable	5 ft.
L1324SW	59185201	1244	40 High-Intensity LED (SMD) Portable	5 ft.
L1322SW	59180501	2 x 779	48 High-Intensity LED (SMD) Twin Head*	5 ft.
L1681SW	-	1940	23 Watt LED (Array) AC Portable	5 ft.
L1682SW	-	2 x 1940	46 Watt LED (Array) AC Twin Head*	5 ft.
L1325SW	-	4800	46 Watt LED (Array) AC Portable	5 ft.
L1326SW	-	2 x 4800	92 Watt LED (Array) AC Twin Head*	5 ft.

*Comes with Tripod

L1681SW



L1325SW



PORTABLE LIGHTS

X-TREME BOX™

1970SW3R02



The X-Treme Box™ is a portable, rugged modular power distribution system for all jobsite conditions. Connect the MINI X-Treme Box for smaller jobs.

- X-Treme Box™ features NEMA 3R rating and spring-loaded covers on all inlets and outlets
- Powder-coated, heavy gauge carbon-steel enclosure and reinforced sled base for superior durability
- Each 20 AMP outlet provided with a dedicated GFCI module with open neutral protection
- MINI X-Treme Box offers 2 circuits, each with 2 duplex 5-20 t-slot receptacles, GFCI module and 20A premium circuit breaker

SPECIFICATIONS

1980SW0102



X-TREME BOX™

PART#	MODEL TYPE	POWER INLET	30A OUTLETS	20A OUTLETS
1960SW3R02	Standard	50 AMP 125/250V California-Style Twist Lock	30 AMP 250V NEMA L6-30 Twist Lock	NEMA L5-20
1962SW3R02	Roll Cage			NEMA L14-30
1970SW3R02	Standard			
1972SW3R02	Roll Cage			
1971SW3R02	Standard			
MINI X-TREME BOX™		20A OUTLETS		
1980SW0102	NEMA Type 1	30A NEMA L14-30 Inlet	4 x NEMA 5-20 T-Slot Duplex	

POWER DISTRIBUTION EXTENSION CORDS

1920SW0008



Temporary power cords designed for use with X-Treme Box™ family of products.

- Heavy duty SEOW or STW cord
- Generator cords or splitter for MINI X-Treme Box or other appliances

DISTRIBUTION CORDS

PART#	WIRE GA/COND	PLUG CONNECTOR	COLOR	LENGTH
CALIFORNIA-STYLE TWIST LOCK ENDS				
1937SW0008	6/3 - 8/1 SEOW	50 AMP 125/250V California-Style Twist Lock	Black	25 ft.
1918SW0008			Black	50 ft.
1918SW0008			Black	100 ft.
1920SW0008	6/4 SE00W		Black	3 ft.
PREMIUM HUBBELL CALIFORNIA TWIST LOCK ENDS				
1938SW0008	6/3 - 8/1 SEOW	50 AMP 125/250V California-Style Twist Lock	Black	50 ft.
1938SW0008			Black	100 ft.
GENERATOR CORDS				
1493	10-3 STW	L14-30 P/R	Yellow	25 ft.
1934SW8802	10/4 - 10/3 STW	NEMA L14 30P 2X NEMA 5-20R	Black	3 ft.

RETRACTABLE ELECTRICAL POWER CORD REELS

R112318845



Southwire's heavy-duty, industrial-grade, spring retractable electrical and power cord reels are ideal for putting light and power where needed, with quick retraction and convenient storage. They are suitable for many industrial and commercial applications where portable electrical power and handheld lighting is required. These versatile cord reels help make cord handling safer and more efficient while extending the life of the cord and improving the work place.

- All steel construction is rugged and durable, providing structural strength
- Long-life drive spring is enclosed for protection against the environment
- A baked-on powder coated finish on steel components provides maximum corrosion resistance
- Adjustable guide arm allows reel to mount on ceiling, wall, bench or floor
- Latching system allows cord length to be maintained outside of reel
- Supplied with premium electrical cord and pre-installed accessories
- Frame is stamped with stiffening ribs and forms then robotically welded
- Stamped steel cable spool has angled edges to protect cord
- Highest quality spring steel drive spring has several free coils in the center; forming a smooth radius that engages the spring arbor for maximum performance and life
- Premium quality, highly flexible, long-life electrical cord is ideally suited for use on a reel

48208802SW



SPECIFICATIONS

RETRACTABLE CORD REELS

PART#	WIRE GA/COND	WIRE TYPE	HOUSING	AMP	CORD SIZE
HEAVY DUTY					
R112318845	12/3	SJEOW	Metal	20A	45 ft.
R112718845	12/3	SJEOW	Metal	20A	45 ft.
MEDIUM DUTY					
48006SW	14/3	SJTW	Metal	13A	30 ft.
48208802SW	12/3	SJEOW	Plastic	13A	50 ft.
SELF-WINDING CORD REELS					
E235	14/3	SJTW	Plastic	15A	50 ft.
E238	12/3	SJTW	Plastic	15A	50 ft.

48006SW



E235



GFCI BOXES

2816SW8802



High impact resin with a slant-roof design to prevent water entry. Receptacles can accommodate large plugs.

- Economical, safe, jobsite power distribution
- Contact factory for available plug outlet and cord connections

SPECIFICATIONS

OUTLET BOXES

PART#	STOCK#	WIRE GA/COND	WIRE TYPE	DESCRIPTION	AMP	LENGTH
DUPLEX BOX						
2822SW8802	58844601	12/3	SJTW	with test reset button	15A	6 ft.
QUAD BOX						
2816SW8802	-	12/3	SJTW	with test reset button and handle	15A	6 ft.
RIGHT ANGLE QUAD BOX						
14880003-3	-	12/3	SJTW	right angle GFCI with circuit breakers	15A	6 ft.

2822SW8802



14880003-3



RIGHT ANGLE GFCI CORD SETS

14650013-6



Right angle models offer a variety of receptacles and cord lengths that are perfect where space is a premium. All models are manual reset GFCIs, and feature 15 Amp capacity relays.

- For use on construction sites and with industrial appliances
- Rainproof rated, UL listed for outdoor use
- Custom cable gauges, lengths and terminations available by special order, contact factory for details

SPECIFICATIONS

USER ATTACHABLES AND ADAPTERS

PART#	GAUGE	DESCRIPTION	AMP
COMMERCIAL-DUTY JACKET			
14880002-6	18-12	Right Angle Manual Reset	15A
14650013-6	-	GFCI Outlet Adapter	15A

RIGHT ANGLE CORD SETS

PART#	GAUGE	WIRE TYPE	DESCRIPTION	AMP	LENGTH
COMMERCIAL-DUTY JACKET					
14880023-6	12/3	SJTW	Tri-Source NEMA 5-15	15A	2 ft.
14880226-6*	12/3	SJTW	Tri-Source NEMA 5-15	15A	2 ft.
14880118-2	12/3	SJTW	Tri-Source NEMA 5-15	15A	25 ft.
14880119-1	12/3	SJTW	Tri-Source NEMA 5-15	15A	50 ft.
14880120-1	12/3	SJTW	Tri-Source NEMA 5-15	15A	100 ft.
HEAVY-DUTY OIL RESISTANT JACKET					
14880228-6	12/3	SJEOW	Tri-Source NEMA 5-15	15A	25 ft.
14880229-6	12/3	SJEOW	Tri-Source NEMA 5-15	15A	50 ft.
14880230-4	12/3	SJEOW	Tri-Source NEMA 5-15	15A	100 ft.

*Lighted End

14880002-6



14880023-6



INLINE GFCI CORD SETS

26020008-6



Excellent for industrial plant maintenance, equipment service, and construction site applications. Provides compliance with the National Electrical Code (NEC 2014) Article 590.6 for “Temporary Installations.” All inline models constructed with 20 AMP relays.

- For use on construction Sites and with industrial appliances
- Rainproof rated GFCI, UL listed for outdoor use.
- Custom cable gauges, lengths and terminations available by special order.
- Manual reset to prevent un-monitored equipment startup.
- Reset is required after GFCI trip or a power outage
- Add user-attachables to any cordset or tool to drive safety and code-compliance

SPECIFICATIONS

INLINE GFCI CORD SETS

PART#	GAUGE	WIRE TYPE	DESCRIPTION	AMP	LENGTH
26020002-6	14/3	SJTW	NEMA 5-15 P&R	15A	2 ft.
26020050-1	14/3	SJTW	NEMA 5-15 P&R	15A	50 ft.
26020124-2	14/3	SJTW	NEMA 5-15 P&R	15A	25 ft.
25080025-2	12/3	SJTW	NEMA 5-20 P&R	20A	25 ft.
26020011-6	12/3	SJTW	NEMA 5-15 P&R	15A	2 ft.
26020150-1	12/3	SJTW	NEMA 5-15 P&R	15A	50 ft.
26000011-6	12/3	SJTW	NEMA 6-20 P&R	20A/240V	2 ft.
44720013-2	10/3	SJTW	NEMA L6-30 P&R	240V/30A	6 ft.
44720065-4	10/3	SJTW	NEMA L6-30 P&R	240V/30A	15 ft.
TRI-SOURCE					
26020008-6	12/3	SJTW	NEMA 5-15P	15A	2 ft.
26020148-1	12/3	SJTW	NEMA 5-15P	15A	50 ft.
30040008-6	12/3	SEOW	NEMA 5-15P	15A	2.5 ft.

26020148-1



USER ATTACHABLES

PART#	GAUGE	DESCRIPTION	RELAY CAP.
25000016-6	18-12	120/240V	20A
30040006-6	16-12	High Capacity	20A

BATTERY BOOSTER CABLES

08860



Southwire has manufactured booster cables for several decades leading the marketplace with product innovations that include: No-Tangle™ cable twin extrusion, TPE insulation, no-shock clamp, UL listings, and copper-clad aluminum cable.

Some models feature Southwire's patented Polar-Glo™ clamp with triple-polarity identification: color-coding, indent stamping, and glow-in-the-dark labels. This clamp attaches firmly to both top post and side terminal batteries. All energized clamp surfaces are shielded to avoid short circuits and conductive clamp surfaces are recessed to prevent accidental contact.

- Jacket material exhibits rubber-like flexibility, high abrasion resistance, a -40° to 60° C temperature range, lighter in weight than other PVC, high resistance to almost all environmental exposures

SPECIFICATIONS

BOOSTER CABLES

PART#	STOCK#	GAUGE	DESCRIPTION	LENGTH
084678802	-	8	Booster Cable CCA	12 ft.
086660104	-	4	Booster Cable CCA Polar Glow Clamp	16 ft.
087600108	-	4	Booster Cable CCA Parrot Clamp	20 ft.
086600104	-	4	Booster Cable CCA Polar Glow Clamp	20 ft.
088600108	-	2	Booster Cable CCA Parrot Clamp	20 ft.
088620108	-	2	Booster Cable CCA Parrot Clamp	25 ft.

WARRANTIES

WHAT DOES THIS WARRANTY COVER?

FIVE-YEAR LIMITED WARRANTY ON CONTRACTOR EQUIPMENT

Under Southwire's Contractor Equipment 5-Year Limited Warranty, Southwire Company, LLC warrants that all Southwire Contractor Equipment will be free from manufacturer defects for a period of five (5) years from the date of the original end user's purchase. However, electrical components and consumable parts such as ropes, blades, dies, draw studs, grips, are excluded from this 5-Year Limited Warranty and are subject to the One -Year warranty terms. Under this 5-Year Limited Warranty, the following are also excluded and Southwire Company, LLC will have no liability for any of the following: normal wear and tear resulting from product use and damage arising out of misuse, abuse, modification, and improper product maintenance. This warranty also does not cover Southwire Contractor Equipment products that have been modified by any party other than Southwire Company, LLC or its authorized third party designee. This 5-Year Limited Warranty is not transferrable to or enforceable by any person other than the product's original end user.

THREE-YEAR LIMITED WARRANTY ON MATERIAL BOXES

Under Southwire's Material Boxes 3 -Year Limited Warranty, Southwire Company, LLC warrants that all Southwire Material Boxes will be free from manufacturer defects for a period of three (3) years from the date of the original end user's purchase. Under this Three-Year Limited Warranty for Material Boxes, the following are excluded and Southwire Company, LLC will have no liability for any of the following: normal wear and tear resulting from product use and damage arising out of misuse, abuse, modification, and improper product maintenance. This warranty also does not cover Material Boxes that have been modified by any party other than Southwire Company, LLC or its authorized third party designee. This 3-Year Limited Warranty is not transferrable to or enforceable by any person other than the product's original end user.

ONE-YEAR LIMITED WARRANTY ON ELECTRICAL COMPONENTS AND CONSUMABLE PARTS (WITH 5-YEAR WARRANTY)

Under Southwire's 1-Year Limited Warranty, Southwire Company, LLC warrants that all electrical components and consumable parts such as ropes, blades, dies, draw studs, grips will be free from manufacturer defects for a period of one-year from the date of the original end user's purchase. Under this 1-Year Limited Warranty, Southwire Company, LLC will have no liability for any of the following: normal wear and tear resulting from product use and damage arising out of misuse, abuse, modification, and improper product maintenance. This warranty also does not cover Southwire electrical components and consumable parts that have been modified by any party other than Southwire Company, LLC or its authorized third party designee. This 1-Year Limited Warranty is not transferrable to or enforceable by any person other than the product's original end user.

ONE-YEAR LIMITED WARRANTY (STAND ALONE)

Under Southwire's 1-Year Limited Warranty, Southwire Company, LLC warrants that this product will be free from manufacturer defects for a period of one-year from the date of the original end user's purchase. Under this 1-Year Limited Warranty, Southwire Company, LLC will have no liability for any of the following: normal wear and tear resulting from product use and damage arising out of misuse, abuse, modification, and improper product maintenance. This warranty also does not cover Southwire products that have been modified by any party other than Southwire Company, LLC or its authorized third party designee. This 1-Year Limited Warranty is not transferrable to or enforceable by any person other than the product's original end user.

Exclusion of Incidental, Consequential, Indirect, Special and Punitive Damages

SOUTHWIRE MAKES NO WARRANTY THAT SOUTHWIRE CONTRACTOR EQUIPMENT PRODUCTS WILL BE MERCHANTABILITY OR FIT FOR ANY PARTICULAR PURPOSE. SOUTHWIRE MAKES NO OTHER WARRANTY, EXPRESSED OR IMPLIED, OTHER THAN THE RELEVANT WARRANTY SPECIFICALLY SET FORTH IN THIS WARRANTY SECTION. SOUTHWIRE WILL NOT BE LIABLE FOR ANY INCIDENTAL, CONSEQUENTIAL, INDIRECT, SPECIAL, OR PUNITIVE DAMAGES FOR ANY BREACH OF THIS LIMITED LIFETIME WARRANTY.

Some states do not allow the exclusion or limitation of incidental or consequential damages, so the above limitation or exclusion may not apply to you.

LIMITED WARRANTY AND LIMITATION OF LIABILITY ON SOUTHWIRE METERS & TESTERS

Southwire Company, LLC warrants this product to be free from defects in material and workmanship for five years from the date of purchase. This warranty does not cover fuses, disposable batteries, or damage arising from an accident, neglect, misapplication, contamination, modification, improper maintenance or repair, operation outside of specifications, or abnormal handling of the product. Southwire's sole liability, and the purchaser's exclusive remedy, for any breach of this warranty is expressly limited to Southwire's repair or replacement of the product. Whether Southwire repairs or replaces the product will be a determination that Southwire makes at its sole discretion. **SOUTHWIRE MAKES NO WARRANTY THAT THE PRODUCT WILL BE MERCHANTABILITY OR FIT FOR ANY PARTICULAR PURPOSE. SOUTHWIRE MAKES NO OTHER WARRANTY, EXPRESSED OR IMPLIED, OTHER THAN THE WARRANTY SPECIFICALLY SET FORTH HEREIN. SOUTHWIRE WILL NOT BE LIABLE FOR ANY INCIDENTAL, CONSEQUENTIAL, INDIRECT, SPECIAL, OR PUNITIVE DAMAGES FOR ANY BREACH OF THIS WARRANTY.**

This warranty is void if this product is used for rental purposes. No product reseller is authorized to extend any other warranty on Southwire's behalf relating to this product, and no such reseller warranty will be binding on Southwire. If you have a warranty claim, or if the product needs to be serviced during or after the warranty period set forth above, please contact the Customer Service Department at 855-SWTOOLS (855-798-6657). The sender is responsible for all shipping, freight, insurance, and packaging costs associated with sending a product to Southwire. Southwire will not be responsible for lost or damaged products returned pursuant to this warranty. All products returned to Southwire under this warranty should be mailed to:

Southwire Tools & Assembled Products Division
Attn: Product Returns
840 Old Bremen Road
Carrollton, GA 30117
Phone Number: 1.855.SW.TOOLS

WARRANTY CLAIM INFORMATION/HOW DO YOU GET SERVICE?

For all warranty, customer service, and product return authorizations and inquiries, please contact Southwire's Tools & Assembled Products at:

Southwire Tools & Assembled Products
Attention Product Returns
840 Old Bremen Road
Carrollton, GA, 30117
Phone Number: 1.855.SW.TOOLS

1. All warranty claims must be approved by Southwire's Tools & Assembled Products Warranty Department prior to return of product. If Southwire determines that a product is defective, Southwire will, at its option, repair or replace defective products or defective product components, free of charge.
2. Upon approval, Southwire will issue a Product Return Authorization Form which will include instructions on how and where to return the product. The product serial number and the original date of delivery must be set forth on the Product Return Authorization Form.
3. Southwire will cover standard freight charges (Courier Ground rate) incurred in connection with products that Southwire ultimately determines to be defective.
4. All defective components and defective products that Southwire replaces under these Warranties will become Southwire's property and will be retained by Southwire.

REPAIR YOUR PRODUCT WHEN IT IS OUT OF WARRANTY

Southwire is happy to provide information about where a purchaser can send a product for repair at consumers' own expense, please contact 1.855.SW.TOOLS or visit www.southwiretools.com/tools/home.do for more information about servicing for Southwire Products.

Contractor Equipment | 05.12.2015 | R1

WARRANTY ON SOUTHWIRE ELECTRICIAN'S NON-ELECTRONIC HAND TOOLS

Southwire Company, LLC warrants this product to be free from defects in materials and workmanship for the life of the product. This warranty does not cover normal wear and tear resulting from product use, nor does it cover damage arising out of misuse, abuse, modification, and/or improper maintenance of the product. If the product breaches this warranty, Southwire will replace the product free of charge. If Southwire no longer manufactures the product, then it will, at its option, replace the nonconforming product with a substantially similar Southwire product or refund the purchase price. SOUTHWIRE MAKES NO WARRANTY THAT THE PRODUCT WILL BE MERCHANTABLE OR FIT FOR ANY PARTICULAR PURPOSE. SOUTHWIRE MAKES NO OTHER WARRANTY, EXPRESSED OR IMPLIED, OTHER THAN THE WARRANTY SPECIFICALLY SET FORTH HEREIN. SOUTHWIRE WILL NOT BE LIABLE FOR ANY INCIDENTAL, CONSEQUENTIAL, INDIRECT, SPECIAL, OR PUNITIVE DAMAGES FOR ANY BREACH OF THIS WARRANTY.

This warranty is void if this product is used for rental purposes. No product reseller is authorized to extend any other warranty on Southwire's behalf relating to this product, and no such reseller warranty will be binding on Southwire. If the product needs to be serviced, please contact the Customer Service Department at 855-SW.TOOLS (855-798-6657) to obtain a return authorization from Southwire. The sender is responsible for all shipping, freight, insurance, and packaging costs associated with sending a product to Southwire. Southwire will not be responsible for lost or damaged products returned for service or returned under this warranty. All products returned to Southwire under this warranty should be mailed to:

Southwire Tools & Assembled Products Division
840 Old Bremen Road
Carrollton, GA 30117
Phone Number: 1.855.SW.TOOLS

INDEX

#

101-106	153	1629SW0008.....	231	2307SW8803.....	233
101-107	153	1637SW0061.....	231	2308SW8803.....	233
101-110	152	1638SW0061.....	231	2309SW8803.....	233
151SW.....	244	1639SW0061.....	231	2367SW8806.....	233
160SW.....	244	1687SW0002.....	231	2368SW8806.....	233
166SW.....	244	1688SW0002.....	231	2407SW8804.....	233
324SW.....	244	1689SW0002.....	231	2408SW8804.....	233
0691SW.....	241	1767SW0002.....	232	2409SW8804.....	233
0692SW.....	241	1768SW0002.....	232	2457SW0003.....	233
1287SW0002.....	231	1769SW0002.....	231	2458SW0003.....	233
1288SW0002.....	231	1787SW0002.....	231	2459SW0003.....	233
1289SW0002.....	231	1788SW0002.....	231	2467SW8806.....	236
1427SW0008.....	231	1789SW0002.....	231	2468SW8806.....	236
1428SW0008.....	231	1918SW0008.....	246	2469SW8806.....	236
1429SW0008.....	231	1920SW0008.....	246	2487SW8804.....	233
1437SW.....	240	1934SW8802.....	246	2488SW8804.....	233
1437SW0061.....	231	1937SW0008.....	246	2489SW8804.....	233
1438SW0061.....	231	1938SW0008.....	246	2548SW00XX.....	235
1439SW0061.....	231	1960SW3R02.....	246	2548SWUSA1.....	235
1487SW0002.....	231	1962SW3R02.....	246	2549SW00XX.....	235
1488SW0002.....	231	1970SW3R02.....	246	2549SWUSA1.....	235
1489SW0002.....	231	1971SW3R02.....	246	2557SW0003.....	233
1493	246	1972SW3R02.....	246	2558SW0003.....	233
1567SW0002.....	232	1980SW0102.....	246	2559SW0003.....	233
1568SW0002.....	232	2211SW8808.....	233	2568SW0006.....	236
1569SW0002.....	232	2304SW8803.....	233	2569SW0006.....	236
1628SW0008.....	231	2305SW8803.....	233	2577SW00XX.....	235
		2306SW8808.....	233	2578SW00XX.....	235

2579SW00XX	235	3689SW0002.....	232	9021SW8802.....	236
2587SW8802.....	233	3953	238	9028SW8802.....	234
2588SW0002.....	233	4004SW8803.....	234	9029SW8802.....	234
2589SW0002.....	233	4112SW8802.....	234	9044SW8808.....	237
2618SW8802.....	233	4187SW8802.....	234	9046SW8808.....	237
2648SW00XX	235	4188SW8802.....	234	9124SW8809.....	237
2687SW8802.....	233	4189SW8802.....	234	9126SW8809.....	237
2688SW8802.....	233	4217SW8804.....	234	9154SW8808.....	237
2689SW8802.....	233	4218SW8804.....	234	9156SW8808.....	237
2816SW8802.....	248	4219SW8804.....	234	9208SW8802.....	234
2822SW8802.....	248	4388SW8802.....	234	9209SW8802.....	234
3482SW0002.....	232	4389SW8802.....	234	9527SW0008.....	236
3487SW0002.....	232	6503SW0008.....	237	9536SW0008.....	236
3488SW0002.....	232	7145SW	242	9552SW9008.....	236
3489SW0002.....	232	7155SW	242	9561SW0008.....	236
3531SW3323.....	238	7164SW	242	9702SW8808.....	238
3532SW3323.....	238	7165SW	242	9703SW8808.....	238
3533SW3323.....	238	7538SW	242	9706SW8808.....	238
3535SW3323.....	238	7539SW	242	9709SW8808.....	238
3536SW3323.....	238	7548SW	242	9716SW8808.....	238
3537SW8809.....	238	7549SW	242	9719SW8808.....	238
3588SW0002.....	232	7605SW	244	9723SW8809.....	238
3589SW0002.....	232	9011SW0008.....	237	9724SW8809.....	238
3677SW0008.....	232	9012SW0008.....	237	9726SW8809.....	238
3678SW0008.....	232	9014SW8809.....	237	9733SW8809.....	238
3679SW0008.....	232	9016SW8809.....	237	9734SW8809.....	238
3687SW0002.....	232	9019SW8802.....	236	9736SW8809.....	238
3688SW0002.....	232	9020SW8802.....	236	9743SW8823.....	238

INDEX

9746SW8823.....	238	23070T.....	66	14880118-2	249
9846SW0008.....	237	23090T.....	65	14880119-1	249
9853SW0008.....	237	30010S.....	86	14880120-1	249
9854SW0008.....	237	30020S.....	85	14880226-6*.....	249
9855SW0008.....	237	31030S.....	84	14880228-6	249
9856SW0008.....	237	31040S.....	83	14880229-6	249
9857SW0008.....	237	40010S-A	80	14880230-4	249
9858SW0008.....	237	40020S-A	79	25000016-6	250
9906SW8803.....	236	40040S.....	81	25080025-2	250
9906SW8808.....	236	40116N	78	26000011-6	250
10030S.....	64	40126N	77	26020002-6	250
10036K	90	40136N	76	26020008-6	250
10040N	63	40140S.....	82	26020011-6	250
13050S.....	59	40150N	75	26020050-1	250
13070T.....	58	41150S.....	74	26020124-2	250
13090T.....	57	41160S.....	73	26020148-1	250
14060S.....	56	41170S.....	72	26020150-1	250
14070T.....	55	41210S.....	88	30040006-6	250
14090T.....	54	48006SW.....	247	30040008-6	250
15190T.....	53	51010S.....	87	44720013-2	250
16020N	62	60010S.....	89	44720065-4	250
16030A.....	61	60020S.....	89	48208802SW.....	247
16040T.....	60	60030S.....	89	53378802SW.....	241
21010N	71	997362.....	236	56578802SW.....	241
21030T.....	70	14650013-6	249	56588802SW.....	241
21050T.....	69	14880002-6	249	58578802SW.....	241
22070T.....	68	14880003-3	248	58588802SW.....	241
23030T.....	67	14880023-6	249	084678802.....	251

086600104.....	251	BAGMSGR	38	CCP9D-US.....	11
086660104.....	251	BD-01	165	CCP350.....	157
087600108.....	251	BD750E	165	CCP750.....	156
088600108.....	251	BD1000E	165	CCPR1K	155
088620108.....	251	BD1000R	165	CCPR400	155
A		BD1250E	165	CCPR400S	156
A-201	151	BEKIT-3	45	CCSX-C1.....	94
A-271	151	BMHS4-3/8	182	CDTBKIT	187
ABS1/2	182	BMHS5--3/8	182	CGS01	120
ABS3/8	182	BMHS6-3/8	182	CHC1-1/8	188
ACLHS	182	BMHSKIT9	182	CHC1-3/8	188
AWL001	24	BML2000.....	163	CHCKIT4	188
B		BN01	18	CJ01	195
B-102	148	BSCC01	164	CJ02	195
B-107	148	C		CK01	197
B-108	149	CB12-350	170	CLPT02GR	43
B-202	149	CB14-500	170	CLPT03.....	43
B-228	150	CB602460	214	CLPT03GR	43
B-272	150	CB603065	214	CLPT04.....	43
B600	110	CC191932.....	217	CLPT04GR	43
B610C	110	CC482423.....	217	CLPT02.....	43
BAG0T15	37	CCF-C1.....	102	CM01	204
BAG4P	41	CCM-C1.....	102	CM02	204
BAG12	41	CCP6	8	CM03	205
BAGBP	39	CCP6D	8	CMD-HQ.....	213
BAGESP	37	CCP9	8	CONCUT.....	16
		CCP9	8	CPT-CF1	97
		CCP9DE	8	CRT	15

INDEX

CSK5	45	E238	247	FTS1/8-125.....	133
CSPH1HD.....	129	EKIT-4.....	44	FTS1/8-240.....	133
CT0850015.....	42	ES001.....	17	FTSP3.0FML-LRKIT	134
CT0850100.....	42	ESP-1	92	FTSP3-100FML	131
CT0850100R	43	ESP-KIT	93	FTSP3-100NCT.....	130
CT0890100.....	42	ESS-1	92	FTSP4.5FML-LRKIT	134
CT1150015.....	42	ETAPE.....	36	FTSP45-75FML	131
CT1150100.....	42	F		FTSP45-75NCT.....	130
CT1150100R	43	FAB1x54	183	FTSP45-125FML	131
CT1190100.....	42	FAB3/4X54	183	FTSP45-125NCT.....	130
CT1450015.....	42	FAB3/8X54	183	FTSP45-240FMLT	132
CT1450100.....	42	FAB9/16X54.....	183	G	
CT1450100R	43	FABK9/16X54.....	183	GLOVE1L.....	40
CT1490100.....	42	FAE3/16X54	183	GP00AA	125
CT8111412.....	42	FDWSAW	16	GP101A	125
D		FLITE1	46	GP102B	125
D1	103	FO604482.....	216	GP103C	125
DCP6D	7	FQCE36.....	184	GP104D	125
DCP8	7	FQCKIT	184	GP110	125
DCP8D	7	FS8	135	H	
DCPA8.....	7	FS12	135	HCT-C1.....	104
DCPA8D	7	FS15	135	HEX-5	34
DCPA8D-US.....	11	FTFL13	134	HEX-8	34
DESAW.....	16	FTS1/4-25.....	133	HM-01	206
E		FTS1/8-25.....	133	HSAW	15
E235	247	FTS1/8-50.....	133	I	
		FTS1/8-65.....	133		

IG-06	128	L1240SW	240	M400TP	106
IG-12	128	L1320SW	245	M500CX4	109
IG-18	128	L1322SW	245	M550	107
IG-24	128	L1323SW	245	M555TP	108
IG-30	128	L1324SW	245	MB750.....	164
IG-KIT	128	L1325SW	245	MB1000.....	164
J					
JR-128.....	147	L1326SW	245	MB1250.....	164
K					
KIT-C1.....	104	L1407SW	240	MBCCH-750	164
KIT-TP1.....	101	L1681SW	245	MBCCH-1000	164
KM30	211	L1682SW	245	MBCCH-1250	164
KM45	211	L1925SW	240	MCB1	169
KM60	210	LNP6	6	MCB1/2.....	169
KODRAW1/2	181	LNP6D	6	MCB3/4.....	169
KODRAW3/4	181	LNP6DC-1	101	MCBLADE.....	143
KOKIT6.....	181	LNP7	6	MCBLEVEL	35
L					
L10SLED SW	239	LNP7D	6	MCCUT.....	143
L13SW	239	LNP8S	6	MCF01	118
L14SLED SW	239	LNP8SD	6	MJ707	194
L20SW	239	LS-105.....	152	MM01	180
L33SW	239	LVFS01	119	MP02PRO	178
L41HDSW	239	LVLTOR9	35	MP-03PRO	173
L113SW	239	M			
L845SW	239	M3K	117	MP03PRO	178
		M3K-M.....	117	MP61	14
		M6K	116	MP360HP	174
		M6K-M.....	116	MP360SDPRO	174
		M300P.....	105	MPC50PRO	178
				MPC75PRO	178
				MPC100PRO	178

INDEX

MPC125PRO 178
MPC150PRO 178
MPC200PRO 178
MPC250PRO 178
MPC300PRO 178
MPC350PRO 178
MPC400PRO 178
MPDS12..... 181
MPHSP 175
MPJ01 192
MPJ02 192
MPK075PRO 178
MPK0100PRO 178
MPK0125PRO 178
MPK0150PRO 178
MPK0200PRO 178
MPK0250PRO 178
MPK0300PRO 178
MPK0350PRO 178
MPK0400PRO 178
MPK050PRO 178
MPLN 14
MPOPN78 179
MPOPN1732 179
MPR-01SD 177
MPSCP 10
MPXD 173
MPXD-SD..... 173

MSP01 176

N

ND1/2-3 30
ND1/2-3M 31
ND1/2-6 30
ND1/2-6M 31
ND1/4-1-1/2M 31
ND1/4-3 30
ND1/4-3M 31
ND1/4-6 30
ND3/8-1-1/2M 31
ND3/8-3 30
ND3/8-3M 31
ND3/8-6 30
ND3/8-6M 31
ND3/16-3M 31
ND3/16-6M 31
ND4.5-3 30
ND5/16-3 30
ND5/16-3M 31
ND5/16-6 30
ND7-3 30
ND7/16-3 30
ND7/16-6 30
ND7/16-6M 31
ND8-3 30

ND9/16-4 30
ND9/16-6 30
ND11/32-3M 31
ND11/32-6 30
ND11/32-6M 31
NDSET2-1-1/2 33
NDSET2-6M 33
NDSET7 32

P

P3T01..... 121
P6T02..... 121
P-583 123
P-586 123
P700 109
P-786 123
P-789 123
P-963 123
P-966 123
P-7812 123
PB2000 163
PB483048 215
PB603034 216
PB603049 215
PC100..... 116 117
PDTC-1 98
PDTP-K1 98
PJA-01 196

PJA-02.....	196	RF-120A.....	143	SCP9.....	5
PJS-01.....	196	RF-170.....	144	SCP9C.....	5
PL500.....	123	RJCC-T1.....	99	SCP9CD.....	5
PL6500.....	123	RJCR-T1.....	99	SCP9D.....	5
PLACUT.....	17	RS-101.....	141	SCP9TPC.....	5
PM06.....	203	RS-101A.....	141	SCP9TPCD-US.....	11
PM10.....	203	RS-101AC.....	142	SCR6-BG.....	158
POUCH4.....	39	S		SCR6-C.....	160
PP6.....	9	S5N1.....	10	SCR6-O.....	158
PP10.....	9	S612STR.....	12	SCR6-SN.....	158
PRDS34.....	181	S1018SOL.....	12	SCU6-AL.....	154
PRDS118.....	181	S1018SOL-US.....	13	SCU6-S.....	154
PRDS716.....	181	S1018STR.....	12	SD1/4C4.....	20
PVCB-04.....	167	S1020SOL-US.....	13	SD1/4C6.....	20
PVCB-06.....	166	S1626STR.....	12	SD1/4K1-1/2.....	19
PVCB-06M.....	166	SA-200L.....	146	SD1/4K4HD.....	19
PVCP-01.....	168	SA-200S.....	145	SD1P3.....	22
PVCP-02.....	168	SA-200SK.....	145	SD2P1-1/2.....	22
Q		SA822.....	13	SD2P4HD.....	22
QJ-01.....	193	SAB1X18.....	185	SD2P6HD.....	22
R		SAB3/4x18.....	185	SD2P7.....	22
R112318845.....	247	SAB7/8X18.....	185	SD2P10.....	22
R112718845.....	247	SA-C1.....	96	SD3/16C3.....	20
RB1000.....	164	SB1/4-1-3/8.....	187	SD3/16C4.....	20
RBCCH-1000.....	164	SB3/16-7/8.....	187	SD3/16C6.....	20
RCT-D1.....	100 103	SBT01.....	198	SD3/16C8.....	20
		SBT02.....	198	SD3/16C10.....	20
				SD3/16CRD.....	21

INDEX

SD5/16K6HD.....	19	SDU-A1	161	SDW-237.....	159
SD5N1LITE	27	SDU-A2.....	161	SDW-239.....	159
SD9N1	27	SDU-A4.....	161	SDW-243.....	159
SD12N1	28	SDU-A6.....	161	SDW-247.....	159
SD15T4.....	25	SDU-A8.....	161	SDW-249.....	159
SD20T4.....	25	SDU-A250.....	161	SDW-BG	159
SD25T4.....	25	SDU-A300.....	161	SDW-C.....	159
SD27T4.....	25	SDU-A350.....	161	SDW-K840	159
SDC2P	21	SDU-C1	161	SDW-O	159
SDCFR	25	SDU-C2.....	161	SDWS	27
SDI1/4K4	20	SDU-C4	161	SDW-TREE.....	159
SDI2P4	22	SDU-C6.....	161	SF-01	191
SDQ2P1-1/2	24	SDU-C8.....	161	SFB01.....	135
SDQ2P4	24	SDU-C250.....	161	SIMPullTM Head	126
SDR9N1.....	28	SDU-C300.....	161	SK-T1	95
SDREV-1	29	SDU-C350.....	161	SM-01.....	205
SDS6N1	29	SDU-C400.....	161	SM30	208
SDSET2-3	26	SDU-C500.....	161	SM60	207
SDSET4MINI	26	SDU-C600.....	161	SNM1012	14
SDSET8.....	26	SDU-KITA	161	SNM1214	14
SDSH1/4	23	SDU-KITC.....	161	SPH	126
SDSH2P6.....	23	SDU-OA4.....	161	SPR143	122
SDU-OA1	161	SDU-OC4.....	161	SPR146	122
SDU-OA2.....	161	SDW-161.....	159	SPR183	122
SDU-OA3.....	161	SDW-162.....	159	SPR963	122
SDU-OC1	161	SDW-163.....	159	SPR966	122
SDU-OC2.....	161	SDW-164.....	159	SPR969	122
SDU-OC3.....	161	SDW-165.....	159	SPR9612	122
		SDW-166.....	159		

SS01	36
ST-C1	95
STJ6-ACSR.....	154
STJ6-BG.....	159
STJ6-CU.....	160
STJ6-CUAL.....	154
STJ6-K.....	159
STJ6-O.....	159
STJ6-SN.....	159
STJB-CUAL.....	154
Sumner	218 219
SVN	14
SWCMT160-3000S	124
SWMT400-4500P.....	124
SWMT1250-3000S	124
SWMT1800-3000S	124
SWMT2500-3000S	124
T	
T100PK.....	111
T200K.....	112
T50078.....	243
T50079.....	243
TCC9	9
TCC9D.....	9
TCC9D-US	11
THEX6-1/2.....	34
THEX6-3/8.....	34

TM30B.....	210
TM45B.....	209
TM60B.....	209
TSS01.....	119
U	
UC100	197
V	
VT-270	147
W	
WAB1X4-1/2.....	186
WAB3/4X4-1/2	186
WAB7/8X4-1/2	186
WB2008.....	212
WB2812.....	212
WB3617.....	212
WG01	136
WPG1/2.....	127
WPG3/4.....	127
WW510	199
WW520	199
WW530	200
WW535	200
WW538	201
WW550	201
WW560	202

X

X-C1	94
XD10	115
XD10BD	115
XS-C1	96
XSR-T1.....	95
XTC100.....	140
XTS-01.....	139
XTS01RB.....	139
XTS02.....	140
XTS02RB.....	140



Southwire™

TOOLS & EQUIPMENT

2018 JOBSITE SOLUTIONS CATALOG

GET SOCIAL WITH US:



**/SOUTHWIRETOOLS
/SOUTHWIRETOOLSLATINO**



@SOUTHWIRETOOLS



@SOUTHWIRETOOLS



SOUTHWIRETOOLS

SOUTHWIRETOOLS.COM | 1-855-SWTOOLS

Delrin® is a registered trademark of E. I. du Pont de Nemours and Company of its affiliates for its brand of acetal resin.
Milwaukee, Super Hawg, Hole Hawg are trademarks, service marks, or trade names of Milwaukee Electric Tool Corporation ("Milwaukee Electric Tool Corporation's Intellectual Property").
All other Trademarks or Registered Trademarks (TM/®) are owned or licensed by Southwire Company.
Any other ™/®- Trademark or Registered Trademark of Southwire Company.

