

VIGILANTE® II ALARM ANNUNCIATORS

Vigilante® II

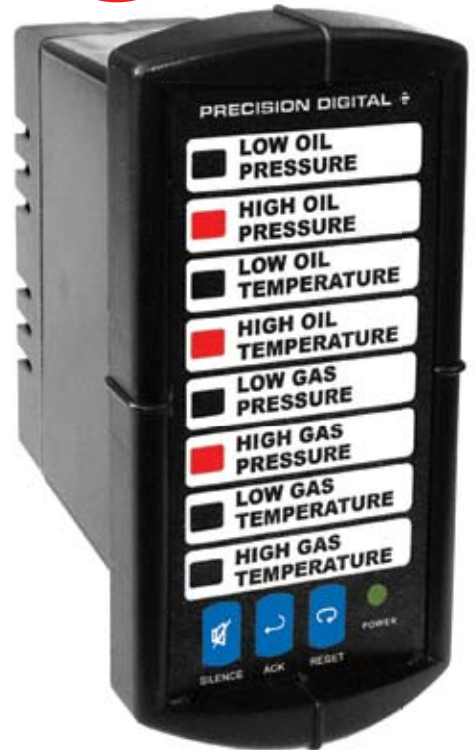

Model PD154 / 4-Point



Model PD158 / 8-Point

- 8 Field Selectable Sequences
- All Common ISA Sequences Including First-Out
- Switch, Transistor, and Logic Level Inputs
- 4 or 8-Point Monitoring
- Free Custom Message Labels
- Type 4X, NEMA 4X, IP65 Front
- Universal Power Supply 85-265 VAC
- 12-36 VDC/12-24 VAC Power Option
- Built-In 85 dB Horn
- 2 SPDT Relays for Alarm Activated Devices
- 24 VDC Isolated Power Supply (AC Models)
- Multiple-Unit First-Out Indication
- Silence, Acknowledge, and Reset Functions
- Sunlight Readable Indication
- Shallow Depth 1/8 DIN Case



APPLICATIONS

Level Monitoring with Level Switches

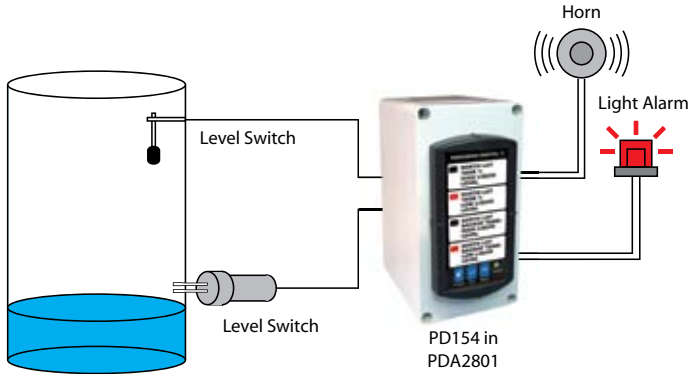

The Vigilante® II is ideal for tank level switch monitoring.

- Up to 8 Individually Labeled Level Switch Inputs
- 24 VDC Level Switch Power Supply
- Relays for External Horns and Light Alarms
- Easy NEMA 4X Mounting Enclosures
- Sunlight Readable Indication

Temp Monitoring with Trident Meters



Connect PD765 Trident alarm relays to the Vigilante® II for temperature alarm monitoring.

- First-Out Indication for Heating/Cooling Systems
- Multiple Unit First-Out Indication
- Remote Silence, Acknowledge, and Reset
- Internal 85 dB Horn
- Fail-Safe Relays for Critical Applications

First-Out Alarm Indication

The Vigilante® II can be programmed for multiple sequences with first-out alarm indication. This feature indicates the first point of failure of a system when multiple alarms occur.

Multiple Unit First-Out Alarm Indication



Multiple Unit First-Out Indication

If multiple Vigilante® II annunciators are connected for multiple unit first-out indication, only one input from all connected devices will display as a first-out alarm.

ALARM SEQUENCES

The Vigilante® II Alarm Annunciator can be programmed for all common ISA sequences including A, F1A, F2A, F3A, M, F1M. Selectable ISA -1 (Silence Button), -4 (No Lock-In), and horn disable options. Two popular sequences are detailed below.

ISA Alarm Sequence A

Acknowledgement and Automatic Reset

Momentary Alarm

Condition	LED	Horn
Normal	Off	Off
Alert	Flash	On
Normal	Flash	On
User Acknowledged		
Acknowledge	Off	Off

Maintained Alarm

Condition	LED	Horn
Normal	Off	Off
Alert	Flash	On
User Acknowledged		
Acknowledge	Steady	Off
Normal	Off	Off

ISA Alarm Sequence F2A

First-Out Alarm Indication with Acknowledgement and Automatic Reset





Momentary Alarm

Condition	LED		Horn
	1 st Pt	Next Pt	
Normal	Off	Off	Off
Alert	Flash	Steady	On
Normal	Flash	Steady	On
User Acknowledged			
Ack	Off	Off	Off

Maintained Alarm

Condition	LED		Horn
	1 st Pt	Next Pt	
Normal	Off	Off	Off
Alert	Flash	Steady	On
User Acknowledged			
Ack	Steady	Steady	Off
Normal	Off	Off	Off

FRONT PANEL

Button			
Description	Silence Horn	Acknowledge Alarm	Reset Inputs
LED	Description		
	Point status indicators		
	Indicates power is on		

LED Test: Press and release the SILENCE and ACK pushbuttons to flash the channel indicator LEDs for an LED function test.

Full Function Test: Press and hold the SILENCE and ACK pushbuttons for 3 seconds to initiate a full function test.

External Connections: All three pushbuttons may be activated remotely via rear terminal connections.

MOUNTING DIMENSIONS

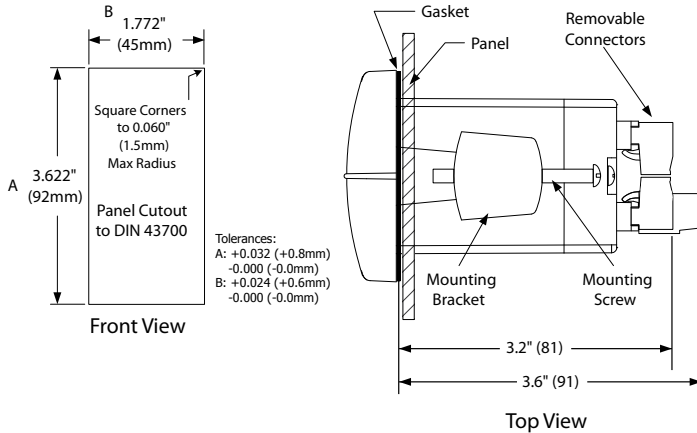

CONNECTIONS

PD158 connections for 85-265 VAC powered model.

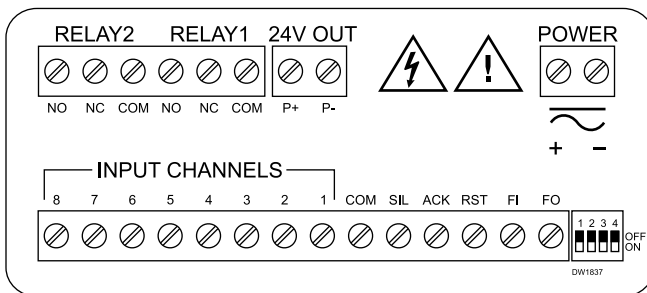

DISCLAIMER: The information in this document is subject to change without notice. Precision Digital Corporation makes no representations or warranties with respect to the contents hereof, and specifically disclaims any implied warranties of merchantability or fitness for a particular purpose.

MESSAGE LABELS

Alarm message labels for the alarm annunciator may be factory printed at no charge, or field printed using a laser printer with clear self-adhesive labels.

Factory printed message labels may be ordered at any time by completing the following form.

_____ Please include label with my order
 _____ I have the Annunciator, please send label

Quantity _____
 Name _____
 Title _____
 Company _____
 Mailing Address _____
 City, St., Zip _____
 Phone _____
 Fax _____
 E-Mail _____
 PO# _____

Area available per message: PD154, 1.25" x 0.60" (32 mm x 15 mm); PD158, 1.25" x 0.25" (32 mm x 6 mm); user may specify any size and length that will fit in this area. Lines of 14 characters max at 9 point type will fit.

PD154	PD158																																										
Message 1	Message 1 & 2																																										
<table border="1" style="width: 100%; height: 50px;"> <tr><td></td><td></td><td></td><td></td><td></td><td></td><td></td><td></td><td></td><td></td><td></td><td></td><td></td><td></td><td></td><td></td><td></td><td></td><td></td><td></td><td></td></tr> <tr><td></td><td></td><td></td><td></td><td></td><td></td><td></td><td></td><td></td><td></td><td></td><td></td><td></td><td></td><td></td><td></td><td></td><td></td><td></td><td></td><td></td></tr> </table>																																											
Message 2	Message 3 & 4																																										
<table border="1" style="width: 100%; height: 50px;"> <tr><td></td><td></td><td></td><td></td><td></td><td></td><td></td><td></td><td></td><td></td><td></td><td></td><td></td><td></td><td></td><td></td><td></td><td></td><td></td><td></td><td></td></tr> <tr><td></td><td></td><td></td><td></td><td></td><td></td><td></td><td></td><td></td><td></td><td></td><td></td><td></td><td></td><td></td><td></td><td></td><td></td><td></td><td></td><td></td></tr> </table>																																											
Message 3	Message 5 & 6																																										
<table border="1" style="width: 100%; height: 50px;"> <tr><td></td><td></td><td></td><td></td><td></td><td></td><td></td><td></td><td></td><td></td><td></td><td></td><td></td><td></td><td></td><td></td><td></td><td></td><td></td><td></td><td></td></tr> <tr><td></td><td></td><td></td><td></td><td></td><td></td><td></td><td></td><td></td><td></td><td></td><td></td><td></td><td></td><td></td><td></td><td></td><td></td><td></td><td></td><td></td></tr> </table>																																											
Message 4	Message 7 & 8																																										
<table border="1" style="width: 100%; height: 50px;"> <tr><td></td><td></td><td></td><td></td><td></td><td></td><td></td><td></td><td></td><td></td><td></td><td></td><td></td><td></td><td></td><td></td><td></td><td></td><td></td><td></td><td></td></tr> <tr><td></td><td></td><td></td><td></td><td></td><td></td><td></td><td></td><td></td><td></td><td></td><td></td><td></td><td></td><td></td><td></td><td></td><td></td><td></td><td></td><td></td></tr> </table>																																											

SPECIFICATIONS

Except where noted all specifications apply to operation at +25°C.

General

Display: PD154; Four red LED channel indicators. PD158; Eight red LED channel indicators. One green LED power indicator.

Alarm Messages: Custom printed adhesive clear labels.

Area: PD154, 1.25" x .60" (32 mm x 15 mm), 4 messages

PD158, 1.25" x .25" (32 mm x 6 mm), 8 messages

User specified size and length, up to 4 lines (PD154) or 2 lines (PD158) of 14 characters of size 9 pt fonts.

Programming Methods: Rear 4-position switch for sequence selection and horn operation. Three front panel pushbuttons for NO/NC input selection, sequence option, and operation.

Audible Alarm: 85 dB internal horn.

Noise Filter: 40 ms debounce on inputs, including external silence, acknowledge and reset.

Shared First-Out Systems: 1 ms unit-to-unit delay. Maximum of 200 units in the shared first-out system.

Non-Volatile Memory: All programmed settings are stored in non-volatile memory for a minimum of ten years if power is lost.

Power Options: 85-265 VAC, 50/60 Hz; 90-265 VDC, 20 W max; or 12-36 VDC, 12-24 VAC, 6 W max.

Fuse: Required external fuse: UL Recognized, 5 A max, slow blow. Up to 6 annunciators may share one 5 A fuse

Isolated Power Supply: 24 VDC ± 10% @ 200 mA max Standard on 85-265 VAC powered units only.

Isolation: 4 kV input/output-to-power line.

Overvoltage Category: Installation Overvoltage Category II: Local level with smaller transient overvoltages than Installation Overvoltage Category III.

Environmental: Operating temperature range: -40 to 65°C. Storage temperature range: -40 to 85°C. Relative humidity: 0 to 90% non-condensing.

Connections: Removable screw terminal blocks accept 12 to 22 AWG wire.

Enclosure: 1/8 DIN, high impact plastic, UL 94V-0, front color: black

Mounting: 1/8 DIN panel cutout required. Two panel mounting brackets included.

Tightening Torque: Screw terminal connectors: Gray: 4.5 lb-in (0.5 Nm). Green: 5 lb-in (0.5 Nm)

Overall Dimensions: 4.68" x 2.45" x 4.19" (62 mm x 119 mm x 106 mm) (H x W x D)

Weight: 9.6 oz (272 g)

UL File Number: E160849; 508 Industrial Control Equipment

Warranty: 3 years parts & labor

Extended Warranty: 1 or 2 years, refer to the Price List for details.

YOUR LOCAL DISTRIBUTOR IS:

Inputs

Input Types: NO or NC switches: No external excitation required.

Open collector transistor (NPN): Open circuit voltage approx. 3.3 VDC. Logic Levels: LOW = 0 to 0.9 VDC, HIGH = 2.4 to 28 VDC

Update Rate: 41 ms following alarm state; 1 ms for alarm state clear.

Sequences: Input follower, ISA Sequences A, F1A, F2A, F3A, M, F1M, and F3M per ISA Standard ISA-18.1-1979 R2004.

Sequence Options: A, F1A, F2A, F3A, M, F1M, F2M, and input follower with selectable options -1 (silence pushbutton), -4 (no lock-in), and -6 (no horn) per ISA Standard ISA-18.1-1979 R2004.

Relays

Rating: 2 SPDT (Form C); rated 3 A @ 30 VDC or 3 A @ 250 VAC resistive load; 1/14 HP @ 125/250 VAC for inductive loads.

Electrical Noise Suppression: A suppressor (snubber) should be connected to each relay contact switching inductive loads to prevent disruption to the microprocessor's operation. Recommended suppressor value: 0.01 µF/470 Ω, 250 VAC (PDX6901).

Relay Operation: Relay 1: Alarm state until alarm is acknowledged. Relay 2: Alarm state if any channel indicating alarm condition.

Fail-Safe Operation: Programmable independent for each relay.

Note: In fail-safe mode, relay coil is energized in non-alarm condition. In case of power failure, relay will go to alarm state.

ORDERING INFORMATION

85-265 VAC* Model	12-36 VDC* Model	Description
PD154-6R2-1	PD154-7R2-0	Vigilante® II 4-Point Annunciator
PD158-6R2-1	PD158-7R2-0	Vigilante® II 8-Point Annunciator

*All models may be powered from AC or DC, see Specifications for details.

Enclosures and Accessories

Model	# of Units	Description	Mounting
PDA25XX-V	1-10*	Plastic NEMA 4X Enclosure	Through Door
PDA26XX-V	1-6*	Stainless Steel NEMA 4X	Through Door
PDA27XX-V	1-6*	Steel NEMA 4 Enclosure	Through Door
PDA2801	1	Low-Cost Plastic NEMA 4X	Through Cover
PDX6901		Snubber 0.01µF, 470Ω, Flexible Leads	

Note: XX = the last two digits of the model number

* Go to www.predig.com to find individual model numbers.

Services

Model	Description
PDN-CSETUP	Custom Setup
PDN-ONEDAYRTN	One-Day Turnaround Service
PDN-EXTWRNTY1-0	Extended Warranty 1 Year LP:\$0-\$299
PDN-EXTWRNTY1-1	Extended Warranty 1 Year LP:\$300-\$599

LDS158_B 09/07