

Copper & Alloys

The electric metal.

ThyssenKrupp Materials NA
Copper and Brass Sales Division



ThyssenKrupp

Copper and Alloys

Contents

Welcome to Copper and Brass Sales.....	1	C385	50
Introduction to Copper and Alloys.....	2	C443	52
Processing Services	4	C464	53
Stock Availability		C485	55
C101, C102.....	6	C510	56
C110	13	C544	58
C122	20	C623	59
C145	24	C624	59
C147	25	C625	59
C172	26	C630	60
C173	30	C642	62
C175	30	C655	63
C180	31	C673	63
C181	31	C675	63
C182	32	C676	63
C187	34	C693	63
C191	34	C725	64
C210	35	C752	64
C220	35	C863	64
C230	35	C932	65
C260	36	C954	68
C272	39	MoldMAX®.....	72
C274	39	ToughMet®.....	73
C314	40	Physical Properties.....	74
C330	41	Fabrication Properties.....	75
C335	41	Mechanical Properties.....	76
C353	42	Chemical Compositions.....	80
C360	43	Specification Cross Reference.....	82
C365	49	Weight Formulas	inside back cover

Note: The data contained in this brochure has been compiled from many sources. Although every effort has been made to crosscheck and verify this information, Copper and Brass Sales is not responsible for its accuracy. This data is not to be used for design or specification purposes.

Welcome to Copper and Brass Sales

Consider this catalog your key to the vast storehouse of copper and copper alloy products comprising the Copper and Brass Sales Division of ThyssenKrupp Materials NA. Within these pages, you'll find one of the largest selections of copper and alloy sizes and shapes available anywhere — all in stock and ready for immediate delivery to your door.

You'll also find helpful technical data and information on how to put these items to work for you. You'll find information on specifications, chemical compositions, physical properties, tolerances, fabrication properties, and more — all arranged to allow you to make the comparisons necessary to match the right material to the job at hand.

After you've found the alloy you need, you'll also find one of the most comprehensive lineups of precision pre-processing services in the industry. These services will save you much time and money by supplying your order in immediately usable condition. Our precision saws, slitters, shears, cut-to-length, edge conditioning, leveling, and traverse-winding equipment will minimize additional handling on your part to maximize your bottom line. Additionally, we operate our own re-rolling mills to supply you with those hard-to-find in-between sizes and tempers. It's like getting a custom mill order with the added advantage of service-center response.

We think that you'll find many other advantages to dealing with the Copper and Brass Sales Division for all of your materials needs. Because we're a nationwide company, you'll have access to a national inventory of metals.

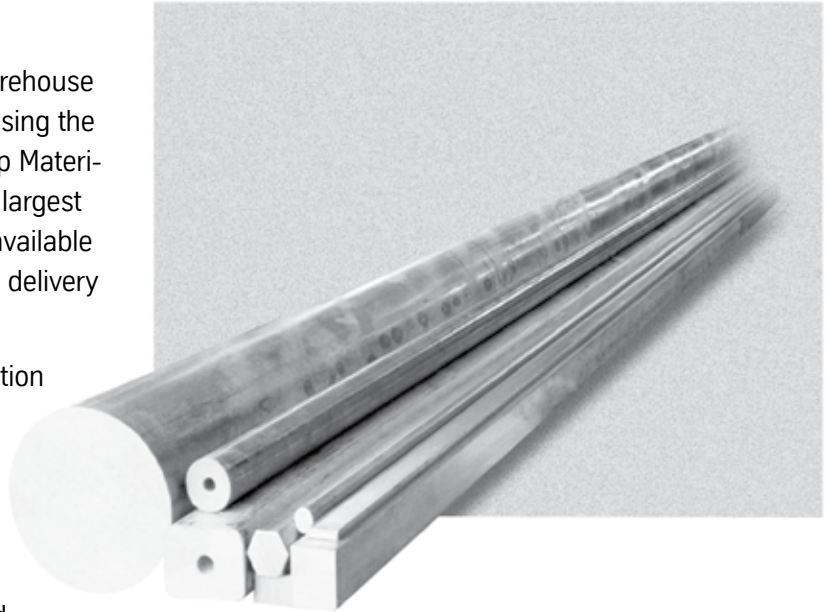

Because we have stocking locations across the country, you'll have the reliability of local service. Because we operate and maintain our own national logistics system, you'll know that we can get your order to you when and where you need it.

And finally, if you don't see what you need within the space of these pages, call us at (800) 926-2600. Because this is a stock catalog, we haven't listed the many special items we have or can access to meet your most unusual requirements.

We take great pride in the ability of our people to serve your needs and we look forward to doing so in the near future.

Just remember, when it comes to copper and alloys and all your nonferrous needs, your best source is the Copper and Brass Sales Division.



One Call Gets It All!
(800) 926-2600

Introduction to Copper and Alloys

As one of the oldest names in metallurgical history, copper exhibits a unique combination of properties including high electrical and thermal conductivity, and high resistance to corrosion.

Mankind's First Metal

Copper has been in use at least 10,000 years, but more than 95% of all copper ever mined and smelted has been extracted since 1900. As with many natural resources, the total amount of copper on Earth is vast (around 10^{14} tons just in the top kilometer of Earth's crust, or about 5 million years worth at the current rate of extraction). However, only a tiny fraction of these reserves is economically viable, given present-day prices and technologies. Various estimates of existing copper reserves available for mining vary from 25 years to 60 years, depending on core assumptions such as the growth rate.

While copper in its purest form is a very soft metal, almost any element that can be added to copper will increase its hardness. The addition of tin not only imparts strength but also results in an alloy, known as bronze, that can be readily cast in molds. Early on, man discovered that bronze would flow evenly into molds and produce reliable castings with intricate shapes and patterns.

Later, the Egyptians developed the art of further hardening copper with the addition of alloying elements and then work hardening the metal by hammering. In addition to advancing the metalworking art, the Egyptians also contributed an early symbol for copper still used today. In the form of a cross with an oval loop on top, this symbol, the ankh, was the one they used for enduring life and was found repeatedly in the writings on the tombs of ancient kings.



The ancient symbol for eternal life, the Ankh, was also used to represent copper.

Copper Alloys

Over the years, as new uses for copper have been discovered, so too have an entire range of copper-based alloys developed to meet specific needs and applications.

Copper alloys are metal alloys that have copper as their principal component. They have high resistance against corrosion. The best known traditional types are bronze, where tin is a significant addition, and brass, using zinc instead. Both of these are imprecise terms, having been commonly referred to as lattens in the past. Today we tend to substitute the term copper alloy instead.

The similarity in external appearance of the various alloys, along with the different combinations of elements used when making each alloy, can lead to confusion when categorizing the different compositions. There are as many as 400 different copper and copper-alloy composi-



The old Kennecott mine is perched on the edge of a glacial moraine, in the deep interior of Alaska's Wrangell-St. Elias National Park and Preserve, the nation's largest.

The Guggenheims and Morgans (of J.P. Morgan fame) financed the construction of this self-contained mining town in the early 20th century and brought in the railroad to boot. It was all to take advantage of a geologic wonder in the mountains above — one of the richest deposits of copper ore ever recorded.

tions loosely grouped into the categories of copper, high-copper alloy, brasses, bronzes, copper-nickels, copper-nickel-zinc (nickel silver), leaded copper, and specialty alloys. The table that follows lists the principal alloying element for five of the more common types used in modern industry, along with the name of each type. Historically, other types, such as those that are characteristic of the Bronze Age, are vague as the mixtures were generally variable.



Alloy Classifications

Family	Principal alloying element	UNS numbers
Copper alloys, brass	Zinc (Zn)	C1xxxx – C4xxxx, C66400 – C69800
Phosphor bronze	Tin (Sn)	C5xxxx
Aluminium bronzes	Aluminium (Al)	C60600 – C64200
Silicon bronzes	Silicon (Si)	C64700 – C66100
Copper nickel, nickel silvers	Nickel (Ni)	C7xxxx

For purposes of identification, copper and copper alloys are divided into characteristic groups, each group determined by its composition, and referenced by a system of three-digit numbers originally designated by the Copper Development Association, or CDA. Today these designations have been expanded to five digits, following a prefix letter C, and made a part of the Unified Numbering System for Metals and Alloys which is jointly managed by the American Society for Testing and Materials, ASTM; and by the Society of Automotive Engineers, SAE. These groups are summarized as follows:

100 Series (C10000) Coppers

This group comprises the pure coppers, those with a designated minimum copper content of 99.3%, for high electrical conductivity.

Also included within this group are the high copper alloys, those with copper contents of between 99.3% and 96%; which contain additional alloying elements such as beryllium, cadmium, chromium, cobalt, nickel, or iron for greater strength without drastically reducing the electrical conductivity.

200 Series (C20000) Brasses

These are the basic copper-zinc alloys which feature ease of manufacturing while still maintaining fair electrical characteristics. These alloys are excellent for drawing and forming while still providing good strength.

300 Series (C30000) Leaded Brasses

These are basically brass alloys that contain an addition of 1 to 3% lead to provide greater ease of machining, blanking, shearing, sawing, and milling.

400 Series (C40000) Tin Brasses

These alloys contain 1 to 2% of tin as well as copper and zinc to provide greater corrosion resistance while maintaining strength. These alloys find many uses in electrical applications such as contact springs, fuse clips, terminals, and connectors.

500 Series (C50000) Phosphor Bronzes

These alloys feature greater resistance to alternating or cyclic stress as required in applications for springs, diaphragms, bellows, and contacts.

This series also includes the leaded phosphor bronzes which provide better performance under load conditions found in sleeve bushings, bearings, thrust washers, and engine and drive train applications.

600 Series (C60000) Bronzes

This series of alloys includes the aluminum bronzes, which contain 2 to 3% of aluminum for strength while maintaining formability. These alloys are often used for wear plates, bushings, bearings, and hydraulic valve parts.

Also included in this group are the silicon bronzes which are suitable for all types of welding in addition to having good hot forming and cold working properties.

Other miscellaneous copper-zinc alloys are also included within this classification series.

700 Series (C70000) Nickel Silvers

These special alloys composed of copper, nickel, and sometimes lead, have high strength and increased resistance to corrosion along with good formability.



Loading copper ingots in Houghton, Michigan, circa 1905. This at a time when Michigan's Upper Peninsula was an important source of the metal necessary to feed the nation's hunger for the new electrification technology. Notice the advanced electric lighting facilities provided dock side.

At Copper and Brass Sales, our service doesn't stop with the sale. We process all products to strict mill specifications and precise tolerances with the short lead time and dependable delivery that you can count on every day.



Re-rolling

Copper and Brass Sales re-rolls strip and coil on precision mills to provide customers the exact thickness of material necessary for light-gauge close-tolerance requirements. The result is the consistent thickness and uniform temper essential for critical electronic, aerospace, automotive and similar applications.

Re-Rolling

Thickness Capability	.004" to .150"	
Minimum Width	no minimum width	
Maximum Width	13.5"	
Tolerances	Thickness	Tolerance
	.004" to .035"	±.0005"
	.035" to .060"	±.00075"
	.060" to .150"	±.001"
Maximum OD	40"	

Annealing

Our custom-designed strand and bell annealing furnaces process copper and alloy strip plus nickel and special purpose alloys in a wide range of tempers and target grain sizes.

Annealing

Thickness Capability	.004" to .150"
Minimum Width	no minimum width
Maximum Width	13.5"

Slitting

Copper and Brass Sales precision coil slitting machinery is used only for nonferrous metals to ensure peak performance at all times. Our slitters accommodate widths up to 36" and thicknesses up to .125" with width tolerances as close as ±.002".

Slitting

Alloys	Aluminum, Copper, Copper Alloy, Stainless Steel, Zinc
Thickness Capability	Up to .187" depending on alloy
Width Capability	.100" to 36" depending on thickness
Tolerances	±.002" on width
Camber	One-half commercial tolerance, tighter on request
Other	ID capabilities: 3", 4", 6", 10", 12", 14", 16", 20"; OD capabilities: up to 60"; Pinch roll capabilities for burr height control

Tension Leveling

Our unique coil-to-coil tension levelers remove high crowns and edgewise curvature from coiled strip products. This allows us to deliver product processed with the close-tolerance flatness required for critical stamping, lead frame (nickel alloys) and chemical etching.

Tension Leveling

Thickness Capability	.004" to .045"
Minimum Width	.250"
Maximum Width	4"
Tolerances	1/4 commercial tolerance on camber, dish, and coil set
Process	Coil-to-coil
Coil Sizes	3" to 16" ID; 36" max. OD



Traverse Winding

Our custom built 5-head traverse winders provide reels with strip that is smooth and free of distortion and functional welds that won't harm tooling. Traverse winding gives you longer coils for greater run time, efficiency, and productivity.

Traverse Winding	
Thickness Capability	.005" to .040"
Minimum Width	.25"
Maximum Width	2.25"
Spool Size	Standard 1000# spools; Can provide 500# or 2000# spools on request

Leveling & Cut-To-Length

Our investment in advanced equipment and experienced, highly-trained operators allows us to deliver nonferrous and specialty alloys to mill certified flatness precisely as you need them, so you get exactly the size flat strip you need to minimize scrap.

Leveling & Cut-To-Length	
Alloys	Copper & Alloys, Aluminum, Stainless Steel, Zinc
Thickness Capability	.010" to .125"
Minimum Width	.250"
Maximum Width	60"
Length	14" to 192" depending on width
Length Tolerance	From $\pm .0625"$ to $+.250"/-.000$

Note: Cut-to-length services for sheet products are available up to 60" wide.

Plate Sawing

Our plate sawing capability allows us to save you time and money by supplying your material in immediately usable condition.

Plate Sawing	Standard	Precision
Thickness .125" to 3"	$\pm .032"$	$\pm .010"$

Sawed Rings & Circles	OD	ID
Thickness .1875" thru 2"	$+.125"/-0$	$+0/-.125"$
Thickness 2" thru 5"	$+.25"/-0$	$+0/-.25"$

Bar Sawing

Rod, bar, tube and extrusions can be cut to your exact specifications on our high-speed equipment.

Bar Sawing	
Standard	$\pm .062"$, all bar sizes
Precision	$\pm .010"$, up to 8" round and square, closer tolerances can be performed by request

Edge Conditioning

Edge conditioning removes the edge burrs left from slitting for critical applications such as transformer winding and precision stamping.

Edge Conditioning	
Edge Burr Crush	.003" to .125" thick
Formed Edge Conditioning	.025" to .125"

Plating

Tin plating and other secondary processes are available on request. Call (800) 926-2600 for more information on plating services.

Testing & Quality Control

Quality assurance at Copper and Brass Sales is an integral part of our entire process. Each incoming shipment we receive is inspected for damage, dimensions, water stains, and blemishes before it is accepted for further processing.

All outbound processed material is inspected by visual and dimensional methods to ensure that you receive the highest quality product available. All certification is also double-checked to guarantee material meets order requirements. And when necessary, as in the case of internally annealed and/or re-rolled material, our in-house laboratory services test for mechanical properties and grain size.

All of our locations are ISO 9001:2008 certified and many locations are certified to AS9100:2009.



Our Commitment To You

Everything we do at Copper and Brass Sales — from precision processing, to quality control, to dependable delivery — is focused on you, our customer. One call to (800) 926-2600 gets you the finest quality nonferrous and specialty alloys available. Just the way you want them — when you want them — where you want them.

C10100 and C10200 Oxygen Free Copper

Nominal Composition

C10100 — 99.99% minimum copper with maximum limits in parts per million (ppm) for the following impurities: antimony – 4, arsenic – 5, bismuth – 1, cadmium – 1, iron – 10, lead – 5, manganese – 0.5, nickel – 10, oxygen – 5, phosphorus – 3, selenium – 3, silver – 25, sulfur – 15, tellurium – 2, tin – 2, and zinc – 1.

C10200 — 99.95% minimum copper (including silver), 10 ppm maximum oxygen

Physical Properties

Melting Point (Liquidus):	1,083°C (1,981°F)
Melting Point (Solidus):	1,083°C (1,981°F)
Density at 68°F:	0.323 lb/in ³
Coefficient of Linear Expansion: (per °F)	9.4 x 10 ⁻⁶ (68-212°F), 9.6 x 10 ⁻⁶ (68-392°F), 9.8 x 10 ⁻⁶ (68-572°F)
Electrical Conductivity at 68°F: (volumetric)	101% IACS for C10100, 100% IACS for C10200 (in annealed condition; lower in hard temper)
Thermal Conductivity:	226 Btu/ft ² /ft/hr/°F at 68°F
Modulus of Elasticity — Tension:	17,000 ksi
Modulus of Rigidity:	6,400 ksi
Fabrication Properties	
Hot Working Temperature:	750-875°C (1,400-1,600°F)
Annealing Temperature:	375-650°C (700-1,200°F)
Approximate Relative Machinability:	20 (free cutting brass = 100)

Mechanical Properties

Rod	Tensile Strength (psi)	Yield Strength (0.5% Ext.) (psi)	% Elongation (in 2")	Rockwell Hardness
0.250" Dia. — H04 Hard (20%)	55,000	50,000	10	HRB 60
1.000" Dia. — M20 As Hot Rolled	32,000	10,000	55	HRF 40
1.000" Dia. — 0.050 mm OS050	32,000	10,000	55	HRF 40
1.000" Dia. — H04 Hard (35%)	48,000	44,000	16	HRB 47
2.000" Dia. — H04 Hard (16%)	45,000	40,000	20	HRB 45
Wire	Tensile Strength (psi)	Yield Strength (0.5% Ext.) (psi)	% Elongation (in 2")	Rockwell Hardness
0.080" Dia. — 0.050 mm	35,000	—	35 (in 10")	—
0.080" Dia. — H04 Hard	55,000	—	—	—
0.080" Dia. — H08 Spring	66,000	—	—	—
Flat Products	Tensile Strength (psi)	Yield Strength (0.5% Ext.) (psi)	% Elongation (in 2")	Rockwell Hardness
0.040" Thick — H02 Half Hard	42,000	36,000	14	HRB 40
0.040" Thick — H04 Hard	50,000	45,000	6	HRB 50
0.040" Thick — M20 As Hot Rolled	34,000	10,000	45	HRF 45
0.250" Thick — H01 Quarter Hard	38,000	30,000	35	HRF 70
0.250" Thick — H04 Hard	50,000	45,000	12	HRB 50
1.0" Thick — H04 Hard	45,000	40,000	20	HRB 45

Description

Oxygen-free, high-conductivity coppers, C10100 (electronic grade) and C10200 (regular grade), are undoubtedly the purest coppers commercially available and possess a unique set of properties. For example, their freedom from oxygen, as their name implies, gives them immunity to hydrogen embrittlement when exposed to elevated temperatures under reducing conditions. This distinguishes them from electrolytic tough pitch (ETP) C11000 copper whose typical oxygen content of 400 ppm results in susceptibility to hydrogen embrittlement. Their freedom from deoxidizing elements and impurities in general ensures a consistently, high electrical conductivity exceeding 100% IACS.

Copper and Brass Sales is the exclusive distributor in North America for premium quality C10100 oxygen-free electronic copper products manufactured by SH Copper Products, Luvata Pori, and Aurubis Pori.

Hot Working

Both C10100 and C10200 have excellent hot workability. They can be

readily hot extruded using very high reductions. They can also be readily forged, and the amount of reduction per pass should be as large as possible, particularly in the initial passes. The time and temperature of heating prior to hot working should be minimized. A uniform temperature should be achieved throughout the work piece. Heating should be preferably done in a reducing or neutral atmosphere.

Cold Working

Both C10100 and C10200 have excellent cold workability. They can be readily cold drawn with high reductions between annealing cycles. Annealing should be performed in a reducing or neutral atmosphere. High temperatures should also be avoided to minimize grain growth.

Joining and Fabrication

Joining by soldering and brazing is excellent. Due to their very low oxygen contents and overall low impurities, both coppers can be readily welded using the shielded arc processes.



Applications

C10100 and C10200 are typically used in applications where the presence of oxygen is detrimental. In particular, C10100, with its strictly held low levels of impurities, is used for more critical conditions such as high-vacuum conditions where low volatility of impurities is essential. Both coppers also form a tight, adherent, oxide scale, which is advantageous for glass-to-metal seals. The coppers are particularly noted for their excellent dimensional stability when heated in hydrogen, having low coefficients of expansion over a broad temperature range.

Due to their high electrical conductivity, toughness and ductility, C10100 and C10200 are used in electronic applications such as coaxial cables, computer hook-up wire, heat sinks for diodes, rectifiers, and other components, lead wire for circuit breakers and modules, microwave equipment, radar components, solderless connectors and

wave guides. Electrical applications include armature windings, bus bars, cold-headed parts such as connector pins, flexible shunts, motor and generator windings, collector rings, switches, contacts, and transformer coil windings.

Applicable Specifications

When so specified, C10100 and C10200 will be manufactured to the latest revision of the following specifications: ASTM Specifications B49, B187, and F68 for rod; B1, B2, B3, B33, B48, B189, B246, B272, B298, B355, and F68 for wire; B187, and F68 for shapes; and B75, B188, B372, and F68 for tube.

OFE C101 Coppers for Electron Device Applications

C10100, ASTM F68-10

High performance power tubes, high temperature, and high-vacuum devices all benefit from the advanced processing, quality control, and testing that you get with OFE Copper manufactured by SH Copper Products (formerly Hitachi), Luvata Pori for drawn products, and Aurubis Pori for rolled products. These products are distributed exclusively by the Copper and Brass Sales Division of ThyssenKrupp Materials NA.

These state-of-the-art products provide higher purity, conductivity, resistance to hydrogen embrittlement, and freedom from volatile gas content than any other copper products available today. OFE C101, ASTM F68 copper offers excellent vacuum integrity after welding or brazing. In addition, the excellent formability, brazeability, and weldability of OFE copper saves you time and effort in manufacturing.

Typical applications include power tubes, x-ray tubes, magnetrons, vacuum capacitors, particle accelerators, and vacuum deposition.

Chemical Composition

Copper	Min. 99.99%*
Bismuth.....	Max. 10 ppm
Cadmium.....	Max. 1 ppm
Lead	Max. 10 ppm
Mercury	Max. 1 ppm
Oxygen.....	Max. 5 ppm

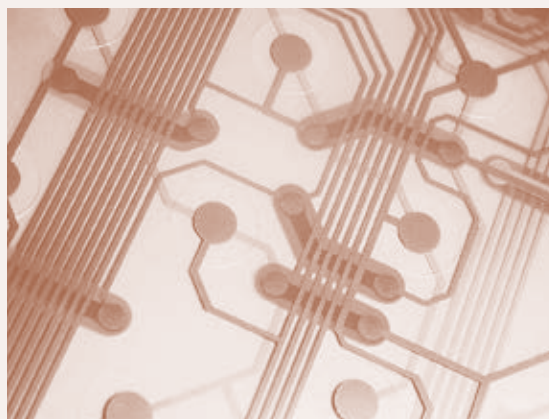

Phosphorus	Max. 3 ppm
Selenium	Max. 10 ppm
Sulfur	Max. 15 ppm
Tellurium	Max. 10 ppm
Zinc.....	Max. 1 ppm
Antimony + Selenium + Arsenic + Tellurium + Bismuth + Tin + Manganese	Max 40 ppm

*Copper content shall be determined by difference of impurity total from 100 percent. Impurity total is defined as the sum of silver, sulfur, lead, tin, bismuth, arsenic, antimony, iron, nickel, mercury, zinc, phosphorus, selenium, tellurium, manganese, cadmium, and oxygen.

Performance

Average electrical conductivity (%)	101.8
Relative thermal conductivity (%)	100
Resistance to hydrogen embrittlement.....	Excellent
Deep-drawability	Excellent
Scale adherence	Excellent



|← D →|

C10100 Round OFE Copper Rod H04 (hard)

12 Foot Mill Lengths
ASTM B187, ASTM F68

Diameter (Inches)	Diameter Tolerance	Pounds Per Foot
0.5	(±.0015)	0.7607
0.625	(±.002)	1.1885
0.75	(±.002)	1.7115
0.875	(±.002)	2.3295
1	(±.002)	3.0427
1.125	(±.0025)	3.8509
1.25	(±.0025)	4.7542
1.5	(±.0025)	6.8460
1.75	(±.0025)	9.3181
2	(±.0025)	12.1706
2.125	(±.003)	13.7395
2.25	(±.0035)	15.4035
2.375	(±.004)	17.1625
2.5	(±.004)	19.0166
2.625	(±.004)	20.9600
2.75	(±.004)	23.0101
3	(±.005)	27.3839
3.25	(±.005)	32.1381
3.5	(±.005)	37.2726
3.875	(±.006)	45.6874
4	(±.006)	48.6826
4.25	(±.006)	54.9580
4.5	(±.007)	61.6139
4.75	(±.007)	68.6500
5	(±.010)	76.0665



|← D →|

C10100 Round OFE Copper Rod Extruded

12 Foot Mill Lengths
ASTM B187, ASTM F68

Diameter (Inches)	Diameter Tolerance	Pounds Per Foot
5.5	(±.063)	92.0405
6	(±.063)	109.5360
6.5	(±.063)	128.5520
7	(±.120)	149.0900
7.5	(±.120)	171.1500

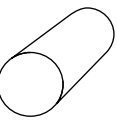

|← D →|

C10100 Round OFE Copper Billet Cast

12 Foot Mill Lengths
ASTM B187, ASTM F68

Diameter (Inches)	Diameter Tolerance	Pounds Per Foot
8	(+.125 -0)	194.7300
9	(+.125 -0)	250.7500

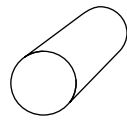

|← D →|

C10100 Round OFE SH Copper Products Rod H04 (hard)

12 Foot Mill Lengths
ASTM B187, ASTM F68

Diameter (Inches)	Diameter Tolerance	Pounds Per Foot
0.125	(±.0013)	0.0475
0.1875	(±.0015)	0.1070
0.25	(±.0015)	0.1902
0.3125	(±.0015)	0.2971
0.375	(±.0015)	0.4279
0.4375	(±.0015)	0.5824
0.5	(±.0015)	0.7607
0.625	(±.002)	1.1885
0.75	(±.002)	1.7115
0.8125	(±.002)	2.0086
0.875	(±.002)	2.3295
1	(±.002)	3.0427
1.0625	(±.0025)	3.4349
1.125	(±.0025)	3.8508
1.1875	(±.0025)	4.2906
1.25	(±.0025)	4.7542
1.3125	(±.0025)	5.2415
1.375	(±.0025)	5.7525
1.5	(±.0025)	6.8460
1.625	(±.0025)	8.0345
1.75	(±.0025)	9.3181
2	(±.0025)	12.1706
2.125	(±.004)	13.7395
2.25	(±.004)	15.4035
2.375	(±.004)	17.1625
2.5	(±.004)	19.0166
2.625	(±.004)	20.9658
2.75	(±.0045)	23.0101
3	(±.0045)	27.3839
3.125	(±.005)	29.7135
3.25	(±.005)	32.1381
3.5	(±.0055)	37.2726
3.625	(±.0055)	39.9825
3.75	(±.006)	42.7874
3.875	(±.006)	45.6874
*3.875		45.6874

*O60 (soft anneal)

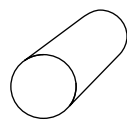

|← D →|

C10100 Round OFE SH Copper Products Rod Extruded

12 Foot Mill Lengths
ASTM B187, ASTM F68

Diameter (Inches)	Diameter Tolerance	Pounds Per Foot
4	(±.120)	48.6826
4.1875	(±.120)	53.3535
4.25	(±.120)	54.9580
4.5	(±.120)	61.6139
4.75	(±.120)	68.6500
5	(±.120)	76.0665



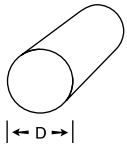

C10100 Round OFE SH Copper Products Rod Forged & Rough Machined

12 Foot Mill Lengths
ASTM B187, ASTM F68

Diameter (Inches)	Diameter Tolerance	Pounds Per Foot
5.5	(±.125)	92.0405
6	(±.125)	109.5360
6.5	(±.125)	128.5520
7	(±.125)	149.0900
7.5	(±.125)	171.1500
8	(±.125)	194.7300
9	(±.125)	246.4560

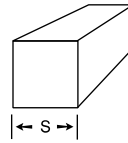

C10100 Square OFE SH Copper Products Bar H02 (half-hard) (Formerly H04)

12 Foot Mill Lengths
ASTM F68

Size (Inches)	Size Tolerance	Pounds Per Foot
0.375	(±.003)	0.5451
0.5	(±.003)	0.9690
0.75	(±.003)	2.1803
1	(±.003)	3.8760
1.25	(±.003)	6.0563
2	(±.003)	15.504

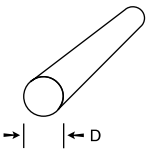

C10200 Round OF Copper Wire O60 (soft anneal)

Supplied In Coils
ASTM B187

Diameter (Inches)	Diameter Tolerance	Pounds Per Foot
0.312	(±.0015)	0.2962
0.406	(±.0015)	0.5015
0.520	(±.002)	0.8227
0.640	(±.002)	1.2463
0.765	(±.002)	1.7806
0.875	(±.002)	2.3295

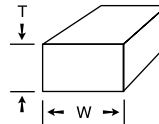

C10100 Rectangular OFE SH Copper Products Bar H02 (half-hard) (Formerly H04)

12 Foot Mill Lengths
ASTM F68, ASTM B187

Thickness (Inches)	Thickness Tolerance	Width (Inches)	Width Tolerance	Pounds Per Foot
0.1875	(±.003)	2	(±.008)	1.4535
0.1875	(±.0055)	12	(±.063)	8.7210
0.25	(±.003)	0.5	(±.008)	0.4845
0.25	(±.003)	1	(±.008)	0.9690
0.25	(±.003)	1.5	(±.008)	1.4535
0.25	(±.004)	3	(±.012)	2.9070
0.25	(±.004)	4	(±.012)	3.8760
0.25	(±.0055)	12	(±.063)	11.6280
0.3125	(±.0055)	12	(±.063)	14.5350
0.375	(±.003)	0.5	(±.008)	0.7268
0.375	(±.003)	1	(±.008)	1.4535
0.375	(±.003)	1.5	(±.008)	2.1803
0.375	(±.003)	2	(±.008)	2.9070
0.375	(±.0055)	12	(±.063)	17.4420
0.5	(±.003)	1	(±.008)	1.9380
0.5	(±.003)	2	(±.008)	3.8760
0.5	(±.004)	3	(±.012)	5.8140
0.5	(±.004)	4	(±.012)	7.7520
0.5	(±.0055)	12	(±.063)	23.2560
0.625	(±.004)	1	(±.008)	2.4225
0.625	(±.006)	12	(±.063)	29.0700
0.75	(±.004)	1	(±.008)	2.9070
0.75	(±.006)	12	(±.063)	34.8840
1	(±.004)	2	(±.008)	7.7520
1	(±.006)	12	(±.063)	46.5130
1.25	(±.020)	12	(±.063)	58.1400
1.5	(±.005)	3.125	(±.012)	18.1688
1.5	(±.020)	12	(±.063)	69.7680

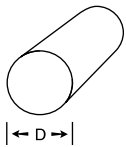

C10200 Round OF Copper Rod H04 (hard)

12 Foot Mill Lengths
ASTM B187

Diameter (Inches)	Diameter Tolerance	Pounds Per Foot
0.875	(±.002)	2.3295
1.125	(±.0025)	3.8509
1.25	(±.0025)	4.7542
1.359	(±.0025)	5.6194
2	(±.0025)	12.1768
3.85	(±.0057)	45.0998
4	(±.006)	48.6826
4.5	(±.00675)	61.6139

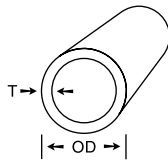

C10100 Round OFE Copper Tube H80 (hard-drawn)

12 Foot Mill Lengths
ASTM F68, ASTM B75

OD (Inches)	OD Tolerance	Thickness (Inches)	Thickness Tolerance	Pounds Per Foot	OD (Inches)	OD Tolerance	Thickness (Inches)	Thickness Tolerance	Pounds Per Foot
0.125	(±.002)	0.032	(±.003)	0.0362	1.5	(±.003)	0.375	(±.02625)	5.1372
0.1875	(±.002)	0.032	(±.0025)	0.0606	1.566	(±.003)	0.167	(±.009)	2.845
0.1875	(±.002)	0.035	(±.0025)	0.065	1.625	(±.003)	0.049	(±.003)	0.9404
0.25	(±.002)	0.032	(±.0025)	0.0849	1.75	(±.003)	0.065	(±.004)	1.3337
0.25	(±.002)	0.035	(±.0025)	0.0916	1.75	(±.003)	0.375	(±.02625)	6.2788
0.3125	(±.002)	0.032	(±.0025)	0.1093	1.75	(±.003)	0.375	(±.02625)	6.2788
0.3125	(±.002)	0.065	(±.0035)	0.1959	2	(±.003)	0.063	(±.004)	1.486
0.375	(±.002)	0.032	(±.0025)	0.1337	2	(±.003)	0.125	(±.006)	2.854
0.375	(±.002)	0.032	(±.0025)	0.1337	2	(±.003)	0.25	(±.0175)	5.3275
0.375	(±.002)	0.035	(±.0025)	0.1449	2	(±.003)	0.5	(±.035)	9.1328
0.375	(±.002)	0.065	(±.0035)	0.2454	2.125	(±.004)	0.25	(±.0175)	5.708
0.5	(±.002)	0.032	(±.0025)	0.1824	2.25	(±.004)	0.3125	(±.004)	7.3729
0.5	(±.002)	0.035	(±.0025)	0.1982	2.5	(±.004)	0.065	(±.006)	1.9273
0.5	(±.002)	0.0625	(±.0035)	0.333	2.5	(±.004)	0.125	(±.008)	3.6151
0.5	(±.002)	0.125	(±.005)	0.5708	2.5	(±.004)	0.25	(±.0175)	6.8496
0.625	(±.002)	0.062	(±.0035)	0.4251	2.5	(±.004)	0.375	(±.02625)	9.7036
0.625	(±.002)	0.121	(±.005)	0.7426	2.615	(±.004)	0.0575	(±.006)	1.7907
0.75	(±.0025)	0.035	(±.0025)	0.3047	2.75	(±.004)	0.25	(±.0175)	7.6107
0.75	(±.0025)	0.0625	(±.004)	0.5232	2.75	(±.004)	0.375	(±.02625)	10.8452
0.75	(±.0025)	0.125	(±.006)	0.9513	2.75	(±.004)	0.625	(±.04375)	16.1727
1	(±.0025)	0.049	(±.0035)	0.5657	3	(±.004)	0.25	(±.0175)	8.3718
1	(±.0025)	0.125	(±.006)	1.3319	3	(±.004)	0.625	(±.04375)	18.0754
1	(±.004)	0.145	(±.006)	1.5097	3.375	(±.005)	0.5	(±.035)	17.5046
1	(±.0025)	0.25	(±.0175)	2.2832	3.5	(±.005)	0.062	(±.006)	2.5956
1.15	(±.003)	0.225	(±.0175)	2.5433	3.5	(±.005)	0.187	(±.011)	7.5441
1.25	(±.003)	0.125	(±.006)	1.7124	3.5	(±.005)	0.25	(±.0175)	9.8939
1.25	(±.003)	0.1975	(±.009)	2.5	3.5	(±.005)	0.562	(±.03934)	20.1063
1.274	(±.003)	0.262	(±.01834)	3.2287	3.75	(±.005)	0.5	(±.035)	19.7878
1.5	(±.003)	0.125	(±.006)	2.0929	4	(±.005)	0.25	(±.0175)	11.416
1.5	(±.003)	0.25	(±.0175)	3.8053					

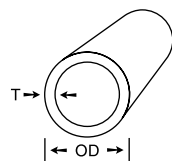

C10100 Round OFE Copper Tube H58 (drawn-general purpose)

12 Foot Mill Lengths
ASTM F68, ASTM B75

OD (Inches)	OD Tolerance	Thickness (Inches)	Thickness Tolerance	Pounds Per Foot
4	(±.005)	0.5	(±.035)	21.3099
4	(±.005)	0.625	(±.04375)	25.6861
4.125	(±.006)	0.3125	(±.025)	14.5079
4.25	(±.006)	0.875	(±.070)	35.9605
4.5	(±.006)	0.109	(±.009)	5.8281
5.17	(±.007)	0.345	(±.0276)	20.2703
5.5	(±.007)	0.562	(±.04496)	33.7934
6.5	(±.008)	0.5	(±.040)	36.5313



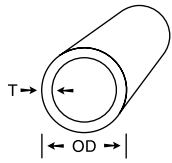

C10200
Round OF Copper
Standard Pipe Size
H80 (hard-drawn)
 20 Foot Lengths
 ASTM B42

Nominal Pipe Size	OD (Inches)	Thickness (Inches)	Pounds Per Foot
.75	1.05	0.114	1.2993
1.25	1.66	0.146	2.6917
1.5	1.9	0.15	3.1965
2	2.375	0.156	4.2153

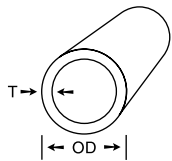

C10200
Round OF Copper
Seamless Standard Pipe Size
H80 (hard-drawn)
 20 Foot Lengths
 ASTM B188

Nominal Pipe Size	OD (Inches)	Thickness (Inches)	Pounds Per Foot
.5	0.84	0.107	0.9551
.75	1.05	0.114	1.2993
1	1.315	0.126	1.8243
2.5	2.875	0.187	6.1209

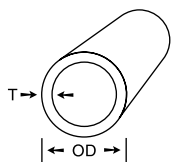

C10200
Round OF Copper
Seamless Extra Heavy Pipe
H80 (hard-drawn)
 20 Foot Lengths
 ASTM B188

Nominal Pipe Size	OD (Inches)	Thickness (Inches)	Pounds Per Foot
.75	1.05	0.157	1.7072
2	2.375	0.221	5.7967

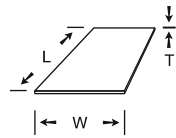

C10100
OFE SH Copper Products
Sheet & Coil
H02 (half-hard)
 ASTM F68

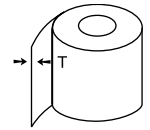

Thickness (Inches)	Thickness Tolerance	Shape	W x L (Inches)	Pounds Per Square Foot
0.01	(±.0013)	Sheet	12 x 72	0.4651
0.015	(±.0015)	Sheet	12 x 72	0.6977
0.02	(±.0018)	Sheet	12 x 72	0.9302
0.025	(±.002)	Sheet	12 x 72	1.1628
0.03	(±.002)	Sheet	12 x 72	1.3954
0.05	(±.0025)	Coil		2.3256
0.07	(±.003)	Sheet	12 x 72	3.2558
0.093	(±.0035)	Sheet	12 x 72	4.3256
0.125	(±.0035)	Sheet	12 x 72	5.8140
0.125	(±.004)	Coil		5.8140
0.156	(±.004)	Coil		7.2559

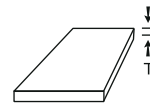

C10100
OFE SH Copper Products Plate
H04 (hard)
 ASTM F68

Thickness (Inches)	Thickness Tolerance	Pounds Per Square Foot
0.1875	(±.0055)	8.7210
0.25	(±.0055)	11.6280
0.375	(±.0055)	17.4420
0.5	(±.0055)	23.2560
0.625	(±.006)	29.0700
0.75	(±.006)	34.8840
1	(±.006)	46.5120
1.5	(±.022)	69.7680

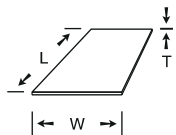

C10100
OFE SH Copper Products
Sheet & Coil
O60 (soft anneal)
 ASTM F68

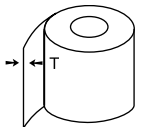

Thickness (Inches)	Thickness Tolerance	Shape	W x L (Inches)	Pounds Per Square Foot
0.032	(±.002)	Sheet	12 x 96	1.4884
0.032	(±.002)	Coil		1.4884
0.04	(±.002)	Coil		1.8605
0.062	(±.0025)	Coil		2.8837
0.08	(±.003)	Coil		3.7210

*Deep Draw Quality

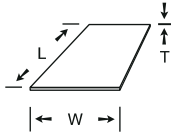

**C10100
OFE Copper Sheet,
Coil & Plate
H02 (half-hard)**
ASTM F68

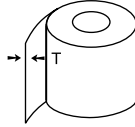

Thickness (Inches)	Thickness Tolerance	Shape	W x L (Inches)	Pounds Per Square Inch
0.02	(±.0035)	Sheet	36 x 96	0.9302
0.025	(±.0035)	Sheet	36 x 96	1.1628
0.032	(±.004)	Sheet	36 x 96	1.4884
0.04	(±.005)	Sheet	36 x 96	1.8605
0.05	(±.005)	Sheet	36 x 96	2.3256
0.062	(±.006)	Sheet	36 x 96	2.8837
0.062	(±.005)	Coil		2.8837
0.093	(±.007)	Sheet	36 x 96	4.3256
0.093	(±.006)	Coil		4.3256
0.125	(±.007)	Sheet	36 x 96	5.8140
0.125	(±.006)	Coil		5.8140
0.19	(±.008)	Plate		8.8373
0.25	(±.012)	Plate		11.6280
0.3125	(±.013)	Plate		14.5350
0.375	(±.013)	Plate		17.4420
0.375	(±.013)	Plate		17.4420
0.5	(±.013)	Plate		23.2560
0.625	(±.017)	Plate		29.0700
0.75	(±.017)	Plate		34.8840
0.875	(±.021)	Plate		40.6980
1	(±.021)	Plate		46.5120

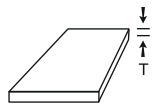

**C10100
OFE Copper Plate
M20 (as hot rolled)**
ASTM F68

Thickness (Inches)	Thickness Tolerance	Pounds Per Square Inch
1.25	(+.125 -0)	58.1400
1.5	(+.125 -0)	69.7680
1.75	(+.125 -0)	81.3960
2	(+.125 -0)	93.0240
2.5	(+.125 -0)	116.2800
3	(+.125 -0)	139.5360
4	(+.125 -0)	186.0480

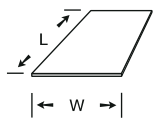

**C10100
OFE Copper Sheet & Coil
060 (soft anneal)**
ASTM F68

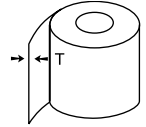

Thickness (Inches)	Thickness Tolerance	Shape	W x L (Inches)	Pounds Per Square Inch
0.02	(±.0035)	Sheet	36 x 96	0.9302
0.02	(±.0035)	Coil		0.9302
0.032	(±.004)	Sheet	36 x 96	1.4884
0.032	(±.004)	Coil		1.4884
0.04	(±.005)	Sheet	36 x 96	1.8605
0.04	(±.004)	Coil		1.8605
0.045	(±.004)	Coil		2.0930
0.05	(±.005)	Sheet	36 x 96	2.3256
0.062	(±.006)	Sheet	36 x 96	2.8837
0.064	(±.003)	Coil		2.9768
0.093	(±.007)	Sheet	36 x 96	4.3256
0.125	(±.007)	Sheet	36 x 96	5.8140
0.125	(±.006)	Coil		5.8140

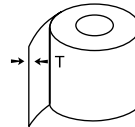

**C10200
OF Copper Coil
H02 (half-hard)**
ASTM B152

Manufactured to order in our plant from master coil.

Thickness (Inches)	Thickness Tolerance	Pounds Per Square Inch
0.020	(±.0018)	0.9302
0.025	(±.002)	1.1628
0.032	(±.002)	1.4884
0.050	(±.0025)	2.3256
0.064	(±.003)	2.9768
0.080	(±.0035)	3.7210
0.125	(±.0035)	5.8140

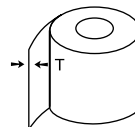

**C10200
OF Copper Coil
060 (soft anneal)**
ASTM B152

Thickness (Inches)	Thickness Tolerance	Pounds Per Square Inch
0.025	(±.00075)	1.1628
0.0315	(±.0005)	1.4651
0.032	(±.001)	1.4884
0.05	(±.001)	2.3256
0.064	(±.00125)	2.9768
0.08	(±.001)	3.7210
0.1	(±.002)	4.6512
0.114	(±.002)	5.3024
0.125	(±.002)	5.8140
0.15	(±.003)	6.9768



C11000 ETP Copper

Nominal Composition

Copper: 99.90% minimum

Oxygen: 0.04%

Physical Properties

Melting Point (Liquidus): 1,083°C (1,981°F)

Melting Point (Solidus): 1,065°C (1,949°F)

Density at 68°F: 0.321 lb/in³ - 0.323 lb/in³

Coefficient of Linear Expansion:
(per °F) 9.4 x 10⁻⁶ (68-212°F),
9.6 x 10⁻⁶ (68-392°F),
9.8 x 10⁻⁶ (68-572°F)

Electrical Conductivity at 68°F:
(volumetric) 100% IACS (in annealed
condition; lower in hard
temper)

Thermal Conductivity: 224 Btu/ft²/ft/hr/°F at 68°F

Modulus of Elasticity — Tension: 17,000 ksi

Modulus of Rigidity: 6,400 ksi

Fabrication Properties

Hot Working Temperature: 750-875°C (1,400-1,600°F)

Annealing Temperature: 475-750°C (900-1,400°F)

Approximate Relative Machinability: 20 (free cutting brass = 100)

Mechanical Properties

Wire	Tensile Strength (psi)	Yield Strength (0.5% Ext.) (psi)	% Elongation (in 2")	Rockwell Hardness
0.080" Dia. — 0.050 mm	35,000	—	35 (in 10")	—
0.080" Dia. — Hard	55,000	—	—	—
Flat Products	Tensile Strength (psi)	Yield Strength (0.5% Ext.) (psi)	% Elongation (in 2")	Rockwell Hardness
0.025" Size — 0.050 mm	32,000	10,000	50	HRF 40
0.025" Size — 1/8 Hard	36,000	28,000	40	HRF 60
0.025" Size — 1/4 Hard	38,000	30,000	35	HRF 70
0.025" Size — Hard	50,000	45,000	12	HRF 90
0.040" Size — 0.050 mm	32,000	10,000	45	HRF 40
0.040" Size — 0.025 mm	34,000	11,000	45	HRF 45
0.040" Size — 1/8 Hard	36,000	28,000	30	HRF 60
0.040" Size — 1/4 Hard	38,000	30,000	25	HRF 70
0.040" Size — 1/2 Hard	42,000	36,000	14	HRF 84
0.040" Size — Hard	50,000	45,000	6	HRF 90
1.0" Size — Hard	45,000	40,000	20	HRF 85

Description

Also called Electrolytic Tough Pitch (ETP) copper, C11000 has a minimum copper plus silver content of 99.90% with about 200-600 ppm (0.02-0.06%) oxygen present as cuprous oxide. This copper is noted for its high electrical and thermal conductivity, good corrosion resistance and solderability, and characteristic copper color.

When C11000 is exposed to the outdoors for long periods, it produces a relatively impervious protective film which eventually forms the familiar green patina of weathered copper. In most environments, its corrosion resistance is excellent to good, although it is not suitable for use with certain materials, for instance acetylene, ammonia, chromic acid, and nitric acid.

Hot Working

C11000 has excellent hot workability and is soft and ductile when heated to a red heat.

Cold Working

C11000 has excellent cold workability, having a high ductility only slightly lower than that of the most ductile brasses. With increasing amounts of cold work, it work hardens slowly, and therefore is capable of being worked extensively before annealing is required. For drastic operations like cold extrusion and drawing, the metal is usually supplied in the soft condition.

Where less drastic work is involved, light-drawn tempers are frequently used. The added stiffness of a light temper is advantageous in feeding

automatic machines such as cold-headers and for machining. Where highest strength and hardness are desired in the finished product, it is best to start with the hardest temper adaptable to the forming operations involved.

Joining and Fabrication

Joining by soldering is excellent, while good by brazing. Soldering can be done by all heating methods. Brazing in hydrogen-bearing atmospheres is not recommended due to potential hydrogen embrittlement in which the hydrogen combines with the oxygen to form water vapor. An inert or oxidizing atmosphere is best. Induction and salt-bath brazing are also suitable. Sound welds with good strength can usually be made with inert-gas arc welding, although these processes are generally not recommended for C11000 copper.

Applications

Applications are numerous, and include ball floats, building fronts, bus bars, wire conductors, contacts, cotter pins, downspouts, flashing, gaskets, gutters, kettles, nails, pans, printing rolls, radiators, radio parts, rivets, screening, soldering copper, switches, tacks, and terminals.

Applicable Specifications

When so specified, C11000 will be manufactured to the latest revision of the following specifications: ASTM Specifications B49, B124, B133, B187 for rod and shapes; ASTM B1, B2, B3, B8, B33, B47, B116, B172, B173, B174, B189, B226, B228, B229, B286, B298, B355, B470, and B496 for wire; and ASTM B152 for flat wire.

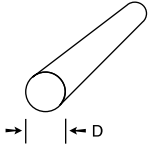

C11000 Round ETP Copper Wire 060 (soft anneal)

Supplied On Spools
ASTM B3

Diameter (Inches)	Diameter Tolerance	Gauge	Wire Form	Pounds Per Foot
0.0201	(±.0002)	24 Gauge	10# Spool	0.0012
0.0253	(±.0003)	22 Gauge	10# Spool	0.0019
0.032	(±.0003)	20 Gauge	10# Spool	0.0031
0.0403	(±.0004)	18 Gauge	12 Inch, 25# Spool	0.0049
0.0403	(±.0004)	18 Gauge	10# Spool	0.0049
0.0508	(±.0005)	16 Gauge	10# Spool	0.0076
0.064	(±.0006)	14 Gauge	50# Spool	0.0124
0.0641	(±.0006)	14 Gauge	10# Spool	0.0125
0.1019	(±.001)	10 Gauge	50# Spool	0.0315
0.1285	(±.0013)	8 Gauge	50# Spool	0.0501
0.25	(±.0025)	—	150# Coil	0.1896

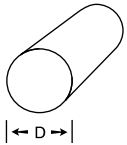

C11000 Round ETP Copper Rod H04 (hard)

12 Foot Mill Lengths
ASTM B187

Diameter (Inches)	Diameter Tolerance	Pounds Per Foot
0.125	(±.0013)	0.0474
0.1875	(±.0015)	0.1066
0.25	(±.0015)	0.1896
0.3125	(±.0015)	0.2962
0.375	(±.0015)	0.4265
0.4375	(±.0015)	0.5806
0.5	(±.0015)	0.7583
0.5625	(±.002)	0.9597
0.625	(±.002)	1.1849
0.6875	(±.002)	1.4337
0.75	(±.002)	1.7062
0.812	(±.002)	1.9999
0.8125	(±.002)	2.0024
0.875	(±.002)	2.3223
1	(±.002)	3.0332
1.125	(±.0025)	3.8389
1.25	(±.0025)	4.7394
1.375	(±.0025)	5.7347
1.5	(±.0025)	6.8248
1.625	(±.0025)	8.0096
1.75	(±.0025)	9.2893
1.875	(±.0025)	10.6637
2	(±.0025)	12.133
2.25	(±.003)	15.3558
2.375	(±.004)	17.1094
2.5	(±.004)	18.9578
2.75	(±.004)	22.9389
3	(±.005)	27.2992
3.25	(±.005)	32.0386
3.5	(±.005)	37.1572
4	(±.006)	48.5318
4.5	(±.007)	61.4231
5	(±.008)	75.831

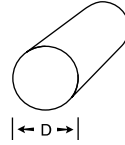

C11000 Round ETP Copper Rod Extruded M30 (as hot extruded)

12 Foot Mill Lengths
ASTM B124

Diameter (Inches)	Diameter Tolerance	Pounds Per Foot
4	(±.120)	48.5318
4.5	(±.120)	61.4231
5	(±.120)	75.831
5.5	(±.120)	91.7555
6	(±.120)	109.197

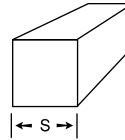

C11000 Square ETP Copper Bar H02 (half-hard) (Formerly H04)

12 Foot Mill Lengths
ASTM B187

Size (Inches)	Size Tolerance	Pounds Per Foot
0.375	(±.003)	0.5434
0.5	(±.003)	0.966
0.625	(±.004)	1.5094
0.75	(±.004)	2.1735
1	(±.004)	3.864
1.25	(±.0045)	6.0375
1.5	(±.0045)	8.694
2	(±.0045)	15.456
2.5	(±.025)	24.15
3	(±.005)	34.776



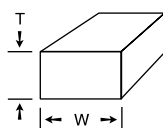

C11000
Rectangular ETP Copper Bar
Square Corner
H02 (half-hard) (Formerly H04)
 12 Foot Mill Lengths
 ASTM B187

Thickness (Inches)	Thickness Tolerance	Width (Inches)	Width Tolerance	Pounds Per Foot	Thickness (Inches)	Thickness Tolerance	Width (Inches)	Width Tolerance	Pounds Per Foot
0.0625	(±.003)	0.5	(±.008)	0.1208	0.25	(±.004)	3	(±.012)	2.898
0.0625	(±.003)	0.625	(±.008)	0.1509	†0.25	(±.004)	3	(±.012)	2.898
0.0625	(±.003)	0.75	(±.008)	0.1811	0.25	(±.004)	3.25	(±.012)	3.1395
0.0625	(±.003)	1	(±.008)	0.2415	0.25	(±.004)	3.5	(±.012)	3.381
‡0.093	(±.002)	0.5	(±.005)	0.1797	‡0.25	(±.004)	4	(±.012)	3.864
‡0.093	(±.002)	0.625	(±.005)	0.2246	0.25	(±.004)	4	(±.012)	3.864
‡0.093	(±.002)	0.75	(±.005)	0.2695	0.25	(±.0045)	5	(±.015)	4.83
0.0937	(±.003)	0.5	(±.008)	0.181	0.25	(±.0045)	6	(±.018)	5.796
0.125	(±.003)	0.375	(±.008)	0.1811	0.25	(±.0045)	8	(±.024)	7.728
0.125	(±.003)	0.5	(±.008)	0.2415	0.3125	(±.003)	0.75	(±.008)	0.9056
0.125	(±.003)	0.625	(±.008)	0.3019	0.3125	(±.003)	1	(±.008)	1.2075
0.125	(±.003)	0.75	(±.008)	0.3623	0.3125	(±.003)	1.25	(±.008)	1.5094
0.125	(±.003)	1	(±.008)	0.483	0.3125	(±.003)	1.5	(±.008)	1.8113
0.125	(±.003)	1.25	(±.008)	0.6038	0.3125	(±.003)	2	(±.008)	2.415
0.125	(±.003)	1.5	(±.008)	0.7245	0.3125	(±.003)	3	(±.008)	3.6225
0.125	(±.003)	1.75	(±.008)	0.8453	0.3125	(±.004)	3.5	(±.012)	4.2263
0.125	(±.003)	2	(±.008)	0.966	0.3125	(±.004)	4	(±.012)	4.83
0.125	(±.004)	2.25	(±.012)	1.0868	0.375	(±.003)	0.5	(±.008)	0.7245
0.125	(±.004)	2.5	(±.012)	1.2075	0.375	(±.003)	0.75	(±.008)	1.0868
0.125	(±.004)	3	(±.012)	1.449	0.375	(±.003)	1	(±.008)	1.449
0.125	(±.004)	4	(±.012)	1.932	0.375	(±.003)	1.25	(±.008)	1.8113
0.125	(±.0045)	5	(±.015)	2.415	0.375	(±.003)	1.5	(±.008)	2.1735
0.125	(±.0045)	6	(±.018)	2.898	0.375	(±.003)	1.75	(±.008)	2.5358
0.1875	(±.003)	0.5	(±.008)	0.3623	0.375	(±.003)	2	(±.008)	2.898
0.1875	(±.003)	0.625	(±.008)	0.4528	0.375	(±.004)	2.5	(±.012)	3.6225
0.1875	(±.003)	0.75	(±.008)	0.5434	0.375	(±.004)	3	(±.012)	4.347
0.1875	(±.003)	0.875	(±.008)	0.6339	0.375	(±.004)	3.5	(±.012)	5.0715
0.1875	(±.003)	1	(±.008)	0.7245	0.375	(±.004)	4	(±.012)	5.796
0.1875	(±.003)	1.25	(±.008)	0.9056	0.375	(±.0045)	5	(±.015)	7.245
0.1875	(±.003)	1.5	(±.008)	1.0868	0.375	(±.0045)	6	(±.018)	8.694
0.1875	(±.003)	1.75	(±.008)	1.2679	0.375	(±.0045)	8	(±.024)	11.592
0.1875	(±.003)	2	(±.008)	1.449	0.5	(±.003)	0.75	(±.008)	1.449
0.1875	(±.004)	2.5	(±.012)	1.8113	0.5	(±.003)	1	(±.008)	1.932
0.1875	(±.004)	3	(±.012)	2.1735	0.5	(±.003)	1.25	(±.008)	2.415
0.1875	(±.004)	3.5	(±.012)	2.5358	0.5	(±.003)	1.5	(±.008)	2.898
0.1875	(±.004)	4	(±.012)	2.898	0.5	(±.003)	1.75	(±.008)	3.381
0.1875	(±.0045)	6	(±.018)	4.347	0.5	(±.003)	2	(±.008)	3.864
0.188	(±.004)	3.75	(+.020 -0)	2.7241	0.5	(±.004)	2.5	(±.012)	4.83
0.25	(±.003)	0.375	(±.008)	0.3623	0.5	(±.004)	3	(±.012)	5.796
0.25	(±.003)	0.5	(±.008)	0.483	0.5	(±.004)	3.125	(±.012)	6.0375
0.25	(±.003)	0.625	(±.008)	0.6038	0.5	(±.004)	3.5	(±.012)	6.762
0.25	(±.003)	0.75	(±.008)	0.7245	0.5	(±.004)	4	(±.012)	7.728
0.25	(±.003)	0.875	(±.008)	0.8453	0.5	(±.0045)	5	(±.015)	9.66
0.25	(±.003)	1	(±.008)	0.966	0.5	(±.0045)	5.5	(±.015)	10.626
0.25	(±.003)	1.25	(±.008)	1.2075	0.5	(±.0045)	6	(±.018)	11.592
*0.25	(±.003)	1.25	(±.008)	1.2075	0.5	(±.0045)	8	(±.024)	15.456
0.25	(±.003)	1.5	(±.008)	1.449	0.625	(±.004)	1	(±.008)	2.415
0.25	(±.003)	1.75	(±.008)	1.6905	0.625	(±.004)	1.5	(±.008)	3.6255
0.25	(±.003)	2	(±.008)	1.932	0.625	(±.004)	2	(±.008)	4.83
‡0.25	(±.003)	2	(±.008)	1.932	0.625	(±.0045)	2.5	(±.012)	6.0375
0.25	(±.004)	2.25	(±.012)	2.1735	0.625	(±.0045)	3	(±.012)	7.245
0.25	(±.004)	2.5	(±.012)	2.415	0.625	(±.0045)	4	(±.012)	9.66

*Silver Flash
 †Tinned
 ‡ASTM B152

Continued next page

Continued from previous page

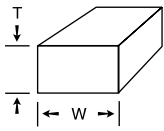

C11000
Rectangular ETP Copper Bar
Square Corner
H02 (half-hard) (Formerly H04)
 12 Foot Mill Lengths
 ASTM B187

Thickness (Inches)	Thickness Tolerance	Width (Inches)	Width Tolerance	Pounds Per Foot
0.625	(±.005)	5	(±.015)	12.075
0.625	(±.005)	6	(±.018)	14.49
0.75	(±.004)	1	(±.008)	2.898
0.75	(±.004)	1.25	(±.008)	3.6225
0.75	(±.004)	1.5	(±.008)	4.347
0.75	(±.004)	1.75	(±.008)	5.0715
0.75	(±.004)	2	(±.008)	5.796
0.75	(±.0045)	2.5	(±.012)	7.245
0.75	(±.0045)	3	(±.012)	8.694
0.75	(±.0045)	3.5	(±.012)	10.143
0.75	(±.0045)	4	(±.012)	11.592
0.75	(±.005)	5	(±.015)	14.49
0.75	(±.005)	6	(±.018)	17.388
0.75	(±.005)	8	(±.024)	23.184
0.875	(±.004)	1.75	(±.008)	5.9168
1	(±.004)	1.25	(±.008)	4.83
1	(±.004)	1.5	(±.008)	5.796
1	(±.004)	1.75	(±.008)	6.762
1	(±.004)	2	(±.008)	7.728
1	(±.0045)	2.5	(±.012)	9.66
1	(±.0045)	3	(±.012)	11.592
1	(±.0045)	3.5	(±.012)	13.524
1	(±.0045)	4	(±.012)	15.456
1	(±.005)	5	(±.015)	19.32
1	(±.005)	6	(±.018)	23.184
1.0625	(±.0045)	1.125	(±.008)	4.6187
1.25	(±.0045)	1.5	(±.008)	7.245
1.25	(±.0045)	2	(±.008)	9.66
1.25	(±.005)	2.5	(±.012)	12.075
1.25	(±.005)	3	(±.012)	14.49
1.25	(±.005)	3.5	(±.012)	16.905
1.25	(±.005)	4	(±.012)	19.32
1.25	(±.006)	5	(±.015)	24.15
1.25	(±.006)	6	(±.018)	28.98
1.5	(±.0045)	2	(±.008)	11.592
1.5	(±.005)	2.5	(±.012)	14.49
1.5	(±.005)	3	(±.012)	17.388
1.5	(±.005)	3.5	(±.012)	20.286
1.5	(±.005)	4	(±.012)	23.184
1.5	(±.006)	5	(±.015)	28.98
1.5	(±.006)	6	(±.018)	34.776
1.75	(±.005)	2.5	(±.012)	16.905
2	(±.005)	2.5	(±.012)	19.32
2	(±.005)	3	(±.012)	23.184
2	(±.005)	4	(±.012)	30.912
2	(±.006)	5	(±.018)	38.64
2.5	(±.006)	3	(±.012)	28.98
2.5	(±.006)	4	(±.012)	38.64

*Silver Flash
 †Tinned
 ‡ASTM B152

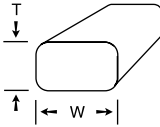

C11000
Rectangular ETP Copper Bar
Rounded Corner (0.062 Radius)
H02 (half-hard) (Formerly H04)
 12 Foot Mill Lengths
 ASTM B187

Thickness (Inches)	Thickness Tolerance	Width (Inches)	Width Tolerance	Pounds Per Foot
0.25	(±.003)	0.75	(±.008)	0.7245
*0.25	(±.003)	1.5	(±.008)	1.449
0.25	(±.003)	1.625	(±.008)	1.5698
0.25	(±.003)	2	(±.008)	1.932
*0.25	(±.003)	4	(±.008)	3.864
0.3125	(±.003)	1	(±.008)	1.2075
0.375	(±.003)	1	(±.008)	1.449
0.375	(±.003)	2.5	(±.008)	3.6225
*0.375	(±.003)	3	(±.008)	4.347
0.5	(±.003)	1	(±.008)	1.932
0.5	(±.003)	2	(±.008)	3.854

*Tinned

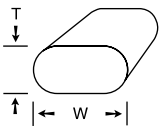

C11000
Rectangular ETP Copper Bar
Full Rounded Edge
Tinned Surface (.0002 In. min.)
H02 (half-hard) (Formerly H04)
 12 Foot Mill Lengths
 ASTM B187

Thickness (Inches)	Thickness Tolerance	Width (Inches)	Width Tolerance	Pounds Per Foot
0.125	(±.003)	2	(±.008)	0.953
0.125	(±.003)	3	(±.008)	1.449
0.125	(±.003)	4	(±.008)	1.932
0.25	(±.003)	1	(±.008)	0.9141
0.25	(±.003)	1.25	(±.008)	1.1556
0.25	(±.003)	1.5	(±.008)	1.4083
0.25	(±.003)	2	(±.008)	1.8801
0.25	(±.004)	2.5	(±.012)	2.3631
0.25	(±.004)	3	(±.012)	2.8461
0.25	(±.004)	3.5	(±.012)	3.3291
0.25	(±.004)	4	(±.012)	3.8121
0.25	(±.0045)	5	(±.015)	4.7781
0.25	(±.0045)	6	(±.018)	5.7441
0.25	(±.0045)	8	(±.024)	7.6761
0.375	(±.003)	1	(±.008)	1.449
0.375	(±.003)	1.5	(±.008)	2.0567
0.375	(±.003)	2	(±.008)	2.898
0.375	(±.004)	3	(±.012)	4.347
0.375	(±.004)	4	(±.012)	5.796
0.375	(±.0045)	5	(±.015)	7.245
0.375	(±.0045)	6	(±.018)	8.694
0.375	(±.0045)	8	(±.024)	11.592
0.5	(±.003)	1.5	(±.008)	2.898
0.5	(±.003)	2	(±.008)	3.6563
0.5	(±.004)	3	(±.012)	5.796
0.5	(±.004)	4	(±.012)	7.728
0.5	(±.0045)	6	(±.018)	11.592



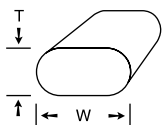

C11000
Rectangular ETP Copper Bar
Full Rounded Edge
H02 (half-hard) (Formerly H04)
 12 Foot Mill Lengths
 ASTM B187

Thickness (Inches)	Thickness Tolerance	Width (Inches)	Width Tolerance	Pounds Per Foot
0.125	(±.003)	0.625	(±.008)	0.2889
0.125	(±.003)	0.75	(±.008)	0.3493
0.125	(±.003)	1	(±.008)	0.47
0.125	(±.003)	1.5	(±.008)	0.7115
0.125	(±.003)	2	(±.008)	0.953
0.125	(±.004)	3	(±.012)	1.42
0.1875	(±.003)	0.75	(±.008)	0.5434
0.1875	(±.003)	1	(±.008)	0.6953
0.1875	(±.003)	1.25	(±.008)	0.8764
0.1875	(±.003)	1.5	(±.008)	1.0575
0.1875	(±.003)	1.75	(±.008)	1.2679
0.1875	(±.003)	2	(±.008)	1.419
0.1875	(±.004)	2.5	(±.012)	1.782
0.1875	(±.004)	3	(±.012)	2.1442
0.1875	(±.004)	3.75	(±.012)	2.7169
0.25	(±.003)	0.75	(±.008)	0.6728
0.25	(±.003)	1	(±.008)	0.9141
0.25	(±.003)	1.25	(±.008)	1.1556
0.25	(±.003)	1.5	(±.008)	1.3971
0.25	(±.003)	1.75	(±.008)	1.6386
0.25	(±.003)	2	(±.008)	1.8801
0.25	(±.004)	2.5	(±.012)	2.3631
0.25	(±.004)	3	(±.012)	2.8461
0.25	(±.004)	4	(±.012)	3.8121
0.25	(±.0045)	5	(±.015)	4.7781
0.25	(±.0045)	6	(±.018)	5.7441
0.25	(±.0045)	8	(±.024)	7.6761
0.375	(±.003)	1	(±.008)	1.3321
0.375	(±.003)	1.25	(±.008)	1.6944
0.375	(±.003)	1.5	(±.008)	2.0567
0.375	(±.003)	1.75	(±.008)	2.5358
0.375	(±.003)	2	(±.008)	2.7812
0.375	(±.004)	2.5	(±.012)	3.5057
0.375	(±.004)	3	(±.012)	4.2302
0.375	(±.004)	4	(±.012)	5.6792
0.375	(±.0045)	5	(±.015)	7.1281
0.375	(±.0045)	6	(±.018)	8.5772
0.5	(±.003)	2	(±.008)	3.864
0.5	(±.004)	3	(±.012)	5.796
0.5	(±.004)	4	(±.012)	7.728
0.5	(±.0045)	4.5	(±.014)	8.694
0.5	(±.0045)	5	(±.015)	9.66
0.5	(±.0045)	6	(±.018)	11.592
0.625	(±.0045)	3	(±.012)	7.26
0.625	(±.0045)	4	(±.012)	9.66
0.75	(±.0045)	4	(±.012)	11.592

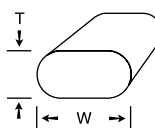

C11000
Rectangular ETP Copper Bar
Full Rounded Edge
Silver Flash Surface (.000001 In. min.)
H02 (half-hard) (Formerly H04)
 12 Foot Mill Lengths
 ASTM B187

Thickness (Inches)	Thickness Tolerance	Width (Inches)	Width Tolerance	Pounds Per Foot
0.1875	(±.003)	1	(±.008)	0.6953
0.1875	(±.003)	1.5	(±.008)	1.0575
0.25	(±.003)	0.5	(±.008)	0.483
0.25	(±.003)	0.625	(±.008)	0.6038
0.25	(±.003)	0.75	(±.008)	0.6726
0.25	(±.003)	1	(±.008)	0.9141
0.25	(±.003)	1.25	(±.008)	1.1556
0.25	(±.003)	1.5	(±.008)	1.3971
0.25	(±.003)	1.75	(±.008)	1.6905
0.25	(±.003)	2	(±.008)	1.8801
0.25	(±.004)	2.5	(±.012)	2.4225
0.25	(±.004)	3	(±.012)	2.8461
0.25	(±.004)	3.25	(±.012)	3.1395
0.25	(±.004)	3.5	(±.012)	3.3291
0.25	(±.004)	4	(±.012)	3.8121
0.25	(±.0045)	5	(±.015)	4.7781
0.25	(±.0045)	6	(±.018)	5.796
0.25	(±.0045)	8	(±.024)	7.6761
0.375	(±.003)	1.5	(±.008)	2.0567
0.375	(±.003)	2	(±.008)	2.7811
0.375	(±.004)	2.5	(±.012)	3.5057
0.375	(±.004)	3	(±.012)	4.2301
0.375	(±.004)	4	(±.012)	5.6792
0.375	(±.0045)	5	(±.015)	7.1281
0.375	(±.0045)	6	(±.018)	8.694
0.5	(±.003)	1.25	(±.008)	2.415
0.5	(±.003)	2	(±.008)	3.864
0.5	(±.004)	3	(±.012)	5.6057
0.5	(±.004)	4	(±.012)	7.5203
0.5	(±.0045)	5	(±.015)	9.66
0.5	(±.0045)	6	(±.018)	11.592

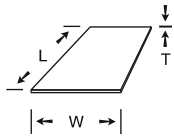

C11000
ETP Copper Sheet
Cold Rolled
1/8-1/4 Hard
 ASTM B152

Thickness (Inches)	Thickness Tolerance	W x L (Inches)	Pounds Per Square Foot
20 Oz, 0.0270	(±.004)	36 x 96	1.2480
36 Oz, 0.0480	(±.005)	36 x 96	2.2188
0.0625	(±.006)	36 x 96	2.8890
0.0640	(±.006)	36 x 96	2.9583
0.0647	(±.006)	36 x 120	2.9907
0.0800	(±.007)	36 x 96	3.6979
0.0937	(±.007)	36 x 96	4.3312
0.1250	(±.007)	36 x 96	5.7780
0.1875	(±.008)	36 x 96	8.6670
0.2500	(±.012)	36 x 120	11.5560

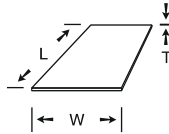

C11000
ETP Copper Sheet & Coil
H02 (half-hard)
 ASTM B152

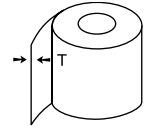

Thickness (Inches)	Thickness Tolerance	Shape	W x L (Inches)	Pounds Per Square Foot
0.0100	(±.0004)	Coil		0.4622
0.0160	(±.0005)	Coil		0.7396
0.0200	(±.0035)	Sheet	36 x 96	0.9245
0.0200	(±.00065)	Coil		0.9245
0.0250	(±.0035)	Sheet	36 x 96	1.1556
0.0250	(±.00075)	Coil		1.1556
0.0300	(±.001)	Coil		1.3867
0.0315	(±.0005)	Coil		1.4561
0.0320	(±.0035)	Sheet	24 x 96	1.4792
0.0320	(±.004)	Sheet	36 x 96	1.4792
0.0320	(±.005)	Sheet	48 x 120	1.4792
0.0320	(±.001)	Coil		1.4792
0.0400	(±.005)	Sheet	36 x 96	1.8490
0.0400	(±.001)	Coil		1.8490
0.0500	(±.005)	Sheet	36 x 96	2.3112
0.0500	(±.001)	Coil		2.3112
0.0600	(±.005)	Sheet	36 x 96	2.7734
0.0620	(±.006)	Sheet	36 x 96	2.8659
0.0620	(±.001)	Coil		2.8659
0.0620	(±.00125)	Coil		2.8659
0.0640	(±.00125)	Coil		2.9583
0.0780	(±.0015)	Coil		3.6055
0.0800	(±.007)	Sheet	36 x 96	3.6979
0.0800	(±.003)	Coil		3.6979
0.0930	(±.007)	Sheet	36 x 96	4.2988
0.0930	(±.008)	Sheet	48 x 120	4.2988
0.0930	(±.0015)	Coil		4.2988
0.0940	(±.003)	Coil		4.3451
0.1250	(±.007)	Sheet	36 x 96	5.7780
0.1250	(±.003)	Coil		5.7780
0.1560	(±.008)	Sheet	36 x 96	7.2109
0.1560	(±.0025)	Coil		7.2109
0.1870	(±.008)	Sheet	36 x 96	8.6439

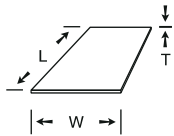

ASTM B370
Roofing Architectural Copper
Sheet & Coil
H00 (eighth-hard)
 ASTM B370

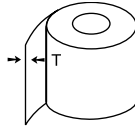

Thickness (Inches)	Thickness Tolerance	Shape	W x L (Inches)	Pounds Per Square Foot
12 Oz, 0.0160	(±.0012)	Sheet	36 x 120	0.7396
12 Oz, 0.0160	(±.0012)	Sheet	36 x 96	0.7396
16 Oz, 0.0216	(±.0012)	Sheet	24 x 120	0.9984
16 Oz, 0.0216	(±.0012)	Sheet	36 x 120	0.9984
16 Oz, 0.0216	(±.0012)	Sheet	36 x 96	0.9984
16 Oz, 0.0216	(±.0012)	Coil		0.9984
20 Oz, 0.0270	(±.0012)	Sheet	36 x 120	1.2480
20 Oz, 0.0270	(±.0012)	Sheet	36 x 96	1.2480
20 Oz, 0.0270	(±.0012)	Coil		1.2480
24 Oz, 0.0323	(±.0015)	Sheet	36 x 120	1.4930
24 Oz, 0.0323	(±.0015)	Sheet	36 x 96	1.4930
24 Oz, 0.0323	(±.0015)	Coil		1.4930
32 Oz, 0.0431	(±.0020)	Sheet	36 x 120	1.9923
32 Oz, 0.0431	(±.0020)	Sheet	36 x 96	1.9923

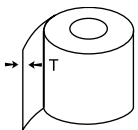

C11000
ETP Copper Coil
H01 (quarter-hard)
 ASTM B152

Thickness (Inches)	Thickness Tolerance	Pounds Per Square Foot
0.0200	(±.00065)	0.9245
0.0640	(±.00125)	2.9583
0.0800	(±.0015)	3.6979
0.0930	(±.002)	4.2988
0.1250	(±.003)	5.7780



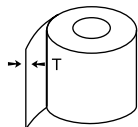

**C11000
ETP Copper Coil
Cold Rolled Annealed
O60 (soft anneal)**
ASTM B152

Thickness (Inches)	Thickness Tolerance	Pounds Per Square Foot
0.005	(±.0002)	0.2311
*0.005	(±.0002)	0.2311
0.007	(±.0003)	0.3236
0.008	(±.0003)	0.3698
0.009	(±.0003)	0.416
0.009	(±.0005)	0.416
0.01	(±.0004)	0.4622
0.012	(±.0004)	0.5547
0.013	(±.0005)	0.6009
0.0142	(±.0005)	0.6564
0.015	(±.0005)	0.6934
0.016	(±.0005)	0.7396
0.017	(±.0005)	0.7858
0.018	(±.0005)	0.832
0.0185	(±.00065)	0.8551
0.02	(±.00065)	0.9245
0.0216	(±.0008)	0.9984
0.0226	(±.00075)	1.0447
0.025	(±.00075)	1.1556
0.028	(±.001)	1.2943
0.03	(±.0005)	1.3867
0.03	(±.001)	1.3867
0.032	(±.001)	1.4792
0.035	(±.001)	1.6178
0.036	(±.001)	1.6641
0.04	(±.001)	1.849
0.043	(±.001)	1.9876
0.045	(±.001)	2.0801
0.05	(±.001)	2.3112
0.062	(±.00125)	2.8659
0.064	(±.00125)	2.9583
0.072	(±.0015)	3.3281
0.08	(±.0015)	3.6979
0.093	(±.0015)	4.2988
0.1	(±.003)	4.6224
0.125	(±.003)	5.778

*Tinned

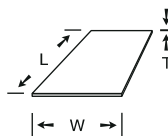

**C11000
ETP Copper Sheet
O60 (soft anneal)**
ASTM B152

Thickness (Inches)	Thickness Tolerance	W x L (Inches)	Pounds Per Square Foot
0.0216, 16 Oz	(±.0035)	36 x 120	0.9984
0.0216, 16 Oz	(±.0035)	36 x 96	0.9984
0.027, 20 Oz	(±.004)	36 x 96	1.248
0.032	(±.004)	36 x 96	1.4792
0.0323, 24 Oz	(±.004)	36 x 96	1.493
0.04	(±.005)	36 x 96	1.849
0.0431, 32 Oz	(±.005)	36 x 96	1.9923
0.0485	(±.005)	36 x 96	2.2419
0.05	(±.005)	36 x 96	2.3112
0.0625	(±.006)	36 x 96	2.889
0.08	(±.007)	36 x 96	3.6979
0.0937	(±.007)	36 x 96	4.3312
0.125	(±.007)	36 x 96	5.778
0.156	(±.008)	36 x 96	7.2109
0.1875	(±.008)	36 x 96	8.667

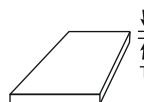

**C11000
ETP Copper Plate
Cold Rolled
H01 (quarter-hard)**
ASTM B152

Thickness (Inches)	Thickness Tolerance	Pounds Per Square Foot
0.25	(±.012)	11.5560
0.3125	(±.015)	14.4450
0.375	(±.015)	17.3340
0.5	(±.015)	23.1120
0.625	(±.019)	28.8900
0.75	(±.019)	34.6680
0.875	(±.024)	40.4460
1	(±.024)	46.2240

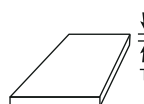

**C11000
ETP Copper Plate
M20 (as hot rolled)**
ASTM B152

Thickness (Inches)	Thickness Tolerance	Pounds Per Square Foot
1.25	(±.029)	57.7800
1.5	(±.029)	69.3360
1.75	(±.036)	80.8920
2	(±.036)	92.4480
2.5	(±.040)	115.5600
3	(±.040)	138.6720
3.5	(±.040)	161.7840
4	(±.040)	184.8960
5	(±.040)	231.1200

C12200 DHP Copper

Nominal Composition

Copper including silver: 99.90% minimum

Phosphorous: 0.015 – 0.040%

Physical Properties

Melting Point (Liquidus): 1,083°C (1,981°F)
 Melting Point (Solidus): 1,065°C (1,949°F)
 Density at 68°F: 0.323 lb/in³
 Coefficient of Linear Expansion: 9.4 x 10⁻⁶ (68-212°F),
 (per °F) 9.5 x 10⁻⁶ (68-392°F),
 9.8 x 10⁻⁶ (68-572°F)

Electrical Conductivity at 68°F: 85% IACS
 Thermal Conductivity: 196 Btu/ft²/ft/hr/°F at 68°F
 Modulus of Elasticity — Tension: 17,000 ksi
 Modulus of Rigidity: 6,400 ksi

Fabrication Properties

Hot Working Temperature: 750-875°C (1,400-1,600°F)
 Annealing Temperature: 375-650°C (700-1,200°F)
 Approximate Relative Machinability: 20 (free cutting brass = 100)

Mechanical Properties

Flat Products	Tensile Strength (psi)	Yield Strength (0.5% Ext.) (psi)	% Elongation (in 2")	Rockwell Hardness
0.040" Size — 1/8 Hard	36,000	28,000	30	HRF 60
0.040" Size — 1/4 Hard	38,000	30,000	25	HRF 70
0.040" Size — 1/2 Hard	42,000	36,000	14	HRF 84
0.040" Size — Hard	50,000	45,000	6	HRF 90
1.0" Size — Hard	45,000	40,000	20	HRF 85
Tube & Pipe				
0.75" SPS — Hard (30%)	50,000	45,000	10	HRF 90
1.0" OD x 0.065" — 0.050 mm	32,000	10,000	45	HRF 40
1.0" OD x 0.065" — 0.025 mm	34,000	11,000	45	HRF 45
1.0" OD x 0.065" — Light Drawn (15%)	40,000	32,000	25	HRF 77
1.0" OD x 0.065" — Hard Drawn (40%)	55,000	50,000	8	HRF 95

Description

C12200 Deoxidized High Phosphorus (DHP) copper has almost exactly the same mechanical properties as the high purity copper alloys such as C11000. It has excellent deep drawing characteristics and resistance to pitting corrosion when exposed to severe weather and water environments.

C12200 has similar corrosion resistance to C11000. It provides excellent resistance to weathering and very good resistance to many chemicals. It is often used specifically for corrosion resistance. It is suitable for use with most waters, and can be used underground because it resists soil corrosion. It resists non-oxidizing mineral and organic acids, caustic solutions and saline solutions.

C12200 has been made weldable and brazeable by deoxidizing with phosphorus. It is widely used as flat products and tubing, especially where it is to be welded or brazed. Phosphorus significantly reduces the conductivity, which may go as low as 70% IACS, but also raises the softening temperature when work hardened and promotes fine grain size.

Hot Working

This alloy's capacity for being hot formed is rated as excellent.

Cold Working

The capacity for cold working this alloy is rated as excellent.

Common Fabrication Processes

Common fabrication processes include blanking, coining, drawing, etching, forming, bending and upsetting, hot forging and pressing, piercing and punching, roll threading and knurling, shearing, spinning, squeezing and swaging, and stamping.

Applications

Applications include tubes for hot and cold water, gas and heating installations, soil and waste pipes, storage tanks, cisterns and cylinders, rainwater goods, roofing, fascias, building facades, evaporators, heat exchangers, stills, vats, chemical equipment, and anodes for electroplating baths.

Applicable Specifications

When so specified, C12200 will be manufactured to the latest revision of the following ASTM specifications: B42, B68, B75, B88, and B280 for tube and pipe; and B152, B187, B5, and B379 for sheet, strip, plate, bar, and refinery shapes.



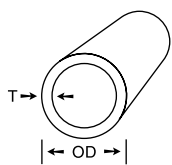

**C12200
Round DHP Copper
Extra Heavy Pipe
H80 (hard-drawn)**
20 Foot Lengths
ASTM B42

Nominal Pipe Size	OD (Inches)	Thickness (Inches)	Pounds Per Foot
.125	0.405	0.1	0.3714
.25	0.54	0.123	0.6246
1	1.315	0.182	2.511

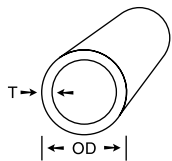

**C12200
Round DHP Copper
Standard Pipe Size
H80 (hard-drawn)**
20 Foot Lengths
ASTM B42

Nominal Pipe Size	OD (Inches)	Thickness (Inches)	Pounds Per Foot
.25	0.54	0.082	0.4573
.375	0.675	0.09	0.6411
.5	0.84	0.107	0.9551
.75	1.05	0.114	1.2993
1	1.315	0.126	1.8243
2	2.375	0.156	4.2153

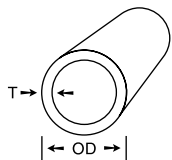

**C12200
Round DHP Copper Tube
Dehydrated & Sealed
O60 (soft anneal)**
50 Foot Coils
ASTM B280

OD (Inches)	OD Tolerance	Thickness (Inches)	Thickness Tolerance	Pounds Per Foot
0.125	(±.002)	0.03	(±.003)	0.0347
0.1875	(±.002)	0.03	(±.003)	0.0575
0.25	(±.002)	0.03	(±.003)	0.0804
0.5	(±.002)	0.032	(±.003)	0.1824

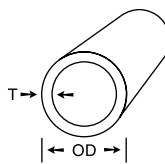

**C12200
Round DHP Copper Tube
O60 (soft anneal)**
50 Foot Coils
ASTM B68

OD (Inches)	OD Tolerance	Thickness (Inches)	Thickness Tolerance	Wire Form	Pounds Per Foot
0.1562	(±.002)	0.032	(±.0025)	50Ft Coil	0.0484
0.25	(±.002)	0.035	(±.003)	50Ft Coil	0.0916
0.25	(±.002)	0.049	(±.003)	50Ft Coil	0.1199
0.25	(±.002)	0.065	(±.0035)	50Ft Coil	0.1464
0.375	(±.002)	0.032	(±.003)	50Ft Coil	0.1337
0.375	(±.002)	0.049	(±.003)	50Ft Coil	0.1945
0.375	(±.002)	0.065	(±.0035)	50Ft Coil	0.2454
0.5	(±.002)	0.032	(±.0025)	144 Inch Length	0.1824
0.5	(±.002)	0.049	(±.003)	50Ft Coil	0.2691
0.5	(±.002)	0.065	(±.0035)	50Ft Coil	0.3443
0.625	(±.002)	0.065	(±.0035)	50Ft Coil	0.4432
0.75	(±.0025)	0.065	(±.004)	50Ft Coil	0.5422

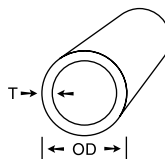

**C12200
Round DHP Copper Tube
H58 (drawn-general purpose)**
12 Foot Mill Lengths
ASTM B75

OD (Inches)	OD Tolerance	Thickness (Inches)	Thickness Tolerance	Pounds Per Foot
0.1875	(±.002)	0.032	(±.0025)	0.0606
0.25	(±.002)	0.035	(±.003)	0.0916
0.25	(±.002)	0.049	(±.003)	0.1199
0.25	(±.002)	0.065	(±.0035)	0.1464
0.3125	(±.002)	0.035	(±.003)	0.1183
0.3125	(±.002)	0.065	(±.0035)	0.1959
0.375	(±.002)	0.035	(±.003)	0.1449
0.375	(±.002)	0.049	(±.003)	0.1945
0.5	(±.002)	0.035	(±.003)	0.1982
0.5	(±.002)	0.065	(±.0035)	0.3443
0.625	(±.002)	0.035	(±.003)	0.2515
0.625	(±.002)	0.065	(±.0035)	0.4432
0.75	(±.0025)	0.035	(±.0035)	0.3047
0.75	(±.0025)	0.049	(±.0035)	0.4183
0.75	(±.0025)	0.065	(±.004)	0.5422
0.8125	(±.0025)	0.049	(±.0035)	0.4542
0.875	(±.0025)	0.065	(±.004)	0.6411
1	(±.0025)	0.035	(±.0035)	0.4113
1	(±.0025)	0.065	(±.004)	0.7401
1.125	(±.003)	0.065	(±.004)	0.839
1.375	(±.003)	0.065	(±.004)	1.0369
1.5	(±.003)	0.065	(±.004)	1.1358

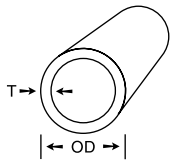

C12200 Round DHP Copper Tube O60 (soft anneal)
12 Foot Mill Lengths
ASTM B75

OD (Inches)	OD Tolerance	Thickness (Inches)	Thickness Tolerance	Pounds Per Foot
0.25	(±.002)	0.032	(±.0025)	0.0849
0.3125	(±.002)	0.032	(±.0025)	0.1093
0.375	(±.002)	0.032	(±.0025)	0.1337
0.5	(±.002)	0.032	(±.0025)	0.1824
0.5	(±.002)	0.049	(±.003)	0.2691
0.5	(±.002)	0.065	(±.0035)	0.3443
2.528	(±.004)	0.45	(±.027)	11.3868
8.125	(±.010)	0.271	(±.016)	25.9182

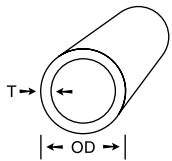

C12200 Round DHP Copper Tube H80 (hard-drawn)
12 Foot Mill Lengths
ASTM B75

OD (Inches)	OD Tolerance	Thickness (Inches)	Thickness Tolerance	Pounds Per Foot
1.75	(±.003)	0.025	(±.003)	0.5251
2.75	(±.004)	0.035	(±.005)	1.1535

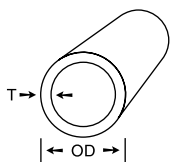

C12200 Round DHP Copper Tube H55 (light-drawn)
12 Foot Mill Lengths
ASTM B75

OD (Inches)	Thickness (Inches)	Pounds Per Foot
0.375	0.065	0.2454

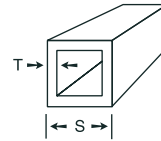

12200 Square DHP Copper Tube O60 (soft anneal)
50 Foot Coils
ASTM B75

Size (Inches)	Thickness (Inches)	Pounds Per Foot
0.1875	0.032	0.077
0.25	0.048	0.1499
0.3125	0.048	0.1963
0.375	0.048	0.2427
0.5	0.048	0.3355
0.5	0.062	0.42
0.625	0.125	0.9666

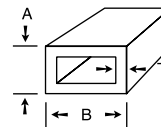

12200 Rectangular DHP Copper Tube O60 (soft anneal)
50 Foot Coils
ASTM B75

Dimension B (Inches)	Thickness (Inches)	Dimension A (Inches)	Pounds Per Foot
0.375	0.048	0.25	0.1968
0.5	0.048	0.25	0.2434
0.5	0.048	0.375	0.2899
0.5	0.065	0.375	0.3754
0.75	0.048	0.25	0.3364
0.75	0.048	0.375	0.3829
0.75	0.048	0.5	0.4294
1	0.048	0.25	0.4294
1	0.048	0.375	0.4759
1	0.048	0.5	0.5224

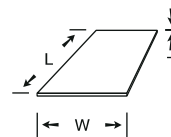

C12200 DHP Copper Sheet Cold Rolled
ASTM B370

Thickness (Inches)	W x L (Inches)	Pounds Per Square Foot
0.0216, 16 Oz	48 x 120	1.0047
0.027, 20 Oz	48 x 120	1.2558
0.064, 48 Oz	48 x 120	2.9768



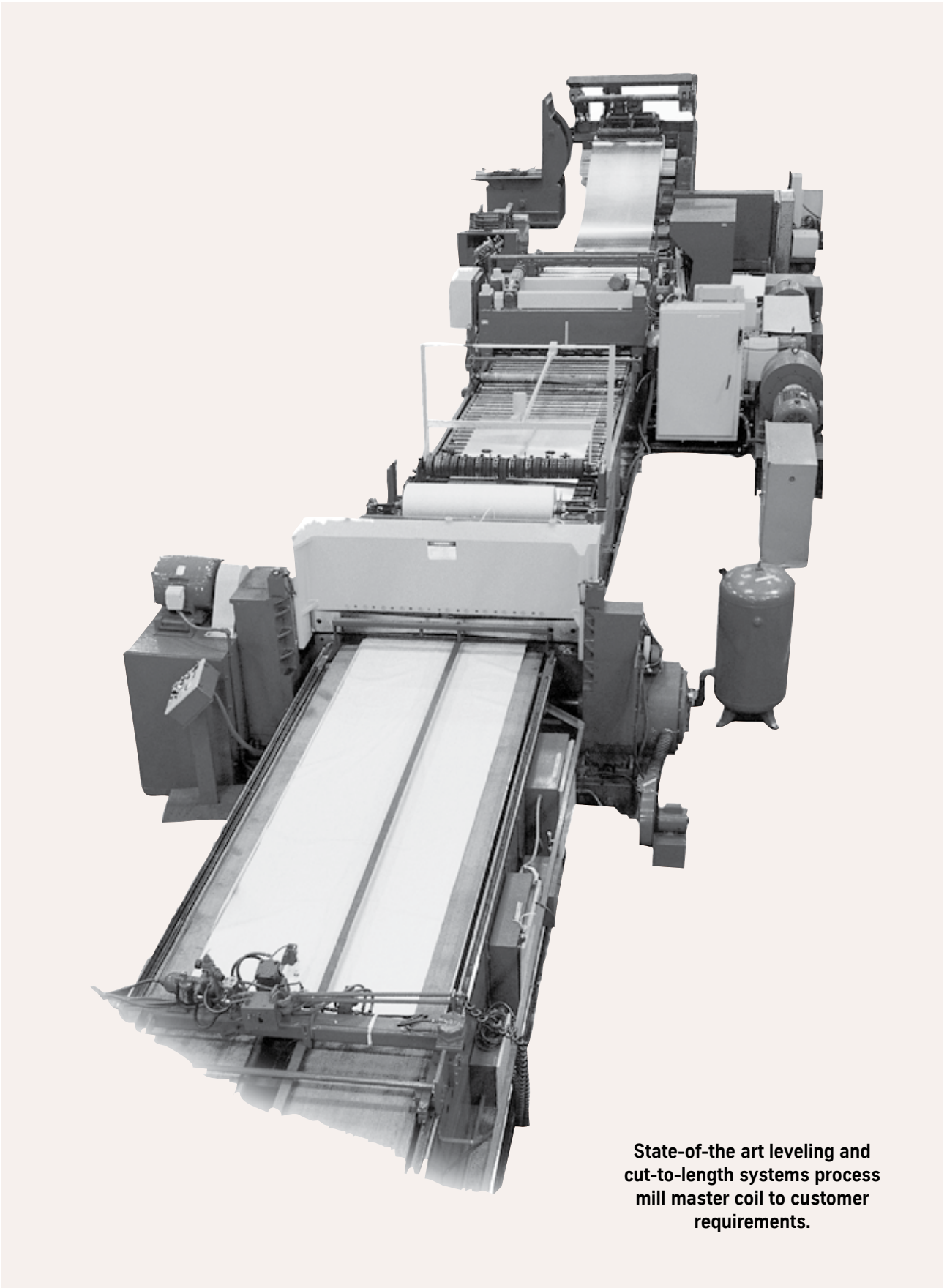

State-of-the art leveling and cut-to-length systems process mill master coil to customer requirements.

C14500 Tellurium Copper

Nominal Composition

Copper: 99.5%
Tellurium: 0.55%
Phosphorus: 0.008%

Physical Properties

Melting Point (Liquidus):	1,075°C (1,967°F)
Melting Point (Solidus):	1,051°C (1,924°F)
Density at 68°F:	0.323 lb/in ³
Coefficient of Linear Expansion: (per °F)	9.5 x 10 ⁻⁶ (68-212°F) 9.7 x 10 ⁻⁶ (68-329°F) 9.9 x 10 ⁻⁶ (68-572°F)
Electrical Conductivity at 68°F: (volumetric)	93% IACS (in the annealed condition; lower for hard temper)
Thermal Conductivity:	205 Btu/ft ² /ft/hr/°F at 68°F:
Modulus of Elasticity - Tension:	17,000 ksi
Modulus of Rigidity:	6,400 ksi

Fabrication Properties

Hot Working Temperature:	750-875°C (1,400-1,600°F)
Annealing Temperature:	420-650°C (800-1,200°F)
Approximate Relative Machinability:	85 (free cutting brass arbitrarily rated at 100)

Mechanical Properties

Rod	Tensile Strength (psi)	Yield Strength (0.5% Ext.) (psi)	% Elongation (in 2")	Rockwell Hardness
0.250" Dia. — Half Hard (20%)	43,000	40,000	18	HRB 43
0.250" Dia. — Hard (45%)	53,000	49,000	10	HRB 54
0.500" Dia. — 0.015 mm	33,000	11,000	46	HRF 43
0.500" Dia. — Half Hard (20%)	43,000	40,000	20	HRB 43
0.500" Dia. — Hard (35%)	48,000	44,000	15	HRB 48
1.000" Dia. — 0.050 mm	32,000	10,000	46	HRF 43
1.000" Dia. — Half Hard (20%)	42,000	40,000	25	HRB 42
1.000" Dia. — Hard (35%)	48,000	44,000	20	HRB 48
2.000" Dia. — Half Hard (15%)	42,000	39,000	35	HRB 42
Wire				
0.080" Dia. — 0.035 mm	33,000	11,000	40	—
0.080" Dia. — 1/8 Hard	38,000	30,000	20	—
0.080" Dia. — 1/2 Hard	51,000	41,000	6	—
0.080" Dia. — Hard	56,000	51,000	3	—

Description

Tellurium copper C14500 holds the answer to certain fabrication problems no other alloy has so satisfactorily solved. Its mechanical properties are similar to that of unalloyed, pure copper, yet its machinability rating of 85% is considerably higher than 20% for unalloyed coppers.

As the alloy cools from its liquid phase, tellurium precipitates out of the intermetallic compound Cu₂Te. This precipitate becomes finely dispersed throughout the matrix and assists in chip breakage during machining. The chips are short and brittle, easily freeing themselves from the tooling, so that rapid machining is thus permitted.

The alloy also maintains good corrosion resistance and excellent electrical conductivity.

Hot Working

Its capacity for being hot worked is good, requiring only moderate power. It has a hot forgeability rating of 65 (closed die only), with forging brass arbitrarily rated at 100. This quality, in particular, accounts for its use in forming closed-die hot forged products requiring high conductivity and good corrosion resistance. In the hard condition, it is not as readily softened by heat as the leaded coppers, thus permitting its use at relatively higher temperatures. It can be readily hot worked at temperatures higher than those tolerated by other free cutting coppers.

Cold Working

It also has good capacity for being cold worked though it offers slightly less ductility than pure copper for moderate cold heading capability.

Joining and Fabrication

Alloy C14500 is readily joined by brazing and soldering but has a fair rating for oxyacetylene and gas shielded arc welding, as well as resistance butt welding. Spot and seam resistance welding is not recommended.

Applications

Because of the exceptional free cutting properties inherent in C14500 it is well adapted for use in high-speed automatic screw machines. It cold heads well and is an outstanding alloy for the production of hot forged products requiring high conductivity and good corrosion resistance. It has also proved to be an excellent material for use in operations requiring furnace brazing and annealing in a reducing atmosphere where high conductivity and free machining must be maintained. During this operation, C14500 is not subject to hydrogen embrittlement.

Typical uses of C14500 are transformer and circuit-breaker terminals, hot forged studs, nuts and bolts, and current-carrying parts that require fine machine work and drilling. It is also used for welding torch tips, and marine and domestic hardware.

Applicable Specifications

When so specified, C14500 will be manufactured to the latest revision of ASTM B301.



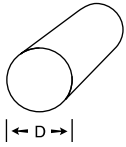

C14500
Round Tellurium Bearing Copper Rod
H02 (half-hard)

12 Foot Mill Lengths
 ASTM B249, ASTM B301

Diameter (Inches)	Diameter Tolerance	Pounds Per Foot
0.1875	(±.0015)	0.107
0.25	(±.0015)	0.1902
0.3125	(±.0015)	0.2971
0.375	(±.0015)	0.4279
0.4375	(±.0015)	0.5824
0.5	(±.0015)	0.7607
0.5625	(±.002)	0.9627
0.625	(±.002)	1.1885
0.6875	(±.002)	1.4381
0.75	(±.002)	1.7115
0.812	(±.002)	2.0086
0.875	(±.002)	2.3295
0.9375	(±.002)	2.675
1	(±.002)	3.0427
1.0625	(±.0025)	3.4402
1.125	(±.0025)	3.8509
1.25	(±.0025)	4.7542
1.3125	(±.0025)	5.2415
1.375	(±.0025)	5.7525
1.5	(±.0025)	6.846
1.625	(±.0025)	8.0345
1.75	(±.0025)	9.3181
1.875	(±.0025)	10.6969
2	(±.0025)	12.1706
2.125	(±.003)	13.7385
2.25	(±.003)	15.4035
2.5	(±.004)	19.0166
2.625	(±.004)	20.9658
2.75	(±.004)	23.0101
3	(±.005)	27.3839
3.25	(±.005)	32.1381
3.5	(±.005)	37.2726
4	(±.006)	48.6826

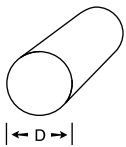

C14500
Round Tellurium Bearing Copper Rod
H04 (hard)

12 Foot Mill Lengths
 ASTM B301, ASTM B249

Diameter (Inches)	Diameter Tolerance	Pounds Per Foot
0.625	(±.002)	1.1885
0.75	(±.002)	1.7115
0.875	(±.002)	2.3295

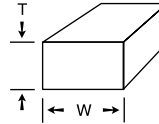

C14500
Rectangular Tellurium Bearing
Copper Bar, Square Corner
H04 (hard)

12 Foot Mill Lengths
 ASTM B301

Thickness (Inches)	Thickness Tolerance	Width (Inches)	Width Tolerance	Pounds Per Foot
0.25	(±.0045)	6	(±.018)	5.814
0.375	(±.004)	4	(±.012)	5.814
*0.75	(±.004)	2	(±.008)	5.814
1	(±.0045)	4	(±.012)	15.504
1	(±.005)	6	(±.018)	23.256
1.25	(±.006)	6	(±.018)	29.07
2	(±.005)	4	(±.012)	31.008
3	(±.009)	4	(±.012)	46.512
3	(±.009)	6	(±.018)	69.768

*H02 (half-hard)

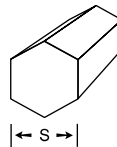

C14500
Hexagon Tellurium Bearing Copper Bar
H02 (half-hard)

12 Foot Mill Lengths
 ASTM B301

Size (Inches)	Size Tolerance	Pounds Per Foot
0.4375	(±.004)	0.643
0.5	(±.003)	0.8398
0.625	(±.004)	1.32
0.75	(±.004)	1.796

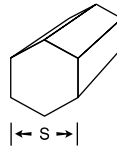

C14500
Hexagon Tellurium Bearing Copper Bar
H04 (hard)

12 Foot Mill Lengths
 ASTM B301

Size (Inches)	Size Tolerance	Pounds Per Foot
0.391	(±.004)	0.5136
0.5625	(±.004)	1.0629
0.669	(±.005)	1.5034
2.5	(±.40)	20.995

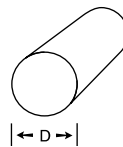

C14700
Round Sulfur Bearing Copper Rod
H02 (half-hard)

12 Foot Mill Lengths
 ASTM B301, ASTM B249

Diameter (Inches)	Diameter Tolerance	Pounds Per Foot
0.5	(±.0015)	0.7607
0.625	(±.002)	1.1885
0.75	(±.002)	1.7115
1.0	(±.002)	3.0427
1.375	(±.0025)	5.7525
1.5	(±.0025)	6.846
1.75	(±.0025)	9.3181

Alloy 25 Beryllium Copper (C17200)

Nominal Composition

Beryllium:	1.8-2.0%
Nickel:	0.2% min.
Nickel, cobalt and iron:	0.6% max.
Copper:	balance

Fabrication Properties

Cold Working:	Excellent
Hot Working:	Good
Hot Forgeability Rating (Forging Brass = 100%):	40%
Hot Working Temperature:	1,200-1,500°F
Annealing Temperature:	1,425-1,475°F
Machinability Rating (Free Cutting Brass = 100%):	20%

Suitability For Being Joined By

Soldering:	Good
Brazing:	Good
Oxyacetylene Welding:	Not Recommended
Gas Shielded Arc Welding:	Good
Coated Metal Arc Welding:	Good
Resistance Welding	
Spot:	Good
Seam:	Fair
Butt:	Fair

Physical Properties

Modulus of Elasticity:	19 x 10 ⁶ psi
Density:	0.302 lb/in ³
Poisson's Ratio:	0.3
Relative Magnetic Permeability:	< 1.01
Electrical Conductivity:	22-30% IACS
Thermal Conductivity:	60 BTU/ft/hr/°F at 70°F 75 BTU/ft/hr/°F at 200°F
Coefficient of Thermal Expansion:	9.7 x 10 ⁻⁶ /°F
Specific Heat (Heat Capacity):	0.086 BTU/lb/°F at 70°F 0.097 BTU/lb/°F at 200°F
Melting Range:	1,600 - 1,800 °F

Mechanical Properties

As supplied by producer:

Rod	Tensile Strength (psi)	Yield Strength (0.5% Ext.) (psi)	% Elongation (in 2")	Rockwell Hardness
All Dia. — A (Solution Heat Treated)	68,000	25,000	48	HRB 62
Up to 0.375" Dia. — H (hard)	112,000	90,000	15	HRB 95
0.375" to 1" Dia. — H (hard)	105,000	90,000	15	HRB 95
Over 1" Dia. — H (hard)	100,000	90,000	15	HRB 95

Description

Alloy 25 provides the highest strength of any copper beryllium alloy with electrical conductivity considerably greater than other high strength copper alloys. Since Alloy 25 is heat treated after forming, it provides excellent formability and ductility. It features good stress relaxation resistance and high fatigue strength. It is also non-magnetic and non-galling.

Applications

Alloy 25 is frequently used in electrical components, computer sockets and contacts, electromagnetic shielding gaskets, pressure sensor bellows, aerospace, and oil and gas applications.

Applicable Specifications

Rod and Bar: ASTM B196, MIL-C-21657, SAE J 461, SAE J 463, AMS 4533, AMS 4534, AMS 4650, AMS 4651, BMS 7-353 Type 2, RWMA Class 4, JIS H 3270, EN 1654, EN 2163, EN 12165, EN 12167, GB 5233, GB 4431

Tube: ASTM B251, B 643, MIL-C-21657, SAE J 461, SAE J 463, AMS 4535, BMS 7-353 Type 2, RWMA Class 4, JIS H 3270, EN 1654, EN 12163, EN 12165, EN 12167, GB 5233, GB 4431

Plate: ASTM B194, SAE J 461, SAE J 463, AMS 4530, AMS 4533, AMS 4534, AMS 4650, AMS 4651, RWMA Class 4, JIS H 3130





Alloy 25 Round Beryllium Copper Bar

Diameter (Inches)	Diameter Tolerance	Manufacturing Method	Temper	Pounds Per Foot	Specifications
0.125	(±.002)	Cold Drawn	H (TD04)	0.0445	AMS 4651, ASTM B196
0.1875	(±.002)	Cold Drawn	H (TD04)	0.1000	AMS 4651, ASTM B196
0.25	(±.002)	Cold Drawn	H (TD04)	0.1778	AMS 4651, ASTM B196
0.25	(±.002)	Cold Drawn	HT (TH04)	0.1788	AMS 4534, ASTM B196
0.3125	(±.002)	Cold Drawn	H (TD04)	0.2778	AMS 4651, ASTM B196
0.375	(±.002)	Cold Drawn	H (TD04)	0.4001	AMS 4651, ASTM B196
0.375	(±.002)	Cold Drawn	HT (TH04)	0.4001	ASTM B196, Oil Field
0.5	(±.002)	Cold Drawn	H (TD04)	0.7112	AMS 4651, ASTM B196
0.5	(±.002)	Cold Drawn	HT (TH04)	0.7112	ASTM B196, Oil Field
0.625	(±.003)	Cold Drawn	H (TD04)	1.1113	AMS 4651, ASTM B196
0.625	(±.003)	Cold Drawn	HT (TH04)	1.1113	ASTM B196, Oil Field
0.75	(±.003)	Cold Drawn	A (TB00)	1.6002	ASTM B196, AMS 4650
0.75	(±.003)	Cold Drawn	H (TD04)	1.6002	AMS 4651, ASTM B196
0.75	(±.003)	Cold Drawn	HT (TH04)	1.6002	AMS 4534, ASTM B196
0.75	(±.003)	Cold Drawn	HT (TH04)	1.6002	ASTM B196, Oil Field
0.875	(±.003)	Cold Drawn	H (TD04)	2.1781	AMS 4651, ASTM B196
0.875	(±.003)	Cold Drawn	HT (TH04)	2.1781	ASTM B196, Oil Field
1	(±.003)	Cold Drawn	AT (TF00)	2.8448	AMS 4533, ASTM B196
1	(±.003)	Cold Drawn	H (TD04)	2.8448	AMS 4651, ASTM B196
1	(±.003)	Cold Drawn	HT (TH04)	2.8448	AMS 4534, ASTM B196
1	(±.003)	Cold Drawn	HT (TH04)	2.8448	ASTM B196, Oil Field
1.125	(±.004)	Cold Drawn	AT (TF00)	3.6005	AMS 4533, ASTM B196
1.125	(±.004)	Cold Drawn	H (TD04)	3.6005	AMS 4651, ASTM B196
1.125	(±.004)	Cold Drawn	H (TD04)	3.6005	AMS 4651, ASTM B196
1.125	(±.004)	Cold Drawn	HT (TH04)	3.6005	AMS 4534, ASTM B196
1.125	(±.004)	Cold Drawn	HT (TH04)	3.6005	Baker Hughes Cu, 03
1.25	(±.004)	Cold Drawn	AT (TF00)	4.4451	AMS 4533, ASTM B196
1.25	(±.004)	Cold Drawn	H (TD04)	4.4451	AMS 4651, ASTM B196
1.25	(±.004)	Cold Drawn	HT (TH04)	4.4451	ASTM B196, Oil Field
1.25	(±.004)	Cold Drawn	HT (TH04)	4.4451	ASTM B196
1.375	(±.004)	Cold Drawn	H (TD04)	5.3785	AMS 4651, ASTM B196
1.375	(±.004)	Cold Drawn	HT (TH04)	5.3785	AMS 4534, ASTM B196
1.375	(±.004)	Cold Drawn	HT (TH04)	5.3785	ASTM B196, Oil Field
1.375	(±.004)	Cold Drawn	AT (TF00)	5.3785	ASTM B196, Oil Field
1.5	(±.004)	Cold Drawn	AT (TF00)	6.4009	AMS 4533, ASTM B196
1.5	(±.004)	Cold Drawn	H (TD04)	6.4009	AMS 4651, ASTM B196
1.5	(±.004)	Cold Drawn	HT (TH04)	6.4009	AMS 4534, ASTM B196
1.5	(±.004)	Cold Drawn	HT (TH04)	6.4009	ASTM B196, Oil Field
1.5	(±.004)	Cold Drawn	HT (TH04)	6.4009	Baker Hughes Cu, 03
1.5	(±.004)	Cold Drawn	HT (TH04)	6.4009	ASTM B196, Overage
1.625	(±.004)	Cold Drawn	AT (TF00)	7.5122	AMS 4533, ASTM B196
1.625	(±.004)	Cold Drawn	H (TD04)	7.5122	AMS 4651, ASTM B196
1.625	(±.004)	Cold Drawn	HT (TH04)	7.5122	AMS 4534, ASTM B196
1.625	(±.004)	Cold Drawn	HT (TH04)	7.5122	ASTM B196, Oil Field
1.625	(±.004)	Cold Drawn	HT (TH04)	7.5122	FMC 40101
1.75	(±.004)	Cold Drawn	AT (TF00)	8.7123	AMS 4533, ASTM B196
1.75	(±.004)	Cold Drawn	H (TD04)	8.7123	AMS 4651, ASTM B196
1.75	(±.004)	Cold Drawn	HT (TH04)	8.7123	AMS 4534, ASTM B196
1.75	(±.004)	Cold Drawn	HT (TH04)	8.7123	ASTM B196, Oil Field
1.75	(±.004)	Cold Drawn	AT (TF00)	8.7123	ASTM B196, Oil Field
1.75	(±.004)	Cold Drawn	AT (TF00)	8.7123	ASTM B196, Overage
1.75	(±.004)	Cold Drawn	HT (TH04)	8.7123	Baker Hughes Cu, 03
1.875	(±.004)	Cold Drawn	AT (TF00)	10.0014	AMS 4533, ASTM B196

Continued next page

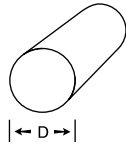

Continued from previous page

Alloy 25 Round Beryllium Copper

Diameter (Inches)	Diameter Tolerance	Manufacturing Method	Temper	Pounds Per Foot	Specifications
1.875	(±.004)	Cold Drawn	H (TD04)	10.0014	AMS 4651, ASTM B196
1.875	(±.004)	Cold Drawn	HT (TH04)	10.0014	AMS 4534, ASTM B196
1.875	(±.004)	Cold Drawn	HT (TH04)	10.0014	FMC M40003
1.875	(±.004)	Cold Drawn	HT (TH04)	10.0014	ASTM B196, Oil Field
1.875	(±.004)	Cold Drawn	AT (TF00)	10.0014	ASTM B196, Oil Field
2	(±.004)	Cold Drawn	A (TB00)	11.3794	ASTM B196, AMS 4650
2	(±.004)	Cold Drawn	AT (TF00)	11.3794	AMS 4533, ASTM B196
2	(±.004)	Cold Drawn	H (TD04)	11.3794	AMS 4651, ASTM B196
2	(±.004)	Cold Drawn	HT (TH04)	11.3794	AMS 4534, ASTM B196
2	(±.004)	Cold Drawn	HT (TH04)	11.3794	FMC M40003
2	(±.004)	Cold Drawn	HT (TH04)	11.3794	ASTM B196, Oil Field
2	(±.004)	Cold Drawn	HT (TH04)	11.3794	Baker Hughes Cu, 03
2.125	(±.004)	Cold Drawn	AT (TF00)	12.8462	ASTM B196, Oil Field
2.25	(±.0045)	Cold Drawn	AT (TF00)	14.4020	AMS 4533, ASTM B196
2.25	(±.0045)	Cold Drawn	H (TD04)	14.4020	AMS 4651, ASTM B196
2.25	(±.0045)	Cold Drawn	HT (TH04)	14.4020	AMS 4534, ASTM B196
2.25	(±.0045)	Cold Drawn	HT (TH04)	14.4020	FMC M40003
2.25	(±.004)	Cold Drawn	AT (TF00)	14.4020	ASTM B196, Oil Field
2.25	(±.0045)	Cold Drawn	HT (TH04)	14.4020	Baker Hughes Cu, 03
2.5	(±.005)	Cold Drawn	A (TB00)	17.7800	ASTM B196, AMS 4650
2.5	(±.005)	Cold Drawn	AT (TF00)	17.7800	AMS 4533, ASTM B196
2.5	(±.005)	Cold Drawn	H (TD04)	17.7800	AMS 4651, ASTM B196
2.5	(±.005)	Cold Drawn	HT (TH04)	17.7800	AMS 4534, ASTM B196
2.5	(±.005)	Cold Drawn	HT (TH04)	17.7800	FMC M40003
2.5	(±.0625)	Hot Worked	AT (TF00)	17.7800	AMS 4533, ASTM B196
2.5	(±.05)	Hot Worked	AT (TF00)	17.7800	ASTM B196, Oil Field
2.625	(±.00525)	Cold Drawn	HT (TH04)	19.6030	AMS 4534, ASTM B196
2.625	(±.00525)	Cold Drawn	HT (TH04)	19.6030	Baker Hughes Cu, 03
2.75	(±.0055)	Cold Drawn	A (TB00)	21.5140	ASTM B196, AMS 4650
2.75	(±.0055)	Cold Drawn	HT (TH04)	21.5140	AMS 4534, ASTM B196
2.75	(±.0055)	Cold Drawn	HT (TH04)	21.5140	FMC M40003
2.75	(±.0625)	Hot Worked	AT (TF00)	21.5140	AMS 4533, ASTM B196
2.75	(±.0055)	Hot Worked	AT (TF00)	22.0000	AMS 4533, ASTM B196
2.75	(±.0625)	Hot Worked	AT (TF00)	21.5140	Baker Hughes
2.75	(±.05)	Hot Worked	AT (TF00)	21.5140	ASTM B196, Oil Field
2.875	(±.00575)	Cold Drawn	A (TB00)	23.5144	ASTM B196, AMS 4650
3	(±.0650)	Hot Worked	A (TB00)	25.6036	ASTM B196, AMS 4650
3	(±.0625)	Hot Worked	AT (TF00)	25.6036	AMS 4533, ASTM B196
3.125	(±.125)	Hot Worked	AT (TF00)	27.7816	AMS 4533, ASTM B196
3.25	(±.0650)	Hot Worked	A (TB00)	30.0490	ASTM B196, AMS 4650
3.25	(±.125)	Hot Worked	AT (TF00)	30.0490	AMS 4533, ASTM B196
3.25	(±.07)	Hot Worked	AT (TF00)	30.0490	ASTM B196, Oil Field
3.5	(±.125)	Hot Worked	AT (TF00)	34.8490	AMS 4533, ASTM B196
3.5	(±.125)	Hot Worked	AT (TF00)	34.8490	Baker Hughes
3.5	(±.07)	Hot Worked	AT (TF00)	34.8490	ASTM B196, Oil Field
3.75	(±.0650)	Hot Worked	A (TB00)	40.0056	ASTM B196, AMS 4650
3.75	(±.12)	Hot Worked	AT (TF00)	40.0056	ASTM B196, Oil Field
4	(±.0650)	Hot Worked	A (TB00)	45.5170	ASTM B196, AMS 4650
4	(±.125)	Hot Worked	AT (TF00)	45.5170	AMS 4533, ASTM B196
4.25	(±.125)	Hot Worked	AT (TF00)	51.3850	AMS 4533, ASTM B196
4.5	(±.125)	Hot Worked	AT (TF00)	57.6080	AMS 4533, ASTM B196
4.75	(±.12)	Hot Worked	A (TB00)	68.6800	ASTM B196, AMS 4650
4.75	(±.12)	Hot Worked	AT (TF00)	64.1870	ASTM B196, Oil Field

Continued next page



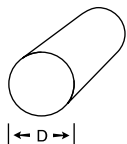

Continued from previous page
Alloy 25
Round Beryllium Copper Bar

Diameter (Inches)	Diameter Tolerance	Manufacturing Method	Temper	Pounds Per Foot	Specifications
5	(±.12)	Hot Worked	AT (TF00)	71.1210	ASTM B196, Oil Field
5.25	(±.12)	Hot Worked	A (TB00)	83.9000	ASTM B196, AMS 4650
5.25	(±.125)	Hot Worked	AT (TF00)	78.4110	AMS 4533, ASTM B196
5.25	(±.125)	Hot Worked	Drill String Temper	78.4110	
5.5	(±.12)	Hot Worked	AT (TF00)	86.0570	ASTM B196, Oil Field
6	(±.12)	Hot Worked	AT (TF00)	102.4140	ASTM B196, Oil Field
6.5	(±.12)	Hot Worked	AT (TF00)	120.1940	ASTM B196, Oil Field

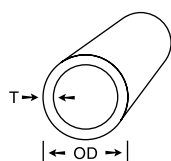

Alloy 25
Beryllium Copper Tube

12 Foot Mill Lengths
 ASTM B643

Description	OD (Inches)	OD Tolerance	Thickness (Inches)	Thickness Tolerance	Temper	Pounds Per Foot
Cold Drawn	1.5	(±.008)	0.25	(±.008)	HT (TH04)	3.5108
Cold Drawn	1.75	(±.008)	0.219	(±.005)	HT (TH04)	3.7668
Cold Drawn	1.875	(±.003)	0.375	(±.023)	HT (TH04)	6.3195
Cold Drawn	1.875	(±.003)	0.5315	(±.032)	HT (TH04)	8.0223
Hot Worked	2	(±.030)	0.25	(±.017)	AT (Heat treated - TF00)	4.9100
Hot Worked	2.125	(±.040)	0.3125	(±.032)	AT (Heat treated - TF00)	6.8000
Hot Worked	2.375	(±.040)	0.375	(±.032)	AT (Heat treated - TF00)	8.4200
Hot Worked	2.5	(±.004)	0.75	(±.045)	AT (Heat treated - TF00)	14.7454
Cold Drawn	3.375	(±.012)	0.5	(±.023)	HT (TH04)	16.1497
Hot Worked	3.375	(±.050)	0.5	(±.053)	AT (Heat treated - TF00)	16.1500
Hot Worked	3.5	(±.050)	0.75	(±.045)	AT (Heat treated - TF00)	23.1714
Hot Worked	4.25	(±.060)	1	(±.070)	Drill String Temper	40.2857
Hot Worked	6	(±.060)	1.25	(±.088)	Drill String Temper	71.0000
Hot Worked	7	(±.060)	1.5	(±.105)	Drill String Temper	103.5790
Hot Worked	7.75	(±.060)	0.825	(±.083)	AT (Heat treated - TF00)	64.1800
Hot Worked	9.25	(±.060)	0.975	(±.083)	AT (Heat treated - TF00)	90.6400
Hot Worked	11.5	(±.060)	1.25	(±.098)	AT (Heat treated - TF00)	143.9400

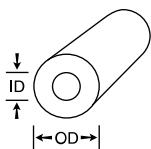

Alloy 25
Beryllium Copper Hollow Bar
Cold Drawn
HT (TH04)

12 Foot Mill Lengths
 ASTM B643

OD (Inches)	OD Tolerance	ID (Inches)	ID Tolerance	Pounds Per Foot
1.375	(+.016)	1	(-.016)	2.5015
1.625	(±.004)	1.25	(±.009)	3.0281
1.75	(±.004)	1.441	(±.009)	2.7694
1.875	(±.004)	1.5	(±.004)	3.5547
1.88	(+.016 -0)	1.495	(±.009)	3.6985

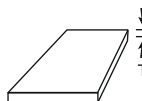

Alloy 25
Beryllium Copper Plate
Cold Rolled
H (Hard - TD04)

ASTM B194

Thickness (Inches)	Thickness Tolerance	Pounds Per Square Foot
0.25	(+.012 -0)	10.8720
0.75	(+.023 -0)	32.6160
1	(+.023 -0)	43.4880

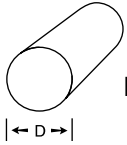

C17300
Round Alloy M25 Beryllium Copper Bar
H (Hard - TD04)

12 Foot Mill Lengths
 ASTM B196

Diameter (Inches)	Diameter Tolerance	Pounds Per Foot
0.0625	(±.002)	0.011
0.0781	(±.002)	0.0171
0.0937	(±.002)	0.0247
0.1093	(±.002)	0.0335
0.125	(±.002)	0.0439
0.1562	(±.002)	0.0685
0.1875	(±.002)	0.0987
0.2031	(±.002)	0.1158
0.2187	(±.002)	0.1343
0.25	(±.002)	0.1754
0.3125	(±.002)	0.2741
0.375	(±.002)	0.3948
0.4375	(±.002)	0.5373
0.5	(±.002)	0.7018
0.5625	(±.003)	0.8882
0.625	(±.003)	1.0965
0.6875	(±.003)	1.3268
0.75	(±.003)	1.579
0.875	(±.003)	2.1492
1	(±.003)	2.8072
1.5	(±.004)	6.3161

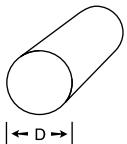

C17510
Round RWMA* Class 3 Copper Bar
HT (TH04)

12 Foot Mill Lengths

Diameter (Inches)	Diameter Tolerance	Pounds Per Foot
0.3125	(±.004)	0.2916
0.375	(±.002)	0.4199
0.5	(±.002)	0.7465
0.5625	(±.003)	0.9448
0.625	(±.003)	1.1665
0.75	(±.003)	1.6797
0.875	(±.003)	2.2863
1	(±.003)	2.9861
1.125	(±.004)	3.7793
1.5	(±.004)	6.7188
1.75	(±.004)	9.1451
2.25	(±.004)	15.1173

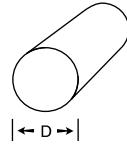

C17510
Round RWMA* Class 3 Copper Bar
Cold Drawn Annealed
A (solution annealed - TB00)

12 Foot Mill Lengths

Diameter (Inches)	Diameter Tolerance	Pounds Per Foot
0.998	(±.003)	2.9742
1.248	(±.001)	4.6509
1.25	(±.004)	4.6658
1.375	(±.004)	5.6457
2	(±.004)	11.9446
2.5	(±.006)	18.6634

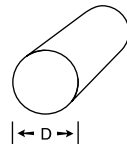

C17510
Round RWMA* Class 3 Copper Bar
AT-T (Heat treated and turned)

12 Foot Mill Lengths

Diameter (Inches)	Diameter Tolerance	Pounds Per Foot
2.5	(±.020)	18.6634
4	(±.030)	47.7782

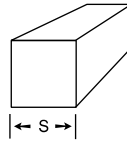

C17510
Square RWMA* Class 3 Copper Bar
HT (TH04)

12 Foot Mill Lengths

Size (Inches)	Size Tolerance	Pounds Per Foot
0.75	(±.005)	2.1398
1	(±.005)	3.804

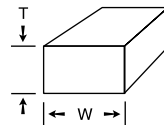

C17510
Rectangular RWMA* Class 3
Copper Bar
HT (TH04)

12 Foot Mill Lengths

Thickness (Inches)	Thickness Tolerance	Width (Inches)	Width Tolerance	Pounds Per Foot
0.25	(±.004)	1	(±.005)	0.951
0.5	(±.004)	0.75	(±.005)	1.4265
1	(±.007)	2	(±.010)	7.608
1	(±.006)	3	(±.006)	11.412
1.5	(±.007)	2		11.412

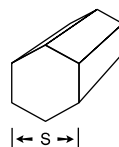

C17510
Hexagon RWMA* Class 3 Copper Bar
HT (TH04)

12 Foot Mill Lengths

Size (Inches)	Size Tolerance	Pounds Per Foot
1.25	(±.005)	5.1513

*Resistance Welding Manufacturers Association





Advanced order entry and tracking systems monitor your material every step of the way.

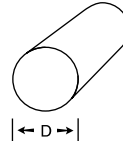

C18000 Round RWMA* Class 3 Copper Bar AT (Heat treated - TF00)

12 Foot Mill Lengths

Diameter (Inches)	Diameter Tolerance	Pounds Per Foot
0.75	(±.003)	1.6426
*0.75	(±.003)	1.579
0.875	(±.003)	2.2358
1	(+.05 -0)	2.9202
1.25	(±.004)	4.5628
1.375	(±.004)	5.521
1.5	(+.06 -0)	6.5705
1.75	(±.004)	8.9431
2	(±.004)	11.6808
3	(+.08 -0)	26.2818
3.5	(+.08 -0)	36.3494

*Cold Drawn (Heat Treated - TH04)

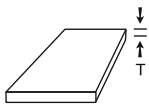

C17510 RWMA* Class 3 Copper Plate HT (TH04)

Thickness (Inches)	Thickness Tolerance	Pounds Per Square Foot
0.25	(+.012 -0)	11.4120
0.375	(+.015 -0)	17.1180
0.5	(+.030 -0)	22.8240
0.75	(+.022 -0)	34.2360
1	(+.028 -0)	45.6480
1.25	(+.028 -0)	57.0600
1.75	(+.033 -0)	79.8840

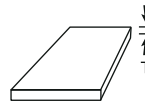

C18000 RWMA* Class 3 Copper Plate AT (Heat treated - TF00)

Thickness (Inches)	Thickness Tolerance	Pounds Per Square Foot
0.5	(+.030 -0)	24.0900
0.75	(+.030 -0)	36.1350
1	(+.125 -0)	48.1800
1.25	(+.125 -0)	60.2250
1.5	(+.125 -0)	72.2700
2	(+.125 -0)	96.3600
2.25	(+.125 -0)	108.4050
2.5	(+.125 -0)	120.4500
3	(+.125 -0)	144.5400
4	(+.125 -0)	192.7200

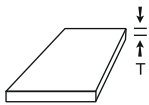

C17510 RWMA* Class 3 Copper Plate AT (Heat treated - TF00)

Thickness (Inches)	Thickness Tolerance	Pounds Per Square Foot
2	(+.060 -0)	91.2960
2.5	(+.060 -0)	114.1200
3	(+.060 -0)	136.9440

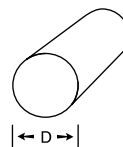

C18150 Round Chromium Zirconium RWMA* Class 2 Copper Bar

12 Foot Mill Lengths

Diameter (Inches)	Diameter Tolerance	Pounds Per Foot
0.5	(±.002)	0.756
0.625	(±.003)	1.1812
1.25	(±.004)	4.7247

*Resistance Welding Manufacturers Association

C18200 Chromium Copper

Nominal Composition

Copper: 99.1%
Chromium: 0.9% Chromium

Physical Properties

Melting Point (Liquidus):	1,075°C (1,967°F)
Melting Point (Solidus):	1,070°C (1,958°F)
Density at 68°F:	0.321 lb/in ³
Coefficient of Linear Expansion per °F:	9.8 x 10 ⁻⁶ (77-212°F)
Electrical Conductivity at 68°F:	80% IACS (solution heat treated, cold worked 50% minimum and aged)
Thermal Conductivity:	187 Btu/ft ² /ft/hr/°F (solution heat treated, cold worked 50% minimum and aged)
Modulus of Elasticity - Tension:	17,000 ksi
Modulus of Rigidity:	7,200 ksi

Fabrication Properties

Hot Working Temperature:	800-925°C (1,500-1,700°F)
Approximate Relative Machinability:	20 (free cutting brass arbitrarily rated at 100)

Description

Chromium Copper C18200 is a heat treatable alloy offering good electrical conductivity, resistance to softening at elevated temperatures and good strength and hardness. This combination of properties makes C18200 one of the preferred resistance welding electrode materials for a variety of applications. Nominally composed of 99.1% copper and 0.9% chromium, this alloy can be brought to its softest condition by annealing at 1,000°C (1,850°F) for one-half hour at temperature, then rapidly quenching in water. In the annealed condition, the alloy is ductile and easily formed, and has an electrical conductivity of about 40% IACS.

After softening in this manner, C18200 may be hardened back to some degree by cold working. However, the alloy also may be hardened by simply exposing it to a controlled temperature range between 425-500°C (800-930°F) for two to four hours. A similar treatment applied to cold worked material imparts additional hardness and strength. In either case, age hardening considerably improves the electrical conductivity (increasing it to about 80% IACS), as well as the mechanical properties which are retained to a great degree even at elevated temperatures above 200°C (375°F). At this temperature, C18200 has a tensile strength about twice that compared to electrolytic tough pitch (ETP) C11000 and silver coppers C10400, C10500, and C10700 at the same temperature.

Hot Working

Alloy C18200 can be hot worked, but after hot working, it is necessary to solution anneal the articles by heating at 1,000°C (1,850°F) and

Mechanical Properties

Rod	Tensile Strength (psi)	Yield Strength (0.5% Ext.) (psi)	% Elongation (in 2")	Rockwell Hardness
0.156" Dia. — TD10, SA-CW 91%	74,000	73,000	5	--
0.156" Dia. — TH10, SA-CW 90% - HT	86,000	77,000	14	--
0.500" Dia. — TB00, SA	45,000	14,000	40	--
0.500" Dia. — TD04, SA-CW 61%	57,000	56,000	11	HRB 65
0.500" Dia. — TH04, SA-CW 61%	77,000	65,000	16	HRB 82
0.500" Dia. — TF00, SA-HT	70,000	55,000	21	HRB 70
1.0" Dia. — TF00, SA-HT	72,000	65,000	18	HRB 80
2.0" Dia. — TF00, SA-HT	70,000	65,000	18	HRB 75
3.0" Dia. — TF00, SA-HT	65,000	55,000	18	HRB 70
4.0" Dia. — TF00, SA-HT	55,000	43,000	25	HRB 68

SA = Solution Anneal, HT = Heat Treat (Age), CW = Cold Work

quenching rapidly before applying the age hardening treatment. For both solution annealing and age hardening, the furnace atmosphere should be kept neutral or slightly reducing in order to minimize scale formation.

Cold Working

Cold workability is excellent. When the ultimate application requires only machining, rod and bar may be obtained in the fully hardened condition. If, however, cold forming operations are necessary, the stock should be ordered in the soft, solution annealed condition.

Joining

Welding and brazing temperatures degrade the properties developed by heat treatment, and such processes are seldom used for joining this alloy except in the softened condition.

Applications

Although C18200 is most commonly used for resistance welding equipment, it is also used for circuit breaker parts, current carrying shafts and arms, electrical connectors, heat sinks, plastic mold components, and switch gear.

Applicable Specifications

C18200 rod is generally manufactured to the latest revision of RWMA-Bulletin 16, Group A, Class 2 for resistance electrodes.



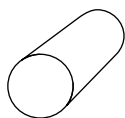

C18200
Round RWMA* Class 2 Copper Bar

12 Foot Mill Lengths

Diameter (Inches)	Diameter Tolerance	Pounds Per Foot
0.3125	(±.002)	0.2953
0.375	(±.002)	0.4252
0.482	(±.002)	0.7025
0.5	(±.002)	0.756
0.625	(±.002)	1.1699
0.75	(±.003)	1.6873
0.875	(±.003)	2.3151
1	(±.003)	3.0057
1.125	(±.004)	3.7999
1.25	(±.004)	4.7247
1.375	(±.004)	5.7169
1.5	(±.004)	6.8036
1.625	(±.004)	7.9848
1.75	(±.004)	9.2604
2	(±.004)	12.0953
3	(±.006)	27.2144

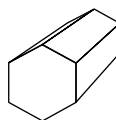

C18200
Hexagon RWMA* Class 2 Copper Bar

12 Foot Mill Lengths

Size (Inches)	Size Tolerance	Pounds Per Foot
0.5	(±.004)	0.8346
1	(±.006)	3.3384
1.25	(±.006)	5.2163

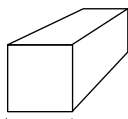

C18200
Square RWMA* Class 2 Copper Bar

12 Foot Mill Lengths

Size (Inches)	Size Tolerance	Pounds Per Foot
0.5	(±.005)	0.963
1	(±.006)	3.852
1.5	(±.007)	8.667
2	(±.007)	15.408

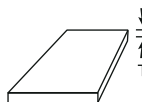

C18200
RWMA* Class 2 Copper Plate

Thickness (Inches)	Thickness Tolerance	Pounds Per Square Foot
0.25	(+.272 -.287)	11.5560
0.375	(+.030 -0)	17.3340
0.5	(+.058 -0)	23.1120
0.625	(+.072 -0)	28.8900
0.75	(+.085 -0)	34.6680
1	(+.113 -0)	46.2240
1.25	(+.113 -0)	57.7800
1.5	(+.113 -0)	69.3360
2	(+.113 -0)	92.4480
2.25	(+.113 -0)	104.0040
2.5	(+.113 -0)	115.5600
4	(+.113 -0)	184.8960

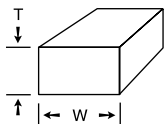

C18200
Rectangular RWMA* Class 2 Copper Bar

12 Foot Mill Lengths

Thickness (Inches)	Thickness Tolerance	Width (Inches)	Width Tolerance	Pounds Per Foot
0.5	(±.005)	0.75	(±.007)	1.4445
0.5	(±.005)	1	(±.007)	1.926
0.5	(±.005)	3	(±.007)	5.778
0.75	(±.007)	1.5	(±.009)	4.3335
0.75	(±.008)	3	(±.015)	8.667
1	(±.007)	1.25	(±.009)	4.815
1	(±.007)	1.5	(±.009)	5.778
1	(±.007)	2	(±.009)	7.704
1.5	(±.007)	2	(±.009)	11.556

*Resistance Welding Manufacturers Association

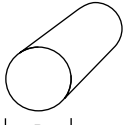

C18700 Round Leaded Copper Bar H04 (hard)

12 Foot Mill Lengths
ASTM B301

Diameter (Inches)	Diameter Tolerance	Pounds Per Foot
0.125	(±.0013)	0.0475
0.156	(±.0015)	0.074
0.188	(±.0015)	0.1075
0.25	(±.0015)	0.1902
0.3125	(±.0015)	0.2971
0.375	(±.0015)	0.4279
0.4375	(±.0015)	0.5824
0.5625	(±.002)	0.9627
0.625	(±.002)	1.1885
0.75	(±.002)	1.7115
1	(±.002)	3.0427

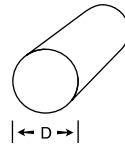

C19160 (K41) Round Leaded Nickel Copper Bar H04 (hard)

12 Foot Mill Lengths
ASTM B249

Diameter (Inches)	Diameter Tolerance	Pounds Per Foot
0.062	(±.00055)	0.0116
0.078	(±.00055)	0.0183
0.093	(±.00055)	0.0261
0.125	(±.00071)	0.0471
0.156	(±.00071)	0.0734
0.187	(±.00071)	0.1054
0.218	(±.00071)	0.1433
0.25	(±.00087)	0.1884
0.313	(±.00087)	0.2953
0.375	(±.00087)	0.4239
0.437	(±.0017)	0.5757
0.5	(±.0017)	0.7536
0.625	(±.0017)	1.1775

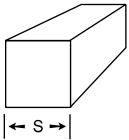

C18700 Square Leaded Copper Bar H04 (hard)

12 Foot Mill Lengths
ASTM B301

Size (Inches)	Size Tolerance	Pounds Per Foot
0.5	(±.003)	0.969

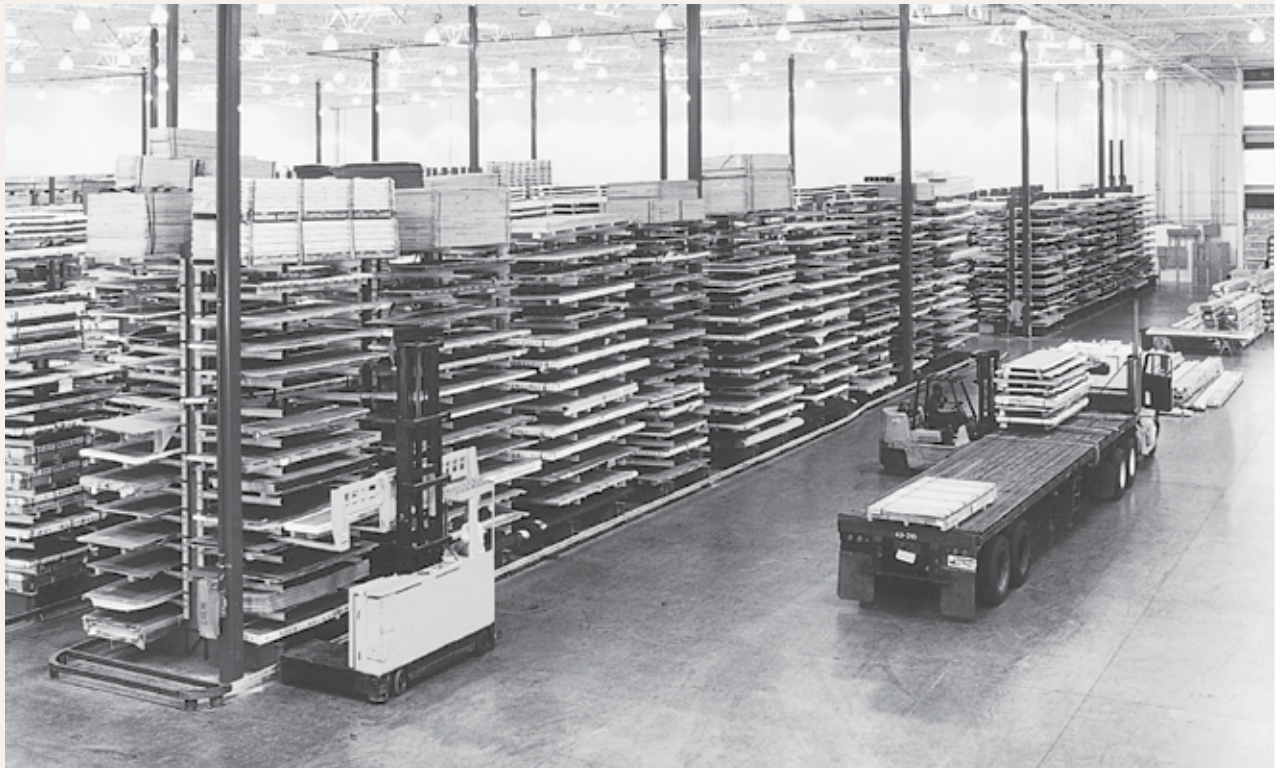

Modern and efficient warehouse and inventory systems speed your order on its way.



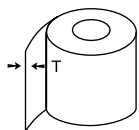

C21000
Gilding Brass 95/5 Coil
O60 (soft anneal)
 ASTM B36

Thickness (Inches)	Thickness Tolerance	Pounds Per Square Foot
0.064	(±.0015)	2.9491
0.125	(±.002)	5.7600

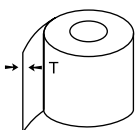

C22000
Commercial Bronze 90/10 Coil
 ASTM B36

Thickness (Inches)	Thickness Tolerance	Temper	Pounds Per Square Foot
0.0110	(±.0004)	O60 (soft anneal)	0.5037
0.0200	(±.00065)	O60 (soft anneal)	0.9158
0.0200	(±.0005)	O60 (soft anneal)	0.9158
0.0230	(±.0005)	O60 (soft anneal)	1.0532
0.0320	(±.001)	H03 (three-quarter-hard)	1.4653
0.0320	(±.001)	H04 (hard)	1.4653
0.0320	(±.001)	O60 (soft anneal)	1.4653
0.0420	(±.001)	H04 (hard)	1.9233
0.0450	(±.001)	H04 (hard)	2.0606
0.0500	(±.00125)	O60 (soft anneal)	2.2896
0.0620	(±.00125)	O60 (soft anneal)	2.8391
0.0900	(±.002)	O60 (soft anneal)	4.1213
0.1000	(±.002)	O60 (soft anneal)	4.5792
0.1250	(±.002)	H02 (half-hard)	5.724
0.1250	(±.002)	O60 (soft anneal)	5.724

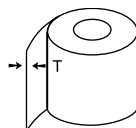

C23000
Red Brass 85/15 Coil
O60 (soft anneal)
 ASTM B36

Thickness (Inches)	Thickness Tolerance	Pounds Per Square Foot
0.008	(±.0005)	0.3640
0.01	(±.0005)	0.4550
0.012	(±.0005)	0.5460
0.013	(±.0005)	0.5916
0.014	(±.0005)	0.6371
0.015	(±.0005)	0.6826
0.016	(±.0005)	0.7281
0.018	(±.0065)	0.8191
0.02	(±.0005)	0.9101
0.028	(±.001)	1.2741
0.032	(±.0005)	1.4561
0.04	(±.001)	1.8202
0.05	(±.001)	2.2752
0.057	(±.00125)	2.5937
*0.063	(±.001)	2.8668
0.064	(±.001)	2.9123
0.08	(±.002)	3.6403
0.102	(±.002)	4.6414
0.125	(±.002)	5.6880

*H02 (half hard)

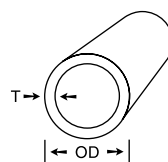

C23000
Round Red Brass 85/15 Pipe
Standard Pipe Sizes — Regular

12 Foot Exact Lengths
 ASTM B43

Red brass pipe is highly recommended for use with abnormally corrosive waters, shallow wells, tubular wells, salt water (sea) used in bath and swimming pools and for underground service with threaded connections.

Nominal Pipe Size	Temper	OD (Inches)	OD Tolerance	Thickness (Inches)	Thickness Tolerance	Pounds Per Foot
3/8	H58	.675	(±.005)	.090	(±.005)	.627
1/2	H58	.840	(±.005)	.107	(±.006)	.934
3/4	H58	1.050	(±.006)	.114	(±.006)	1.27
1	H58	1.315	(±.006)	.126	(±.007)	1.78
1-1/2	H58	1.900	(±.006)	.150	(±.008)	3.13
2	H58	2.375	(±.008)	.156	(±.009)	4.12
2-1/2	H58	2.875	(±.008)	.187	(±.010)	5.99
3	H80	3.500	(±.010)	.219	(±.012)	8.56
3-1/2	H80	4.000	(±.010)	.250	(±.013)	11.2
4	H80	4.500	(±.012)	.250	(±.014)	12.7

C26000 Cartridge Brass

Nominal Composition

Copper:	70%
Iron:	0.05% max.
Lead:	0.07% max.
Zinc:	30%

Note: Cu + Sum of Named Elements, 99.7% min.

Physical Properties

Melting Point - Liquidus:	1,750°F
Melting Point - Solidus:	1,680°F
Density:	0.308 lb/in ³ at 68°F
Specific Gravity:	8.530
Electrical Conductivity:	28% IACS @ 68°F
Thermal Conductivity:	70 Btu/ft ² /ft/hr/°F at 68°F
Coefficient of Thermal Expansion per °F:	11.10 x 10 ⁻⁶ (68-572° F)
Specific Heat Capacity:	0.090 Btu/lb/°F at 68°F
Modulus of Elasticity in Tension:	16,000 ksi
Modulus of Rigidity:	6,000 ksi

Fabrication Properties

Soldering:	Excellent
Brazing:	Excellent
Oxyacetylene Welding:	Good
Gas Shielded Arc Welding:	Good
Coated Metal Arc Welding:	Not Recommended
Spot Weld:	Fair
Seam Weld:	Not Recommended
Butt Weld:	Good
Machinability Rating:	30

Description

C26000 Cartridge Brass is the most ductile of the brasses and is used in greater quantity than any other copper-zinc alloy. C26000 has excellent to good corrosion resistance in most environments, but is not suitable for use with certain materials, such as acetic acid, moist ammonia or ammonia compounds, hydrochloric acid and nitric acid.

Hot and Cold Working

Capacity for Being Cold Worked:	Excellent
Capacity for Being Hot Formed:	Fair

Typical Mechanical Properties at 68°F

Flat Products Section Size 0.04" Temper	Tensile Strength (psi)	Yield Strength (0.5% ext.) (psi)	% Elongation (in 2")	Rockwell Hardness
H01	54,000	40,000	43	HRB 55
H02	62,000	52,000	25	HRB 70
H04	76,000	63,000	8	HRB 82
H06	86,000	65,000	5	HRB 88
H08	94,000	65,000	3	HRB 91
H10	99,000	65,000	3	HRB 93
O15	53,000	22,000	54	HRC 78
O25	51,000	19,000	55	HRC 72
O35	49,000	17,000	57	HRC 68
O50	47,000	15,000	62	HRC 64
O70	46,000	14,000	65	HRC 58
O100	44,000	11,000	66	HRC 54
Rod 1.0" Dia.	Tensile Strength (psi)	Yield Strength (0.5% ext.) (psi)	% Elongation (in 2")	Rockwell Hardness
H00	55,000	40,000	48	HRB 60
H02	70,000	52,000	30	HRB 80
O50	48,000	16,000	65	HRC 65
Tube				
H80	78,000	64,000	8	HRB 82
O25	52,000	20,000	55	HRC 75
O50	47,000	15,000	65	HRC 64

Typical Uses

Grillwork, heater cores, thermostats, electrical connectors, radiator tube, locks, finish hardware, kick plates, decorative hardware, door knobs, hinges, snaps, etched articles, coinage, watch parts, costume jewelry, buttons, electrical sockets, lamps, terminal connectors, lamp fixtures, reflectors, screw shells, ammunition cartridge cases, lighters, bathroom fixtures, plumbing accessories, faucet escutcheons, traps, and brass goods.

Applicable Specifications

Bar:	ASTM B36, B19
Cartridge Case:	ASTM B129 MIL-C-10375
Plate:	AMS 4507, 4505 ASTM B19, B36
Rod:	SAE J461, J463
Sheet:	AMS 4507, 4508, 4505 ASTM B19, B36 SAE J463, J461
Strip:	AMS 4507, 4505 ASTM B36, B569, B19, B888 SAE J463, J461
Tube:	ASTM B135 ASTM B587, B587



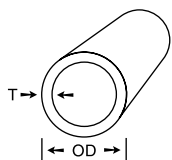

**C26000
Round Cartridge Brass
70/30 Tube
H58 (drawn-general purpose)**

12 Foot Mill Lengths
ASTM B135

OD (Inches)	OD Tolerance	Thickness (Inches)	Thickness Tolerance	Pounds Per Foot
0.125	(±.002)	0.035	(±.003)	0.0366
0.1875	(±.002)	0.032	(±.0025)	0.0578
0.1875	(±.002)	0.049	(±.003)	0.0788
0.25	(±.002)	0.032	(±.0025)	0.081
0.25	(±.002)	0.049	(±.003)	0.1144
0.25	(±.002)	0.065	(±.0035)	0.1396
0.3125	(±.002)	0.032	(±.0025)	0.1042
0.3125	(±.002)	0.049	(±.003)	0.1499
0.3125	(±.002)	0.065	(±.0035)	0.1868
0.375	(±.002)	0.032	(±.0025)	0.1274
0.375	(±.002)	0.049	(±.003)	0.1855
0.375	(±.002)	0.065	(±.0035)	0.234
0.4375	(±.002)	0.032	(±.0025)	0.1507
0.4375	(±.002)	0.065	(±.0035)	0.2811
0.5	(±.002)	0.032	(±.0025)	0.1739
0.5	(±.002)	0.065	(±.0035)	0.3283
0.5625	(±.002)	0.035	(±.0025)	0.2144
0.5625	(±.002)	0.065	(±.0035)	0.3755
0.625	(±.002)	0.035	(±.0025)	0.2398
0.625	(±.002)	0.049	(±.003)	0.3277
0.625	(±.002)	0.065	(±.0035)	0.4227
0.75	(±.0025)	0.035	(±.0035)	0.2906
0.75	(±.0025)	0.049	(±.0035)	0.3988
0.75	(±.0025)	0.065	(±.004)	0.517
0.75	(±.0025)	0.083	(±.005)	0.6428
0.8125	(±.0025)	0.015	(±.0015)	0.1389
0.875	(±.0025)	0.049	(±.0035)	0.47
0.875	(±.0025)	0.065	(±.004)	0.6114
1	(±.0025)	0.032	(±.0025)	0.3597
1	(±.0025)	0.065	(±.004)	0.7057
1.125	(±.003)	0.065	(±.004)	0.8
1.25	(±.003)	0.035	(±.0035)	0.4938
1.25	(±.003)	0.065	(±.004)	0.8944
1.375	(±.003)	0.032	(±.003)	0.499
1.375	(±.003)	0.065	(±.004)	0.9887
1.5	(±.003)	0.065	(±.004)	1.0831
1.625	(±.003)	0.065	(±.004)	1.1774
1.75	(±.003)	0.035	(±.0035)	0.697
1.75	(±.003)	0.065	(±.004)	1.2718
1.875	(±.003)	0.065	(±.004)	1.3661
2.125	(±.004)	0.065	(±.006)	1.5548
2.25	(±.004)	0.032	(±.004)	0.8241
2.5	(±.004)	0.065	(±.006)	1.8378
2.75	(±.004)	0.065	(±.006)	2.0265

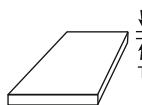

**C26000
Cartridge Brass 70/30 Plate
Cold Rolled**

ASTM B36

Thickness (Inches)	Thickness Tolerance	Pounds Per Square Foot
*0.25	(±.012)	11.0880
0.375	(±.013)	16.6320
0.375	(±.013)	16.6320
0.5	(±.013)	22.1760
0.75	(±.013)	33.2640

*H02 (half-hard)

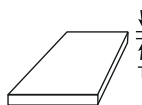

**C26000
Cartridge Brass 70/30 Sheet
H02 (half-hard)**

ASTM B36

Thickness (Inches)	Thickness Tolerance	Width x Length (Inches)	Pounds Per Square Foot
0.016	(±.0025)	24 x 96	0.7096
0.02	(±.003)	24 x 96	0.8870
0.02	(±.0035)	36 x 96	0.8870
0.025	(±.003)	24 x 96	1.1088
0.025	(±.0035)	36 x 96	1.1088
0.032	(±.0035)	24 x 96	1.4193
0.032	(±.004)	36 x 96	1.4193
0.04	(±.004)	24 x 96	1.7741
0.04	(±.005)	36 x 96	1.7741
0.045	(±.004)	24 x 120	1.9958
0.05	(±.004)	24 x 96	2.2176
0.05	(±.005)	36 x 96	2.2176
0.0625	(±.005)	24 x 96	2.7720
0.0625	(±.006)	36 x 96	2.7720
0.08	(±.007)	36 x 96	3.5482
0.093	(±.006)	24 x 96	4.1247
0.093	(±.007)	36 x 96	4.1247
0.1	(±.006)	24 x 96	4.4352
0.125	(±.006)	24 x 96	5.5440
0.125	(±.007)	36 x 96	5.5440
0.156	(±.008)	36 x 96	6.9189
0.188	(±.008)	36 x 96	8.3382

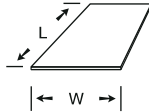

C26000
Cartridge Brass 70/30 Sheet
O60 (soft anneal)

ASTM B36

Thickness (Inches)	Thickness Tolerance	Width x Length (Inches)	Pounds Per Square Foot
0.02	(±.003)	24 x 96	0.8870
0.025	(±.003)	24 x 96	1.1088
0.032	(±.0035)	24 x 96	1.4193
0.032	(±.004)	36 x 96	1.4193
0.04	(±.004)	24 x 96	1.7741
0.04	(±.005)	36 x 96	1.7741
0.05	(±.004)	24 x 96	2.2176
0.05	(±.005)	36 x 96	2.2176
0.0625	(±.006)	36 x 96	2.7720
0.063	(±.006)	36 x 96	2.7942
0.064	(±.006)	24 x 96	2.8385
0.093	(±.007)	36 x 96	4.1247
0.125	(±.007)	36 x 96	5.5440

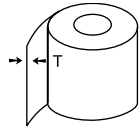

C26000
Cartridge Brass 70/30 Coil
O60 (soft anneal)

ASTM B36

Thickness (Inches)	Thickness Tolerance	Pounds Per Square Foot
0.005	(±.0002)	0.2218
0.007	(±.0005)	0.3105
0.008	(±.0003)	0.3548
0.009	(±.0003)	0.3992
0.01	(±.0003)	0.4435
0.011	(±.0003)	0.4879
0.012	(±.0003)	0.5322
0.013	(±.0005)	0.5766
0.014	(±.0005)	0.6209
0.015	(±.0005)	0.6653
0.016	(±.00065)	0.7096
0.017	(±.00065)	0.7540
0.018	(±.00065)	0.7983
0.019	(±.00065)	0.8427
0.02	(±.00065)	0.8870
0.025	(±.00075)	1.1088
0.028	(±.0005)	1.2419
0.03	(±.001)	1.3306
0.032	(±.001)	1.4193
0.035	(±.001)	1.5523
0.036	(±.001)	1.5967
0.04	(±.001)	1.7741
0.045	(±.001)	1.9958
0.05	(±.001)	2.2176
0.057	(±.00125)	2.5281
0.062	(±.00125)	2.7498
0.064	(±.00125)	2.8385
0.08	(±.0015)	3.5482
0.09	(±.002)	3.9917
0.093	(±.002)	4.1247
0.1	(±.002)	4.4352
0.125	(±.002)	5.5440
0.15	(±.0035)	6.6528

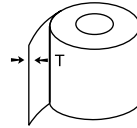

C26000
Cartridge Brass 70/30 Coil
H01 (quarter-hard)

ASTM B36

Thickness (Inches)	Thickness Tolerance	Pounds Per Square Foot
0.016	(±.0005)	0.7096
0.02	(±.00065)	0.8870
0.025	(±.00075)	1.1088
0.031	(±.005)	1.3749
0.032	(±.001)	1.4193
0.04	(±.001)	1.7741
0.05	(±.001)	2.2176
0.06	(±.00125)	2.6611
0.062	(±.00125)	2.7498
0.064	(±.00125)	2.8385

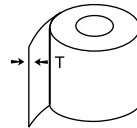

C26000
Cartridge Brass 70/30 Coil
H02 (half-hard)

ASTM B36

Thickness (Inches)	Thickness Tolerance	Pounds Per Square Foot
0.01	(±.0004)	0.4435
0.012	(±.0004)	0.5322
0.015	(±.0005)	0.6653
0.016	(±.0005)	0.7096
0.02	(±.00065)	0.8870
0.0236	(±.0003)	1.0467
0.025	(±.0005)	1.1088
0.025	(±.00075)	1.1088
0.031	(±.0005)	1.3749
0.0315	(±.0005)	1.3971
0.032	(±.0005)	1.4193
0.04	(±.001)	1.7741
0.045	(±.001)	1.9958
0.05	(±.001)	2.2176
0.062	(±.00125)	2.7498
0.064	(±.00125)	2.8385
0.07	(±.002)	3.1046
0.08	(±.0015)	3.5482
0.093	(±.0015)	4.1247
0.1	(±.002)	4.4352
0.118	(±.002)	5.2335
0.125	(±.002)	5.5440
0.188	(±.004)	8.3382





Precision coil slitting to customer requirements is a hallmark of our service.

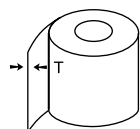

C26000 Cartridge Brass 70/30 Coil H03 (three-quarter hard)

ASTM B36

Thickness (Inches)	Thickness Tolerance	Pounds Per Square Foot
0.025	(±.00075)	1.1088
0.0315	(±.0005)	1.3971
0.05	(±.001)	2.2176

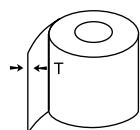

C26000 Cartridge Brass 70/30 Coil H04 (hard)

ASTM B36

Thickness (Inches)	Thickness Tolerance	Pounds Per Square Foot
0.016	(±.0005)	0.7096
0.02	(±.00065)	0.8870
0.032	(±.0004)	1.4193
0.032	(±.001)	1.4193
0.04	(±.001)	1.7741
0.045	(±.001)	1.9958
0.05	(±.00125)	2.2176
0.0625	(±.00125)	2.7720

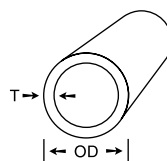

C27200 Round Yellow Brass Tube H58 (drawn-general purpose)

12 Foot Mill Lengths
ASTM B135

OD (Inches)	OD Tolerance	Thickness (Inches)	Thickness Tolerance	Pounds Per Foot
0.375	(±.002)	0.032	(±.0025)	0.1266
0.375	(±.002)	0.049	(±.003)	0.1843
0.375	(±.002)	0.062	(±.0035)	0.2238
0.5	(±.002)	0.032	(±.0025)	0.1728
0.5	(±.002)	0.049	(±.003)	0.2549
0.5	(±.002)	0.065	(±.0035)	0.3262
0.625	(±.002)	0.049	(±.003)	0.3256
0.625	(±.002)	0.065	(±.0035)	0.42
0.75	(±.0025)	0.032	(±.0025)	0.2651
0.75	(±.0025)	0.049	(±.0035)	0.3962
0.75	(±.0025)	0.065	(±.004)	0.5136
0.75	(±.0025)	0.094	(±.005)	0.7114
1	(±.0025)	0.032	(±.0025)	0.3574
1	(±.0025)	0.065	(±.004)	0.7011
1	(±.0025)	0.091	(±.005)	0.9543
1	(±.0025)	0.125	(±.006)	1.2618
1.25	(±.003)	0.065	(±.004)	0.8886
1.25	(±.003)	0.125	(±.006)	1.6223
1.5	(±.003)	0.049	(±.0035)	0.8364
1.5	(±.003)	0.065	(±.004)	1.076
1.75	(±.003)	0.032	(±.003)	0.6343
1.75	(±.003)	0.065	(±.004)	1.2635
2	(±.003)	0.032	(±.003)	0.7265
2	(±.003)	0.049	(±.0035)	1.1028
2	(±.003)	0.065	(±.004)	1.451
2	(±.003)	0.125	(±.006)	2.7038
2.5	(±.004)	0.032	(±.004)	0.911
3	(±.004)	0.049	(±.005)	1.6681
4	(±.005)	0.065	(±.006)	2.9507

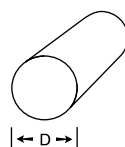

C27450 Round Yellow Brass Bar H02 (half hard)

12 Foot Mill Lengths
ASTM B927

Diameter (Inches)	Diameter Tolerance	Pounds Per Foot
0.75	(±.002)	1.6426
1	(±.002)	2.9202
1.625	(±.002)	7.7112
1.75	(±.0025)	8.9431

C31400 Leaded Commercial Bronze

Nominal Composition

Copper: 89%
Zinc: 9.1%
Lead: 1.9%

Physical Properties

Melting Point (Liquidus):	1,040°C (1,900°F)
Melting Point (Solidus):	1,010°C (1,850°F)
Density at 68°F:	0.319 lb/in ³
Coefficient of Linear Thermal Expansion per °F:	1.02 x 10 ⁻⁵ (68-572°F)
Electrical Conductivity at 68°F (volumetric):	42% IACS (in the annealed condition; lower in hard temper)
Thermal Conductivity:	104 Btu/ft ² /ft/hr/°F at 68°F
Modulus of Elasticity - Tension:	17,000 ksi
Modulus of Rigidity:	6,400 ksi

Fabrication Properties

Annealing Temperature:	425-650°C (800-1,200°F)
Approximate Relative Machinability:	80 (free cutting brass arbitrarily rated at 100)

Mechanical Properties

Rod	Tensile Strength (psi)	Yield Strength (0.5% Ext.) (psi)	% Elongation (in 2")	Rockwell Hardness
0.250" Dia. — 1/2 Hard (37%)	60,000	55,000	10	HRB 65
0.500" Dia. — 1/2 Hard (25%)	55,000	50,000	14	HRB 61
1.0" Dia. — Annealed 0.050 mm	37,000	12,000	45	HRF 55
1.0" Dia. — 1/2 Hard (20%)	52,000	45,000	18	HRB 58

Description

Leaded commercial bronze C31400 combines the natural corrosion resistance of C22000 with the machinability typical of leaded brasses. Like C22000, it is an alpha brass nominally composed of 89% copper and 9% zinc, but it also contains approximately 2% lead to impart free-cutting characteristics. The relatively low zinc content of C31400 provides excellent corrosion resistance in potable water applications along with a pleasing golden color that matches C22000 hardware. Alloy C31400 is also suitable for outdoor use due to its resistance to stress corrosion cracking and to corrosion in general, but where the highest strength is not required.

Hot and Cold Working

C31400 has poor hot workability due to its lead content, so hot working is not recommended; however, it can be successfully hot extruded into rod products. Although it is primarily used for high-speed screw machining, it has good cold workability, sustaining a moderate degree of cold work.

Joining

Joining by soldering is excellent and by brazing is good. The lead content prevents successful welding.

Applications

Screws, screw machine parts, pickling crates, architectural hardware.

Applicable Specifications

When so specified, C31400 will be manufactured to the latest revision of the following specification: ASTM B140.

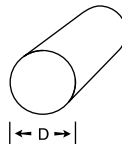

C31400 Round Leaded Commercial Bronze Bar H02 (half hard)

12 Foot Mill Lengths
ASTM B140

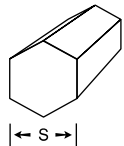

C31400 Hexagonal Leaded Commercial Bronze Bar H02 (half-hard)

12 Foot Mill Lengths
ASTM B140

CBS Part No.	Size (Inches)	Pounds Per Foot
CUHEX00147	0.4375	0.6091

CBS Part No.	Diameter (Inches)	Diameter Tolerance	Pounds Per Foot
CURD00654	0.25	(±.0015)	0.1802
CURD01235	0.375	(±.0015)	0.4054
CURD01338	0.5	(±.0015)	0.7206
CURD01363	0.5625	(±.002)	0.912
CURD00374	0.625	(±.002)	1.126
CURD00041	0.6875	(±.002)	1.3624
CURD01159	0.75	(±.002)	1.6214
CURD00206	1	(±.002)	2.8825
CURD00071	1.125	(±.0025)	3.6482
CURD01228	1.25	(±.0025)	4.5039
CURD00635	1.375	(±.0025)	5.6635
CURD00065	1.5	(±.0025)	6.4857
CURD01233	1.75	(±.0025)	8.8277
CURD01345	2	(±.0025)	11.5301
CURD01342	2.125	(±.003)	13.6361



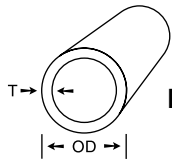

C33000 Round Low Leaded Brass Tube H80 (hard-drawn)

12 Foot Mill Lengths
ASTM B135

OD (Inches)	OD Tolerance	Thickness (Inches)	Thickness Tolerance	Pounds Per Foot
0.25	(±.002)	0.032	(±.0025)	0.0807
0.25	(±.002)	0.065	(±.0035)	0.1392
0.3125	(±.002)	0.028	(±.0025)	0.0922
0.3125	(±.002)	0.065	(±.0035)	0.1862
0.375	(±.002)	0.035	(±.003)	0.1377
0.375	(±.002)	0.049	(±.003)	0.1849
0.375	(±.002)	0.065	(±.0035)	0.2332
0.5	(±.002)	0.032	(±.0025)	0.1733
0.5	(±.002)	0.049	(±.003)	0.255
0.5	(±.002)	0.065	(±.0035)	0.3273
0.5	(±.002)	0.125	(±.005)	0.5425
0.625	(±.002)	0.065	(±.0035)	0.4213
0.625	(±.002)	0.125	(±.005)	0.7234
0.6875	(±.0025)	0.032	(±.0025)	0.2428
0.75	(±.0025)	0.035	(±.0035)	0.2896
0.75	(±.0025)	0.065	(±.0035)	0.5153
0.75	(±.0025)	0.125	(±.006)	0.9042
*0.875	(±.0025)	0.025	(±.004)	0.2461
0.875	(±.0025)	0.065	(±.004)	0.6094
0.875	(±.0025)	0.125	(±.006)	1.0851
1	(±.003)	0.035	(±.0035)	0.3909
1	(±.003)	0.065	(±.004)	0.7034
1	(±.003)	0.125	(±.006)	1.2659
1.125	(±.003)	0.031	(±.003)	0.3925
1.125	(±.003)	0.065	(±.004)	0.7974
1.125	(±.003)	0.125	(±.006)	1.4467
1.25	(±.003)	0.065	(±.004)	0.8915
1.25	(±.003)	0.125	(±.006)	1.6276
1.375	(±.003)	0.125	(±.006)	1.8084
1.5	(±.003)	0.032	(±.003)	0.5437
1.5	(±.003)	0.065	(±.004)	1.0796
1.5	(±.003)	0.125	(±.006)	1.9893
1.625	(±.003)	0.125	(±.006)	2.1701
1.75	(±.003)	0.065	(±.004)	1.2676
1.75	(±.003)	0.125	(±.006)	2.3509
2	(±.003)	0.065	(±.004)	1.4557
2	(±.003)	0.125	(±.006)	2.7126
2.25	(±.004)	0.065	(±.006)	1.6438
2.25	(±.004)	0.125	(±.008)	3.0743
2.25	(±.004)	0.25	(±.014)	5.787
2.5	(±.004)	0.125	(±.008)	3.436
2.75	(±.004)	0.125	(±.008)	3.7977
3	(±.004)	0.065	(±.006)	2.208
3.25	(±.005)	0.065	(±.006)	2.3649
3.25	(±.005)	0.125	(±.008)	4.5211
3.5	(±.005)	0.125	(±.008)	4.8827
4	(±.005)	0.065	(±.006)	2.9603
*4	(±.005)	0.125	(±.008)	5.6061

*H58 (drawn-general purpose)

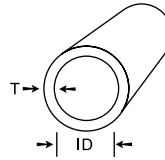

C33500 Round Low Leaded Brass Inside Diameter Tube Air Cylinder H80 (hard-drawn)

12 Foot Mill Lengths
ASTM B135

ID (Inches)	Thickness (Inches)	Pounds Per Foot
1.5	0.125	2.35
2	0.125	3.07
3	0.125	4.52
4	0.125	5.9872



Our precision bar saws can delivery production quantities with finished edges.

C35300 High Leaded Brass

Nominal Composition

Copper: 61.5%
Zinc: 36.5%
Lead: 2%

Physical Properties

Melting Point (Liquidus):	910°C (1,670°F)
Melting Point (Solidus):	875°C (1,635°F)
Density at 68°F:	0.306 lb/in ³
Average Coefficient of Linear Thermal Expansion per °F:	1.13 x 10 ⁻⁵ (68-572°F)
Electrical Conductivity at 68°F (volumetric):	26% IACS (in annealed condition; lower in hard temper)
Thermal Conductivity:	67 Btu/ft ² /ft/hr/°F at 68°F
Modulus of Elasticity - Tension:	15,000 ksi
Modulus of Rigidity:	5,600 ksi

Fabrication Properties

Annealing Temperature:	425-600°C (800-1,100°F)
Approximate Relative Machinability:	90 (Free cutting brass arbitrarily rated at 100.)

Mechanical Properties

Rod	Tensile Strength (psi)	Yield Strength (0.5% Ext.) (psi)	% Elongation (in 2")	Rockwell Hardness
1.00" Dia. — 1/2 Hard (20%)	58,000	45,000	25	HRB 75

Description

C35300 high leaded brass has a slightly lower copper content than the C34000 series brasses, but of a copper content similar to free-cutting brass C36000. With approximately 61.5% copper, 36.5% zinc, and 2% lead, this alloy fulfills the need for a strong, hard brass with good machinability.

Unlike the C34000 series brasses, the composition of C35300 falls within the alpha + beta range. The beta grains give it increased hardness and rigidity, but a more limited ductility. However, the ductility of C35300 is not as limited as that of C36000.

Hot Working

C35300 has poor hot workability due to its lead content.

Cold Working

C35300 has fair cold workability. Although its formability is limited, it can be finished in the annealed state, which gives a moderate amount of formability combined with excellent machinability when so desired; however, C35300 is usually furnished in harder tempers for purposes that do not require much forming and where machinability is important. Common fabrication processes include bending, flaring, roll threading and heading.

Joining

Joining by soldering is excellent and brazing is good. The lead content prevents successful welding.

Applications

Applications of C35300 include clock and watch parts, and hardware such as gears, nuts, rivets and screws. Other applications include drawer handles, drawer pulls, faucet seats and stems.

Applicable Specifications

When so specified, C35300 will be manufactured to the latest revision of Specification ASTM B453 for rod and wire.

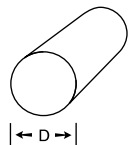

C35300
Round High Leaded Brass Bar
Thread Roll Quality
H02 (half hard)
12 Foot Mill Lengths
ASTM B453

CBS Part No.	Diameter (Inches)	Diameter Tolerance	Pounds Per Foot
CURD00194*	0.25	(±.0015)	0.1802
CURD00087	0.25	(±.0015)	0.1802
CURD01142	0.3125	(±.0015)	0.2815
CURD00057	0.375	(±.0015)	0.4054
CURD01419	0.4375	(±.0015)	0.5517
CURD01137	0.5	(±.0015)	0.7206
CURD00072	0.562	(±.002)	0.9104
CURD00318	0.625	(±.002)	1.1262
CURD00259	0.75	(±.002)	1.6214

*H01 (quarter-hard)

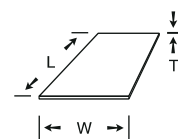

C35300
High Leaded Brass Sheet
H02 (half-hard)
ASTM B121

CBS Part No.	Thickness (Inches)	Width x Length (Inches)	Pounds Per Square Foot
CUFLR02487	0.125	24 x 96	5.5080



C36000 Free-Cutting Brass

Nominal Composition

Copper: 61.5%
Zinc: 35.4%
Lead: 3.1%

Physical Properties

Melting Point (Liquidus):	900°C (1,650°F)
Melting Point (Solidus):	885°C (1,630°F)
Density at 68°F:	0.307 lb/in ³
Average Coefficient of Linear Thermal Expansion per °F:	1.14 x 10 ⁻⁵ (68-572°F)
Electrical Conductivity at 68°F (volumetric):	26% IACS (in annealed condition; lower for hard temper)
Thermal Conductivity:	67 Btu/ft ² /ft/hr/°F at 68°F
Modulus of Elasticity - Tension:	14,000 ksi
Modulus of Rigidity:	5,300 ksi

Fabrication Properties

Hot Working Temperature:	700-800°C (1,300-1,450°F)
Annealing Temperature:	425-600°C (800-1,100°F)
Approximate Relative Machinability:	100

Mechanical Properties

Rod	Tensile Strength (psi)	Yield Strength (0.5% Ext.) (psi)	% Elongation (in 2")	Rockwell Hardness
0.250" Dia. — 1/2 Hard (25%)	68,000	52,000	18	HRB 80
1.0" Dia. — Soft Anneal	49,000	18,000	53	HRF 68
1.0" Dia. — 1/2 Hard (20%)	58,000	45,000	25	HRB 78
2.0" Dia. — 1/2 Hard (15%)	55,000	44,000	32	HRB 75

Description

Free Cutting Brass C36000 is nominally composed of 61.5% copper, 35.4% zinc, and 3.1% lead. It is the alloy most often used for continuous high-speed machining operations. This is because its high lead content creates machined chips which are short and easily freed from the work, hence, the name "free-cutting." This results in minimal tool wear and breakage with minimum downtime during machining. Alloy C36000 is thus considered the standard free-cutting copper alloy, and, as a result, its machinability index has been arbitrarily rated at 100, thereby becoming the standard to which all other copper alloys are compared. In volume, C36000 rod is probably used more than all other copper alloys combined.

Hot Working and Cold Working

C36000 has fair hot workability. It can be hot worked if mechanically supported. It can be extruded readily and may be forged or hot rolled. Due to its high lead content, it has poor cold workability. Although it can withstand a limited amount of cold work, non-lead brasses of higher copper content are much more suitable for cold working applications. Common fabrication processes are machining, roll threading and knurling.

Joining

Joining by soldering is excellent, while good by brazing. The lead content prevents successful welding.

Applications

Typical uses of C36000 are for hardware such as gears and pinions where excellent machinability is an important requirement, as well as for all types of automatic high-speed screw machine products. Specific applications include faucet stems and seats, gauges, lock hardware, and valve stems, seats, and trim.

Applicable Specifications

When so specified, C36000 will be manufactured to the latest revision of the following specifications: ASTM Specification B16 and AMS Specification 4610.

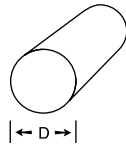

C36000
Round Free-Cutting Brass Bar
H02 (half hard)
 12 Foot Mill Lengths
 ASTM B16

Diameter (Inches)	Diameter Tolerance	Pounds Per Foot	Diameter (Inches)	Diameter Tolerance	Pounds Per Foot	Diameter (Inches)	Diameter Tolerance	Pounds Per Foot
0.0625	(±.0013)	0.0113	0.9375	(±.002)	2.5417	2.625	(±.004)	19.9272
0.0781	(±.0013)	0.0176	1	(±.002)	2.8919	2.75	(±.004)	21.8703
0.093	(+0 -.0008)	0.0254	1	(±.0015)	2.8919	2.75	(±.004)	21.8703
0.0937	(±.0013)	0.0254	1.0312	(±.0025)	3.0755	2.875	(±.004)	23.9037
0.1093	(±.0013)	0.0346	1.0625	(±.0025)	3.2647	3	(±.005)	26.0275
0.125	(±.0013)	0.0451	1.125	(±.0025)	3.6601	3.125	(±.005)	28.2415
0.1406	(±.0013)	0.0572	1.1875	(±.0025)	4.0781	3.25	(±.005)	30.5461
0.1562	(±.0015)	0.0705	1.25	(±.0025)	4.5187	3.375	(±.005)	32.941
0.1718	(±.0015)	0.0854	1.3125	(±.0025)	4.9819	3.5	(±.005)	35.4263
0.1875	(±.0015)	0.1017	1.375	(±.0025)	5.4675	3.75	(±.005)	40.6679
0.2031	(±.0015)	0.1191	1.4375	(±.0025)	5.9759	4	(±.006)	46.271
0.2187	(±.0015)	0.1383	1.5	(±.0025)	6.5069	4.5	(±.006)	58.5618
0.2343	(±.0015)	0.159	1.5625	(±.0025)	7.0604			
0.25	(±.0015)	0.1808	1.625	(±.0025)	7.6365			
0.251	(±.001)	0.1822	1.6875	(±.0025)	8.2353			
0.2656	(±.0015)	0.204	1.75	(±.0025)	8.8566			
0.2812	(±.0015)	0.2287	1.8125	(±.0025)	9.5005			
0.2968	(±.0015)	0.2548	1.875	(±.0025)	10.1669			
0.3125	(±.0015)	0.2824	1.9375	(±.0025)	10.856			
0.3281	(±.0015)	0.3114	2	(±.0025)	11.5678			
0.3437	(±.0015)	0.3417	2.0625	(±.003)	12.302			
0.3593	(±.0015)	0.3735	2.125	(±.003)	13.0589			
0.375	(±.0015)	0.4066	2.1875	(±.003)	13.8384			
0.3906	(±.0007)	0.4413	2.25	(±.003)	14.6405			
0.3906	(±.0015)	0.4413	2.375	(±.004)	16.3123			
0.4062	(±.0015)	0.4772	2.5	(±.004)	18.0746			
0.4375	(±.0015)	0.5535	2.625	(±.004)	19.9272			
0.453	(±.0015)	0.5935	2.75	(±.004)	21.8703			
0.4531	(±.0015)	0.5937	2.875	(±.004)	23.9037			
0.4687	(±.0015)	0.6354	3	(±.005)	26.0275			
0.5	(±.0015)	0.723	3.125	(±.005)	28.2415			
0.5312	(±.002)	0.8161	3.25	(±.005)	30.5461			
0.5468	(±.002)	0.8647	3.375	(±.005)	32.941			
0.5625	(±.002)	0.915	3.5	(±.005)	35.4263			
0.5937	(±.002)	1.0195	3.75	(±.005)	40.6679			
0.625	(±.002)	1.1296	4	(±.006)	46.271			
0.6406	(±.002)	1.1868	4.5	(±.006)	58.5618			
0.6562	(±.002)	1.2455	1.875	(±.0025)	10.1669			
0.6875	(±.002)	1.3669	1.9375	(±.0025)	10.856			
0.7187	(±.002)	1.494	2	(±.0025)	11.5678			
0.75	(±.002)	1.6267	2.0625	(±.003)	12.302			
0.7812	(±.002)	1.7651	2.125	(±.003)	13.0589			
0.8125	(±.002)	1.9091	2.1875	(±.003)	13.8384			
0.8437	(±.002)	2.0585	2.25	(±.003)	14.6405			
0.875	(±.002)	2.2141	2.375	(±.004)	16.3123			
0.9062	(±.002)	2.3751	2.5	(±.004)	18.0746			

C36000
Round Tight Tolerance
Free-Cutting Brass Bar
H02 (half hard)
 12 Foot Mill Lengths
 ASTM B16

Diameter (Inches)	Diameter Tolerance	Pounds Per Foot
0.075	(+0 -.0005)	0.0163
0.078	(±.0005)	0.0176
0.093	(±.0005)	0.025
0.0937	(±.0005)	0.0254
0.1243	(+0 -.0005)	0.0447
0.125	(±.0005)	0.0452
0.156	(±.0005)	0.0705
0.1562	(±.0005)	0.0705
0.1875	(±.0007)	0.1017
0.2031	(±.0007)	0.1193
0.2188	(±.0007)	0.1384
0.25	(±.0005)	0.1808
0.25	(±.0008)	0.1807
0.2656	(±.0008)	0.204
0.2812	(±.0008)	0.2287
0.3125	(±.0008)	0.2824
0.3438	(±.0008)	0.3417
0.375	(±.0008)	0.4067
0.4375	(±.0008)	0.5535
0.5	(±.0008)	0.723



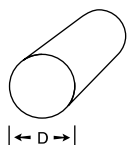

C36000
Round Free-Cutting Brass Bar
 Stress Relieved, Annealed
H02 (half hard)

12 Foot Mill Lengths
 ASTM B16

Diameter (Inches)	Diameter Tolerance	Pounds Per Foot
1	(±.002)	2.8919
1.125	(±.0025)	3.6601
1.5	(±.003)	6.5069

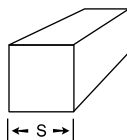

C36000
Square Free-Cutting Brass Bar
H02 (half-hard)

12 Foot Mill Lengths
 ASTM B16

Size (Inches)	Size Tolerance	Pounds Per Foot
0.1562	(±.0035)	0.0899
0.1875	(±.0035)	0.1295
0.2187	(±.0035)	0.1762
0.25	(±.0035)	0.2303
0.3125	(±.0035)	0.3598
0.375	(±.0035)	0.518
0.4375	(±.0035)	0.7051
0.5	(±.0045)	0.921
0.5625	(±.0045)	1.1656
0.625	(±.0045)	1.439
0.6875	(±.0045)	1.741
0.75	(±.0045)	2.0723
0.875	(±.0045)	2.8205
1	(±.0045)	3.684
1.125	(±.005)	4.6625
1.25	(±.005)	5.7563
1.375	(±.005)	6.965
1.5	(±.005)	8.289
1.625	(±.005)	9.728
1.75	(±.005)	11.2823
2	(±.006)	14.736
2.25	(±.007)	18.6503
2.5	(±.008)	23.025
2.75	(±.025)	27.8603

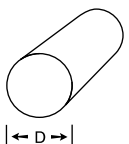

C36000
Round Cast Free-Cutting Brass Bar
H02 (half hard)

12 Foot Mill Lengths
 ASTM B16

Diameter (Inches)	Diameter Tolerance	Pounds Per Foot
4.25	(±.020)	52.2357
4.75	(+.050 -0)	65.2494
5	(±.020)	72.2985
5.25	(±.020)	79.7091
5.5	(±.020)	87.4812
5.75	(±.020)	95.6148
6	(+.050 -0)	104.11
6.5	(+.050 -0)	122.185
7	(+.050 -0)	141.705
8	(+.050 -0)	185.084
9	(+.050 -0)	234.247
10	(+.080 -0)	289.194

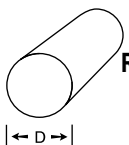

C36000
Round Extruded Free-Cutting Brass Bar
H02 (half hard)

12 Foot Mill Lengths
 ASTM B16

Diameter (Inches)	Diameter Tolerance	Pounds Per Foot
2.5	(±.025)	18.0746
2.625	(±.025)	19.9272
2.875	(±.025)	23.9037
3	(±.025)	26.0275
3.125	(±.035)	28.2415
3.25	(±.035)	30.5461
3.5	(±.035)	35.4263
3.75	(±.060)	40.6679
4	(±.060)	46.271
4.25	(±.120)	52.2357
4.5	(±.120)	58.5618
4.75	(±.120)	65.2494
5	(±.120)	72.2985
5.125	(±.120)	75.9586
5.25	(±.120)	79.7091
5.5	(±.120)	87.4812
6	(±.120)	104.11
6.5	(±.120)	122.185

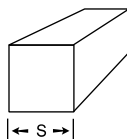

C36000
Square Free-Cutting Brass Bar
Extruded

12 Foot Mill Lengths
 ASTM B16

Size (Inches)	Size Tolerance	Pounds Per Foot
3	(±.039)	33.156
3.5	(±.063)	45.129
4	(±.087)	58.944

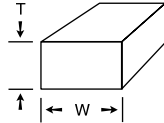

C36000
Rectangular Free-Cutting Brass Bar
H02 (half-hard)
 12 Foot Mill Lengths
 ASTM B16

Thickness (Inches)	Thickness Tolerance	Width (Inches)	Width Tolerance	Pounds Per Foot	Thickness (Inches)	Thickness Tolerance	Width (Inches)	Width Tolerance	Pounds Per Foot
0.125	(±.0035)	0.25	(±.0039)	0.1151	0.375	(±.0045)	1.5	(±.008)	2.0723
0.125	(±.0035)	0.375	(±.0039)	0.1727	0.375	(±.0045)	1.75	(±.008)	2.4176
0.125	(±.0035)	0.5	(±.0039)	0.2303	0.375	(±.0045)	2	(±.008)	2.763
0.125	(±.0035)	0.625	(±.0039)	0.2878	0.375	(±.0045)	2.5	(±.012)	3.4538
0.125	(±.0035)	0.75	(±.0059)	0.3454	0.375	(±.0045)	3	(±.012)	4.1445
0.125	(±.0035)	1	(±.0068)	0.4605	0.375	(±.0045)	4	(±.012)	5.526
0.125	(±.0035)	1.25	(±.0068)	0.5756	0.375	(±.006)	6	(±.018)	8.289
0.125	(±.0035)	1.5	(±.0068)	0.6908	0.5	(±.004)	0.625	(±.005)	1.1513
0.125	(±.0035)	1.75	(±.0068)	0.8059	0.5	(±.004)	0.75	(±.005)	1.3815
0.125	(±.0043)	2	(±.0098)	0.921	0.5	(±.004)	0.875	(±.005)	1.6118
0.125	(±.0043)	2.5	(±.0098)	1.1513	0.5	(±.004)	1	(±.005)	1.842
0.125	(±.0043)	3	(±.0098)	1.3815	0.5	(±.004)	1.25	(±.005)	2.3025
0.1875	(±.0035)	0.25	(±.0039)	0.1727	0.5	(±.0045)	1.5	(±.008)	2.763
0.1875	(±.0035)	0.375	(±.0039)	0.259	0.5	(±.0045)	1.75	(±.008)	3.2235
0.1875	(±.0035)	0.5	(±.0039)	0.3454	0.5	(±.0045)	2	(±.008)	3.684
0.1875	(±.0035)	0.625	(±.0039)	0.4318	0.5	(±.0045)	2.5	(±.012)	4.605
0.1875	(±.0035)	0.75	(±.0059)	0.518	0.5	(±.0045)	3	(±.012)	5.526
0.1875	(±.0035)	0.875	(±.0059)	0.6044	0.5	(±.0045)	3.5	(±.012)	6.447
0.1875	(±.0035)	1	(±.0068)	0.6908	0.5	(±.0045)	4	(±.012)	7.368
0.1875	(±.0035)	1.25	(±.0068)	0.8635	0.5	(±.006)	5	(±.015)	9.21
0.1875	(±.0035)	1.5	(±.0068)	1.0361	0.5	(±.006)	6	(±.018)	11.052
0.1875	(±.0043)	2	(±.0098)	1.3815	0.625	(±.0045)	0.75	(±.005)	1.7269
0.1875	(±.0043)	2.5	(±.0098)	1.7269	0.625	(±.0045)	0.875	(±.005)	2.0148
0.1875	(±.0043)	3	(±.0098)	2.0723	0.625	(±.0045)	1	(±.005)	2.3025
0.1875	(±.0047)	4	(±.0188)	2.763	0.625	(±.0045)	1.25	(±.005)	2.8781
0.25	(±.0035)	0.3125	(±.0035)	0.2878	0.625	(±.005)	1.5	(±.008)	3.4538
0.25	(±.0035)	0.375	(±.0035)	0.3454	0.625	(±.005)	1.75	(±.008)	4.0294
0.25	(±.0035)	0.5	(±.0035)	0.4605	0.625	(±.005)	2	(±.008)	4.605
0.25	(±.004)	0.625	(±.005)	0.5756	0.625	(±.005)	2.5	(±.012)	5.7563
0.25	(±.004)	0.75	(±.005)	0.6908	0.625	(±.005)	3	(±.012)	6.9075
0.25	(±.004)	1	(±.005)	0.921	0.625	(±.005)	4	(±.012)	9.21
0.25	(±.004)	1.25	(±.005)	1.1513	0.75	(±.0045)	0.875	(±.005)	2.4176
0.25	(±.0045)	1.5	(±.008)	1.3815	0.75	(±.0045)	1	(±.005)	2.763
0.25	(±.0045)	1.75	(±.008)	1.6118	0.75	(±.0045)	1.25	(±.005)	3.4538
0.25	(±.0045)	2	(±.008)	1.842	0.75	(±.005)	1.5	(±.008)	4.1445
0.25	(±.0045)	2.25	(±.012)	2.0723	0.75	(±.005)	1.75	(±.008)	4.8353
0.25	(±.0045)	2.5	(±.012)	2.3025	0.75	(±.005)	2	(±.008)	5.526
0.25	(±.0045)	3	(±.012)	2.763	0.75	(±.005)	2.5	(±.012)	6.9075
0.25	(±.0045)	4	(±.012)	3.684	0.75	(±.005)	3	(±.012)	8.289
0.3125	(±.0035)	0.375	(±.0035)	0.4318	0.75	(±.005)	4	(±.012)	11.052
0.3125	(±.0035)	0.5	(±.0035)	0.5756	0.875	(±.0045)	1	(±.005)	3.2235
0.3125	(±.004)	0.625	(±.005)	0.7195	0.875	(±.005)	1.5	(±.008)	4.8353
0.3125	(±.004)	0.75	(±.005)	0.8635	0.875	(±.005)	2	(±.008)	6.447
0.3125	(±.004)	1	(±.005)	1.1513	1	(±.0045)	1.25	(±.005)	4.605
0.3125	(±.0045)	1.5	(±.008)	1.7269	1	(±.005)	1.5	(±.008)	5.526
0.3125	(±.0045)	2	(±.008)	2.3025	1	(±.005)	1.75	(±.008)	6.447
0.375	(±.0035)	0.5	(±.0035)	0.6908	1	(±.005)	2	(±.008)	7.368
0.375	(±.004)	0.625	(±.005)	0.8635	1	(±.005)	2.5	(±.012)	9.21
0.375	(±.004)	0.75	(±.005)	1.0361	1	(±.005)	3	(±.012)	11.052
0.375	(±.004)	0.875	(±.005)	1.2088	1	(±.005)	3.5	(±.012)	12.894
0.375	(±.004)	1	(±.005)	1.3815	1	(±.007)	4	(±.012)	14.736
0.375	(±.004)	1.25	(±.005)	1.7269	1	(±.007)	6	(±.018)	22.104

Continued next page



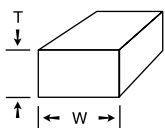

Continued from previous page

C36000
Rectangular Free-Cutting Brass Bar
H02 (half-hard)

12 Foot Mill Lengths
ASTM B16

Thickness (Inches)	Thickness Tolerance	Width (Inches)	Width Tolerance	Pounds Per Foot	Thickness (Inches)	Thickness Tolerance	Width (Inches)	Width Tolerance	Pounds Per Foot
1.25	(±.005)	1.5	(±.008)	6.9075	1.5	(±.006)	4	(±.012)	22.104
1.25	(±.005)	1.75	(±.008)	8.0588	1.75	(±.005)	2	(±.008)	12.894
1.25	(±.005)	2	(±.008)	9.21	1.75	(±.006)	2.5	(±.012)	16.1175
1.25	(±.006)	2.5	(±.012)	11.5125	1.75	(±.006)	3	(±.012)	19.341
1.25	(±.006)	3	(±.012)	13.815	2	(±.006)	2.5	(±.012)	18.42
1.25	(±.006)	4	(±.012)	18.42	2	(±.006)	3	(±.012)	22.104
1.375	(±.005)	1.75	(±.008)	8.8646	2	(±.006)	4	(±.012)	29.472
1.5	(±.005)	2	(±.008)	11.052	2.5	(±.014)	3.5	(±.02)	32.235
1.5	(±.006)	2.5	(±.012)	13.815					
1.5	(±.006)	3	(±.012)	16.578					

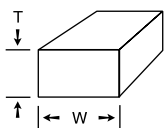

C36000
Rectangular Free-Cutting Brass Bar
Extruded
H02 (half-hard)

12 Foot Mill Lengths
ASTM B16

Thickness (Inches)	Thickness Tolerance	Width (Inches)	Width Tolerance	Pounds Per Foot	Thickness (Inches)	Thickness Tolerance	Width (Inches)	Width Tolerance	Pounds Per Foot
0.0937	(±.010)	1	(±.015)	0.3452	0.5	(±.010)	1	(±.015)	1.842
0.125	(±.010)	0.25	(±.010)	0.1151	0.5	(±.010)	1.25	(±.015)	2.3025
0.125	(±.010)	0.625	(±.010)	0.2878	0.5	(±.010)	1.5	(±.015)	2.763
0.125	(±.010)	0.75	(±.010)	0.3454	0.5	(±.010)	2.5	(±.025)	4.605
0.125	(±.010)	1	(±.015)	0.4605	0.5	(±.010)	5	(±.070)	9.21
0.125	(±.010)	1.25	(±.015)	0.5756	0.5	(±.010)	6	(±.090)	11.052
0.125	(±.010)	4	(±.060)	1.842	0.625	(±.010)	2	(±.025)	4.605
0.1875	(±.010)	0.5	(±.010)	0.3454	0.625	(±.010)	4	(±.060)	9.21
0.1875	(±.010)	1	(±.015)	0.6908	0.75	(±.010)	3	(±.035)	8.289
0.1875	(±.010)	2	(±.025)	1.3815	0.85	(±.01)	2.85	(±.015)	8.925
0.1875	(±.010)	3	(±.035)	2.0723	1	(±.010)	2.5	(±.025)	9.21
0.25	(±.010)	0.5	(±.010)	0.4605	1	(±.010)	3	(±.035)	11.052
0.25	(±.010)	1	(±.015)	0.921	1	(±.010)	4	(±.060)	14.736
0.25	(±.010)	1.5	(±.015)	1.3815	1	(±.012)	5	(±.024)	18.42
0.25	(±.010)	1.75	(±.015)	1.6118	1	(±.010)	6	(±.090)	22.104
0.25	(±.010)	2	(±.025)	1.842	1.25	(±.020)	1.75	(±.020)	8.0588
0.25	(±.010)	2.5	(±.025)	2.3025	1.25	(±.020)	2.5	(±.025)	11.5125
0.25	(±.010)	3	(±.030)	2.763	1.25	(±.020)	3	(±.035)	13.815
0.25	(±.010)	4	(±.060)	3.684	1.25	(±.014)	5	(±.024)	23.025
0.3125	(±.010)	1	(±.015)	1.1513	1.5	(±.025)	2.5	(±.025)	13.815
0.3125	(±.010)	1.25	(±.015)	1.4391	1.5	(±.025)	3	(±.035)	16.578
0.375	(±.010)	1	(±.015)	1.3815	1.5	(±.025)	4	(±.060)	22.104
0.375	(±.010)	2	(±.025)	2.763	1.75	(±.030)	2	(±.025)	12.894
0.375	(±.010)	6	(±.090)	8.289					
0.5	(±.010)	0.625	(±.010)	1.1513					
0.5	(±.010)	0.75	(±.010)	1.3815					

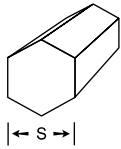

C36000
Hexagon Free-Cutting Brass Bar
Rounded Corner
H02 (half-hard)

12 Foot Mill Lengths
 ASTM B16

Size (Inches)	Size Tolerance	Pounds Per Foot
0.3125	(±.003)	0.3118
0.375	(±.003)	0.4067
0.4375	(±.003)	0.6049
0.5	(±.003)	0.794
0.5625	(±.004)	1.0052
0.625	(±.004)	1.2421
0.6875	(±.004)	1.5021
0.75	(±.004)	1.788
0.8125	(±.004)	2.0988
0.875	(±.004)	2.428
0.9375	(±.004)	2.7932
1	(±.004)	3.1788
1.0625	(±.005)	3.5884
1.125	(±.005)	4.022
1.1875	(±.005)	4.5023
1.25	(±.005)	4.962
1.3125	(±.005)	5.465
1.375	(±.005)	6.0363
1.5	(±.005)	7.148
1.625	(±.005)	8.4309
1.75	(±.005)	9.778
1.875	(±.005)	11.2246
2	(±.005)	12.702
2.25	(±.007)	16.0764

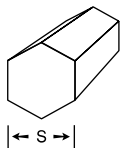

C36000
Hexagon Free-Cutting Brass Bar
Stress Relieved Annealed
H02 (half-hard)

12 Foot Mill Lengths
 ASTM B16

Size (Inches)	Size Tolerance	Pounds Per Foot
1.5	(±.005)	7.1838
2	(±.005)	12.7712
3.5	(±.011)	39.1118

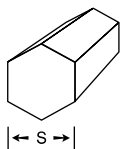

C36000
Hexagon Free-Cutting Brass Bar
Thread Roll Quality
H02 (half-hard)

12 Foot Mill Lengths
 ASTM B16

Size (Inches)	Size Tolerance	Pounds Per Foot
0.75	(±.004)	1.7994

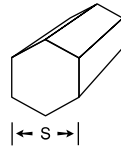

C36000
Hexagon Free-Cutting Brass Bar
H02 (half-hard)

12 Foot Mill Lengths
 ASTM B16

Size (Inches)	Size Tolerance	Pounds Per Foot
0.125	(±.0025)	0.0498
0.1562	(±.003)	0.0779
0.1875	(±.003)	0.1122
0.2187	(±.003)	0.1528
0.25	(±.003)	0.1996
0.2812	(±.003)	0.2525
0.3125	(±.003)	0.3118
0.3437	(±.003)	0.3772
0.375	(±.003)	0.4489
0.4375	(±.003)	0.6111
0.5	(±.003)	0.7982
0.5625	(±.004)	1.0102
0.625	(±.004)	1.2471
0.6875	(±.004)	1.5091
0.75	(±.004)	1.796
0.8125	(±.004)	2.1077
0.875	(±.004)	2.4445
0.9375	(±.004)	2.8062
0.984	(±.004)	2.8001
1	(±.004)	3.1928
1.0625	(±.005)	3.6044
1.125	(±.005)	4.0408
1.1875	(±.005)	4.5023
1.25	(±.005)	4.9888
1.3125	(±.005)	5.5001
1.375	(±.005)	6.0363
1.4375	(±.005)	6.5976
1.5	(±.005)	7.1838
1.625	(±.005)	8.4309
1.6875	(±.005)	9.092
1.75	(±.005)	9.778
1.875	(±.005)	11.2246
2	(±.005)	12.7712
2.125	(±.006)	14.4174
2.25	(±.006)	16.1636
2.375	(±.007)	18.0093
2.5	(±.008)	19.955
2.625	(±.008)	22.0003
2.75	(±.008)	24.1456
2.875	(±.009)	26.3905
3	(±.009)	28.7352
3.25	(±.010)	33.724
3.5	(±.011)	39.1118



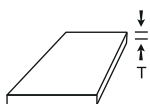

C36500
Leaded Muntz Metal Plate
M20 (as hot rolled)
 ASTM B171

Thickness (Inches)	Thickness Tolerance	Pounds Per Square Foot
0.25	(±.027)	10.9440
0.375	(±.025)	16.4160
0.375	(±.027)	16.4160
0.5	(±.025)	21.8880
0.5	(±.027)	21.8880
0.625	(±.030)	27.3600
0.75	(±.028)	32.8320
0.75	(±.030)	32.8320
1	(±.035)	43.7760
1.25	(±.040)	54.7200
1.5	(±.040)	65.6640
1.75	(±.045)	76.6080
2	(±.055)	87.5520
2.5	(±.062)	109.4400
3	(±.062)	131.3280
3.5	(±.062)	153.2160



Our precision plate saws hold tight tolerances with finished edges.

C38500 Architectural Bronze

Nominal Composition

Copper: 57%
 Lead: 3%
 Tin: 40%
 Note: Cu + Sum of Named Elements, 99.5% min.

Physical Properties

Melting Point (Liquidus):	1,630°F
Melting Point (Solidus):	1,610°F
Density at 68°F:	0.306 lb/in ³
Specific Gravity:	8.470
Coefficient of Linear Thermal Expansion per °F:	11.6 x 10 ⁻⁶ (68-572°F)
Electrical Conductivity at 68°F (volumetric):	28% IACS
Thermal Conductivity:	71 Btu/ft ² /ft/hr/°F at 68°F
Modulus of Elasticity - Tension:	17,000 ksi

Mechanical Properties at 68°F

Shape	Tensile Strength (psi)	Yield Strength (0.5% Ext.) (psi)	% Elongation (in 2")	Rockwell Hardness
1.0" Section — M30 (as hot extruded)	60,000	20,000	30	HRB 65

Description

This alloy is similar to C36000 Free Cutting Brass with the main difference being a slightly higher lead content in C36000 for better machinability. The machinability rating for C38500 is 90 compared to 100 for C36000.

Common Fabrication Processes

Hot forging and pressing, hot forming and bending, and machining.

Joining

Joining by soldering is excellent and brazing is good. In general, welding is not recommended, however, butt welding is fair.

Hot and Cold Working

Capacity for Being Cold Worked: Poor

Capacity for Being Hot Formed: Excellent

Machinability Rating

Relative Machinability: 90 (free cutting brass = 100)

Typical Uses

Architecture: handrails, thresholds, terrazzo strip, shower doors, privacy sun grills, trim, store fronts, architectural forgings, extrusions, architectural moldings, window mullions, bathroom partition brackets, door frames, elevator trim.

Builders Hardware: lock bodies, drawer pulls, slide bolts, drawer handles, lock cams, hinges.

Consumer: straight edges, picture frames, fireplace screens, lamps, handles.

Industrial: valve seats, valves, gauges, forgings, valve stems, valve trim, wheeled racks.

Applicable Specifications

When so specified, C38500 shapes will be supplied to ASTM B455.

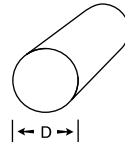

C38500 Round Architectural Bronze Bar H02 (half hard)

12 Foot Mill Lengths
 ASTM B455

Diameter (Inches)	Diameter Tolerance	Pounds Per Foot
0.25	(±.0015)	0.1802
0.5	(±.0015)	0.7206
0.75	(±.002)	1.6214
1	(±.002)	2.883

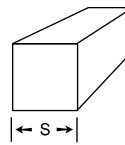

C38500 Square Architectural Bronze Bar H02 (half-hard)

12 Foot Mill Lengths
 ASTM B455

Size (Inches)	Size Tolerance	Pounds Per Foot
0.5	(±.0035)	0.918
0.75	(±.0045)	2.0655
1	(±.0045)	3.672



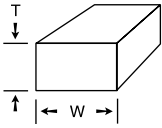

C38500
Rectangular Architectural
Bronze Bar
H02 (half-hard)

12 Foot Mill Lengths
ASTM B455

Thickness (Inches)	Thickness Tolerance	Width (Inches)	Width Tolerance	Pounds Per Foot
0.125	(±.010)	0.5	(±.010)	0.2295
0.125	(±.010)	0.75	(±.010)	0.3443
0.125	(±.010)	1	(±.015)	0.459
0.125	(±.010)	1.5	(±.015)	0.6885
0.125	(±.010)	2	(±.025)	0.918
0.1875	(±.010)	1	(±.015)	0.6885
0.25	(±.010)	0.5	(±.010)	0.459
0.25	(±.010)	0.75	(±.010)	0.6885
0.25	(±.010)	1	(±.015)	0.918
0.25	(±.010)	1.25	(±.015)	1.1475
0.25	(±.010)	1.5	(±.015)	1.377
0.25	(±.010)	2	(±.025)	1.836
0.25	(±.010)	2.5	(±.025)	2.295
0.25	(±.010)	3	(±.035)	2.754
0.25	(±.010)	4	(±.025)	3.672
0.25	(±.010)	4	(±.060)	3.672
0.375	(±.010)	0.5	(±.010)	0.6885
0.375	(±.010)	0.75	(±.010)	1.0328
0.375	(±.010)	1	(±.015)	1.377
0.375	(±.010)	1.5	(±.015)	2.0655
0.375	(±.010)	2	(±.025)	2.754
0.375	(±.010)	3	(±.035)	4.131
0.5	(±.010)	0.75	(±.010)	1.377
0.5	(±.010)	1	(±.015)	1.836
0.5	(±.010)	1.25	(±.015)	2.295
0.5	(±.010)	2	(±.025)	3.672
0.5	(±.010)	2.5	(±.025)	4.59
0.75	(±.010)	1	(±.015)	2.754
0.75	(±.010)	2	(±.025)	5.508

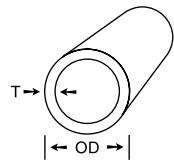

C38500
Round Architectural
Bronze Tube
Extruded
H02 (half-hard)

12 Foot Mill Lengths

OD (Inches)	Thickness (Inches)	Pounds Per Foot
1.5	0.125	1.9828
1.9	0.125	2.5596

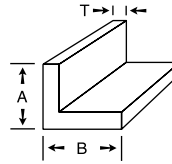

C38500
Architectural Bronze Angle
Extruded
H02 (half-hard)

12 Foot Mill Lengths
ASTM B455

Thickness (Inches)	Leg A (Inches)	Leg B (Inches)	Pounds Per Foot
*0.062	0.75	0.75	0.327
0.0625	0.5	0.5	0.227
0.125	0.5	1	0.631
0.125	0.5	0.5	0.402
0.125	0.625	0.625	0.516
0.125	0.75	0.75	0.634
0.125	0.75	1	0.746
0.125	1	1	0.861
0.125	1	2	1.32
0.125	1.25	1.25	1.09
0.125	1.5	1.5	1.32
0.125	2	2	1.779
0.1875	1	1	1.248
0.1875	1.25	1.25	1.592
0.1875	1.5	1.5	1.937
0.1875	2	2	2.625
0.25	1.5	1.5	2.525
0.25	2	2	3.443
0.25	3	3	5.279

*M30 (as hot extruded)

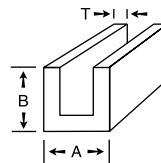

C38500
Architectural Bronze Channel
Extruded
H02 (half-hard)

12 Foot Mill Lengths
ASTM B455

Base A (Inches)	Thickness (Inches)	Leg B (Inches)	Pounds Per Foot
0.5	0.093	0.5	0.449
0.625	0.1	0.625	0.625
0.75	0.093	0.75	0.705
0.75	0.125	0.75	0.861
1	0.125	0.5	0.803
1	0.125	1	1.262
1.25	0.125	0.5	0.918
1.5	0.125	0.5	1.033
1.5	0.125	1	1.492
1.5	0.125	1.5	1.951

C44300 Admiralty (Arsenical) Brass

Nominal Composition

Copper: 71%
 Arsenic: 0.4%
 Tin: 1.0%
 Zinc: 28%

Physical Properties

Melting Point - Liquidus: 1,720°F
 Melting Point - Solidus: 1,650°F
 Density: 0.308 lb/in³ at 68°F
 Specific Gravity: 8.530
 Electrical Resistivity: 41.50 ohms-cmil/ft @ 68°F
 Electrical Conductivity: 25% IACS @ 68°F
 Thermal Conductivity: 64 Btu/ft/hr/ft²/°F at 68°F
 Coefficient of Thermal Expansion: 11.20 x 10⁻⁶/°F (68-572°F)
 Specific Heat Capacity: 0.090 Btu/lb/°F at 68°F
 Modulus of Elasticity in Tension: 16,000 ksi
 Modulus of Rigidity: 6,000 ksi

Fabrication Properties

Soldering: Excellent
 Brazing: Excellent
 Oxyacetylene Welding: Good
 Gas Shielded Arc Welding: Fair
 Coated Metal Arc Welding: Not Recommended
 Spot Welding: Good
 Seam Welding: Not Recommended
 Butt Welding: Good
 Capacity for Being Cold Worked: Excellent
 Capacity for Being Hot Formed: Fair
 Machinability Rating: 30

Thermal Properties

Annealing: 800 - 1,100°F
 Hot Works: 1,200 - 1,450°F

Typical Mechanical Properties (68°F)

Product Form Temper	Tensile Strength (psi)	Yield Strength (0.5% ext.) (psi)	% Elongation (in 2")	Rockwell Hardness
Plate, 1" M20	48,000	18,000	65	70F
Wire, 0.08" OS015	55,000	-	60	-
Tube OS025	53,000	22,000	65	75F

Applicable Specifications

Plate, Clad: ASTM B432
 Plate, Condenser: ASME SB171, ASTM B171
 Tube: ASTM B135
 Tube, Condenser: ASME SB111, ASTM B111
 Tube, Finned: ASME SB359, ASTM B359
 Tube, U-Bend: ASME SB395, ASTM B395
 Tube, Welded: ASME SB543, ASTM B543

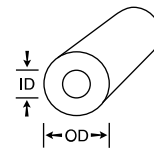

C44300 Round Admiralty Brass Hollow Bar H80 (hard-drawn)

12 Foot Mill Lengths
ASTM B135

OD (Inches)	ID (Inches)	Pounds Per Foot
1.625	1.232	3.3523
1.75	1.313	3.9621
1.75	1.482	2.6145
1.875	1.48	3.9641
2.125	1.73	4.5531
2.25	1.563	7.6831
2.25	1.728	6.1941
2.25	1.813	5.7086
2.25	1.982	3.4154
2.312	1.982	4.2683
2.75	2.228	7.6419
2.75	2.482	4.2347
3.25	2.727	9.2996

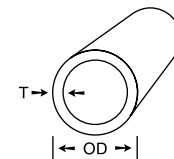

C44300 Round Admiralty Brass Tube H80 (hard-drawn)

12 Foot Mill Lengths
ASTM B135

OD (Inches)	Thickness (Inches)	Pounds Per Foot
1.5	0.134	2.2138
2.312	0.166	4.2683

Description

Admiralty brass, C44300, has good corrosion resistance and is commonly used for tubing in steam condensers cooled with fresh, salt or brackish water. C44300 metal tubes are also used for heat exchangers in oil refineries, in which corrosion from sulfur compounds and contaminated water may be very severe, and for feed-water heaters and heat-exchanger equipment as well as other industrial processes.

Typical Applications

Oil well pump liners, evaporator tubing, heat exchanger tubing, condenser tube plates, distiller tubes, ferrules, bourdon tubes, condenser tubes, and strainers.



C46400 Naval Brass

Nominal Composition

Copper:	60%
Zinc:	39.2%
Tin:	0.8%

Physical Properties

Melting Point (Liquidus):	900°C (1,650°F)
Melting Point (Solidus):	885°C (1,630°F)
Density at 68°F:	0.304 lb/in ³
Coefficient of Linear Thermal Expansion:	1.18 x 10 ⁻⁵ /°F (68-572°F)
Electrical Conductivity at 68°F (volumetric):	26% IACS (in the annealed condition; lower in hard temper)
Thermal Conductivity:	67 Btu/ft ² /hr/°F at 68°F
Modulus of Elasticity - Tension:	15,000 ksi
Modulus of Rigidity:	5,600 ksi

Fabrication Properties

Hot Working Temperature:	1,200-1,500°F
Annealing Temperature:	800-1,100°F
Relative Machinability:	30 (Free cutting brass = 100)

Mechanical Properties

Rod	Tensile Strength (psi)	Yield Strength (0.5% Ext.) (psi)	% Elongation (in 2")	Rockwell Hardness
0.250" Dia. —				
O60	58,000	27,000	45	HRB 56
O50	63,000	30,000	40	HRB 60
H01	70,000	48,000	25	HRB 80
H02	80,000	57,000	20	HRB 85
1.0" Dia. —				
O60	57,000	25,000	47	HRB 55
O50	63,000	30,000	40	HRB 60
H01	69,000	46,000	27	HRB 78
H02	75,000	53,000	20	HRB 82
2.0" Dia. —				
O60	56,000	25,000	47	HRB 55
O50	62,000	28,000	43	HRB 60
H01	67,000	40,000	35	HRB 75

Description

Naval brass C46400 is nominally composed of 60% copper, 39.2% zinc and 0.8% tin. As is typical of brass alloys with the duplex alpha + beta structure, C46400 has good strength and rigidity. By substituting tin for an equal quantity of zinc, a high corrosion resistance to seawater is achieved. The addition of tin also gives the alloy an inherent resistance to dezincification, thereby further inhibiting the impingement by seawater at higher than normal temperatures. The alloy is also noted for its resistance to wear, fatigue, galling, and stress corrosion cracking.

Hot Working and Cold Working

C46400 has excellent hot workability and fair cold workability. Characteristically, it becomes extremely plastic when hot, and is well adapted to any hot working process including hot forging and pressing, and hot heading and upsetting. It can be cold worked to a moderate degree using processes such as blanking, drawing, forming, bending, shearing, heading and upsetting.

Joining

Joining by soldering and brazing is excellent; by oxyacetylene welding, good; and by gas shielded arc welding, fair.

Applications

Considered the most widely used of the tin brasses, C46400 rod is used to fabricate a variety of nuts, bolts, rivets, bearings, bushings, lock pins, valve stems, pump and propeller shafts, and marine hardware.

Applicable Specifications

When so specified, C46400 will be manufactured to the following current specifications: ASTM Specifications B21 and B124, AMS Specifications 4611, 4612.

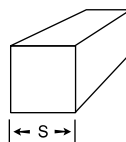

C46400 Square Naval Brass Bar H02 (half-hard)

12 Foot Mill Lengths
ASTM B21

Size (Inches)	Size Tolerance	Pounds Per Foot
0.75	(±.0045)	2.052
1	(±.0045)	3.648
2	(±.005)	14.592

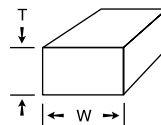

C46400 Rectangular Naval Brass Bar H02 (half-hard)

12 Foot Mill Lengths
ASTM B21

Thickness (Inches)	Thickness Tolerance	Width (Inches)	Width Tolerance	Pounds Per Foot
0.5	(±.005)	2	(±.008)	3.648
1	(±.005)	2	(±.008)	7.296
1.25	(±.005)	2	(±.008)	9.12

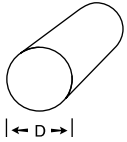

C46400 Round Naval Brass Bar

12 Foot Mill Lengths
ASTM B21

Diameter (Inches)	Diameter Tolerance	Temper	Pounds Per Foot
0.1875	(±.0015)	H02 (half-hard)	0.1007
0.25	(±.0015)	H02 (half-hard)	0.179
0.3125	(±.0015)	H02 (half-hard)	0.2797
0.375	(±.0015)	H02 (half-hard)	0.4027
0.4375	(±.0015)	H02 (half-hard)	0.5481
0.5	(±.0015)	H02 (half-hard)	0.7159
0.5625	(±.002)	H02 (half-hard)	0.9061
0.625	(±.002)	H02 (half-hard)	1.1186
0.75	(±.002)	H02 (half-hard)	1.6108
0.875	(±.002)	H02 (half-hard)	2.1925
1	(±.002)	H02 (half-hard)	2.8637
1.125	(±.0025)	H02 (half-hard)	3.6243
1.25	(±.0025)	H02 (half-hard)	4.4745
1.375	(±.0025)	H02 (half-hard)	5.4141
1.5	(±.0025)	H02 (half-hard)	6.4433
1.625	(±.0025)	H02 (half-hard)	7.5619
1.75	(±.0025)	H02 (half-hard)	8.77
1.875	(±.0025)	H02 (half-hard)	10.0676
2	(±.0025)	H02 (half-hard)	11.4547
2.25	(±.003)	H02 (half-hard)	14.4974
2.5	(±.004)	H02 (half-hard)	17.898
2.75	(±.004)	H02 (half-hard)	21.6566
3	(±.035)	M30 (as hot extruded)	25.7731
3.25	(±.035)	M30 (as hot extruded)	30.2476
3.5	(±.035)	M30 (as hot extruded)	35.0801
3.75	(±.060)	M30 (as hot extruded)	40.2705
4	(±.060)	M30 (as hot extruded)	45.8189
4.5	(±.060)	M30 (as hot extruded)	57.9895
4.5	(±.060)	M30 (as hot extruded)	57.9895
6	(±.060)	M30 (as hot extruded)	103.093

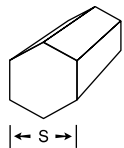

C46400 Hexagon Naval Brass Bar H02 (half-hard)

12 Foot Mill Lengths
ASTM B21

Size (Inches)	Size Tolerance	Pounds Per Foot
0.625	(±.004)	1.235
0.687	(±.004)	1.4922
0.875	(±.004)	2.4206
1	(±.004)	3.1616
1.25	(±.005)	4.94
1.5	(±.005)	7.1136
2	(±.005)	12.6464

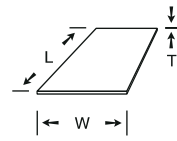

C46400 Naval Brass Sheet

ASTM B171

Thickness (Inches)	Width x Length (Inches)	Pounds Per Square Foot
0.04	48 x 120	1.7510
0.04	48 x 96	1.7510
0.05	48 x 96	2.1888
0.064	48 x 144	2.8017
0.125	48 x 120	5.4720
0.125	48 x 96	5.4720

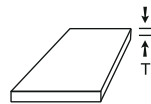

C46400 Diamondized Naval Brass Plate

ASTM B171

Thickness (Inches)	Thickness Tolerance	Pounds Per Square Foot
0.25	(+.000 -.004)	10.9440
0.375	(±.005)	16.4160
0.5	(+.000 -.004)	21.8880
0.625	(+.000 -.004)	27.3600
1	(+.000 -.004)	43.7760
1.25	(+.000 -.004)	54.7200

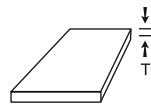

C46400 Naval Brass Plate M20 (as hot rolled)

ASTM B171

Thickness (Inches)	Thickness Tolerance	Pounds Per Square Foot
0.25	(±.022)	10.9440
0.375	(±.029)	16.4160
0.5	(±.029)	21.8880
0.625	(±.032)	27.3600
0.75	(±.032)	32.8320
1	(±.042)	43.7760
1.125	(±.042)	49.2480
1.25	(±.042)	54.7200
1.5	(±.042)	65.6640
1.75	(±.042)	76.6080
2	(±.062)	87.5520



C48500 Leaded Naval Brass

Nominal Composition

Copper: 60%
Zinc: 37.5%
Lead: 1.8%
Tin: 0.7%

Physical Properties

Melting Point (Liquidus):	900°C (1,650°F)
Melting Point (Solidus):	885°C (1,630°F)
Density at 68°F:	0.305 lb/in ³
Coefficient of Linear Thermal Expansion per °F:	1.18 x 10 ⁻⁵ (68-572°F)
Electrical Conductivity at 68°F (volumetric):	26% IACS (in the annealed condition; lower in hard temper)
Thermal Conductivity:	67 Btu/ft ² /ft/hr/°F at 68°F
Modulus of Elasticity - Tension:	15,000 ksi
Modulus of Rigidity:	5,600 ksi

Fabrication Properties

Hot Working Temperature:	650-750°C (1,200-1,400°F)
Annealing Temperature:	425-600°C (800-1,100°F)
Approximate Relative Machinability:	70 (Free cutting brass arbitrarily rated at 100.)

Mechanical Properties

Rod	Tensile Strength (psi)	Yield Strength (0.5% Ext.) (psi)	% Elongation (in 2")	Rockwell Hardness
1.0" Dia. —				
O60	57,000	25,000	40	HRB 55
H01	69,000	46,000	20	HRB 78
H02	75,000	53,000	15	HRB 82

Description

Leaded naval brass C48500 is nominally composed of 60% copper, 37.5% zinc, 1.8% lead, and 0.7% tin. As is typical of brass alloys with the duplex alpha + beta structure, C48500 has good strength and rigidity. By substituting tin for an equal quantity of zinc, a high corrosion resistance to seawater is achieved. The addition of tin also gives the alloy an inherent resistance to dezincification, thereby further inhibiting the impingement by seawater at higher than normal temperatures. The addition of lead improves machinability, so C48500 is used in machining applications where unleaded Naval Brass C46400 might be the choice. The alloy is also noted for its resistance to wear, fatigue, galling, and stress corrosion cracking.

Hot Working

C48500 has good hot workability. Characteristically it becomes extremely plastic when hot and is fairly well adapted to any hot working process including hot forging and pressing and hot heading and upsetting.

Cold Working

Due to its lead content, C48500 has poor cold workability. Because it can be cold worked only to a very limited degree, it is used for machining applications rather than typical cold working operations such as blanking, drawing, forming, bending, shearing, heading and upsetting.

Joining

Joining by soldering is excellent, while good by brazing. The lead content prevents successful welding.

Applications

C48500 is typically used for fasteners, valve stems, screw machine products, and marine hardware.

Applicable Specifications

When so specified, C48500 will be manufactured to the following current specifications: ASTM Specifications B21 and B124.



C48500 Round High Leaded Naval Brass Bar H02 (half hard)

12 Foot Mill Lengths
ASTM B21

Diameter (Inches)	Diameter Tolerance	Pounds Per Foot
0.25	(±.0015)	0.1796
0.2812	(±.0015)	0.2272
0.375	(±.0015)	0.404
0.4375	(±.0015)	0.5499
0.5	(±.0015)	0.7188
0.5625	(±.002)	0.92
0.625	(±.002)	1.1223
0.75	(±.002)	1.6161
0.875	(±.002)	2.1997
1	(±.002)	2.8731
1.125	(±.0025)	3.6363
1.25	(±.0025)	4.4892
1.3125	(±.0025)	4.9494
1.375	(±.0025)	5.432
1.5	(±.0025)	6.4645
1.625	(±.0025)	7.5868
1.75	(±.0025)	8.7989
2	(±.0025)	11.4924
2.0625	(±.003)	12.2219
*3	(±.005)	25.8579

*M30 (as hot extruded)

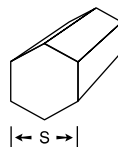

C48500 Hexagon High Leaded Naval Brass Bar H02 (half-hard)

12 Foot Mill Lengths
ASTM B21

Size (Inches)	Pounds Per Foot
0.875	2.4286
1.25	4.9563

C51000 Phosphor Bronze, 5% A

Nominal Chemical Composition %

Copper:	94.8
Tin:	5.0
Phosphorus:	0.2
Zinc:	0.3 max.
Iron:	0.1 max.
Lead:	0.05 max.
Note: Cu + Sum of Named Elements, 99.5% min.	

Physical Properties

Melting Point - Liquidus:	1,920°F
Melting Point - Solidus:	1,750°F
Density:	0.320 lb/in ³ at 68°F
Specific Gravity:	8.860
Electrical Resistivity:	69.10 ohms-cmil/ft @ 68°F
Electrical Conductivity:*	15% IACS @ 68°F
Thermal Conductivity:	40 Btu/ft/hr/ft ² /oF at 68°F
Coefficient of Thermal Expansion:	9.90 x 10 ⁻⁶ /oF (68-572°F)
Specific Heat Capacity:	0.090 Btu/lb/oF at 68°F
Modulus of Elasticity in Tension:	16,000 ksi
Modulus of Rigidity:	6,000 ksi

*Determined on an alloy containing 5% tin and .2% phosphorus. This value will vary with the composition.

Common Fabrication Processes

Blanking, Drawing, Forming and Bending, Heading and Upsetting, Roll Threading and Knurling, Shearing, Stamping

Fabrication Properties

Soldering:	Excellent
Brazing:	Excellent
Oxyacetylene Welding:	Fair
Gas Shielded Arc Welding:	Good
Coated Metal Arc Welding:	Fair
Spot Weld:	Good
Seam Weld:	Fair
Butt Weld	Excellent:
Capacity for Being Cold Worked:	Excellent
Capacity for Being Hot Formed:	Poor
Machinability Rating:	20

Thermal Properties

Annealing Minimum:	900°F
Annealing Maximum:	1,250°F

Typical Mechanical Properties (68°F)

Flat Products	Section Size (Inches)	Tensile Strength (ksi)	Yield Strength (0.5% ext.) (ksi)	% Elongation (in 2")	Rockwell Hardness B
H04	0.04	84	—	7	87
H06	0.04	96	—	3	93
H08	0.04	103	—	3	95
H10	0.04	107	—	2	97
OS015	0.04	53	22	50	34
OS025	0.04	50	21	52	30
OS035	0.04	49	20	58	28
OS050	0.04	47	19	64	26
Rod					
H02	0.5	75	65	25	80
H02	1	70	58	25	78
Wire					
H01	0.08	68	60	24	—
H02	0.08	85	80	8	—
H04	0.08	110	—	3	—
H06	0.08	130	—	3	—
H08	0.08	140	—	2	—
OS035	0.08	50	20	58	—

Typical Uses

Architecture: bridge bearing plates.

Electrical: Resistance wire, fuse clips, electromechanical spring components, electrical flexing contact blades, electrical connectors, electronic connectors, wire brushes, switch parts, electronic and precision instrument parts.

Fasteners: fasteners, cotter pins, lock washers.

Industrial: bourdon tubes, bellows, perforated sheets, chemical hardware, truss wire, springs, sleeve bushings, diaphragms, clutch disks, pressure responsive elements, beater bar, textile machinery, and welding rods.

Applicable Specifications

Bar:	AMS 4625, ASTM B139, ASTM B103
Bolts:	ASTM F468
Nuts:	ASTM F467
Plate:	AMS 4510, ASTM B103
Rod:	AMS 4625, ASTM B139
Screws:	ASTM F468
Shapes:	ASTM B139
Sheet:	AMS 4510, ASTM B103
Strip:	AMS 4510, ASTM B103, ASTM B888
Studs:	ASTM F468
Tube:	AMS 4625
Wire:	AMS 4720, ASTM B159



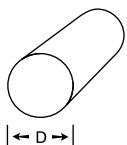

C51000
Round Grade A Phosphor Bronze Bar
H04 (hard)

12 Foot Mill Lengths
AMS 4625, ASTM B139

Diameter (Inches)	Diameter Tolerance	Pounds Per Foot	Specifications
0.25	(±.002)	0.1884	AMS 4625, ASTM B139
0.3125	(±.002)	0.2944	AMS 4625, ASTM B139
0.375	(±.002)	0.4239	AMS 4625, ASTM B139
0.5	(±.002)	0.7536	AMS 4625, ASTM B139
0.625	(±.003)	1.1775	AMS 4625, ASTM B139
0.75	(±.003)	1.6956	AMS 4625, ASTM B139
0.875	(±.003)	2.3079	AMS 4625, ASTM B139
1	(±.003)	3.0144	AMS 4625, ASTM B139
1.25	(±.004)	4.71	AMS 4625, ASTM B139
1.5	(±.004)	6.7824	AMS 4625, ASTM B139
1.75	(±.004)	9.2316	AMS 4625, ASTM B139
2.25	(±.005)	15.2604	AMS 4625, ASTM B139

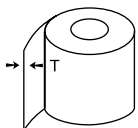

C51000
Grade A Phosphor Bronze Coil
H08 (spring)

ASTM B103

Thickness (Inches)	Thickness Tolerance	Pounds Per Square Foot
0.008	(±.0004)	0.3686
0.01	(±.0003)	0.4608
0.016	(±.0005)	0.7373
0.018	(±.0005)	0.8294
0.02	(±.00075)	0.9216
0.032	(±.0005)	1.4746
*0.04	(±.001)	1.8432
0.04	(±.0005)	1.8432
0.05	(±.001)	2.304
0.062	(±.0015)	2.857
†0.125	(±.002)	5.76

*H01 (quarter-hard)
†O60 (soft anneal)

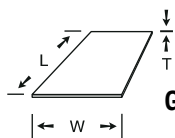

C51000
Grade A Phosphor Bronze Sheet
H08 (spring)

ASTM B103

Thickness (Inches)	Width x Length (Inches)	Pounds Per Square Foot
0.032	12 x 96	1.4746
0.04	12 x 96	1.8432
0.05	12 x 96	2.304
0.062	12 x 96	2.857
0.0937	12 x 96	4.3177
0.125	12 x 96	5.76

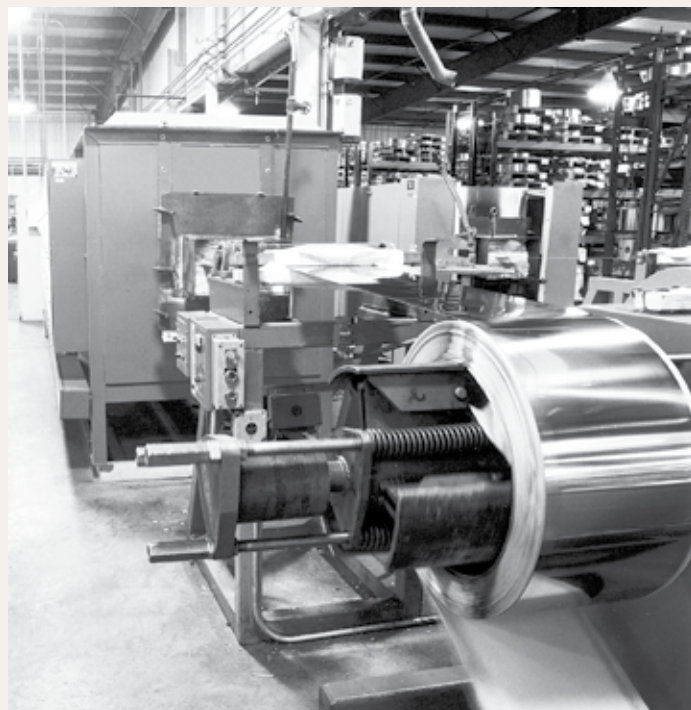

Above: Our custom-designed strand and bell annealing furnaces process copper and alloy strip plus nickel and special purpose alloys in a wide range of tempers and target grain sizes.

Below: We re-roll strip and coil on precision mills to provide customers the exact thickness of material necessary for light-gauge close-tolerance requirements. The result is the consistent thickness and uniform temper essential for critical electronic, aerospace, automotive and similar applications.

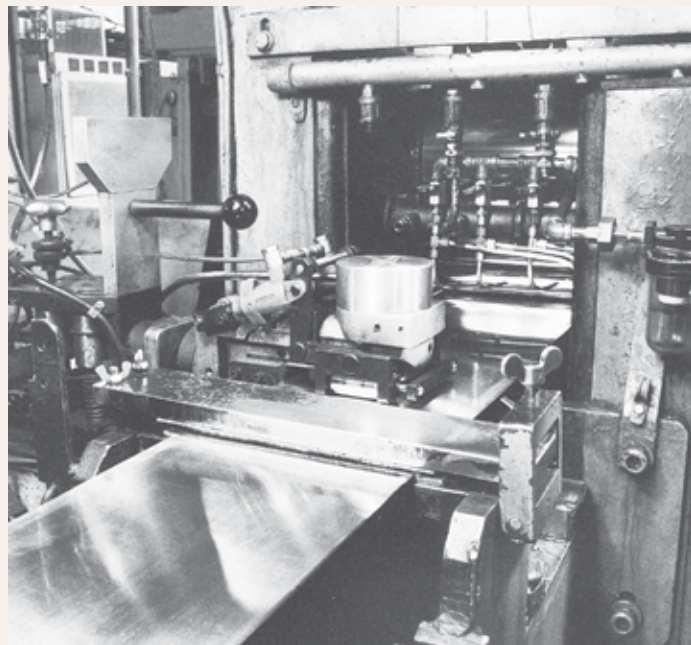

C54400 Phosphor Bronze

Nominal Composition

Copper: 87.9%
 Lead: 4.0%
 Tin: 4.0%
 Zinc: 4.0%
 Phosphorus: 0.10%

Physical Properties

Melting Point (Liquidus): 1,000°C (1,830°F)
 Melting Point (Solidus): 930°C (1,700°F)
 Density at 68°F: 0.321 lb/in³
 Coefficient of Linear Thermal Expansion per °F: 9.6 x 10⁻⁶ (68-572°F)
 Electrical Conductivity at 68°F (volumetric): 19% IACS (in the annealed condition; lower in hard temper)
 Thermal Conductivity: 50 Btu/ft²/ft/hr/°F at 68°F
 Modulus of Elasticity - Tension: 15,000 ksi
 Modulus of Rigidity: 5,600 ksi

Fabrication Properties

Annealing Temperature: 475-675°C (900-1,250°F)
 Approximate Relative Machinability: 80 (free cutting brass arbitrarily rated at 100)

Mechanical Properties

Rod	Tensile Strength (psi)	Yield Strength (0.5% Ext.) (psi)	% Elongation (in 2")	Rockwell Hardness
0.500" Dia. — H04, Hard (35%)	75,000	63,000	15	B 83
1.0" Dia. — H04, Hard (25%)	68,000	57,000	20	B 80

Description

Nominally composed of 87.9% copper, 4.0% zinc, 4.0% tin, 4.0% lead, and 0.10% phosphorus, phosphor bronze C54400 finds its primary application where strength and bearing properties are required, and, in addition, offers the corrosion resistant characteristic of the high tin phosphor bronzes. In particular, the alloy is noted for its stress corrosion cracking resistance and its high endurance limit. The high lead content makes it an extremely machinable alloy that is equaled by few in the wrought metal industry as a bearing alloy.

Hot Working

This alloy is not recommended for hot working due to its moderate tin and high lead content.

Cold Working

C54400 has good cold workability. When annealed, this alloy can be bent, formed, and cold worked. The lead content prevents severe cold working operations such as deep drawing from being successfully performed.

Joining

Joining by soldering is excellent and good by brazing. The lead content prevents successful welding.

Applications

Typical applications include bushings, bearings, shafts, gears, pinions, thrust washers, valve parts and electrical connectors.

Applicable Specifications

The standard specification for C54400 rod, bar and shapes is ASTM Specification B139. Other commercial and customer specifications may be applicable when specified.

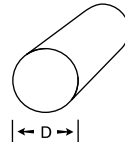

C54400 Round Phosphor Bronze Bar H04 (hard)

12 Foot Mill Lengths
 ASTM B139

Diameter (Inches)	Diameter Tolerance	Pounds Per Foot
0.1875	(±.002)	0.1063
0.25	(±.002)	0.189
0.3125	(±.002)	0.2953
0.375	(±.002)	0.4252
0.4375	(±.002)	0.5788
0.5	(±.002)	0.756
0.5625	(±.003)	0.9568
0.625	(±.003)	1.1812
0.6875	(±.003)	1.4292
0.75	(±.003)	1.7009
0.8125	(±.003)	1.9962
0.84	(±.003)	2.1336
0.875	(±.003)	2.3151
1	(±.003)	3.0238
1.125	(±.004)	3.827
1.25	(±.004)	4.7247
1.375	(±.004)	5.7169
1.5	(±.004)	6.8036
1.625	(±.004)	7.9848
1.75	(±.004)	9.2604
2	(±.004)	12.0953
2.25	(±.005)	15.3081
2.5	(±.005)	18.8989



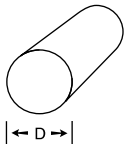

C62300 Round Extruded Aluminum Bronze Bar

12 Foot Mill Lengths
ASTM B139

Diameter (Inches)	Diameter Tolerance	Pounds Per Foot
0.75	(±.003)	1.47
1	(±.003)	2.6
1.5	(±.004)	5.86

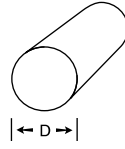

C62400 Round Aluminum Bronze Bar

12 Foot Mill Lengths
ASTM B150

Diameter (Inches)	Diameter Tolerance	Pounds Per Foot
0.375	(±.002)	0.36
0.5	(±.002)	0.64
0.5625	(±.003)	0.8
0.625	(±.003)	0.99
0.75	(±.003)	1.43
0.8125	(±.003)	1.67
0.875	(±.003)	1.94
1	(±.003)	2.54
1.125	(±.004)	3.21
1.25	(±.004)	3.97
1.375	(±.004)	4.8
1.5	(±.004)	5.71
1.75	(±.004)	7.77
1.875	(±.004)	8.91
2	(±.004)	10.14
2.25	(±.005)	12.84
2.5	(±.005)	15.85
2.625	(±.005)	17.47
3	(±.006)	22.82
3.5	(±.007)	31.06

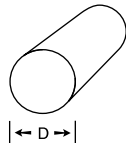

C62500 Round Aluminum Bronze Bar

12 Foot Mill Lengths

Diameter (Inches)	Diameter Tolerance	Pounds Per Foot
0.875	(±.010)	1.87
1	(±.010)	2.45
1.25	(±.010)	3.83
1.5	(±.015)	5.52
2	(±.015)	9.8
2.25	(±.025)	12.41
2.5	(±.025)	15.32
3	(±.025)	22.06



Heavy plate sawing to tight tolerances is a specialty at Copper and Brass Sales.

C63000 Aluminum Nickel Bronze

Nominal Composition

Copper:	81.0%
Aluminum:	10.0%
Nickel:	5.0%
Iron:	3.0%
Manganese:	1.0%

Physical Properties

Melting Point (Liquidus):	1,054°C (1,930°F)
Melting Point (Solidus):	1,035°C (1,895°F)
Density at 68°F:	0.274 lb/in ³ at 68°F
Coefficient of Linear Thermal Expansion per °F:	9.0 x 10 ⁻⁶ (68-572°F)
Electrical Conductivity:	7% IACS
Thermal Conductivity:	22.6 Btu/ft ² /ft/hr/°F at 68°F
Modulus of Elasticity - Tension:	17,500 ksi
Modulus of Rigidity:	6,400 ksi

Fabrication Properties

Hot Working Temperature:	800-925°C (1,450-1,700°F)
Annealing Temperature:	600-700°C (1,100-1,300°F)
Approximate Relative Machinability:	30 (free cutting brass arbitrarily rated at 100)

Mechanical Properties

Rod	Tensile Strength (psi)	Yield Strength (0.5% Ext.) (psi)	% Elongation (in 2")	Hardness (Mid-Radius)
.500" Dia. — HR50 (14%)	114,000	89,000	11	100 HRB
.500" Dia. — HR50 (17%)	122,600	90,000	10	100 HRB
2.125" Dia. — HR50	119,000	82,000	15	224 HB
2.500" Dia. — HR50	117,000	83,000	14	231 HB
3.000" Dia. — HR50	113,000	80,000	13	—

Description

Aluminum nickel bronze C63000 is a special high strength copper aluminum alloy containing 81% copper, 10% aluminum, 5% nickel, 3% iron and 1% manganese. It has high strength, hardness, and corrosion resistance, as well as toughness and good wear resistance.

Hot Working

The alloy is readily hot worked. It is hot forged and machined into engineering parts. Forgeability rating is 75.

Cold Working

C63000 cannot be cold worked extensively due to its rapid work hardening rate.

Joining and Fabrication

Soldering and oxyacetylene welding are not recommended. Brazing is fair. Gas shielded and coated metal arc welding are good, as are spot, seam and butt-welding.

Applications

Valve parts including seats, guides, balls, and stems. Pump parts including shafts and gears. Also, bearings, bushing, nuts, bolts, and plumbing parts.

Applicable Specifications

ASTM B150 and AMS 4640 for rod, ASTM B124 for forging rod.



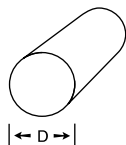

C63000
Round Aluminum Nickel Bronze Bar
HR50 (drawn and stress relieved)

12 Foot Mill Lengths
 AMS 4640, ASTM B150

Diameter (Inches)	Diameter Tolerance	Pounds Per Foot
0.375	(±.002)	0.36
0.4375	(±.002)	0.49
0.5	(±.002)	0.64
0.5625	(±.003)	0.81
0.625	(±.003)	0.99
0.6875	(±.003)	1.21
0.75	(±.003)	1.43
0.8125	(±.003)	1.67
0.875	(±.003)	1.94
0.9375	(±.003)	2.25
1	(±.004)	2.54
1.125	(±.004)	3.21
1.1875	(±.004)	3.58
1.25	(±.004)	3.97
1.375	(±.004)	4.8
1.4375	(±.004)	6.29
1.5	(±.004)	5.71
1.625	(±.004)	6.69
1.75	(±.004)	7.77
1.875	(±.004)	8.98
2	(±.004)	10.14
2.125	(±.0045)	11.45
2.25	(±.0045)	12.84
2.375	(±.00475)	14.3
2.5	(±.005)	15.85
2.625	(±.00525)	17.6
2.75	(±.0055)	19.18
2.875	(±.0575)	25.16
3	(±.006)	22.82

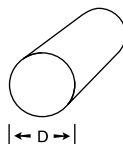

C63000
Round Aluminum Nickel Bronze Bar

12 Foot Mill Lengths
 AMS 4640, ASTM B150

Diameter (Inches)	Diameter Tolerance	Pounds Per Foot
3.25	(±.125)	26.78
3.5	(±.125)	31.06
3.625	(±.125)	33.917
3.75	(±.125)	35.65
4	(±.125)	40.56
4.25	(±.125)	45.79
4.5	(±.125)	51.34
4.75	(±.125)	58.2356
5	(±.125)	63.38
5.25	(±.125)	70.41
5.5	(±.125)	78.0777
5.75	(±.125)	85.744
6	(±.125)	91.95
6.5	(±.125)	116.63
7	(±.125)	125.6
9	(±.125)	207.65

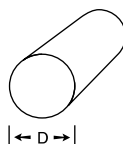

C63020
Round Aluminum Nickel Bronze Bar

12 Foot Mill Lengths
 AMS 4590, ASTM B150

Diameter (Inches)	Diameter Tolerance	Pounds Per Foot
1	(+.080 -0)	2.5528
1.5	(+.080 -0)	5.7438
1.75	(+.080 -0)	7.818
2	(+.080 -0)	10.2113
2.25	(+.080 -0)	12.9237
2.75	(+.080 -0)	19.3057

C64200 Aluminum Silicon Bronze

Nominal Composition

Copper: 91.2%
Aluminum: 7.0%
Silicon: 1.8%

Physical Properties

Melting Point (Liquidus): 1,005°C (1,840°F)
Melting Point (Solidus): 985°C (1,800°F)
Density at 68°F: 0.278 lb/in³
Coefficient of Linear Thermal Expansion per °F: 1.00 x 10⁻⁵ (68-572°F)
Electrical Conductivity at 68°F (volumetric): 8% IACS (in the annealed condition; lower in hard temper)
Thermal Conductivity: 26 Btu/ft²/ft/hr/°F at 68°F
Modulus of Elasticity - Tension: 16,000 ksi
Modulus of Rigidity: 6,000 ksi

Fabrication Properties

Hot Working Temperature: 700-870°C (1,300-1,600°F)
Annealing Temperature: 600-700°C (1,100-1,300°F)
Approximate Relative Machinability: 60 (free cutting brass arbitrarily rated at 100)

Mechanical Properties

Rod	Tensile Strength (psi)	Yield Strength (0.5% Ext.) (psi)	% Elongation (in 2")	Rockwell Hardness
0.500" Dia. — O50 Light Anneal	92,000	58,000	22	HRB 98
0.750" Dia. — M30 As Hot Extruded	75,000	35,000	32	HRB 77
0.750" Dia. — O50 Light Anneal	90,000	55,000	28	HRB 89
0.750" Dia. — HR50 Drawn and Stress Relieved	102,000	68,000	22	HRB 94
1.500" Dia. — HR50 Drawn and Stress Relieved	93,000	60,000	26	HRB 90
Bar	Tensile Strength (psi)	Yield Strength (0.5% Ext.) (psi)	% Elongation (in 2")	Rockwell Hardness
0.750" Thick — M30 As Hot Extruded	75,000	35,000	32	HRB 77

Description

Nominally composed of 91.2% copper, 7.0% aluminum, and 1.8% silicon, C64200 is an engineering alloy at least as resistant to corrosion as copper itself, but much stronger. It is also non-magnetic and has good fatigue and galling resistance. It has the highest machinability rating of bronzes and brasses without the addition of lead. Its combi-

nation of machinability, strength, hot forgeability, corrosion and wear resistance make it a remarkable alloy. It is one of the lightest of the copper base alloys.

Hot Working

C64200 has excellent hot workability and is used for hot forging.

Cold Working

C64200 has poor cold workability and cold working is not recommended.

Joining

Joining by soldering or oxyacetylene welding is not recommended. Joining by brazing and other welding methods such as gas shielded arc welding is fair.

Applications

Although not recommended for cold working or welding, this alloy has exceptionally high strength and is well suited for studs, bolts, and forgings for heavy switchgear and electrical hardware, especially in outdoor applications. C64200 is considered to be one of the best valve stem alloys. Other applications include gears, marine hardware, nuts, pole line hardware, and valve bodies and components.

Applicable Specifications

When so specified, C64200 will be manufactured to the latest revision of the following specifications: ASTM Specifications B124 and B150, and AMS Specifications 4633 and 4634.

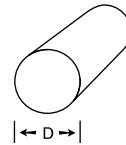

C64200 Round Aluminum Silicon Bronze Bar HR50 (drawn and stress relieved)

12 Foot Mill Lengths
AMS 4634, ASTM B150

Diameter (Inches)	Diameter Tolerance	Pounds Per Foot
0.375	(±.002)	0.3683
0.4375	(±.002)	0.5012
0.5	(±.002)	0.6547
0.5625	(±.003)	0.8286
0.625	(±.003)	1.023
0.6875	(±.003)	1.2378
0.75	(±.003)	1.4731
0.875	(±.003)	2.005
1	(±.003)	2.6188
1.125	(±.004)	3.3144
1.25	(±.004)	4.0918
1.375	(±.004)	4.9511
1.5	(±.004)	5.8922
1.625	(±.004)	6.9152
1.75	(±.004)	8.02
2	(±.004)	10.475
2.25	(±.005)	13.2575
3.75	(±.008)	36.8263



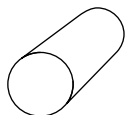

|← D →|

C65500
Round High Silicon Bronze Bar
H04 (hard)

12 Foot Mill Lengths
ASTM B98

Diameter (Inches)	Diameter Tolerance	Pounds Per Foot
0.25	(±.002)	0.1813
0.3125	(±.002)	0.2833
0.375	(±.002)	0.408
0.4375	(±.002)	0.5553
0.5	(±.002)	0.7253
0.625	(±.003)	1.1333
0.75	(±.003)	1.6302
0.875	(±.003)	2.2213
1	(±.003)	2.9014
1.125	(±.004)	3.672
1.25	(±.004)	4.5334
1.5	(±.004)	6.5281
1.75	(±.004)	8.8854
2	(±.004)	11.6054
2.5	(±.005)	18.1335

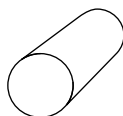

|← D →|

C67600
Round Manganese Bronze Bar
H02 (half-hard)

12 Foot Mill Lengths

Diameter (Inches)	Pounds Per Foot
1.125	3.6005

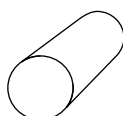

|← D →|

C69300
Round Eco Brass Bar
12 Foot Mill Lengths
ASTM B124, ASTM B371, ASTM B283

Diameter (Inches)	Pounds Per Foot
0.25	0.1767
0.5	0.7069
0.75	1.5904
0.875	2.1648
1	2.8274
1.0625	3.1903
1.25	4.4179
1.5	6.3617
1.75	8.659
2	11.3097
2.25	14.3139
2.5	17.6715

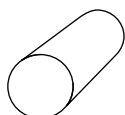

|← D →|

C67300
Round Manganese Bronze Bar
H02 (half-hard)

12 Foot Mill Lengths

Diameter (Inches)	Diameter Tolerance	Pounds Per Foot
0.75	(±.003)	1.5843
1.125	(±.004)	3.5647
1.25	(±.004)	4.4009
1.375	(±.004)	5.3251
1.5	(±.004)	6.3373
2	(±.004)	11.2663
2.25	(±.005)	14.2589
2.75	(±.006)	21.3004

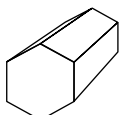

|← S →|

C69300
Hexagon Brass Bar
Rounded Corner

12 Foot Mill Lengths
ASTM B124, ASTM B371, ASTM B283

Size (Inches)	Pounds Per Foot
0.5	0.7794
0.75	1.7537
1	3.1176
1.5	7.0146
2	12.4704
2.5	19.485

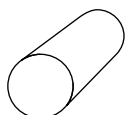

|← D →|

C67500
Round Manganese Bronze Bar
H02 (half-hard)

12 Foot Mill Lengths
ASTM B138

Diameter (Inches)	Diameter Tolerance	Pounds Per Foot
0.375	(±.002)	0.709
0.625	(±.003)	1.1039
1	(+0 -.003)	2.8166

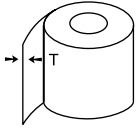

C72500
Copper Nickel Coil
O60 (soft anneal)
 ASTM B122

Thickness (Inches)	Thickness Tolerance	Pounds Per Square Foot
0.020	(±.001)	0.9707
0.030	(±.001)	1.4329
0.040	(±.001)	1.8952
0.050	(±.001)	2.3480
0.060	(±.0015)	2.8176
0.080	(±.002)	3.7903
0.125	(±.002)	5.8700

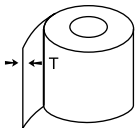

C75200
Nickel Silver Coil
O60 (soft anneal)
 ASTM B122

Thickness (Inches)	Thickness Tolerance	Pounds Per Square Foot
0.032	(±.001)	1.4561
0.050	(±.001)	2.2752
0.080	(±.002)	3.6404

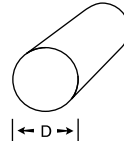

C86300
Round Manganese Bronze Bar
 Produced oversize for finishing to nominal dimensions.
 12 Foot Mill Lengths
 ASTM B505

Diameter (Inches)	Pounds Per Foot
1	2.915
1.5	6.317
2	10.977
2.5	17.000
3	24.200
3.5	33.043
4	43.629
4.5	54.904
5	67.633

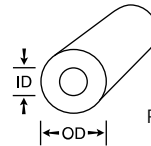

C86300
Round Manganese Bronze Hollow Bar
 Produced oversize for finishing to nominal dimensions.
 12 Foot Mill Lengths
 ASTM B505

OD (Inches)	ID (Inches)	Pounds Per Foot
3	1.5	20.38
3.5	2	23.77
4	2	33.8169
5	2.5	54.25
5	3	48
6	2	93.71



Precision cutting hollow bar on one of our Amada CNC controlled fully automatic horizontal band saws.



C93200 Bearing Bronze

Chemical Composition

Copper:	81-85%, 83% nom.
Aluminum:	0.005%
Antimony:	0.35%
Iron:	0.20%
Lead:	6.0-8.0%, 8.0% nom.
Nickel (includes Cobalt):	1.0%
Phosphorus:	0.15%
Silicon:	0.005%
Sulfur:	0.08%
Tin:	6.3-7.5%, 6.9% nom.
Zinc:	1.0-4.0%, 2.5 nom.

Note: Cu + Sum of Named Elements, 99.0% min.

Physical Properties

Melting Point – Liquidus:	1,790°F
Melting Point – Solidus:	1,570°F
Density:	0.322 lb/in ³ at 68°F
Specific Gravity:	8.910
Electrical Resistivity:	85.90 ohms-cmil/ft @ 68°F
Electrical Conductivity:	12% IACS @ 68°F
Thermal Conductivity:	33.60 Btu/hr/ft ² /ft/°F at 68°F
Coefficient of Thermal Expansion:	10 x 10 ⁻⁶ /°F (68-212°F)
Specific Heat Capacity:	0.090 Btu/lb/°F at 68°F
Modulus of Elasticity in Tension:	14,500 ksi

Description

C93200 Bearing Bronze has excellent machining properties, good hardness, strength, and wear resistance, with excellent anti-friction qualities. The alloy is not subject to dezincification and has reasonable corrosion resistance to seawater and brine making it suitable for pump and valve components.

Typical Uses

Automotive fittings, fasteners, washers, industrial thrust washers, pumps, bushings, machine parts, main spindle bearings, machine tool bearings.

Joining and Fabrication

Soldering:	Excellent
Brazing:	Good
Oxyacetylene Welding:	Not Recommended
Gas Shielded Arc Welding:	Not Recommended
Coated Metal Arc Welding:	Not Recommended
Machinability Rating:	70%

Applicable Specifications

Centrifugal Cast:	ASTM B271
Continuous Cast:	ASTM B505

Mechanical Properties (68°F)

Temper	Tensile Strength (psi)	Yield Strength (0.5% ext.) (psi)	% Elongation
Centrifugal Cast M02	30,000 min.	14,000 min.	15
Continuous Cast M07	35,000 min.	20,000 min.	10

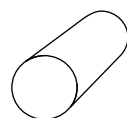

← D →

C93200 Round Bearing Bronze Bar

12 Foot Mill Lengths
ASTM B505

Diameter (Inches)	Diameter Tolerance	Pounds Per Foot
0.5	(+.029 to +.039)	0.914
0.625	(+.029 to +.039)	1.371
0.75	(+.029 to +.039)	1.8883
0.875	(+.029 to +.039)	2.629
1	(+.029 to +.039)	3.429
1.125	(+.029 to +.039)	4.229
1.25	(+.029 to +.039)	5.257
1.375	(+.029 to +.039)	6.286
1.5	(+.029 to +.039)	7.429
1.625	(+.029 to +.039)	8.4706
1.75	(+.029 to +.039)	9.7129
1.875	(+.029 to +.039)	11.1811
2	(+.034 to +.044)	12.91
2.125	(+.034 to +.044)	14.51
2.25	(+.034 to +.044)	16.11
2.375	(+.034 to +.044)	18.06
2.5	(+.034 to +.044)	20
2.625	(+.034 to +.044)	22.06
2.75	(+.034 to +.044)	24.11
2.875	(+.034 to +.044)	26.29
3	(+.034 to +.044)	28.46
3.25	(+.034 to +.044)	33.26
3.5	(+.034 to +.044)	38.86
3.75	(+.034 to +.044)	44.8
4	(+.055 to +.071)	51.31
4.25	(+.055 to +.071)	57.94
4.5	(+.055 to +.071)	64.57
4.75	(+.055 to +.071)	72
5	(+.055 to +.071)	79.54
5.5	(+.078 to +.110)	97.26
6	(+.078 to +.110)	115
6.5	(+.078 to +.110)	136
7	(+.078 to +.110)	156.3
7.5	(+.078 to +.110)	178.1
8	(+.078 to +.110)	203
9	(+.078 to +.110)	256.6
10	(+.094 to +.134)	319.4
11	(+.094 to +.134)	384.8
12	(+.094 to +.134)	458.1

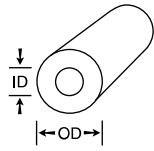

C93200 Round Bearing Bronze Hollow Bar

Produced oversize for finishing to nominal dimensions.
12 Foot Mill Lengths
ASTM B505

OD (Inches)	ID (Inches)	Pounds Per Foot	OD (Inches)	ID (Inches)	Pounds Per Foot	OD (Inches)	ID (Inches)	Pounds Per Foot
1	0.5	2.74	2.125	1.25	10.4	3.5	1.5	32.34
1	0.625	2.4	2.125	1.5	8	3.5	1.75	30.17
1	0.75	1.83	2.25	0.75	14.63	3.5	2	26.97
1.125	0.5	3.66	2.25	1	13.37	3.5	2.25	23.77
1.125	0.625	3.2	2.25	1.125	13.03	3.5	2.375	22.17
1.25	0.5	4.57	2.25	1.25	12.11	3.5	2.5	20.8
1.25	0.625	4.229	2.25	1.5	10.06	3.5	2.75	16.23
1.25	0.75	3.66	2.25	1.625	8.91	3.5	3	12.34
1.25	0.875	3.2	2.25	1.75	7.66	3.75	2	32.91
1.25	1	2.29	2.375	1.375	12.91	3.75	2.25	29.94
1.375	0.5	5.49	2.375	1.5	11.89	3.75	2.375	28
1.375	0.625	5.14	2.375	1.625	10.29	3.75	2.5	25.94
1.375	0.75	4.69	2.375	1.75	9.37	3.75	2.75	22.17
1.375	0.875	4.11	2.375	2	6.4	3.75	3	17.37
1.375	1	3.43	2.5	0.75	18.4	4	1	49.37
1.5	0.5	6.74	2.5	1	17.49	4	1.25	46.86
1.5	0.625	6.29	2.5	1.25	15.54	4	1.5	45.6
1.5	0.75	5.83	2.5	1.5	13.83	4	1.75	42.86
1.5	0.875	5.26	2.5	1.75	11.43	4	2	40.34
1.5	1	4.57	2.5	1.875	9.71	4	2.5	33.26
1.5	1.25	2.86	2.5	2	8.57	4	2.75	29.14
1.625	0.75	7.09	2.625	1.75	13.03	4	2.875	27.31
1.625	1	5.83	2.625	2	10.97	4	3	25.37
1.625	1.125	4.91	2.75	0.75	22.63	4	3.25	20.23
1.75	0.625	9.03	2.75	1	21.26	4	3.5	15.2
1.75	0.75	8.34	2.75	1.5	17.6	4.25	2.25	43.43
1.75	0.875	8	2.75	1.625	16.46	4.25	2.75	35.77
1.75	1	7.31	2.75	1.75	15.54	4.25	3	31.66
1.75	1.125	6.4	2.75	2	12.69	4.25	3.25	26.86
1.75	1.25	5.714	2.75	2.25	9.26	4.25	3.5	21.6
1.75	1.375	4.57	3	1	25.71	4.5	1.5	58.63
1.875	1.25	7.09	3	1.25	24.69	4.5	2	53.49
1.875	1.375	5.83	3	1.5	22.06	4.5	2.5	46.86
1.875	1.5	4.91	3	1.75	19.66	4.5	2.75	42.86
2	0.5	12.46	3	2	17.37	4.5	3	38.29
2	0.625	12	3	2.25	13.71	4.5	3.25	33.71
2	0.75	11.31	3	2.375	12.11	4.5	3.5	28.57
2	0.875	10.74	3	2.5	10.51	4.5	3.75	23.31
2	1	10.29	3.25	1.25	28.91	4.5	4	17.37
2	1.125	9.6	3.25	1.5	27.54	4.75	3	45.71
2	1.25	8.8	3.25	1.75	25.14	4.75	3.25	41.14
2	1.375	7.77	3.25	2	21.94	4.75	3.5	36.11
2	1.5	6.857	3.25	2.25	18.63	4.75	3.75	30.74
2	1.625	5.26	3.25	2.5	15.43	4.75	4	24.8
2	1.75	4	3.25	2.75	10.97	5	2	68.23
2.125	1	12	3.5	1	36.11	5	2.5	61.49

Continued next page



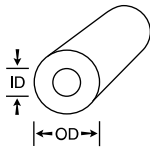

Continued from previous page

C93200

Round Bearing Bronze Hollow Bar

Produced oversize for finishing to nominal dimensions.
12 Foot Mill Lengths
ASTM B505

OD (Inches)	ID (Inches)	Pounds Per Foot	OD (Inches)	ID (Inches)	Pounds Per Foot
5	3	53.49	7.5	6.5	53.71
5	3.25	48.57	8	4	157.71
5	3.5	44	8	5	128.11
5	3.75	38.29	8	5.5	113.14
5	4	32.23	8	5.75	106.06
5	4.5	19.54	8	6	96.91
5.25	4	42.63	8	6.5	79.2
5.25	4.25	36.57	8	7	58.63
5.5	2	86.29	8.5	6	122.74
5.5	2.5	79.77	8.5	6.5	102.86
5.5	3	71.43	8.5	7	84.34
5.5	3.5	61.14	8.5	7.5	62.06
5.5	4	50.06	9	4	212.34
5.5	4.25	45.14	9	5	182.29
5.5	4.5	37.83	9	6	150.17
5.5	4.75	31.54	9	7	110.86
5.5	5	24.34	9	7.5	88.23
6	2	104.69	9	8	65.26
6	2.5	97.14	9.5	7.5	116.69
6	3	89.71	9.5	8	96.46
6	3.5	79.54	9.5	8.5	72.69
6	3.75	74.4	10	6	213.26
6	4	68.57	10	8	127.2
6	4.5	55.66	10	8.5	102.06
6	4.75	48.91	10.5	8.5	134.17
6	5	41.49	10.5	9.5	81.14
6.5	3	109.14	11	7	240
6.5	3.5	99.89	11	8	194.17
6.5	4.5	75.43	11	9	141.26
6.5	4.75	69.03	11	9.5	112
6.5	5	61.14	11.5	10	118.51
6.5	5.5	46.17	12	6	345.5
6.5	6	29.03	12	7	312
6.75	5.75	47.89	12	8	265.14
6.75	6	39.2	12	9	213.37
7	2.5	139	12	10	155.54
7	4	110.29	13	9	283
7	4.5	95.77	13	10	235.66
7	5	82.29	13	10.5	209.49
7	5.5	67.2	13	11	171.43
7	6	49.71	14	11	256.11
7.5	4	131.43	15	12	276.69
7.5	5	105.49	15	13	201.14
7.5	5.5	89.14			
7.5	5.75	80.34			
7.5	6	72.23			

C95400 Aluminum Bronze

Chemical Composition

Copper:	83.2% nom., 83% min.
Aluminum:	10.0-11.5%, 10.8% nom.
Iron:	3.0-5.0%, 4.0% nom.
Manganese:	0.5%
Nickel (Includes Cobalt):	1.5%
Note:	Cu + Sum of Named Elements, 99.5% min.

Physical Properties

Melting Point – Liquidus:	1,900°F
Melting Point – Solidus:	1,880°F
Density:	0.269 lb/in ³ at 68°F
Specific Gravity:	7.450
Electrical Resistivity:	80.20 ohms-cmil/ft @ 68°F
Electrical Conductivity:	13% IACS @ 68°F
Thermal Conductivity:	33.90 Btu/hr/ft ² /ft ² /°F at 68°F
Coefficient of Thermal Expansion:	9 x 10 ⁻⁶ /°F (68-572°F)
Specific Heat Capacity:	0.10 Btu/lb/°F at 68°F
Modulus of Elasticity in Tension:	15,500 ksi
Magnetic Permeability:	1.20, TQ 50 Temper, Field Strength 16 kA/m
Magnetic Permeability:	1.270, As Cast, Field Strength 16 kA/m

Mechanical Properties (68°F)

Temper	Tensile Strength (psi)	Yield Strength (0.5% ext.) (psi)	% Elongation	Brinell Hardness 3000kg
Centrifugal Cast TQ50	90,000 min.	45,000 min.	6	190
Centrifugal Cast M02	75,000 min.	30,000 min.	12	150
Continuous Cast TQ50	95,000 min.	45,000 min.	10	
Continuous Cast M07	85,000 min.	32,000 min.	12	

Description

C95400 is a cast aluminum bronze alloy with high strength and excellent resistance to corrosion. Although supplied in the cast condition, it can be heat treated to enhance its mechanical properties and to comply with more demanding applications.

Typical Uses

Typical uses include welding guns, nuts, large hold down screws, bushings, high strength clamps, gears, valves, bearings, valve bodies, landing gear parts, worm gears, machine parts, pressure blocks for the steel industry, bearing segments for the steel industry, valve seats, valve guides, pickling hooks, spur gears, heavily loaded worm gears, and pump parts.

Applicable Specifications

Centrifugal Cast:	ASTM B271
Continuous Cast:	ASTM B505

Fabrication Properties

Soldering:	Good
Brazing:	Good
Oxyacetylene Welding:	Not Recommended
Gas Shielded Arc Welding:	Good
Coated Metal Arc Welding:	Good
Machinability Rating:	60

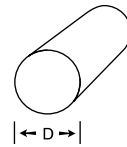

C95400 Round Aluminum Bronze Bar Continuous Cast

12 Foot Mill Lengths
ASTM B505

Diameter (Inches)	Diameter Tolerance	Pounds Per Foot
0.5	(+.0525 to +.0725)	0.83
0.625	(+.0525 to +.0725)	1.25
0.75	(+.0525 to +.0725)	1.75
1	(+.0525 to +.0725)	2.92
1.25	(+.0525 to +.0725)	4.5
1.5	(+.0525 to +.0725)	6.33
1.625	(+.0525 to +.0725)	7.42
1.75	(+.0525 to +.0725)	8.5
2	(+.0525 to +.0725)	11
2.25	(+.0525 to +.0725)	13.83
2.5	(+.0525 to +.0725)	16.92
2.75	(+.0525 to +.0725)	20.1667
3	(+.0525 to +.0725)	23.9167
3.25	(+.079 to +.109)	28.75
3.5	(+.079 to +.109)	33.25
3.75	(+.079 to +.109)	37.9167
4	(+.079 to +.109)	42.8333
4.25	(+.079 to +.109)	48.5
4.5	(+.079 to +.109)	54.25
4.75	(+.105 to +.145)	60.9167
5	(+.105 to +.145)	67.42
5.5	(+.105 to +.145)	80.83
6	(+.163 to +.213)	98.25
6.5	(+.163 to +.213)	114.333
7	(+.163 to +.213)	132.25
8	(+.163 to +.213)	171.5
9	(+.163 to +.213)	215.75



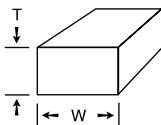

C95400
Rectangular Aluminum Bronze Bar
Continuous Cast

12 Foot Mill Lengths
 ASTM B505

Thickness (Inches)	Thickness Tolerance	Width (Inches)	Width Tolerance	Pounds Per Foot	Thickness (Inches)	Thickness Tolerance	Width (Inches)	Width Tolerance	Pounds Per Foot
0.25	(+.067 to +.107)	1	(+.043 to +.083)	1.25	1	(+.067 to +.107)	2	(+.043 to +.083)	7.42
0.25	(+.067 to +.107)	1.5	(+.043 to +.083)	1.75	1	(+.067 to +.107)	2.5	(+.043 to +.083)	9.17
0.25	(+.067 to +.107)	2	(+.043 to +.083)	2.33	1	(+.067 to +.107)	3	(+.043 to +.083)	10.92
0.25	(+.067 to +.107)	2.5	(+.043 to +.083)	2.8333	1	(+.067 to +.107)	4	(+.043 to +.083)	14.5
0.25	(+.067 to +.107)	3	(+.043 to +.083)	3.4167	1	(+.067 to +.107)	5	(+.043 to +.083)	18
0.25	(+.067 to +.107)	4	(+.043 to +.083)	4.5833	1	(+.087 to +.127)	6	(+.063 to +.113)	21.8333
0.25	(+.087 to +.127)	6	(+.063 to +.113)	7.25	1	(+.087 to +.127)	8	(+.063 to +.113)	30.3333
0.375	(+.067 to +.107)	1	(+.043 to +.083)	1.67	1	(+.087 to +.127)	12	(+.063 to +.113)	42.25
0.375	(+.067 to +.107)	1.5	(+.043 to +.083)	2.42	1.25	(+.067 to +.107)	1.5	(+.043 to +.083)	6.9167
0.375	(+.067 to +.107)	2	(+.043 to +.083)	3.17	1.25	(+.067 to +.107)	1.75	(+.043 to +.083)	8
0.375	(+.067 to +.107)	2.5	(+.043 to +.083)	3.9167	1.25	(+.067 to +.107)	2	(+.043 to +.083)	9.0833
0.375	(+.067 to +.107)	3	(+.043 to +.083)	4.75	1.25	(+.067 to +.107)	2.5	(+.043 to +.083)	11.33
0.375	(+.067 to +.107)	3.5	(+.043 to +.083)	5.33	1.25	(+.067 to +.107)	3	(+.043 to +.083)	13.4167
0.375	(+.067 to +.107)	4	(+.043 to +.083)	6.17	1.25	(+.067 to +.107)	3.5	(+.043 to +.083)	15.5833
0.375	(+.067 to +.107)	5	(+.043 to +.083)	7.6668	1.25	(+.067 to +.107)	4	(+.043 to +.083)	17.8333
0.375	(+.067 to +.107)	6	(+.043 to +.083)	7.263	1.5	(+.067 to +.107)	1.75	(+.043 to +.083)	9.5833
0.5	(+.067 to +.107)	1	(+.043 to +.083)	2.0833	1.5	(+.067 to +.107)	2	(+.043 to +.083)	10.83
0.5	(+.067 to +.107)	1.25	(+.043 to +.083)	2.5833	1.5	(+.067 to +.107)	2.5	(+.043 to +.083)	13.25
0.5	(+.067 to +.107)	1.5	(+.043 to +.083)	3.0833	1.5	(+.067 to +.107)	3.5	(+.043 to +.083)	18.5833
0.5	(+.067 to +.107)	1.75	(+.043 to +.083)	3.5833	1.5	(+.067 to +.107)	4	(+.043 to +.083)	21.0833
0.5	(+.067 to +.107)	2	(+.043 to +.083)	4	1.75	(+.067 to +.107)	2	(+.043 to +.083)	12.58
0.5	(+.067 to +.107)	2.5	(+.043 to +.083)	5	1.75	(+.067 to +.107)	2.5	(+.043 to +.083)	15.5
0.5	(+.067 to +.107)	3	(+.043 to +.083)	6	1.75	(+.067 to +.107)	3	(+.043 to +.083)	18.3333
0.5	(+.067 to +.107)	3.5	(+.043 to +.083)	6.92	1.75	(+.067 to +.107)	4	(+.043 to +.083)	24.5
0.5	(+.067 to +.107)	4	(+.043 to +.083)	7.75	2	(+.067 to +.107)	2.5	(+.043 to +.083)	17.5833
0.5	(+.067 to +.107)	5	(+.043 to +.083)	9.75	2	(+.067 to +.107)	3	(+.043 to +.083)	21
0.5	(+.087 to +.127)	6	(+.063 to +.113)	12.08	2	(+.067 to +.107)	4	(+.043 to +.083)	27.75
0.5	(+.087 to +.127)	8	(+.063 to +.113)	16	2	(+.087 to +.127)	6	(+.063 to +.113)	42.0833
0.5	(+.087 to +.127)	10	(+.063 to +.113)	19.8333	2.5	(+.067 to +.107)	3	(+.043 to +.083)	26.17
0.5	(+.087 to +.127)	12	(+.063 to +.113)	23.5833	2.5	(+.043 to +.107)	4	(+.043 to +.083)	32.4
0.625	(+.067 to +.107)	1	(+.043 to +.083)	2.5	2.5	(+.067 to +.107)	5	(+.043 to +.083)	42.92
0.625	(+.067 to +.107)	1.5	(+.043 to +.083)	3.75					
0.625	(+.067 to +.107)	2	(+.043 to +.083)	4.92					
0.625	(+.067 to +.107)	2.5	(+.043 to +.083)	6					
0.625	(+.067 to +.107)	3	(+.043 to +.083)	7.17					
0.625	(+.067 to +.107)	4	(+.043 to +.083)	9.58					
0.625	(+.067 to +.107)	5	(+.043 to +.083)	11.8333					
0.625	(+.087 to +.127)	6	(+.063 to +.113)	14.4996					
0.75	(+.067 to +.107)	1	(+.043 to +.083)	3					
0.75	(+.067 to +.107)	1.5	(+.043 to +.083)	4.333					
0.75	(+.067 to +.107)	2	(+.043 to +.083)	5.75					
0.75	(+.067 to +.107)	2.5	(+.043 to +.083)	7.08					
0.75	(+.067 to +.107)	3	(+.043 to +.083)	8.4167					
0.75	(+.067 to +.107)	3.5	(+.043 to +.083)	9.9167					
0.75	(+.067 to +.107)	4	(+.043 to +.083)	11.1667					
0.75	(+.087 to +.127)	6	(+.063 to +.113)	17					
0.75	(+.087 to +.127)	8	(+.063 to +.113)	22.3333					
1	(+.067 to +.107)	1.25	(+.043 to +.083)	4.83					
1	(+.067 to +.107)	1.5	(+.043 to +.083)	5.67					
1	(+.067 to +.107)	1.75	(+.043 to +.083)	6.5					

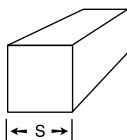

C95400
Square Aluminum Bronze Bar
Continuous Cast

12 Foot Mill Lengths
 ASTM B505

Size (Inches)	Size Tolerance	Pounds Per Foot
0.75	(+.0525 to +.0725)	2.1
1	(+.0525 to +.0725)	3.238
2	(+.0525 to +.0725)	13.8
0.75	(+.0525 to +.0725)	2.1
1	(+.0525 to +.0725)	3.7
1.25	(+.0525 to +.0725)	5.6
1.5	(+.0525 to +.0725)	7.9
2	(+.0525 to +.0725)	13.8
3	(+.0525 to +.0725)	30.3

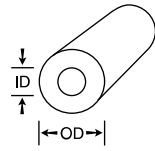

C95400 Round Aluminum Bronze Hollow Bar Continuous Cast

Produced oversize for finishing to nominal dimensions.
12 Foot Mill Lengths
ASTM B505

OD (Inches)	ID (Inches)	Pounds Per Foot	OD (Inches)	ID (Inches)	Pounds Per Foot
1.25	0.75	3.33	3	2	14.83
1.25	0.75	3.2	3	2	14.48
1.5	0.75	5.25	3	2.25	12.25
1.5	0.75	5.04	3	2.25	11.97
1.5	1	4.17	3	2.5	9.17
1.75	0.75	7.5	3	2.5	9.03
1.75	1.25	5	3.25	1.75	22.58
1.75	1.25	5.01	3.25	2	20.42
2	0.75	9.75	3.25	2.25	17.5
2	0.75	8.7152	3.25	2.5	14.25
2	1	8.92	3.25	2.75	11.25
2	1	8.54	3.5	1	31.33
2	1.25	7.58	3.5	1.5	28.67
2	1.5	5.83	3.5	1.5	27.73
2.25	1	11.4	3.5	2	24.5
2.25	1.25	10.42	3.5	2.25	22.42
2.25	1.5	8.75	3.5	2.5	19.33
2.25	1.5	8.46	3.5	2.5	17.95
2.25	1.75	6.67	3.5	2.75	15.67
2.25	1.75	6.59	3.5	3	12.17
2.375	2	5.92	3.75	2.5	22.82
2.5	1	15	3.75	2.75	20.83
2.5	1	14.63	3.75	2.75	19.58
2.5	1.25	13.58	3.75	3	17.08
2.5	1.25	13.32	4	1	41.42
2.5	1.5	11.92	4	1.5	38.42
2.5	1.5	11.51	4	1.5	37.66
2.5	1.75	9.83	4	2	34.42
2.5	1.75	9.6	4	2.5	29.17
2.5	2	7.58	4	2.5	27.78
2.5	2	7.27	4	2.75	25.83
2.75	1.5	15.42	4	3	22.5
2.75	1.5	15.2	4	3.25	18.75
2.75	1.75	13.42	4	3.5	13.92
2.75	1.75	13.15	4.125	1.5	40.25
2.75	2	11	4.25	3	28.17
2.75	2	10.87	4.25	3.25	23.33
2.75	2.25	8.25	4.25	3.5	19.5
3	1	22.13	4.5	2	45.17
3	1.5	19.25	4.5	2	44.96
3	1.5	18.99	4.5	2.5	40.17
3	1.75	17.25	4.5	3	33.75

Continued next page



Continued from previous page

C95400

**Round Aluminum Bronze Hollow Bar
Continuous Cast**

Produced oversize for finishing to nominal dimensions.
12 Foot Mill Lengths
ASTM B505

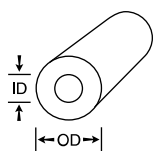

OD (Inches)	ID (Inches)	Pounds Per Foot
4.5	3.5	25.5
4.75	3.75	26.42
5	2	59
5	2.5	53.5
5	3	46.92
5	3.25	43.3333
5	3.5	39.25
5	4	30.25
5	4	28.15
5.5	2	74.58
5.5	3	60.75
5.5	3.5	52.83
5.5	4	44.08
5.5	4	41.4
5.5	4.5	33.5
6	2	90.17
6	3	78.17
6	3.5	70.5
6	4	61.58
6	4.5	46.87
6	5	39.83
6	5	34.43
6.25	3.75	72.6
6.5	4.5	67.08
6.5	5.5	43
7	3	112.5
7	4	95.33
7	5	73.33
7	6	46.75
7.5	6	59.007
8	4	135.42
8	5	112.67
8	6	93.58
8.5	6.5	84.578
9	7	97.5
9	7	86.4
10	6	171.347
10	7	138.956
11	9	112.771



Copper and Brass Sales is always your best choice for a complete range of quality nonferrous and specialty alloys.

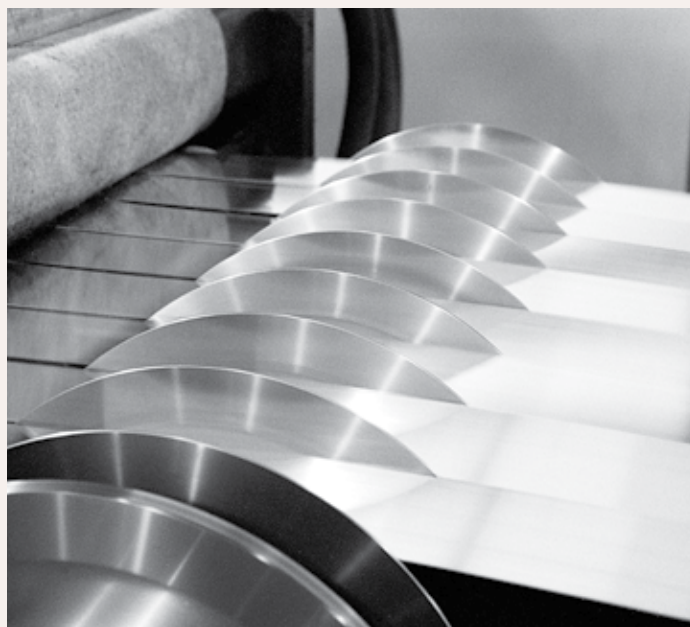

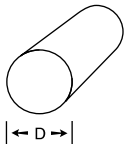

**MoldMAX High Hardness[®]
Round Beryllium Copper Bar**
12 Foot Mill Lengths

Diameter (Inches)	Diameter Tolerance	Pounds Per Foot
0.5	(+.020 +.040)	0.7112
0.625	(+.020 +.040)	1.1113
0.75	(+.020 +.040)	1.6002
0.875	(+.020 +.040)	2.1781
1	(+.020 +.050)	2.8448
1.25	(+.030 +.060)	4.4451
1.5	(+.030 +.060)	6.4009
2	(+.040 +.080)	11.3794
2.25	(+.040 +.080)	14.402
2.5	(+.040 +.080)	17.7803
2.75	(+.040 +.080)	21.5141
3	(+.040 +.080)	25.6036
3.5	(+.040 +.080)	34.8493
4	(+.060 +.120)	45.5174
4.5	(+.060 +.120)	57.608
5	(+.060 +.120)	71.121
6	(+.060 +.120)	102.414

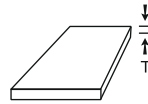

**MoldMAX High Hardness[®]
Beryllium Copper Plate**

Thickness (Inches)	Thickness Tolerance	Pounds Per Square Foot
0.25	(+.012/+.036)	10.872
0.375	(+.015/+.045)	16.308
0.5	(+.015/+.045)	21.744
0.625	(+.019/+.057)	27.18
0.75	(+.019/+.057)	32.616
1	(+.023/+.068)	43.488
1.25	(+.028/+.084)	54.36
1.5	(+.028/+.084)	65.232
1.75	(+.068-0)	76.104
2	(+.250/+.430)	521.856
2	(+.033/+.066)	86.976
2.25	(+.087-0)	97.848
2.5	(+.092-0)	108.72
2.75	(+.108-0)	119.592
3	(+.126-0)	130.464
3.5	(+.038-0)	152.208
4	(+.063/+.126)	173.952
4.5	(+.073/+.146)	195.696
6	(+.111/+.222)	260.928
8	(+.120 +.370)	347.904

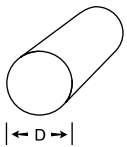

**MoldMAX V[®]
Round Beryllium Free Copper Bar**
12 Foot Mill Lengths

Diameter (Inches)	Diameter Tolerance	Pounds Per Foot
0.5	(+.030 -0)	0.76
1	(+.020 to +.050)	3.0332
2	(+.040 to +.080)	12.133
2.5	(+.040 to +.080)	18.9578
3	(+.040 to +.080)	27.2992
4	(+.060 to +.120)	48.5318

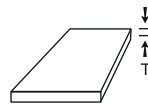

**MoldMAX Low Hardness[®]
Beryllium Copper Plate**

Thickness (Inches)	Thickness Tolerance	Pounds Per Square Foot
0.25	(+.012 +.036)	10.872
0.375	(+.019 -0)	16.308
0.5	(+.015 +.045)	21.744
0.625	(+.019 +.057)	27.18
0.75	(+.019 +.057)	32.616
1	(+.012 -0)	43.488
1.25	(+.056 -0)	54.36
1.5	(+.028 +.084)	65.232
1.75	(+.033 +.099)	76.104
2	(+.250 +.430)	521.856
2	(+.033 +.066)	86.976
2.25	(+.033 +.066)	97.848
2.5	(+.039 +.078)	108.72
3	(+.046 +.092)	130.464
3.5	(+.054 +.108)	152.208
4	(+.063 +.126)	173.952
4.5	(+.073 +.146)	195.696
6	(+.111 +.222)	260.928

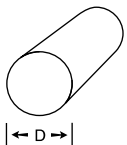

**MoldMAX SC[®] (PROtherm[®])
Round Beryllium Copper Bar**
12 Foot Mill Lengths

Diameter (Inches)	Diameter Tolerance	Pounds Per Foot
0.5	(+.020 to +.040)	0.7512
2	(+.040 to +.080)	12.0199
2.5	(+.040 to +.080)	18.7811
3	(+.0325 to +.0925)	28.1978
4	(+.060 to +.120)	48.0797



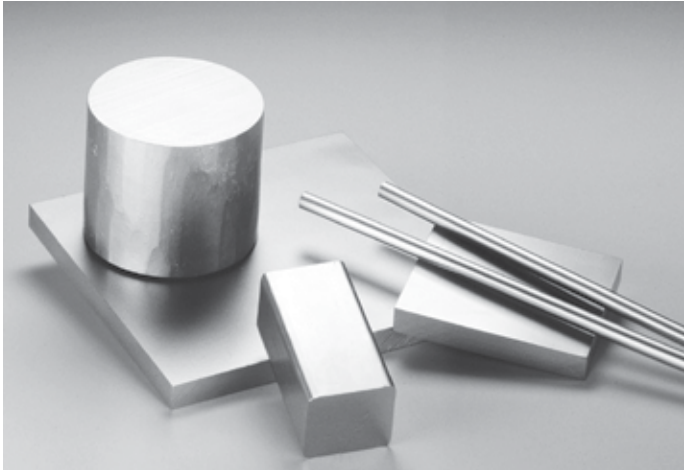
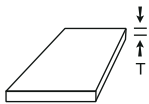

Photo courtesy of Materion.

Beryllium copper rod, bar and plate.



**MoldMAX SC[®] (PROtherm[®])
Beryllium Copper Plate**

Thickness (Inches)	Thickness Tolerance	Pounds Per Square Foot
1	(+.023 +.068)	45.936
3.5		160.776

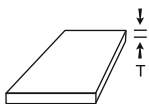

**MoldMAX V[®]
Beryllium Free Copper Plate**

Thickness (Inches)	Thickness Tolerance	Pounds Per Square Foot
1	(+.080 -0)	45.216
2.5	(+.039 +.100)	113.04
3	(+.046 +.106)	135.648
3.5	(+.108 -0)	158.256
4	(+.063 +.126)	180.864

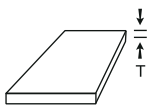

**MoldMAX XL[®]
Beryllium Free Copper Plate**

Thickness (Inches)	Thickness Tolerance	Pounds Per Square Foot
12	(+.060 +.250)	556.416
2	(+.060 +.250)	92.736
4	(+.063 +.126)	185.472

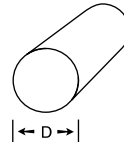

**ToughMet[®] 3
Round Copper Nickel Tin Bar
AT-110**

12 Foot Mill Lengths
UNS C72900, AMS 4596

Diameter (Inches)	Diameter Tolerance	Pounds Per Foot
0.595	(+.040 -0)	1.0772
1	(+.060 -0)	3.28
1.25	(+.060 -0)	4.7542
1.375	(+.060 -0)	6.113
1.5	(+.060 -0)	7.4
1.75	(+.060 -0)	9.76
2	(+.100 -0)	12.5755
2	(+.100 -0)	12.62
2.25	(+.100 -0)	15.41
2.5	(+.100 -0)	20.229
2.77	(+.100 -0)	24.631
3	(+.140 -0)	29.3414
3.25	(+.140 -0)	34.695
3.5	(+.140 -0)	39.251
3.75	(+.240 -0)	42.7874
4	(+.240 -0)	50.2785
4.5	(+.240 -0)	61.6139
5	(+.240 -0)	78.2054
5.5	(+.240 -0)	94.6394
6	(+.240 -0)	111.574
6.75	(+.240 -0)	138.631
7	(+.240 -0)	149.09

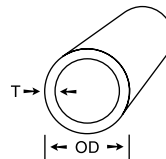

**ToughMet[®] 3
Round Copper Nickel Tin Tube
CX-105**

12 Foot Mill Lengths
ASTM B505

OD (Inches)	OD Tolerance	Thickness (Inches)	Thickness Tolerance	Pounds Per Foot
3	(±.005)	0.625	(±.045)	19.39
*5.5	(+.060 -0)	1.25	(±.020)	71.2286
7.125	(+.060 -0)	1.5625	(±.025)	112.8
9.5	(+.078 to +.110)	2.25	(-.158 to -.062)	209.454

*CX-90

Physical Properties

Copper No.	Melting Point, Liquidus (°F)	Melting Point, Solidus (°F)	Density, 68°F (Lb/In ³)	Coefficient Of Linear Thermal Expansion, 68 - 572°F (x 10 ⁻⁶ /°F)	Thermal Conductivity, 68°F (Btu/Ft ² /Ft/Hr/°F)	Electrical Conductivity, Annealed, 68°F (%ACS)	Specific Heat, 68°F (Btu/Lb/°F)
Coppers							
C10100	1981	1981	.323	9.8	226	101	.092
C10200	1981	1981	.323	9.8	226	101	.092
C11000	1981	1949	.321-.323	9.8	226	101	.092
C12200	1981		.323	9.8	196	85	.092
C14300	1976	1926	.323	9.8	218	96	.092
C14500	1967	1924	.323	9.9	205	93	.092
Copper Alloys							
C17200	1800	1590	.298	9.9	62-75	22	.10
C17300	1800	1590	.298	9.9	62-75	22	.10
C17510		1830	.319	10.7	144	20	
C18000			.315	9.7	125	48	
A945			.310	9.7	80		
C18200	1967	1958	.321	9.8	187 (68-212°F)	80	.092
C18700 / C99	1976	1747	.323	9.8	218	96	.092
C97			.321	10.4	140	50	.090
Brasses							
C21000	1950	1920	.320	10.0	135	56	.09
C22000	1910	1870	.318	10.2	109	44	.09
C23000	1880	1810	.316	10.4	92	37	.09
C26000	1750	1680	.308	11.1	70	28	.09
C28000	1660	1650	.303	11.6	71	28	.09
Leaded Brasses							
C33000	1720	1660	.307	11.2	67	26	.09
C35300	1670	1630	.306	11.3	67	26	.09
C36000	1650	1630	.307	11.4	67	26	.09
C36500	1650	1630	.304	11.6	71	28	.09
C38500	1690	1610	.306	11.6	71	28	—
Tin Brasses							
C46400	1650	1630	.304	11.8	67	26	.09
C48500	1650	1630	.305	11.8	67	26	.09
Phosphor Bronze							
C51000	1920	1750	.320	9.9	40	15	.09
Leaded Phosphor Bronze							
C54400	1830	1700	.321	9.6	50	19	.09
Aluminum Silicon Bronze							
C64200	1840	1800	.278	10.0	26	8	.09
Copper-Zinc							
C67300			.300				
Copper-Nickel							
C71500	2260	2140	.323	9.0	17	4.6	.09
Nickel-Silver							
C75200	2030	1960	.316	9.0	19	6.0	.09



Copper Alloy No.	Machinability Rating (Free Cutting Brass = 100)	Suitability For Being Joined By					Resistance Welding		
		Soldering	Brazing	Oxyacetylene Welding	Gas Shielded Arc Welding	Coated Metal Arc Welding	Spot	Seam	Butt
Coppers									
C10100	20	E	E	F	G	NR	NR	NR	G
C10200	20	E	E	F	G	NR	NR	NR	G
C11000	20	E	G	NR	F	NR	NR	NR	G
C12200	20	E	E	G	E	NR	NR	NR	G
C14300	20	E	E	G	E	NR	NR	NR	G
C14500	85	E	G	F	F	NR	NR	NR	F
Copper Alloys									
C17200	20	G	G	NR	G	G	G	F	F
C17300	50	G	G	NR	G	G	G	F	F
C18200	20	G	G	NR	G	NR	NR	NR	F
C18700/C99	85	E	G	NR	NR	NR	NR	NR	F
Brasses									
C21000	20	E	E	G	G	NR	NR	NR	G
C22000	20	E	E	G	G	NR	NR	NR	G
C23000	30	E	E	G	G	NR	F	NR	G
C26000	30	E	E	G	F	NR	G	NR	G
C28000	40	E	E	G	F	NR	G	NR	G
Leaded Brasses									
C33000	60	E	G	F	F	NR	F	NR	F
C35300	90	E	G	NR	NR	NR	NR	NR	F
C36000	100	E	G	NR	NR	NR	NR	NR	F
C36500	60	E	G	F	F	NR	NR	NR	F
Tin Brasses									
C46400	30	E	E	G	F	NR	G	F	G
C48500	70	E	G	NR	NR	NR	NR	NR	F
Phosphor Bronze									
C51000	20	E	E	F	G	F	G	F	E
Leaded Phosphor Bronze									
C54400	80	E	G	NR	NR	NR	NR	NR	F
Aluminum Silicon Bronze									
C64200	60	NR	F	NR	F	F	F	F	F
Silicon Bronze									
C65500	30	G	E	G	E	F	E	E	E
Copper-Nickel									
C71500	20	E	E	G	E	E	E	E	E
Nickel-Silver									
C75200	20	E	E	G	F	NR	G	F	G

E = Excellent
 G = Good
 F = Fair
 NR = Not Recommended

Mechanical Properties

Copper No. C10100

Form	Size Section (in.)	Temper	Tensile Strength (ksi)	Yield Strength (.5% Ext. under Load) (ksi)	Elongation in 2 in. (%)
FLAT PRODUCTS	.040	.050 mm	32.0	10.0	45
		.025 mm	34.0	11.0	45
		Eighth Hard	36.0	28.0	30
		Quarter Hard	38.0	30.0	25
		Half Hard	42.0	36.0	14
		Hard	50.0	45.0	6
		Spring	55.0	50.0	4
	.250	Extra Spring	57.0	53.0	4
		As Hot Rolled	34.0	10.0	45
		.050 mm	32.0	10.0	50
		Eighth Hard	36.0	28.0	40
		Quarter Hard	38.0	30.0	35
		Hard	50.0	45.0	12
		As Hot Rolled	32.0	10.0	50
ROD	1.0	Hard	45.0	40.0	20
	1.0	.050 mm	32.0	10.0	55
	.250	Hard (40%)	55.0	50.0	10
	1.0	Hard (35%)	48.0	44.0	16
	2.0	Hard (16%)	45.0	40.0	20
TUBE	1.0 in. OD x .065 in. Wall	As Hot Rolled	32.0	10.0	55
		.050 mm	32.0	10.0	45
	Light Drawn (15%)	.025 mm	34.0	11.0	45
		Hard Drawn (40%)	40.0	32.0	25
		Hard Drawn (40%)	55.0	50.0	8

Copper No. C11000

Form	Size Section (in.)	Temper	Tensile Strength (ksi)	Yield Strength (.5% Ext. under Load) (ksi)	Elongation in 2 in. (%)	
FLAT PRODUCTS	.040	.050 mm	32.0	10.0	45	
		.025 mm	34.0	11.0	45	
		Eighth Hard	36.0	28.0	30	
		Quarter Hard	38.0	30.0	25	
		Half Hard	42.0	36.0	14	
		Hard	50.0	45.0	6	
		Spring	55.0	50.0	4	
	.025	Extra Spring	57.0	53.0	4	
		As Hot Rolled	34.0	10.0	45	
		.050 mm	32.0	10.0	50	
		Eighth Hard	36.0	28.0	40	
		Quarter Hard	38.0	30.0	35	
		Hard	50.0	45.0	12	
		As Hot Rolled	32.0	10.0	50	
ROD	1.0	Hard	45.0	40.0	20	
	1.0	.050 mm	32.0	10.0	55	
	.250	Hard (40%)	55.0	50.0	10	
	1.0	Hard (35%)	48.0	44.0	16	
	2.0	Hard (16%)	45.0	40.0	20	
WIRE	1.0	As Hot Rolled	32.0	10.0	55	
		.080	.050 mm	35.0		35*
		Hard	55.0		1.5**	
		Spring	66.0		1.5**	

*Elongation in 10 inches.
**Elongation in 60 inches.

Copper No. C10200

Form	Size Section (in.)	Temper	Tensile Strength (ksi)	Yield Strength (.5% Ext. under Load) (ksi)	Elongation in 2 in. (%)
FLAT PRODUCTS	.040	.050 mm	32.0	10.0	45
		.025 mm	34.0	11.0	45
		Eighth Hard	36.0	28.0	30
		Quarter Hard	38.0	30.0	25
		Half Hard	42.0	36.0	14
		Hard	50.0	45.0	6
		Spring	55.0	50.0	4
	.250	Extra Spring	57.0	53.0	4
		As Hot Rolled	34.0	10.0	45
		.050 mm	32.0	10.0	50
		Eighth Hard	36.0	28.0	40
		Quarter Hard	38.0	30.0	35
		Hard	50.0	45.0	12
		As Hot Rolled	32.0	10.0	50
ROD	1.0	Hard	45.0	40.0	20
	1.0	.050 mm	32.0	10.0	55
	.250	Hard (40%)	55.0	50.0	10
	1.0	Hard (35%)	48.0	44.0	16
	2.0	Hard (16%)	45.0	40.0	20
TUBE	1.0 in. OD x .065 in. Wall	As Hot Rolled	32.0	10.0	55
		.050 mm	32.0	10.0	45
	Light Drawn (15%)	.025 mm	34.0	11.0	45
		Hard Drawn (40%)	40.0	32.0	25
		Hard Drawn (40%)	55.0	50.0	8

Copper No. C12200

Form	Size Section (in.)	Temper	Tensile Strength (ksi)	Yield Strength (.5% Ext. under Load) (ksi)	Elongation in 2 in. (%)
FLAT PRODUCTS	.040	.050 mm	32.0	10.0	45
		.025 mm	34.0	11.0	45
		Eighth Hard	36.0	28.0	30
		Quarter Hard	38.0	30.0	25
		Half Hard	42.0	36.0	14
		Hard	50.0	45.0	6
		Spring	55.0	50.0	4
	.250	Extra Spring	57.0	53.0	4
		As Hot Rolled	34.0	10.0	45
		.050 mm	32.0	10.0	50
		Eighth Hard	36.0	28.0	40
		Quarter Hard	38.0	30.0	35
		Hard	50.0	45.0	12
		As Hot Rolled	32.0	10.0	50
TUBE	1.0 in. OD x .065 in. Wall	Hard	45.0	40.0	20
		.050 mm	32.0	10.0	45
	Light Drawn (15%)	.025 mm	34.0	11.0	45
		Hard Drawn (40%)	40.0	32.0	25
		Hard Drawn (40%)	55.0	50.0	8

Copper No. C14300

Form	Size Section (in.)	Temper	Tensile Strength (ksi)	Yield Strength (.5% Ext. under Load) (ksi)	Elongation in 2 in. (%)
FLAT	.005	Special Spring	65.0	62.0	2
PROD-UCTS	.040	.050 mm	32.0	10.0	45
		.025	34.0	11.0	45
30		Eighth Hard	38.0	30.0	30.0
		Quarter Hard	40.0	32.0	25
		Half Hard	44.0	38.0	12
		Hard	52.0	47.0	6
		Spring	58.0	54.0	4
		Extra Spring	60.0	58.0	3



Copper No. C14500

Form	Size Section (in.)	Temper	Tensile Strength (ksi)	Yield Strength (.5% Ext. under Load) (ksi)	Elongation in 2 in. (%)
ROD	1.000	.050 mm	32.0	10.0	50
	.500	.015 mm	33.0	11.0	46
		Eighth Hard (6%)	38.0	30.0	26
	.250	Half Hard (20%)	43.0	40.0	18
	.500	Half Hard (20%)	43.0	40.0	20
	1.000	Half Hard (20%)	42.0	40.0	25
	2.000	Half Hard (15%)	42.0	39.0	35
	.250	Hard (45%)	53.0	49.0	10
	.500	Hard (35%)	48.0	44.0	15
	1.000	Hard (35%)	48.0	44.0	20

Copper Alloy No. C18200

Form	Size Section (in.)	Temper	Tensile Strength (ksi)	Yield Strength (.5% Ext. under Load) (ksi)	Elongation in 2 in. (%)	
FLAT PRODUCTS	.040	Solution Heat Treated	34.0	19.0	40	
		Solution Heat Treated and Aged (500°C - 3 hrs.)	51.0	36.0	22	
		Solution Heat Treated and Cold Worked (50%)	53.0	51.0	6	
		Solution Heat Treated, Cold Worked (50%), and Aged (450°C - 3 hrs.)	67.0	59.0	14	
		Solution Heat Treated and Cold Worked (91%)	74.0	73.0	5	
		Solution Heat Treated, Cold Worked (90%), and Aged	86.0	77.0	14	
		Solution Heat Treated	45.0	14.0	40	
		Solution Heat Treated and Aged (500°C - 3 hrs.)	70.0	55.0	21	
		Solution Heat Treated and Cold Worked (60.5%)	57.0	56.0	11	
		Solution Heat Treated, Cold Worked (60.5%), and Aged (450°C - 3 hrs.)	77.0	65.0	16	
ROD	.156	Solution Heat Treated, Cold Worked (50%), Aged and Cold Worked (6%)	77.0	67.0	19	
		Solution Heat Treated and Aged	72.0	65.0	18	
		Solution Heat Treated and Aged	70.0	65.0	18	
		Solution Heat Treated and Aged	65.0	55.0	18	
		Solution Heat Treated and Aged	55.0	43.0	25	
		.500	Solution Heat Treated	45.0	14.0	40
			Solution Heat Treated and Aged (500°C - 3 hrs.)	70.0	55.0	21
			Solution Heat Treated and Cold Worked (60.5%)	57.0	56.0	11
			Solution Heat Treated, Cold Worked (60.5%), and Aged (450°C - 3 hrs.)	77.0	65.0	16
			Solution Heat Treated, Cold Worked (50%), Aged and Cold Worked (6%)	77.0	67.0	19
Solution Heat Treated and Aged	72.0		65.0	18		
Solution Heat Treated and Aged	70.0		65.0	18		
Solution Heat Treated and Aged	65.0		55.0	18		
Solution Heat Treated and Aged	55.0		43.0	25		

Copper Alloy Nos. C17200 and C17300

Form	Size Section (in.)	Temper	Tensile Strength (ksi)	Yield Strength (.5% Ext. under Load) (ksi)	Elongation in 2 in. (%)			
FLAT PRODUCTS	.188 in.	Under A	70.0	32.0	45			
		1/4H	80.0	70.0	25			
		1/2H	92.0	82.0	15			
		H	110.0	104.0	5			
		AM	105.0	82.0	20			
		1/4HM	115.0	92.0	17			
		1/2HM	128.0	105.0	15			
		HM	142.0	122.0	12			
		XHM	168.0	148.0	7			
		XHMS	182.0	160.0	6			
		ROD	All	A	68.0	25.0	48	
				Up to 3/8 in. incl.	H	112.0	90.0	15
				Over 3/8 to 1 in. incl.	H	105.0	90.0	15
				Over 1 in.	H	100.0	90.0	15

Note:

A—Solution Heat Treated

H—Hard (except for tempers using M designations)

T—Precipitation Heat Treated

AM through XHMS—Special Mill Processing and Precipitation Treatment

Copper Alloy No. 17510

Form	Condition	Tensile Strength (ksi)	Yield Strength (.2% Offset) (ksi)	Elongation in 2 in. (%)
Coil	HT	110	100	8
Rod, Bar,	AT	100	80	10
Plate, Tube	HT	110	100	10

Copper Alloy No. C18000

Tensile Strength (ksi)	Yield Strength (ksi)	Elongation in 2 in. (%)
100	75	13

Copper Alloy No. A945

Tensile Strength (ksi)	Yield Strength (ksi)	Elongation in 2 in. (%)
130	80	6

Copper Alloy No. C18700/C99

Form	Size Section (in.)	Temper	Tensile Strength (ksi)	Yield Strength (.5% Ext. under Load) (ksi)	Elongation in 2 in. (%)
ROD	1.0	.050 mm	32.0	10.0	45
		Half Hard (20%)	43.0	40.0	18
		Half Hard (20%)	42.0	38.0	25
		Hard (50%)	55.0	50.0	8
		Hard (45%)	53.0	49.0	10
		Hard (35%)	48.0	44.0	12
		Hard (35%)	48.0	42.0	15

Copper Alloy No. C21000

Form	Size Section (in.)	Temper	Tensile Strength (ksi)	Yield Strength (.5% Ext. under Load) (ksi)	Elongation in 2 in. (%)
ROLLED STRIP	.040	.050 mm	34.0	10.0	45
		.035 mm	35.0	11.0	45
		.015 mm	38.0	14.0	42
		Quarter Hard	42.0	32.0	25
		Half Hard	48.0	40.0	12
		Hard	56.0	50.0	5
		Extra Hard	61.0	55.0	4
		Spring	64.0	58.0	4

Mechanical Properties

Copper Alloy No. C22000

Form	Size Section (in.)	Temper	Tensile Strength (ksi)	Yield Strength (.5% Ext. under Load) (ksi)	Elongation in 2 in. (%)	
FLAT PRODUCTS	.040	.050 mm	37.0	10.0	45	
		.035 mm	38.0	12.0	45	
		.025 mm	39.0	14.0	44	
		.015 mm	41.0	15.0	42	
		Quarter Hard	45.0	35.0	25	
		Half Hard	52.0	45.0	11	
		Hard	61.0	54.0	5	
		Extra Hard	67.0	58.0	4	
		Spring	72.0	62.0	3	
		.250	.035 mm	38.0	12.0	50
			Half Hard	52.0	45.0	15
			As Hot Rolled	39.0	14.0	44
		.040	As Hot Rolled	37.0	10.0	45

Copper Alloy No. C23000

Form	Size Section (in.)	Temper	Tensile Strength (ksi)	Yield Strength (.5% Ext. under Load) (ksi)	Elongation in 2 in. (%)		
FLAT PRODUCTS	.040	.070 mm	39.0	10.0	48		
		.050 mm	40.0	12.0	47		
		.035 mm	41.0	14.0	46		
		.025 mm	43.0	16.0	44		
		.015 mm	45.0	18.0	42		
		Quarter Hard	50.0	39.0	25		
		Half Hard	57.0	49.0	12		
		Hard	70.0	57.0	5		
		Extra Hard	78.0	61.0	4		
		Spring	84.0	63.0	3		
		TUBE	1.0 in. OD x .065 in. Wall	.050 mm	40.0	12.0	55
				.015 mm	44.0	18.0	45
				Light Drawn (15%) Hard Drawn (35%)	50.0 70.0	40.0 58.0	30 8
		PIPE	3/4 in. SPS	.015 mm	44.0	18.0	45

Copper Alloy No. C26000

Form	Size Section (in.)	Temper	Tensile Strength (ksi)	Yield Strength (.5% Ext. under Load) (ksi)	Elongation in 2 in. (%)		
FLAT PRODUCTS	.040	.100 mm	44.0	11.0	66		
		.070 mm	46.0	14.0	65		
		.050 mm	47.0	15.0	62		
		.035 mm	49.0	17.0	57		
		.025 mm	51.0	19.0	55		
		.015 mm	53.0	22.0	54		
		Quarter Hard	54.0	40.0	43		
		Half Hard	62.0	52.0	25		
		Hard	76.0	63.0	8		
		Extra Hard	86.0	65.0	5		
		Spring	94.0	65.0	3		
		Extra Spring	99.0	65.0	3		
		WIRE	.080	.050 mm	48.0		64
				.035 mm	50.0		60
.025 mm	52.0				58		
.015 mm	54.0				56		
Eighth Hard	58.0				35		
Quarter Hard	70.0				20		
Extra Hard	124.0				4		
Spring	130.0				3		
TUBE	1.0 in. OD x .065 in. Wall			.050 mm	47.0	15.0	65
				.025 mm	52.0	20.0	55
		Hard Drawn (35%)	78.0	64.0	8		
ROD	1.0	.050 mm	48.0	16.0	65		
		Eighth Hard (6%)	55.0	40.0	48		
		Half Hard (20%)	70.0	52.0	30		

Copper No. C28000

Form	Size Section (in.)	Temper	Tensile Strength (ksi)	Yield Strength (.5% Ext. under Load) (ksi)	Elongation in 2 in. (%)
FLAT PRODUCTS	.040	Soft Annealed	54.0	21.0	45
		As Hot Rolled	54.0	21.0	45
		Eighth Hard	60.0	35.0	30
		Half Hard	70.0	50.0	10
ROD	1.0	Soft Annealed	54.0	21.0	50
		Quarter Hard	72.0	50.0	25
		As Extruded	52.0	20.0	52
TUBE	1.0 OD x .065 Wall	Light Annealed	56.0	23.0	50
		Hard Drawn	74.0	55.0	10

Copper Alloy No. C33000

Form	Size Section (in.)	Temper	Tensile Strength (ksi)	Yield Strength (.5% Ext. under Load) (ksi)	Elongation in 2 in. (%)
TUBE	1.0 in. OD x .065 in. Wall	.050 mm	47.0	15.0	60
		.025 mm	52.0	20.0	50
		Hard Drawn (35%)	75.0	60.0	7

Copper Alloy No. C35300

Form	Size Section (in.)	Temper	Tensile Strength (ksi)	Yield Strength (.5% Ext. under Load) (ksi)	Elongation in 2 in. (%)
FLAT PRODUCTS	.040	.035 mm	49.0	17.0	52
		Quarter Hard	54.0	40.0	38
		Half Hard	61.0	50.0	20
		Hard	74.0	60.0	7
		Extra Hard	85.0	62.0	5
ROD	1.0	Half Hard (20%)	58.0	45.0	25

Copper Alloy No. C36000

Form	Size Section (in.)	Temper	Tensile Strength (ksi)	Yield Strength (.5% Ext. under Load) (ksi)	Elongation in 2 in. (%)
ROD	1.0	Soft Anneal	49.0	18.0	53
		Half Hard (25%)	68.0	52.0	18
		Half Hard (20%)	58.0	45.0	25
		Half Hard (15%)	55.0	44.0	32

Copper Alloy No. C36500

Form	Size Section (in.)	Temper	Tensile Strength (ksi)	Yield Strength (.5% Ext. under Load) (ksi)	Elongation in 2 in. (%)
PLATE	1.0	As Hot Rolled	54.0	20.0	45

Copper Alloy No. C38500

Form	Size Section (in.)	Temper	Tensile Strength (ksi)	Yield Strength (.5% Ext. under Load) (ksi)	Elongation in 2 in. (%)
SHAPES	1.0	M30	60.0	20.0	30



Copper Alloy No. C46400

Form	Size Section (in.)	Temper	Tensile Strength (ksi)	Yield Strength (.5% Ext. under Load) (ksi)	Elongation in 2 in. (%)
FLAT PRODUCTS	.040	Light Anneal	62.0	30.0	40
		Quarter Hard	70.0	58.0	17
	.250	Soft Anneal	58.0	25.0	49
		Light Anneal	60.0	28.0	45
ROD	1.0	As Hot Rolled	55.0	25.0	50
		Soft Anneal	58.0	27.0	45
	.250	Light Anneal	63.0	30.0	40
		Quarter Hard (10%)	70.0	48.0	25
		Half Hard (20%)	80.0	57.0	20
	1.0	Soft Anneal	57.0	25.0	47
		Light Anneal	63.0	30.0	40
		Quarter Hard (8%)	69.0	46.0	27
		Half Hard (20%)	75.0	53.0	20
		2.0	Soft Anneal	56.0	25.0
Light Anneal	62.0		28.0	43	
Quarter Hard (8%)	67.0		40.0	35	

Copper Alloy No. C48500

Form	Size Section (in.)	Temper	Tensile Strength (ksi)	Yield Strength (.5% Ext. under Load) (ksi)	Elongation in 2 in. (%)
ROD	1.0	Soft Anneal	57.0	25.0	40
		Quarter Hard (8%)	69.0	46.0	20
		Half Hard (20%)	75.0	53.0	15

Copper Alloy No. C51000

Form	Size Section (in.)	Temper	Tensile Strength (ksi)	Yield Strength (.5% Ext. under Load) (ksi)	Elongation in 2 in. (%)
FLAT PRODUCTS	.040	.050 mm	47.0	19.0	64
		.035 mm	49.0	20.0	58
		.025 mm	50.0	21.0	52
		.015 mm	53.0	22.0	50
		Half Hard	68.0	55.0	28
		Hard	81.0	75.0	10
		Extra Hard	92.0	80.0	6
		Spring	100.0	80.0	4
		Extra Spring	107.0	80.0	3
		ROD	.500	Half Hard (20%)	75.0
Half Hard (20%)	70.0			58.0	25
WIRE	.080	.035 mm	50.0	20.0	58
		Quarter Hard	68.0	60.0	24
		Half Hard	85.0	80.0	8
		Hard	110.0		5
		Extra Hard (75%)	130.0		3
		Spring	140.0		2

Copper Alloy No. C54400

Form	Size Section (in.)	Temper	Tensile Strength (ksi)	Yield Strength (.5% Ext. under Load) (ksi)	Elongation in 2 in. (%)
FLAT PRODUCTS	.040	.035 mm	44.0	19.0	50
		Half Hard	58.0	40.0	24
ROD	.500	Hard (35%)	75.0	63.0	15
		Hard (25%)	68.0	57.0	20

Copper Alloy No. C64200

Form	Size Section (in.)	Temper	Tensile Strength (ksi)	Yield Strength (.5% Ext. under Load) (ksi)	Elongation in 2 in. (%)
ROD	.750	As Extruded	75.0	35.0	32
		Light Anneal	92.0	58.0	22
		Light Anneal	90.0	55.0	28
		Hard (15%)	102.0	68.0	22
		Hard (10%)	93.0	60.0	26

Copper Alloy No. C65500

Form	Size Section (in.)	Temper	Tensile Strength (ksi)	Yield Strength (.5% Ext. under Load) (ksi)	Elongation in 2 in. (%)		
FLAT PRODUCTS	.040	.070 mm	56.0	21.0	63		
		.035 mm	60.0	25.0	60		
		.015 mm	63.0	30.0	55		
		Quarter Hard	68.0	35.0	30		
		Half Hard	78.0	45.0	17		
		Hard	94.0	58.0	8		
		Extra Hard	104.0	60.0	6		
		Spring	110.0	62.0	4		
		ROD	1.0	.050 mm	58.0	22.0	60
				Half Hard (20%)	78.0	45.0	35
Hard (36%)	92.0			55.0	22		
Extra Hard (50%)	108.0			60.0	13		

Copper Alloy No. C67300

Tensile Strength (ksi)	Yield Strength (.5% Ext. under Load) (ksi)	Elongation in 2 in. (%)
75	55	15

Copper Alloy No. C71500

Form	Size Section (in.)	Temper	Tensile Strength (ksi)	Yield Strength (.5% Ext. under Load) (ksi)	Elongation in 2 in. (%)
FLAT PRODUCTS	1.0	As Hot Rolled	55.0	20.0	45
		ROD	1.0	Half Hard (20%)	75.0

Copper Alloy No. C75200

Form	Size Section (in.)	Temper	Tensile Strength (ksi)	Yield Strength (.5% Ext. under Load) (ksi)	Elongation in 2 in. (%)
FLAT PRODUCTS	.040	.035 mm	58.0	25.0	40
		.015 mm	60.0	30.0	32
		Quarter Hard	65.0	50.0	20
		Half Hard	74.0	62.0	8
		Hard	85.0	74.0	3

Chemical Compositions

Coppers

Copper No.	Description	Cu (incl. Ag) (% Min.)	Ag (% Min.)	As	Sb	P	Te	Other Named Elements
C10100	Oxygen Free Electronic	99.99 (Exc. Ag)	—	—	—	.0003	.0010	Se + Te + Bi + As + Sb + Sn + Mn = .0040; Hg = Zn = Cd = .0001; S = .0018; Pb = Se = Bi = O = .0010
C10200	Oxygen Free	99.95	—	—	—	—	—	—
C11000	Electrolytic Tough Pitch	99.9	—	—	—	—	—	Oxygen and trace elements may vary depending on the process
C12200	Phosphorus Deoxidized, High Residual Phosphorus	99.9	—	—	—	.015-.040	—	—
C14300	Cadmium Copper Deoxidized	99.9	—	—	—	—	—	.05-.15 Cd
C14500	Tellurium Bearing	99.9 (inc. Te)	—	—	—	.004-.012	.40-.7	—

Copper Alloys

Copper Alloy No.	Trade Name	Cu (incl. Ag)	Fe	Ni	Co	Cr	Si	Be	Pb	Other Named Elements
C17200	Beryllium Copper	Rem.	—	—	—	—	.20	1.80-2.00	—	Al = .20
C17300		Rem.	—	—	—	—	.20	1.80-2.00	.20-.6	Al = .20 Ni + Co = .20 min.; Ni + Fe + Co = .6
C17510	Beryllium Copper Alloy	Rem.	.10	1.4-2.2	.30	—	.20	.20-.6	—	Al = .20
C18000	A940	Rem.	.15	2.0-3.0 (incl. Co)	—	.10-.6	.40-.8	—	—	—
	A945	84.9	—	10.8	—	1.5	2.8	—	—	—
C18200	Chromium Copper	Rem.	.10	—	—	.6-1.2	.10	—	.05	—
C18700	C99	Rem.	—	—	—	—	—	—	.8-1.5	—
	C97	97.8	—	1.0	—	—	—	—	1.0	P = .22

Brasses

Copper Alloy No.	Trade Name	Cu	Pb	Fe	Zn	Other Named Elements
C21000	Gilding, 95%	94.0-96.0	.03	.05	Rem.	—
C22000	Commercial Bronze, 90%	89.0-91.0	.05	.05	Rem.	—
C23000	Red Brass, 85%	84.0-86.0	.05	.05	Rem.	—
C26000	Cartridge Brass, 70%	68.5-71.5	.07	.05	Rem.	—
C27200		62.0-65.0	.07	.07	Rem.	—
C28000	Muntz Metal, 60%	59.0-63.0	.30	.07	Rem.	—

Leaded Brasses

Copper Alloy No.	Trade Name	Cu	Pb	Fe	Sn	Zn	Other Named Elements
C33000	Low Leaded Brass (Tube)	65.0-68.0	.25-.7 (.20 for O.D. > 5")	.07	—	Rem.	—
C34500		62.0-65.0	1.5-2.5	.15	—	Rem.	—
C35300	High Leaded Brass, 62%	60.0-63.0 (61.0 min. for rod)	1.5-2.5	.15 (.10 for flat products)	—	Rem.	—
C36000	Free Cutting Brass	60.0-63.0	2.5-3.7	.35	—	Rem.	—
C36500	Leaded Muntz Metal, Uninhibited	58.0-61.0	.25-.7	.15	.25	Rem.	—
C38000	Architectural Bronze, Low Leaded	55.0-60.0	1.5-2.5	.35	.30	Rem.	Al=.50
C38500	Architectural Bronze	55.0-59.0	2.5-3.5	.35	.30	Rem.	—



Chemical Compositions

Tin Brasses

Copper Alloy No.	Trade Name	Cu	Pb	Fe	Sn	Zn	P	Other Named Elements
C46400	Naval Brass, Uninhibited	59.0-62.0	.20	.10	.5-1.0	Rem.	—	—
C48500	Naval Brass, High Leaded	59.0-62.0	1.3-2.2	.10	.5-1.0	Rem.	—	—

Phosphor Bronze

Copper Alloy No.	Trade Name	Cu	Pb	Fe	Sn	Zn	P	Other Named Elements
C51000	Phosphor Bronze, 5% A	Rem.	.05	.10	4.2-5.8	.30	.03-.35	—

Leaded Phosphor Bronze

Copper Alloy No.	Trade Name	Cu	Pb	Fe	Sn	Zn	P	Other Named Elements
C54400	Phosphor Bronze, B-2	Rem.	3.5-4.5	.10	3.5-4.5	1.5-4.5	.01-.50	—

Aluminum Silicon Bronze

Copper Alloy No.	Cu (incl. Ag)	Pb	Fe	Sn	Zn	Al	Mn	Si	Ni (incl. Co)	As
C64200	Rem.	.05	.30	.20	.50	6.3-7.6	.10	1.5-2.2	.25	.15

Silicon Bronze

Copper Alloy No.	Trade Name	Cu (incl. Ag)	Pb	Fe	Zn	Mn	Si	Ni (incl. Co)
C65500	High Silicon Bronze, A	Rem.	.05	.8	1.5	.50-1.3	2.8-3.8	.6

Copper-Zinc

Copper Alloy No.	Cu (incl. Ag)	Pb	Fe	Sn	Zn	Ni (incl. Co)	Al	Mn	Si
C67300	58.0-63.0	.40-3.0	.50	.30	Rem.	.25	.25	2.0-3.5	.50-1.5

Copper-Nickel

Copper Alloy No.	Trade Name	Cu (incl. Ag)	Pb	Fe	Zn	Ni (incl. Co)	Mn	Other Named Elements
C71500	Copper-Nickel, 30%	Rem.	.05	.40-1.0	1.0	29.0-33.0	1.0	For welding applications: Zn = .50; Pb = .02; S = .02; and C = .05

Nickel-Silver

Copper Alloy No.	Trade Name	Cu	Pb	Fe	Zn	Ni (incl. Co)	Mn
C75200	Nickel-Silver, 65-18	63.5-66.5	.05	.25	Rem.	16.5-19.5	.50

Specification Cross Reference*

ALLOY	AMS	ASTM	FED	SAE	FORM	ALLOY	AMS	ASTM	FED	SAE	FORM	
C101 (OFE)	B1	B2	QQ-W-343	J461, J463	Copper, Hard Drawn Wire	C102 cont.	B640	B640	J461, J463	J461, J463	Copper, Welded Tube for Air-Cond. and Refrig. Service	
			QQ-W-343		Copper, Medium-Hard Drawn Wire						Copper, Seamless and Welded Distribution Tube (Type D)	
	B3	B33	QQ-W-343	J461, J463	Copper, Soft Wire	B641	B641	J461, J463	J461, J463	J461, J463	Copper, Seamless and Welded Distribution Tube (Type D)	
			QQ-W-343		Copper, Tinned Soft Wire for Electrical						Copper, Seamless Water Tube (special use)	
	B75	B111		J461, J463	Copper, Seamless Tube Soft, Drawn Temper	B707	B707	J461, J463	J461, J463	J461, J463	Copper, Seamless Water Tube (special use)	
											Copper, Seamless Cond. Tube and Ferrule Stock	Copper, Welded Water Tube
	B133	B152	QQ-C-502	J461, J463	Copper, Rod, Bar, Shape	B716	B716	J461, J463	J461, J463	J461, J463	Copper, Brazing Alloy	
			QQ-C-576		Copper, SHT, PLT, Strip, and Rolled Bar						Copper, Rod, Shape, Flat Bar, Wire, Strip-Finished Edge	
	B170	B187	B188	B246	QQ-C-502	J461, J463	J461, J463	J461, J463	J461, J463	J461, J463	J461, J463	Copper, SHT, PLT, Strip, Bar, Sawed, Shr, Slit and Slit Edge Rolled
	B188	B246	QQ-W-343	J461, J463	Copper, Seamless Tube, Pipe	B716	B716	J461, J463	J461, J463	J461, J463	J461, J463	Copper, Non-Insulated Electrical Wire
												Copper, Tinned Medium-Hard Drawn and Hard Drawn Wire for Electrical
	B272	B280	QQ-C-502	J461, J463	Copper, Flat Wire, Strip with Rolled or Drawn Edges	B716	B716	J461, J463	J461, J463	J461, J463	J461, J463	Copper, Water Tube Wrought Copper
												Copper, Seamless Tube for Air-Cond. and Refrig. Field Service
	B355	B359	QQ-W-343	J461, J463	Copper, Nickel Coated Soft Wire	B716	B716	J461, J463	J461, J463	J461, J463	J461, J463	Copper, Seamless Pipe
												Copper, Seamless Tube for Cond. and Heat-Exchanger with Integral Fins
	B447	B640	B641	F68	QQ-C-502	J461, J463	J461, J463	J461, J463	J461, J463	J461, J463	J461, J463	Copper, Seamless Tube, Soft, Drawn Temper
	B641	F68	QQ-C-502	J461, J463	Copper, Welded Tube for Air-Cond. and Refrig. Service	B716	B716	J461, J463	J461, J463	J461, J463	J461, J463	Copper, Seamless Cond. Tube and Ferrule Stock
												Copper, Seamless and Welded Distribution Tube (Type D)
F68	QQ-C-502	QQ-C-576	J461, J463	Copper, Electronic Grade Wrought Form	B716	B716	J461, J463	J461, J463	J461, J463	J461, J463	Copper, SHT, PLT, Strip, Bar, Sawed, Shr, Slit and Slit Edge Rolled	
											Copper, Rod, Shape, Flat Bar, Wire, Strip-Finished Edge	Copper, Non-Insulated Electrical Wire
QQ-C-576	QQ-W-343		J461, J463	Copper, SHT, PLT, Strip, Bar, Sawed, Shr, Slit and Slit Edge Rolled	B716	B716	J461, J463	J461, J463	J461, J463	J461, J463	Copper, Threadless Pipe	
											Copper, Non-Insulated Electrical Wire	Copper, Drainage Tube (DWW)
C102 (OF)	4501A	B152	QQ-C-576	J461, J463	Copper, SHT, PLT, Strip	B372	B372	J461, J463	J461, J463	J461, J463	Copper, Seamless Rect. Waveguide Tube	
			QQ-C-502		Copper, Rod, Bar, Shape, Oxygen Free, Hard Temper						Copper, U-Bend Seamless Heat Exchanger and Cond. Tube	
4701C	B3	B1	QQ-C-502	J461, J463	Copper, Annealed Wire	B395	B395	J461, J463	J461, J463	J461, J463	Copper, Seamless Water Tube (special use)	
			QQ-C-502		Copper, Hard Drawn Wire						Copper, Welded Water Tube	
B2	B3	B33	QQ-C-502	J461, J463	Copper, Medium-Hard Drawn Wire	B447	B640	J461, J463	J461, J463	J461, J463	Copper, Welded Tube for Air-Cond. and Refrig. Service	
			QQ-C-502		Copper, Soft Wire						Copper, Seamless and Welded Distribution Tube (Type D)	
B3	B33	QQ-W-343	QQ-W-343	J461, J463	Copper, Tinned Soft Wire for Electrical	B641	B641	J461, J463	J461, J463	J461, J463	Copper, Seamless Water Tube (special use)	
					Copper, Seamless Pipe						Copper, Welded Water Tube	
B42	B68	WW-P-377	J461, J463	J461, J463	Copper, Seamless Tube, Bright Annealed	B707	B707	J461, J463	J461, J463	J461, J463	Copper, Seamless Water Tube (special use)	
					Copper, Seamless Tube, Soft, Drawn Temper						Copper, Welded Water Tube	
B75	B88	WW-T-799	J461, J463	J461, J463	Copper, Seamless Tube, Soft, Drawn Temper	B716	B716	J461, J463	J461, J463	J461, J463	Copper, Brazing Alloy	
					Copper, Seamless Water Tube						Copper, Pipe, Regular and Extra-Strong	
B111	B133	B152	QQ-C-502	J461, J463	Copper, Seamless Cond. Tube and Ferrule Stock	B716	B716	J461, J463	J461, J463	J461, J463	Copper, Seamless Water Tube	
			QQ-C-576		Copper, Rod, Bar, Shape						Copper, Seamless Water Tube	
B170	B187	B188	QQ-C-502	J461, J463	Copper, SHT, PLT, Strip, and Rolled Bar	B716	B716	J461, J463	J461, J463	J461, J463	Copper, Brazing Alloy	
					Copper, Refinery Shapes						Copper, Pipe, Regular and Extra-Strong	
B187	B188	B246	QQ-W-343	J461, J463	Copper, Bus Bar, Rod, Shape and Tube	B716	B716	J461, J463	J461, J463	J461, J463	Copper, Regular and Extra-Strong	
					Copper, Tinned Hard-Drawn and Medium-Hard Drawn Wire for Electrical						Copper, Seamless Bus Pipe and Tube	
B246	B272	B280	QQ-C-502	J461, J463	Copper, Flat Wire, Strip with Rolled or Drawn Edges	B716	B716	J461, J463	J461, J463	J461, J463	Copper, Seamless Water Tube	
					Copper, Seamless Tube for Air-Cond. and Refrig. Field Service						Copper, Seamless Water Tube	
B355	B359	QQ-W-343	J461, J463	J461, J463	Copper, Nickel-Coated Soft Wire	B716	B716	J461, J463	J461, J463	J461, J463	Copper, Seamless Water Tube	
					Copper, Nickel-Coated Soft Wire						Copper, Seamless Water Tube	
B372	B395	B447	QQ-W-343	J461, J463	Copper, Seamless Tube for Cond. and Heat-Exchangers with Integral Fins	B716	B716	J461, J463	J461, J463	J461, J463	Copper, Seamless Water Tube	
					Copper, Seamless Rect. Waveguide Tube						Copper, Seamless Water Tube	
B395	B447	QQ-W-343	J461, J463	J461, J463	Copper, U-Bend Seamless Heat Exchanger and Cond. Tube	B716	B716	J461, J463	J461, J463	J461, J463	Copper, Seamless Water Tube	
					Copper, Seamless Rect. Waveguide Tube						Copper, Seamless Water Tube	
B447	QQ-W-343		J461, J463	J461, J463	Copper, Welded Tube	B716	B716	J461, J463	J461, J463	J461, J463	Copper, Seamless Water Tube	
					Copper, Welded Tube						Copper, Seamless Water Tube	



Specification Cross Reference*

ALLOY	AMS	ASTM	FED	SAE	FORM	ALLOY	AMS	ASTM	FED	SAE	FORM					
C105 (OFS)	B1	B2	QQ-W-343		Copper, Hard Drawn Wire	C108 cont.			QQ-B-650		Copper, Brazing Alloy					
			QQ-W-343		Copper, Medium Hard Drawn Wire				WW-P-377		Copper, Pipe, Regular and Extra-Strong					
	B3	B133	QQ-W-343		Copper, Soft Wire				C110 (ETP)	4500E	B152	QQ-C-576	J461, J463	Copper, SHT, PLT, Strip		
			QQ-C-502		Copper, Rod, Bar, Shape							QQ-W-343	J461, J463	Copper, Hard Drawn Wire		
	B152	B187	QQ-C-576		Copper, SHT, PLT, Strip, and Rolled Bar							B2		QQ-W-343	J461, J463	Copper, Medium-Hard Drawn Wire
			QQ-C-502		Copper, Bus Bar, Rod, Shape							B3		QQ-W-343	J461, J463	Copper, Soft Wire
	B188	B246	QQ-C-502		Copper, Seamless Bus Pipe and Tube							B5		QQ-W-343	J461, J463	Copper, ETP Refinery Shapes, i.e., Ingot
			QQ-W-343		Copper, Tinned Hard Drawn and Medium Hard Drawn Wire for Electrical							B8			J461, J463	Copper, Concentric-Lay-Stranded Conductors, Hard, Medium-Hard, Soft
	B272	B355	QQ-C-502		Copper, Flat Wire, Strip with Rolled or Drawn Edges							B33		QQ-W-343	J461, J463	Copper, Tinned Soft Wire for Electrical
			QQ-C-502		Copper, Nickel Coated Soft Wire							B47		QQ-W-343	J461, J463	Copper, Trolley Wire
	B355	B187	QQ-C-502		Copper, Rod, Shape, Flat Bar, Wire, Strip-Finished Edge							B48		QQ-W-343	J461, J463	Copper, Rect. and Sq. Soft Bare Wire for Electrical
			QQ-C-576		Copper, SHT, PLT, Strip, Bar, Sawed, Shr, Slit and Slit Edge Rolled							B101		QQ-C-576	J461, J463	Copper, Lead-Coated SHT
	B355	B188	QQ-W-343		Copper, Non-Insulated Electrical Wire							B124		QQ-C-502	J461, J463	Copper, Forging Rod, Bar, Shape
			QQ-B-650		Copper, Brazing Alloy							B133		QQ-C-502	J461, J463	Copper, Rod, Bar, Shapes
	B355	B188	QQ-C-502		Copper, Rod, Shape, Flat Bar, Wire, Strip-Finished Edge							B152		QQ-C-576	J461, J463	Copper, SHT, PLT, Strip, and Rolled Bar
QQ-W-343				Copper, Non-Insulated Electrical Wire	B187		QQ-C-502	J461, J463				Copper, Bus Bar, Rod, Shape				
C107 (OFS)	B1	B2	QQ-W-343		Copper, Hard Drawn Wire	B188		QQ-C-502				J461, J463	Copper, Seamless Bus Pipe and Tube			
			QQ-W-343		Copper, Medium Hard Drawn Wire	B246		QQ-W-343	J461, J463	Copper, Tinned Hard Drawn and Medium-Hard Drawn Wire for Electrical						
	B3	B133	QQ-W-343		Copper, Soft Wire	B272		QQ-C-502	J461, J463	Copper, Flat Wire, Strip with Rolled or Drawn Edges						
			QQ-C-502		Copper, Rod, Bar, Shape	B283			J461, J463	Copper, Die Forging (Hot-Pressed)						
	B152	B187	QQ-C-576		Copper, SHT, PLT, Strip and Rolled Bar	B355			J461, J463	Copper, Nickel Coated Soft Wire						
			QQ-C-502		Copper, Bus Bar, Rod, Shape	B370		QQ-C-576	J461, J463	Copper, SHT, Strip for Building Construction						
	B188	B246	QQ-W-343		Copper Seamless Bus Pipe and Tube	B447		QQ-B-575	J461, J463	Copper, Welded Tube						
			QQ-W-343		Copper, Tinned Hard Drawn and Medium Hard Drawn Wire for Electrical	B47		QQ-B-650	J461, J463	Copper, Braided Wire						
	B272	B355	QQ-C-502		Copper, Flat Wire, Strip with Rolled or Drawn Edges	B246		QQ-C-502	J461, J463	Copper, Brazing Alloy						
			QQ-W-343		Copper, Nickel Coated Soft Wire	B272		QQ-C-502	J461, J463	Copper, Rod, Shape, Flat Bar, Wire, Strip-Finished Edge						
	B355	B187	QQ-B-650		Copper, Brazing Alloy	B272		QQ-C-576	J461, J463	Copper, SHT, PLT, Strip, Bar, Sawed, Shr, Slit, and Slit Edge Rolled						
			QQ-C-502		Copper, Rod, Shape, Flat Bar, Wire, Strip-Finished Edge	B355		QQ-W-343	J461, J463	Copper, Non-Insulated Electrical Wire						
	B355	B188	QQ-C-576		Copper, SHT, PLT, Strip, Bar, Sawed, Shr, Slit, and Slit Edge Rolled	B370		WW-P-377	J461, J463	Copper, Pipe-Regular and Extra-Strong						
			QQ-W-343		Copper, Non-Insulated Electrical Wire	B447			J461, J463	Wrought Copper						
	C108 (OFLP)	B42	B68	WW-P-377		Copper, Seamless Pipe	C111 (ETP)		B1	QQ-W-343	J461, J463	Copper, Hard Drawn Wire				
WW-P-377					Copper, Seamless Tube, Bright Annealed	B2					QQ-W-343	J461, J463	Copper, Medium-Hard Drawn Wire			
B75		B88	WW-P-377		Copper, Seamless Tube, Soft, Drawn Temper	B3					QQ-W-343	J461, J463	Copper, Soft Wire			
			WW-P-377		Copper, Seamless Water Tube	B8					QQ-W-343	J461, J463	Copper, Concentric-Lay-Stranded Conductors, Hard, Medium-Hard, Soft			
B111		B133	WW-P-377		Copper, Seamless Cond. Tube and Ferrule Stock	B33					QQ-W-343	J461, J463	Copper, Tinned Soft Wire for Electrical			
			WW-P-377		Copper, Rod, Bar, Shape	B47					QQ-W-343	J461, J463	Copper, Trolley Wire			
B152		B280	WW-P-377		Copper, SHT, PLT, Strip, and Rolled Bar	B246					QQ-W-343	J461, J463	Copper, Tinned Hard Drawn and Medium-Hard Drawn Wire for Electrical			
			WW-P-377		Copper, Seamless Tube for Air-Cond. and Refrig. Field Service	B272					QQ-C-502	J461, J463	Copper, Flat Wire, Strip with Rolled or Drawn Edges			
B302		B306	WW-P-377		Copper, Threadless Pipe	B355					QQ-B-650	J461, J463	Copper, Nickel Coated Soft Wire			
			WW-P-377		Copper, Drainage Tube (DWT)	B355					QQ-C-502	J461, J463	Copper, Brazing Alloy			
B359		B360	WW-P-377		Copper, Seamless Tube for Cond. and Heat Exchangers with Integral Fins	B355					QQ-C-502	J461, J463	Copper, Rod, Shape, Flat Bar, Wire, Strip-Finished Edge			
			WW-P-377		Copper, Hard Drawn Capillary Tube for Restrictor Application	B355					QQ-C-576	J461, J463	Copper, SHT, PLT, Strip, Bar, Sawed, Shr, Slit and Slit Edge Rolled			
B395		B447	WW-P-377		Copper, U-Bend Seamless Heat Exchanger and Cond. Tube	B355					QQ-W-343	J461, J463	Copper, Non-Insulated Electrical Wire			
			WW-P-377		Copper, Welded Tube	B355					QQ-W-343	J461, J463	Wrought Copper			
B543		B640	WW-P-377		Copper, Welded Heat-Exchanger Tube	B355					QQ-W-343	J461, J463	Copper, Hard Drawn Wire			
	WW-P-377			Copper, Welded Tube for Air-Cond. and Refrig. Service	B355		QQ-W-343	J461, J463	Copper, Medium-Hard Drawn Wire							
B641	B707	WW-P-377		Copper, Seamless and Welded Distribution Tube (Type D)	B355		QQ-W-343	J461, J463	Copper, Soft Wire							
		WW-P-377		Copper, Seamless Water Tube (special use)	B355		QQ-W-343	J461, J463	Copper, ETP Refinery Shapes, i.e., Ingots							
B716	B716	WW-P-377		Copper Welded Water Tube	B355		QQ-W-343	J461, J463	Copper, Concentric-Lay-Stranded Conductors, Hard, Medium-Hard, Soft							
		WW-P-377		Copper Welded Water Tube	B355		QQ-W-343	J461, J463	Copper, Tinned Soft Wire for Electrical							

*Specifications provided for reference only, not necessarily certified by Copper and Brass Sales. Check with your sales representative to confirm the specifications for your order.

One Call Gets It All!
(800) 926-2600

Not For Design Purposes

Specification Cross Reference*

ALLOY	AMS	ASTM	FED	SAE	FORM	ALLOY	AMS	ASTM	FED	SAE	FORM		
C113 cont.	B47			J461, J463	Copper, Trolley Wire	C115 cont.	B246	QQ-W-343	J461, J463	J461, J463	Copper, Tinned Hard Drawn Wire for Electrical		
	B48	QQ-W-343		J461, J463	Copper, Rect. and Sq. Soft Bare Wire for Electrical		B272	QQ-C-502	J461, J463	J461, J463	Copper, Flat Wire, Strip with Rolled or Drawn Edges		
	B152	QQ-C-576		J461, J463	Copper, SHT, PLT, Strip, and Rolled Bar		B355			J461, J463	J461, J463	Copper, Nickel Coated Soft Wire	
	B187	QQ-C-502		J461, J463	Copper, Bus Bar, Rod, Shape		B442			J461, J463	J461, J463	Copper, Tough-Pitch Chem. Refined-Refinery Shapes	
	B188			J461, J463	Copper, Seamless Bus Pipe and Tube		B623			J461, J463	J461, J463	Copper, Tough-Pitch Fire-Refined Hi-Cond., Ingots, Billets, Cakes, Slabs	
	B246	QQ-W-343		J461, J463	Copper, Tinned Hard Drawn and Medium-Hard Drawn Wire for Electrical		QQ-B-575	J461, J463	J461, J463	J461, J463	J461, J463	Copper, Braided Wire	
	B272	QQ-C-502		J461, J463	Copper, Flat Wire, Strip with Rolled or Drawn Edges		QQ-B-650	J461, J463	J461, J463	J461, J463	J461, J463	Copper, Brazing Alloy	
	B355			J461, J463	Copper, Nickel Coated Soft Wire		QQ-W-343	J461, J463	J461, J463	J461, J463	J461, J463	Copper, Non-Insulated Electrical Wire	
	B442			J461, J463	Copper, Tough-Pitch Chem. Refined-Refinery Shapes					J461, J463	J461, J463	Wrought Copper	
	B623			J461, J463	Copper, Tough-Pitch Fire-Refined Hi-Cond., Ingots, Billets, Cakes, Slabs		C116 (STP)	B1	QQ-W-343	J461, J463	J461, J463	J461, J463	Copper, Hard Drawn Wire
	QQ-B-575	J461, J463		J461, J463	Copper, Braided Wire		B2	QQ-W-343	J461, J463	J461, J463	J461, J463	Copper, Medium-Hard Drawn Wire	
	QQ-B-650	J461, J463		J461, J463	Copper, Brazing Alloy		B3	QQ-W-343	J461, J463	J461, J463	J461, J463	Copper, Soft Wire	
	QQ-C-502	J461, J463		J461, J463	Copper, Rod, Shape, Flat Bar, Wire, Strip-Finished Edge		B5			J461, J463	J461, J463	Copper, ETP Refinery Shapes, i.e., Ingots	
	QQ-C-576	J461, J463		J461, J463	Copper, SHT, PLT, Strip, Bar, Sawed, Shr, Slit and Slit Edge Rolled		B8			J461, J463	J461, J463	Copper, Concentric-Lay-Stranded Conductors, Hard, Medium-Hard, Soft	
	QQ-W-343	J461, J463		J461, J463	Copper, Non-Insulated Electrical Wire		B33	QQ-W-343	J461, J463	J461, J463	J461, J463	Copper, Tinned Soft Wire for Electrical	
		J461, J463		J461, J463	Wrought Copper		B47			J461, J463	J461, J463	Copper, Trolley Wire	
					B48	QQ-W-343	J461, J463	J461, J463	J461, J463	J461, J463	Copper, Rect. and Sq. Soft Bare Wire for Electrical		
C114 (STP)	B1	QQ-W-343		J461, J463	Copper, Hard Drawn Wire	B187	QQ-C-502	J461, J463	J461, J463	J461, J463	Copper, Bus Bar, Rod, Shape		
	B2	QQ-W-343		J461, J463	Copper, Medium-Hard Drawn Wire	B188			J461, J463	J461, J463	Copper, Seamless Bus Pipe and Tube		
	B3	QQ-W-343		J461, J463	Copper, Soft Wire	B246	QQ-W-343	J461, J463	J461, J463	J461, J463	Copper, Tinned Hard Drawn and Medium-Hard Drawn Wire for Electrical		
	B5			J461, J463	Copper, ETP Refinery Shapes, i.e., Ingots	B272	QQ-C-502	J461, J463	J461, J463	J461, J463	Copper, Flat Wire, Strip with Rolled or Drawn Edges		
	B8			J461, J463	Copper, Concentric-Lay-Stranded Conductors, Hard, Medium-Hard, Soft	B355			J461, J463	J461, J463	Copper, Nickel Coated Soft Wire		
	B33	QQ-W-343		J461, J463	Copper, Tinned Soft Wire for Electrical	B442			J461, J463	J461, J463	Copper, Tough-Pitch Chem. Refined-Refinery Shapes		
	B47			J461, J463	Copper, Trolley Wire	B623			J461, J463	J461, J463	Copper, Tough-Pitch Fire-Refined Hi-Cond., Ingots, Billets, Cakes, Slabs		
	B48	QQ-W-343		J461, J463	Copper, Rect. and Sq. Soft Bare Wire for Electrical	QQ-B-575	J461, J463	J461, J463	J461, J463	J461, J463	Copper, Braided Wire		
	B152	QQ-C-576		J461, J463	Copper, SHT, PLT, Strip, and Rolled Bar	QQ-B-650	J461, J463	J461, J463	J461, J463	J461, J463	Copper, Brazing Alloy		
	B187	QQ-C-502		J461, J463	Copper, Bus Bar, Rod, Shape	QQ-C-502	J461, J463	J461, J463	J461, J463	J461, J463	Copper, Rod, Shape, Flat Bar, Wire, Strip-Finished Edge		
	B188			J461, J463	Copper, Seamless Bus Pipe and Tube	QQ-C-576	J461, J463	J461, J463	J461, J463	J461, J463	Copper, SHT, PLT, Strip, Bar, Sawed, Shr, Slit and Slit Edge Rolled		
	B246	QQ-W-343		J461, J463	Copper, Tinned Hard Drawn and Medium-Hard Drawn Wire for Electrical	QQ-W-343	J461, J463	J461, J463	J461, J463	J461, J463	Copper, Non-Insulated Electrical Wire		
	B272	QQ-C-502		J461, J463	Copper, Flat Wire, Strip with Rolled or Drawn Edges				J461, J463	J461, J463	Wrought Copper		
	B355			J461, J463	Copper, Nickel Coated Soft Wire	C120 (DLP)	B5			J461, J463	Copper, ETP Refinery Shapes, i.e., Ingots		
	B442			J461, J463	Copper, Tough-Pitch Chem. Refined-Refinery Shapes	B42	WW-P-377	J461, J463	J461, J463	J461, J463	Copper, Seamless Pipe		
	B623			J461, J463	Copper, Tough-Pitch Fire-Refined Hi-Cond., Ingots, Billets, Cakes, Slabs	B48			J461, J463	J461, J463	Copper, Rect. and Sq., Soft Bare Wire for Electrical		
	QQ-B-575	J461, J463		J461, J463	Copper, Braided Wire	B68			J461, J463	J461, J463	Copper, Seamless Tube, Bright Annealed		
	QQ-B-650	J461, J463		J461, J463	Copper, Brazing Alloy	B75			J461, J463	J461, J463	Copper, Seamless Tube, Drawn and Soft Temper		
	QQ-C-502	J461, J463		J461, J463	Copper, Rod, Shape, Flat Bar, Wire, Strip-Finished Edge	B88	WW-T-799	J461, J463	J461, J463	J461, J463	Copper, Seamless Water Tube		
	QQ-C-576	J461, J463		J461, J463	Copper, SHT, PLT, Strip, Bar, Sawed, Shr, Slit and Slit Edge Rolled	B111			J461, J463	J461, J463	Copper, Seamless Cond. Tube and Ferrule Stock		
	QQ-W-343	J461, J463		J461, J463	Copper, Non-Insulated Electrical Wire	B133	QQ-C-502	J461, J463	J461, J463	J461, J463	Copper, Rod, Bar, Shape		
		J461, J463		J461, J463	Wrought Copper	B152	QQ-C-576	J461, J463	J461, J463	J461, J463	Copper, SHT, PLT, Strip, and Rolled Bar		
C115 (STP)	B1	QQ-W-343		J461, J463	Copper, Hard Drawn Wire	B187	QQ-C-502	J461, J463	J461, J463	J461, J463	Copper, Bus Bar, Rod, Shape		
	B2	QQ-W-343		J461, J463	Copper, Medium-Hard Drawn Wire	B188			J461, J463	J461, J463	Copper, Seamless Bus Pipe and Tube		
	B3	QQ-W-343		J461, J463	Copper, Soft Wire	B272	QQ-C-502	J461, J463	J461, J463	J461, J463	Copper, Flat Wire, Strip with Rolled or Drawn Edges		
	B5			J461, J463	Copper, ETP Refinery Shapes, i.e., Ingots	B280			J461, J463	J461, J463	Copper, Seamless Tube for Air-Cond. and Refrig. Field Service		
	B8			J461, J463	Copper, Concentric-Lay-Stranded Conductors, Hard, Medium-Hard, Soft	B302	WW-P-377	J461, J463	J461, J463	J461, J463	Copper, Threadless Pipe		
	B33	QQ-W-343		J461, J463	Copper, Tinned Soft Wire for Electrical	B306			J461, J463	J461, J463	Copper, Drainage Tube (DWW)		
	B47			J461, J463	Copper, Trolley Wire	B359			J461, J463	J461, J463	Copper, Seamless Tube for Cond. and Heat Exchanger with Integral Fins		
	B48	QQ-W-343		J461, J463	Copper, Rect. and Sq. Soft Bare Wire for Electrical	B372			J461, J463	J461, J463	Copper, Seamless Rect. Waveguide Tube		



Specification Cross Reference*

ALLOY	AMS	ASTM	FED	SAE	FORM	ALLOY	AMS	ASTM	FED	SAE	FORM				
C120 cont.	B395			J461, J463	Copper, U-Bend Seamless Heat Exchanger and Cond. Tube	C122 cont.			QQ-B-650	J461, J463	Copper, Brazing Alloy				
				J461, J463	Copper, Tough-Pitch Chem. Refined-Refinery Shapes				QQ-C-502	J461, J463	Copper, Rod, Shape, Flat Bar, Wire, Strip-Finished Edges				
	B442		J461, J463	Copper, Welded Tube	QQ-C-576				J461, J463	Copper, SHT, PLT, Strip, Bar, Sawed, Shr, Slit and Slit Edge Rolled					
	B447		J461, J463	Copper, Tough-Pitch Fire-Refined Hi-Cond. Ingots, Billets, Cakes, Slabs	WW-P-377				J461, J463	Copper, Pipe, Regular and Extra-Strong					
	B623		J461, J463	Copper, Welded Tube for Air-Cond. and Refrig. Service	WW-T-799				J461, J463	Copper, Water Tube Wrought Copper					
	B640		J461, J463	Copper, Seamless and Welded Distribution Tube (Type D)											
	B641		J461, J463	Copper, Seamless Water Tube (special uses)	C123 (DHP)				B5		Copper, ETP Refinery Shapes, i.e., Ingots				
	B707		J461, J463	Copper, Braided Wire	B48						Copper, Rect. and Sq. Soft Bare Wire for Electrical				
	B716		J461, J463	Copper, Welded Water Tube	B152				QQ-C-576		Copper, SHT, PLT, Strip, and Rolled Bar				
	QQ-B-575	J461, J463		Copper, Braided Wire	B442						Copper, Tough-Pitch Chem. Refined-Refinery Shapes				
	QQ-B-650	J461, J463		Copper, Brazing Alloy	B623						Copper, Tough-Pitch Fire-Refined Hi-Cond. Ingots, Billets, Cakes, Slabs				
	QQ-C-502	J461, J463		Copper, Rod, Shape, Flat Bar, Wire, Strip-Finished Edges							Copper, Brazing Alloy				
	QQ-C-576	J461, J463		Copper, SHT, PLT, Strip, Bar, Sawed, Shr, Slit and Slit Edge Rolled					QQ-B-650		Copper, Rod, Shape, Flat Bar, Wire, Strip-Finished Edges				
	WW-P-377	J461, J463		Copper, Pipe, Regular and Extra-Strong					QQ-C-502		Copper, SHT, PLT, Strip, Bar, Sawed, Shr, Slit and Slit Edge Rolled				
WW-T-799	J461, J463		Copper, Water Tube Wrought Copper		QQ-C-576		Copper, SHT, PLT, Strip, Bar, Sawed, Shr, Slit and Slit Edge Rolled								
C121 (DLP)	B133	QQ-C-502	QQ-B-650	QQ-C-502	Copper, Rod, Bar, Shape	C125 (FRTP)	B133	B152	QQ-C-502		Copper, Rod, Bar, Shape				
					Copper, Brazing Alloy				QQ-C-576		Copper, SHT, PLT, Strip, and Rolled Bar				
					Copper, Rod, Shape, Flat Bar, Wire, Strip-Finished Edges				B272	QQ-C-502	Copper, Flat Wire, Strip with Rolled or Drawn Edges				
			QQ-C-576		Copper, SHT, Strip for Building Construction		B370	QQ-C-576		Copper, SHT, Strip for Building Construction					
			QQ-C-576		Copper, Rod, Shape, Flat Bar, Wire, Strip-Finished Edges			QQ-C-502		Copper, Rod, Shape, Flat Bar, Wire, Strip-Finished Edges					
			QQ-C-576		Copper, SHT, PLT, Strip, Bar, Sawed, Shr, Slit and Slit Edge Rolled			QQ-C-576		Copper, SHT, PLT, Strip, Bar, Sawed, Shr, Slit and Slit Edge Rolled					
C122 (DHP)	B5			J461, J463	Copper, ETP Refinery Shapes, i.e., Ingots	C127 (FRSTP)	B272		QQ-C-502		Copper, Flat Wire, Strip with Rolled or Drawn Edges				
	B42	WW-P-377		J461, J463	Copper, Seamless Pipe				QQ-C-502		Copper, Rod, Shape, Flat Bar, Wire, Strip-Finished Edges				
	B48			J461, J463	Copper, Rect. and Sq., Soft Bare Wire for Electrical						QQ-C-576		Copper, SHT, PLT, Strip, Bar, Sawed, Shr, Slit and Slit Edge Rolled		
	B68			J461, J463	Copper, Seamless Tube, Bright Annealed								Copper, Flat Wire, Strip with Rolled or Drawn Edges		
	B75			J461, J463	Copper, Seamless Tube, Drawn and Soft Temper								Copper, Rod, Shape, Flat Bar, Wire, Strip-Finished Edges		
	B88	WW-P-799		J461, J463	Copper, Seamless Water Tube								Copper, SHT, PLT, Strip, Bar, Sawed, Shr, Slit and Slit Edge Rolled		
	B111			J461, J463	Copper, Seamless Cond. Tube and Ferrule Stock				C128 (FRSTP)	B272		QQ-C-502		Copper, Flat Wire, Strip with Rolled or Drawn Edges	
	B133	QQ-C-502		J461, J463	Copper, Rod, Bar, Shape							QQ-C-502		Copper, Rod, Shape, Flat Bar, Wire, Strip-Finished Edges	
	B152	QQ-C-576		J461, J463	Copper, SHT, PLT, Strip, and Rolled Bar							QQ-C-576		Copper, SHT, PLT, Strip, Bar, Sawed, Shr, Slit and Slit Edge Rolled	
	B272	QQ-C-502		J461, J463	Copper, Flat Wire, Strip with Rolled or Drawn Edges				C130 (FRSTP)	B272		QQ-C-502		Copper, Flat Wire, Strip with Rolled or Drawn Edges	
	B280			J461, J463	Copper, Seamless Tube for Air-Cond. and Refrig. Field Service							QQ-C-502		Copper, Rod, Shape, Flat Bar, Wire, Strip-Finished Edges	
	B302	WW-P-377		J461, J463	Copper, Threadless Pipe							QQ-C-576		Copper, SHT, PLT, Strip, Bar, Sawed, Shr, Slit and Slit Edge Rolled	
	B306			J461, J463	Copper, Drainage Tube (DWW)				C142 (DPA)	B5				Copper, ETP Refinery Shapes, i.e., Ingot	
	B359			J461, J463	Copper, Seamless Tube for Cond. and Heat Exchanger with Integral Fins							B48			Copper, Rect. and Sq. Soft Bare Wire for Electrical
	B360			J461, J463	Copper, Hard Drawn Capillary Tube for Restrictor Applications							B75			Copper, Seamless Tube, Soft, Drawn Temper
	B370	QQ-C-576		J461, J463	Copper, SHT, Strip, for Building Construction							B111			Copper, Seamless Cond. Tube and Ferrule Stock
	B395			J461, J463	Copper, U-Bend Seamless Heat Exchanger and Cond. Tube							B133			Copper, Rod, Bar, Shape
	B442			J461, J463	Copper, Tough-Pitch Chem. Refined-Refinery Shapes							B152	QQ-C-576		Copper, SHT, PLT, Strip, and Rolled Bar
	B447			J461, J463	Copper, Welded Tube							B359			Copper, Seamless Tube for Cond. and Heat-Exchangers with Integral Fins
	B543			J461, J463	Copper, Welded Heat-Exchanger Tube							B395			Copper, U-Bend Seamless Heat-Exchanger and Cond. Tube
	B623			J461, J463	Copper, Tough-Pitch Fire-Refined Hi-Cond. Ingots, Billets, Cakes, Slabs							B442			Copper, Tough-Pitch, Chem. Refined-Refinery Shapes
	B640			J461, J463	Copper, Welded Tube for Air-Cond. and Refrig. Service							B447			Copper, Welded Tube
	B641			J461, J463	Copper, Seamless and Welded Distribution Tube (Type D)										
	B707			J461, J463	Copper, Seamless Water Tube (special uses)										
	B716			J461, J463	Copper, Welded Water Tube										
	QQ-B-575	J461, J463		J461, J463	Copper, Braided Wire										

*Specifications provided for reference only, not necessarily certified by Copper and Brass Sales. Check with your sales representative to confirm the specifications for your order.

One Call Gets It All!
(800) 926-2600

Not For Design Purposes

Specification Cross Reference*

ALLOY	AMS	ASTM	FED	SAE	FORM	ALLOY	AMS	ASTM	FED	SAE	FORM
C260 cont.	B135 B569		WW-T-791	J461, J463	Copper Alloy, Seamless Tube	C350 (Medium Leaded Brass 62%)	B121 B453	QQ-B-613	QQ-B-613	J461, J463	Copper Alloy, Leaded SHT, PLT, Strip, and Rolled Bar
				J461, J463	Copper Alloy, Strip in Narrow Width and Light Gage for Heat-Exchanger Tube					J461, J463	Copper Alloy, Leaded Rod Copper Alloy, Leaded SHT, PLT, Strip, Bar
	B587	QQ-B-613	J461, J463	Copper Alloy, Welded Tube	J461, J463	Copper Alloy, Leaded Rod, Bar, Shape, Forging, Finished Edge Strip Wrought Copper Alloy					
			J461, J463	Copper Alloy, Non-Leaded SHT, PLT, Strip, Bar	J461, J463	Copper Alloy, Leaded Rod, Bar, Shape, Forging, Finished Edge Strip Wrought Copper Alloy					
C268 (Yellow Brass 66%)	B36	QQ-B-613	J461, J463	J461, J463	Copper Alloy, SHT, PLT, Strip, and Rolled Bar	C353 (Hard Leaded Brass 62%)	B121 B453	QQ-B-613	QQ-B-613	J461, J463	Copper Alloy, Leaded SHT, PLT, Strip, and Rolled Bar Copper Alloy, Leaded Rod Copper Alloy, Leaded SHT, PLT, Strip, Bar
				J461, J463	Copper Alloy, Welded Tube					J461, J463	Copper Alloy, Leaded SHT, PLT, Strip, Bar
	B587	QQ-B-613	J461, J463	Copper Alloy, Non-Leaded SHT, PLT, Strip, Bar	J461, J463	Copper Alloy, Leaded Rod Copper Alloy, Leaded Rod Copper Alloy, Leaded SHT, PLT, Strip, Bar					
			J461, J463	Copper Alloy, Non-Leaded Rod, Bar, Shape, Forging, Finished Edge Strip Wrought Copper Alloy	J461, J463	Copper Alloy, Leaded Rod Copper Alloy, Leaded SHT, PLT, Strip, Bar					
C270 (Yellow Brass 65%)	4710D	B134	QQ-W-321	J461, J463	Copper Alloy, Wire	C360 (Free Cutting Brass)	4610K B16	B16	QQ-B-613	J461, J463	Copper Alloy, Rod and Bar Copper Alloy, Rod, Bar, Shape for Use in Screw Machines
	4712C	B134	QQ-W-321	J461, J463	Copper Alloy, Wire					J461, J463	Copper Alloy, Leaded SHT, PLT, Strip, and Rolled Bar
	4713C	B134	QQ-W-321	J461, J463	Copper Alloy, Wire					J461, J463	Copper Alloy, Leaded Rod, Bar, Shape, Forging, Finished Edge Strip Wrought Copper Alloy
		B134	QQ-W-321	J461, J463	Copper Alloy, Wire					J461, J463	Copper Alloy, Leaded Rod, Bar, Shape, Forging, Finished Edge Strip Wrought Copper Alloy
		B135 B587	QQ-B-613	J461, J463	Copper Alloy, Seamless Tube Copper Alloy, Welded Tube					J461, J463	Copper Alloy, Leaded Rod, Bar, Shape, Forging, Finished Edge Strip Wrought Copper Alloy
			QQ-B-613	J461, J463	Copper Alloy, Non-Leaded SHT, PLT, Strip, Bar					J461, J463	Copper Alloy, Leaded Rod, Bar, Shape, Forging, Finished Edge Strip Wrought Copper Alloy
C272	B36	QQ-B-613	J461, J463	J461, J463	Copper Alloy, SHT, PLT, Strip, and Rolled Bar	C365 (Leaded Muntz Metal Uninhibited)	B171 B283			J461, J463	Copper Alloy, Condenser Tube Plate
				J461, J463	Copper Alloy, Seamless Tube					J461, J463	Copper Alloy, Die Forging (Hot Pressed)
	B135 B587	QQ-B-613	J461, J463	Copper Alloy, Welded Tube Copper Alloy, Non-Leaded SHT, PLT, Strip, Bar	J461, J463					Copper Alloy, Condenser Tube Plate	
C274 (Yellow Brass 63%)	B134	QQ-W-321 QQ-B-613	J461, J463	J461, J463	Copper Alloy, Wire	C366 (Leaded Muntz Metal Arsenical)	B171			J461, J463	Copper Alloy, Condenser Tube Plate
				J461, J463	Copper Alloy, Non-Leaded SHT, PLT, Strip, Bar					J461, J463	Copper Alloy, Condenser Tube Plate
C280 (Muntz Metal 60%)	B111 B135	WW-T-791 QQ-B-613	J461, J463	J461, J463	Copper Alloy, Seamless Cond. Tube and Ferrule Stock	C367 (Leaded Muntz Metal Antimonial)	B171			J461, J463	Copper Alloy, Condenser Tube Plate
				J461, J463	Copper Alloy, Seamless Tube Copper Alloy, Non-Leaded SHT, PLT, Strip, Bar					J461, J463	Copper Alloy, Condenser Tube Plate
C314 (Leaded Comm. Bronze)	B140				Copper Alloy, Rod, Bar, Shape	C368 (Leaded Muntz Metal Phosphorized)	B171				Copper Alloy, Condenser Tube Plate
C316 (Leaded Comm. Bronze)	B140				Copper Alloy, Rod, Bar, Shape						
C320 (Leaded Red Brass)	B140				Copper Alloy, Rod, Bar, Shape	C370 (Free Cutting Muntz Metal)	B135	QQ-B-613			Copper Alloy, Seamless Tube Copper Alloy, Leaded SHT, PLT, Strip, and Rolled Bar
C330 (Low Leaded Brass)	B135 B135	WW-T-791 WW-T-791	J461, J463 J461, J463	J461, J463	Copper Alloy, Seamless Tube Copper Alloy, Seamless Tube Wrought Copper Alloy						
C332 (High Leaded Brass)	B135 B135		J461, J463	J461, J463	Copper Alloy, Seamless Tube	C377 (Forging Brass)	4614F B124	B124		J461, J463	Copper Alloy, Free Cutting Forging
				J461, J463	Copper Alloy, Seamless Tube					J461, J463	Copper Alloy, Forging Rod, Bar and Shape
C335 (Low Leaded Brass)	B121 B453	QQ-B-613	J461, J463	J461, J463	Copper Alloy, Leaded SHT, PLT, Strip, and Rolled Bar	C405 (Tin Brass)	B591			J461, J463	Copper Alloy, SHT, PLT, Strip, and Rolled Bar
				J461, J463	Copper Alloy, Leaded Rod Copper Alloy, Leaded SHT, PLT, Strip, Bar					J461, J463	Copper Alloy, SHT, PLT, Strip, and Rolled Bar
C340 (Medium Leaded Brass 64-1/2%)	B121 B453	QQ-B-613	J461, J463	J461, J463	Copper Alloy, Leaded SHT, PLT, Strip, and Rolled Bar	C408 (Tin Brass)	B591			J461, J463	Copper Alloy, SHT, PLT, Strip, and Rolled Bar
				J461, J463	Copper Alloy, Leaded Rod Copper Alloy, Leaded SHT, PLT, Strip, Bar					J461, J463	Copper Alloy, SHT, PLT, Strip, and Rolled Bar
C342 (High Leaded Brass 64-1/2%)	B121	QQ-B-613	J461, J463	J461, J463	Copper Alloy, Leaded SHT, PLT, Strip, and Rolled Bar	C411 (Tin Brass)	B105			J461, J463	Copper Alloy, Hard-Drawn Wire for Electrical Conductors
				J461, J463	Copper Alloy, Leaded Rod, Bar, Shape, Forging, Finished Edge Strip Wrought Copper Alloy					J461, J463	Copper Alloy, SHT, PLT, Strip, and Rolled Bar
				J461, J463	Copper Alloy, Leaded Rod, Bar, Shape, Forging, Finished Edge Strip Wrought Copper Alloy					J461, J463	Copper Alloy, SHT, PLT, Strip, and Rolled Bar
C345	B453		J461, J463	J461, J463	Copper Alloy, Leaded Rod Copper Alloy, Leaded Rod, Bar, Shape, Forging, Finished Edge Strip Wrought Copper Alloy	C413 (Tin Brass)	B591			J461, J463	Copper Alloy, SHT, PLT, Strip, and Rolled Bar
				J461, J463	Copper Alloy, Leaded Rod, Bar, Shape, Forging, Finished Edge Strip Wrought Copper Alloy					J461, J463	Copper Alloy, SHT, PLT, Strip, and Rolled Bar
				J461, J463	Copper Alloy, Leaded Rod, Bar, Shape, Forging, Finished Edge Strip Wrought Copper Alloy	C415 (Tin Brass)	B591			J461, J463	Copper Alloy, SHT, PLT, Strip, and Rolled Bar
				J461, J463	Copper Alloy, Leaded Rod, Bar, Shape, Forging, Finished Edge Strip Wrought Copper Alloy					J461, J463	Copper Alloy, SHT, PLT, Strip, and Rolled Bar
				J461, J463	Copper Alloy, Leaded Rod, Bar, Shape, Forging, Finished Edge Strip Wrought Copper Alloy	C422 (Tin Brass)	B591			J461, J463	Copper Alloy, SHT, PLT, Strip, and Rolled Bar
				J461, J463	Copper Alloy, Leaded Rod, Bar, Shape, Forging, Finished Edge Strip Wrought Copper Alloy					J461, J463	Copper Alloy, SHT, PLT, Strip, and Rolled Bar
				J461, J463	Copper Alloy, Leaded Rod, Bar, Shape, Forging, Finished Edge Strip Wrought Copper Alloy	C425 (Tin Brass)	B591			J461, J463	Copper Alloy, SHT, PLT, Strip, and Rolled Bar
				J461, J463	Copper Alloy, Leaded Rod, Bar, Shape, Forging, Finished Edge Strip Wrought Copper Alloy					J461, J463	Copper Alloy, SHT, PLT, Strip, and Rolled Bar
				J461, J463	Copper Alloy, Leaded Rod, Bar, Shape, Forging, Finished Edge Strip Wrought Copper Alloy	C430 (Tin Brass)	B591			J461, J463	Copper Alloy, SHT, PLT, Strip, and Rolled Bar
				J461, J463	Copper Alloy, Leaded Rod, Bar, Shape, Forging, Finished Edge Strip Wrought Copper Alloy					J461, J463	Copper Alloy, SHT, PLT, Strip, and Rolled Bar
				J461, J463	Copper Alloy, Leaded Rod, Bar, Shape, Forging, Finished Edge Strip Wrought Copper Alloy	C434 (Tin Brass)	B591			J461, J463	Copper Alloy, SHT, PLT, Strip, and Rolled Bar
				J461, J463	Copper Alloy, Leaded Rod, Bar, Shape, Forging, Finished Edge Strip Wrought Copper Alloy					J461, J463	Copper Alloy, SHT, PLT, Strip, and Rolled Bar

*Specifications provided for reference only, not necessarily certified by Copper and Brass Sales. Check with your sales representative to confirm the specifications for your order.

One Call Gets It All!
(800) 926-2600

Not For Design Purposes

Specification Cross Reference*

ALLOY	AMS	ASTM	FED	SAE	FORM	ALLOY	AMS	ASTM	FED	SAE	FORM	
C443 (Admiralty, Arsenical)		B111			Copper Alloy, Seamless Cond. Tube and Ferrule Stock	C482 (Naval Brass Medium Leaded)		B21	QQ-B-637		Copper Alloy, Rod, Bar, Shape	
		B171			Copper Alloy, Condenser Tube Plate			B124				Copper Alloy, Forging Rod, Bar, and Shapes
		B359			Copper Alloy, Seamless Tube for Cond. and Heat- Exchanger with Integral Fins			B283				Copper Alloy, Die Forging (Hot Pressed)
		B395			Copper Alloy, U-Bend Seamless Heat-Exchanger and Cond. Tube				QQ-B-637			Copper Alloy, RBW, Shape, Forging, Finished Edge Strip
		B543			Copper Alloy, Welded Heat- Exchanger Tube				QQ-B-639			Copper Alloy, SHT, PLT, Strip, and Bar
C444 (Admiralty, Antimonial)		B111			Copper Alloy, Seamless Cond. Tube and Ferrule Stock	C485 (Naval Brass High Leaded)		B21	QQ-B-637		Copper Alloy, Rod, Bar, Shape	
		B171			Copper Alloy, Condenser Tube Plate			B124				Copper Alloy, Forging Rod, Bar, and Shapes
		B359			Copper Alloy, Seamless Tube for Cond. and Heat- Exchanger with Integral Fins			B283				Copper Alloy, Die Forging (Hot Pressed)
		B395			Copper Alloy, U-Bend Seamless Heat-Exchanger and Cond. Tube				QQ-B-637			Copper Alloy, RBW, Shape, Forging, Finished Edge Strip
		B543			Copper Alloy, Welded Heat- Exchanger Tube				QQ-B-639			Copper Alloy, SHT, PLT, Strip, and Bar
C445 (Admiralty, Phosphorized)		B111			Copper Alloy, Seamless Cond. Tube and Ferrule Stock	C502 (Phos. Bronze)		B105			Copper Alloy, Hard Drawn Wire for Electrical Conductors	
		B171			Copper Alloy, Condenser Tube Plate			B105				Copper Alloy, Hard Drawn Wire for Electrical Conductors
		B359			Copper Alloy, Seamless Tube for Cond. and Heat- Exchanger with Integral Fins			B105				Copper Alloy, Hard Drawn Wire for Electrical Conductors
		B395			Copper Alloy, U-Bend Seamless Heat-Exchanger and Cond. Tube			B105				Copper Alloy, Hard Drawn Wire for Electrical Conductors
		B543			Copper Alloy, Welded Heat- Exchanger Tube			B105				Copper Alloy, Hard Drawn Wire for Electrical Conductors
C462 (Naval Brass)		B21	QQ-B-637		Copper Alloy, Rod, Bar, Shape	C510 (Phos. Bronze) (Grade A)	4510D	B103	QQ-B-750	J461, J463	Copper Alloy, SHT, PLT, Strip	
			QQ-B-637		Copper Alloy, Non-Leaded Rod, Bar, Shape, Forging, Finished Edge Strip		4625E	B139	QQ-B-750	J461, J463	Copper Alloy, Rod, Bar, Tube	
			QQ-B-639		Copper Alloy, RBW, Shape, Forging, Finished Edge Strip		4720C	B159	QQ-W-321	J461, J463	Copper Alloy, Wire	
					Copper Alloy, SHT, PLT, Strip, and Bar		B100	B100	QQ-B-750	J461, J463	Copper Alloy, Rolled Bearing and Expansion PLT, SHT, for Bridge and Other Structural Uses	
							B103	B103	QQ-B-750	J461, J463	Copper Alloy, SHT, PLT, Strip, and Rolled Bar	
C464 (Naval Brass Uninhibited)	4611E	B21	QQ-B-637	J461, J463	Copper Alloy, Rod and Bar	C511 (Phos. Bronze)		B100		J461, J463	Copper Alloy, Rolled Bearing and Expansion PLT, SHT, for Bridge and Other Structural Uses	
	4612F	B21	QQ-B-637	J461, J463	Copper Alloy, Rod and Bar			B103		J461, J463	Copper Alloy, SHT, PLT, Strip	
		B21	QQ-B-637	J461, J463	Copper Alloy, Forging Rod, Bar, and Shape					J461, J463	Wrought Copper Alloy	
		B124			Copper Alloy, Condenser Tube Plate					J461, J463	Wrought Copper Alloy	
		B171			J461, J463					J461, J463	Wrought Copper Alloy	
C465 (Naval Brass Arsenical)		B21	QQ-B-637	J461, J463	Copper Alloy, Rod, Bar, Shape, Forging, Finished Edge Strip	C518 (Phos. Bronze)		B103	QQ-R-571		Copper Alloy, Welding Rod	
		B283			Copper Alloy, Die Forging (Hot Pressed)			B103		J461, J463	Copper Alloy, SHT, PLT, Strip	
			QQ-B-637	J461, J463	Copper Alloy, Non-Leaded Rod, Bar, Shape, Forging, Finished Edge Strip			B103		J461, J463	Copper Alloy, Rod, Bar, Shape	
			QQ-B-639	J461, J463	Copper Alloy, RBW, Shape, Forging, Finished Edge Strip			B159		J461, J463	Copper Alloy, Wire	
					J461, J463					J461, J463	Wrought Copper Alloy	
C466 (Naval Brass Antimonial)		B171		J461, J463	Copper Alloy, SHT, PLT, Strip, and Bar	C521 (Phos. Bronze) (Grade C) B139		B103		J461, J463	Copper Alloy, SHT, PLT, Strip	
			QQ-B-637	J461, J463	Copper Alloy, Condenser Tube Plate			B103		J461, J463	Copper Alloy, Rod, Bar, Shape	
			QQ-B-639	J461, J463	Copper Alloy, Non-Leaded Rod, Bar, Shape, Forging, Finished Edge Strip			B159		J461, J463	Copper Alloy, Wire	
					J461, J463					J461, J463	Copper Alloy, RBW, SHT, PLT, and Strip	
					J461, J463					J461, J463	Wrought Copper Alloy	
C467 (Naval Brass Phosphorized)		B171		J461, J463	Copper Alloy, Condenser Tube Plate	C524 (Phos. Bronze) (Grade D) B139		B103	QQ-B-750	J461, J463	Copper Alloy, SHT, PLT, Strip	
			QQ-B-650	J461, J463	Copper Alloy, Non-Leaded Rod, Bar, Shape, Forging, Finished Edge Strip			B103		J461, J463	Copper Alloy, Rod, Bar, Shape	
			QQ-R-571	J461, J463	Copper Alloy, Forging Rod, Bar, and Shape			B159		J461, J463	Copper Alloy, Wire	
					J461, J463					J461, J463	Copper Alloy, RBW, SHT, PLT, and Strip	
					J461, J463					J461, J463	Wrought Copper Alloy	
C470 (Naval Brass) Brass Alloy		B21			Copper Alloy, Brazing Alloy	C532 (Leaded Phos. Bronze)		B103			Copper Alloy, SHT, PLT, Strip	
					Copper Alloy, Welding Rod			B103				Copper Alloy, SHT, PLT, Strip
					Copper Alloy, Rod, Bar, Shape			B139				Copper Alloy, Rod, Bar, Shape
C470 (Naval Brass) Brass Alloy		B21			Copper Alloy, Brazing Alloy	C534 (Leaded Phos. Bronze)		B103			Copper Alloy, SHT, PLT, Strip	
					Copper Alloy, Welding Rod			B103				Copper Alloy, Rod, Bar, Shape
					Copper Alloy, Rod, Bar, Shape			B139				Copper Alloy, Rod, Bar, Shape
C470 (Naval Brass) Brass Alloy		B21			Copper Alloy, Brazing Alloy	C544 (Phos. Bronze B2)	4520F	B103	QQ-B-750	J461, J463	Copper Alloy, Strip	
					Copper Alloy, Welding Rod			B103	QQ-B-750	J461, J463	Copper Alloy, SHT, PLT, Strip	
					Copper Alloy, Rod, Bar, Shape			B139	QQ-B-750	J461, J463	Copper Alloy, Rod, Bar, Shape	
C470 (Naval Brass) Brass Alloy		B21			Copper Alloy, Brazing Alloy	C544 (Phos. Bronze B2)	4520F	B103	QQ-B-750	J461, J463	Copper Alloy, Strip	
					Copper Alloy, Welding Rod			B103	QQ-B-750	J461, J463	Copper Alloy, SHT, PLT, Strip	
					Copper Alloy, Rod, Bar, Shape			B139	QQ-B-750	J461, J463	Copper Alloy, Rod, Bar, Shape	
C470 (Naval Brass) Brass Alloy		B21			Copper Alloy, Brazing Alloy	C544 (Phos. Bronze B2)	4520F	B103	QQ-B-750	J461, J463	Copper Alloy, Strip	
					Copper Alloy, Welding Rod			B103	QQ-B-750	J461, J463	Copper Alloy, SHT, PLT, Strip	
					Copper Alloy, Rod, Bar, Shape			B139	QQ-B-750	J461, J463	Copper Alloy, Rod, Bar, Shape	



Specification Cross Reference*

ALLOY	AMS	ASTM	FED	SAE	FORM	ALLOY	AMS	ASTM	FED	SAE	FORM		
C606 (Al. Bronze)	B169		QQ-C-450	J461, J463	Copper Alloy, SHT, PLT, Strip, and Rolled Bar	C642 cont.			QQ-C-465	J461, J463	Copper Alloy, Rod, Bar, Flat Wire, Shape, and Forging Wrought Copper Alloy		
			QQ-C-465						QQ-C-591				
									QQ-C-591				
C607 (Al. Bronze)	B105				Copper Alloy, Hard Drawn Wire for Electrical Conductors	C647 (Silicon Bronze)	B411 B412 B422	QQ-C-591 QQ-C-591 QQ-C-591			Copper Alloy, Rod and Bar Copper Alloy, Wire Copper Alloy, SHT, Strip Copper Alloy, SHT, PLT, Strip, Bar, and Flat Wire		
C608 (Al. Bronze)	B111			J461, J463	Copper Alloy, Seamless Cond. Tube and Ferrule Stock	C651 (Low Silicon Bronze)	B96 B98 B99 B105	QQ-C-591	J461, J463	J461, J463	Copper Alloy, SHT, PLT, Strip Rolled Bar for General Purposes and Pressure Vessels Copper Alloy, Rod, Bar, Shape Copper Alloy, Wire Copper Alloy, Hard Drawn Wire for Electrical Conductors Copper Alloy, Seamless Pipe and Tube Copper Alloy, SHT, PLT, Strip, Bar, and Flat Wire		
	B359		J461, J463	Copper Alloy, Seamless Tube for Cond. and Heat-Exchanger with Integral Fins									
	B395		J461, J463	Copper Alloy, U-Bend Seamless Heat-Exchanger and Cond. Tube Wrought Copper Alloy									
C610 (Al. Bronze)	B169		QQ-C-450	J461, J463	Copper Alloy, SHT, PLT, Strip, and Rolled Bar	C655 (High Silicon Bronze)	4615E 4665A	B98 B315 B96	J461, J463 J461, J463 J461, J463	J461, J463	Copper Alloy, Rod and Bar Copper Alloy, Seamless Tube Copper Alloy, SHT, PLT, Strip Rolled Bar for General Purpose and Pressure Vessels Copper Alloy, Rod, Bar, Shape Copper Alloy, Wire Copper Alloy, Rolled Bearing and Expansion PLT, SHT, for Bridge and Other Struct. Uses Copper Alloy, Hard Drawn Wire for Electrical Conductors Copper Alloy, Forging Rod, Bar, and Shape Copper Alloy, Die Forging (Hot Pressed) Copper Alloy, Seamless Pipe and Tube Copper Alloy, SHT, PLT, Strip, Bar, and Flat Wire Wrought Copper Alloy		
			QQ-C-450									B96	QQ-C-591
C613 (Al. Bronze)	B111	B150 B169	QQ-C-450	J461, J463	Copper Alloy, Seamless Cond. Tube and Ferrule Stock	B98 B99 B100			J461, J463	J461, J463	Copper Alloy, Rod and Bar Copper Alloy, SHT, PLT, Strip, and Rolled Bar Copper Alloy, Condenser Tube Plate Copper Alloy, Seamless Pipe and Tube Copper Alloy, Welded Pipe Copper Alloy, SHT, PLT, Strip Wrought Copper Alloy		
				J461, J463	Copper Alloy, Rod, Bar, Shape								
				J461, J463	Copper Alloy, SHT, PLT, Strip, and Rolled Bar								
				J461, J463	Copper Alloy, Condenser Tube Plate								
				J461, J463	Copper Alloy, Seamless Pipe and Tube								
				J461, J463	Copper Alloy, Welded Pipe								
C614 (Al. Bronze)	B111	B150 B169	QQ-C-465 QQ-C-450	J461, J463	Copper Alloy, Seamless Cond. Tube and Ferrule Stock	B105 B124			J461, J463	J461, J463	Copper Alloy, Rod and Bar Copper Alloy, SHT, PLT, Strip, and Rolled Bar Copper Alloy, Condenser Tube Plate Copper Alloy, Seamless Pipe and Tube Copper Alloy, Welded Pipe Copper Alloy, SHT, PLT, Strip Copper Alloy, Rod, Bar, Flat Wire, Shape, and Forging Wrought Copper Alloy		
				J461, J463	Copper Alloy, Rod, Bar, Shape								
				J461, J463	Copper Alloy, SHT, PLT, Strip, and Rolled Bar								
				J461, J463	Copper Alloy, Condenser Tube Plate								
				J461, J463	Copper Alloy, Seamless Pipe and Tube								
				J461, J463	Copper Alloy, Welded Pipe								
C618 (Al. Bronze) C619 (Al. Bronze)	B124	B150 B283	QQ-R-571	J461, J463	Copper Alloy, Welding Rod	B283 B315			J461, J463	J461, J463	Copper Alloy, SHT, PLT, Strip, Bar, and Flat Wire Wrought Copper Alloy		
				J461, J463	Copper Alloy, Forging Rod, Bar, and Shape								
				J461, J463	Copper Alloy, Rod, Bar, Shape								
				J461, J463	Copper Alloy, Die Forging (Hot Pressed)								
				J461, J463	Copper Alloy, Welding Rod								
				J461, J463	Copper Alloy, Forging Rod, Bar, and Shape								
C622 (Al. Bronze)	B150		QQ-R-571	J461, J463	Copper Alloy, Rod, Bar, Forging	B98			J461, J463	J461, J463	Copper Alloy, Rod and Bar Copper Alloy, SHT, PLT, Strip, Bar, and Flat Wire		
												4635C	4635C (Waive Hardness)
												B124	Copper Alloy, Forging Rod, Bar, and Shape
C623 (Al. Bronze)	B150 B283		QQ-R-571	J461, J463	Copper Alloy, Rod, Bar, Shape	B291			J461, J463	J461, J463	Copper Alloy, SHT, and PLT		
				J461, J463	Copper Alloy, Rod, Bar, Shape								
				J461, J463	Copper Alloy, Die Forging (Hot Pressed)								
C624 (Al. Bronze)	B150		QQ-R-571	J461, J463	Copper Alloy, Welding Rod	B138 B283			J461, J463 J461, J463	J461, J463	Copper Alloy, Rod, Bar, Shape Copper Alloy, Rod, Bar, Shape, Forging, PLT, Strip, Flat Wire Wrought Copper Alloy		
				J461, J463	Copper Alloy, Forging Rod, Bar, and Shape								
				J461, J463	Copper Alloy, Rod, Bar, Shape								
C630 (Al. Bronze)	B150	B124	QQ-C-465	J461, J463	Copper Alloy, Rod, Bar, Forging	B283			J461, J463 J461, J463	J461, J463	Copper Alloy, Rod, Bar, Shape Copper Alloy, Die Forging (Hot Pressed) Copper Alloy, Rod, Bar, Shape, Forging, PLT, Strip, Flat Wire Wrought Copper Alloy		
				J461, J463	Copper Alloy, Forging Rod, Bar, and Shape								
				J461, J463	Copper Alloy, Rod, Bar, Shape								
				J461, J463	Copper Alloy, Condenser Tube Plate								
				J461, J463	Copper Alloy, Die Forging (Hot Pressed)								
				J461, J463	Copper Alloy, SHT, PLT, Strip								
C642 (Al. Bronze)	B124	B150 B283	QQ-C-465	J461, J463	Copper Alloy, Forging Rod, Bar, and Shape	B543			J461, J463	J461, J463	Copper Alloy, Rod, Bar, Shape, Forging, PLT, Strip, Flat Wire Wrought Copper Alloy		
				J461, J463	Copper Alloy, Rod, Bar, Shape								
				J461, J463	Copper Alloy, Die Forging (Hot Pressed)								
C642 (Al. Bronze)	B124	B150 B283	QQ-C-465	J461, J463	Copper Alloy, Forging Rod, Bar, and Shape	B592			J461, J463	J461, J463	Copper Alloy, SHT, PLT, Strip, and Rolled Bar		
				J461, J463	Copper Alloy, Rod, Bar, Shape								
				J461, J463	Copper Alloy, Die Forging (Hot Pressed)								
C642 (Al. Bronze)	B124	B150 B283	QQ-C-465	J461, J463	Copper Alloy, Forging Rod, Bar, and Shape	B706			J461, J463	J461, J463	Copper Alloy, Pipe and Tube		
				J461, J463	Copper Alloy, Rod, Bar, Shape								
				J461, J463	Copper Alloy, Die Forging (Hot Pressed)								
C642 (Al. Bronze)	B124	B150 B283	QQ-C-465	J461, J463	Copper Alloy, Forging Rod, Bar, and Shape	B371			J461, J463	J461, J463	Copper Alloy, Rod		
				J461, J463	Copper Alloy, Rod, Bar, Shape								
				J461, J463	Copper Alloy, Die Forging (Hot Pressed)								

*Specifications provided for reference only, not necessarily certified by Copper and Brass Sales. Check with your sales representative to confirm the specifications for your order.

One Call Gets It All!
(800) 926-2600

Not For Design Purposes

Specification Cross Reference*

ALLOY	AMS	ASTM	FED	SAE	FORM	ALLOY	AMS	ASTM	FED	SAE	FORM	
C697		B371			Copper Alloy, Rod	C735		B122	QQ-C-585		Copper Alloy, SHT, PLT, Strip, and Rolled Bar	
C704 (Copper-Nickel-5%)		B111			Copper Alloy, Seamless Cond. Tube and Ferrule Stock				QQ-C-585		Copper Alloy, SHT, PLT, Strip, and Bar	
		B359			Copper Alloy, Seamless Tube for Cond. and Heat-Exchanger with Integral Fins	C740		B122			Copper Alloy, SHT, PLT, Strip, and Rolled Bar	
		B395			Copper Alloy, U-Bend Seamless Heat Exchanger and Cond. Tube	C745		B122	QQ-C-585		Copper Alloy, SHT, PLT, Strip, and Rolled Bar	
		B466			Copper Alloy, Seamless Pipe and Tube			B151	QQ-C-586		Copper Alloy, Rod and Bar	
		B543			Copper Alloy, Welded Heat Exchanger Tube			B206	QQ-W-321		Copper Alloy, Wire	
									QQ-C-585		Copper Alloy, SHT, PLT, Strip, and Bar	
C706 (Copper-Nickel-10%)		B111		J461, J463	Copper Alloy, Seamless Cond. Tube and Ferrule Stock	C752		B122	QQ-C-585	J461, J463	Copper Alloy, SHT, PLT, Strip, and Rolled Bar	
		B122		J461, J463	Copper Alloy, SHT, PLT, Strip, and Rolled Bar			B151	QQ-C-586	J461, J463	Copper Alloy, Rod and Bar	
		B151		J461, J463	Copper Alloy, Rod and Bar			B206	QQ-W-321	J461, J463	Copper Alloy, Wire	
		B171		J461, J463	Copper Alloy, Condenser Tube PLT				QQ-C-585	J461, J463	Copper Alloy, SHT, PLT, Strip, and Bar	
		B359		J461, J463	Copper Alloy, Seamless Tube for Cond. and Heat-Exchanger with Integral Fins				QQ-C-586	J461, J463	Copper Alloy, Rod, Bar, Flat Wire, Strip with Finished Edge	
		B395		J461, J463	Copper Alloy, U-Bend Seamless Heat Exchanger and Cond. Tube					J461, J463	Wrought Copper Alloy	
		B402		J461, J463	Copper Alloy, SHT, PLT, for Pressure Vessels	C757		B151				Copper Alloy, Rod and Bar
		B466		J461, J463	Copper Alloy, Seamless Pipe and Tube			B206	QQ-W-321			Copper Alloy, Wire
		B467		J461, J463	Copper Alloy, Welded Pipe	C762		B122	QQ-C-585			Copper Alloy, SHT, PLT, Strip, and Rolled Bar
		B469		J461, J463	Copper Alloy, Seamless Tube for Pressure Application				QQ-C-585			Copper Alloy, SHT, PLT, Strip, and Bar
		B543		J461, J463	Copper Alloy, Welded Heat Exchanger Tube	C764		B151	QQ-C-586			Copper Alloy, Rod and Bar
		B552		J461, J463	Copper Alloy, Seamless, Welded Tube for Water Desalting Plants			B206	QQ-W-321			Copper Alloy, Wire
		B608		J461, J463	Copper Alloy, Welded Pipe				QQ-C-586			Copper Alloy, SHT, PLT, Strip, and Bar
				J461, J463	Wrought Copper Alloy	C766			QQ-C-585		Copper Alloy, SHT, PLT, Strip, and Bar	
C710 (Copper-Nickel-20%)		B111		J461, J463	Copper Alloy, Seamless Cond. Tube and Ferrule Stock	C770		B122	QQ-C-585	J461, J463	Copper Alloy, SHT, PLT, Strip, and Rolled Bar	
		B122		J461, J463	Copper Alloy, SHT, PLT, Strip, and Rolled Bar			B151	QQ-C-586	J461, J463	Copper Alloy, Rod and Bar	
		B206		J461, J463	Copper Alloy, Wire			B206	QQ-W-321	J461, J463	Copper Alloy, Wire	
		B359		J461, J463	Copper Alloy, Seamless Tube for Cond. and Heat-Exchanger with Integral Fins				QQ-C-585	J461, J463	Copper Alloy, SHT, PLT, Strip, and Bar	
		B395		J461, J463	Copper Alloy, U-Bend Seamless Heat Exchanger and Cond. Tube				QQ-C-586	J461, J463	Copper Alloy, Rod, Bar, Flat Wire, Strip with Finished Edge	
		B466		J461, J463	Copper Alloy, Seamless Pipe and Tube					J461, J463	Wrought Copper Alloy	
		B467		J461, J463	Copper Alloy, Welded Pipe	C773			QQ-B-650			Copper Alloy, Brazing Alloy
		B543		J461, J463	Copper Alloy, Welded Heat Exchanger Tube				QQ-R-571			Copper Alloy, Welding Rod
					J461, J463	Wrought Copper Alloy	C774		B124			Copper Alloy, Forging Rod Bar, and Shape
C715 (Copper-Nickel-30%)		B111		J461, J463	Copper Alloy, Seamless Cond. Tube and Ferrule Stock			B283			Copper Alloy, Die Forging (Hot Pressed)	
		B122		J461, J463	Copper Alloy, SHT, PLT, Strip, and Rolled Bar	C792		B151	QQ-C-586		Copper Alloy, Rod and Bar	
		B151		J461, J463	Copper Alloy, Rod and Bar			B206	QQ-C-586		Copper Alloy, Wire	
		B171		J461, J463	Copper Alloy, Condenser Tube PLT						Copper Alloy, Rod, Bar, Flat Wire, Strip with Finished Edge	
		B359		J461, J463	Copper Alloy, Seamless Tube for Cond. and Heat-Exchanger with Integral Fins	C820			QQ-C-390		Copper Alloy, Casting	
		B395		J461, J463	Copper Alloy, U-Bend Seamless Heat Exchanger and Cond. Tube	C824			QQ-C-390		Copper Alloy, Casting	
		B402		J461, J463	Copper Alloy, SHT, PLT, for Pressure Vessels	C825		4890A	QQ-C-390		Copper Alloy, Investment Casting	
		B466		J461, J463	Copper Alloy, Seamless Pipe and Tube				QQ-C-390		Copper Alloy, Casting	
		B467		J461, J463	Copper Alloy, Welded Pipe	C826			QQ-C-390		Copper Alloy, Casting	
		B543		J461, J463	Copper Alloy, Welded Heat Exchanger Tube	C827			QQ-C-390		Copper Alloy, Casting	
		B552		J461, J463	Copper Alloy, Seamless, Welded Tube for Water Desalting Plants	C828			QQ-C-390		Copper Alloy, Casting	
		B608		J461, J463	Copper Alloy, Welded Pipe	C836		4855C	QQ-C-390	J461, J463	Copper Alloy, Sand and Centrifugal Casting	
					J461, J463	Wrought Copper Alloy			B30	QQ-C-525	J461, J463	Copper Alloy, Ingot
								B271	QQ-C-390	J461, J463	Copper Alloy, Centrifugal Casting	
Copper Nickel		B111			Copper Alloy, Seamless Cond. Tube and Ferrule Stock			B505	QQ-C-390	J461, J463	Copper Alloy, Continuous Casting	
		B395			Copper Alloy, U-Bend Seamless Heat Exchanger and Cond. Tube			B584	QQ-C-390	J461, J463	Copper Alloy, Sand Casting	
		B543			Copper Alloy, Welded Heat Exchanger Tube				QQ-C-390	J461, J463	Copper Alloy, Casting	
		B552			Copper Alloy, Seamless and Welded Tube for Desalting Plants				QQ-C-390	J461, J463	Cast Copper Alloy	



Specification Cross Reference*

ALLOY	AMS	ASTM	FED	SAE	FORM	ALLOY	AMS	ASTM	FED	SAE	FORM
C838 (Leaded Red Brass)	B30			J461, J462	Copper Alloy, Ingot	C867 (Leaded Manganese Bronze)		B30			Copper Alloy, Ingot
	B271	QQ-C-390		J461, J462	Copper Alloy, Centrifugal Casting		B271				Copper Alloy, Centrifugal Casting
	B505	QQ-C-390		J461, J462	Copper Alloy, Continuous Casting		B584				Copper Alloy, Sand Casting
	B584	QQ-C-390		J461, J462	Copper Alloy, Sand Casting						
C842 (Leaded Semi-Red Brass)	B30		QQ-C-575		Copper Alloy, Ingot	C868 (Manganese Bronze)	B176	QQ-C-390			Copper Alloy, Casting
	B505		QQ-C-390		Copper Alloy, Continuous Casting		QQ-C-390				Copper Alloy, Casting
			QQ-C-390		Copper Alloy, Casting						
C844 (Leaded Semi-Red Brass)	B30		QQ-C-525		Copper Alloy, Ingot	C874 (Silicon Bronze)	B30		QQ-C-390	J461, J462	Copper Alloy, Ingot
	B271	QQ-C-390			Copper Alloy, Centrifugal Casting		B271			J461, J462	Copper Alloy, Centrifugal Casting
	B505	QQ-C-390			Copper Alloy, Continuous Casting		B584	QQ-C-390	J461, J462	J461, J462	Copper Alloy, Sand Casting
	B584	QQ-C-390			Copper Alloy, Sand Casting			QQ-C-390	J461, J462	J461, J462	Copper Alloy, Casting
C848 (Leaded Semi-Red Brass)	B30				Copper Alloy, Ingot	C875 (Silicon Bronze)	B30			J461, J462	Copper Alloy, Ingot
	B271	QQ-C-390			Copper Alloy, Centrifugal Casting		B271			J461, J462	Copper Alloy, Centrifugal Casting
	B505	QQ-C-390			Copper Alloy, Continuous Casting		B584			J461, J462	Copper Alloy, Sand Casting
	B584	QQ-C-390			Copper Alloy, Sand Casting					J461, J462	Copper Alloy, Casting
C852 (Leaded Yellow Brass)	B30			J461, J462	Copper Alloy, Ingot	C876 (Silicon Bronze)	B30				Copper Alloy, Ingot
	B271	QQ-C-390		J461, J462	Copper Alloy, Centrifugal Casting		B584				Copper Alloy, Sand Casting
	B584	QQ-C-390		J461, J462	Copper Alloy, Sand Casting						
		QQ-C-390		J461, J462	Copper Alloy, Casting						
C854 (Leaded Yellow Brass)	B30			J461, J462	Copper Alloy, Ingot	C878 (Silicon Bronze)	B30			J461, J463	Copper Alloy, Ingot
	B271	QQ-C-390		J461, J462	Copper Alloy, Centrifugal Casting		B176			J461, J463	Copper Alloy, Casting
	B584	QQ-C-390		J461, J462	Copper Alloy, Sand Casting					J461, J463	Cast Copper Alloy
		QQ-C-390		J461, J462	Copper Alloy, Casting						
C855 (Yellow Brass)			QQ-C-390		Copper Alloy, Casting	C879 (Silicon Bronze)	B30			J461, J462	Copper Alloy, Ingot
							B176			J461, J462	Copper Alloy, Casting
										J461, J462	Cast Copper Alloy
C857 (Leaded Yellow Brass)	B30				Copper Alloy, Ingot	C903 (Tin Bronze)	B30	QQ-C-525	J461, J462		Copper Alloy, Ingot
	B271	QQ-C-390			Copper Alloy, Centrifugal Casting		B271	QQ-C-390	J461, J462		Copper Alloy, Centrifugal Casting
	B584	QQ-C-390			Copper Alloy, Sand Casting		B505	QQ-C-390	J461, J462		Copper Alloy, Continuous Casting
		QQ-C-390			Copper Alloy, Casting		B584	QQ-C-390	J461, J462		Copper Alloy, Sand Casting
C858 (Leaded Yellow Brass)	B30			J461, J462	Copper Alloy, Ingot	C905 (Tin Bronze)	4845E	QQ-C-390	J461, J462		Copper Alloy, Sand and Centrifugal Casting
	B176			J461, J462	Copper Alloy, Casting		B22	QQ-C-390	J461, J462		Copper Alloy, Casting for Bridges and Turntables
				J461, J462	Cast Copper Alloy		B30			J461, J462	Copper Alloy, Ingot
							B271	QQ-C-390	J461, J462		Copper Alloy, Centrifugal Casting
C861 (Manganese Bronze)			QQ-C-390		Copper Alloy, Casting	C907 (Tin Bronze)	B30			J461, J462	Copper Alloy, Ingot
							B427	QQ-C-390	J461, J462		Copper Alloy, Gear Bronze Casting
							B505	QQ-C-390	J461, J462		Copper Alloy, Continuous Casting
								QQ-C-390	J461, J462		Copper Alloy, Casting
C862 (Manganese Bronze)	B30		QQ-C-525	J461, J462	Copper Alloy, Ingot	C908 (Tin Bronze)	B30				Copper Alloy, Ingot
	B271	QQ-C-390		J461, J462	Copper Alloy, Centrifugal Casting		B427				Copper Alloy, Gear Bronze Casting
	B505	QQ-C-390		J461, J462	Copper Alloy, Continuous Casting						
	B584	QQ-C-390		J461, J462	Copper Alloy, Sand Casting						
C863 (Manganese Bronze)	4862C		QQ-C-390	J461, J462	Copper Alloy, Sand and Centrifugal, High Strength Casting	C910 (Tin Bronze)	B30	QQ-C-525			Copper Alloy, Ingot
	B22	QQ-C-390		J461, J462	Copper Alloy, Casting for Bridges and Turntables		B505	QQ-C-390			Copper Alloy, Continuous Casting
	B30	QQ-C-523		J461, J462	Copper Alloy, Ingot						
	B271	QQ-C-390		J461, J462	Copper Alloy, Centrifugal Casting						
C864 (Leaded Manganese Bronze)	B30		QQ-C-523	J461, J462	Copper Alloy, Ingot	C911 (Tin Bronze)	B22				Copper Alloy, Casting for Bridges and Turntables
	B271	QQ-C-390		J461, J462	Copper Alloy, Centrifugal Casting		B30				Copper Alloy, Ingot
	B505	QQ-C-390		J461, J462	Copper Alloy, Continuous Casting						
	B584	QQ-C-390		J461, J462	Copper Alloy, Sand Casting						
C865 (Manganese Bronze)	4860B		QQ-C-390	J461, J463	Copper Alloy, Sand and Centrifugal Casting	C913 (Tin Bronze)	B22				Copper Alloy, Casting for Bridges and Turntables
	B30	QQ-C-523		J461, J462	Copper Alloy, Ingot		B30				Copper Alloy, Ingot
	B176	QQ-C-390		J461, J462	Copper Alloy, Casting		B505	QQ-C-390			Copper Alloy, Continuous Casting
	B271	QQ-C-390		J461, J462	Copper Alloy, Centrifugal Casting						
C866 (Leaded Manganese Bronze)	B30		QQ-C-523	J461, J462	Copper Alloy, Ingot	C916 (Tin Bronze)	B30				Copper Alloy, Ingot
	B271	QQ-C-390		J461, J462	Copper Alloy, Centrifugal Casting		B427	QQ-C-390			Copper Alloy, Gear Bronze Casting
	B505	QQ-C-390		J461, J462	Copper Alloy, Continuous Casting						
	B584	QQ-C-390		J461, J462	Copper Alloy, Sand Casting						
C867 (Leaded Manganese Bronze)	B30				Copper Alloy, Ingot	C917 (Tin Bronze)	B30				Copper Alloy, Ingot
	B271	QQ-C-390			Copper Alloy, Centrifugal Casting		B427				Copper Alloy, Gear Bronze Casting
	B505	QQ-C-390			Copper Alloy, Continuous Casting						
	B584	QQ-C-390			Copper Alloy, Sand Casting						
C868 (Manganese Bronze)	B176	QQ-C-390			Copper Alloy, Casting	C922 (Leaded Tin Bronze)	B30	QQ-C-525	J461, J462		Copper Alloy, Ingot
	QQ-C-390				Copper Alloy, Casting		B271	QQ-C-390	J461, J462		Copper Alloy, Centrifugal Casting
							B505	QQ-C-390	J461, J462		Copper Alloy, Continuous Casting
							B584	QQ-C-390	J461, J462		Copper Alloy, Sand Casting
C874 (Silicon Bronze)	B30		QQ-C-390	J461, J462	Copper Alloy, Ingot	C925 (Leaded Tin Bronze)	B30			J461, J462	Copper Alloy, Ingot
	B271		QQ-C-390	J461, J462	Copper Alloy, Centrifugal Casting		B271			J461, J462	Copper Alloy, Centrifugal Casting
	B584	QQ-C-390	J461, J462	J461, J462	Copper Alloy, Sand Casting		B505	QQ-C-390	J461, J462	J461, J462	Copper Alloy, Continuous Casting
		QQ-C-390	J461, J462	J461, J462	Copper Alloy, Casting					J461, J462	Cast Copper Alloy

*Specifications provided for reference only, not necessarily certified by Copper and Brass Sales. Check with your sales representative to confirm the specifications for your order.

One Call Gets It All!
(800) 926-2600

Not For Design Purposes

Specification Cross Reference*

ALLOY	AMS	ASTM	FED	SAE	FORM
C923 (Leaded Tin Bronze)	B30			J461, J462	Copper Alloy, Ingot
	B271	QQ-C-390		J461, J462	Copper Alloy, Centrifugal Casting
	B505	QQ-C-390		J461, J462	Copper Alloy, Continuous Casting
C925 (Leaded Tin Bronze)	B30			J461, J462	Copper Alloy, Ingot
	B505	QQ-C-390		J461, J462	Copper Alloy, Continuous Casting
		QQ-C-390		J461, J462	Copper Alloy, Casting
C927 (Leaded Tin Bronze)	B30			J461, J462	Copper Alloy, Ingot
	B505	QQ-C-390		J461, J462	Copper Alloy, Continuous Casting
		QQ-C-390		J461, J462	Copper Alloy, Casting
C928 (Leaded Tin Bronze)	B30				Copper Alloy, Ingot
	B505				Copper Alloy, Continuous Casting
					Copper Alloy, Casting
C929 (Leaded Tin Bronze)	B30			J461, J462	Copper Alloy, Ingot
	B427			J461, J462	Copper Alloy, Gear
	B505			J461, J462	Copper Alloy, Continuous Casting
C932 (High Leaded Tin Bronze)	B30	QQ-C-525		J461, J462	Copper Alloy, Ingot
	B271	QQ-C-390		J461, J462	Copper Alloy, Centrifugal Casting
	B505	QQ-C-390		J461, J462	Copper Alloy, Continuous Casting
C934 (High Leaded Tin Bronze)	B30				Copper Alloy, Ingot
	B505	QQ-C-390			Copper Alloy, Continuous Casting
		QQ-C-390			Copper Alloy, Casting
C935 (High Leaded Tin Bronze)	B30			J461, J462	Copper Alloy, Ingot
	B271	QQ-C-390		J461, J462	Copper Alloy, Centrifugal Casting
	B505	QQ-C-390		J461, J462	Copper Alloy, Continuous Casting
C937 (High Leaded Tin Bronze)	4842C	QQ-C-390		J461, J462	Copper Alloy, Sand and Centrifugal Casting
	B22	QQ-C-390		J461, J462	Copper Alloy, Casting for Bridges and Turntables
	B30			J461, J462	Copper Alloy, Ingot
C938 (High Leaded Tin Bronze)	B271	QQ-C-390		J461, J462	Copper Alloy, Centrifugal Casting
	B505	QQ-C-390		J461, J462	Copper Alloy, Continuous Casting
	B584	QQ-C-390		J461, J462	Copper Alloy, Sand Casting
C939 (High Leaded Tin Bronze)	B30	QQ-C-525			Copper Alloy, Ingot
	B505	QQ-C-390			Copper Alloy, Continuous Casting
		QQ-C-390			Copper Alloy, Casting
C940 (High Leaded Tin Bronze)	B30	QQ-C-525			Copper Alloy, Ingot
	B505	QQ-C-390			Copper Alloy, Continuous Casting
		QQ-C-390			Copper Alloy, Casting
C941 (High Leaded Tin Bronze)	B30				Copper Alloy, Ingot
	B505	QQ-C-390			Copper Alloy, Continuous Casting
		QQ-C-390			Copper Alloy, Casting
C943 (High Leaded Tin Bronze)	B30			J461, J462	Copper Alloy, Ingot
	B271	QQ-C-390		J461, J462	Copper Alloy, Centrifugal Casting
	B505	QQ-C-390		J461, J462	Copper Alloy, Continuous Casting
C944 (High Leaded Tin Bronze)	B30				Copper Alloy, Ingot
					Copper Alloy, Sand Casting
					Cast Copper Alloy

ALLOY	AMS	ASTM	FED	SAE	FORM
C945 (High Leaded Tin Bronze)		B30			Copper Alloy, Ingot
C947 (Nickel Tin Bronze)	B30			J461, J462	Copper Alloy, Ingot
	B505	QQ-C-390		J461, J462	Copper Alloy, Continuous Casting
	B584	QQ-C-390		J461, J462	Copper Alloy, Sand Casting
C948 (Nickel Tin Bronze)	B30			J461, J462	Copper Alloy, Ingot
	B505	QQ-C-390		J461, J462	Copper Alloy, Continuous Casting
	B584	QQ-C-390		J461, J462	Copper Alloy, Sand Casting
C949 (Nickel Tin Bronze)	B30				Copper Alloy, Ingot
	B584				Copper Alloy, Sand Casting
C952 (Al. Bronze)	B30	QQ-B-675		J461, J462	Copper Alloy, Ingot
	B148	QQ-C-390		J461, J462	Copper Alloy, Sand Casting
	B271	QQ-C-390		J461, J462	Copper Alloy, Centrifugal Casting
C953 (Al. Bronze)	B30	QQ-B-675		J461, J462	Copper Alloy, Ingot
	B148	QQ-C-390		J461, J462	Copper Alloy, Sand Casting
	B271	QQ-C-390		J461, J462	Copper Alloy, Centrifugal Casting
C954 (Al. Bronze)	B30	QQ-B-675		J461, J462	Copper Alloy, Ingot
	B148	QQ-C-390		J461, J462	Copper Alloy, Sand Casting
	B271	QQ-C-390		J461, J462	Copper Alloy, Centrifugal Casting
C955 (Al. Bronze)	B30	QQ-B-675		J461, J462	Copper Alloy, Ingot
	B148	QQ-C-390		J461, J462	Copper Alloy, Sand Casting
	B271	QQ-C-390		J461, J462	Copper Alloy, Centrifugal Casting
C956 (Al. Bronze)	B30	QQ-B-675		J461, J462	Copper Alloy, Ingot
	B148	QQ-C-390		J461, J462	Copper Alloy, Sand Casting
	B271	QQ-C-390		J461, J462	Copper Alloy, Centrifugal Casting
C957 (Al. Bronze)	B30	QQ-B-675		J461, J462	Copper Alloy, Ingot
	B148	QQ-C-390		J461, J462	Copper Alloy, Sand Casting
	B271	QQ-C-390		J461, J462	Copper Alloy, Centrifugal Casting
C958 (Al. Bronze)	B30	QQ-B-675		J461, J462	Copper Alloy, Ingot
	B148	QQ-C-390		J461, J462	Copper Alloy, Sand Casting
	B271	QQ-C-390		J461, J462	Copper Alloy, Centrifugal Casting
C962 (Copper Nickel)	B30	QQ-B-675		J461, J462	Copper Alloy, Ingot
	B369	QQ-C-390		J461, J462	Copper Alloy, Sand Casting
	B505	QQ-C-390		J461, J462	Copper Alloy, Centrifugal Casting
C964 (Copper Nickel)	B30	QQ-B-675		J461, J462	Copper Alloy, Ingot
	B369	QQ-C-390		J461, J462	Copper Alloy, Sand Casting
	B505	QQ-C-390		J461, J462	Copper Alloy, Centrifugal Casting
C973 (Nickel Silver)	B30	QQ-B-675		J461, J462	Copper Alloy, Ingot
	B271	QQ-C-390		J461, J462	Copper Alloy, Sand Casting
	B505	QQ-C-390		J461, J462	Copper Alloy, Centrifugal Casting
C976 (Nickel Silver)	B30	QQ-B-675		J461, J462	Copper Alloy, Ingot
	B271	QQ-C-390		J461, J462	Copper Alloy, Sand Casting
	B505	QQ-C-390		J461, J462	Copper Alloy, Centrifugal Casting
C978 (Nickel Silver)	B30	QQ-B-675		J461, J462	Copper Alloy, Ingot
	B271	QQ-C-390		J461, J462	Copper Alloy, Sand Casting
	B505	QQ-C-390		J461, J462	Copper Alloy, Centrifugal Casting

*Specifications provided for reference only, not necessarily certified by Copper and Brass Sales. Check with your sales representative to confirm the specifications for your order.



Weight Formulas

(All dimensions in inches unless otherwise noted. Use Density from table below.)

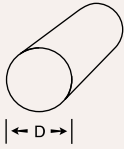

Round Rod: $(\text{Diameter})^2 \times 9.42 \times \text{Density} = \text{Weight per Lineal Foot (Pounds)}$

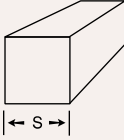

Square Bar: $(\text{Size})^2 \times 12 \times \text{Density} = \text{Weight per Lineal Foot (Pounds)}$

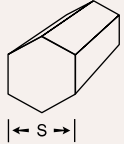

Hexagon Bar: $(\text{Size})^2 \times 10.4 \times \text{Density} = \text{Weight per Lineal Foot (Pounds)}$

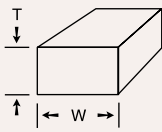

Rectangular Bar: $\text{Thickness} \times \text{Width} \times 12 \times \text{Density} = \text{Weight per Lineal Foot (Pounds)}$

Round Tube: $(\text{Outside Diameter} - \text{Thickness}) \times \text{Thickness} \times 37.7 \times \text{Density} = \text{Weight per Lineal Foot (Pounds)}$

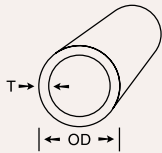

Square Tube: $1.27 \times \text{Round Tube of same Thickness and Outside Dimension} = \text{Weight per Lineal Foot (Pounds)}$

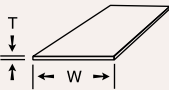

Sheet: $\text{Thickness} \times 144 \times \text{Density} = \text{Weight per Square Foot (Pounds)}$

Coil and Strip: $\text{Thickness} \times \text{Width} \times 12 \times \text{Density} = \text{Weight per Lineal Foot (Pounds)}$

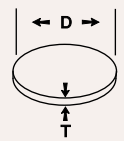

Circles: $(\text{Diameter})^2 \times \text{Thickness} \times 0.785 \times \text{Density} = \text{Weight (Pounds)}$

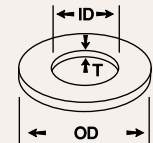

Rings: $(\text{Outside Diameter} + \text{Inside Diameter}) \times (\text{Outside Diameter} - \text{Inside Diameter}) \times \text{Thickness} \times 0.785 \times \text{Density} = \text{Weight (Pounds)}$

Metal	Density (Pounds per Cubic Inch)	Metal	Density (Pounds per Cubic Inch)
Aluminum	0.098	Nickel	0.322
Bearing Bronze (SAE 660)	0.318	Platinum	0.775
Brass	0.306	Silver	0.378
Copper	0.322	Stainless Steel	0.291
Gold	0.697	Steel	0.284
Iron	0.284	Tin	0.264
Lead	0.410	Tobin Bronze	0.304
Magnesium	0.061	Zinc	0.258
Muntz Metal	0.303		
Naval Brass	0.304		



One Call Gets It All!
(800) 926-2600

www.tkmna.com

ThyssenKrupp Materials NA
Copper and Brass Sales Division



CBS-024-07-14 Revised