

Name: _____

Date: _____

Grade K End-of-Year Science Assessment

1. Ms. Henry's class is going to make observations of a real flower. Which should they do?

A.

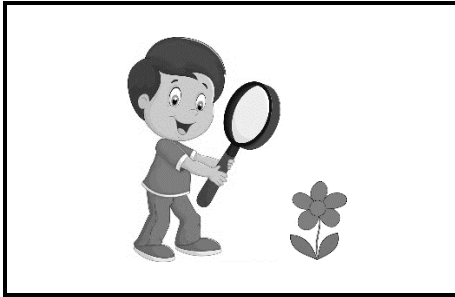

B.

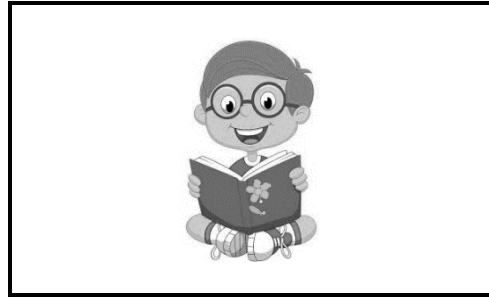

C.

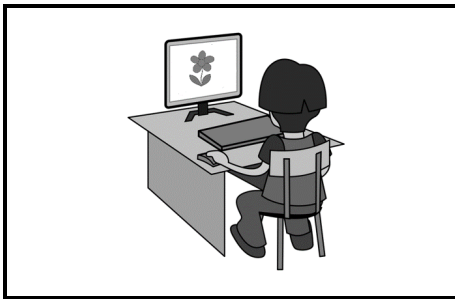

D.

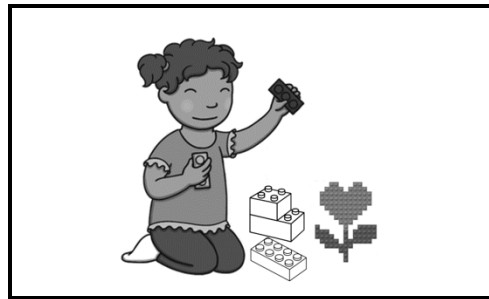

2. After making observations of the flower, Ms. Henry's class wanted to remember what they observed. What should the students do next?

A.



B.

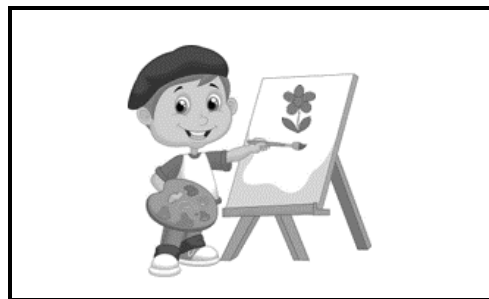

C.

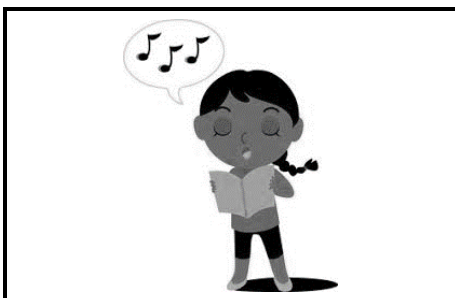

D.

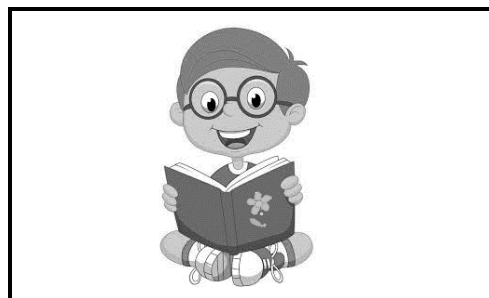

3. What will happen when Lara lets go of the basketball?

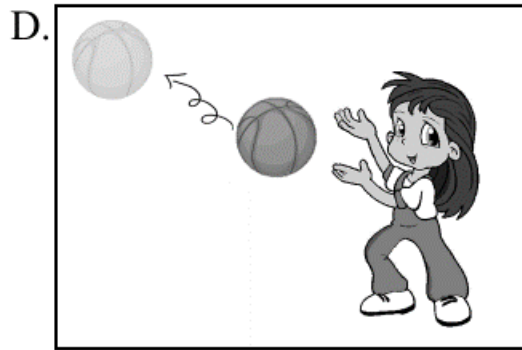
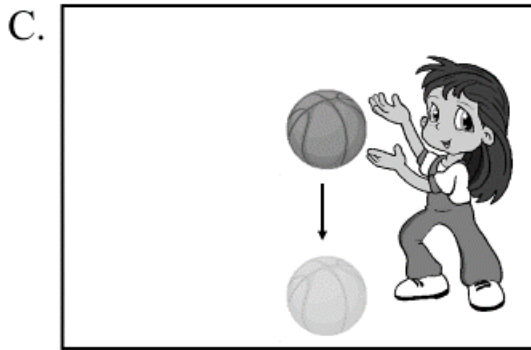
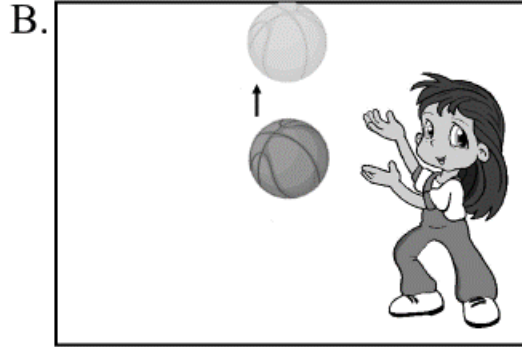
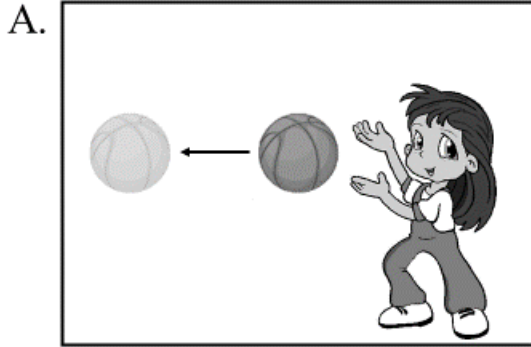

4. Erica looked at the sky in the morning and at night for three days. Each day she recorded what she saw. What did Erica draw after three days?

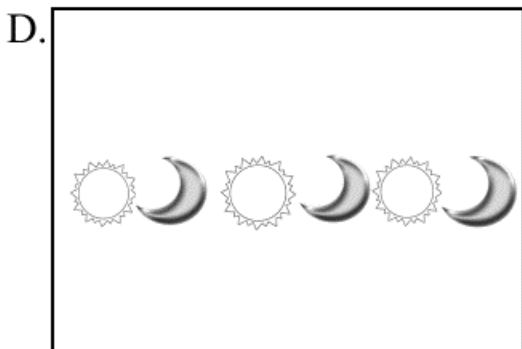
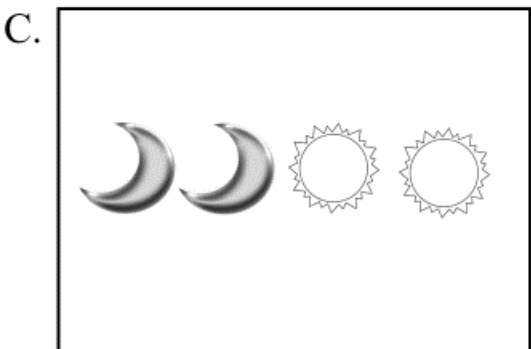
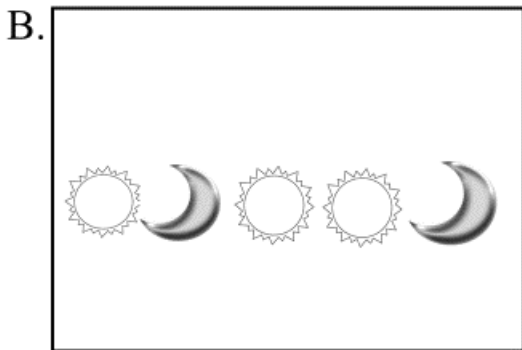
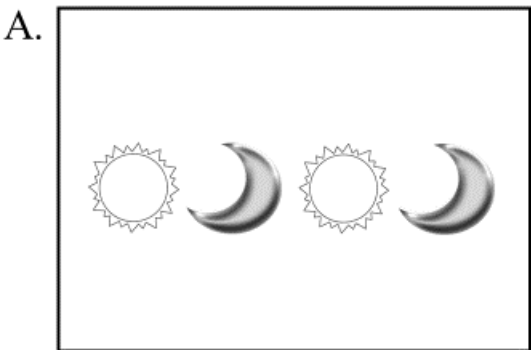

5. Alice was outside at recess after lunch and looked up at the sky. Which of these is always in the daytime sky?

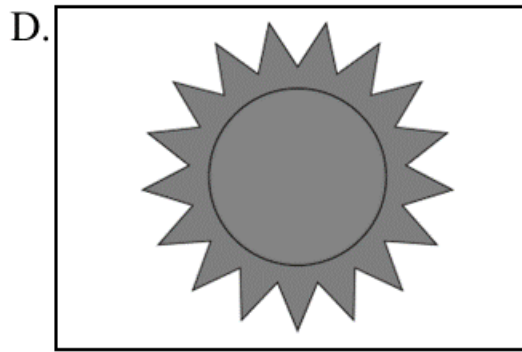
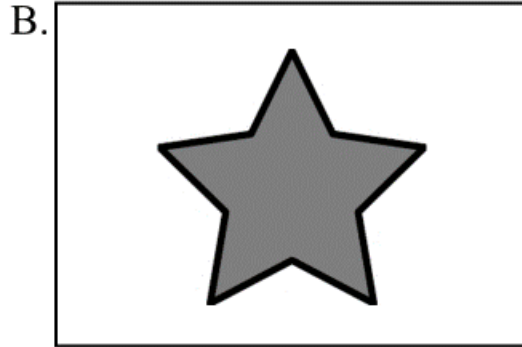
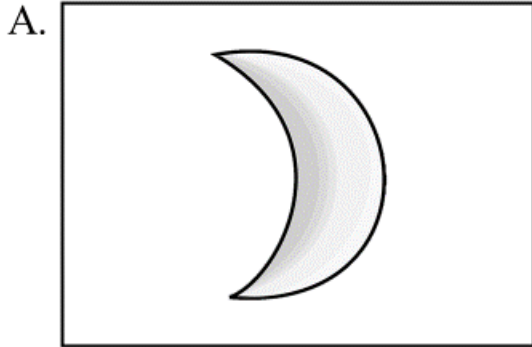

6. Which of the following is usually never seen during the daytime?

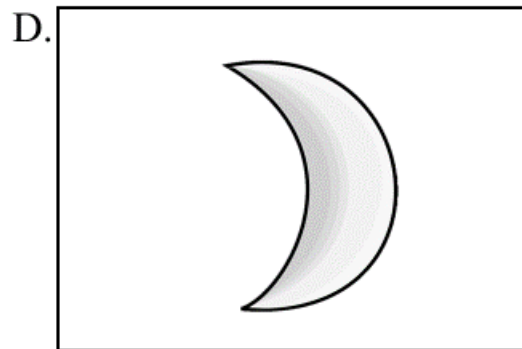
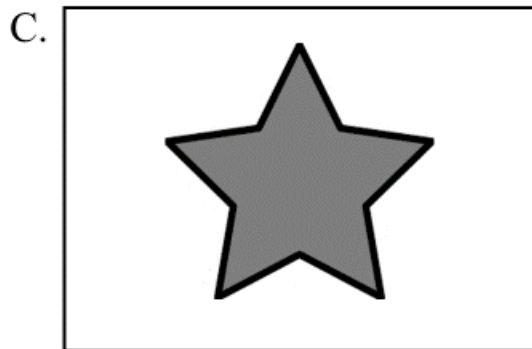
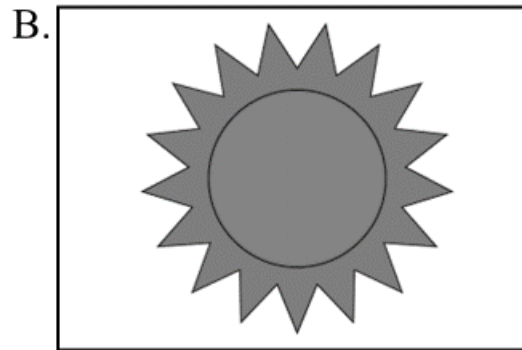
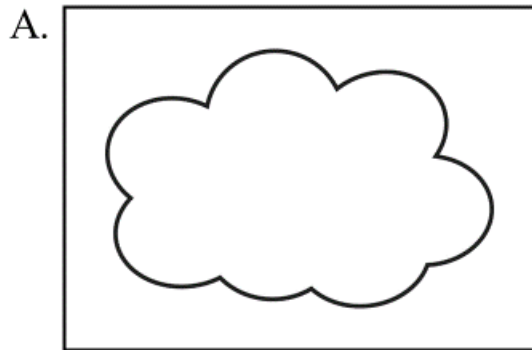

7. Jolani was making observations of things she saw outside her classroom window. She saw four things that looked about the same size. Which item is really the smallest?

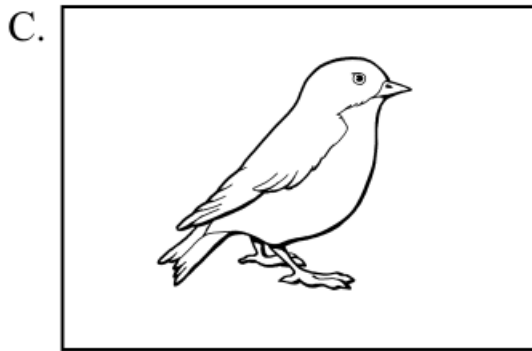
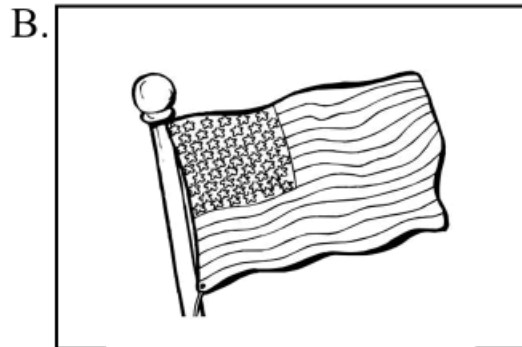
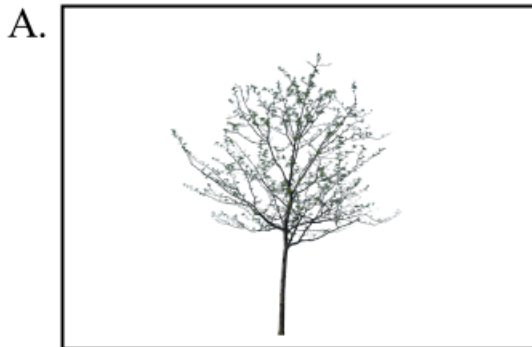

8. Benji was making observations of things he saw outside his classroom window. He saw four things that looked about the same size. Which item is really the closest?

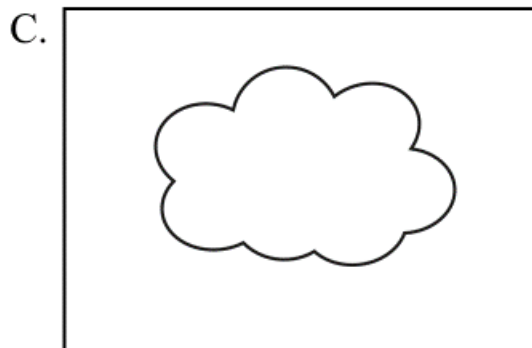
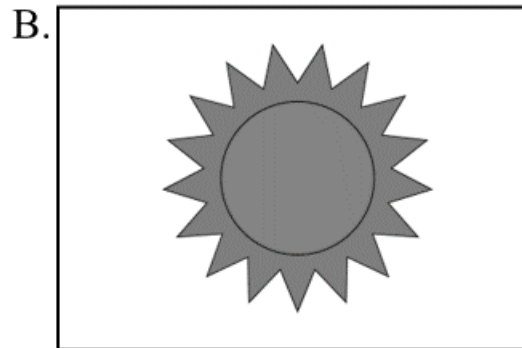
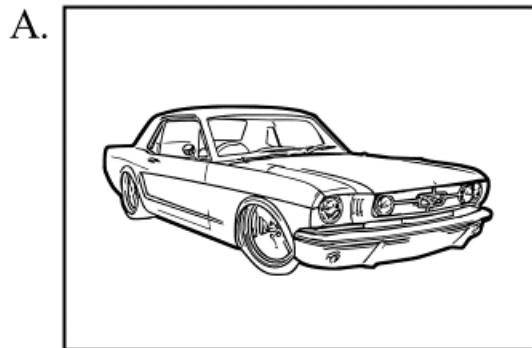

9. Rory sorted items based on weight. Which picture shows the items correctly sorted by weight?

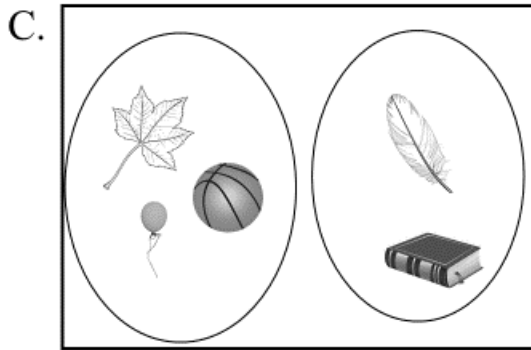
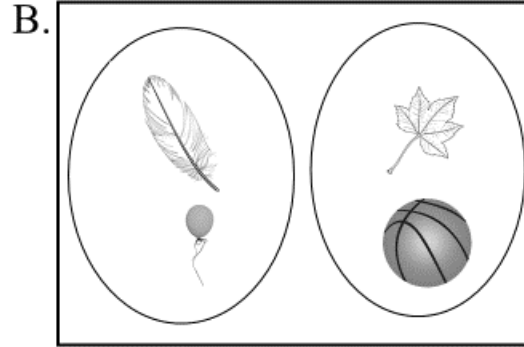
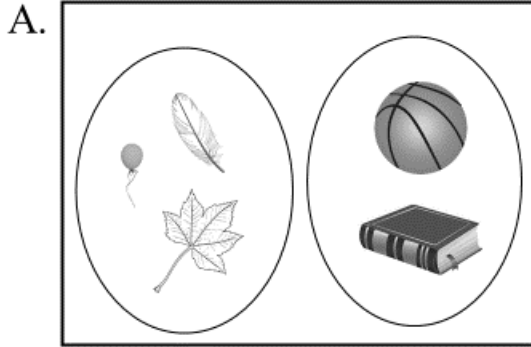

10. Which picture below shows a way to change the shape of paper?

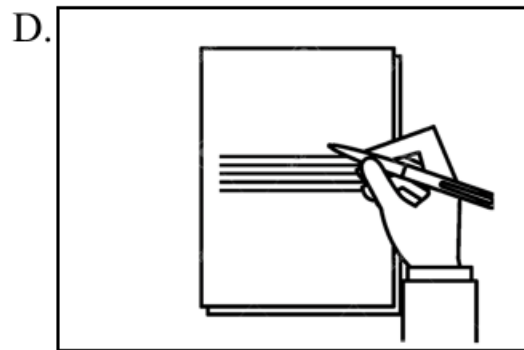
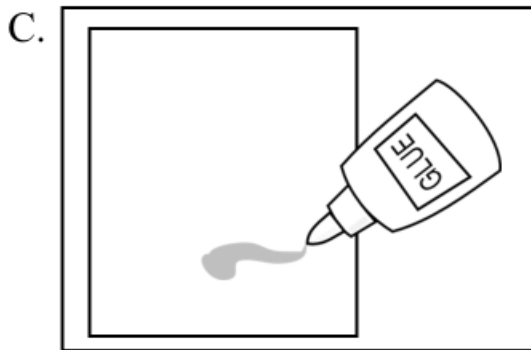
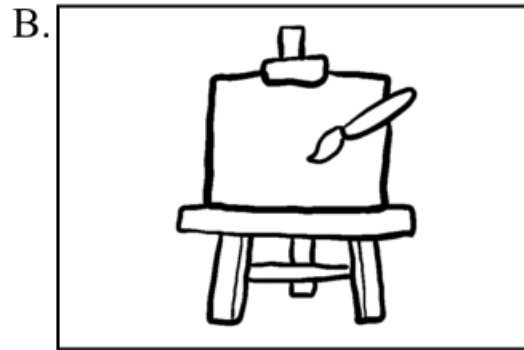
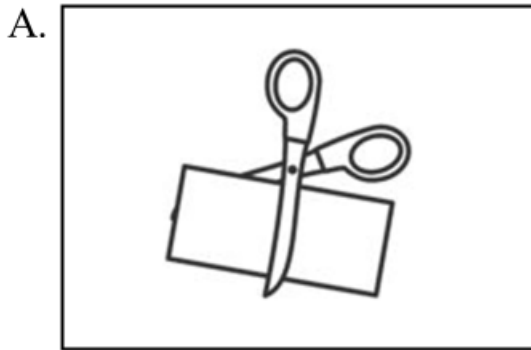

11. Which object below is most likely to vibrate?

A.



B.



C.

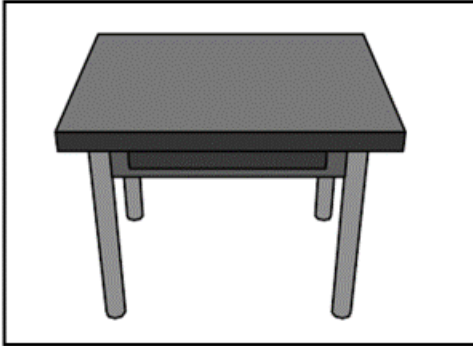

D.

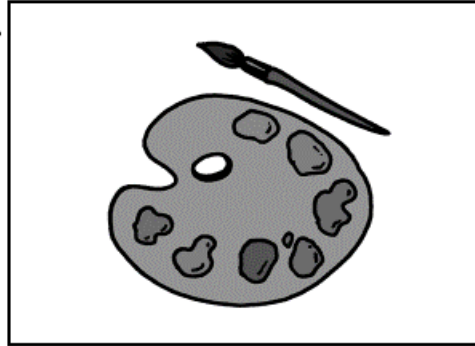

12. Which of these objects moves the fastest?

A.

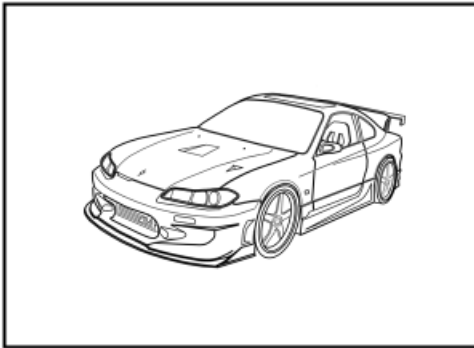

B.

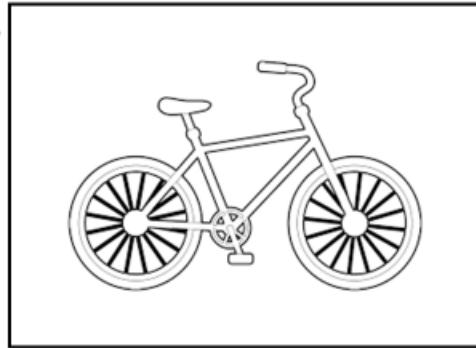

C.

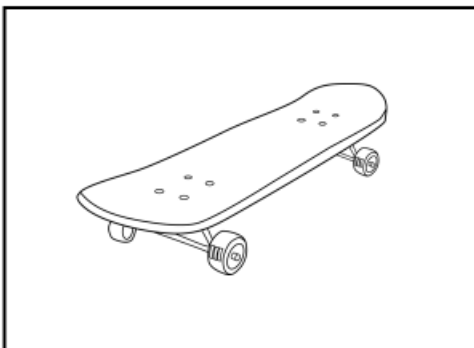

D.

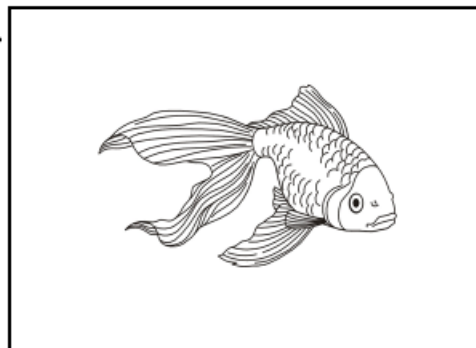

13. Which picture below does **not** show a push or a pull?

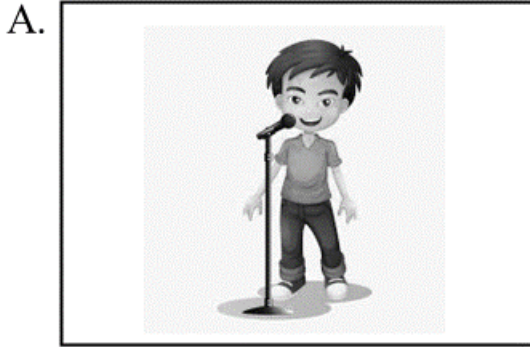

14. Janee said the tennis ball felt fuzzy. Which part of her body did Janee use to feel the tennis ball?

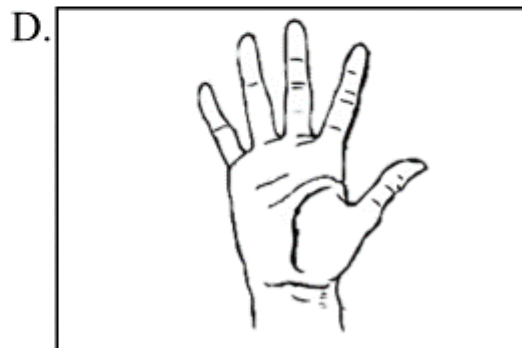
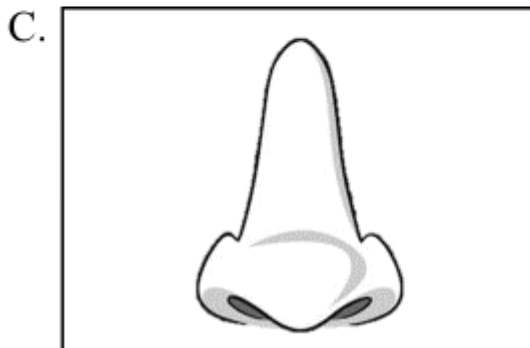
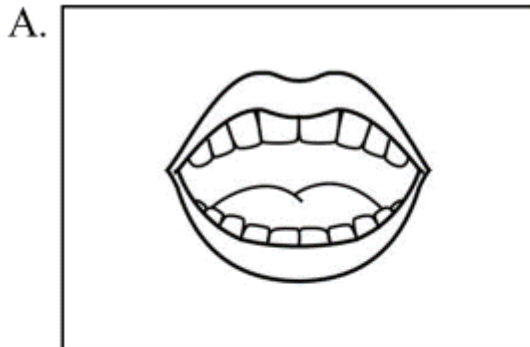

15. Marisol was reading a book about a dog. In the book the dog dug a hole, drove a car, listened to music, and played basketball. Which of these things could a dog really do?

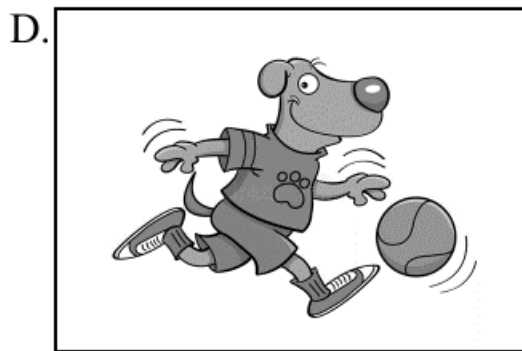
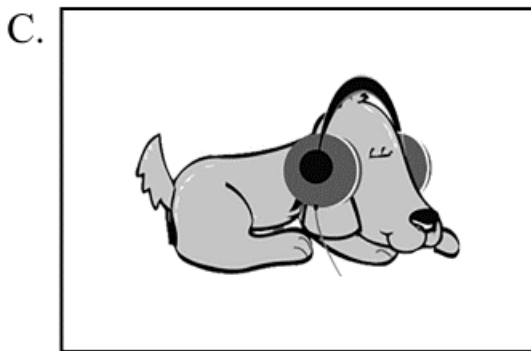
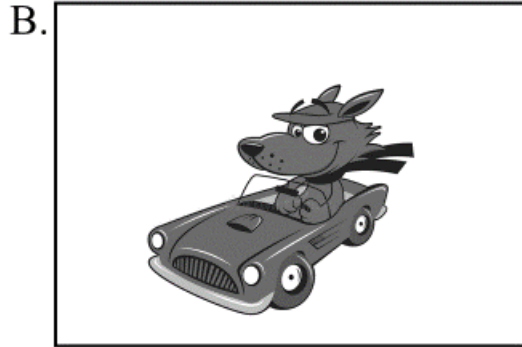
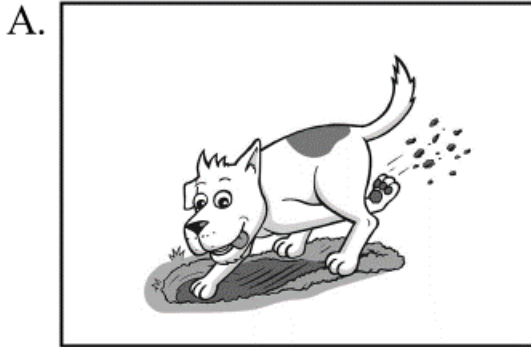

16. Armando was reading a book about animals. In it was a turtle, a cat, a dog, and a snake. Which animal moves differently from the others?

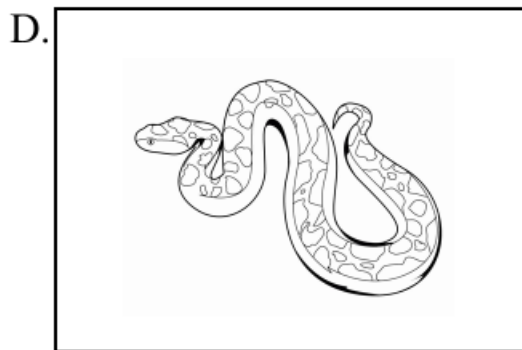
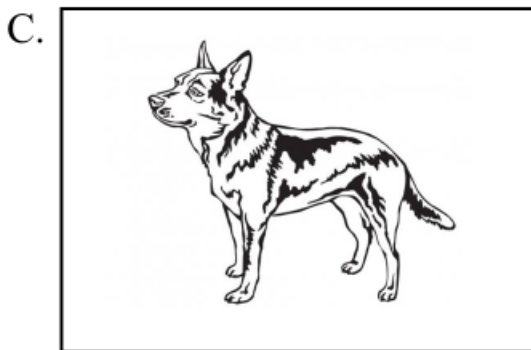
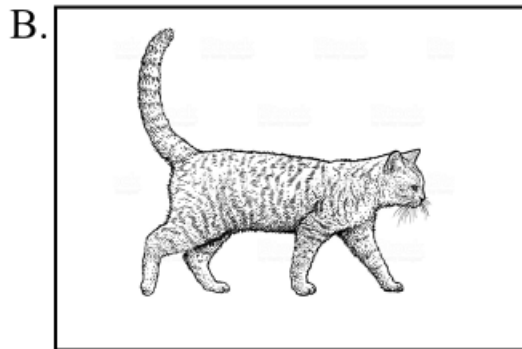
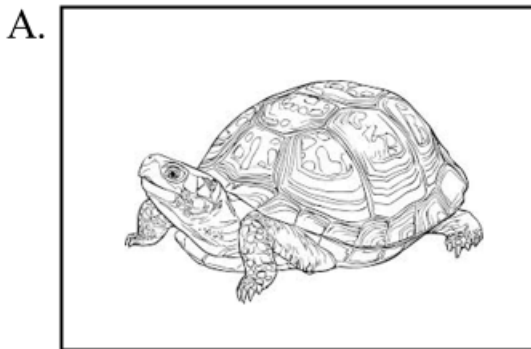

Answer Key: Grade K End-of-Year Science Assessment

| Question # | Correct Answer | Standard(s) |
|------------|----------------|------------------------------------|
| 1 | A | SC.K.N.1.1, SC.K.N.1.2, SC.K.N.1.5 |
| 2 | B | SC.K.N.1.3, SC.K.N.1.4 |
| 3 | C | SC.K.E.5.1 |
| 4 | D | SC.K.E.5.2 |
| 5 | D | SC.K.E.5.3 |
| 6 | C | SC.K.E.5.4 |
| 7 | C | SC.K.E.5.5 |
| 8 | A | SC.K.E.5.6 |
| 9 | A | SC.K.P.8.1 |
| 10 | A | SC.K.P.9.1 |
| 11 | B | SC.K.P.10.1 |
| 12 | A | SC.K.P.12.1 |
| 13 | A | SC.K.P.13.1 |
| 14 | D | SC.K.L.14.1 |
| 15 | A | SC.K.L.14.2 |
| 16 | D | SC.K.L.14.3 |