



PURELY BEAUTIFUL WATERWAYS

LEARN HOW OTTERBINE AERATION AND FOUNTAIN
SYSTEMS KEEP PONDS AND LAKES CLEAN







Powerful Aeration & Attractive Displays, Otterbine Creates Beauty While Solving Problems



LOOK INSIDE & LEARN MORE

- 2** The Otterbine Difference
- 4** Surface & Sub-Surface Aeration Systems
- 6** Aerating Fountains
- 14** Industrial Aerators
- 20** Small Pond Owners: All-in-One Fountain & Circulator
- 22** Giant Fountains
- 28** Lighting
- 30** Sizing & Selection
- 31** Technical Specifications

The Science Behind Beautiful Water...

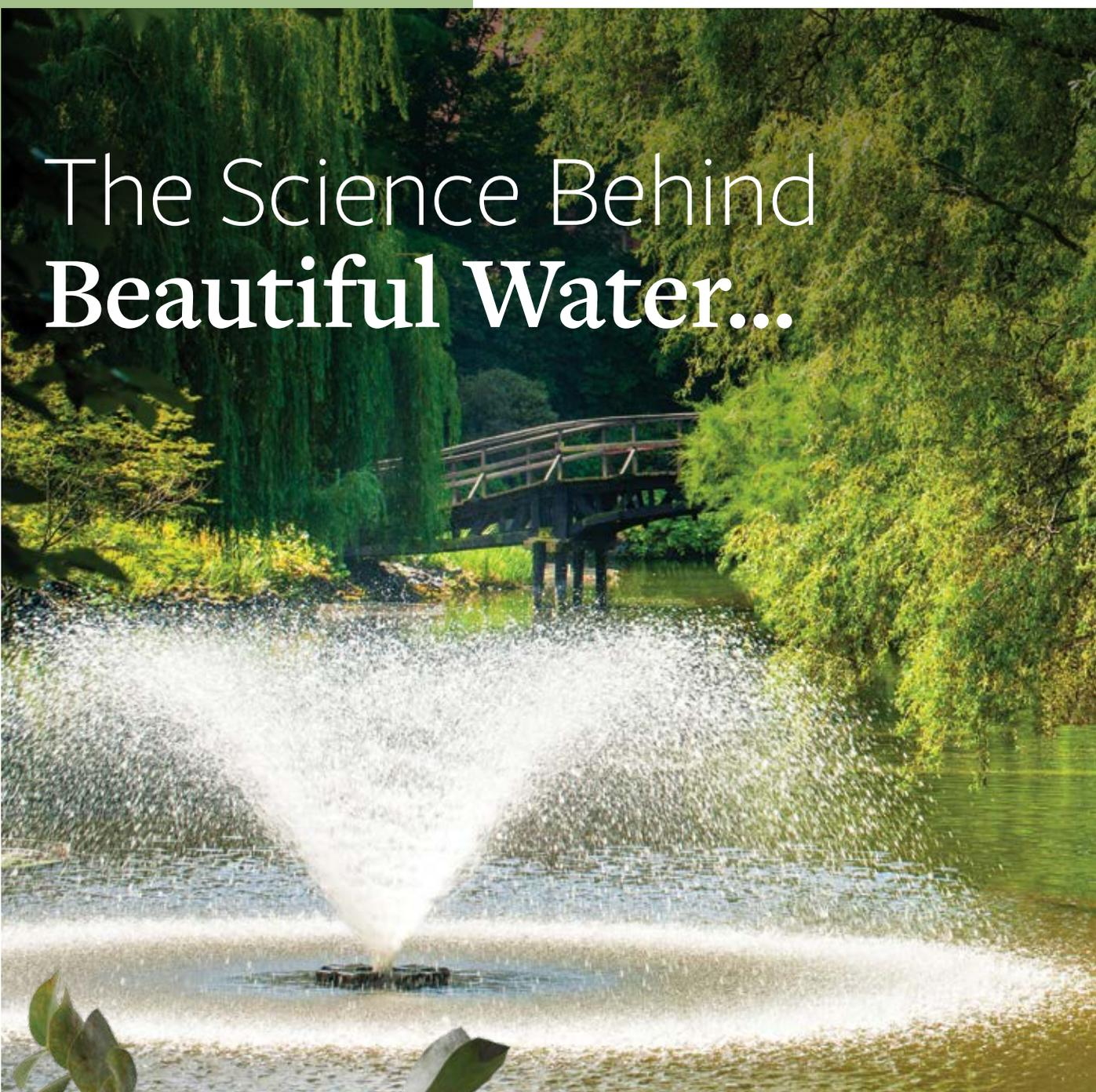

Otterbine-Barebo's passion and true calling in this world is creating beautiful, clean and sustainable waterways. With over 60-years in the lake management industry, family owned Otterbine-Barebo, Inc. manufactures high quality pond and lake management systems that deliver scientifically proven results. Otterbine systems offer the highest oxygen transfer and pumping rates in the industry; independent testing done by the University of Minnesota and GSEE prove it! Otterbine systems add as much as 3.3lbs or 1.5kg of oxygen per horsepower hour into the water and can pump over 920 GPM or 199 m³/hr per horsepower. And, all Otterbine equipment undergoes strict safety testing; we make sure our



“We chose Otterbine because of their reputation as the leading manufacturer of lake management aerators, the durability of the product, and the amount of water that can be aerated per minute, together with the professionalism and the sound support from the company.”

**—Will Righton, GCS,
Mirage City Golf Club Cairo, Egypt**

systems pass ETL, ETL-C and CE standards. Safety features like cable disconnects and surge arrestors come standard with our units while other companies charge more to include them!

Boasting an average lifespan of over 15-years, Otterbine systems are built to last and are energy efficient! Otterbine manufactures units with 316 marine-grade stainless steel. The Otterbine difference matters, as other systems found on the market are manufactured with 304 grade stainless and are unable to withstand the demands of harsh aquatic environments. In addition, Otterbine products maintain top-notch standards by boasting some of the lowest operating costs in the

industry; with systems operating 34% more efficiently than other aerator and fountain type products, and that equals lower operating costs.

Finally, Otterbine takes pride in offering the best customer service possible; and what better way to ensure this than by hand picking every sales and service partner. Combine world class distribution and field service with quality products, and dedicated sales and service support from the factory—it’s no wonder why Otterbine ranks #1 in Customer Satisfaction. There really is only one choice when looking for a scientifically proven method to safely clean and beautify your water; Otterbine.

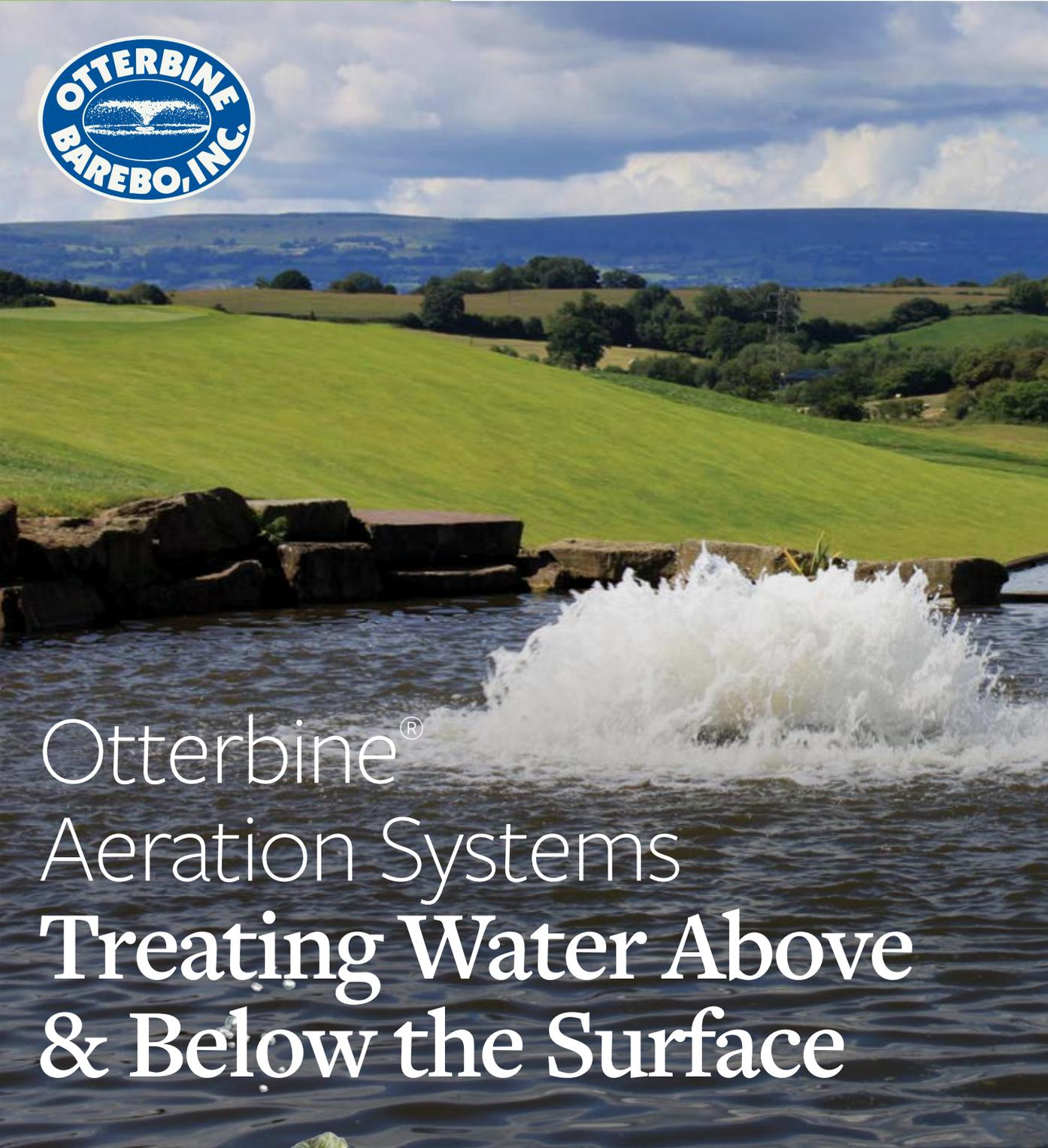
A photograph of a water aerator in a pond. The aerator is a large, white, circular structure with multiple blades or diffusers, creating a large splash of white water. The pond is surrounded by green grassy hills and a blue sky with white clouds. In the foreground, there are some dark rocks.

Otterbine[®] Aeration Systems Treating Water Above & Below the Surface



Otterbine offers a variety of aeration systems including aerating fountains, industrial aerators and subsurface diffused air systems. Choosing the right system is critical and depends on the amount of aquatic vegetation, the visual effect desired and the available power. When determining aeration vs. aesthetic, know that aeration systems need to provide a minimum of 2.2lbs. or 1kg of oxygen per horsepower hour, and



3HP High Volume
& 5HP Sunburst

“The pond regularly became stagnant in the hot weather due to the lack of moving water and low oxygen levels, but the addition of an Otterbine aerator has worked wonders. The pond has been cleaned up dramatically and the water is clear. You can see and smell the difference!”

**—Eoin Riddel, Course Manager,
Royal Dornoch Golf Club**

produce pumping rates of 400GPM or 86.3m³ per hour, per horsepower. A general rule of thumb when selecting a system for aeration is 2HP per surface acre.

Otterbine prides itself on superior customer service from initial inquiry to installation—and beyond—our team is always available to assist you. An Otterbine Regional Consultant will work with you and assist in determining your needs. They will then match you with a field specialist,

who will come on site and walk you through the various systems, and help you determine available power. Finally, our field specialist will recommend an installation expert.

Otterbine also provides free design consultation for any size project. Simply provide us with pond dimensions and depth, or your CAD drawings and details of your project and we will have recommendations and a quote to you within 48-hours!

Aerating Fountains Function & Beauty



Otterbine's Aerating Fountains should not be confused with floating fountains. Our surface spray aerators are engineered to provide results along with beautiful, dynamic spray patterns.

A unique mixed flow pumping system delivers aeration when you need it, while stainless steel and high intensity thermoplastic construction will stand up to effluent and brackish water conditions. Superior construction allows us to provide an industry first 5-year warranty.

Offering both beauty and function; these systems operate in as little as 30 inches or 75cm of water and all 1-5HP Aerating Fountain spray patterns are interchangeable! Not to mention they're backed by Otterbine's exclusive pattern guarantee!!



SUNBURST

60 Hz	1HP	2HP	3HP	5HP
Spray Height (ft)	4	7	10	11
Spray Diameter (ft)	15	24	30	40
GPM	530	640	775	1,100
50 Hz	1HP	2HP	3HP	5HP
Spray Height (m)	1.2	2	2.9	3.2
Spray Diameter (m)	5	7.3	8.6	11.6
m³/hr	114.4	138.1	167.2	237.3



2HP Tristar &
2HP Sunbursts

“I always recommend an Otterbine Aerating Fountain for water features. Otterbine’s Aerating Fountains provide both aesthetics and aeration, helping maintain the water features as an asset to the landscape and property. Otterbine’s quality design, warranties and support during and after the sale are second to none.”

**—Adrian Mortram, Managing Director,
Robin Hume Associates, LTD**



PRODUCT ILLUSTRATION

- 1** High-tech thermoplastic pumping chambers are staged to allow for easy interchange.
- 2** Rugged low visibility closed cell foam filled float includes handles and protective pockets for lights when applicable.
- 3** Industrial strength thermoplastic screen helps keep debris out of the unit.
- 4** Electrical quick disconnect is part of the upper plate to prevent damage.
- 5** Mixed flow pumping system achieves maximum pumping capacities.
- 6** Oil cooled, efficient 3450/2875 RPM custom built motor incorporates a silicon carbide g-type seal to ensure dependability and long life.
- 7** Corrosion resistant, durable 18 gauge/316 grade stainless steel motor housing.

Complete package is safety tested, approved and listed with ETL and ETL-C. Products for the European Union are also safety tested, approved, and carry CE certification. See www.otterbine.com for product testing and package details.



GEMINI

60 Hz	1HP	2HP	3HP	5HP
Spray Height (ft)	5	9	12	15
Spray Diameter (ft)	10	16	24	34
GPM	555	665	800	1,125
50 Hz	1HP	2HP	3HP	5HP
Spray Height (m)	2	2.6	3.5	4.4
Spray Diameter (m)	4	4.7	6.9	9.5
m ³ /hr	119.7	143.5	172.6	242.7





SATURN

60 Hz	1HP	2HP	3HP	5HP
Spray Height (ft)	1.5	3	4.5	5
Spray Diameter (ft)	7	11	20	24
GPM	400	480	580	825
50 Hz	1HP	2HP	3HP	5HP
Spray Height (m)	0.5	0.9	1.4	1.5
Spray Diameter (m)	2.1	3.3	6.1	7
m ³ /hr	86.3	103.6	125.1	178

When looking to improve water quality proper sizing and placement of units is critical. Units that have higher pumping rates offer the best solution in managing severe aquatic environments; while combining more aesthetic patterns like the Tristar with an aeration pattern like the Sunburst can provide the best of both worlds!

“As an Audubon International Signature Course, water quality is important at Catechee Golf Club. We have a 10 million gallon effluent water holding pond on the golf course that initially presented problems with algae and low oxygen. These problems led to odors and fish kills. We installed two Otterbine aerators and one Otterbine sub-aerator about 10 years ago. These units solved our issues and have been virtually problem free. I highly recommend Otterbine products.”

**—Buck Workman,
CGCS Catechee Golf Club, Hartwell, GA**



PHOENIX

60 Hz	1HP	2HP	3HP	5HP
Spray Height (ft)	8	11	15	18
Spray Diameter (ft)	14	20	28	34
GPM	150	210	275	400
50 Hz	1HP	2HP	3HP	5HP
Spray Height (m)	3	4	4.2	4.2
Spray Diameter (m)	5.5	6.4	7.2	7.2
m ³ /hr	32.4	45.3	59.3	59.3



ROCKET

60 Hz	1HP	2HP	3HP	5HP
Spray Height (ft)	11-13	17-19	20-22	23-25
Spray Diameter (ft)	5	5	8	8
GPM	110	155	200	290
50 Hz	1HP	2HP	3HP	5HP
Spray Height (m)	3.8-4.4	4.9-5.5	5.6-6.2	5.6-6.2
Spray Diameter (m)	1.5	1.5	2.4	2.4
m ³ /hr	23.7	33.4	43.2	43.2



TRISTAR

60 Hz	1HP	2HP	3HP	5HP
Spray Height (ft)	8	12	16	19
Spray Diameter (ft)	13	17	23	27
GPM	150	210	275	400
50 Hz	1HP	2HP	3HP	5HP
Spray Height (m)	3	4	4.6	4.6
Spray Diameter (m)	4	5.2	6.1	6.1
m ³ /hr	32.4	45.3	59.3	59.3



CONSTELLATION

60 Hz	1HP	2HP	3HP	5HP
Spray Height (ft)	4	6	9	10
Spray Diameter (ft)	18	28	35	36
GPM	150	210	275	400
50 Hz	1HP	2HP	3HP	5HP
Spray Height (m)	1.2	1.8	2.4	2.4
Spray Diameter (m)	5.4	7.6	9.6	9.6
m ³ /hr	32.4	45.3	59.3	59.3



EQUINOX

60 Hz	1HP	2HP	3HP	5HP
Spray Height (ft)	10	13	15	20
Spray Diameter (ft)	35	40	58	72
GPM	150	210	275	400
50 Hz	1HP	2HP	3HP	5HP
Spray Height (m)	3	4	4.5	5.3
Spray Diameter (m)	10.5	12	17	18.3
m ³ /hr	32.4	45.3	59.3	59.3



OMEGA

60 Hz	1HP	2HP	3HP	5HP
Spray Height (ft)	8	11	15	18
Spray Diameter (ft)	10	16	21	22
GPM	150	210	275	400
50 Hz	1HP	2HP	3HP	5HP
Spray Height (m)	2.7	3.1	3.5	3.5
Spray Diameter (m)	3	4.1	5	5
m ³ /hr	32.4	45.3	59.3	59.3



COMET

60 Hz	1HP	2HP	3HP	5HP
Spray Height (ft)	9-11	16-18	19-21	21-23
Spray Diameter (ft)	5	5	8	8
GPM	130	185	240	325
50 Hz	1HP	2HP	3HP	5HP
Spray Height (m)	2.8-3.4	4.4-5	5.2-6.8	5.2-6.8
Spray Diameter (m)	1.5	1.5	2.4	2.4
m ³ /hr	28	39.9	51.8	51.8



GENESIS

60 Hz	1HP	2HP	3HP	5HP
Spray Height (ft)	6	10	15	18
Spray Diameter (ft)	24	32	50	62
GPM	150	210	275	400
50 Hz	1HP	2HP	3HP	5HP
Spray Height (m)	2.1	3.4	4.2	4.2
Spray Diameter (m)	7.6	10.7	13.7	13.7
m ³ /hr	32.4	45.3	59.3	59.3

Fountain Glo™ LED Lighting The Perfect Accessory

“The aerators look stunning and instantly changed the look of what were just open bodies of water. The aerators give us stunning views both day and night with the inclusion of the lighting kits.”

**—Daniel Rowe, Course Manager
The Warwickshire Golf & Country Club**

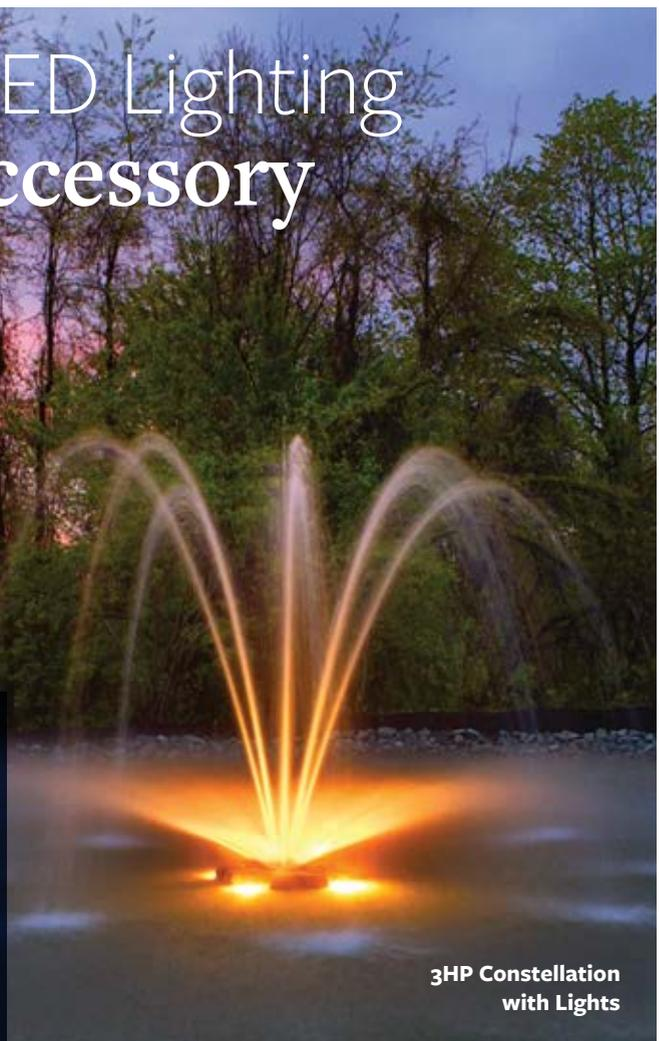

**3HP Constellation
with Lights**

Highlight your Aerating Fountain into the nighttime hours while adding value and security to your property. Choose from our standard LED light sets, or upgrade to our color changing 40W RGBW sequencing light sets.

RECOMMENDED LED LIGHT SET BY PATTERN & HP

Pattern	4-Light	6-Light	8-Light*
Sunburst	1HP-5HP	—	—
Gemini	1HP-5HP	—	—
Saturn	1HP-5HP	—	—
Tristar	1HP-5HP	—	—
Omega	1HP-5HP	—	—
Phoenix	1HP-3HP	5HP	—
Constellation	1HP-2HP	3HP-5HP	—
Rocket	1HP-2HP	3HP-5HP	—
Comet	1HP-2HP	3HP-5HP	—
Genesis	1HP	2HP	3HP-5HP
Equinox	—	1HP	2HP-5HP

Add more lights for brighter displays. Refer to chart above for Otterbine's recommended low voltage LED light set by pattern and size. Additional information on these systems as well as our RGBW Sequencing Lights can be found later in this catalog under Fountain Glo™ Lighting.

*8-Light LED systems require two cable runs.

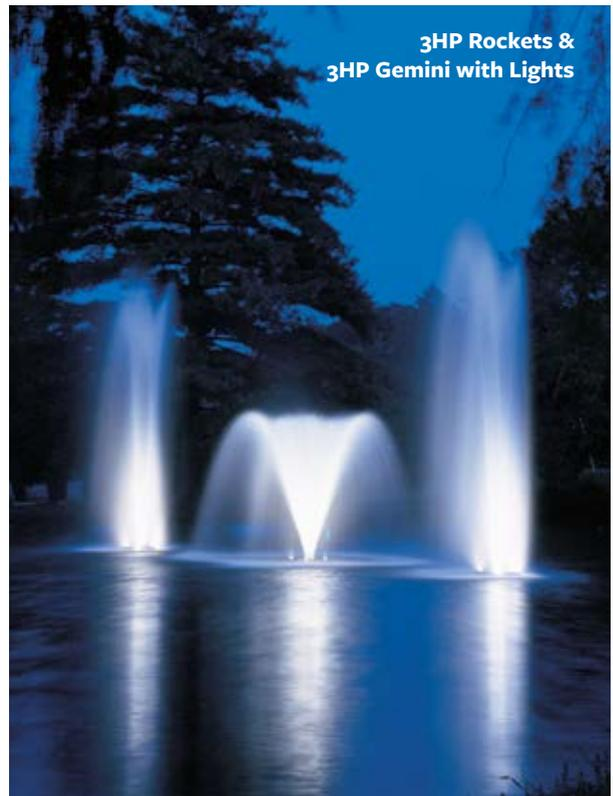

**3HP Rockets &
3HP Gemini with Lights**

From a Backyard Oasis to Community Ponds

Aerating Fountain:
Sunburst



Aerating Fountain:
Gemini with LED Lights



Aerating Fountain:
Rocket



Aerating Fountain:
Phoenix



Aerating Fountain:
Tristar



Aerating Fountain:
Gemini



Industrial Aerators Surface & Subsurface

Otterbine's experience in aquaculture and wastewater treatment is obvious in the performance driven results of our surface and subsurface industrial aeration systems. Constructed from 316 stainless steel, thermoplastics and rugged low speed motors; these systems are designed to withstand the demands of severe aquatic environments. The High Volume is Otterbine's power house providing over 3.3lbs. or 1.5kg of oxygen per horsepower hour and pumping over 920GPM or 198m³ per hour. These systems provide unique solutions to managing water quality, and are available in low profile spray patterns and horizontal mixers.

All Industrial Aerators can operate in as little as 3ft or 92cm of water and are supported by a comprehensive 3-year warranty.



HIGH VOLUME

60 Hz	1HP	2HP	3HP	5HP
Spray Height (ft)	1.5	2	3	4.5
Spray Diameter (ft)	4	7	9	11
GPM	920	1,525	2,100	3,000
50 Hz	1HP	2HP	3HP	5HP
Spray Height (m)	0.5	0.6	0.9	1.1
Spray Diameter (m)	1.2	2.3	2.6	3.5
m³/hr	198.5	329	453.1	647.2

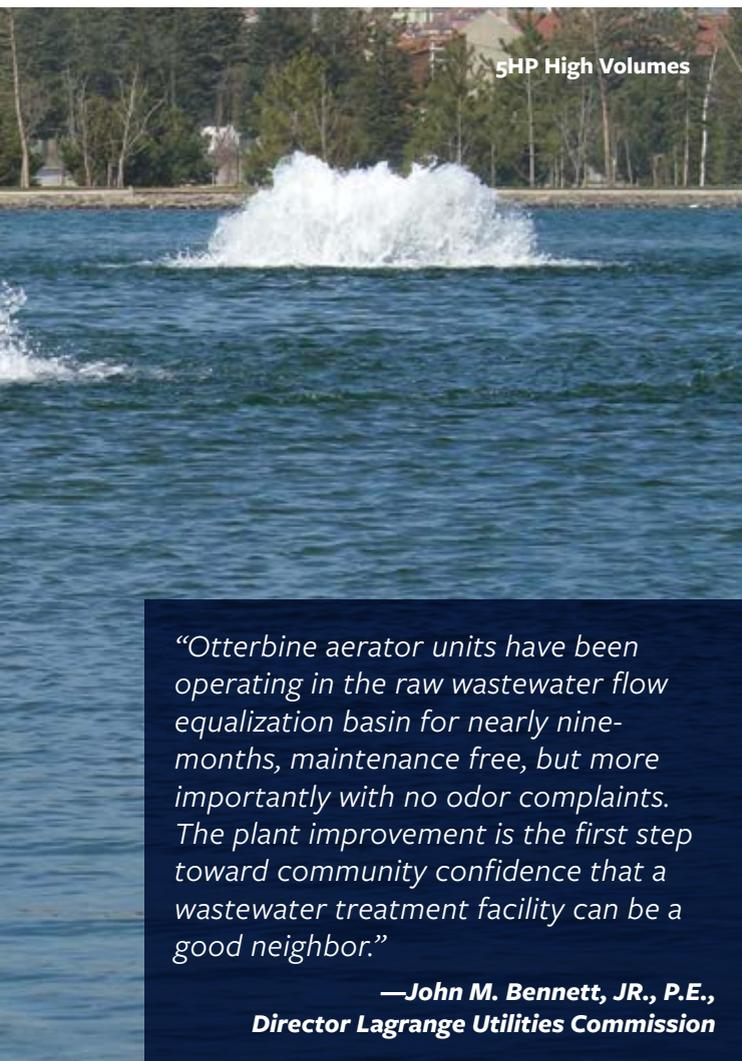

High Volume

PRODUCT ILLUSTRATIONS

- 1** Rugged closed cell foam filled low visibility polyethylene float.
- 2** Precision pitched stainless steel impeller is virtually unbreakable.
- 3** Protective arms secure motor unit and allow for easy handling.
- 4** Electrical quick disconnect is part of upper plate to prevent accidental damage.
- 5** Enclosed in a corrosion resistant, durable 18 gauge/316 grade stainless steel motor housing, the oil-cooled, efficient 1725/1425 RPM custom built motor has dynamically balanced rotors to move high volumes of water.



Triton Mixer



Sub-Triton Mixer



Triton Aspirator



Sub-Triton Aspirator

Complete package is safety tested, approved and listed with ETL and ETL-C. Products for the European Union are also safety tested, approved, and carry CE certification. See www.otterbine.com for product testing and package details.

Like components used throughout industrial aerators. High Volume is mounted vertically, while Aspirator and Mixer models are mounted horizontally.



MIXERS: TRITON & SUB-TRITON

60 Hz	1HP	2HP	3HP
Volume (ft³) Influenced	490,000	980,000	1,470,000

50 Hz	1HP	2HP	3HP
Volume (m³) Influenced	12,488	24,976	37,463



ASPIRATORS: TRITON & SUB-TRITON

60 Hz	1HP	2HP	3HP	5HP
Volume (ft³) Influenced	210,000	420,000	630,000	1,050,000

50 Hz	1HP	2HP	3HP	5HP
Volume (m³) Influenced	5,352	10,704	16,056	26,760



**Air Flo
Diffused Aeration**

“The Air Flo 3 system is virtually invisible, stealthily quiet and yet highly effective in maintaining an environmentally healthy and aesthetically pleasing high visibility water feature.”

**—Chuck Gast,
CGCS Bellerive CC, St. Louis MO**

The Air Flo 3 is Otterbine’s subsurface diffused aeration system and is one of several choices Otterbine offers when no surface spray is desired. Often referred to as a ‘bubbler’ system, these units operate from quiet on-shore compressors that pump air to diffusers placed at the pond bottom. Oxygen is then released in the form of bubbles throughout the water column, mixing bottom and top water layers breaking down thermal stratification and adding much needed oxygen to the pond.

With no electrical components in the water, these systems are the ideal choice for water quality management solutions in recreational bodies of water. Requiring little to no maintenance, these units are constructed of corrosion resistant materials and can operate in depths from 6ft–40ft or 2m–12m. Independently tested for safety and effectiveness, the Air Flo includes a 2-year all-inclusive warranty.

AIR FLO DIFFUSED AIR

SYSTEM	# of Compressor(s)	Diffuser Pad(s)	# Discs per Pad	# Disc per System
AF3-121	1	2	1	2
AF3-131	1	3	1	3
AF3-141	1	4	1	4
AF3-112	1	1	2	2
AF3-122	1	2	2	4
AF3-241	2	4	1	4
AF3-261	2	6	1	6
AF3-281	2	8	1	8
AF3-222	2	2	2	4
AF3-232	2	3	2	6
AF3-242	2	4	2	8
AF3-262	2	6	2	12

PRODUCT ILLUSTRATION



- Air Flo 3 Diffused Air Systems incorporate 1/2HP oil-less rocking piston compressors allowing for operating depths up to 40ft or 12m.
- All systems come with self-cleaning 12in (305mm) disc diffuser manifolds (single or dual)
- Diffuser manifold base is constructed of high-density polyethylene plastic and incorporate ballast channels for level sinking of pads during installation.
- Enhanced 18 gauge, 304 stainless steel cabinet construction is corrosion resistant, provides quieter operation and simplified servicing.
- Compact and low profile, cabinet footprint for all systems is 16in x 16in x 20.5in (41cm x 41cm x 52cm)
- Cabinet cooling system includes (2) axial fans that draw air through vented louvers on the front and bottom of the cabinet for complete cabinet air exchange at the rate of 225 times per minute.
- Valve manifolds located inside cabinet allow for future expansion of most Air Flo 3 Systems.
- Cabinet enclosure secured by stainless steel latch that accommodates a locking mechanism.

Complete package is safety tested, approved and listed with ETL and ETL-C. Products for the European Union are also safety tested, approved, and carry CE certification. Minimum operating depth varies, visit www.otterbine.com for product testing and package details.

Why the Science of Water Management is Critical

TOP 10 REASONS FOR AERATION:

1. Algae and Aquatic Weed Control
2. Odor Reduction
3. Reduction/Elimination of Chemicals
3. Phosphorus Reduction
4. Elimination of Fish Kills
5. Oxidation of Iron and Heavy Metals
6. Mosquito Breeding Deterrent
8. Beneficial to Aquatic Animal Life & Ecosystem
9. Prolongs the Life of the Pond/Lake
10. Public Safety; Aeration Prevents Diseases Associated with Stagnant Water

The scientific measure of an aerator's capability to supply a lake with oxygen is its "Oxygen Transfer Rate" (OTR) as defined by The American Society of Civil Engineers. The gold standard for the measure of how much oxygen an aeration system transfers is the ASCE "Measurement of Oxygen Transfer in Clean Water." Any manufacturer that is serious about helping its customers keep the aquatic ecosystem balanced and clean will happily provide you with oxygen transfer tests performed by an independent third party. Otterbine's systems are tested for OTR by the University of Minnesota and Gerry Shell Environmental Labs; these test results can be found at www.otterbine.com. Be sure to ask for a manufacturer's test results when in the market for an aerator.

Aeration provides a multitude of benefits to a lake or pond. The primary benefit of any aeration system is to add dissolved oxygen to the water. Aeration supports aerobic digestion and oxidative processes. Aerobic digestion is where naturally forming bacteria consume or biodegrade organic material in the lake. We speak of oxidation primarily in that oxygen attaches to phosphorus in the water and converts it to an insoluble form, unavailable to plants as a nutrient. One gram of phosphorus grows one hundred grams of algae.

Surface spray and diffused aeration are the most common type of aerators. Surface spray aerators throw water droplets through the air. The droplets trap atmospheric oxygen molecules and fall to the surface releasing "dissolved oxygen" (DO) into the water. The



Here are the results of a High Volume aerator after one month in operation.

Otterbine High Volume surface spray aerator adds over 3lbs (1.5kg) of oxygen to the water per horsepower hour regardless of depth. Independent tests indicate that surface spray units add 2 mg/l of DO to the water at depths of 12ft (3.6m). Diffused aeration is a process where air is driven down a tube and released through a diffuser at the bottom of the basin. The air bubbles are slowly "absorbed" by the water as they rise to the surface. Air bubbles rise to the surface at 1ft (30cm) per second; meaning that diffuser OTR increases with depth. A diffused aerator will transfer only 1.59lbs of oxygen per horsepower hour in 8ft (2.4m) of water, while it will transfer up to 2.72lbs (1.23kg) of oxygen per horsepower hour in 14 ft (4.2m) of depth. Our 1HP High Volume and Sunburst aerators have a higher OTR than a 1HP diffuser system at depths of 8ft -14ft (or 2.4m - 4.2m.) Call the experts at Otterbine to assist you in selecting the right system for your application!

From the Fairway to the Clubhouse

Aerating Fountain:
Sunburst



Aerating Fountain:
Gemini



Industrial Aerator:
High Volume



Fractional Series:
Gemini



Aerating Fountain:
Tristar



Industrial Aerator:
High Volume



Industrial Aerator:
Air Flo



All-In-One Fountain & Circulator Small Pond Solutions

Whether you're looking for aeration or an attractive display, this all-in-one fountain & circulator is the ideal solution for small ponds less than three quarters of an acre in size. Easily converted in just minutes between the included four aerating fountain patterns and horizontal circulator.

Smaller ponds tend to be shallow, and therefore need a system that will achieve proven results. Make sure when deciding on a small pond aeration system to compare circulation and oxygen transfer rates. When set to the Gemini pattern (seen above) this unit adds an amazing 1.13lbs or .5kg of oxygen per horsepower hour and pumps 506GPM or 115m³ per hour.

Enjoy the beauty of this aerating fountain at night by purchasing the deluxe package which comes complete with a beautiful 2-light led system, with colored lenses available.

1/2HP FRACTIONAL SERIES

60 Hz	GEMINI	HIGH VOLUME	PHOENIX	ROCKET	MIXER
Spray Height (ft)	4	2	10.6	10.6	n/a
Spray Diameter (ft)	4.5	2.5	10.6	3	n/a
GPM	506	435	195	179	n/a*
50 Hz	GEMINI	HIGH VOLUME	PHOENIX	ROCKET	MIXER
Spray Height (m)	1.2	1	2.8	3	n/a
Spray Diameter (m)	1.8	1.4	3	40 cm	n/a
m³/hr	115	99	44	41	n/a*

*1/2HP Mixer volume influenced is 245,000ft³ (6938m³) and effectively moves water 115 linear feet (35 linear meters).



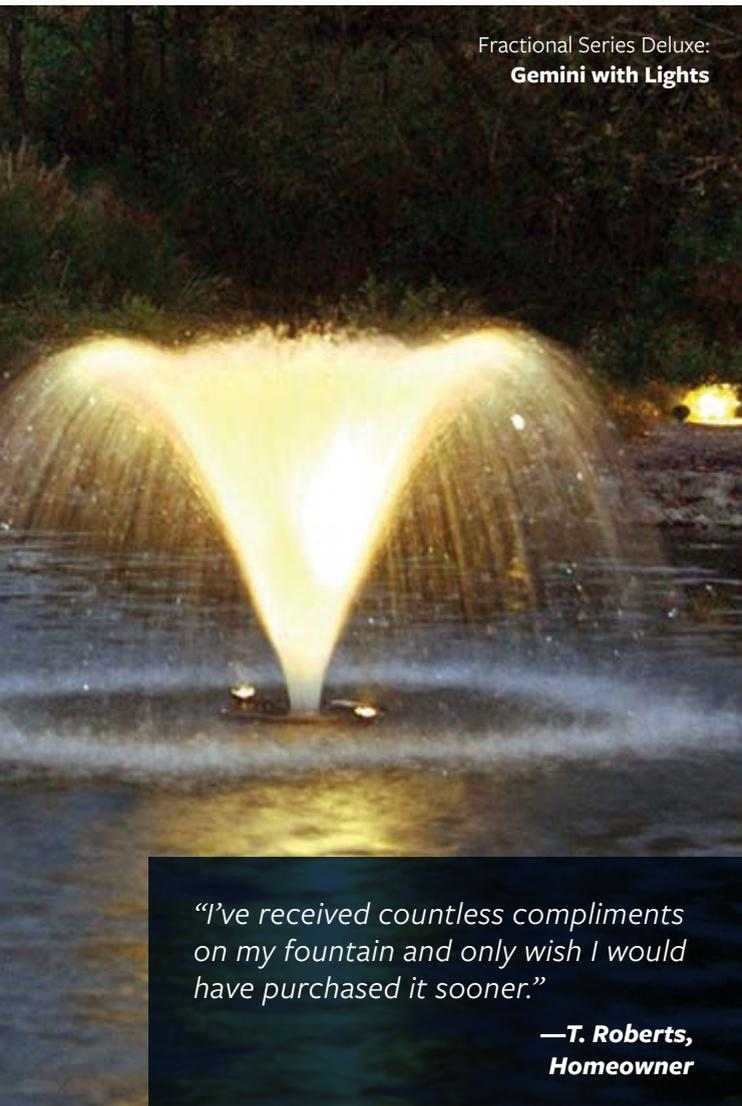

PRODUCT ILLUSTRATION

- 1** Includes corrosion resistant adjustable spray impellers/patterns to produce 4 spray patterns, and a horizontal mixer. [comes assembled as Gemini]
- 2** Rugged low visibility foam filled polyethylene float with recessed light pockets.
- 3** Oil cooled, efficient 3250/2750RPM custom built motor incorporates a silicon carbide single seal to ensure dependability and long life.
- 4** Corrosion resistant, durable 18 gauge/316 grade stainless steel motor housing.
- 5** Stainless steel brackets allow for easy conversion between aerating fountain patterns and mixer model.
- 6** Adjustable discharge angle +/- 8 degrees. [Mixer model only]

Complete package is safety tested, approved and listed with ETL and ETL-C. Products for the European Union are also safety tested, approved and carry CE certification. Minimum operating depth is 16in or 41cm. Visit www.otterbine.com for details.

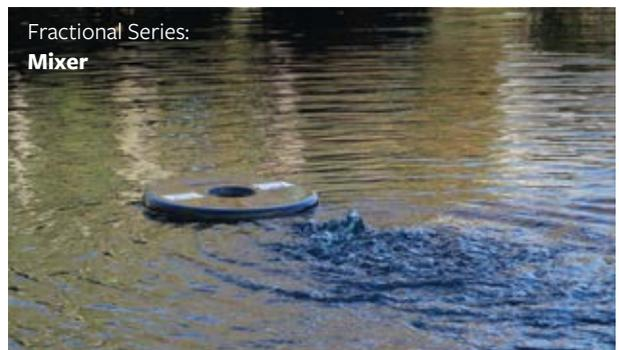
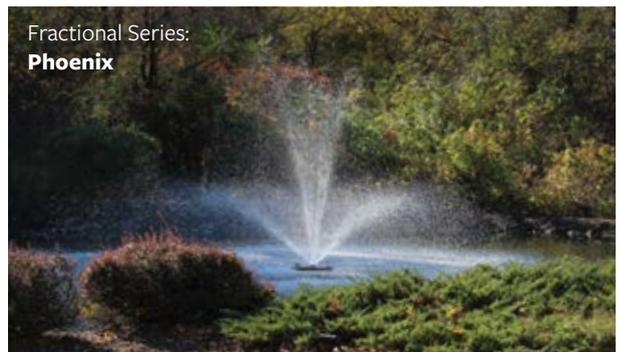

Giant Fountains Dramatic Displays



When you want to create a bold impression look to any of the patterns found within Otterbine's Giant Fountain line. Often specified by landscape architects and designers, these floating fountains create sensational displays wherever they are found.

Premier locations throughout the world, from resorts and country clubs to corporate headquarters, select these systems because of their beauty, versatility and quality. From the staggering 90ft or 27m height of



“Otterbine was very helpful in the design and specification aspects of our water feature project. A company representative did a site inspection and helped with a product recommendation and design within days of our inquiry.”

**—Richard H. Brooks,
Brooks Development Group**

our Super Nova to the magnificent multi-dimensional cascading pattern of the Equinox—onlookers are mesmerized by the magnificence of these fountains.

Constructed for ease of use, the Giant Fountain line allows for shallow operating depths of only 40in or 1m, while large wheels on the frame improves mobility eliminating the need for hoists and cranes in most instances. Combine this with corrosion resistant materials, a unique screening system to simplify cleaning and an adjustable float to minimize visibility in the water—these units are virtually maintenance free. Better

yet they are backed by an all-inclusive 2-year warranty that can be increased to a 3-year warranty when purchased with power monitoring Subtrols.

Prolong the beauty of a Giant Fountain with the addition of our Fountain Glo light systems. From our energy efficient LED lights to our color-changing RGBW sequencing light systems, create awe-inspiring displays to further captivate from day into night.

Specifications and CAD drawings can be found through our website at www.otterbine.com.



TRIAD

60 Hz	10HP	15HP	25HP
Spray Height (ft)	36	40	50
Spray Diameter (ft)	33	37	42
GPM	300	390	500
50 Hz	10HP	15HP	25HP
Spray Height (m)	10.4	11.6	14.3
Spray Diameter (m)	9.4	10.7	12.2
m ³ /hr	68.1	88.5	113.5



EQUINOX

60 Hz	10HP	15HP	25HP
Spray Height (ft)	28	31	41
Spray Diameter (ft)	80	85	106
GPM	300	390	500
50 Hz	10HP	15HP	25HP
Spray Height (m)	8	9	12
Spray Diameter (m)	24	25	32
m ³ /hr	68	88	113



AQUASTAR

60 Hz	10HP	15HP	25HP
Spray Height (ft)	36	40	50
Spray Diameter (ft)	33	37	42
GPM	225	350	400
50 Hz	10HP	15HP	25HP
Spray Height (m)	10.4	11.6	14.3
Spray Diameter (m)	9.4	10.7	12.2
m ³ /hr	51.1	79.5	90.8



MYSTIC

60 Hz	10HP	15HP	25HP
Spray Height (ft)	40	50	65
Spray Diameter (ft)	6	6	6
GPM	450	500	800
50 Hz	10HP	15HP	25HP
Spray Height (m)	11.6	14.3	18.9
Spray Diameter (m)	1.8	1.8	1.8
m ³ /hr	102.2	113.5	181.6



SUPERNOVA

60 Hz	10HP	15HP	25HP
Spray Height (ft)	55	70	95
Spray Diameter (ft)	1	1	1
GPM	225	350	400

50 Hz	10HP	15HP	25HP
Spray Height (m)	15.8	20.1	27.4
Spray Diameter (cm)	30	30	30
m ³ /hr	51.1	79.5	90.8



POLARIS

60 Hz	10HP	15HP	25HP
Spray Height (ft)	27	30	35
Spray Diameter (ft)	13	8	8
GPM	675	750	1,200

50 Hz	10HP	15HP	25HP
Spray Height (m)	7	8.5	10.1
Spray Diameter (m)	2.4	2.4	2.4
m ³ /hr	153.2	170.3	272.4



ARIES

60 Hz	10HP	15HP	25HP
Spray Height (ft)	27	30	37
Spray Diameter (ft)	85	101	121
GPM	300	390	500

50 Hz	10HP	15HP	25HP
Spray Height (m)	7	8	10
Spray Diameter (m)	24	28	33
m ³ /hr	68	88	113

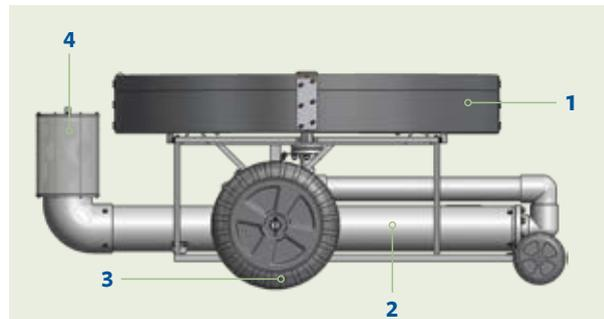

PRODUCT ILLUSTRATION

- 1 Special polyethylene float allows for easy height adjustment to make it less visible in the water.
- 2 High quality Grundfos pump and Franklin 3450/2875 RPM motor ensure years of corrosion-resistant, trouble-free run time and no maintenance.
- 3 Large center wheels assist installation and removal eliminating the need for a crane in most applications.
- 4 Removable stainless steel intake screen allows for cleaning in the water and protects pump from debris.

Dimensions: 10HP & 15HP = 100in (254cm) x 74in (188cm) x 40in (102cm); 25HP: 120in (305cm) x 90in (229cm) x 40in (102cm).

Complete package is safety tested, approved and listed with ETL and ETL-C. Products for the European Union are also safety tested, approved, and carry CE certification. Minimum operating depth is 40in or 1m, with and without lights. See www.otterbine.com for product testing and package details.

From Commercial Sites to Recreational Parks

Giant Fountain:
Polaris



Aerating Fountain:
Phoenix

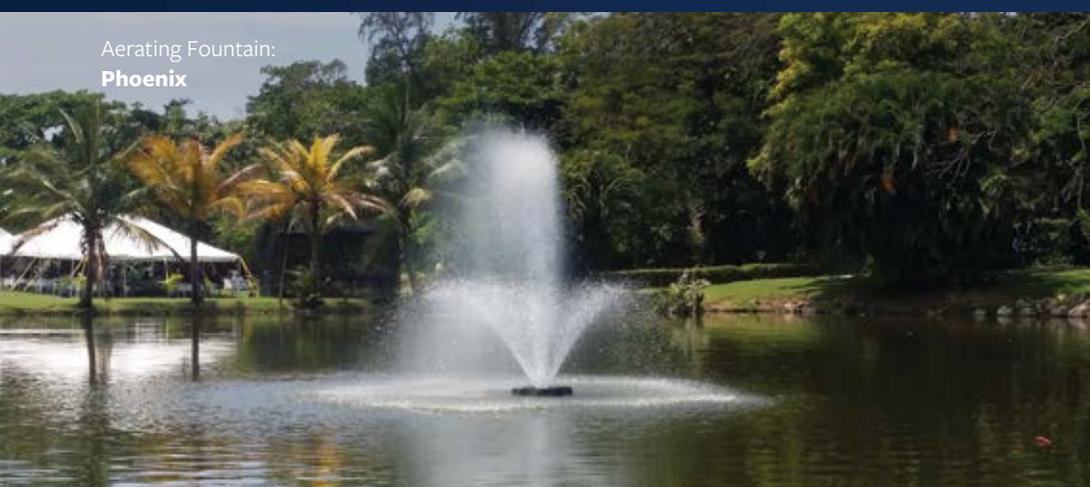

Aerating Fountain:
Gemini



Industrial Aerator:
High Volume

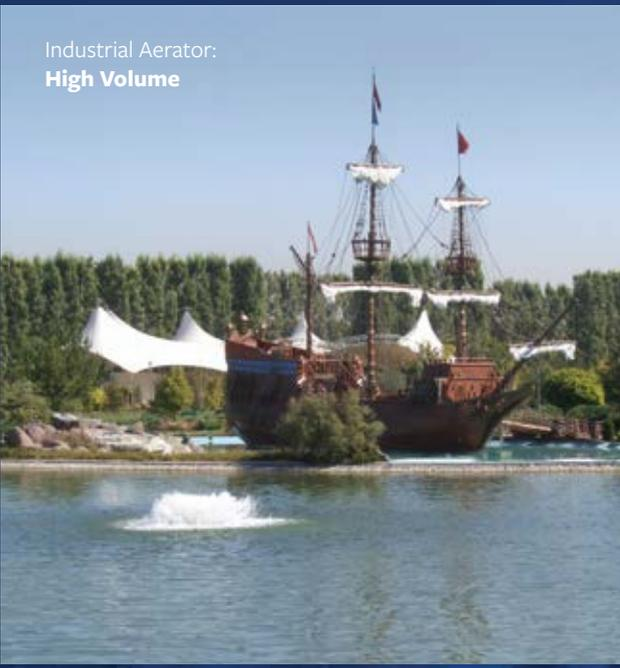

Fractional Series:
Gemini



Aerating Fountain:
Equinox



Aerating Fountain:
Sunburst



Fountain Glo™ Lighting Enhancing Displays into the Night

The perfect addition to any Otterbine spray pattern, our lighting systems come in a variety of configurations to create radiant displays once the sun sets. All manufactured from corrosion resistant materials and featuring energy efficient LED lamps—there is bound to be one that suits your needs.

Our most popular LED light system is available in both cool and warm lamps, from 2 lights to 16 — creating rich, vibrant displays. While our ultra-bright compact color changing RGBW sequencing light sets are the perfect addition if you are looking to spice up your display for that extra special something. These 4-light LED systems are available in 40W for our 1-5HP systems, 80W for our 10HP+ fountains and come with 24 pre-programmed sequences with the option of adding custom programs upon request.

High Voltage light systems are also available, check out our website to learn more.



LOW VOLTAGE (LED)

Lights	2	4	6	8*	12*	16*
Lamp Wattage (Total)	14	28	42	56	84	112
Lamp Options	2	4	6	8*	12*	16*
Bright White (Lumens)	970	1,940	2,910	3,880	5,820	7,760
Warm White (Lumens)	700	1,400	2,100	2,800	4,200	5,600

*Multiple cable runs required (One cable run required for every four lights.)

**3HP Gemini & 3HP Rockets
with Low Voltage Lights**

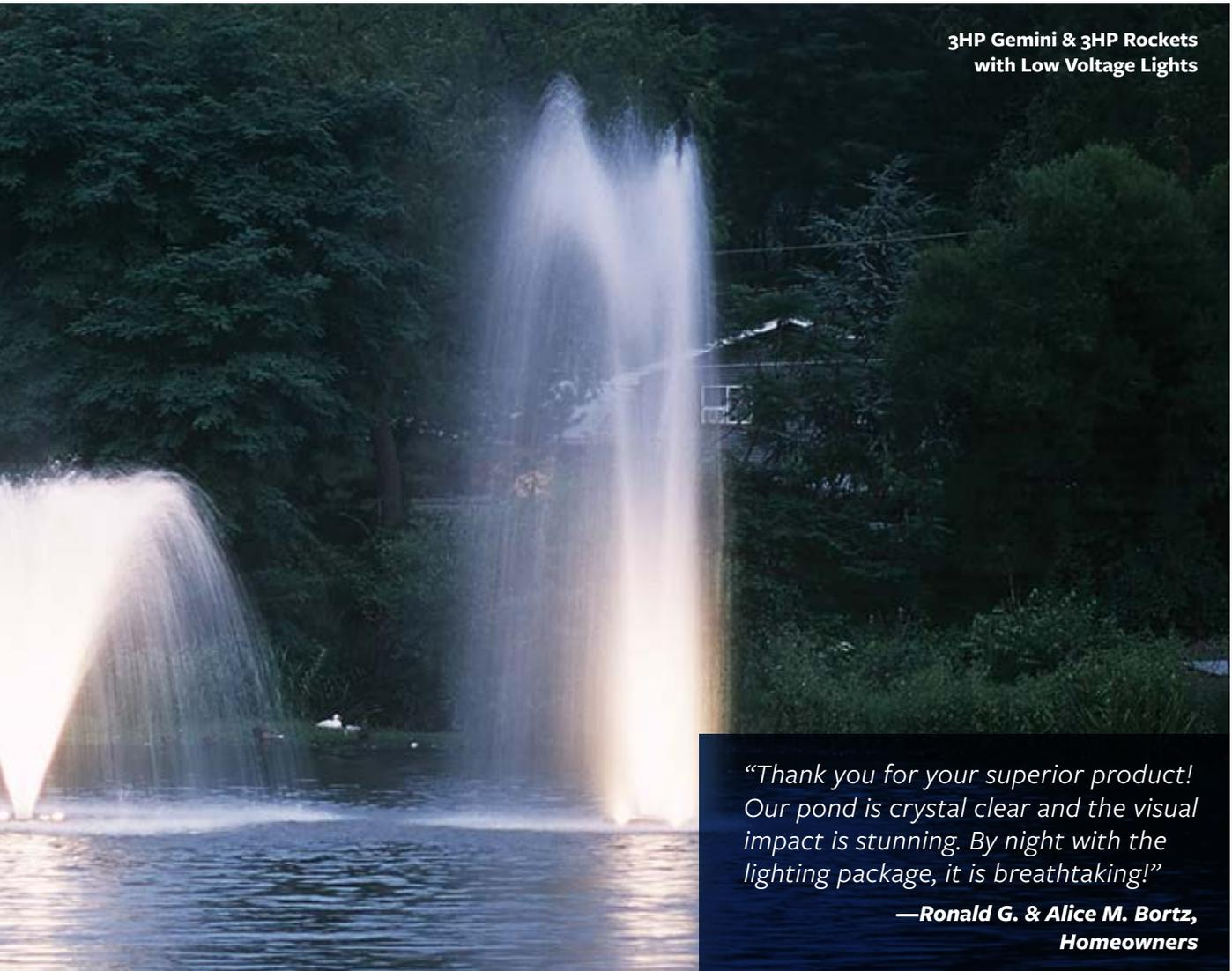

“Thank you for your superior product! Our pond is crystal clear and the visual impact is stunning. By night with the lighting package, it is breathtaking!”

**—Ronald G. & Alice M. Bortz,
Homeowners**



MR16 LED Low Voltage



RGBW SEQUENCING LIGHTS (LED)

RGBW Lighting	40W	80W
Lamp Wattage (Total)	150	331

All RGBW Light Systems include 4 light fixtures.



40W Lamp



80W Lamp

Model	Lumens (per single fixture)							
	Minimum				Maximum			
	Red	Green	Blue	White	Red	Green	Blue	White
40W	260	300	77	430	420	480	130	620
80W	600	720	172	1250	940	1130	270	1960

System Sizing & Selection



GENERAL RULE OF THUMB:

2 HP PER SURFACE ACRE

Properly planned aeration systems can have a dramatic effect on the health of your pond or lake. It's important to take time in identifying your specific needs, along with other site conditions related to your water feature; not only will it help in product selection but it will ultimately contribute to the success of your aerator or fountain system. Before you make your initial investment, you'll want to consider:

WHAT PRODUCT IS BEST: Aeration vs. decorative; surface vs. sub-surface—depending on your goal these considerations will help you in product selection.

KNOW YOUR POND & SITE REQUIREMENTS: Know the four factors that can impact your decision: Surface Area, Depth, Quality of Incoming Water, and Available Power.

SYSTEM SIZING & PLACEMENT: Pond size, shape and depth will play a large part in determining the size of your system, especially when looking for aeration. Refer to the System Sizing per Surface Acre table and Product Placement guide on this page for assistance. When your goal is to improve water quality it is imperative that your system is properly sized to deliver the optimal aeration.

These are just some initial guidelines in product selection, please feel free to contact us with any specific questions you may have.

HP REQUIREMENT BY PRODUCT LINE SYSTEM SIZING per SURFACE ACRE

1 to 1.5HP	1.5HP	2HP	3HP
HIGH VOLUME* (Industrial Aerator)	AERATING FOUNTAINS* (Sunburst, Gemini, Saturn)	MIXERS/ CIRCULATORS	AERATING FOUNTAINS (All Decorative Patterns)
	ASPIRATORS		

*In severe aquatic conditions multiply the HP requirement by 2. Air Flo systems use a different sizing matrix utilizing depth and surface area. For details visit us at www.otterbine.com to view the sizing guide online. Giant Fountain sizing is based on preference for pattern display and dimensions.

Hours of Operation		
Severe Lake Management	Average Lake Management	Basic Lake Management
24hrs/day	12-16hrs/day*	6-8hrs/day

Additional considerations are required in areas that experience prolonged periods of freezing.
 * Increase operational hours as outside temperatures & daylight hours increase.
 * Night (dark) is the optimal time to operate aeration systems for water quality management purposes.

HOW POND SHAPE IMPACTS PRODUCT PLACEMENT

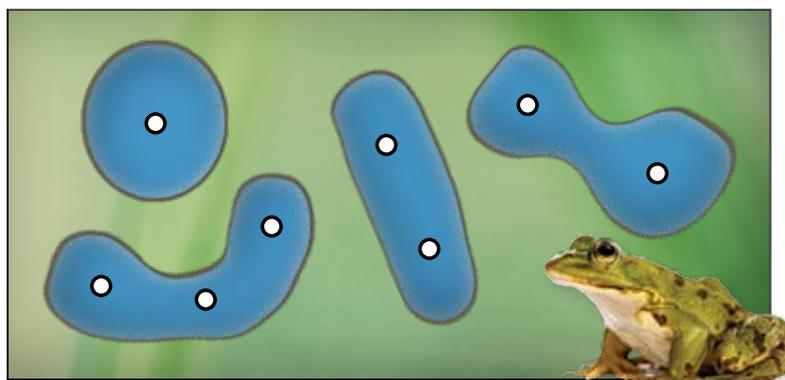

This is a reference to illustrate placement of units to achieve optimal results when aeration is your primary objective. For best results break HP requirements into smaller units and space throughout the water feature.



Technical Specifications 60Hz

60Hz

AERATING FOUNTAIN SPECS (1HP-5HP)

Specs			Max Cable Runs							
HP	Electrical Rating	Amp Draw	12AWG / 4mm ²		10AWG / 6mm ²		8AWG / 10mm ²		6AWG / 16mm ²	
1	115V 1Ph	14	—	—	150 ft.	46 m	250 ft.	76 m	—	—
1	208 / 230V 1Ph	8.3 / 7.5	300 / 375 ft.	91 / 114 m	500 / 600 ft.	152 / 183 m	800 / 975 ft.	244 / 297 m	—	—
2	208 / 230V 1Ph	13.7 / 12.4	175 / 225 ft.	53.3 / 69 m	300 / 375 ft.	92 / 114 m	475 / 575 ft.	145 / 175 m	750 / 925 ft.	229 / 282 m
3	208 / 230V 1Ph	15.5 / 14	—	—	250 / 325 ft.	76 / 99 m	425 / 525 ft.	130 / 160 m	675 / 825 ft.	206 / 251 m
3	208 / 230V 3Ph	9.7 / 8.6	300 / 375 ft.	91 / 114 m	500 / 625 ft.	152 / 191 m	800 / 975 ft.	244 / 297 m	—	—
3	460V 3Ph	4.3	1000	305 m	—	—	—	—	—	—
5	230V 1Ph	23	—	—	—	—	300 ft.	91 m	500 ft.	152 m
5	208 / 230V 3Ph	15.1 / 13.4	200 / 250 ft.	61 / 72 m	300 / 400 ft.	92 / 122 m	500 / 625 ft.	152 / 191 m	—	—
5	460V 3Ph	7.2	925 ft.	282 m	1000 ft.	305 m	—	—	—	—
5	575V 3Ph	5.5	1000 ft.	305	—	—	—	—	—	—

INDUSTRIAL AERATOR SPECS (1HP-5HP)

Specs			Max Cable Runs							
HP	Electrical Rating	Amp Draw	12AWG / 4mm ²		10AWG / 6mm ²		8AWG / 10mm ²		6AWG / 16mm ²	
1	115V 1Ph	13.4	—	—	150 ft.	46 m	250 ft.	76 m	—	—
1	208 / 230V 1Ph	6.8	375 / 425 ft.	114 / 130 m	600 / 675 ft.	183 / 206 m	950 / 1000 ft.	290 / 305 m	—	—
2	208 / 230V 1Ph	11.9	200 / 225 ft.	61 / 69 m	325 / 375 ft.	99 / 114 m	525 / 600 ft.	160 / 183 m	825 / 925 ft.	251 / 282 m
3	208 / 230V 1Ph	13.5	—	—	275 / 325 ft.	84 / 99 m	450 / 500 ft.	137 / 152 m	725 / 800 ft.	221 / 244 m
3	208 / 230V 3Ph	8.5	350 / 375 ft.	107 / 114 m	550 / 625 ft.	168 / 191 m	900 / 1000 ft.	274 / 305 m	—	—
3	460V 3Ph	4.2	1000 ft.	305 m	—	—	—	—	—	—
5	208 / 230V 3Ph	14.4	200 / 225 ft.	61 / 69 m	325 / 350 ft.	99 / 107 m	500 / 575 ft.	152 / 175 m	—	—
5	460V 3Ph	7.5	900 ft.	274 m	1000 ft.	305 m	—	—	—	—
5	575V 3Ph	6	1000 ft.	305 m	—	—	—	—	—	—

GIANT FOUNTAIN SPECS (10HP-25HP)

Specs			Max Cable Runs							
HP	Electrical Rating	Amp Draw	10AWG / 6mm ²		8AWG / 10mm ²		6AWG / 16mm ²		4AWG / 25mm ²	
10	230V 1Ph	47	—	—	—	—	250 ft.	76 m	375 ft.	114 m
10	208V 3Ph	34.5	—	—	225 ft.	69 m	350 ft.	107 m	575 ft.	175 m
10	230V 3Ph	30	—	—	275 ft.	84 m	450 ft.	137 m	700 ft.	213 m
10	460V 3Ph	15	700 ft.	213 m	1000 ft.	305 m	—	—	—	—
15	230V 1Ph	67	—	—	—	—	—	—	275 ft.	84 m
15	208V 3Ph	51	—	—	—	—	250 ft.	76 m	375 ft.	114 m
15	230V 3Ph	44	—	—	—	—	300 ft.	91 m	475 ft.	145 m
15	460V 3Ph	22	475 ft.	145 m	775 ft.	236 m	1000 ft.	305 m	—	—
25	208V 3Ph	81	—	—	—	—	—	—	250 ft.	76 m
25	230V 3Ph	70	—	—	—	—	—	—	300 ft.	91 m
25	460V 3Ph	35	—	—	475 ft.	145 m	775 ft.	236 m	1000 ft.	305 m

FRACTIONAL SERIES SPECS (1/2HP)

Specs			Max Cable Runs	
HP	Electrical Rating	Amp Draw	12AWG / 4mm ²	
1/2	115V 1Ph	6	300 ft.	91 m
1/2	230V 1Ph	3	600 ft.	183 m

RGBW SEQUENCE LIGHTING SPECS

Specs				Max Cable Runs			
Watts	Lights per Set	Max Amp Draw	Output Electrical Rating	12AWG / 4mm ²		10AWG / 6mm ²	
40W	4	115V 1Ph 1.9A	30VDC	600 ft.	183 m	1000 ft.	305 m
80W	4	115V 1Ph 4.2A	30VDC	600 ft.	183 m	1000 ft.	305 m

LED LIGHTING SPECS

Specs				Max Cable Runs			
Watts	Lights per Set	Amp Draw	Output Electrical Rating	16AWG/1.5mm ²		12AWG/4mm ²	
7	2 (FRAC)	115V 1Ph .15A	12VDC	150v	46 m	300 ft.	91 m
7	2	115V 1Ph .18A	15VDC	650 ft.	198 m	1000 ft.	305 m
7	4	115V 1Ph .35A	15VDC	325 ft.	99 m	700 ft.	213 m
7	6	115V 1Ph .53A	15VDC	225 ft.	69 m	525 ft.	160 m
7	8*	115V 1Ph .70A	15VDC	325 ft.	99 m	700 ft.	213 m
7	12*	115V 1Ph 1.06A	15VDC	325 ft.	99 m	700 ft.	213 m
7	16*	115V 1Ph 1.44A	15VDC	325 ft.	99 m	700 ft.	213 m

*Multiple cable runs required (one for every four lights)

Technical Specifications 50Hz

AERATING FOUNTAIN SPECS (1HP-5HP)

Specs			Max Cable Runs					
HP	Electrical Rating	Amp Draw	12AWG / 4mm ²		10AWG / 6mm ²		8AWG / 10mm ²	
1	220V 1Ph	8.3	325 ft.	99 m	525 ft.	160 m	850 ft.	260 m
2	220V 1Ph	12.6	200 ft.	61 m	350 ft.	107 m	550 ft.	168 m
3	220V 1Ph	13.5	—	—	325 ft.	99 m	525 ft.	160 m
3	380 / 415V 3Ph	4	1000 ft.	305 m	—	—	—	—
5	380 / 415V 3Ph	7	775 / 850 ft.	236 / 259 m	1000 ft.	305 m	—	—

INDUSTRIAL AERATOR SPECS (1HP-5HP)

Specs			Max Cable Runs					
HP	Electrical Rating	Amp Draw	12AWG / 4mm ²		10AWG / 6mm ²		8AWG / 10mm ²	
1	220-240V 1Ph	8	350 ft.	107 m	550 ft.	168 m	875 ft.	267 m
2	220-240V 1Ph	12	225 ft.	69 m	350 ft.	107 m	575 ft.	175 m
3	220-240V 1Ph	14	—	—	300 ft.	91 m	500 ft.	152 m
3	380 / 415V 3Ph	4.2	1000 ft.	305 m	—	—	—	—
5	380 / 415V 3Ph	7.2	775 / 850 ft.	236 / 259 m	1000 ft.	305 m	—	—

GIANT FOUNTAINS SPECS (10HP-25HP)

Specs			Max Cable Runs							
HP	Electrical Rating	Amp Draw	10AWG / 6mm ²		8AWG / 10mm ²		6AWG / 16mm ²		4AWG / 25mm ²	
10	380 / 415V 3Ph	16	550 / 600 ft.	168 / 183 m	850 / 950 ft.	259 / 290 m	1000 ft.	305 m	—	—
15	380 / 415V 3Ph	24	350 / 400 ft.	107 / 122 m	575 / 625 ft.	175 / 191 m	900 / 1000 ft.	274 / 305 m	—	—
25	380 / 415V 3Ph	40	—	—	350 / 375 ft.	107 / 114 m	550 / 600 ft.	168 / 183 m	850 / 950 ft.	259 / 290 m

FRACTIONAL SERIES SPECS (1/2HP)

Specs			Max Cable Runs				
HP	Electrical Rating	Running Amps	12AWG / 4mm ²				
1/2	220V 1Ph	2.8	600 ft.				183 m

RGBW SEQUENCE LIGHTING SPECS

Specs				Max Cable Runs			
Watts	Lights per Set	Max Amp Draw	Output Electrical Rating	12AWG / 4mm ²		10AWG / 6mm ²	
40W	4	220V 1Ph 1.0A	30VDC	600 ft.	183 m	1000 ft.	305 m
80W	4	220V 1Ph 2.1A	30VDC	600 ft.	183 m	1000 ft.	305 m

LED LIGHTING SPECS

Specs				Max Cable Runs			
Watts	Lights per Set	Amp Draw	Output Electrical Rating	16AWG / 1.5mm ²		12AWG / 4mm ²	
7	2	220V 1Ph 0.08A	12VDC	150 ft.	46 m	300 ft.	91 m
7	2	220V 1Ph 0.09A	15VDC	650 ft.	198 m	1000 ft.	305 m
7	4	220V 1Ph 0.18A	15VDC	325 ft.	99 m	700 ft.	213 m
7	6	220V 1Ph 0.27A	15VDC	225 ft.	69 m	525 ft.	160 m
7	8*	220V 1Ph 0.35A	15VDC	325 ft.	99 m	700 ft.	213 m
7	12*	220V 1Ph 0.53A	15VDC	325 ft.	99 m	700 ft.	213 m
7	16*	220V 1Ph 0.72A	15VDC	325 ft.	99 m	700 ft.	213 m

*Multiple cable runs required (one for every four lights)





OTTERBINE® BAREBO, INC.
3840 Main Road East, Emmaus, PA 18049, U.S.A.
PHONE: 1-800-AER8TER | 610-965-6018
FAX: 610-965-6050 WEB: www.otterbine.com

