

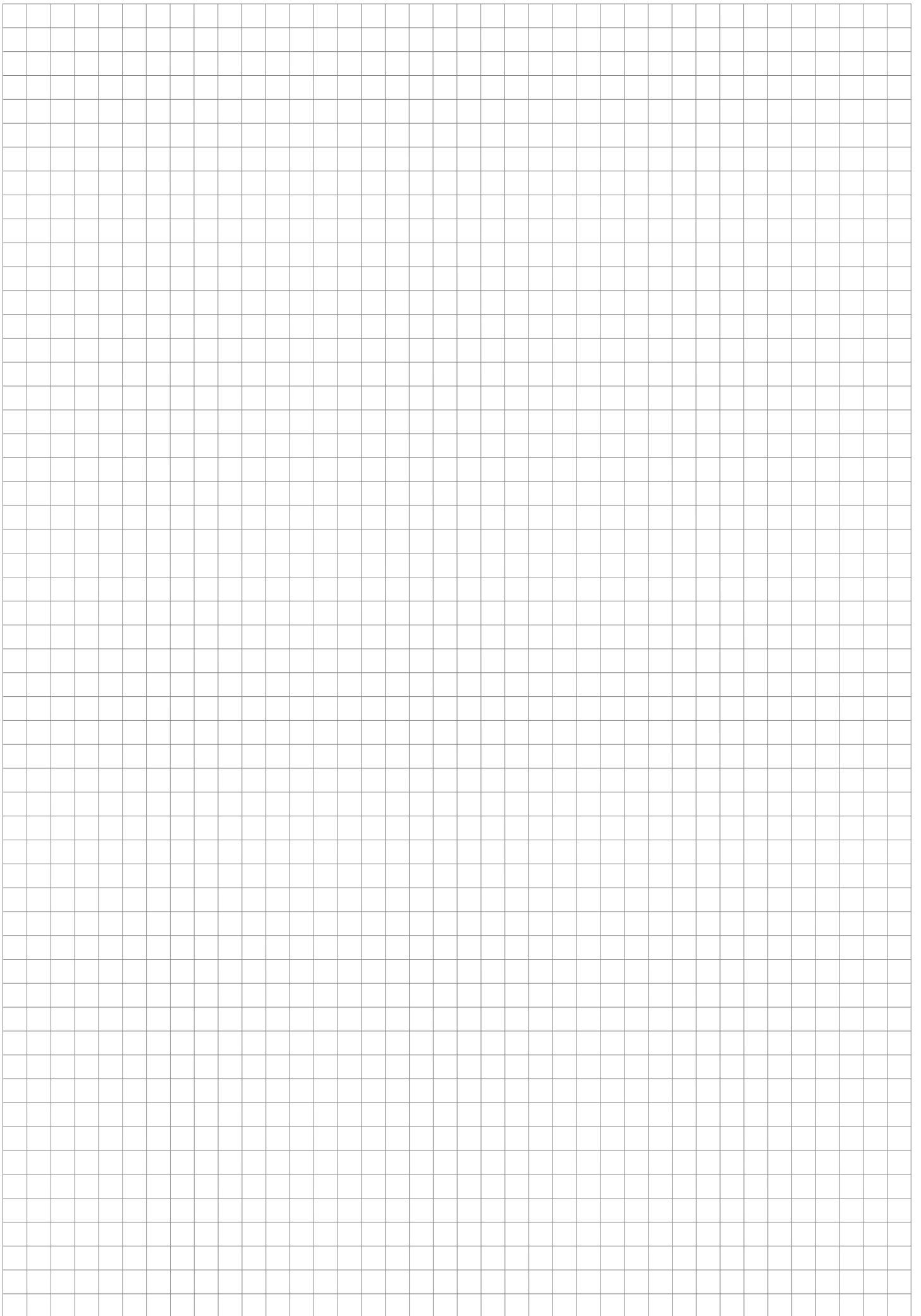

**Single outlet BODO,
wet maintenance floors**
Assembly instruction





Single outlet BODO, wet maintenance floors

Assembly instruction

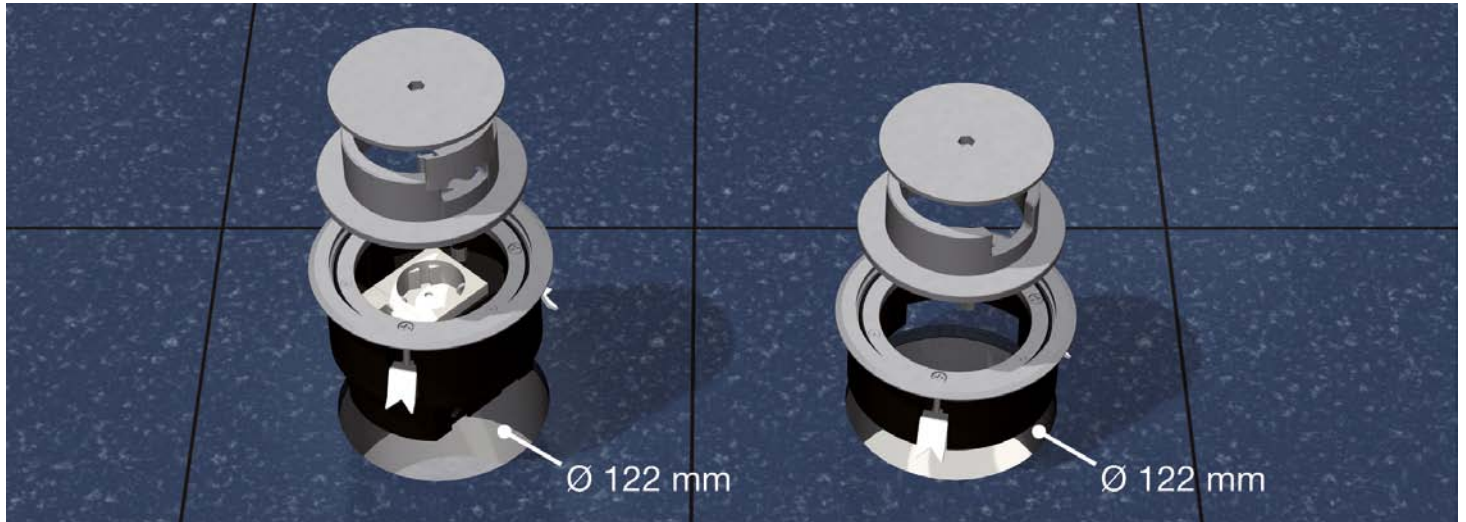

Round single outlet with protection frame made of aluminium, with an external diameter of 133 mm, equipped with an isolated ground receptacle and an RJ45 data socket (Legrand Typ Cat. 6A STP RJ45, 76573) or inspection chamber. For the installation into screed or raised floors. Other equipment options are available.



1 | Screed/raised floors

Create a floor opening in screed or raised floor by means of shuttering / drill bit or by using a hollow floor box with a shuttering unit.

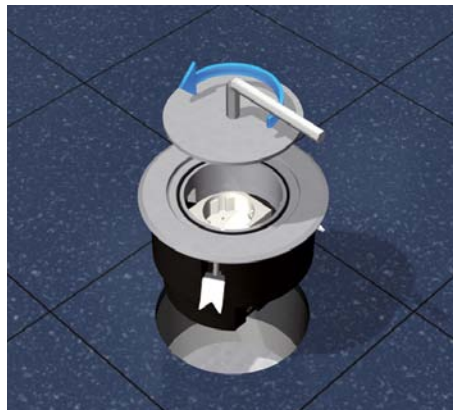

2 | Cover

Open cover with the enclosed socket wrench counter clock-wise.

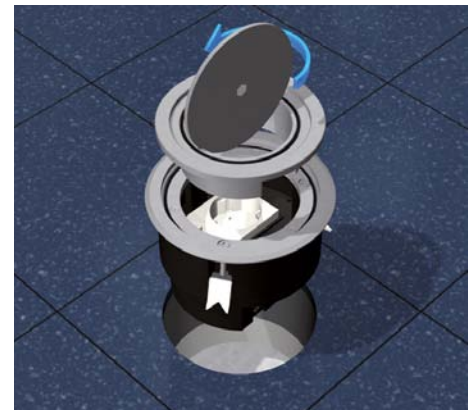

3 | Remove tube

Hinge the enclosed claws with corresponding screws into the notches in the frame. Bring claws to the right position and pull tight with a phillips screw. Make sure that the frame is solid.

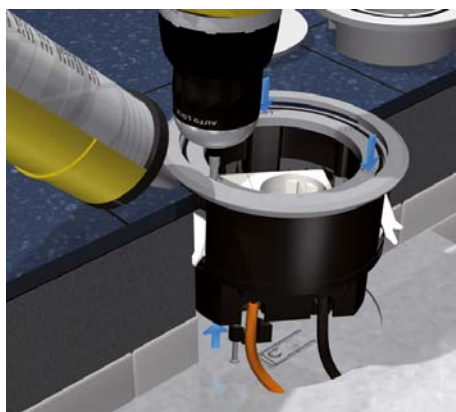

4 | Attach the frame and insert the strain relief

Protection frame has to seal accordingly when used in wet-maintained floors. Insert strain relief from below into the opening and secure the cable. Tighten the claws with cross-head screws.

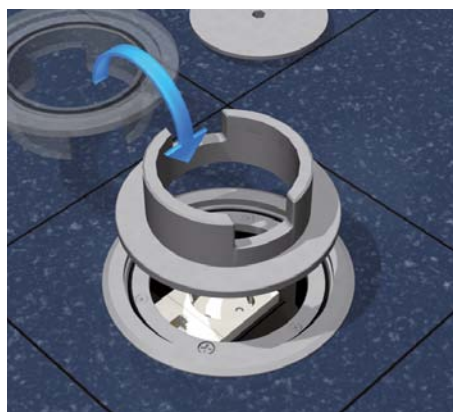

5 | Tube insert

Bring single-outlet from closed to open state by swivelling the tube insert by 180°. Insert the rubber protection sleeve for a dust-proof sealing.

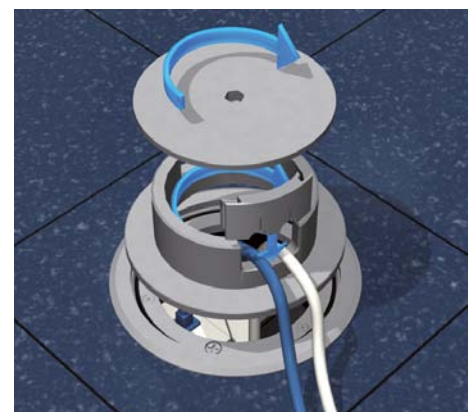

6 | Mounting

Insert straight or angle plug and bring out cables through cable outlet. Screw tube collet and tube cover tightly.



Errors and technical modification subject to change, reproduction as well as electronic duplication only with our written permission. With appearance of this print all preceding documents lose their validity.

