

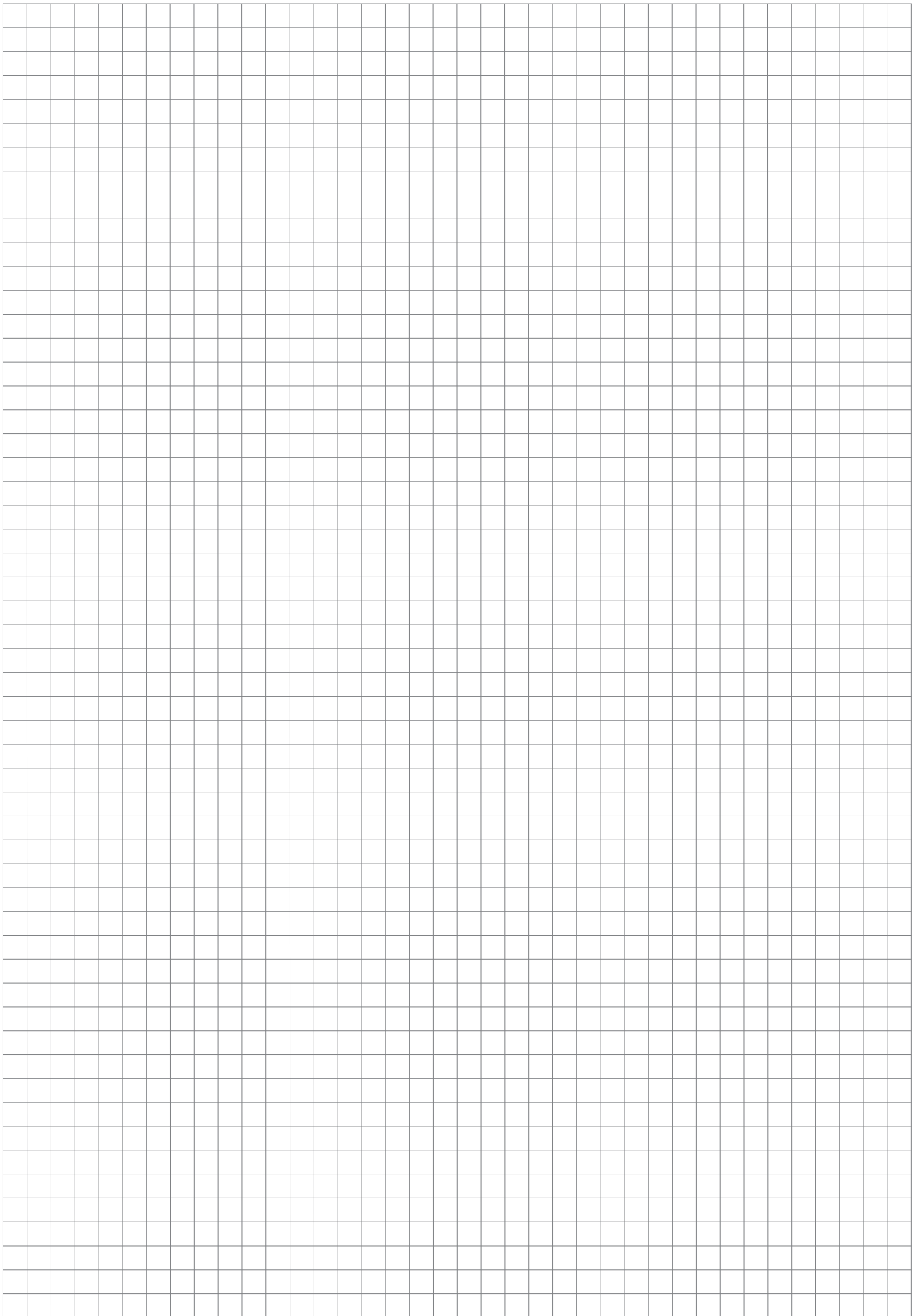

Cartridge units made of stainless steel, quadrangular

Assembly instruction





Cartridge unit made of stainless steel, quadrangular

Assembly instruction

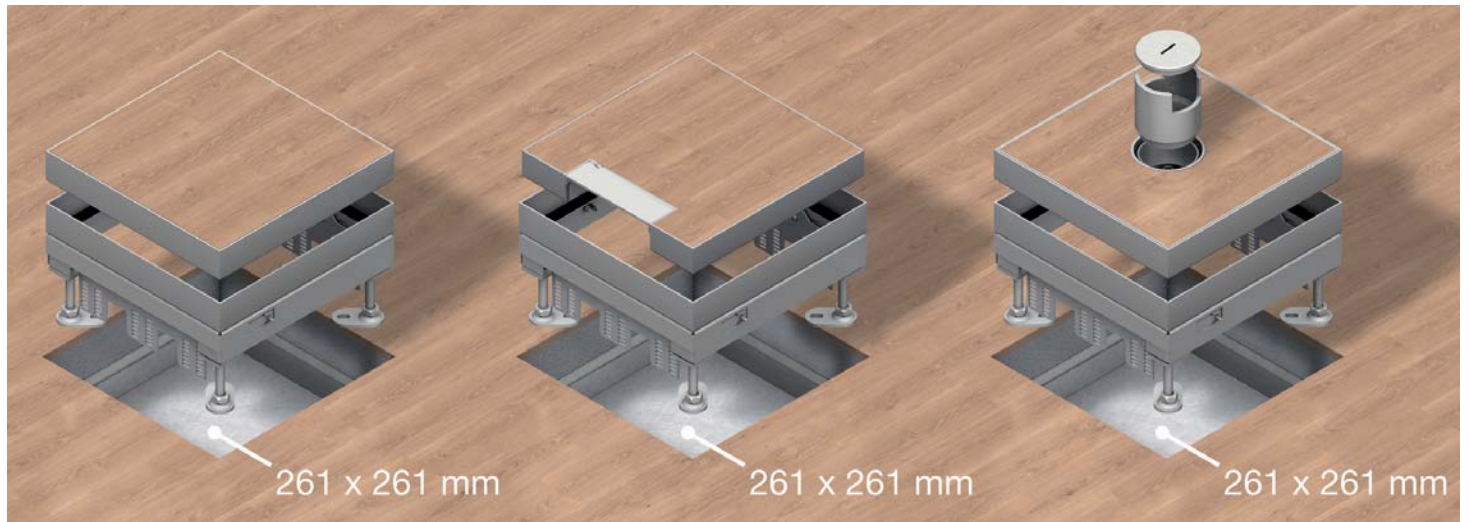

Quadrangular cartridge unit with hem, made of stainless steel, with the outside measurements of 261 x 261mm as a dummy cartridge unit, cable outlet cartridge unit and tube cartridge unit for the installation into screed and hollow floors. For 12/22/32/42 mm parquet and stone covers and linoleum in combination with rigid foam lid insert. Can be levelled from 65 to 315 mm.

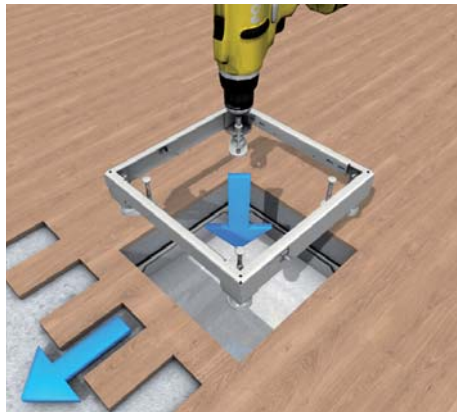

1 | Levelling device

For parquet or stone floors insert the levelling device into the floor opening. Fasten the four levelling bases with nail plugs.

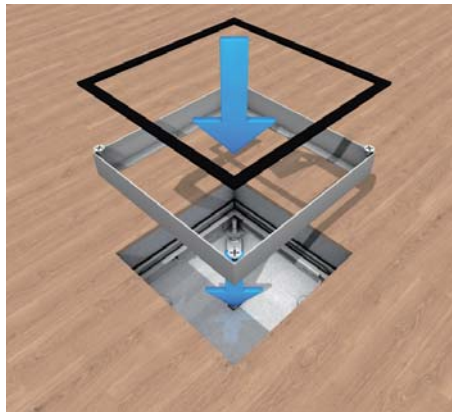

2 | Stainless steel frame

Screw the stainless steel frame to the levelling device with four screws. Glue rubber seal in place. Make the grounding connection between levelling device and floor box. A regular maintenance and cleaning of the seals is necessary.



3 | Floor adjustment

Align the installation frame flush to the level of the finished floor with four levelling screws. Seal expansion joint revolving with cork or sealing mass.

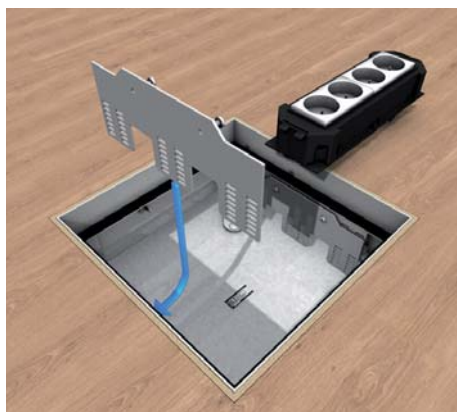

4 | Lock-in leads

Mount both lock-in leads with two screws each on the side of the frame. Create grounding connection between levelling device and floor box. When using a coupler plug $H = 35$ mm, comply with the minimum installation depth $H_{min} = 95$ mm.

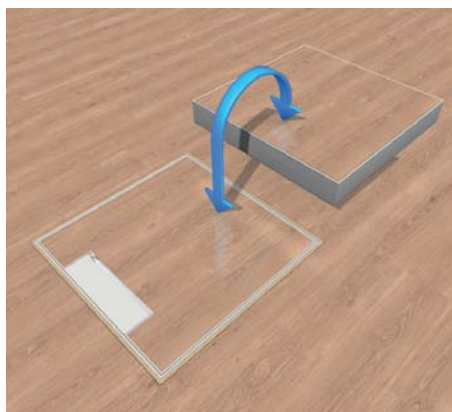

5 | Parquet cover

For damp maintenance floors such as parquet covers, use a dummy cartridge unit or a cable outlet cartridge unit. However, the floor cover depth must be considered. Insert the replaceable cartridge into the frame.

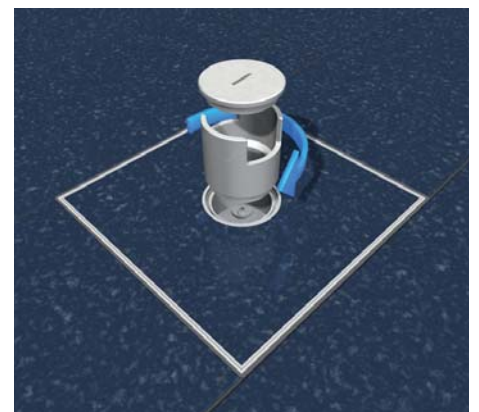

6 | Stone cover

For wet maintenance floor covers such as stone covers, only a tube cartridge unit may be used. However, the floor cover depth must be considered. Insert the replaceable cartridge into the frame. The tube can be screwed.



Errors and technical modification subject to change, reproduction as well as electronic duplication only with our written permission. With appearance of this print all preceding documents lose their validity.

