

TOTO®



ECOPOWER®  
BROCHURE



# ECOPOWER<sup>®</sup>

In today's fast paced world, the need for superior performance and reliability means everything. EcoPower is a state-of-the-art, eco-friendly technology that helps you save water, energy and money without sacrificing an ounce of performance.





## REDUCING WASTE. SAVING ENERGY.

A commercial fixture that performs better and requires less time, money and effort is TOTO's main goal. Since EcoPower products use the energy of running water to operate, there's no need for external power or routine battery change. This results in minimized maintenance and costs associated with expensive battery recycling programs, and a reduction of hazardous battery waste in our landfills.







Helix® M EcoPower Faucet  
Atherton™ Undercounter Lavatory  
Sensor Operated Soap Dispenser



# ECOPOWER® SENSOR FAUCET

Harness the Power of Water

Engineered to require no wired installation or routine battery replacement, EcoPower faucets are the perfect marriage of hands-free operation, low maintenance, easy installation and ecology.

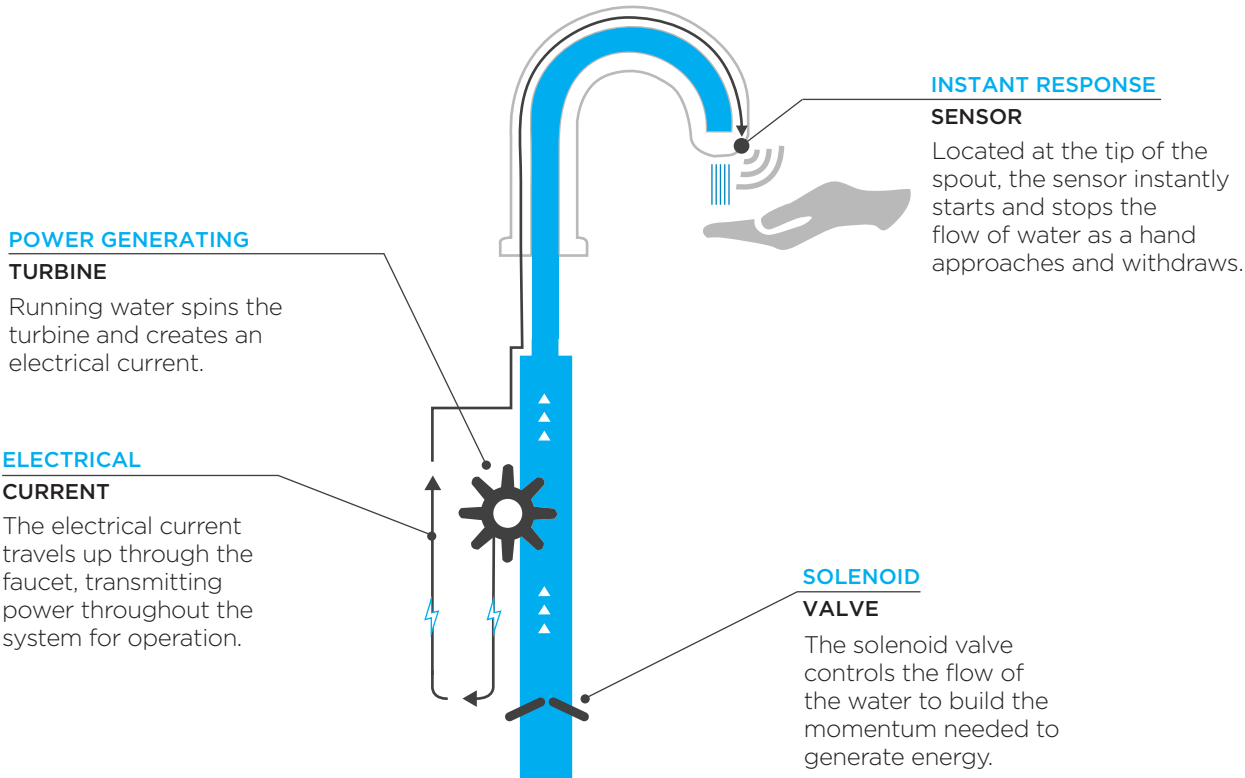

## PERFECTLY RESPONSIVE

### Smart Sensor Technology

Strategically located at the tip of the spout, the sensor is in an ideal location for the most effective response time.



### SMART SENSOR

An instant response time ensures the most efficient use of water. When a hand approaches, water instantly starts flowing, and when the hand withdraws, it instantly stops.

### CONVENTIONAL FAUCET

Conventional sensors are located at the base of the faucet, causing erratic water flow.

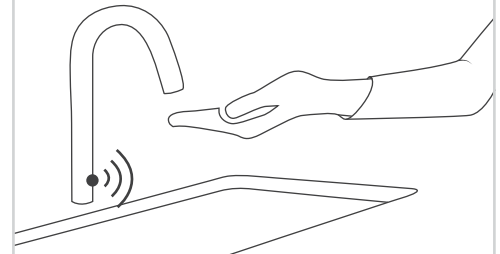

## EASY AS 1, 2, 3

### Hassle-free Installation

The EcoPower faucet controller box can be installed in three simple steps: screw, set and connect. No wires nor electricians needed.

**1** SCREW THE MOUNTING BRACKET ON TO THE WALL.

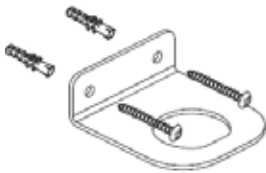

**2** SET THE CONTROLLER ONTO THE MOUNTING BRACKET AND SECURE IT WITH A NUT.

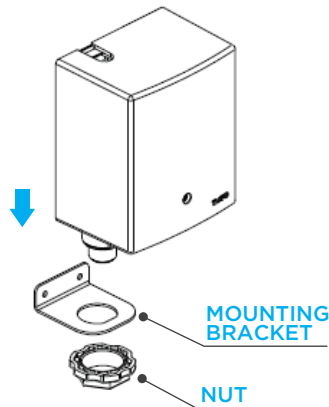

**3** CONNECT THE WATER SUPPLY HOSE.

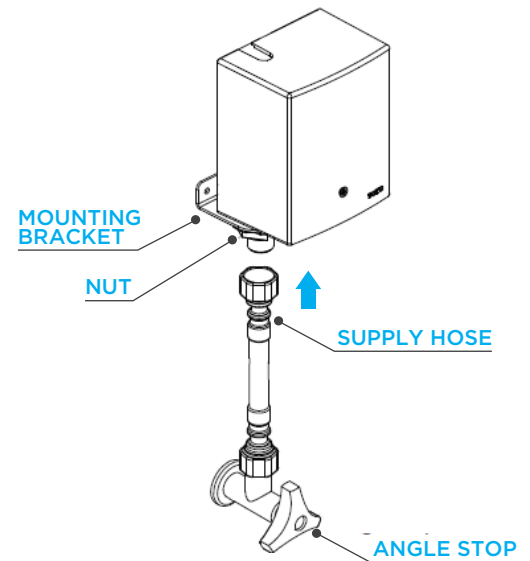

## ECOPOWER FAUCET FEATURES

Sustainable Energy, Powered By Water

EcoPower Faucets feature technologies that conserve water and energy and reduce maintenance costs.

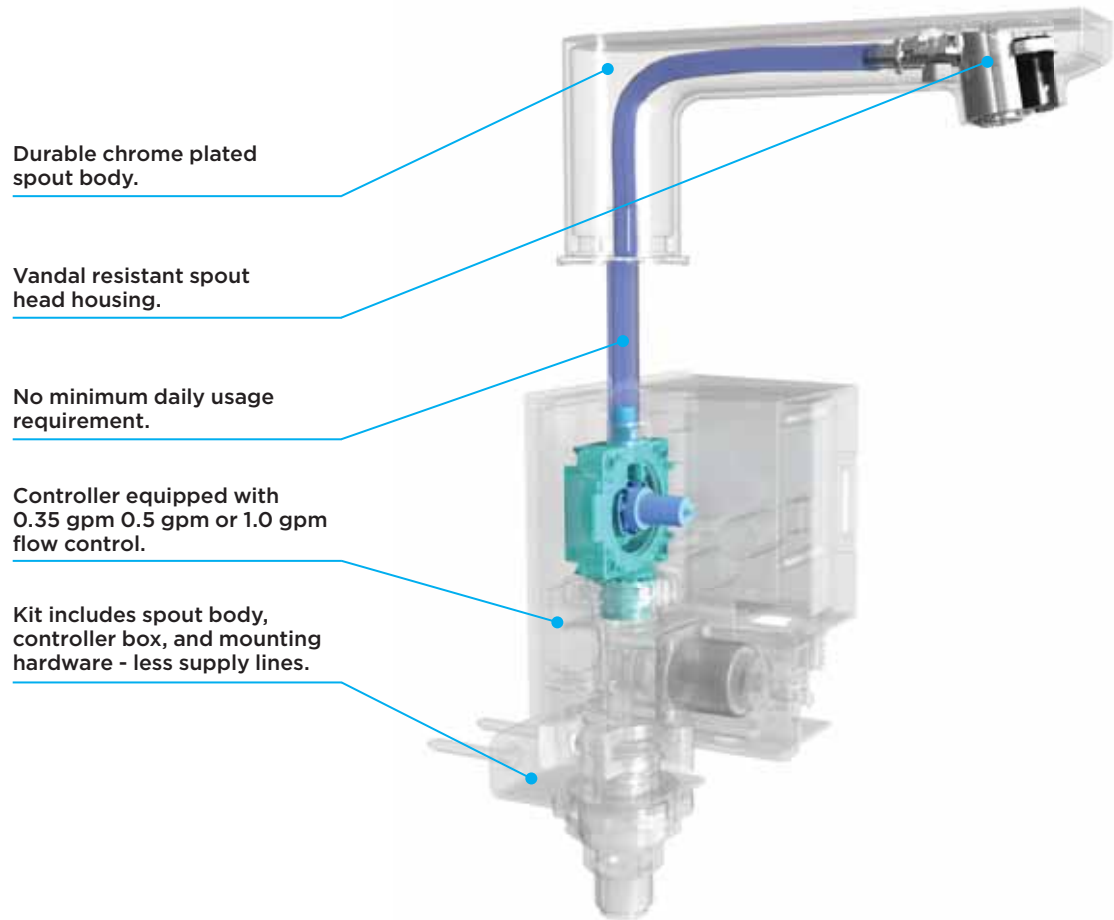



# ECOPOWER FAUCETS SINGLE-HOLE MOUNT



*\*Only applies to 0.35 gpm & 0.5 gpm commercial faucets.  
Refer to page 16 for the icon guide.  
\*\*Available Q1 2018*

### AXIOM® ECOPOWER FAUCET

- TEL143-D20E (0.35 GPM/0.11 GPC)
- TEL145-D10E (0.5 GPM/0.09 GPC)
- TEL145-C20E (0.5 GPM/0.19 GPC)
- TEL141-D10E (1.0 GPM/0.18 GPC)

### GOOSENECK ECOPOWER FAUCET

- \*\*TEL153-D20E (0.35 GPM/0.11 GPC)
- TEL155-D10E (0.5 GPM/0.09 GPC)
- TEL155-C20E (0.5 GPM/0.19 GPC)
- TEL151-D10E (1.0 GPM/0.18 GPC)

### HELIX® ECOPOWER FAUCET

- TEL113-D20E (0.35 GPM/0.11 GPC)
- TEL115-D10E (0.5 GPM/0.09 GPC)
- TEL115-C20E (0.5 GPM/0.19 GPC)
- TEL111-D10E (1.0 GPM/0.18 GPC)

### HELIX M ECOPOWER FAUCET

- TEL123-D20E (0.35 GPM/0.11 GPC)
- TEL125-D10E (0.5 GPM/0.09 GPC)
- TEL125-C20E (0.5 GPM/0.19 GPC)
- TEL121-D10E (1.0 GPM/0.18 GPC)

NEW 0.35 GPM



NEW 0.35 GPM



NEW 0.35 GPM



NEW 0.35 GPM

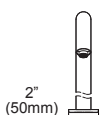
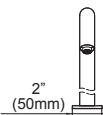
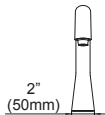
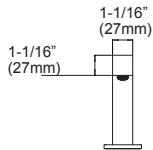
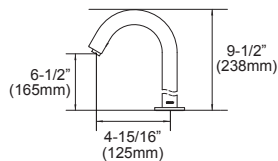
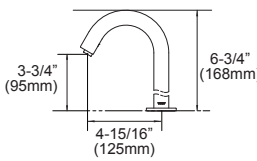
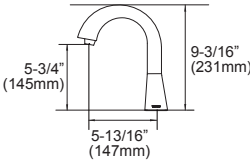
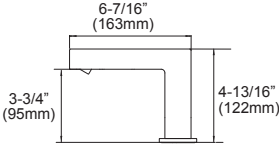

*These dimensions are subject to change without notice.*

# ECOPOWER FAUCETS SINGLE-HOLE MOUNT



\*Only applies to 0.35 gpm & 0.5 gpm commercial faucets.  
Refer to page 16 for the icon guide.  
\*\*Available Q1 2018

## LIBELLA™ ECOPOWER FAUCET

- \*\*TEL1A3-D20E (0.35 GPM/0.11 GPC)
- TEL1A5-D10E (0.5 GPM/ 0.09 GPC)
- TEL1A5-C20E (0.5 GPM/ 0.19 GPC)
- TEL1A1-D10E (1.0 GPM/0.18 GPC)

## LIBELLA M ECOPOWER FAUCET

- \*\*TEL1B3-D20E (0.35 GPM/0.11 GPC)
- TEL1B5-D10E (0.5 GPM/0.09 GPC)
- TEL1B5-C20E (0.5 GPM/0.19 GPC)
- TEL1B1-D10E (1.0 GPM/0.18 GPC)

## STANDARD ECOPOWER FAUCET

- TEL103-D20E (0.35 GPM/0.11 GPC)
- TEL105-D10E (0.5 GPM/0.09 GPC)
- TEL105-C20E (0.5 GPM/0.19 GPC)
- TEL101-D10E (1.0 GPM/0.18 GPC)

## INTEGRATED ECOPOWER FAUCET

- TEL5L1I5R (0.5 GPM/0.15 GPC)



NEW 0.35 GPM



NEW 0.35 GPM



NEW 0.35 GPM

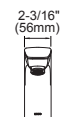
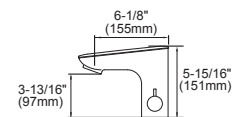
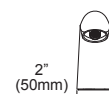
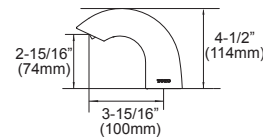
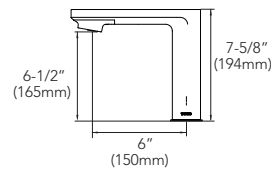
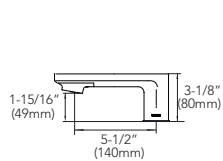

- ▶ Thermostatic mixer with Safety Thermo technology
- ▶ On-deck temperature control
- ▶ EcoPower system integrated within the spout

These dimensions are subject to change without notice.

# ECOPOWER FAUCETS WALL MOUNT



\*Only applies to 0.35 gpm & 0.5 gpm commercial faucets.  
Refer to page 16 for the icon guide.  
\*\*Available Q1 2018

## LIBELLA WALL-MOUNT ECOPOWER FAUCET

- \*\*TEL1C3-D10E (0.35 GPM/0.11 GPC)
- TEL1C5-D10E (0.5 GPM/0.09 GPC)
- TEL1C5-C20E (0.5 GPM/0.19 GPC)
- TEL1C1-D10E (1.0 GPM/0.18 GPC)

## LIBELLA WALL-MOUNT M ECOPOWER FAUCET

- \*\*TEL1D3-D20E (0.35 GPM/0.11 GPC)
- TEL1D5-D10E (0.5 GPM/0.09 GPC)
- TEL1D5-C20E (0.5 GPM/0.19 GPC)
- TEL1D1-D10E (1.0 GPM/0.18 GPC)

## GOOSENECK WALL-MOUNT ECOPOWER FAUCET

- \*\*TEL163-D20E (0.35 GPM/0.11 GPC)
- TEL165-D10E (0.5 GPM/0.09 GPC)
- TEL165-C20E (0.5 GPM/0.19 GPC)
- TEL161-D10E (1.0 GPM/0.18 GPC)

## HELIX® WALL-MOUNT ECOPOWER FAUCET

- TEL133-D20E (0.35 GPM/0.11 GPC)
- TEL135-D10E (0.5 GPM/0.09 GPC)
- TEL135-C20E (0.5 GPM/0.19 GPC)
- TEL131-D10E (1.0 GPM/0.18 GPC)

NEW 0.35 GPM



NEW 0.35 GPM



NEW 0.35 GPM



NEW 0.35 GPM

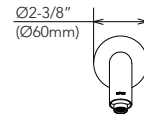
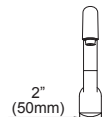
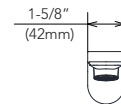
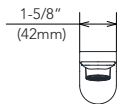
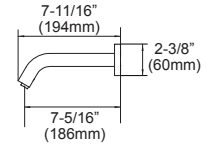
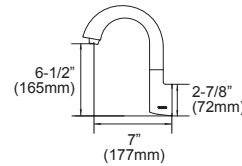
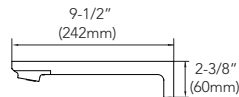
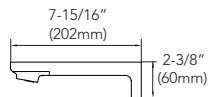

These dimensions are subject to change without notice.

## ECOPOWER FLUSH VALVE FEATURES

Sustainable Energy, Powered By Water

EcoPower Flush Valves provide superior performance in high-traffic areas with features that increase water and energy savings.

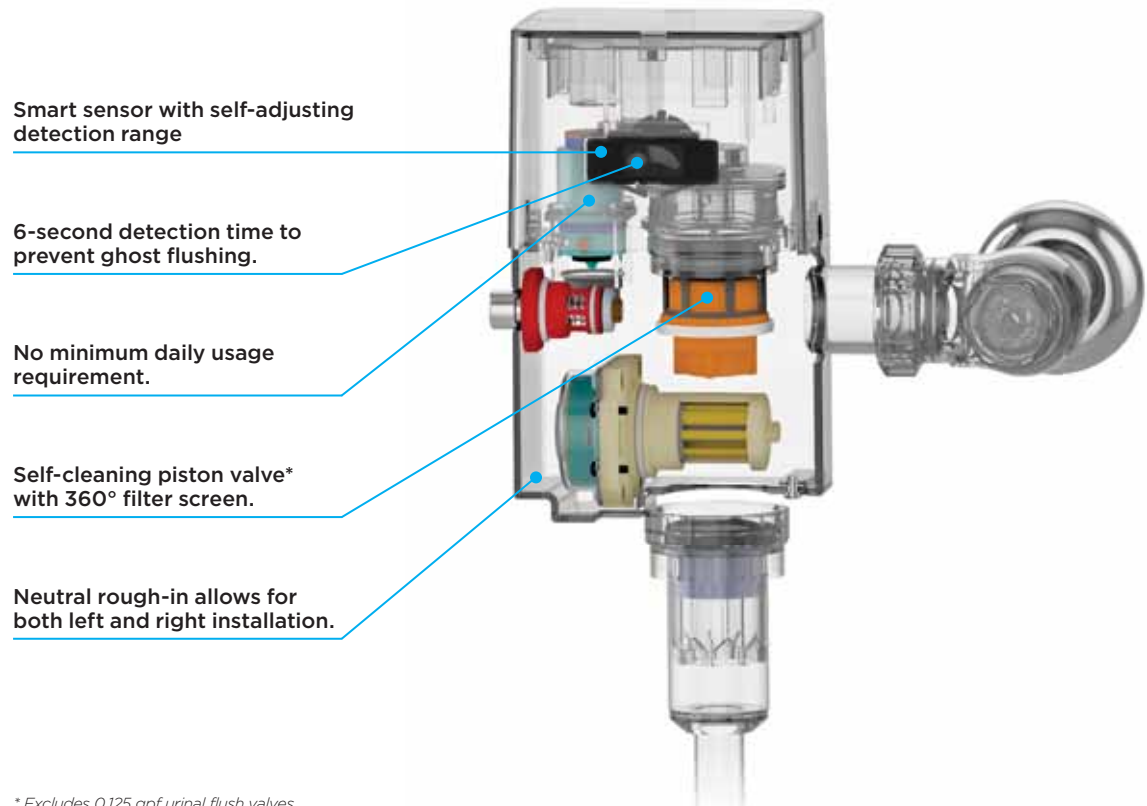

# ECOPOWER TOILET FLUSH VALVES



\*Only applies to 1.0 gpf & 1.28 gpf toilet flush valves.  
Refer to page 16 for the icon guide.

### EXPOSED TOILET FLUSH VALVE

TET1UA - 1.0 GPF  
TET1LA - 1.28 GPF  
TET1GA - 1.6 GPF

### EXPOSED TOILET 24" VACUUM BREAKER FLUSH VALVE

TET6UA - 1.0 GPF  
TET6LA - 1.28 GPF  
TET6GA - 1.6 GPF

### CONCEALED TOILET FLUSH VALVE

TET2UA - 1.0 GPF  
TET2LA - 1.28 GPF  
TET2GA - 1.6 GPF

### CONCEALED TOILET FLUSH VALVE

TET3UA - 1.0 GPF  
TET3LA - 1.28 GPF  
TET3GA - 1.6 GPF



- ▶ Durable chrome plated body with tamper-proof screws and solid bronze valve body
- ▶ True mechanical flush override

- ▶ Durable chrome plated body with tamper-proof screws and solid bronze valve body
- ▶ True mechanical flush override
- ▶ For toilet with 1-1/2" top spud inlet using using 24" vacuum breaker bar

- ▶ 14" x 12" stainless steel cover plate with solid bronze valve body
- ▶ Manual flush override

- ▶ 4" x 4" brushed stainless steel cover plate with solid bronze valve body
- ▶ Manual flush override

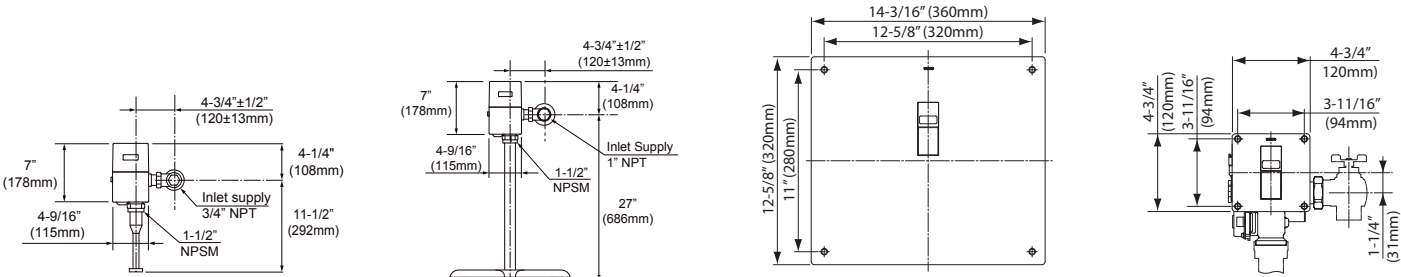

These dimensions are subject to change without notice. Refer to local codes for details.



# ECOPOWER URINAL FLUSH VALVES



\*Only applies to 0.5 gpf & 0.125 gpf urinal flush valves.  
 †Only applies to 0.125 gpf urinal flush valves.  
 Refer to page 16 for the icon guide.

## EXPOSED URINAL FLUSH VALVE

TEU1UA - 0.125 GPF  
 TEU1LA - 0.5 GPF  
 TEU1GA - 1.0 GPF



## CONCEALED URINAL FLUSH VALVE

TEU2UA - 0.125 GPF  
 TEU2LA - 0.5 GPF



## CONCEALED URINAL FLUSH VALVE

TEU3UA - 0.125 GPF  
 TEU3LA - 0.5 GPF



- ▶ Durable chrome plated body with tamper-proof screws and solid bronze valve body
- ▶ True mechanical flush override
- ▶ TEU1GA includes smart sensor fuzzy logic control to reduce water usage

- ▶ 14" x 12" stainless steel cover plate with solid bronze valve body
- ▶ Manual flush override

- ▶ 4" x 4" brushed stainless steel cover plate with solid bronze valve body
- ▶ Manual flush override

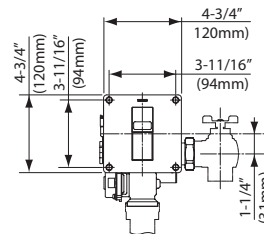
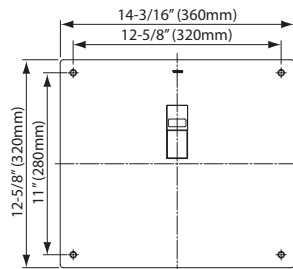
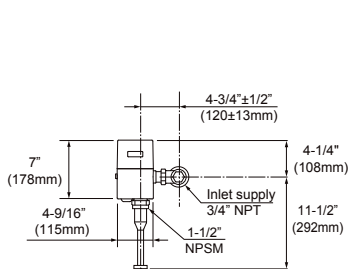

These dimensions are subject to change without notice. Refer to local codes for details.

SUSTAINABLE ENERGY.  
POWERED BY WATER.



## RESTROOMS CAN BE A PEACEFUL, INSPIRING ESCAPE.

TOTO products can create beautiful, refreshing bathroom experiences in any situation. We're known for consistent high performance designs and a beautiful global aesthetic in all our products, so wherever you find TOTO you can experience the same reliability, value and style.





Libella™ M Wall-Mount EcoPower Faucet  
Luminist® Round Vessel Lavatory  
Clean Dry® High Speed Hand Dryer  
NEOREST® AC™ Wall-Hung Toilet  
Washout High-Efficiency Urinal  
Concealed Toilet Flush Valve

# ICON GUIDE



EcoPower



Auto Functions



Safety Thermo with SMA Thermostatic Valve Technology



ADA Compliant



WaterSense



Meets CEC Water Regulations - Effective 2016

**CALGreen**

Meets CalGreen Water Regulations for new construction and permitted remodel





**TOTO USA, INC.**  
1155 SOUTHERN ROAD  
MORROW, GA 30260  
800-350-8686

**[www.totousa.com](http://www.totousa.com)**

#KO-102017-EPB  
Printed in U.S.A. 10/2017