

The TOOL SHED

NUMBER 168

June 2012

• • • A Journal of Tool Collecting published by CRAFTS of New Jersey • • •

New Jersey Plane Makers

By Bob Garay

Like most collectors, when I first started collecting tools I was very unselective. I would go to the flea markets and buy any antique tool I could afford or that seemed worthy. Over the years I filled my shelves with many fine planes, both wood and metal. I enjoyed cleaning them and studying all their features and getting them back to working condition. It was interesting to study their history and I was lucky to have great reference books. Emil Pollak's book, *American Wooden Planes* was a wealth of information. Every time I got a wooden plane I would research the maker, hoping to find that I got a rare maker. Over the years I ran across many New Jersey maker planes and Alex Farnham's books on New Jersey Tools and Their Makers gave me more information where Pollak's book left off.

As I became more knowledgeable about New Jersey plane makers I bid on planes that showed up in auctions. The CRAFTS auction always has New Jersey planes and I was glad I could fill out my collection with some selective bidding. Of course, there were many other collectors who were interested in

New Jersey planes, like Wilma Sagurton who kept the prices on some makers high. I was fortunate a few years ago while in Nashua, NH, to be talking to Bill Curtis who was in the process of organizing his large wood plane collection. He told me he had some very good New Jersey planes he was looking to find a new home for. Would I be interested? Well, it was at that moment that I realized that I was a collector of New Jersey planes and I said boldly, "YES". He just happened to have a box load of these planes I could look thru. I was amazed at some of the rare makers and marks of hardware dealers he had for me to see. We struck a deal and I came home the proud owner of a good dozen plus planes. It was time to hit Pollak's and Farnham's books again and check out these planes. As I studied these planes I realized that I was starting to focus my wood plane collection on New Jersey makers. I sorted through my shelves and put in boxes the good planes from my earlier collecting days that seemed disposable now. I sold them to allow more room and spending power

Continued on page 6

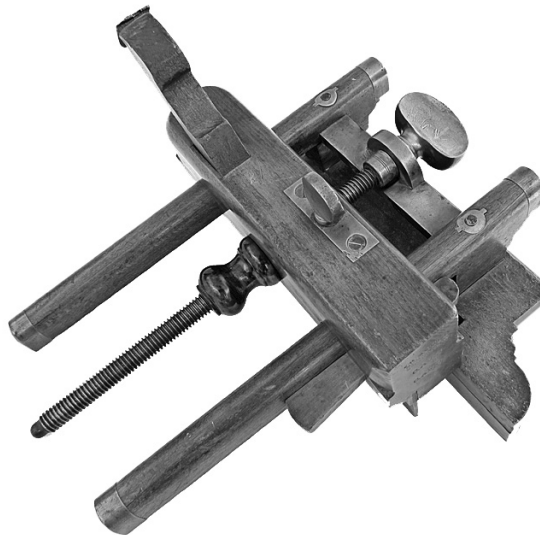

Mockridge & Francis self-regulating plow plane. This Newark based company was one of the most productive of the NJ planemakers. From Chuck Granick's collection.

Contents

- New Jersey Plane Makers by Bob Garay 1
- President's Corner 2
- April 2012 Meeting by Dave Nowicki 3
- Tool Events 12
- Want Ads 12

◆◆ CRAFTS PICNIC ◆◆

September 9, 2012 - 9AM

Brady Camp, Pottstown, NJ

◆◆◆◆ NEXT MEETING ◆◆◆◆

November 4, 2012 - 1PM

HOST Masonic Lodge, Highbridge, NJ

Please mark your calendar

New Jersey Plane Makers

Continued from page 1

to acquire more New Jersey makers. In recent years I was lucky to find some great deals in the CRAFTS auction as some of the Wilma Sagurton and Greg Welsh collection became available. I recently displayed a selection of these New Jersey wooden planes at the CRAFTS picnic. Since it happened to be one of the only times it has ever rained on a CRAFTS picnic there was limited tailgating and a lot of interest in the displays set up inside. Thus I enjoyed talking to many members about my plane display and all the different New Jersey makers. Many said I should

write an article on the planes and I agreed that it might add some interest to these home-grown makers.

Thus, the following is a brief description of the many New Jersey planemakers and hardware dealers who sold wood planes in New Jersey. I focused on makers of all wood planes, as New Jersey also had makers of metal planes. Much of the information is gathered from the two great reference books by Alex Farnham; *Early Tools of New Jersey and The men Who Made Them*, and *Search for Early New Jersey Toolmakers*. Also, I have included information found in; *American Wooden Planes*, by Emil & Martyl Pollak 4th edition revised by Tom Elliott

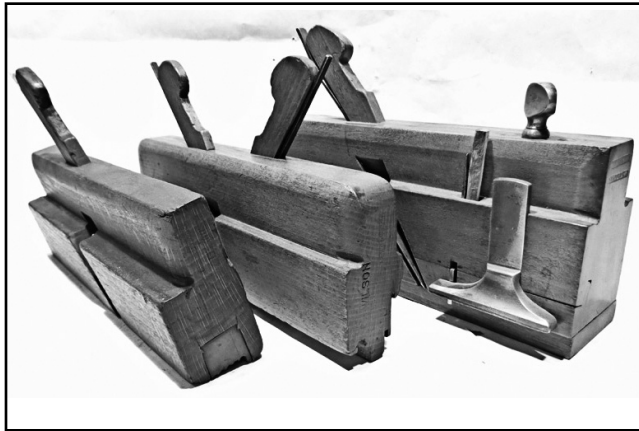

Above - 3 unique planes by Andruss. Left is a 5 reed boxed cluster. Center is J.Andruss 3/8" T&G come & go plane. Right is a moving filletster with fence, brass depth stop and slit.

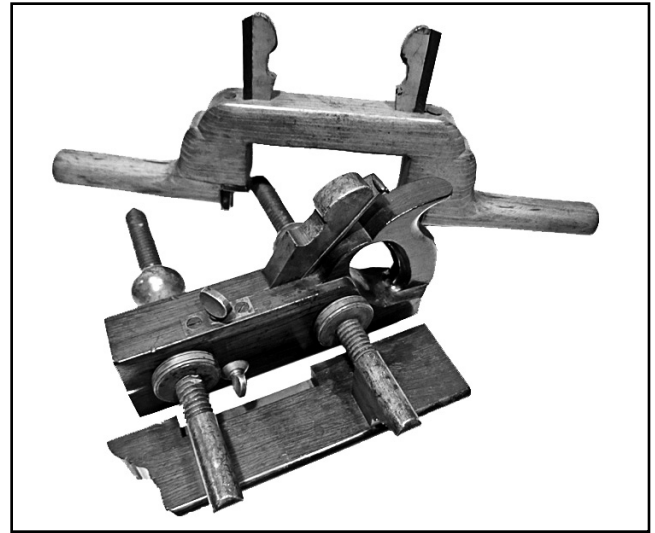

Above - Mockridge & Francis rosewood plow plane and double pistol coach router.

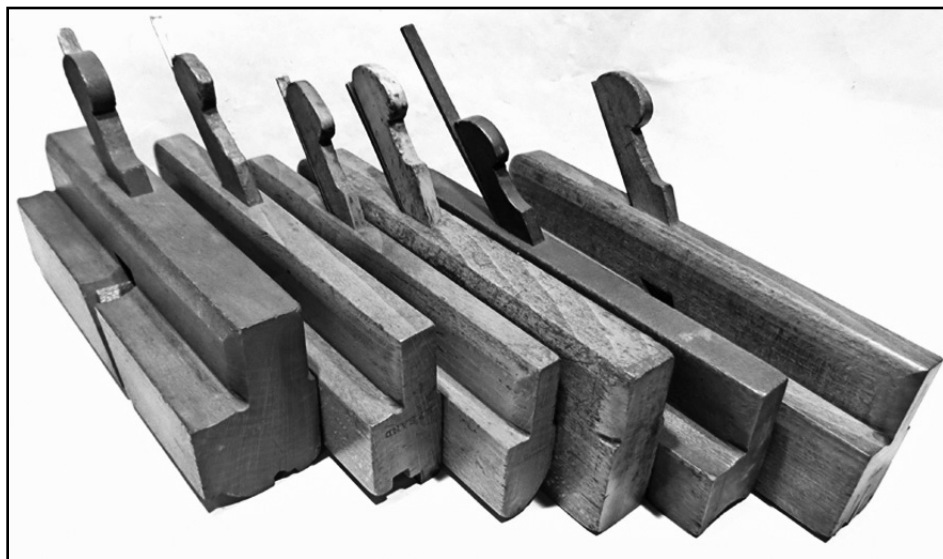

Above - 6 rare Newark plane makers. From left is wide complex molder by C.Parkhurst. Second is a J.A.King 7/8" tongue plane. Third is an I.King round plane. Fourth is a Newark Plane Rule & Level Co. skew rabbet plane. Fifth is a C.H.Crane hollow plane. Far right is a J.Searing double boxed complex molder.

NJ Planemakers Locations

Newark, NJ

Andruss - 1821-1841. Jonathan Andruss was probably the first Newark plane maker. Sons David & George formed partnership – David died in 1832 & the father died in 1843. Early planes marked "J. ANDRUSS" for father before sons' partnership are rare.

John Burkinshaw - 1857-58. Listed in 1858 directory as planemaker, 125 Academy St. Possibly a relation to W.Burkinshaw.

Thomas Burns - 1836-38. Listed in Newark directories as planemaker at 150 Washington St. - the same address as George Andruss. No imprint has been reported, thus he may have worked for Andruss.

L.H.Crane -1830-36. Cabinetmaker in Newark.

J. Doremus - 1830. Maker of regular and coach planes. A very rare plane to find.

Samuel E. Farrand - 1835-36. Worked in same address as Andruss in 1835. Later as part of Farrand & Gould, plane & machine makers. Many of his planes are coach planes which fit one of his businesses as a carriage dealer. By 1860 he is listed as a farmer in Hanover, NJ at age 60.

Edward Francis - 1852-53. Documented plane maker, 138 Washington St.

Elias Francis - 1835-79. Partner with Mockridge, listed in 1837-38 as plane-maker at 145 Washington St. In 1879 was listed as Superintendent of Newark Plane, Rule & Level Co.

J.L.Haynes - 1850. Found example with his imprint along with J. Parker with location of Newark, NJ. A very rare plane with no imprint recorded.

John A. King - 1835-37. One of only, three known early black planemakers.

Ira Looker - 1858-59 & 1858-63. Directory lists as plane maker, 14 Fair St.

Archibald McIntire -1854-55. Directory lists as plane maker, 226 Nesbit St.

Continued on page 8



Above - 3 rare NJ hardware dealer planes. Left is H.Schmitt, and center is W.Schmitt Co. Both have "AUSTRIA" stamped on front as well as C-clamp mark. Right is smoother with C.BELL - J. CITY hardware dealer mark.

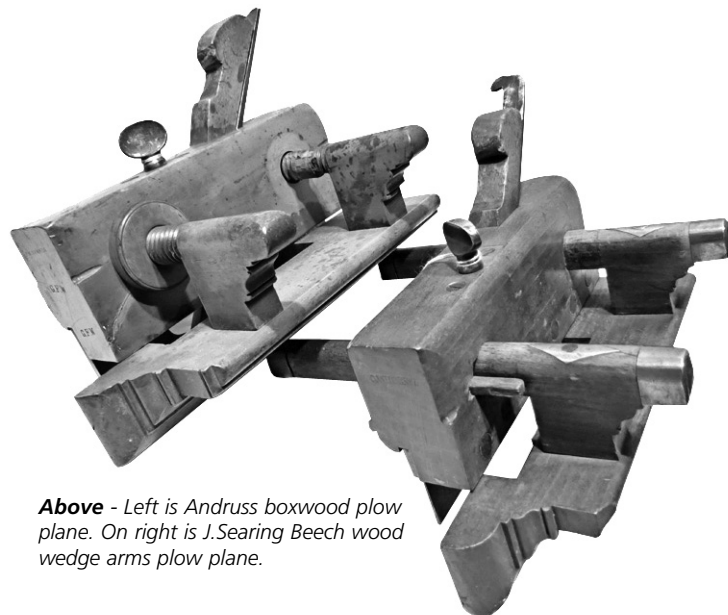

Above - Left is Andruss boxwood plow plane. On right is J.Searing Beech wood wedge arms plow plane.



Above - Unique coach planes. From left are two Mockridge & Francis rabet planes, (a compass bottom & a T-rabet.) Third and fourth are planes by S.E.Ferrand also a compass rabet and T-rabet. Far right is a rare rosewood Mockridge & Francis 1/8" coach grooving plane.

New Jersey Plane Makers

Continued from page 7

Abrahm Mockridge - 1833-1873.

Formed partnership with Elias Francis, & later with son.

Mockridge & Francis - 1835-1868. Later in 1879 Francis became superintendent of the Newark Plane, Rule & Level Co.

Mockridge & Son - 1868-1902. Oscar Mockridge continued to use the old imprint after his father's death in 1873.

A.G.Moore - 1847-52. Listed in Newark directories as a planemaker during these years. Moved to NY and is listed there in 1853 working at same address as J.W.Farr.

Timothy B. Noe - 1837. Listed as plane-maker located at 162 Plane St in the Newark directory. The same address as David Willis, another Newark planemaker.

Joseph Parker - 1834. Listed in the 1850 census as a planemaker in Newark. A rare maker with one known example of a beech smoother plane with his mark.

Charles Parkhurst - 1835-36. Also partner with Joseph Coe as Parkhurst & Coe - planemakers the same year. In the 1837-38 directories Parkhurst is listed as a, "Turner and plane maker", at 55 Court St. In the 1850 census he is listed as a turner.

Philip Quigley - 1849-50. Listed in Newark directory as manufacturer of levels & carpenter tools employing 12 workers. A rare plane to find with his mark.

John Scheler - 1860-61. Directory lists as Planemaker, 26 Broom St.

H. Schmitt - 1835. Imported tools & hardware dealer. Austria type horn plane.

W. Schmitt Co. - 1850's. Hardware dealer. Austria type horn plane.

James Searing -1821-1849. James and his son John worked together.

T.Shepard - 1850. Thomas Shepard worked and lived in Newark with P.Quigley.

John F. Teasman - 1835-37. Listed in Newark directory as planemaker, "colored" and in 1850 census as planemaker. No imprint reported.

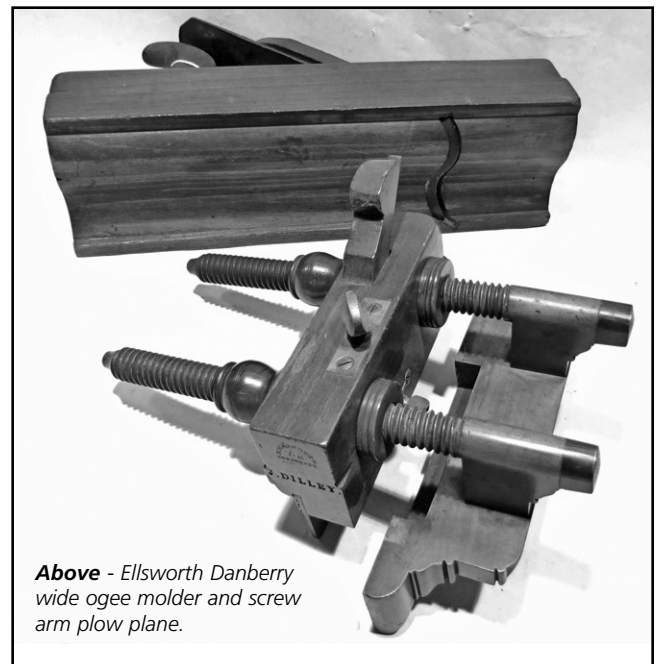

Above - Ellsworth Danberry wide ogee molder and screw arm plow plane.

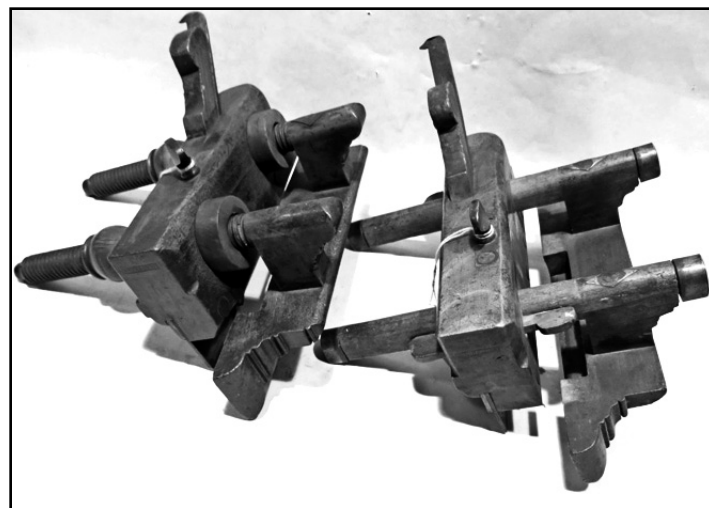

Above - 2 plow planes by Eastburn. On left is a beech body plow with boxwood arms, washers & nuts. On right is a wedged arm plow with brass caps on the arms.

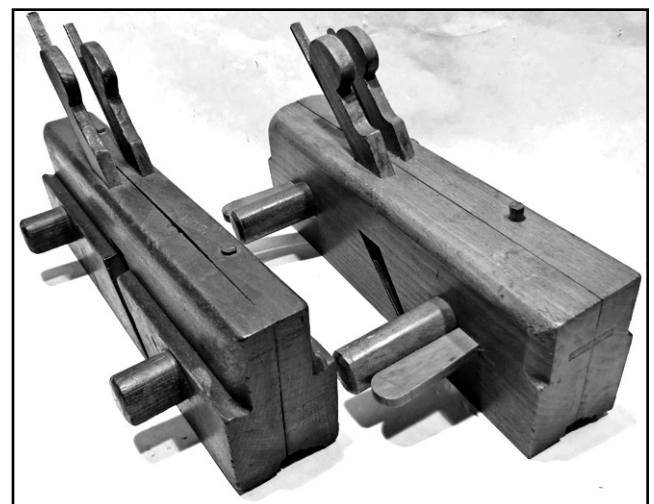

Right - 2 sash planes by Eastburn. Left is a very early friction arm sash plane, a scarce design used by only a few early planemakers. On right is later design of wedged arm sash plane by Eastburn.

Alexander Veres or Viris - 1854-59. Directory lists as Planemaker, 138 Washington St. (Veres & Viris) are most likely the same individual but with spelling variations. Both spellings do not appear in the directory at the same time.

Daniel Whittemore - 1854-59. Directories list as Planemaker, 2 East River St. & 11 Hamilton St.

David Willis - 1837. Listed as planemaker located at 162 Plane St in the Newark directory. The same address as Timothy B. Noe, another Newark planemaker.

New Brunswick, NJ

Samuel C. Cook - 1825-1845. Possibly apprenticed with Robert Eastburn. Possibly employed by Joseph Eastburn. Apprentice included Benjamin Norman. Succeeded by Ellsworth Danbury.

Ellsworth Danberry - 1850. Worked with and succeeded S.C.Cook.

Robert Eastburn - 1795-1826. NJ earliest planemaker. Planes marked EASTBURN with crowned initials are believed prior to 1810. Crowned stamp believed to be same as Thos. Grant, NY planemaker who also lived in New Brunswick and knew Eastburn.

Joseph Eastburn - 1850-1871. Son of Robert, probably used earlier Eastburn stamp.

R.M.Tilburn - 1820. Apprenticed in Newbury, MA before moving to NJ in 1820 as a journeyman planemaker. Later he worked in Philadelphia.

William H.H.White - 1830's-1850. Was a planemaker and later a carpenter.

Other NJ Cities

Thomas Aikman - 1800-Burlington. Some planes marked "Phila".

Andrine Bros. - 1879 - Jersey City. Hardware dealer located at 204 Grove St.

C. Bell - mid 1800's - Jersey City. A hardware dealer.



Left - wedge arm Plow plane by S.C.Cook, beech wood body with a boxwood fence.

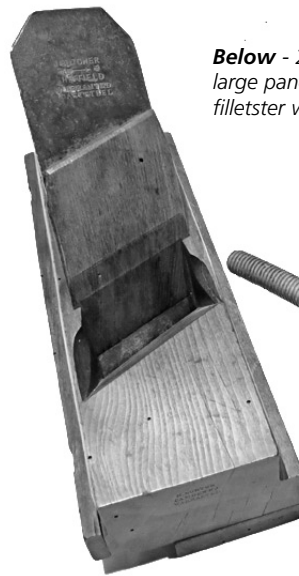

Below - 2 planes by Nathan F.Norton. Left is a large panel raiser plane. Right is beech wood filletster with long 12" boxwood arms & nuts.

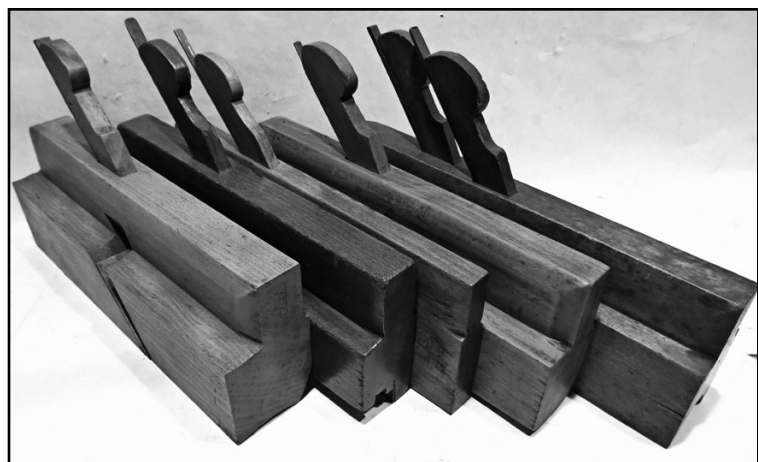
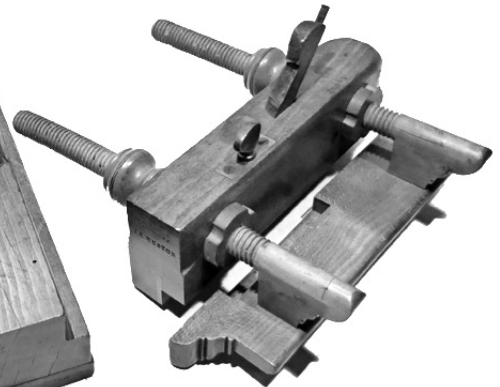

Above - From left is B.Norman #18 hollow plane. Second is S.C.Cook 3/4" tongue plane. Third is W.H.H.White 3/4" skew rabbet. Fourth is R.M.Tilburn #16 round plane. Far right is W.J.C.Ward 1" double iron nosing plane.

Continued on page 10

New Jersey Plane Makers

Continued from page 9

Joseph Brumley - 1790's -1800 - Mt. Holly & Trenton. A very rare maker who was a cabinetmaker and maker of planes. Moved to Wash. DC in 1800. Not marked NJ.

W.B. Chamberlin - 1845 - Westfield. Probably a hardware dealer, known mark with Chapin/Union plane.

John Frace - 1860 - Newton. Listed in 1860 census as carpenter, evidence of work is rosewood plow plane.

John Gage - 1883-1919 - Vineland. Maker of Gage self-setting plane, Stanley bought business in 1919.

Laird - 1800 -NJ or NY. Overstruck Eastburn imprint.

H. Luttgen - 1870 - Jersey City. Hardware dealer.

Saml Norcross - ca. 1800. A very rare early NJ planemaker with limited information.

Benjamin Norman - 1840-56 - Trenton. Apprenticed with S.C.Cook. Opened store in Pennington, NJ.

Nathan F. Norton - 1850-56- Camden. Started working with Israel White & planemaking in Philadelphia area.

D.Parkhurst - ca.1800. UR maker with similar stamp to other Parkhurst makers.

John D. Parkhurst - 1850 - Springfield. In the 1850 census he is listed as a carpenter. He is an unrated maker with only 2 planes with his mark. A rare maker to find.

William Ward - 1868-80 - Saddle River. Born in Sheffield England & also worked in NY. Maker of many different wood-working tools. All his planes include a four pointed star mark.

Jacob White - 1844-45- Camden. Relative of well-known Philadelphia planemaker, Israel White, and later worked with Cousin Henry White in Philadelphia. A Rare plane to find with Camden, NJ mark.

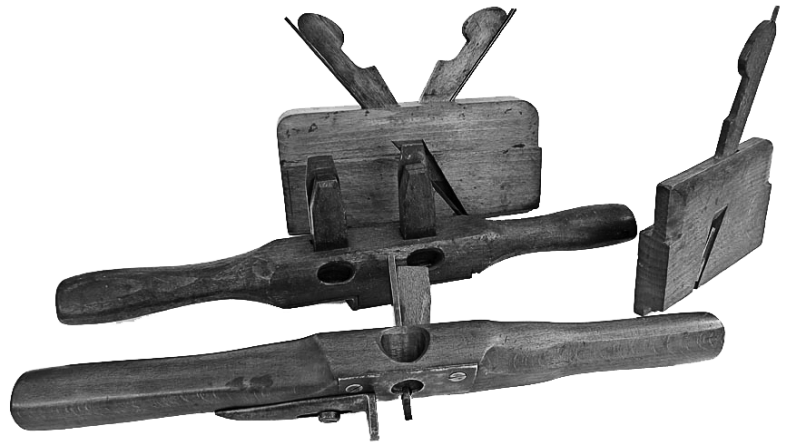

Above rear is two way coach plane with curved molding. Below this caption is bottom profile view of this plane. Above are two coach routers. Above right is small coach 1/4" groove plane. Maker of all planes is Mockridge & Francis. Chuck Granick's collection.

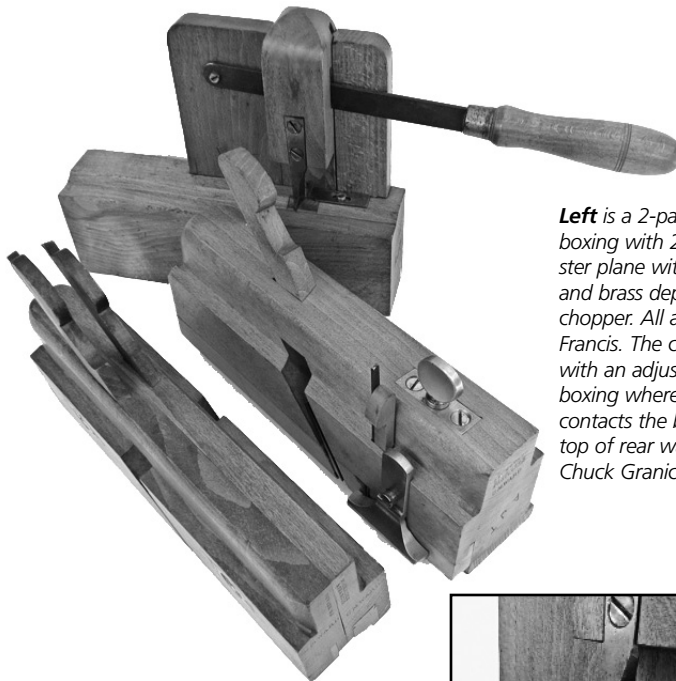

Left is a 2-part sash plane, double boxing with 2 irons. Center is a fillet-ster plane with adjustable fence, nicker and brass depth stop. Rear is a sash chopper. All are made by Mockridge & Francis. The chopper is shown below, with an adjustable brass stop and boxing where the chopper blade contacts the base. Maker stamp on top of rear wall. Chuck Granick's collection.



It has been a challenge to find all the New Jersey plane makers, as there is still a lot of research to be done and historical records are incomplete. It seems many elusive makers that are mentioned in directories as "planemaker" were actually workers for one of the major makers. Thus these "planemakers" never stamped the planes they made with their own names, but used the company name.

Of course any historical study will be a work in progress and so is this. My hope is that this article starts some dialogue and collectors send in new information relevant to New Jersey planemakers so we can update this informa-

tion. This article will be uploaded to the CRAFTS website and updated with any new information. Another benefit of having this article on the website is that it will be in color. I hope to add many more spectacular planes and makers marks there. Thanks to Ken Hopfel, Chuck Granick and George Duin for some of the planes and information in this article. Also much thanks to the Pollaks and Tom Elliot for their work in *American Wooden Planes*. Lastly, but definitely not least, is the inspiration and groundbreaking works by Alex Farnham. He inspired me to become a New Jersey collector and to him I owe many thanks. ■

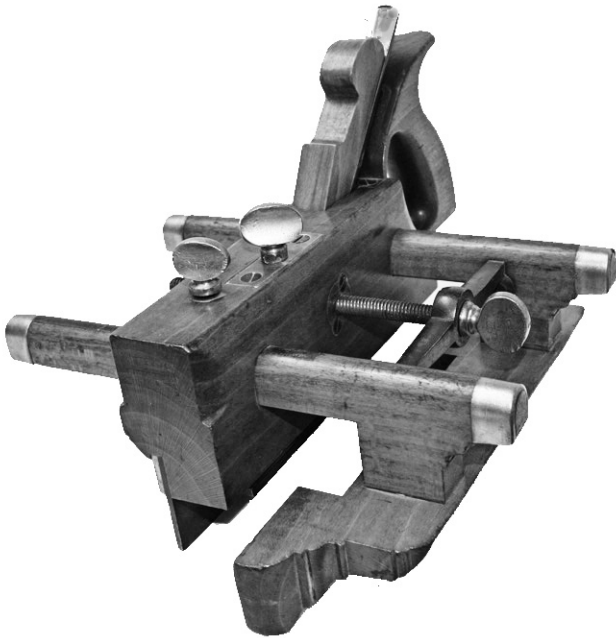

Above - I.King 3-arm self-setting plow plane. It has a handle that is attached to the body with iron supports. It is considered to be the first of the New Jersey 3-arm plow planes. Ken Hopfel's collection.

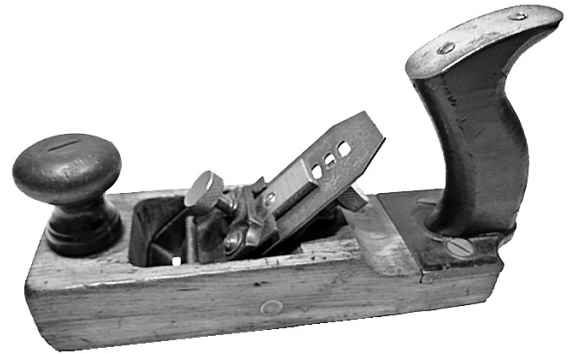

Above - Gage Tool Co. plane with scarce cast iron handle-overhang.



Above - Andruss unhandled 3-arm plow plane. One of only three known examples, George Duin's collection



Left - From left are 3 molding planes by T.Shepard, J.Brumley & S.Norcross. Right are two double iron complex moulders, left by Andruss and right J. Searing. Ken Hopfel's collection.