

LIVE 3

Vocal Harmony & Real-Time Pitch Correction for Guitarists



VOCALIST[®]

**Owner's
Manual**

WARNING FOR YOUR PROTECTION READ THE FOLLOWING:

KEEP THESE INSTRUCTIONS

HEED ALL WARNINGS

FOLLOW ALL INSTRUCTIONS

THE APPARATUS SHALL NOT BE EXPOSED TO DRIPPING OR SPLASHING LIQUID AND NO OBJECT FILLED WITH LIQUID, SUCH AS VASES, SHALL BE PLACED ON THE APPARATUS

CLEAN ONLY WITH A DRY CLOTH.

DO NOT BLOCK ANY OF THE VENTILATION OPENINGS. INSTALL IN ACCORDANCE WITH THE MANUFACTURER'S INSTRUCTIONS.

DO NOT INSTALL NEAR ANY HEAT SOURCES SUCH AS RADIATORS, HEAT REGISTERS, STOVES, OR OTHER APPARATUS (INCLUDING AMPLIFIERS) THAT PRODUCE HEAT.

ONLY USE ATTACHMENTS/ACCESSORIES SPECIFIED BY THE MANUFACTURER.

UNPLUG THIS APPARATUS DURING LIGHTNING STORMS OR WHEN UNUSED FOR LONG PERIODS OF TIME.

Do not defeat the safety purpose of the polarized or grounding-type plug. A polarized plug has two blades with one wider than the other. A grounding type plug has two blades and a third grounding prong. The wide blade or third prong are provided for your safety. If the provided plug does not fit your outlet, consult an electrician for replacement of the obsolete outlet.

Protect the power cord from being walked on or pinched particularly at plugs, convenience receptacles, and the point where they exit from the apparatus.

Refer all servicing to qualified service personnel. Servicing is required when the apparatus has been damaged in any way, such as power-supply cord or plug is damaged, liquid has been spilled or objects have fallen into the apparatus, the apparatus has been exposed to rain or moisture, does not operate normally, or has been dropped.

MAINS DISCONNECT: The plug shall remain readily operable. For rack-mount or installation where plug is not accessible, an all-pole mains switch with a contact separation of at least 3 mm in each pole shall be incorporated into the electrical installation of the rack or building.

If connected to 240V supply, a suitable CSA/UL certified power cord shall be used for this supply.



The symbols shown above are internationally accepted symbols that warn of potential hazards with electrical products. The lightning flash with arrowpoint in an equilateral triangle means that there are dangerous voltages present within the unit. The exclamation point in an equilateral triangle indicates that it is necessary for the user to refer to the owner's manual.

These symbols warn that there are no user serviceable parts inside the unit. Do not open the unit. Do not attempt to service the unit yourself. Refer all servicing to qualified personnel. Opening the chassis for any reason will void the manufacturer's warranty. Do not get the unit wet. If liquid is spilled on the unit, shut it off immediately and take it to a dealer for service. Disconnect the unit during storms to prevent damage.

ELECTROMAGNETIC COMPATIBILITY

This unit conforms to the Product Specifications noted on the **Declaration of Conformity**. Operation is subject to the following two conditions:

- this device may not cause harmful interference, and
- this device must accept any interference received, including interference that may cause undesired operation.

Operation of this unit within significant electromagnetic fields should be avoided.

- use only shielded interconnecting cables.

DECLARATION OF CONFORMITY

Manufacturer's Name: Harman Music Group
Manufacturer's Address: 8760 S. Sandy Parkway
Sandy, Utah 84070, USA

declares that the product:
Product name: Vocalist® Live 3

Product option: all (requires Class II power adapter that conforms to the requirements of EN60065, EN60742, or equivalent.)

conforms to the following Product Specifications:

Safety: IEC 60065 (7th ed. 2001)

EMC: EN 55013 (2001-A1)
EN 55020 (1998)

Supplementary Information:

The product herewith complies with the requirements of the Low Voltage Directive 2006/95/EC and the EMC Directive 2004/108/EC.

Vice-President of Engineering
8760 S. Sandy Parkway

Sandy, Utah 84070, USA
Date: December 3, 2009

European Contact: Your local DigiTech Sales and Service Office or

Harman Music Group
8760 South Sandy Parkway
Sandy, Utah 84070 USA
Ph: (801) 568-8800
Fax: (801) 568-7583



If you want to dispose this product, do not mix it with general household waste. There is a separate collection system for used electronic products in accordance with legislation that requires proper treatment, recovery and recycling.

Private household in the 25 member states of the EU, in Switzerland and Norway may return their used electronic products free of charge to designated collection facilities or to a retailer (if you purchase a similar new one).

For Countries not mentioned above, please contact your local authorities for a correct method of disposal.

By doing so you will ensure that your disposed product undergoes the necessary treatment, recovery and recycling and thus prevent potential negative effects on the environment and human health.

Warranty

We at **Vocalist**[®] are very proud of our products and back up each one we sell with the following warranty:

1. The warranty registration card must be mailed within ten days after purchase date to validate this warranty.
2. Vocalist warrants this product, when used solely within the U.S., to be free from defects in materials and workmanship under normal use and service.
3. Vocalist liability under this warranty is limited to repairing or replacing defective materials that show evidence of defect, provided the product is returned to Vocalist WITH RETURN AUTHORIZATION, where all parts and labor will be covered up to a period of one year. A Return Authorization number may be obtained from Vocalist by telephone. The company shall not be liable for any consequential damage as a result of the product's use in any circuit or assembly.
4. Proof-of-purchase is considered to be the burden of the consumer.
5. Vocalist reserves the right to make changes in design, or make additions to, or improvements upon this product without incurring any obligation to install the same on products previously manufactured.
6. The consumer forfeits the benefits of this warranty if the product's main assembly is opened and tampered with by anyone other than a certified Vocalist technician or, if the product is used with AC voltages outside of the range suggested by the manufacturer.
7. The foregoing is in lieu of all other warranties, expressed or implied, and Vocalist neither assumes nor authorizes any person to assume any obligation or liability in connection with the sale of this product. In no event shall Vocalist or its dealers be liable for special or consequential damages or from any delay in the performance of this warranty due to causes beyond their control.

NOTE: The information contained in this manual is subject to change at any time without notification. Some information contained in this manual may also be inaccurate due to undocumented changes in the product or operating system since this version of the manual was completed. The information contained in this version of the owner's manual supersedes all previous versions.

Contents

Overview	1	Right Out.....	10
Introduction	1	Ground Lift Switch	10
musiQ® Technology	1	Power Input.....	10
Included Items	3		
Front Panel	4	Getting Started	11
Vocal Signal Strength.....	4	Connections when using a separate guitar amplifier.....	11
Guitar Signal Strength.....	4	Connections when sending the guitar/vocal mix to the PA.....	12
Tuner Bars	4	Adjust the Guitar Sensitivity.....	12
Display	5	Tune the Guitar	13
♭ # Flat/Sharp Tuner LEDs ...	5	Adjust the Vocal Level	13
Harmony Patch Number....	5	Adjust the Effects and Choose the Harmonies.....	13
EQ	5		
Compressor	5	Pre Effects	14
Warmth.....	5	Warmth.....	14
Pitch Correct.....	5	Compressor	14
Guitar Mix	5	EQ	14
Reverb	6	Low-cut Filter and Noise Gate	14
Part A/B Footswitch	6		
Effect Footswitch	6	Effects	15
Harmony Footswitch	6	Pitch Correct.....	15
Delay	6	Reverb	15
Harmony Mix.....	7	Delay.....	15
Humanize.....	7	Effects On/Off.....	16
Setup Button.....	7	Engaging the Tuner.....	16
Patch Button	7		
Voicing Buttons.....	7	Harmony	17
Voicing Display.....	7	Harmony Patches and Parts.....	17
Gender Display.....	8	Store and Recall a Patch....	17
Gender Buttons	8	Selecting Harmony Part A or Part B	18
		Selecting Patch using the Footswitch	18
Rear Panel	9		
Input Gain	9		
Mic In and Line In.....	9		
48V	9		
Guitar In.....	10		
Guitar Thru.....	10		
Stereo Mono Select.....	10		
Left Out	10		

Harmony Voicing	18
Harmony Gender.....	19
Harmony Mix.....	19
Humanize.....	19
Harmony On/Off	20
Setup Menu	21
Guitar Sensitivity.....	21
Harmony Footswitch Mode.....	21
Chorus Depth	22
Chorus Speed	22
Guitar Reverb Send Level ..	23
Noise Gate.....	23
Effects Block Diagram	24
Factory Restore.....	24
Specifications.....	25

Overview

Introduction

The Vocalist[®] Live 3 is a powerful but easy to use intelligent vocal harmony processor that automatically generates live multi-part vocal harmony by analyzing guitar chord progressions. Armed with the musIQ[®] harmony generation technology, the Vocalist Live 3 combines studio-quality audio performance, state of the art vocal processing and an easy to use control interface.

In addition to two voices of harmony with gender control, the Vocalist Live 3 provides five vocal pre effects, pitch correction, reverb (3 room sizes), delay (5 settings), ability to add the guitar signal to the mix, guitar chorus, and five patches (each with A and B parts) to save harmony configurations. The Vocalist Live 3 ensures an enjoyable and streamlined harmony and vocal processing experience for a wide range of applications.

musIQ[®] Technology

musIQ is a revolutionary technology that eliminates the need to program key and scale information to generate Harmony Voices. In real time musIQ technology analyzes the Lead Voice as well as the notes and chords played on a guitar and automatically generates accurate and musically correct vocal harmonies that both complement the Lead Voice and fit the music being played. With musIQ technology, you can focus on your singing and playing performance and eliminate song programming once and for all.

Vocalist® Live 3 Main Features

- Two voices of fully automatic harmony. Just play naturally on your guitar and musIQ® technology will ensure that the harmony voices are always musically correct.
- Gender controls for each harmony voice allow you to alter the character of the harmony voices.
- Humanize control to adjust the style of the harmony voices from loose to tight.
- Five Harmony Patches to save harmony settings, each with an A part and a B part to make on-stage harmony changes easy.
- Real-time Chromatic Pitch Correction.
- Vocal Pre Effects: Warmth (tube preamp), Compressor, two-band EQ, Low Cut and Noise Gate.
- Reverb with three different room sizes.
- Delay with five delay settings.
- Built-in guitar chorus effect.
- Ability to mix the guitar and vocal signals to provide the acoustic guitar player with a easy way to connect straight to the PA or a powered speaker.
- Low noise microphone preamp.
- 48V phantom power.
- Guitar Ground Lift to eliminate any noise hum issues that may arise.
- Built-in Guitar Tuner.
- Balanced XLR stereo outputs.
- Balanced Line Input for post processing recording applications.
- 24-bit, 44.1 kHz audio quality.

Included Items

Before you get started, please ensure that the following items have been included:

- The Vocalist® Live 3
- PS-0913B Power Adapter
- Owner's Manual
- Warranty Card

The utmost care was taken while your Vocalist Live 3 was being manufactured. Everything should be included and in perfect working order. If anything is missing, contact the factory at once. Please help us become acquainted with you and your needs by completing your warranty card or registering online at www.vocalistpro.com. It is your safeguard should a problem arise with your Vocalist Live 3.

Important safety tip: Always turn on amplifiers **AFTER** all other connections are made to the Vocalist Live 3 and **AFTER** the Vocalist Live 3 is powered up.

Front Panel

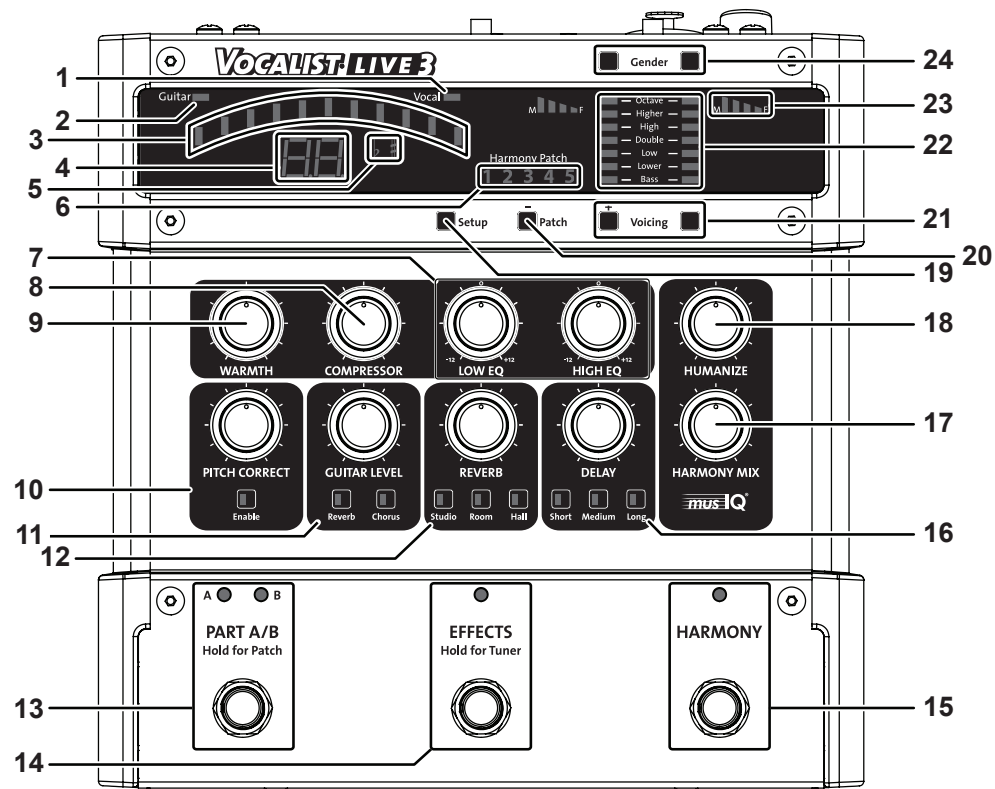

1. Vocal Signal Strength

This light represents the signal strength of both the Mic In and Line In. When lit green, the vocal input signal is at a sufficient level. When lit amber, the signal strength is nearing the Vocalist Live 3's limiting point. When lit red, the limiter is active and the Mic/Line Input Gain should be reduced.

2. Guitar Signal Strength

This light indicates the signal strength at the Guitar In. When lit green, a sufficient guitar input signal is present. When lit amber, the signal strength is approaching the limit. When lit red, the guitar signal is clipping and the Vocalist Live 3 Guitar Sensitivity setting should be changed to Lo.

3. Tuner Bars

These are used by the Guitar Tuner to indicate whether the note played is sharp or flat of the note shown in the Display.

4. Display

In Tuner mode this displays the note played on the guitar. In Setup Menu it is used to display the current value of the various parameters.

5. Flat/Sharp Tuner LEDs

These LEDs light when using the Guitar Tuner to show what note is being played (example: F#).

6. Harmony Patch Number

This indicates which of the five Harmony Patches is presently selected. Note that each Harmony Patch has two harmony settings: Part A and Part B.

7. EQ

A two band EQ allows the tone of the input vocal to be adjusted. The Low EQ knob controls the cut/boost of the bass frequencies. The High EQ knob controls the cut/boost of the treble frequencies.

8. Compressor

Adjusts the amount of compression or dynamic range on the lead voice.

9. Warmth

This controls the warmth of the vocal by emulating a tube preamp.

10. Pitch Correct

This knob adjusts the amount of the chromatic pitch correction on the lead voice. The Enable button is used to turn pitch correction on and off. When the Enable button is lit, Pitch Correct is on and active in the signal path. When the button is not lit, Pitch Correct is bypassed.

11. Guitar Mix

This knob adjusts the amount of guitar signal that is present in the output mix. The Chorus button enables and disables a chorus effect for the guitar signal. The Reverb button enables and disables the guitar signal from being routed through the reverb.

12. Reverb

This knob adjusts the amount of reverb that is applied to the vocals when the effects are enabled. If the Reverb button is pressed to send the guitar signal to the reverb then this knob also controls the amount of reverb on the guitar.

The three buttons select the character of the reverb: Studio selects a standard studio plate reverb, Room selects a medium-sized room and Hall selects a large concert hall.

13. Part A/B Footswitch

Pressing this footswitch quickly will toggle between the A and B Parts of the Harmony Patch. Pressing and holding this footswitch will slowly step between the Vocalist Live 3's Harmony Patches. Release the footswitch when the desired Patch is reached.

The two LEDs above the footswitch Indicate whether Part A or Part B of the Harmony Patch is selected. The green LED on the left indicates Part A, the red LED on the right indicates Part B.

14. Effects Footswitch

Pressing the Effects footswitch quickly will enable and disable the Pitch Correction, Chorus, Reverb and Delay Effects. It does not affect the Pre-Effects (Warmth, Compressor, EQ, Low Cut, and Noise Gate) which are always active. Pressing and holding the switch will engage the Tuner. The Effects LED flashes when the Tuner is active.

15. Harmony Footswitch

The Harmony footswitch turns the Harmony Voices on and off. When the footswitch is lit, the Harmony Voices are enabled. When it is not lit, they are bypassed.

16. Delay

This knob adjusts the amount of delay signal that is applied to the vocals when the Effects Footswitch is enabled.

The three buttons select the delay time. There are selections for Short, Medium and Long delays. Additionally, pressing the Short and Medium buttons at the same time will select a medium-short delay time. Pressing the Medium and Long buttons at the same time will select a medium-long delay time.

17. Harmony Mix

This adjusts the mix of the Harmony Voices with the Lead Voice at the outputs. With the knob fully counter-clockwise, only the Lead Voice is heard in the outputs with no Harmony Voices. With the knob fully clockwise, only the Harmony Voices will be heard at the outputs with no Lead Voice.

18. Humanize

This adjusts the naturalness of the Harmony Voices. The intent is to make the harmonies sound more like real backup singers by introducing variations in the timing and pitch. Fully counterclockwise makes the harmonies follow the Lead Voice very tightly. Fully clockwise and the harmonies are quite loose.

19. Setup Button

Press the Setup button to enter Setup Mode. Subsequent presses step you through the various global parameters. In Setup Mode use the + (Voicing 1) and – (Patch) buttons to adjust the parameter values.

20. Patch Button

This button cycles through the Vocalist Live 3's five Harmony Patches. To save harmony settings to the current Harmony Patch and A/B Parts, press and hold the Harmony Patch button until the selected Patch Number flashes.

21. Voicing Buttons

There are individual Voicing controls for each of the two Harmony Voices. Pressing the Voicing button of the corresponding Harmony Voice will cycle through the Voicing options.

22. Voicing Display

These LEDs display the currently selected Voicings. To disable a Harmony Voice, press the button until none of the LEDs is lit for that Voice.

Note: The exact harmony note choice of the various Voicing shift settings depends on variables such as current note or chord, chord history and lead voice note.

23. Gender Display

The Gender Display indicates the currently selected gender for that voice. Note that when there are no bars lit on the Gender Display, the Gender setting is disabled for the corresponding Harmony Voice.

24. Gender Buttons

Separate Gender settings can be applied to each of the two Harmony Voices. By pressing the Gender button of the corresponding Harmony Voice, you can cycle through the Gender shifts from Masculine (M) to Feminine (F).

Rear Panel

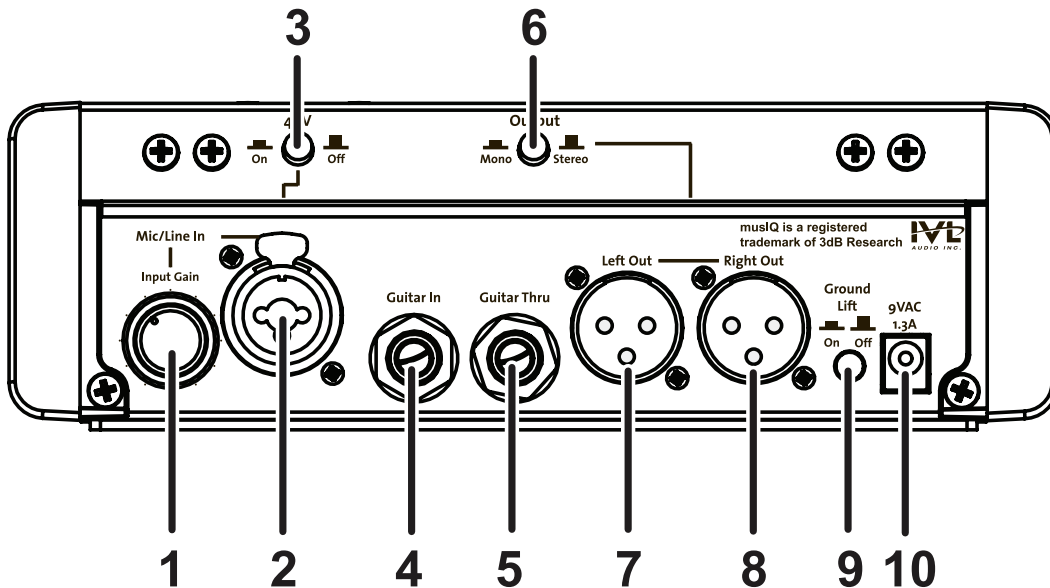

1. Input Gain

This adjusts the input level of the Lead Vocal signal for both the Mic In and Line In. The relative signal strength can be determined by the Vocal Signal Strength indicator on the front panel.

2. Mic In and Line In

The Vocalist Live 3 uses a combo jack for vocal input. This jack will accept either a balanced mic-level signal on the XLR portion of the jack or a line-level signal on the $\frac{1}{4}$ " portion of the jack. The $\frac{1}{4}$ " jack accepts both balanced TRS and unbalanced TS inputs.

3. 48V Phantom Power Switch

Pressing this switch turns on the 48V phantom power to the Mic In. With the switch in the out position, the 48V phantom power is turned off.

Note: Phantom power is normally only needed with condenser microphones and should never be used with ribbon microphones. To avoid damaging the microphone, please consult your microphone documentation to ensure phantom power is applied only when appropriate.

4. Guitar In

This ¼" unbalanced TS Guitar In connects directly to the guitar for use by musIQ® harmony generation.

Note: It is important for the Vocalist Live 3 to be the first device in the guitar signal chain to ensure proper analysis of the guitar signal for harmony generation.

5. Guitar Thru

The guitar signal received on the Guitar In is passed through the ¼" unbalanced TS Guitar Thru to connect to guitar effects and/or an amplifier.

6. Stereo Mono Select

This switch selects whether the Outputs are stereo or mono. When Mono is selected, both Outputs have the same signal and stereo imaging is lost.

7. Left Out

These balanced XLR outputs provide a stereo mix of Lead Vocal and Harmony Voices. The signal level coming from of the outs could be described as a "hot" mic-level signal. It should be compatible with both the mic input of a mixer (with the input trim turned down somewhat) and with a line input on the mixer (with the level set higher).

8. Right Out

Balanced XLR output of the right channel.

9. Ground Lift Switch

This switch lifts Pin 1 of the XLR Outputs from all ground references and may help break troublesome ground loops that cause hum between a Mixer and a guitar amplifier.

10. Power Input

Connect only the supplied PS-0913AC adapter here to power the Vocalist Live 3.

Getting Started

The Vocalist Live 3 provides fully automatic vocal harmony for a guitar player. Simply route your guitar signal into Vocalist Live 3 using the Guitar In. The Vocalist Live 3 monitors what you are playing on the guitar and adjusts the harmonies to fit over the accompaniment.

Connections when using a separate guitar amplifier

When using a separate guitar amplifier, the Guitar Thru output provides a pass through for the guitar signal. Connect the Guitar Thru to any guitar effects and your amplifier. Connect the XLR Output(s) to the PA. Remember to turn the Guitar Level knob on the Vocalist Live 3 down so the guitar signal doesn't pass to the PA.

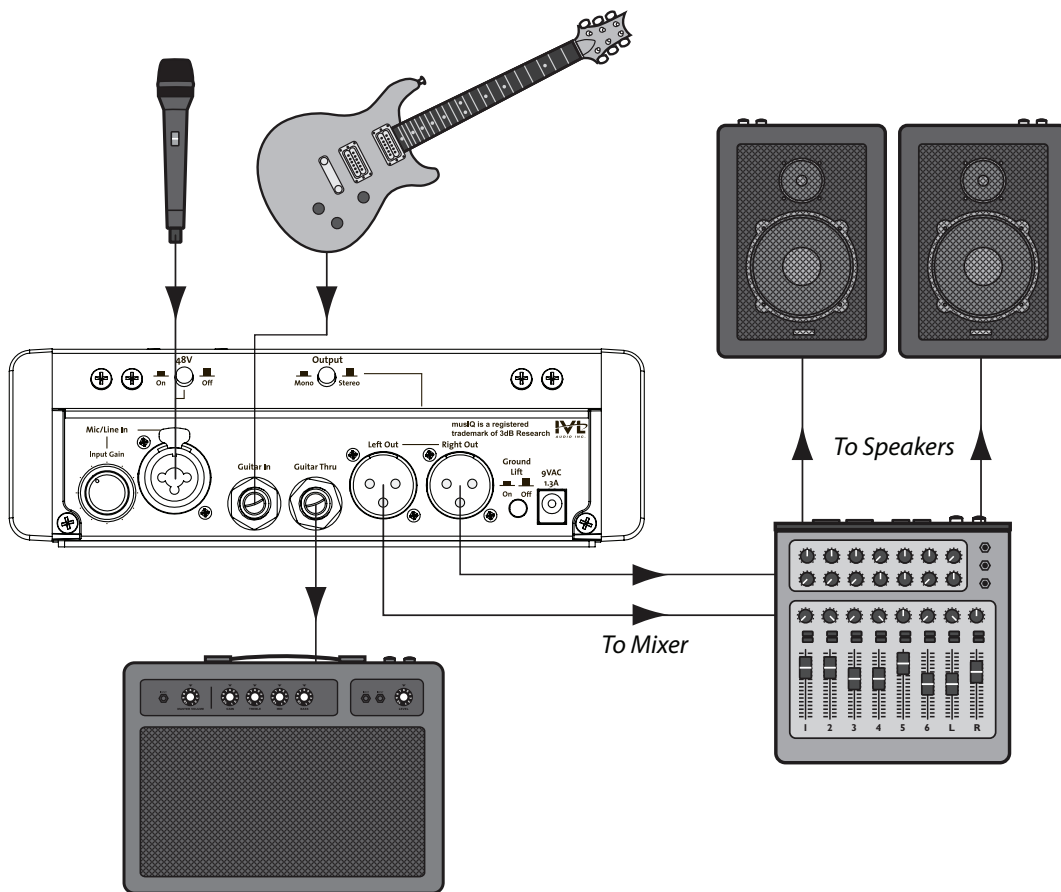

Connections when sending the guitar/vocal mix to the PA

Often with an acoustic guitar it is convenient to provide a single output to the PA. The Vocalist Live 3 allows you to mix the guitar with the vocals and send the guitar/vocal mix to the PA via the XLR Outputs. This allows you total control of your sound from on-stage. The Vocalist Live 3 also provides the ability to add chorus and reverb to your guitar signal to fill out the sound. For a solo act it is no longer necessary to carry a mixer to the gig.

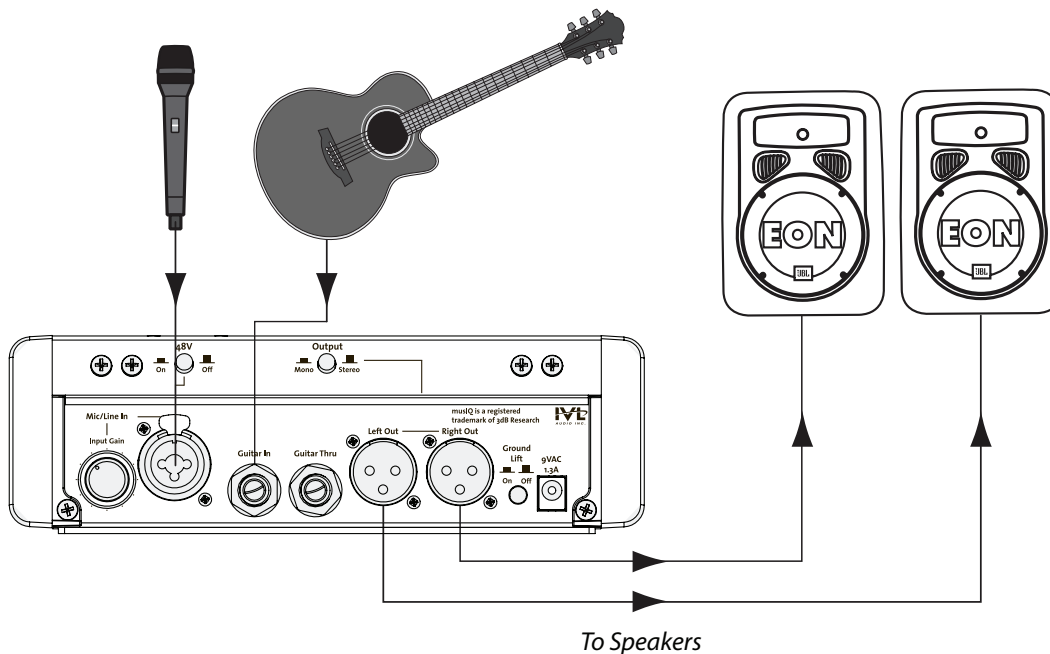

Adjust the Guitar Sensitivity

While playing the guitar, the Guitar Signal Strength indicator should be green or amber. If the Guitar Signal Strength indicator does not light when you play, the guitar signal level may be too low and the Guitar Sensitivity should be changed to Hi. If the Guitar Signal Strength indicator lights red quite often, then the Guitar Sensitivity should be changed to Lo. Changing the Guitar Sensitivity will also affect the level of the guitar signal in the Outputs.

To set the Guitar Sensitivity Press the Setup button to enter Setup Mode. Follow the instructions on adjusting Setup parameters later in this manual.

Tune the Guitar

●
EFFECTS
Hold for Tuner

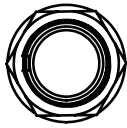

It is important for your guitar to be properly tuned in order for the muslQ® technology to generate the best sounding harmonies. Alternate tunings (for example, DADGAD or tuning down) are fine, as long as the built-in tuner shows each string as in tune. If you are using an external tuner, make sure that the tuner's reference is set to 440 Hz.

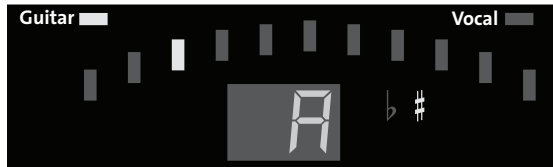

To use the built-in tuner, press and hold the Effect footswitch to start the Guitar Tuner. The Effect LED will flash while the Tuner mode is active. Note that for the Tuner to work properly

it needs to receive adequate guitar signal strength, which is indicated by the Guitar Signal Strength indicator.

As each string is individually played, the closest note to that played will appear on the Display and the Tuner LEDs will show the deviation in pitch from the target note. If the string is in tune with the target note, the green center Tuner LED will be lit. LEDs to the left will light if the string is flat and bars to the right if the string is sharp.

When all strings are in tune, press the Effects footswitch to exit the Guitar Tuner.

Adjust the Vocal Level

Using the Input Gain knob on the rear of the unit, adjust the level so the Vocal level LED lights green when you sing normally and lights amber when you sing loudly. Avoid having the vocal level LED light red if possible.

Adjust the Effects and Choose the Harmonies

You are now ready to adjust the effects and choose harmonies as described in the following sections.

Pre Effects

The Vocalist® Live 3 contains a variety of pre effects to enhance your vocal sound. There are controls on the front panel to directly adjust the settings of the tube preamp model, the compressor and EQ.

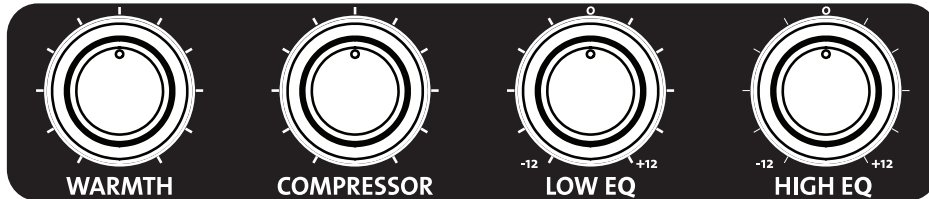

Warmth

This controls the amount of warm subtle distortion from the tube preamp model, adding a degree of vintage tone.

Compressor

The Compressor gives the ability to tighten up the dynamic range of the Lead Voice. The Compressor threshold, ratio, attack and release are all adjusted automatically to provide the right amount of overall compression.

EQ

The Vocalist Live 3's EQ shapes the tone of the incoming vocal signal. There are separate controls for the cut/boost of Low EQ (Bass) and High EQ (Treble) bands.

Low-cut Filter and Noise Gate

The Vocalist Live 3 also has fixed low-cut filter and a noise gate that can be adjusted from within the Setup Menu. See the Setup Menu section later in this manual for making adjustments to either of these options.

Effects

Pitch Correct

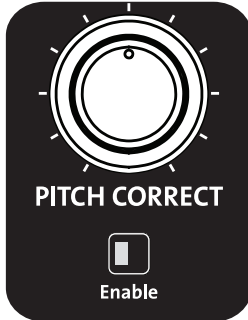

This corrects the Lead Voice to a 12-note chromatic scale.

Use the Amount knob to set the aggressiveness of the pitch correction.

When the Pitch Correct button is lit, Pitch Correct is enabled. When the button is not lit, Pitch Correct is bypassed.

Reverb

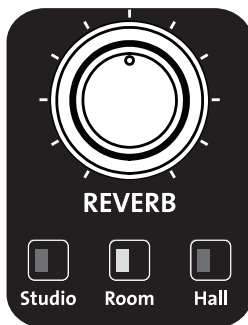

There are three selectable room sizes for the Reverb effect. The active reverb type is indicated by the lit button.

Studio Reverb simulates a studio plate reverb. Room Reverb a medium sized room, and Hall Reverb a large concert hall.

The Reverb Level knob adjusts the amount of reverb applied to the vocals. If the Guitar Reverb button is enabled then this knob also controls the amount of reverb on the guitar signal.

Delay



The Vocalist Live 3 provides 5 preset delay configurations. These are controlled by 3 buttons called Short, Medium and Long. Each button can be selected individually to get a different delay time. You can also select the Short and Medium buttons at the same time to get a medium-short delay or the Medium and Long buttons at the same time you get a medium-long delay. The delay times for the 5 settings are approximately 90ms to 750ms.

Effects On/Off



EFFECTS

Hold for Tuner

Pressing the Effects footswitch will enable and disable the Pitch Correction, Chorus, Reverb and Delay Effects. It does not affect the Pre Effects which are always active.

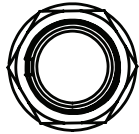

Engaging the Tuner

The Effects Footswitch is also used to access the tuner. Press and hold the Effects footswitch to enable the Tuner. The Effects footswitch LED flashes and the guitar output is muted when the Tuner is active. To disable the Tuner, press the Effects footswitch.

Harmony

Harmony Patches and Parts



Singers need a way to configure different Harmony Voicings for use in different songs. To accommodate this, the Vocalist Live 3 provides five Harmony Patches. This allows the singer to specify the Harmony Voicing and Gender Settings in advance and recall them when needed during a performance. There are five harmony patches. Each harmony patch also has an A Part and a B Part. Typically this will be used to specify one harmony setting for, say, the verse and a separate setting for the chorus. During the song it is easy to toggle back and forth between the A Part and the B Part with the simple press of the Part A/B footswitch

Each Harmony Patch stores the Harmony Voicing and Harmony Gender settings. Harmony Patches do not store the Pre Effects, Pitch Correct, Guitar Level, Reverb, Delay, Harmony Mix, Humanize or Harmony Mix parameters.

Store and Recall a Patch

To recall a patch use the Harmony Patch button. Each press of the button steps to the next Patch.

If you have made changes to a harmony patch, you can store the changes to the selected Patch by pressing and holding the Harmony Patch button until the lit Harmony Patch Number flashes twice.

Note: You must make changes to the Patch location you wish to save them to as there is no way to save changes made in Patch 1 to Patch 5.

Selecting Harmony Part A or Part B

A B

Pressing the Part A/B footswitch quickly will toggle between the A and B Part of the Harmony Patch.

PART A/B
Hold for Patch

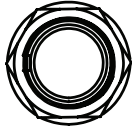

Selecting Patch using the Footswitch

Pressing and holding the footswitch will slowly step the Vocalist Live 3 through the Harmony Patches. Release the footswitch when the desired Patch is reached.

Harmony Voicing

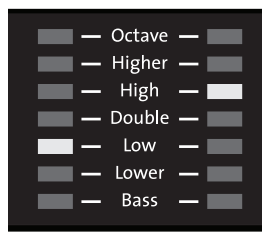

Each Voicing button sets the Voicing for one of the Harmony Voices by cycling through the Voicing options.

The Double option sets the Harmony Voice to “sing” the same note as the lead voice. This provides a rich doubling sound. By cycling through the options until none of the options are lit, the corresponding Harmony Voice is turned off completely.

Because **muslQ**[®] technology adjusts the harmony voices depending on the singer’s note and the music being played on the guitar, it is not possible to exactly specify the exact musical interval using the harmony voicing controls. However, it may be convenient to think of the High and Higher settings to be roughly a third and a fifth above the sung note. Similarly, the Low and Lower settings can be thought of as being roughly a third and a fifth below the sung note.

Harmony Gender

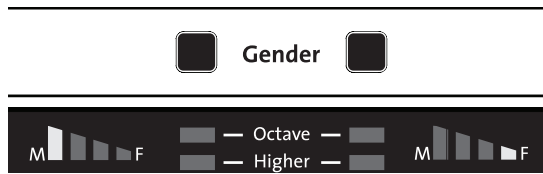

The Vocalist® Live 3 has the option of gender shifting the Harmony Voices to change the character of the virtual backup singers.

There are individual Gender controls for each Harmony Voice. By pressing the Gender button of the corresponding Harmony Voice, you can cycle through the Gender shifts from Masculine (M) to Feminine (F) as indicated on the Gender Display.

The five Gender options for each Harmony Voice are Heavy Male Gender, Light Male Gender, Light Female Gender, Heavy Female Gender and None. When none of the Gender options are lit, this represents no Gender shift is applied, leaving the corresponding Harmony Voice with the same Gender as the Lead Voice.



Harmony Mix

This adjusts the mix between the Lead Voice with the Harmony Voices. With the knob fully counter clockwise, only the Lead Voice is heard. With the knob fully clockwise, only the Harmony Voices will be heard with no Lead Voice.



Humanize

Humanize controls parameters that affect the naturalness of the Harmony Voices such as the time delay between onsets of the Harmony Voices, steadiness of the pitch and the pitch scoop of the voices as it shifts from one note to the next.

Harmony On/Off



HARMONY

This footswitch turns the Harmony Voices on and off. When the footswitch LED is lit, the Harmony Voices are enabled. When the footswitch LED is off, the Harmony Voices are bypassed.

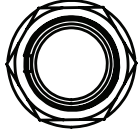

Setup Menu

A Setup Menu has been added to allow additional control of some global settings. To enter the Setup Menu simply press the Setup Button. Once in the Setup Menu the Setup button allows you to step through menu items and the - (Patch) and + (Voicing) buttons adjust the parameter values. A long press of the Setup button will exit the Setup Menu. Alternatively, once you cycle past the last menu item you will leave Setup.

Guitar Sensitivity

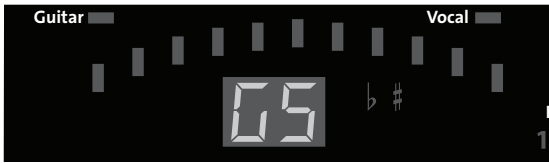

Press Setup until **05** appears in the Display. This is the Guitar Sensitivity adjustment menu.

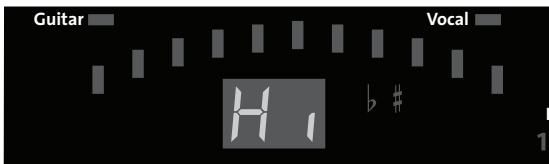

The **05** will disappear after a second and either **H1** or **L0** will appear showing the current Guitar Sensitivity. Select the desired sensitivity using the +/- buttons. Changing the Guitar Sensitivity will affect the level of the guitar signal in the Outputs.



Harmony Footswitch Mode

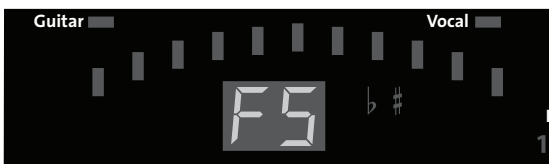

Press Setup until **FS** appears in the Display. This selects the operation mode for the Harmony footswitch.



FS will disappear after a second and either **T1** (for toggle mode) or **M1** (for momentary mode) will appear. Toggle mode turns the Harmony Voicings on or off with a single press of the footswitch. Momentary mode turns the Harmony Voicings



on only as long as the footswitch is held. Once it is released, the Harmony Voicings are bypassed. Select the desired mode using the +/- buttons.

Low-cut Filter On/Off

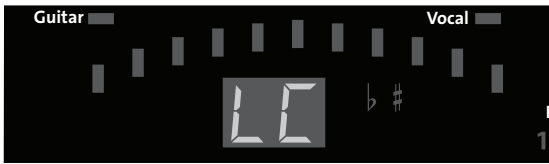

Press Setup until **LC** appears in the Display. This is the Low Cut filter setup menu that lets you turn the 75 Hz Low Cut filter on or off.

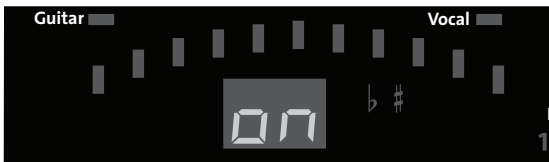

After a moment the **LC** will disappear and the Display will show whether the Low Cut filter is turned on or off.



Pressing the + or – buttons to enable or disable the Low Cut filter.

Chorus Depth



Press Setup until **Cd** appears in the Display. This is the Chorus Depth setup menu.

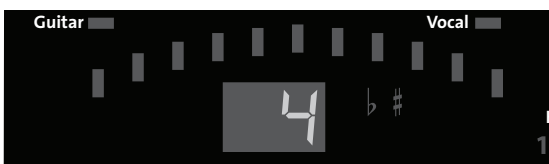

The **Cd** will disappear after a second and a number from 1 to 10 will appear showing the current Chorus Depth. Select the desired Chorus Depth using the +/- buttons.

Chorus Speed

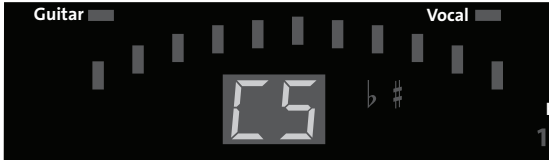

Press Setup until **CS** appears in the Display. This is the Chorus Speed setup menu.

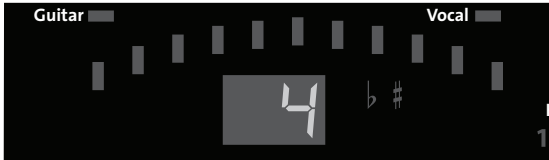

The **CS** will disappear after a second and a number from 1 to 10 will appear showing the current Chorus Speed. Select the desired Chorus Speed using the +/- buttons.

Guitar Reverb Send Level



Press Setup until **GR** appears in the Display. This is the Guitar Reverb Send setup menu.

This send level adjustment is handy in that you can set the amount of reverb applied to the guitar signal separately from the reverb level applied to the vocals. With this level set to 0, there will be no reverb on the

guitar signal even when the main Reverb level control is turned up.

The **GR** will disappear after a moment and a number from 1 to 10 will appear showing the current Guitar Reverb Send Level. Select the desired send level using the +/- buttons.

Noise Gate

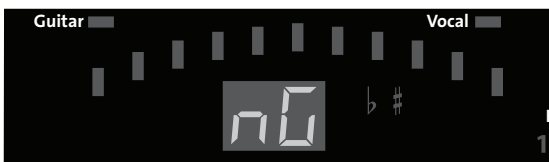

Press Setup until **NG** appears in the Display. This is the Noise Gate setup menu where you can adjust the Noise Gate Threshold.

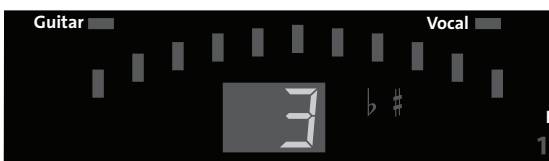

After a moment the **NG** will disappear and the display will show the current Noise Gate Threshold. The threshold can be adjusted from **0F** (noise

gate is off), 1 - 20. Higher numbers raise the threshold so you have to sing louder to open the gate and have your voice heard.

Effects Block Diagram

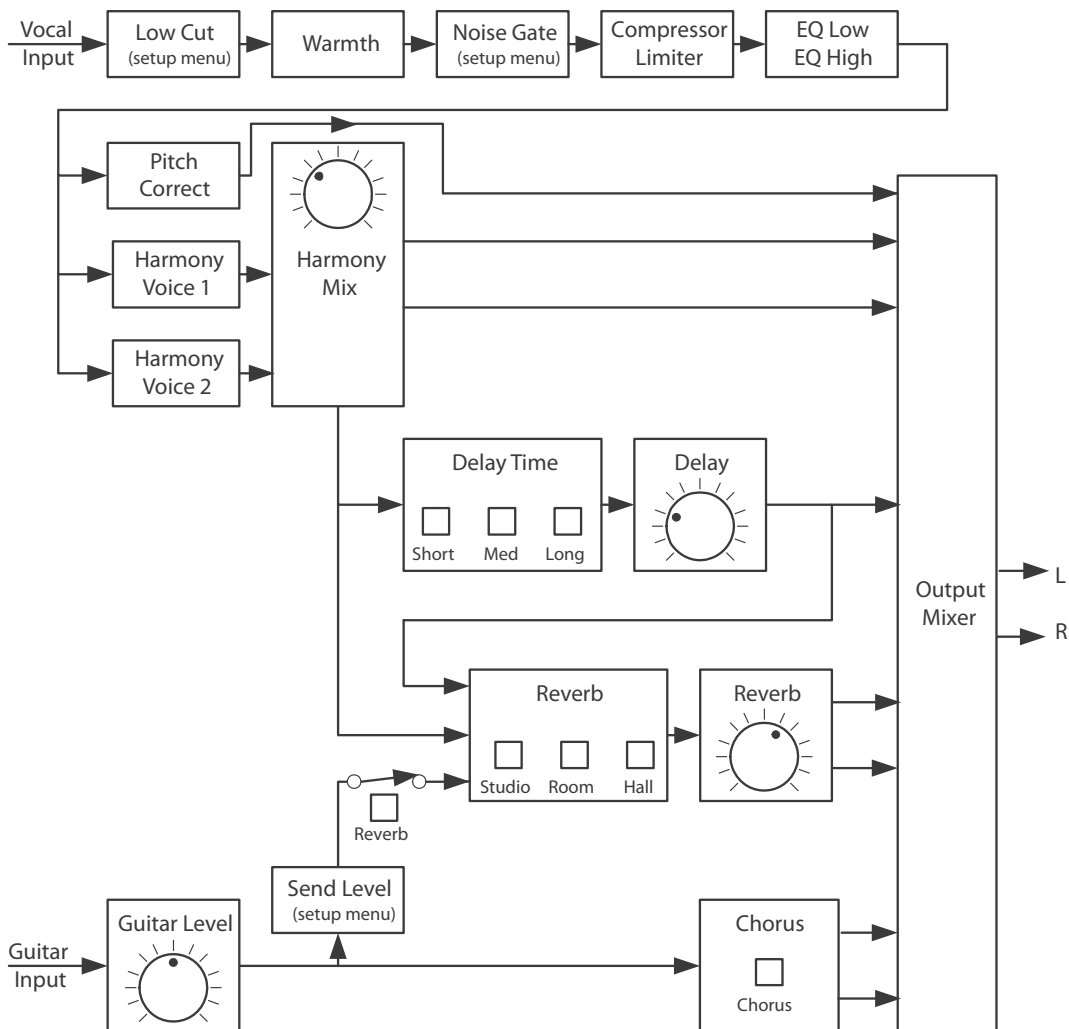

Factory Restore

In order to restore the patches and settings to their factory defaults follow these steps.

1. Make sure the Vocalist Live 3 is powered off.
2. Press and hold the Patch (-) and VI Voicing (+) buttons.
3. While continuing to hold the Patch (-) and VI Voicing (+) buttons, power up the Vocalist Live 3.
4. When $r \bar{E}$ is displayed, release the Patch (-) and VI Voicing (+) buttons.
5. Power down the unit. The Factory Reset procedure is complete.

Specifications

Mic Preamp

Connector:	XLR balanced
Input Sensitivity @ -4dBFS:	-35 dBu to +0 dBu
Equivalent Input Noise (EIN):	-126 dBu, 20 Hz - 20 kHz (A-Weighted)
Input Impedance:	1 k Ω Balanced

Line Input

Connector:	¼" TRS balanced / unbalanced
Input Sensitivity @ -4dBFS:	-13 dBu to +22 dBu
Input Impedance:	14.6 k Ω balanced, 8.4 k Ω unbalanced

Guitar Input / Guitar Thru:

Connectors:	¼" unbalanced
Impedance:	1 M Ω (input), 1 k Ω (thru)
Max Input Level at Thru Clip:	11.5 Vpp
Input Sensitivity @ 0dBFS:	6.5 Vpp

Outputs

Connectors:	XLR balanced
Output Level @ 0dBFS:	-6 dBu
Output Impedance:	135 Ω pseudo-balanced

Input (Line) to Output (Line) Performance

Dynamic Range:	106 dB, 20 Hz - 20 kHz (A-Weighted)
THD + Noise @ Min gain:	0.007% @ 1 kHz
Frequency Response @ Max gain:	-3 dB @ <20 Hz and >20 kHz

Analog to Digital Converter

Resolution:	24 bits
Sampling Rate:	44.1 kHz
Frequency Response:	-3 dB at <20 Hz and >20 kHz
Dynamic Range:	114 dB, A-weighted
Crosstalk:	-110 dB @ 1 kHz

Digital to Analog Converter

Resolution:	24 bits
Sampling Rate:	44.1 kHz
Frequency Response:	20 Hz – 20 kHz, +/- 0.5dB
Dynamic Range:	114 dB, A-weighted
Crosstalk:	-100 dB @ 1 kHz
Sample Rate:	44.1 kHz Internal Clock

Power

US and Canada:	120 VAC, 60 Hz Adapter: PS0913B - 120
Japan:	100 VAC, 50/60 Hz Adapter: PS0913B - 100
Europe:	230 VAC, 50 Hz Adapter: PS0913B - 230
UK:	240 VAC, 50 Hz Adapter: PS0913B - 240
Australia:	240 VAC, 50 Hz Adapter: PS0913B - 240-AU
AC Power Adapter Output:	9VAC, 1.3 A
Power Consumption:	8.1 watts

Product Dimensions:

8.25" (L) x 8.25" (W) x 2.5" (H)
210 mm(L) x 210mm(W) x 63.5mm(H)

Weight:

4.2 lbs., 1.9 kg

VOCALIST[®]

8760 South Sandy Parkway
Sandy, Utah 84070
PH (801) 566-8800
FAX (801) 566-7005

Vocalist[®] Live 3 Owner's Manual 18-0685-A

©2009 Harman International Industries, Incorporated, all rights reserved.

Vocalist is a registered trademark of Harman International Industries, Inc.

muslQ[®] is a registered trademark of 3dB Research Ltd.

Printed in the USA

H A Harman International Company