



SURGERY



---

Gefäßchirurgie	Chirurgie vasculaire
Vascular surgery	Cirurgía vascular
	Chirurgia vascolare

Katalog  
*Catalogue*  
Catalogue  
*Catálogo*  
Catalogo

No. **115**



Kataloge  
*Catalogues*

Catalogues  
*Catálogos*  
Cataloghi

Endoskopie  
*Endoscopy*

Endoscopia  
*Endoscopia*  
Endoscopia



Geräte  
*Units*  
Appareils  
*Equipos*  
Apparecchi

**ENDOSCOPY** No. **205**



Sinuskopie  
*Sinuscopy*  
Sinuscopie  
*Sinuscopía*  
Sinuscopia

**ENDOSCOPY** No. **211**



Optiken  
*Scopes*  
Optiques  
*Ópticas*  
Ottiche

**ENDOSCOPY** No. **206**



Mini & Mikro System für MIC  
*Mini & micro system for MIS*  
Système mini & mikro pour MIC  
*Sistema mini y micro para MIC*  
Sistema mini e micro per MIC

**ENDOSCOPY** No. **213**



Laparoskopie  
*Laparoscopy*  
Laparoscopie  
*Laparoscopia*  
Laparoscopia

**ENDOSCOPY** No. **207**

Sterilisation  
*Sterilization*

Stérilisation  
*Esterilización*  
Sterilizzazione



Urologie  
*Urology*  
Urologie  
*Urología*  
Urologia

**ENDOSCOPY** No. **208**



Steril Container - System I  
*Sterile container - system I*  
Contenaires pour stérilisation - système I  
*Contenedores para esterilización - sistema I*  
Container per sterilizzazione - sistema I

**STERILIZATION** No. **302**



Gynäkologie  
*Gynaecology*  
Gynécologie  
*Ginecología*  
Ginecologia

**ENDOSCOPY** No. **209**



Steril Container - System II  
*Sterile container - system II*  
Contenaires pour stérilisation - système II  
*Contenedores para esterilización - sistema II*  
Container per sterilizzazione - sistema II

**STERILIZATION** No. **303**



Arthroskopie  
*Arthroscopy*  
Arthroscopie  
*Artroscopia*  
Artroscopia

**ENDOSCOPY** No. **210**

Kataloge  
Catalogues  
Catálogos  
Cataloghi

Chirurgie  
*Surgery*  
Chirurgie  
*Cirugía*  
Chirurgia

HNO  
*ENT*  
ORL  
*ORL*  
ORL



Hauptkatalog Chirurgie  
*Main catalogue surgery*  
Catalogue général  
*Catálogo general*  
Catalogo generale

**SURGERY** No. **111**



HNO Hauptkatalog  
*ENT main catalogue*  
ORL catalogue général  
*ORL catálogo general*  
ORL catalogo generale

**ENT** No. **501**



Plastische Chirurgie  
*Plastic surgery*  
Chirurgie plastique  
*Cirugía plástica*  
Chirurgia plastica

**SURGERY** No. **112**

Elektro Chirurgie  
*Electro surgery*  
Eléctrochirurgie  
*Electro-Cirugía*  
Elettrobisturi



Ophthalmologie  
*Ophthalmology*  
Ophtalmologie  
*Oftalmología*  
Oftalmologia

**SURGERY** No. **113**



Elektro Chirurgie  
*Electro surgery*  
Eléctrochirurgie  
*Electro-Cirugía*  
Elettrobisturi

**ENDOSCOPY** No. **212**



Traumatologie  
*Traumatology*  
Traumatologie  
*Traumatología*  
Traumatologia

**SURGERY** No. **114**

Dental  
*Dental*  
Dentaire  
*Dental*  
Dentale



Retraktor Systeme  
*Retractor systems*  
Systèmes des écarteurs  
*Sistema de retractores*  
Sistemi di retrattori

**SURGERY** No. **133**









Dental  
*Dental*  
Dentaire  
*Dental*  
Dentale

**DENTAL** No. **402**

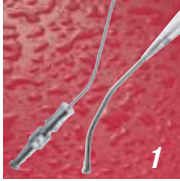
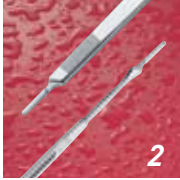

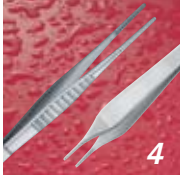
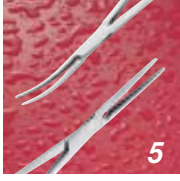
Aneurismen Clips  
*Aneurysm clips*  
Clips pour anévrismes  
*Clips para aneurismas*  
Clips per aneurismi

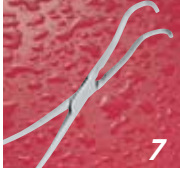
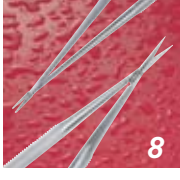
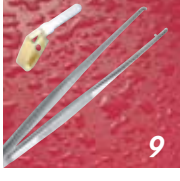
**SURGERY** No. **134**

	<b>Saugrohre</b> <i>Suction tubes</i>	Canules d'aspiration <i>Tubos de aspiración</i> Tubi per aspirazione	6 - 10
	<b>Skalpellgriffe und Klingen</b> <i>Scalpel handles and blades</i>	Manches et lames de bistouri <i>Mangos y hojas de bisturí</i> Manici e lame per bisturi	11 - 14
	<b>Scheren</b> <i>Scissors</i>	Ciseaux <i>Tijeras</i> Forbici	15 - 46
	<b>Pinzetten</b> <i>Forceps</i>	Pinces <i>Pinzas</i> Pinze	47 - 53
	<b>Arterienklemmen</b> <i>Haemostatic forceps</i>	Pinces hémostatiques <i>Pinzas hemostáticas</i> Pinze emostatiche	54 - 75
	<b>Bulldogklemmen</b> <i>Bulldog clamps</i>	Clamps Bulldog <i>Clamps Bulldog</i> Pinze Bulldog	76 - 83
	<b>Gefäßklemmen</b> <i>Vascular clamps</i>	Pinces vasculaires <i>Pinzas vasculares</i> Pinze vascolari	85 - 129
	<b>Mikro Instrumente</b> <i>Micro instruments</i>	Micro instruments <i>Instrumentos para micro cirugía</i> Strumenti per micro chirurgia	130 - 140
	<b>Gefäßclips und Anlegezangen</b> <i>Clips and applying forceps</i>	Clips et pinces à appliquer <i>Clips y aplicadores</i> Clips e pinze per mettere clips	142 - 149
	<b>Schlauchklemmen</b> <i>Tubing clamps</i>	Presse-tubes <i>Pinzas para tubos</i> Pinze serratubi	150 - 151

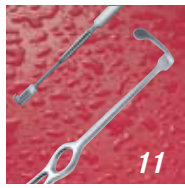

11

**Wundhaken**  
*Retractors*

Ecarteurs  
*Separadores*  
Divaricatori

152 - 169

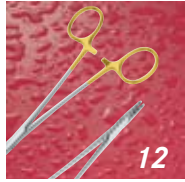

12

**Nadelhalter**  
*Needle holders*

Porte-aiguilles  
*Porta-agujas*  
Porta aghi

170 - 179

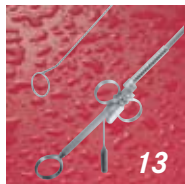

13

**Tourniquet und Gefäßstripper**  
*Tourniquet and vein strippers*

Tourniquet et tire-veines  
*Tourniquete y Fleboextractores*  
Tourniquet e tiravene

180 - 181

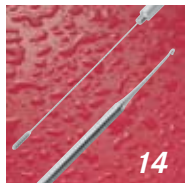

14

**Dissektoren und Gefäß-Dilatatoren**  
*Dissectors and vascular dilators*

Dissecteur et dilatateurs vasculaires  
*Disector y dilatadores vasculares*  
Dissettori e dilatatori vascolari

182 - 186



15

**Tunnelierbesteck**  
*Tunneling set*

Jeu pour tunnelisation  
*Juego de tunelización*  
Set per tunnelizzazione

187 - 189



16

**Aortastanzen**  
*Aorta punches*

Perforateurs pour l'aorte  
*Perforadores para aorta*  
Perforatori per aorta

190

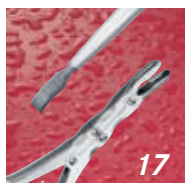

17

**Knochen-Instrumentarium**  
*Bone instruments*

Instruments pour la chirurgie osseuse  
*Instrumental para la cirugía ósea*  
Strumenti per chirurgia ossea

191 - 205

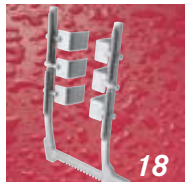

18

**Rippensperrer**  
*Rib retractors*

Ecarteurs des côtes  
*Separadores costales*  
Divaricatori costali

206 - 226

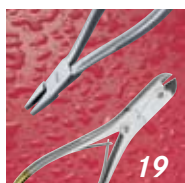

19

**Draht-Instrumentarium**  
*Wire instruments*

Instruments pour cerclage  
*Instrumental para cerclaje*  
Strumenti per cerchiaggio

227 - 231



20

**Index**  
*Index*

Index  
*Indice*  
Indice

232 - 257

Saugrohre  
Suction tubes

Canules d'aspiration  
Tubos de aspiración  
Tubi per aspirazione



POOLE		220 mm - 8"
8 mm Ø	23 Charr./Fr.	<b>tk 6308-22</b>



POOLE		220 mm - 8"
10 mm Ø	30 Charr./Fr.	<b>tk 6310-22</b>



ANDREWS-PYNCHON		235 mm - 9 1/4"
		<b>tk 6320-23</b>



DE BAKEY		275 mm - 10 3/4"
		<b>tk 6325-27</b>



tk 6350-02		
YANKAUER		270 mm - 10 3/4"
		<b>tk 6350-27</b>



**Saugrohre**  
**Suction tubes**

Canules d'aspiration  
Tubos de aspiración  
Tubi per aspirazione



**COOLEY**

1:3

	8 mm Ø
350 mm - 13 3/4"	<b>tk 6291-35</b>



1:3

	10 mm Ø
310 mm - 12 1/4"	<b>tk 6292-31</b>



1:3

	6 mm Ø
300 mm - 12"	<b>tk 6293-30</b>



1:3

	8 mm Ø
330 mm - 13"	<b>tk 6294-33</b>

Saugrohre  
Suction tubes

Canules d'aspiration  
Tubos de aspiración  
Tubi per aspirazione



1:2

HAMMERSMITH

x=	y=		295 mm - 11½"
9.5 mm	50 mm	Adult	<b>tk 6295-01</b>
8.0 mm	40 mm	Child	<b>tk 6295-02</b>
5.5 mm	25 mm	Infant	<b>tk 6295-03</b>



1:2

SOUTHAMPTON

180 mm - 8"
<b>tk 6296-00</b>

**Saugrohre**  
**Suction tubes**

Canules d'aspiration  
*Tubos de aspiración*  
Tubi per aspirazione



**FRAZIER**

		170 mm - 6 <sup>3</sup> / <sub>4</sub> "
2 mm Ø	6 Charr./Fr.	<b>tk 25230-06</b>
2 <sup>1</sup> / <sub>3</sub> mm Ø	7 Charr./Fr.	<b>tk 25230-07</b>
2 <sup>2</sup> / <sub>3</sub> mm Ø	8 Charr./Fr.	<b>tk 25230-08</b>
3 mm Ø	9 Charr./Fr.	<b>tk 25230-09</b>
3 <sup>1</sup> / <sub>3</sub> mm Ø	10 Charr./Fr.	<b>tk 25230-10</b>
4 mm Ø	12 Charr./Fr.	<b>tk 25230-12</b>
5 mm Ø	15 Charr./Fr.	<b>tk 25230-15</b>

1:2



**FERGUSSON**

		170 mm - 6 <sup>3</sup> / <sub>4</sub> "
2 mm Ø	6 Charr./Fr.	<b>tk 25228-06</b>
2 <sup>1</sup> / <sub>3</sub> mm Ø	7 Charr./Fr.	<b>tk 25228-07</b>
2 <sup>2</sup> / <sub>3</sub> mm Ø	8 Charr./Fr.	<b>tk 25228-08</b>
3 mm Ø	9 Charr./Fr.	<b>tk 25228-09</b>
3 <sup>1</sup> / <sub>3</sub> mm Ø	10 Charr./Fr.	<b>tk 25228-10</b>
4 mm Ø	12 Charr./Fr.	<b>tk 25228-12</b>
5 mm Ø	15 Charr./Fr.	<b>tk 25228-15</b>

1:2

Absaugaufsätze  
Profusion vents

Raccords d'aspiration  
Terminales para aspiración  
Terminali per aspirazione

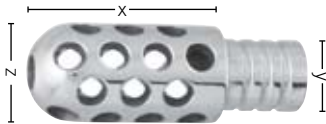

ROSS - ATRIAL BASKET

x=	y=	z=	
29 mm	12 mm	19 mm	<b>tk 6251-01</b>
29 mm	9 mm	15 mm	<b>tk 6251-02</b>
19 mm	9 mm	15 mm	<b>tk 6251-03</b>
16 mm	6 mm	12 mm	<b>tk 6251-04</b>

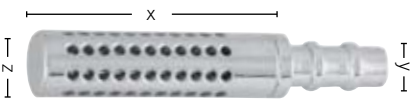

ROSS - SUMP SUCKER

	x=	y=	z=	
Adult	30 mm	5 mm	7.5 mm	<b>tk 6252-01</b>
Child	20 mm	5 mm	6.5 mm	<b>tk 6252-02</b>
Infant	15 mm	3 mm	5.0 mm	<b>tk 6252-03</b>

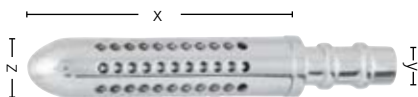

ROSS - VENTRICULAR VENT

	x=	y=	z=	
Adult	35 mm	5 mm	7.5 mm	<b>tk 6253-01</b>
Child	25 mm	5 mm	6.5 mm	<b>tk 6253-02</b>
Infant	16 mm	3 mm	5.0 mm	<b>tk 6253-03</b>



x=	y=	z=	
12 mm	6 mm	6 mm	<b>tk 6254-01</b>
12 mm	8 mm	8 mm	<b>tk 6254-02</b>
12 mm	9 mm	9 mm	<b>tk 6254-03</b>

Y-Verbindungstück für Herz-Lungen-Maschinen  
Y-connector for heart- lung machines

Connecteur en Y pour des coeur-poumons artificial  
Connexión en Y para corazón-pulmónes artificiales  
Connettore a Y per cuore-polmone artificiale

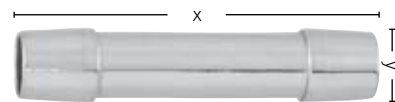

x=	y=	
54 mm	12 mm	<b>tk 6255-01</b>
54 mm	9 mm	<b>tk 6255-02</b>
38 mm	6 mm	<b>tk 6255-03</b>
38 mm	5 mm	<b>tk 6255-04</b>

Gerades Verbindungstück für Herz-Lungen-Maschinen  
Straight connector for heart- lung machines

Connecteur droit pour des coeur-poumons artificial  
Connexión recta para corazón-pulmónes artificiales  
Connettore retto per cuore-polmone artificiale

**Skalpellgriffe**  
*Scalpel handles*

Manches pour bistouri  
*Mangos de bisturí*  
Manici per bisturi



Für Klagen Fig. 18 - 25  
*For blades Fig. 18 - 25*  
Pour lames Fig. 18 - 25  
*Para hojas Fig. 18 - 25*  
Per lame Fig. 18 - 25

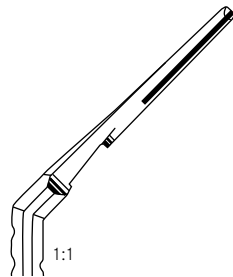

Fig. 4 L

**tk 7102-04**

**abgewinkelt**  
*angled on flat*  
coudé sur le plat  
*angulado*  
angolato



**STANDARD**

Fig. 4

**tk 7100-04**



Fig. 4 L

**tk 7101-04**



**COLLIN**

Fig. 8

**tk 7105-08**

**hohl**  
*hollow*  
creux  
*hueco*  
cavo



**BARRON**

Fig. 3

**tk 7113-03**

Skalpellsgriffe  
Scalpel handles

Manches pour bistouri  
Mangos de bisturí  
Manici per bisturi

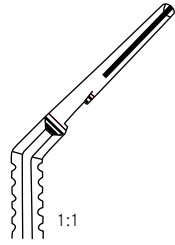

Fig. 3 L

**tk 7112-03**

abgewinkelt  
angled on flat  
coudé sur le plat  
angulado  
angolato



Für Klingen Fig. 10 - 15  
For blades Fig. 10 - 15  
Pour lames Fig. 10 - 15  
Para hojas Fig. 10 - 15  
Per lame Fig. 10 - 15



Fig. 3  
**tk 7110-03**



Fig. 3 L  
**tk 7111-03**



Fig. 7K  
**tk 7110-71**



Fig. 7  
**tk 7110-07**



Fig. 3 grad.  
**tk 7113-05**

graduirt  
graduated  
gradué  
graduado  
graduato



Fig. 3 R  
**tk 7115-03**



Fig. 3 RG  
**tk 7116-03**

**Skalpellklingen**  
**Scalpel blades**

Lames de bistouris  
Hojas de bisturí  
Lame per bisturi



Packung mit 100 Stück  
Package of 100 pieces  
Paquet de 100 pièces  
Paquetes de 100 piezas  
Confezione da 100 pezzi



Die abgebildeten Klingen sind steril  
The blades on this page are sterile  
Les lames de cette page sont stériles  
Las hojas de esta página son estériles  
Le lame illustrate sono sterili

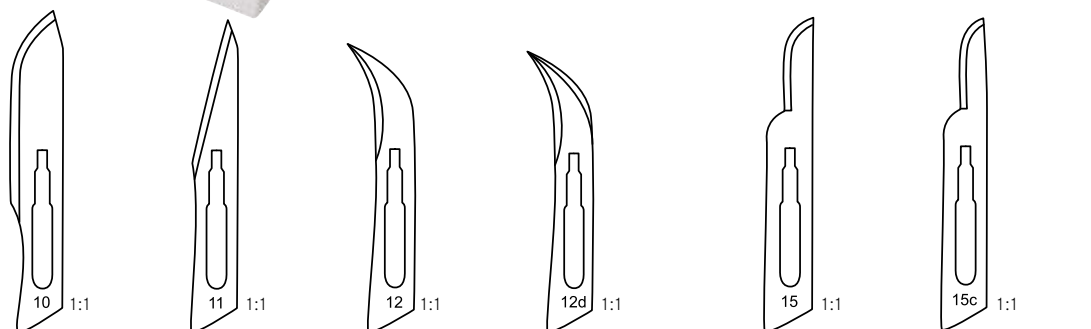

Fig. 10	Fig. 11	Fig. 12	Fig. 12d	Fig. 15	Fig. 15c
<b>tk 7210-10T</b>	<b>tk 7210-11T</b>	<b>tk 7210-12T</b>	<b>tk 7210-12DT</b>	<b>tk 7210-15T</b>	<b>tk 7210-15CT</b>

doppelschneidend  
double cutting edge  
double tranchante  
corta doble  
a doppio taglio

passend für Griffe: tk 7110-03, tk 7111-03, tk 7110-07, tk 7110-71, tk 7112-03, tk 7113-03, tk 7115-03, tk 7116-03  
for handles: tk 7110-03, tk 7111-03, tk 7110-07, tk 7110-71, tk 7112-03, tk 7113-03, tk 7115-03, tk 7116-03  
pour manches: tk 7110-03, tk 7111-03, tk 7110-07, tk 7110-71, tk 7112-03, tk 7113-03, tk 7115-03, tk 7116-03  
para mangos: tk 7110-03, tk 7111-03, tk 7110-07, tk 7110-71, tk 7112-03, tk 7113-03, tk 7115-03, tk 7116-03  
per manici: tk 7110-03, tk 7111-03, tk 7110-07, tk 7110-71, tk 7112-03, tk 7113-03, tk 7115-03, tk 7116-03

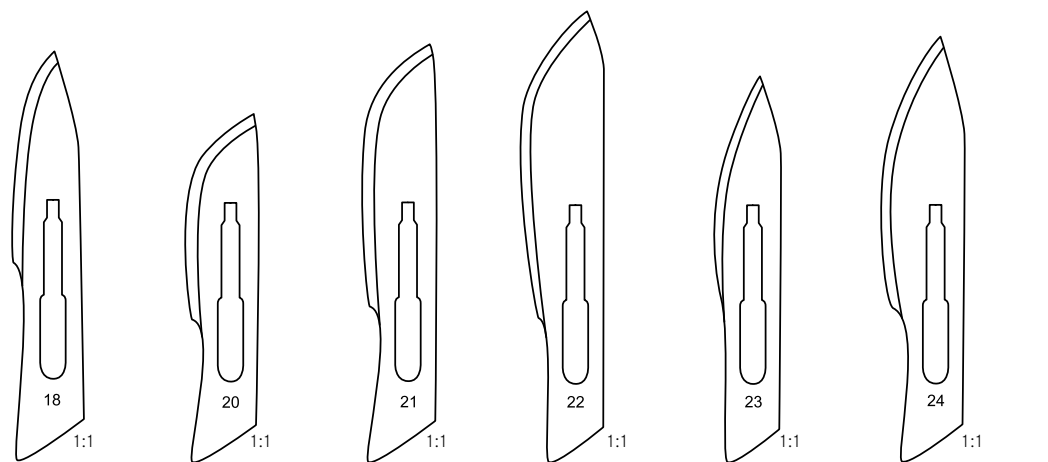

Fig. 18	Fig. 20	Fig. 21	Fig. 22	Fig. 23	Fig. 24
<b>tk 7210-18T</b>	<b>tk 7210-20T</b>	<b>tk 7210-21T</b>	<b>tk 7210-22T</b>	<b>tk 7210-23T</b>	<b>tk 7210-24T</b>

passend für Griffe: tk 7100-04, tk 7101-04, tk 7102-04, tk 7105-08  
for handles: tk 7100-04, tk 7101-04, tk 7102-04, tk 7105-08  
pour manches: tk 7100-04, tk 7101-04, tk 7102-04, tk 7105-08  
para mangos: tk 7100-04, tk 7101-04, tk 7102-04, tk 7105-08  
per manici: tk 7100-04, tk 7101-04, tk 7102-04, tk 7105-08

Mikro-Klingenhalter – Mikro-Klingen  
*Micro-blade holder – Micro-blades*

Porte micro-lames – Micro-lames  
*Porta para micro-hojas – Micro-hojas*  
 Porta micro-lame – Micro-lame



1:1

135 mm – 5¼"

**tk 7120-13**

**TITAN**



1:1

Fig. 3

**tk 7121-03**



1:1

Fig. 4

**tk 7121-04**



1:1

Fig. 7

**tk 7121-07**



1:1

Fig. 9

**tk 7121-09**

Mikro-Klingen – Packung mit 25 Stück

*Micro-blades – package of 25 pieces*

Micro-lames – paquet de 25 pièces

*Micro-hojas – paquete de 25 piezas*

Micro-lame – confezione da 25 pezzi



Die abgebildeten Klingen sind steril.

*The blades on this page are sterile.*

Les lames de cette page sont stériles.

*Las hojas de esta página son estériles.*

Le lame illustrate sono sterili.



# PRIMUSLINE

Scheren  
Scissors

Ciseaux  
Tijeras  
Forbici

TEKNO **PRIMUSLINE** Scheren sind Scheren von höchster Qualität. Sowohl die Bearbeitung der TEKNO **PRIMUSLINE** Scheren wie auch der Schliff der Schneide werden ausschließlich auf modernsten CNC Maschinen durchgeführt. Diese modernen Fertigungsverfahren erlauben höchste Maßgenauigkeit. Die Präzision der Schnittfläche und des Schraubenschlusses ermöglichen einen optimalen, lang anhaltenden Schnitt und Gang. Die Oberfläche der Branchen ist blendfrei gehalten um ein störungsfreies Arbeiten zu garantieren.

*TEKNO **PRIMUSLINE** scissors are surgical scissors of highest quality. The processing of the TEKNO **PRIMUSLINE** scissors, as well as the sharpening of the blades is done on advanced numeric controlled machines. These contemporary production methods allow the highest accuracy of measurements. The precision of the blades and the lock stand for a superior cutting quality. The non-reflective surface of the handles guarantees an interference free working*

TEKNO **PRIMUSLINE** ciseaux sont des instruments chirurgicaux de qualité supérieure. L'usinage des ciseaux TEKNO **PRIMUSLINE** et le tranchant des lames sont exécutés sur des centres de contrôle numérique les plus modernes. Ces procédés de fabrication innovatifs offrent le plus haut degré d'exactitude. La précision du coupe des lame et du raccord vissé permettent une qualité de coupe excellente. Le surface anti-éblouissante des branches garantit un travail sans perturbations.

*TEKNO **PRIMUSLINE** tijeras son instrumentos quirurgicos de alta calidad. La producción de las tijeras TEKNO **PRIMUSLINE** y también la afiladura de las hojas son realizados con máquinas modernas de control numérico. Estes procedimientos de fabricación de generación moderna garantizan el grado mas alto de exactitud. La alta precisión del filo de las hojas y del cierre permiten una calidad de corte exelente. La superficie antideslumbrante de los mangos garantiza un trabajo sin perturbaciones.*

Le forbici TEKNO **PRIMUSLINE** sono forbici chirurgiche di altissima qualità. Tutta la lavorazione della forbici TEKNO **PRIMUSLINE** nonché anche l'affilatura vengono eseguite esclusivamente su macchine numeriche modernissime. Questi processi di produzione garantiscono misure esatte. La precisione della superficie di taglio e funzionamento ottimale per lungo tempo. Le superficie non riflettente dell'impugnatura permettono un lavoro senza disturbi di luce.



Technische Informationen  
*Technical information*

Information technique  
*Información técnica*  
Informazione tecnica

# PRIMUSLINE

## Standard Cut

Hochwertige Scheren mit Standardschliff

*High performance scissors with standard cutting edges*

Ciseaux de haute qualité avec coupe standard

*Tijeras de alta calidad con afiladura estándar*

Forbici di altissima qualità con filettatura standard



## SuperCut

Osteotomschliff und Mikroverzahnung

Präzisere Präparation und minimal traumatisierender Schnitt

*Osteotom edges and micro serration*

*Precise dissection and minimal traumatizing cut*

Coupe ostéotome et dentelure micro

Dissection précise et minimal traumatique

*Corte osteotomo y dentado micro*

*Dissección precisa mínima traumática*

Affilatura a forma di osteotomo e dentellatura micro

Dissezione precisa e taglio minimamente traumatizzante



## TC Cut

Eingeschweisste Hartmetallschneiden mit Standardschliff

Lange Schnitthaltigkeit

*Welded tungsten-carbide cutting edges*

*Long lasting cutting ability*

Plaques en carbure de tungstène soudées dans les lames

Qualité de coupe continue

*Placas de carburo de tungsteno soldadas en las hojas*

*Calidad de corte permanente*

Lame saldate al carburo di tungsteno con filettatura standard

Lunga durata di taglio



Technische Informationen  
*Technical information*

Information technique  
*Información técnica*  
Informazione tecnica

# PRIMUSLINE

## TC SuperCut

Eingeschweisste Hartmetallschneiden, Osteotomschliff und Mikroverzahnung  
Lange Schnitthaltigkeit, präzisere Präparation und minimal traumatisierender Schnitt

*Welded tungsten-carbide cutting edges, osteotom edges and micro serration*

*Long lasting cutting ability, precise dissection and minimal traumatizing cut*

Plaques en carbure de tungstène, coupe ostéotome et dentelure micro  
Qualité de coupe continue, dissection précise et minimal traumatique

*Placas de carburo de tungsteno, corte osteotomo y dentado micro*  
*Calidad de corte permanente, dissección precisa mínima traumática*

Lame saldate al carburo di tungsteno con affilatura a forma di osteotomo e dentellatura micro  
Lunga durata di taglio, dissezione precisa e taglio minimamente traumatizzante



## Ceramic SuperCut

Eingeschweisste Hartmetallschneide mit Osteotomschliff und Mikroverzahnung, schwarze Keramikbeschichtung  
Lange Schnitthaltigkeit durch hohe Oberflächenhärte der Beschichtung, blendfreie Oberfläche, präzisere Präparation und minimal traumatisierender Schnitt

*Welded tungsten-carbide cutting edges with osteotom edges and micro serration, black ceramic coating*

*Long lasting cutting ability due to high surface hardness of the coating, anti-glaring surface, better vision, precise dissection and minimal traumatizing cut*

Plaques en carbure de tungstène, coupe ostéotome et dentelure micro, surface céramisée  
Qualité de coupe continue, dissection précise et minimal traumatique, surface anti-éblouissante

*Placas de carburo de tungsteno, corte osteotomo y dentado micro, superficie cerámica*  
*Calidad de corte permanente, dissección precisa mínima traumática, superficie antideslumbrante*

Lame saldate al carburo di tungsteno con affilatura a forma di osteotomo e dentellatura micro, rivestimento di ceramica.  
Lunga durata di taglio grazie all'alta durezza della superficie. Superficie antiriflesso, dissezione precisa e taglio minimamente traumatizzante



Scheren | Ciseaux  
 Scissors | Tijeras  
 Forbici

# PRIMUSLINE



**METZENBAUM**

STANDARD

140 mm - 5½"	tk 8323-14-A	tk 8333-14-A
150 mm - 6"		tk 8353-15-A
180 mm - 8"	tk 8343-18-A	tk 8353-18-A
200 mm - 8"	tk 8343-20-A	tk 8353-20-A
230 mm - 9"		tk 8353-23-A

SUPERCUT

140 mm - 5½"	tk 8323-14-B	tk 8333-14-B
150 mm - 6"		tk 8353-15-B
180 mm - 8"	tk 8343-18-B	tk 8353-18-B
200 mm - 8"	tk 8343-20-B	tk 8353-20-B
230 mm - 9"		tk 8353-23-B

TC CUT

140 mm - 5½"	tk 8323-14-C	tk 8333-14-C
180 mm - 8"	tk 8343-18-C	tk 8353-18-C
200 mm - 8"	tk 8343-20-C	tk 8353-20-C
230 mm - 9"		tk 8353-23-C

CERAMIC SUPERCUT

140 mm - 5½"	tk 8323-14-E	tk 8333-14-E
180 mm - 8"	tk 8343-18-E	tk 8353-18-E
200 mm - 8"	tk 8343-20-E	tk 8353-20-E
230 mm - 9"		tk 8353-23-E
250 mm - 9¾"		tk 8353-25-E

Scheren | Ciseaux  
 Scissors | Tijeras  
 Forbici

# PRIMUSLINE



1:1

## METZENBAUM FINO



<input type="checkbox"/> STANDARD	
140 mm - 5½"	<b>tk 8373-14-A</b>
180 mm - 8"	<b>tk 8381-18-A</b>
200 mm - 8"	<b>tk 8381-20-A</b>
<input checked="" type="checkbox"/> SUPERCUT	
140 mm - 5½"	<b>tk 8373-14-B</b>
180 mm - 8"	<b>tk 8381-18-B</b>
200 mm - 8"	<b>tk 8381-20-B</b>
<input checked="" type="checkbox"/> TC CUT	
140 mm - 5½"	<b>tk 8373-14-C</b>
180 mm - 8"	<b>tk 8381-18-C</b>
200 mm - 8"	<b>tk 8381-20-C</b>
<input checked="" type="checkbox"/> TC SUPERCUT	
180 mm - 8"	<b>tk 8381-18-D</b>
<input checked="" type="checkbox"/> CERAMIC SUPERCUT	
140 mm - 5½"	<b>tk 8373-14-E</b>
180 mm - 8"	<b>tk 8381-18-E</b>
200 mm - 8"	<b>tk 8381-20-E</b>



1:2

## BABY METZENBAUM

<input type="checkbox"/> STANDARD	
115 mm - 4½"	<b>tk 8333-11-A</b>
<input checked="" type="checkbox"/> SUPERCUT	
115 mm - 4½"	<b>tk 8333-11-B</b>
<input checked="" type="checkbox"/> TC CUT	
115 mm - 4½"	<b>tk 8333-11-C</b>
<input checked="" type="checkbox"/> TC SUPERCUT	
115 mm - 4½"	<b>tk 8333-11-D</b>
<input checked="" type="checkbox"/> CERAMIC SUPERCUT	
115 mm - 4½"	<b>tk 8333-11-E</b>



1:1

Scheren | Ciseaux  
 Scissors | Tijeras  
 Forbici

# PRIMUSLINE



**LEXER**

<input type="checkbox"/>	STANDARD	
	160 mm - 6¼"	<b>tk 8123-16-A</b>
<input checked="" type="checkbox"/>	SUPERCUT	
	160 mm - 6¼"	<b>tk 8123-16-B</b>
<input checked="" type="checkbox"/>	TC CUT	
	160 mm - 6¼"	<b>tk 8123-16-C</b>
<input checked="" type="checkbox"/>	TC SUPERCUT	
	160 mm - 6¼"	<b>tk 8123-16-D</b>
<input checked="" type="checkbox"/>	CERAMIC SUPERCUT	
	160 mm - 6¼"	<b>tk 8123-16-E</b>



**MAYO LEXER**

<input checked="" type="checkbox"/>	TC CUT	
	165 mm - 6½"	<b>tk 8125-16-C</b>
<input checked="" type="checkbox"/>	TC SUPERCUT	
	165 mm - 6½"	<b>tk 8125-16-D</b>
<input checked="" type="checkbox"/>	CERAMIC SUPERCUT	
	165 mm - 6½"	<b>tk 8125-16-E</b>

Scheren | Ciseaux  
 Scissors | Tijeras  
 Forbici

# PRIMUSLINE



1:2



1:1

**MAYO STILLE**

<input type="checkbox"/> STANDARD	
170 mm - 6¾"	<b>tk 8283-17-A</b>
<input checked="" type="checkbox"/> SUPERCUT	
170 mm - 6¾"	<b>tk 8283-17-B</b>
<input checked="" type="checkbox"/> TC CUT	
170 mm - 6¾"	<b>tk 8283-17-C</b>
<input checked="" type="checkbox"/> TC SUPERCUT	
170 mm - 6¾"	<b>tk 8283-17-D</b>
<input checked="" type="checkbox"/> CERAMIC SUPERCUT	
170 mm - 6¾"	<b>tk 8283-17-E</b>



1:1

**REYNOLDS**

<input type="checkbox"/> STANDARD	
140 mm - 5½"	<b>tk 8603-14-A</b>
160 mm - 6¼"	<b>tk 8603-16-A</b>
<input checked="" type="checkbox"/> CERAMIC SUPERCUT	
160 mm - 6¼"	<b>tk 8603-16-E</b>

Scheren  
Scissors

Ciseaux  
Tijeras  
Forbici

# PRIMUSLINE



1:2



1:1

## JOSEPH

<input type="checkbox"/> STANDARD	
150 mm - 6"	<b>tk 8693-14-A</b>
<input checked="" type="checkbox"/> SUPERCUT	
150 mm - 6"	<b>tk 8693-14-B</b>



1:2



1:1

## KELLY

<input type="checkbox"/> STANDARD	
160 mm - 6¼"	<b>tk 8463-16-A</b>
<input checked="" type="checkbox"/> SUPERCUT	
160 mm - 6¼"	<b>tk 8463-16-B</b>
<input checked="" type="checkbox"/> TC CUT	
160 mm - 6¼"	<b>tk 8463-16-C</b>
<input checked="" type="checkbox"/> TC SUPERCUT	
160 mm - 6¼"	<b>tk 8463-16-D</b>
<input checked="" type="checkbox"/> CERAMIC SUPERCUT	
160 mm - 6¼"	<b>tk 8463-16-E</b>



Scheren | Ciseaux  
 Scissors | Tijeras  
 | Forbici

# PRIMUSLINE



1:2



1:1

**STEVENS**

<input type="checkbox"/> STANDARD	
130 mm - 5"	<b>tk 8463-13-A</b>
<input checked="" type="checkbox"/> SUPERCUT	
130 mm - 5"	<b>tk 8463-13-B</b>

stumpf, gebogen  
*blunt, curved*  
 mousses, courbes  
*roma, curva*  
 smusse, curve



1:2



1:1

**IRIS**

<input checked="" type="checkbox"/> SUPERCUT	
115 mm - 4½"	<b>tk 9434-11-B</b>
<input checked="" type="checkbox"/> TC SUPERCUT	
115 mm - 4½"	<b>tk 9434-11-C</b>

spitz, gebogen  
*sharp, curved*  
 pointue, courbes  
*aguda, curva*  
 acuta, curve

# SUPERCUT<sup>TK</sup>

## SuperCut Scheren (SU) SuperCut scissors (SU)

---

Ciseaux SuperCut (SU)  
SuperCut tijeras (SU)  
Forbici con taglio SuperCut (SU)



Ein äußerst scharfer Osteotomschliff am oberen Scherenblatt gewährt das leichte Abscheren des Gewebes. Das zweite Scherenblatt ist leicht gezahnt, um das Abrutschen des Gewebes zu vermeiden. SuperCut-Scheren sind an einem goldenen Ring zu erkennen. Auf Wunsch kann jedes andere Modell in SuperCut geliefert werden. Auf Wunsch können SuperCut Scheren auch ohne Zahnung geliefert werden.

*An extremely sharp osteotome cut on the upper blade guarantees easy and precise cutting of the tissue. The other blade is slightly serrated for fixing the tissue. SuperCut scissors are indicated by one golden ring. Any other tekno scissors can be supplied as tekno SuperCut upon request. SuperCut scissors can be supplied upon request without serration.*

L'aiguisage extrêmement coupante «osteotome» de la lame supérieure, garantit une coupure facile et précise du tissu. La deuxième lame est légèrement dentelée pour tenir le tissu. Ciseaux SuperCut peuvent être identifiées à une bague d'orée. Tous les autres ciseaux peuvent être fournis en version SuperCut sur demande. Les ciseaux SuperCut peuvent être fournis également non dentelés sur demande.

*A través de un filo de "osteotomo" extremo agudo de una hoja es posible cortar facilmente precisamente el tejido. La segunda hoja tiene dientes muy suaves para evitar que se desliza el tejido. Las tijeras SuperCut se reconocen de un anillo dorado. Todas las otras tijeras pueden ser producidos en SuperCut segun demanda. Las tijeras SuperCut pueden ser producidos también sin dientes segun demanda.*

La affilatura speciale della lama superiore a forma di osteotomo da' un taglio estremamente facile e preciso. Una leggera dentatura sulla seconda lama evita che il tessuto scivoli. Per distinguersi dalle altre forbici, le forbici SuperCut hanno un anello dorato. Se richiesto le forbici SuperCut si forniscono pure senza la zigrinatura su una lama. Se richiesto ogni altro modello di forbici può essere fornito con taglio SuperCut.

**Technische Informationen**  
*Technical information*

Information technique  
*Información técnica*  
Informazione tecnica

140 mm - 5½"	<b>tk 8198-14</b>	<b>tk 9198-14</b>
140 mm - 5½"	<b>tk 8198-14 SU</b>	<b>tk 9198-14 SU</b>
140 mm - 5½"	<b>tk 8193-14 TC</b>	<b>tk 9193-14 TC</b>
140 mm - 5½"	<b>tk 8197-14 SU TC</b>	<b>tk 9197-14 SU TC</b>

gerade  
*straight*

droits  
*recta*

rette

gebogen  
*curved*

courbes

*curva*

curve



**standard**

Scheren aus rostfreiem Stahl mit Standardschliff für präzises Arbeiten.  
*Stainless steel scissors with standard cut for precise working.*

Ciseaux de acier inoxydable avec coupe standard pour des travaux précis.

*Tijeras de acero inoxidable con corte standard para un trabajo preciso.*

Forbici di acciaio inossidabile con filatura Standard per tagli precisi.



**super cut**

Messerschliff und Mikroverzahnung für einen feinen minimal traumatisierenden Schnitt.  
*Knife edges and micro serration for a fine and minimally traumatizing cut.*

Aiguisement tranchante et dents micro pour une coupe fine, peu traumatisante.

*Hoja de bisturi y dentadura micro para un corte fino, mínimo traumatizante.*

Affilatura a scalpello e dentellatura micro per uno taglio fine, minimo traumatizzante.

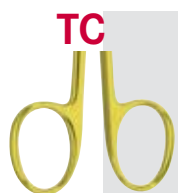

**tungsten carbide**

Nahtlos aufgeschweisste, korrosionsfreie Hartmetallschneiden.

*Seamless welded, corrosion-free tungsten carbide cutting edges.*

Plaques en carbure de tungstène, non-corrosives, soudées homogènement dans les lames.

*Placas de carburo de tungsteno soldadas homogéneamente y anticorrosiva en las hojas.*

Congiunzione omogenea senza cordolo lame saldate al carburo di tungsteno.



**super cut**

Nahtlos aufgeschweisste Hartmetallschneide mit Messerschliff und Mikroverzahnung

*Corrosion-free tungsten carbide plates, seamlessly welded into the jaws. Knife edges and micro serration.*

Plaques en carbure de tungstène, soudées homogènement das les lames. Aiguisement trachante et dents micro.

*Placas de caburo de tungsteno soldadas homogéneamente y en las hojas. Hojas de bisturi y dentura micro.*

"Tungston carbide" lame con taglio "super cut".

Gefäßscheren  
*Vascular scissors*

Ciseaux vasculaires  
*Tijeras vasculares*  
Forbici vascolari



145 mm - 5 $\frac{3}{4}$ "  
**tk 8722-14**

1 Blatt mit Sondenspitze  
*1 Blade with probe*  
1 Lame avec sonde  
*1 Punta forma sonda*  
1 Lama con sonda



LINCOLN

170 mm - 6 $\frac{3}{4}$ "



1:2

**tk 8724-17**



1:2

**tk 8725-17**



115 mm - 4 $\frac{1}{2}$ "  
**tk 8727-11**



FULTON

170 mm - 6 $\frac{3}{4}$ "

**tk 8730-17**

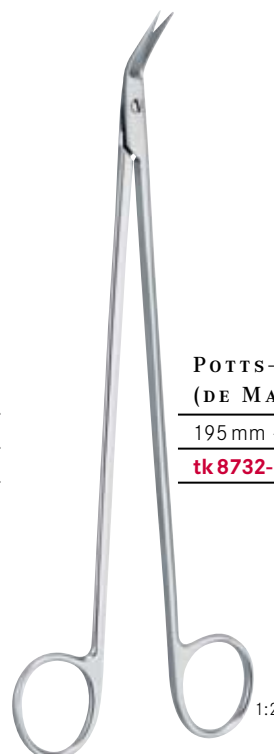

POTTS-SMITH  
(DE MARTEL)

195 mm - 7 $\frac{3}{4}$ "

**tk 8732-19**

**Gefäßscheren**  
**Vascular scissors**

Ciseaux vasculaires  
*Tijeras vasculares*  
Forbici vascolari





**FAVALORO**  
150 mm - 6"  
**tk 8740-15**

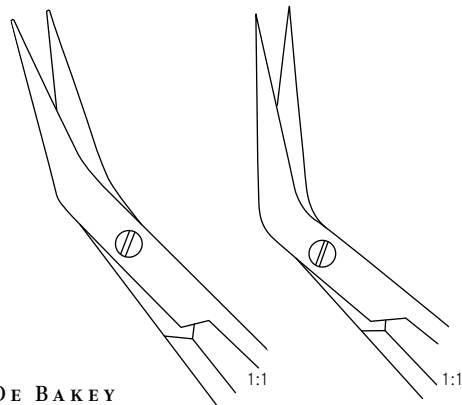

**DE BAKEY**  
155 mm - 6" **tk 8741-15** | **tk 8742-15**

Offset-Schere, S-förmig  
*Offset scissors, s-shaped*  
Ciseaux offset, courbes en S  
*Tijera offset, curva en S*  
Forbici offset, curve a forma di S

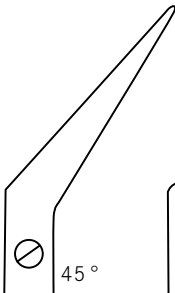
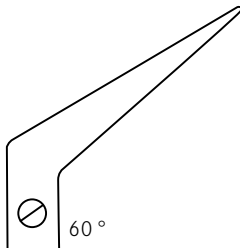

<b>DE BAKEY</b>	 25°	 45°	 60°
160 mm - 6¼"	<b>tk 8745-16</b>	<b>tk 8746-16</b>	<b>tk 8747-16</b>
230 mm - 9"	<b>tk 8745-23</b>	<b>tk 8746-23</b>	<b>tk 8747-23</b>
280 mm - 11"	<b>tk 8745-28</b>	<b>tk 8746-28</b>	<b>tk 8747-28</b>



**MILLS**  
225 mm - 8¾"  
**tk 8744-22**

Gefäßscheren  
Vascular scissors

Ciseaux vasculaires  
Tijeras vasculares  
Forbici vascolari



POTTS-DE  
MARTEL

190 mm - 7 1/2"

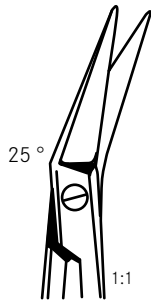

tk 8771-25

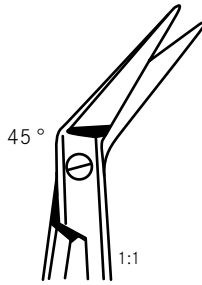

tk 8771-45

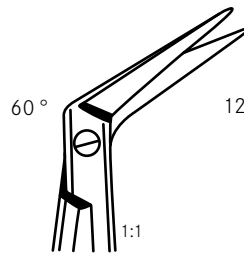

tk 8771-60

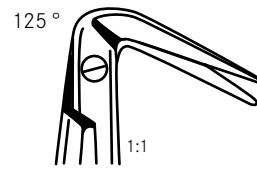

tk 8771-12

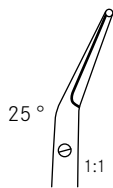

tk 8772-25

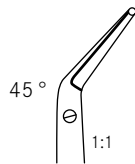

tk 8772-45

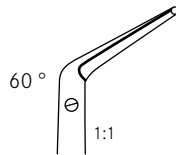

tk 8772-60

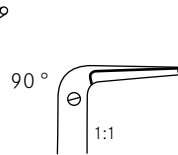

tk 8772-90

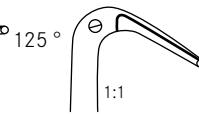

tk 8772-12

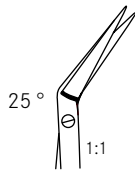

tk 8774-25

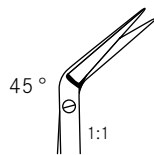

tk 8774-45

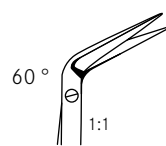

tk 8774-60

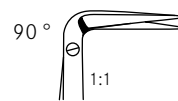

tk 8774-90

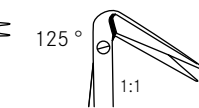

tk 8774-12

**Gefäßscheren**  
**Vascular scissors**

Ciseaux vasculaires  
*Tijeras vasculares*  
Forbici vascolari

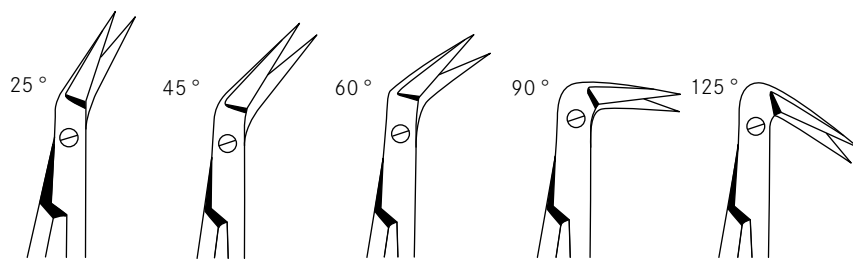

**DIETRICH-  
HEGEMANN**

145 mm - 5 <sup>3</sup> / <sub>4</sub> "	<b>tk 8754-14</b>	<b>tk 8755-14</b>	<b>tk 8756-14</b>	<b>tk 8757-14</b>	<b>tk 8758-14</b>
160 mm - 6 <sup>1</sup> / <sub>4</sub> "	<b>tk 8754-16</b>	<b>tk 8755-16</b>	<b>tk 8756-16</b>	<b>tk 8757-16</b>	<b>tk 8758-16</b>
190 mm - 7 <sup>1</sup> / <sub>2</sub> "	<b>tk 8754-19</b>	<b>tk 8755-19</b>	<b>tk 8756-19</b>	<b>tk 8757-19</b>	<b>tk 8758-19</b>

Gefäßscheren  
*Vascular scissors*

Ciseaux vasculaires  
*Tijeras vasculares*  
Forbici vascolari

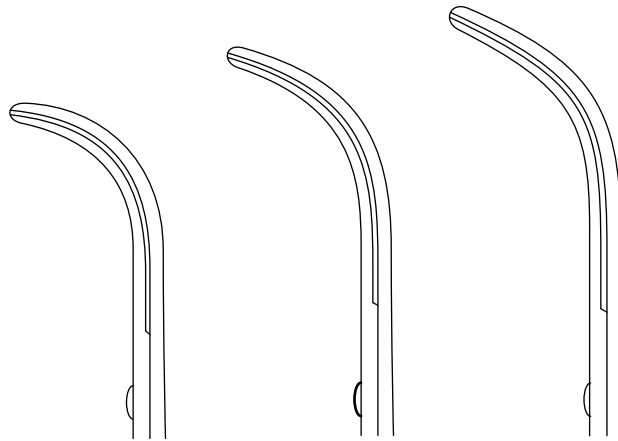

**HOHENFELLNER**

195 mm - 8 $\frac{3}{4}$ "	225 mm - 8 $\frac{3}{4}$ "	250 mm - 9 $\frac{3}{4}$ "
<b>tk 8728-18</b>	<b>tk 8728-21</b>	<b>tk 8728-24</b>



**Gefäßscheren**  
**Vascular scissors**

Ciseaux vasculaires  
*Tijeras vasculares*  
Forbici vascolari



DE BAKEY	25°	45°	60°
	160 mm - 6 1/4"	<b>tk 8775-16</b>	<b>tk 8776-16</b>
230 mm - 9"	<b>tk 8775-23</b>	<b>tk 8776-23</b>	<b>tk 8777-23</b>
280 mm - 11"	<b>tk 8775-28</b>	<b>tk 8776-28</b>	<b>tk 8777-28</b>

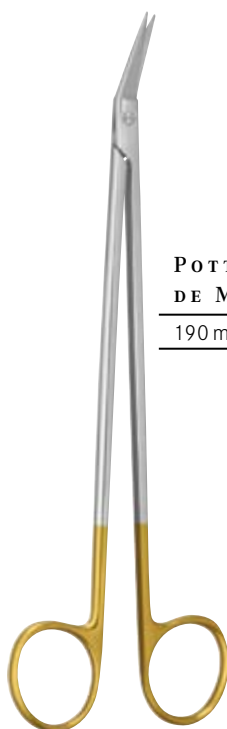

POTTS- DE MARTEL	25°	45°	60°
	190 mm - 7 1/2"	<b>tk 8773-25</b>	<b>tk 8773-45</b>

Lungenscheren  
Lobectomy scissors

Ciseaux à lobectomie  
Tijeras para lobectomia  
Forbici per lobectomia



CRAFOORD

300 mm - 12 "	<b>tk 8882-30</b>
---------------	-------------------

1:3



WILLAUER

250 mm - 9¾ "	<b>tk 8892-25</b>	<b>tk 8893-25</b>
280 mm - 11 "	<b>tk 8892-28</b>	<b>tk 8893-28</b>

gerade	gebogen
straight	curved
droits	courbes
recta	curva
rette	curve



FINOCHIETTO

270 mm - 10¾ "	<b>tk 8912-27</b>
----------------	-------------------



RESANO

250 mm - 10 "	<b>tk 8939-25</b>
---------------	-------------------

Knorpelscheren  
*Cartilage scissors*

Ciseaux pour cartilages  
*Tijeras para cartilagos*  
 Forbici per cartilagini



MARTIN-CARTILAGE

190 mm - 7½" tk 8747-19

gebogen, gezahnt  
*curved, saw edge*

courbes, dentelés  
*curva, dentada*  
 curve, dentate



MC INDOE

190 mm - 7½" tk 8752-19



POTTS-SMITH

190 mm - 7½" tk 8753-19

**Thoraxscheren**  
*Thorax scissors*

Ciseaux pour le thorax  
*Tijeras para el tórax*  
Forbici per torace



**SATINSKY**

245 mm - 9<sup>3</sup>/<sub>4</sub>"

**tk 8762-24**



**KLINKENBERG-LOTH**

230 mm - 9"

**tk 8767-23**



**JORGENSEN**

220 mm - 8<sup>3</sup>/<sub>4</sub>"

**tk 8769-22**

Sehnenscheren  
*Tenotomy scissors*

Ciseaux à ténatomie  
*Tijeras para tenotomía*  
 Forbici per tenotomia



WESTCOTT

110 mm - 4 1/4"



**tk 9352-11**

*spitz - spitz*  
*sharp - sharp*  
*pointue - pointue*  
*aguda - aguda*  
*acuta - acuta*



**tk 9357-11**

*stumpf - stumpf*  
*blunt - blunt*  
*mousse - mousse*  
*roma - roma*  
*smussa - smussa*

Tonsillenscheren  
*Tonsil scissors*

Ciseaux pour les amygdales  
*Tijera para amigdales*  
Forbici per tonsille

**TUCARTK**



TOENNIS-  
ADSON

170 mm - 6 $\frac{3}{4}$ "

**tk 9718-17 TC**

1:2



DEAN

170 mm - 6 $\frac{3}{4}$ "

**tk 8859-17 TC**

gebogen, gezahnt

*curved, saw edge*

curves, dentelés

*curvas, dentadas*

curve, dentate

1:2

Chirurgische Scheren  
*Operating scissors*

Ciseaux à chirurgie  
*Tijeras para cirugía*  
 Forbici per chirurgia



**MAYO**

145 mm - 5 $\frac{3}{4}$ "	<b>tk 8272-14</b>	<b>tk 8273-14</b>
150 mm - 6 $\frac{3}{4}$ "	<b>tk 8272-15</b>	<b>tk 8273-15</b>
170 mm - 6 $\frac{3}{4}$ "	<b>tk 8272-17</b>	<b>tk 8273-17</b>
230 mm - 9"	<b>tk 8272-23</b>	<b>tk 8273-23</b>
145 mm - 5 $\frac{3}{4}$ "	<b>tk 8272-14 SU</b>	<b>tk 8273-14 SU</b>
150 mm - 6 $\frac{3}{4}$ "	<b>tk 8272-15 SU</b>	<b>tk 8273-15 SU</b>
170 mm - 6 $\frac{3}{4}$ "	<b>tk 8272-17 SU</b>	<b>tk 8273-17 SU</b>
230 mm - 9"	<b>tk 8272-23 SU</b>	<b>tk 8273-23 SU</b>
145 mm - 5 $\frac{3}{4}$ "	<b>tk 8278-14 TC</b>	<b>tk 8279-14 TC</b>
170 mm - 6 $\frac{3}{4}$ "	<b>tk 8278-17 TC</b>	<b>tk 8279-17 TC</b>
230 mm - 9"	<b>tk 8278-23 TC</b>	<b>tk 8279-23 TC</b>

Chirurgische Scheren  
Operating scissors

Ciseaux à chirurgie  
Tijeras para cirugía  
Forbici per chirurgia



LEXER

160 mm - 6¼"	tk 8122-16	tk 8123-16
210 mm - 8¼"	tk 8122-21	tk 8123-21
160 mm - 6¼"	tk 8122-16 SU	tk 8123-16 SU
160 mm - 6¼"	tk 8138-16 TC	tk 8139-16 TC



KELLY

160 mm - 6¼"	tk 8462-16	tk 8463-16
180 mm - 7"	tk 8462-18	tk 8463-18

Fistel Scheren  
Fistula scissors

Ciseaux pour fistules  
Tijeras para fistulas  
Forbici per fistole



**Chirurgische Scheren**  
**Operating scissors**

Ciseaux à chirurgie  
Tijeras para cirugía  
Forbici per chirurgia



1:2

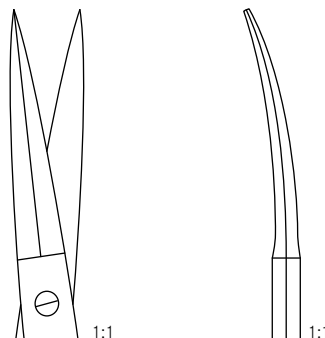

**PECK-JOSEF**

140 mm - 5½"	<b>tk 8198-14</b>	<b>tk 9198-14</b>
140 mm - 5½"	<b>tk 8198-14 SU</b>	<b>tk 9198-14 SU</b>
140 mm - 5½"	<b>tk 8193-14 TC</b>	<b>tk 9193-14 TC</b>
140 mm - 5½"	<b>tk 8197-14 SU TC</b>	<b>tk 9197-14 SU TC</b>



1:2



**BROPHY (SULLIVAN)**

145 mm - 5¾"	<b>tk 8572-14</b>	<b>tk 8573-14</b>
--------------	-------------------	-------------------

Chirurgische Scheren – Präparierscheren  
*Operating scissors – Dissecting scissors*

Ciseaux à chirurgie – Ciseaux à dissection  
*Tijeras para cirugía – Tijeras de disección*  
 Forbici per chirurgia – Forbici per dissezione



**METZENBAUM-NELSON**

	Fig. 1	Fig. 2	Fig. 3
115 mm – 4½"	<b>tk 8323-11</b>		
145 mm – 5¾"	<b>tk 8323-14</b>	<b>tk 8324-14</b>	<b>tk 8325-14</b>
150 mm – 6"	<b>tk 8343-15</b>		
180 mm – 7"	<b>tk 8343-18</b>	<b>tk 8344-18</b>	<b>tk 8345-18</b>
200 mm – 8"	<b>tk 8343-20</b>	<b>tk 8344-20</b>	<b>tk 8345-20</b>
230 mm – 9"	<b>tk 8343-23</b>	<b>tk 8344-23</b>	<b>tk 8345-23</b>
250 mm – 9¾"	<b>tk 8343-25</b>	<b>tk 8344-25</b>	<b>tk 8345-25</b>
280 mm – 11"	<b>tk 8343-28</b>	<b>tk 8344-28</b>	<b>tk 8345-28</b>
300 mm – 12"	<b>tk 8343-30</b>	<b>tk 8344-30</b>	<b>tk 8345-30</b>
145 mm – 5¾"	<b>tk 8323-14 SU</b>		
180 mm – 7"	<b>tk 8343-18 SU</b>		
200 mm – 8"	<b>tk 8343-20 SU</b>		
230 mm – 9"	<b>tk 8343-23 SU</b>		
115 mm – 4½"	<b>tk 8327-11 TC</b>		
145 mm – 5¾"	<b>tk 8327-14 TC</b>	<b>tk 8328-14 TC</b>	<b>tk 8329-14 TC</b>
180 mm – 7"	<b>tk 8347-18 TC</b>	<b>tk 8348-18 TC</b>	<b>tk 8349-18 TC</b>
200 mm – 8"	<b>tk 8347-20 TC</b>	<b>tk 8348-20 TC</b>	<b>tk 8349-20 TC</b>
230 mm – 9"	<b>tk 8347-23 TC</b>	<b>tk 8348-23 TC</b>	<b>tk 8349-23 TC</b>
250 mm – 9¾"	<b>tk 8347-25 TC</b>		
280 mm – 11"	<b>tk 8347-28 TC</b>		
300 mm – 12"	<b>tk 8347-30 TC</b>		

Chirurgische Scheren – Präparierscheren  
*Operating scissors – Dissecting scissors*

Ciseaux à chirurgie – Ciseaux à dissection  
*Tijeras para cirugía – Tijeras de disección*  
 Forbici per chirurgia – Forbici per dissezione



**METZENBAUM-NELSON**

	Fig. 1	Fig. 2	Fig. 3
115 mm - 4½"	<b>tk 8333-11</b>		
145 mm - 5¾"	<b>tk 8333-14</b>	<b>tk 8334-14</b>	<b>tk 8335-14</b>
150 mm - 6"	<b>tk 8353-15</b>		
180 mm - 7"	<b>tk 8353-18</b>	<b>tk 8354-18</b>	<b>tk 8356-18</b>
200 mm - 8"	<b>tk 8353-20</b>	<b>tk 8354-20</b>	<b>tk 8356-20</b>
230 mm - 9"	<b>tk 8353-23</b>	<b>tk 8354-23</b>	<b>tk 8356-23</b>
250 mm - 9¾"	<b>tk 8353-25</b>	<b>tk 8354-25</b>	<b>tk 8356-25</b>
280 mm - 11"	<b>tk 8353-28</b>	<b>tk 8354-28</b>	<b>tk 8356-28</b>
300 mm - 12"	<b>tk 8353-30</b>	<b>tk 8354-30</b>	<b>tk 8356-30</b>
145 mm - 5¾"	<b>tk 8333-14 SU</b>		
180 mm - 7"	<b>tk 8353-18 SU</b>		
200 mm - 8"	<b>tk 8353-20 SU</b>		
230 mm - 9"	<b>tk 8353-23 SU</b>		
115 mm - 4½"	<b>tk 8337-11 TC</b>		
145 mm - 5¾"	<b>tk 8337-14 TC</b>	<b>tk 8338-14 TC</b>	<b>tk 8339-14 TC</b>
180 mm - 7"	<b>tk 8357-18 TC</b>	<b>tk 8358-18 TC</b>	<b>tk 8359-18 TC</b>
200 mm - 8"	<b>tk 8357-20 TC</b>	<b>tk 8358-20 TC</b>	<b>tk 8359-20 TC</b>
230 mm - 9"	<b>tk 8357-23 TC</b>	<b>tk 8358-23 TC</b>	<b>tk 8359-23 TC</b>
250 mm - 9¾"	<b>tk 8357-25 TC</b>		
280 mm - 11"	<b>tk 8357-28 TC</b>		
300 mm - 12"	<b>tk 8357-30 TC</b>		

Chirurgische Scheren – Präparierscheren  
*Operating scissors – Dissecting scissors*

Ciseaux à chirurgie – Ciseaux à dissection  
*Tijeras para cirugía – Tijeras de disección*  
 Forbici per chirurgia – Forbici per dissezione



**METZENBAUM-FINO**

	Fig. 1	Fig. 3	Fig. 1	Fig. 3
145 mm - 5¾"	<b>tk 8372-14</b>	<b>tk 8374-14</b>	<b>tk 8373-14</b>	<b>tk 8375-14</b>
180 mm - 7"	<b>tk 8380-18</b>		<b>tk 8381-18</b>	
200 mm - 8"	<b>tk 8380-20</b>		<b>tk 8381-20</b>	
230 mm - 9"	<b>tk 8380-23</b>		<b>tk 8381-23</b>	
145 mm - 5¾"	<b>tk 8372-14 SU</b>		<b>tk 8373-14 SU</b>	
180 mm - 7"	<b>tk 8380-18 SU</b>		<b>tk 8381-18 SU</b>	
200 mm - 8"	<b>tk 8380-20 SU</b>		<b>tk 8381-20 SU</b>	
230 mm - 9"	<b>tk 8380-23 SU</b>		<b>tk 8381-23 SU</b>	
145 mm - 5¾"	<b>tk 8363-14 TC</b>	<b>tk 8366-14 TC</b>	<b>tk 8365-14 TC</b>	<b>tk 8367-14 TC</b>
180 mm - 7"	<b>tk 8370-18 TC</b>		<b>tk 8371-18 TC</b>	
200 mm - 8"	<b>tk 8370-20 TC</b>		<b>tk 8371-20 TC</b>	
230 mm - 9"	<b>tk 8370-23 TC</b>		<b>tk 8371-23 TC</b>	

**Feine Scheren**  
*Fine scissors*

Ciseaux fins  
*Tijeras finas*  
Forbici fini



**QUINBY**  
125 mm - 5" | **tk 8592-12**



1:2



**NEUMANN**  
120 mm - 4¾" | **tk 8597-12**

S-förmig gebogen  
*S curved*  
courbes en S  
*curva en S*  
curve a forma di S

1:2

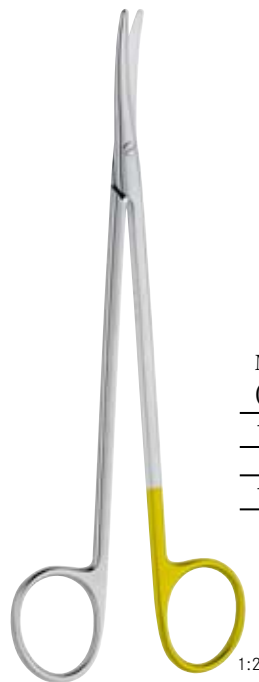

**MC INDOE  
(METZENBAUM)**  
180 mm - 7" | **tk 8352-18**  
180 mm - 7" | **tk 8352-18 SU**



1:2

Kurzes Maul  
*Short jaw*  
Mors court  
*Boca corta*  
Taglio corto



**LOCKLIN**  
165 mm - 6½" | **tk 8582-16** | **tk 8587-16**

gerade, gezahnt  
*straight, saw edge*  
droits, dentelées  
*recta, dentada*  
rette, dentate



gebogen, gezahnt  
*curved, saw edge*  
courbes, dentelées  
*curva, dentada*  
curve, dentate

1:2

1:2

Feine Scheren – Irisscheren  
*Fine scissors – Iris scissors*

Ciseaux fins – Ciseaux à iridectomie  
*Tijeras finas – Tijeras para iridectomia*  
*Forbici fini – Forbici per iridectomia*



1:2



1:1

1:1

**STRABISMUS-SCHERE**

115 mm – 4½"	<b>tk 9482-11</b>	<b>tk 9483-11</b>
115 mm – 4½"	<b>tk 9482-11 SU</b>	<b>tk 9483-11 SU</b>



1:1

1:1

90 mm – 3½"	<b>tk 8652-09</b>	<b>tk 8653-09</b>
100 mm – 4"	<b>tk 8652-10</b>	<b>tk 8653-10</b>
115 mm – 4½"	<b>tk 8652-11</b>	<b>tk 8653-11</b>
100 mm – 4"	<b>tk 8652-10 SU</b>	<b>tk 8653-10 SU</b>

Scheren für plastische Operationen  
*Plastic surgery scissors*

Ciseaux pour la chirurgie plastique  
*Tijeras para cirugía plástica*  
Forbici per chirurgia plastica



**REYNOLDS (JAMESON)**

160 mm - 6 $\frac{1}{4}$ "	<b>tk 8602-16</b>	<b>tk 8603-16</b>
180 mm - 7"	<b>tk 8602-18</b>	<b>tk 8603-18</b>
160 mm - 6 $\frac{1}{4}$ "	<b>tk 8602-16 SU</b>	<b>tk 8603-16 SU</b>
180 mm - 7"	<b>tk 8602-18 SU</b>	<b>tk 8603-18 SU</b>



**KILNER (RAGNELL)**

120 mm - 4 $\frac{3}{4}$ "	<b>tk 8697-12</b>
150 mm - 6"	<b>tk 8697-15</b>
120 mm - 4 $\frac{3}{4}$ "	<b>tk 8697-12 SU</b>
150 mm - 6"	<b>tk 8697-15 SU</b>
180 mm - 7"	<b>tk 8697-18 SU</b>
200 mm - 8"	<b>tk 8697-20 SU</b>
120 mm - 4 $\frac{3}{4}$ "	<b>tk 8698-12 TC</b>
150 mm - 6"	<b>tk 8698-15 TC</b>

Scheren für plastische Operationen  
*Plastic surgery scissors*

Ciseaux pour la chirurgie plastique  
*Tijeras para cirugía plástica*  
 Forbici per chirurgia plastica



**JOSEPH**

140 mm - 5½"	<b>tk 8692-14</b>	<b>tk 8693-14</b>
--------------	-------------------	-------------------



1:1



1:1



**GORNEY**

190 mm - 7½"	<b>tk 8702-20</b>	<b>tk 8703-20</b>
230 mm - 9"	<b>tk 8702-23</b>	<b>tk 8703-23</b>
180 mm - 7¼"	<b>tk 8704-18 SU</b>	<b>tk 8705-18 SU</b>
230 mm - 9"	<b>tk 8704-23 SU</b>	<b>tk 8705-23 SU</b>

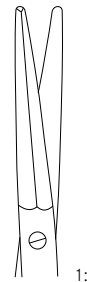

1:2



1:2



**Anatomische Pinzetten**  
*Dressing forceps*

Pinces à dissection  
*Pinzas de disección*  
Pinze anatomiche

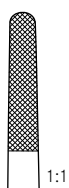

**STANDARD**

145 mm - 5¾"	<b>tk 11977-14</b>
200 mm - 8"	<b>tk 11977-20</b>
250 mm - 9¾"	<b>tk 11977-25</b>
300 mm - 12"	<b>tk 11977-30</b>

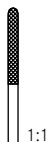

**MC INDOE**

150 mm - 6"	<b>tk 11640-15</b>
-------------	--------------------

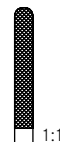

**POTTS-SMITH**

180 mm - 7"	<b>tk 11652-18</b>
210 mm - 8¼"	<b>tk 11652-21</b>
250 mm - 9¾"	<b>tk 11652-25</b>

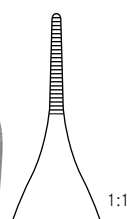

**ADSON**

120 mm - 4¾"	<b>tk 10502-12</b>
150 mm - 6"	<b>tk 10502-15</b>

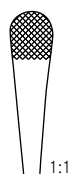

**WANGENSTEEN**

150 mm - 6"	<b>tk 10610-15</b>
230 mm - 9"	<b>tk 10610-23</b>



**CUSHING**

175 mm - 7"	<b>tk 10402-17</b>
-------------	--------------------

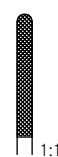

**TAYLOR**

180 mm - 7"	<b>tk 10415-18</b>
-------------	--------------------

Chirurgische Pinzetten  
Tissue forceps

Pinces à dissection à griffes  
Pinzas de disección con dientes  
Pinze chirurgiche

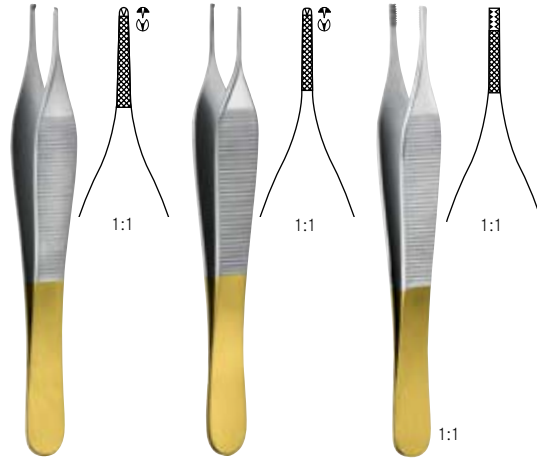

ADSON		ADSON-MICRO		ADSON-BROWN	
120 mm - 4 3/4"	<b>tk 10504-12</b>	<b>tk 10506-12</b>	<b>tk 10506-12</b>	<b>tk 10508-12</b>	<b>tk 10508-12</b>
150 mm - 6"	<b>tk 10504-15</b>	<b>tk 10506-15</b>	<b>tk 10506-15</b>		



GILLIES	
150 mm - 6"	<b>tk 11638-15</b>



OEHLER		
140 mm - 5 1/2"	160 mm - 4 1/4"	180 mm - 7"
<b>tk 11690-14</b>	<b>tk 11690-16</b>	<b>tk 11690-18</b>

200 mm - 8"	250 mm - 9 3/4"	300 mm - 12"
<b>tk 11690-20</b>	<b>tk 11690-25</b>	<b>tk 11690-30</b>

**Atraumatische Pinzetten**  
**Atraumatic tissue forceps**

Pinces atraumatiques  
 Pinzas de disección atraumáticas  
 Pinze per dissezione atraumatiche

**ATRAUMTK**

**TUCARTK**



**DE BAKEY**

	x = 1.5 mm	x = 2.0 mm
150 mm - 6"	<b>tk 11968-15</b>	<b>tk 11969-15</b>
190 mm - 7½"	<b>tk 11968-19</b>	<b>tk 11969-19</b>
240 mm - 9½"	<b>tk 11968-24</b>	<b>tk 11969-24</b>

Atraumatische Pinzetten  
Atraumatic tissue forceps

Pinces atraumatiques  
Pinzas de disección atraumáticas  
Pinze per dissezione atraumatiche

ATRAUMTK



x

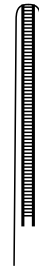
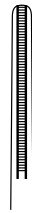
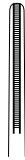
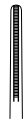

DE BAKEY

	x = 1.5 mm	x = 2.0 mm	x = 2.7 mm	x = 3.5 mm
120 mm - 4 <sup>3</sup> / <sub>4</sub> "	<b>tk 11960-12</b>			
145 mm - 5 <sup>3</sup> / <sub>4</sub> "	<b>tk 11960-14</b>	<b>tk 11964-14</b>		
160 mm - 6 <sup>1</sup> / <sub>4</sub> "	<b>tk 11960-16</b>	<b>tk 11964-16</b>	<b>tk 11966-16</b>	<b>tk 11965-16</b>
200 mm - 8 "	<b>tk 11960-20</b>	<b>tk 11964-20</b>	<b>tk 11966-20</b>	<b>tk 11965-20</b>
240 mm - 9 <sup>1</sup> / <sub>2</sub> "	<b>tk 11960-24</b>	<b>tk 11964-24</b>	<b>tk 11966-24</b>	<b>tk 11965-24</b>
300 mm - 12 "		<b>tk 11964-30</b>	<b>tk 11966-30</b>	<b>tk 11965-30</b>
350 mm - 14 "				<b>tk 11965-35</b>

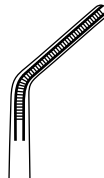
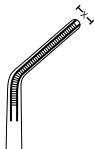

	x = 1.5 mm	x = 2.0 mm
145 mm - 5 <sup>3</sup> / <sub>4</sub> "	<b>tk 11967-14</b>	
160 mm - 6 <sup>1</sup> / <sub>4</sub> "		<b>tk 11967-16</b>
200 mm - 8 "		<b>tk 11967-20</b>
240 mm - 9 <sup>1</sup> / <sub>2</sub> "		<b>tk 11967-24</b>
300 mm - 12 "		<b>tk 11967-30</b>

**Atraumatische Pinzetten**  
**Atraumatic tissue forceps**

Pinces atraumatiques  
 Pinzas de disección atraumáticas  
 Pinze per dissezione atraumatiche

**ATRAUMTK**



DE BAKEY					
	x = 1.2 mm	x = 1.5 mm	x = 1.8 mm	x = 2.0 mm	x = 2.8 mm
160 mm - 6¼"	<b>tk 11970-16</b>	<b>tk 11971-16</b>	<b>tk 11972-16</b>	<b>tk 11975-16</b>	<b>tk 11976-16</b>
200 mm - 8"	<b>tk 11970-20</b>	<b>tk 11971-20</b>	<b>tk 11972-20</b>	<b>tk 11975-20</b>	<b>tk 11976-20</b>
240 mm - 9½"	<b>tk 11970-24</b>	<b>tk 11971-24</b>	<b>tk 11972-24</b>	<b>tk 11975-24</b>	<b>tk 11976-24</b>

**TITANK**

**Atraumatische Pinzetten**  
*Atraumatic tissue forceps*

**Pinces atraumatiques**  
*Pinzas de disección atraumáticas*  
*Pinze per dissezione atraumatiche*

**ATRAUM** **TK**



**DE BAKEY-ADSON**

125 mm - 5"	<b>tk 10510-12</b>
-------------	--------------------



**DE BAKEY-GERALD**

150 mm - 6"	<b>tk 10327-15</b>
180 mm - 7"	<b>tk 10327-18</b>



**DE BAKEY BAYONET**

180 mm - 7"	<b>tk 10328-18</b>
200 mm - 8"	<b>tk 10328-20</b>

**Atraumatische Pinzetten**  
**Atraumatic tissue forceps**

Pinces atraumatiques  
Pinzas de disección atraumáticas  
Pinze atraumatiche per dissezione

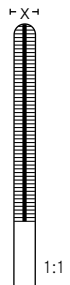
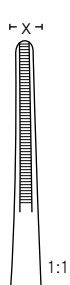

	x = 2.5 mm	x = 3.0 mm
150 mm - 6 "	<b>tk 11962-15</b>	<b>tk 11963-15</b>
200 mm - 8 "	<b>tk 11962-20</b>	<b>tk 11963-20</b>
240 mm - 9½ "	<b>tk 11962-24</b>	<b>tk 11963-24</b>

rostfrei  
stainless  
inoxydable  
inoxidable  
inossidabile

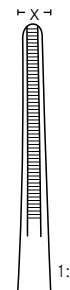
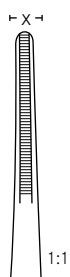

	x = 2.5 mm	x = 2.8 mm
150 mm - 6 "	<b>tk 11978-15</b>	<b>tk 11979-15</b>
200 mm - 8 "	<b>tk 11978-20</b>	<b>tk 11979-20</b>
240 mm - 9½ "	<b>tk 11978-24</b>	<b>tk 11979-24</b>



# PRIMUSLINE

Arterienklemmen  
*Haemostatic forceps*

---

Pinces hémostatiques  
*Pinzas hemostáticas*  
Pinze emostatiche



TEKNO **PRIMUSLINE** Arterienklemmen sind chirurgische Instrumente von höchster Qualität aus bestem rostfreiem Edelstahl, gefertigt von Spezialisten. Die Klemmen zeichnen sich durch besonders schlanke Maulteile und feinere Branchen aus.

*TEKNO PRIMUSLINE haemostatic forceps are surgical instruments of highest quality, made of high grade medical steel by specially skilled craftsmen. The forceps stand out of their extremely fine jaw parts and thinner handles.*

TEKNO **PRIMUSLINE** pinces hémostatiques sont des instruments chirurgicaux d'une qualité supérieure faites du meilleur acier inoxydable par des ouvriers bien spécialisés. Les pinces se distinguent par des mors plus fins et des branches plus graciles.

*TEKNO PRIMUSLINE pinzas hemostáticas son instrumentos quirúrgicos de alta calidad, producidos del mejor acero inoxidable por trabajadores bien especializados. Las pinzas se diferencian por las bocas muy finas y los mangos delgados.*

TEKNO **PRIMUSLINE** pinze emostatiche sono strumenti chirurgici di altissima qualità, fabbricate col migliore acciaio inossidabile da operai altamente specializzati. Le pinze si differenziano per il morso e le branche fini.



Gewebe- und Darmfazzangen  
*Tissue and intestinal holding forceps*

Pinces intestinales et de tissue  
*Pinzas para intestinos y tejidos*  
 Pinze per tessuti ed intestino

# PRIMUSLINE



**BABCOCK**

160 mm - 6¼"	<b>tk 28280-16-P</b>
180 mm - 7"	<b>tk 28280-18-P</b>
200 mm - 8"	<b>tk 28280-20-P</b>



**ALLIS**

150 mm - 6"	<b>tk 28140-15-P</b>	<b>tk 28160-15-P</b>
190 mm - 7½"		<b>tk 28160-19-P</b>

**Zähne** 4x5 5x6  
**Teeth**  
 Dents  
 Dientes  
 Denti



Arterienklemmen  
*Haemostatic forceps*

Pinces hémostatiques  
*Pinzas hemostáticas*  
Pinze emostatiche

# PRIMUSLINE



**KELLY**

140 mm - 5 1/2"	<b>tk 12040-14-P</b>	<b>tk 12041-14-P</b>
-----------------	----------------------	----------------------

**KELLY-RANKIN**

160 mm - 6 1/4"	<b>tk 12040-16-P</b>	<b>tk 12041-16-P</b>
-----------------	----------------------	----------------------

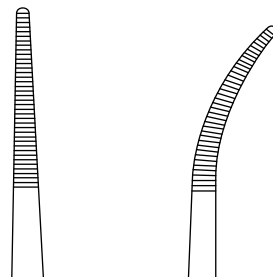

**CRILE**

140 mm - 5 1/2"	<b>tk 12050-14-P</b>	<b>tk 12051-14-P</b>
-----------------	----------------------	----------------------

**CRILE-RANKIN**

160 mm - 6 1/4"	<b>tk 12050-16-P</b>	<b>tk 12051-16-P</b>
-----------------	----------------------	----------------------

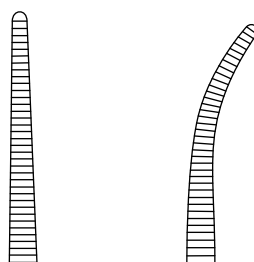

Arterienklemmen  
*Haemostatic forceps*

Pinces hémostatiques  
*Pinzas hemostáticas*  
Pinze emostatiche

# PRIMUSLINE



**P É A N**

130 mm - 5"	<b>tk 12058-13-P</b>	<b>tk 12059-13-P</b>
140 mm - 5½"	<b>tk 12058-14-P</b>	<b>tk 12059-14-P</b>
160 mm - 6¼"	<b>tk 12058-16-P</b>	<b>tk 12059-16-P</b>

graziles Modell  
*delicate pattern*  
modèle délicat  
*modelo delicado*  
modello delicato

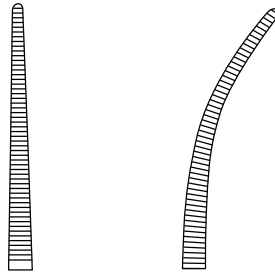

**K O C H E R**

130 mm - 5"	<b>tk 12078-13-P</b>	<b>tk 12079-13-P</b>
140 mm - 5½"	<b>tk 12078-14-P</b>	<b>tk 12079-14-P</b>
160 mm - 6¼"	<b>tk 12078-16-P</b>	<b>tk 12079-16-P</b>

graziles Modell  
*delicate pattern*  
modèle délicat  
*modelo delicado*  
modello delicato

1x2

1x2

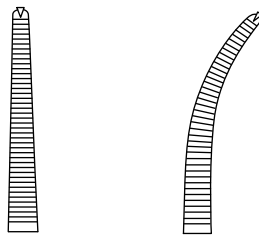

Arterienklemmen  
*Haemostatic forceps*

Pinces hémostatiques  
*Pinzas hemostáticas*  
Pinze emostatiche

# PRIMUSLINE



<b>PÉAN-FINO</b>						
	1:1	1:1	1:1	1:1	1:1	1:1
	145 mm - 5 3/4"	165 mm - 6 1/2"	185 mm - 7 1/4"	140 mm - 5 1/2"	160 mm - 6 1/4"	180 mm - 7"
	<b>tk 12062-14-P</b>	<b>tk 12062-16-P</b>	<b>tk 12062-18-P</b>	<b>tk 12063-14-P</b>	<b>tk 12063-16-P</b>	<b>tk 12063-18-P</b>



<b>KOCHER-FINO</b>						
	1:1	1:1	1:1	1:1	1:1	1:1
	145 mm - 5 3/4"	165 mm - 6 1/2"	185 mm - 7 1/4"	145 mm - 5 3/4"	160 mm - 6 1/4"	180 mm - 7"
	<b>tk 12082-14-P</b>	<b>tk 12082-16-P</b>	<b>tk 12082-18-P</b>	<b>tk 12083-14-P</b>	<b>tk 12083-16-P</b>	<b>tk 12083-18-P</b>
	1x2	1x2	1x2	1x2	1x2	1x2

Arterienklemmen  
Haemostatic forceps

Pinces hémostatiques  
Pinzas hemostáticas  
Pinze emostatiche



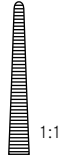
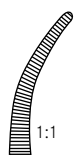

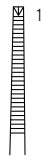

HARTMANN	 1:1	 1:1
	100 mm - 4"	tk 12000-10



TERRIER	 1x2
	85 mm - 3 <sup>3</sup> / <sub>4</sub> "



HALSTED- MOSQUITO	 1:1	 1:1	 1:1	 1:1	
	125 mm - 5"	tk 12010-12	tk 12011-12	tk 12012-12	tk 12013-12
	140 mm - 5 <sup>1</sup> / <sub>2</sub> "	tk 12010-14	tk 12011-14	tk 12012-14	tk 12013-14

1x2                      1x2

125 mm - 5"	tk 12110-12	tk 12111-12	tk 12112-12	tk 12113-12
-------------	-------------	-------------	-------------	-------------

1x2                      1x2



**Arterienklemmen**  
**Haemostatic forceps**

Pinces hémostatiques  
Pinzas hemostáticas  
Pinze emostatiche



**MICRO-  
MOSQUITO**

100 mm - 4"	<b>tk 12020-10</b>	<b>tk 12021-10</b>	<b>tk 12022-10</b>	<b>tk 12023-10</b>
120 mm - 4 3/4"	<b>tk 12020-12</b>	<b>tk 12021-12</b>	<b>tk 12022-12</b>	<b>tk 12023-12</b>

1x2

1x2



**PROVIDENCE-  
HOSPITAL**

140 mm - 5 1/2"	<b>tk 12020-14</b>	<b>tk 12021-14</b>
-----------------	--------------------	--------------------

1:2

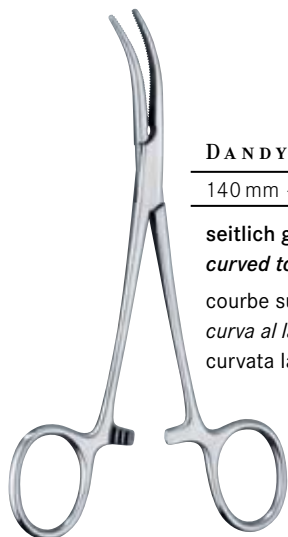

**DANDY**

140 mm - 5 1/2"	<b>tk 12030-14</b>	<b>tk 12032-14</b>
-----------------	--------------------	--------------------

seitlich gebogen  
*curved to the side*  
courbe sur le plat  
*curva al lado*  
curvata lateralmente

1x2

1:2



**MOSQUITO-  
DANDY**

120 mm - 4 3/4"	<b>tk 12031-12</b>
-----------------	--------------------

seitlich gebogen  
*curved to the side*  
courbe sur le plat  
*curva al lado*  
curvata lateralmente

1:2

**Arterienklemmen**  
*Haemostatic forceps*

Pinces hémostatiques  
*Pinzas hemostáticas*  
Pinze emostatiche



**CHRISTOPHE**

130 mm - 4"	<b>tk 12039-13</b>
150 mm - 6"	<b>tk 12039-15</b>

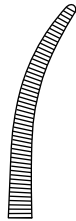

**LOVELACE**

155 mm - 6"	<b>tk 12195-15</b>	<b>tk 12196-15</b>
-------------	--------------------	--------------------

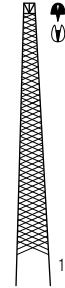

1x2



**LERICHE**

150 mm - 6"	<b>tk 12034-15</b>	<b>tk 12035-15</b>
-------------	--------------------	--------------------

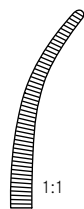
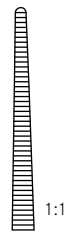

1:2



**LERICHE**

150 mm - 6"	<b>tk 12036-15</b>	<b>tk 12037-15</b>
-------------	--------------------	--------------------

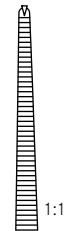

1x2

1x2

1:2



**Arterienklemmen**  
**Haemostatic forceps**

Pinces hémostatiques  
Pinzas hemostáticas  
Pinze emostatiche

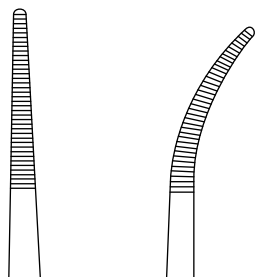

<b>KELLY</b>		
140 mm - 5 1/2"	<b>tk 12040-14</b>	<b>tk 12041-14</b>

<b>KELLY-RANKIN</b>		
160 mm - 6 1/4"	<b>tk 12040-16</b>	<b>tk 12041-16</b>

<b>KELLY</b>		
140 mm - 5 1/2"	<b>tk 12140-14</b>	<b>tk 12141-14</b>

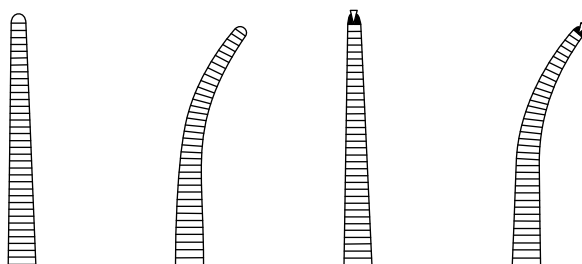

<b>CRILE</b>				
140 mm - 5 1/2"	<b>tk 12050-14</b>	<b>tk 12051-14</b>	<b>tk 12052-14</b>	<b>tk 12053-14</b>
			1x2	1x2

<b>CRILE-RANKIN</b>				
160 mm - 6 1/4"	<b>tk 12050-16</b>	<b>tk 12051-16</b>	<b>tk 12054-16</b>	<b>tk 12055-16</b>
			1x2	1x2

<b>CRILE</b>		
140 mm - 5 1/2"	<b>tk 12250-14</b>	<b>tk 12251-14</b>



Präparier- und Ligaturklemmen  
Dissecting and ligature forceps

Pincès à disséquer et à sutures  
Pinzas para preparación y suturas  
Pinze per preparazioni e suture

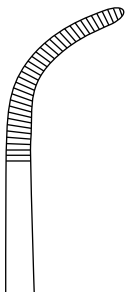
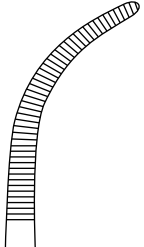
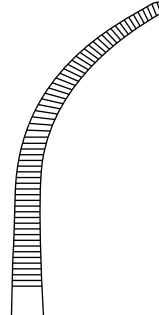
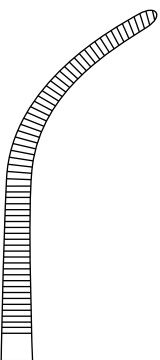

OVERHOLT-  
GEISSENDOERFER

				
	Fig. 0	Fig. 1	Fig. 2	Fig. 3
210 mm - 8 1/4"	<b>tk 12280-21</b>	<b>tk 12281-21</b>	<b>tk 12282-21</b>	<b>tk 12283-21</b>
270 mm - 10 3/4"	<b>tk 12280-27</b>	<b>tk 12281-27</b>	<b>tk 12282-27</b>	<b>tk 12283-27</b>

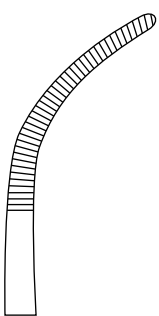
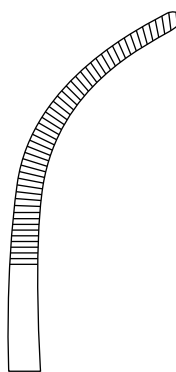
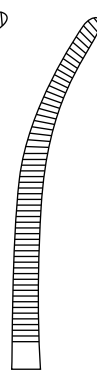
			
	Fig. 4	Fig. 5	Fig. 6
210 mm - 8 1/4"	<b>tk 12284-21</b>	<b>tk 12285-21</b>	<b>tk 12286-21</b>
270 mm - 10 3/4"	<b>tk 12284-27</b>	<b>tk 12285-27</b>	<b>tk 12286-27</b>

**Präparier- und Ligaturklemmen**  
*Dissecting and ligature forceps*

Pinces à disséquer et à sutures  
*Pinzas para preparación y suturas*  
Pinze per preparazioni e suture



**OVERHOLT-FINO**

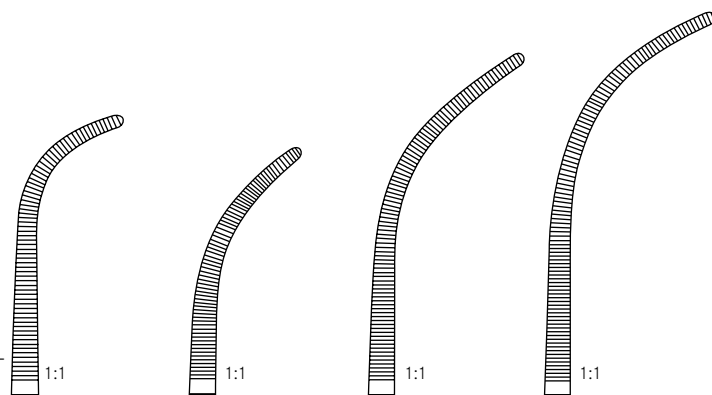

Fig. 0	Fig. 1	Fig. 2	Fig. 3	Fig. 6
215 mm - 8½"	210 mm - 8¼"	220 mm - 8¾"	230 mm - 9"	225 mm - 8¾"
<b>tk 12287-00</b>	<b>tk 12287-01</b>	<b>tk 12287-02</b>	<b>tk 12287-03</b>	<b>tk 12287-06</b>



**OVERHOLT**

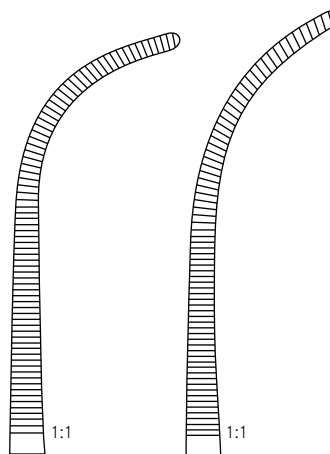
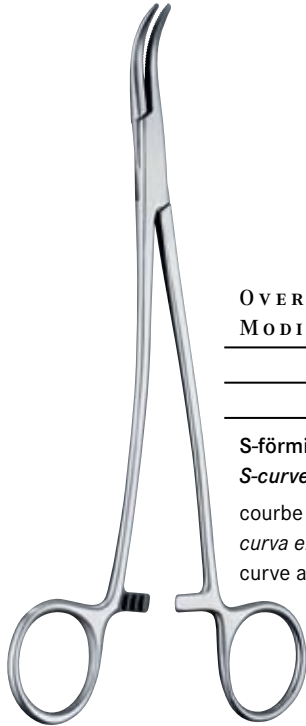

Fig. 0	Fig. 1	Fig. 6
295 mm - 8½"	295 mm - 8½"	300 mm - 8¾"
<b>tk 12288-00</b>	<b>tk 12288-01</b>	<b>tk 12288-06</b>

Präparier- und Ligaturklemmen  
Dissecting and ligature forceps

Pincès à disséquer et à sutures  
Pinzas para preparación y suturas  
Pinze per preparazioni e suture



OVERHOLT-  
MODIFIZIERT

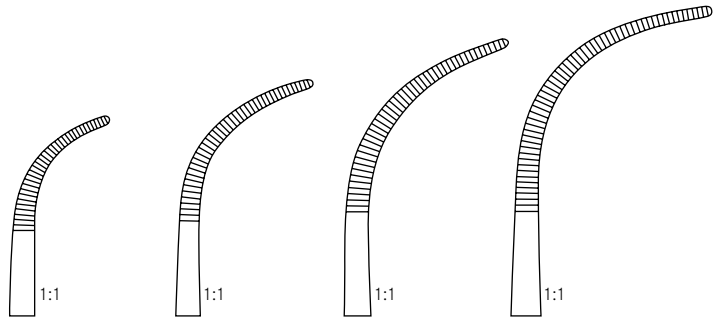

185 mm - 7 1/4"	205 mm - 8"	210 mm - 8 1/4"	215 mm - 8 1/2"
<b>tk 12235-01</b>	<b>tk 12235-02</b>	<b>tk 12235-03</b>	<b>tk 12235-04</b>

S-förmig gebogen  
*S-curved*  
courbe en S  
curva en S  
curve a forma di S

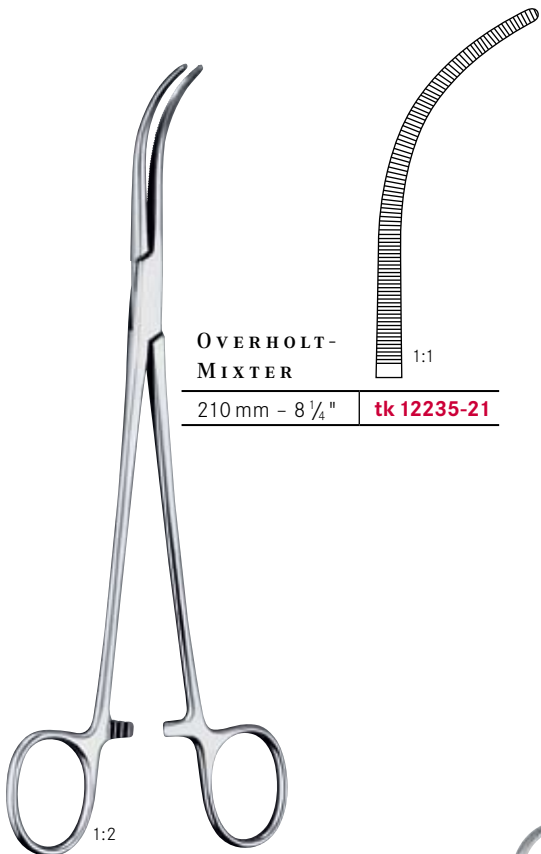

OVERHOLT-  
MIXTER

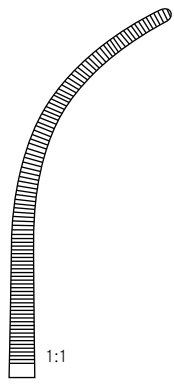

210 mm - 8 1/4"	<b>tk 12235-21</b>
-----------------	--------------------

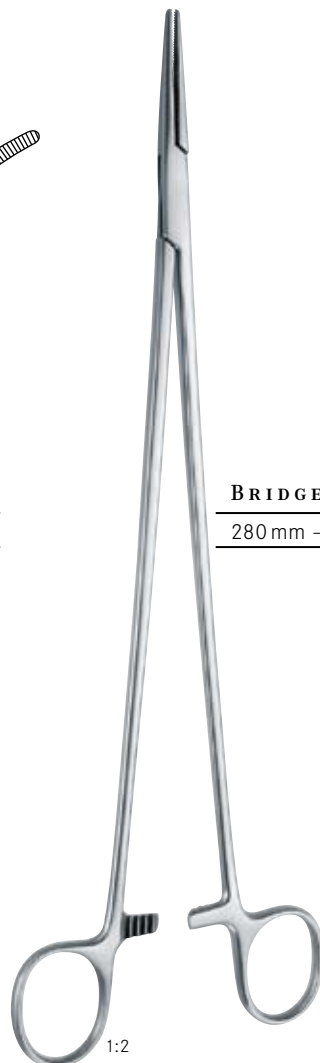

BRIDGE

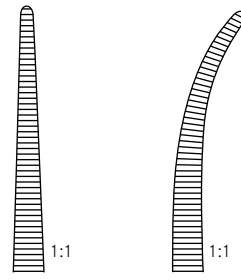

280 mm - 11"	<b>tk 12238-28</b>	<b>tk 12239-28</b>
--------------	--------------------	--------------------

**Präparier- und Ligaturklemmen**  
*Dissecting and ligature forceps*

Pinces à disséquer et à sutures  
*Pinzas para preparación y suturas*  
Pinze per preparazioni e suture



**GEMINI**

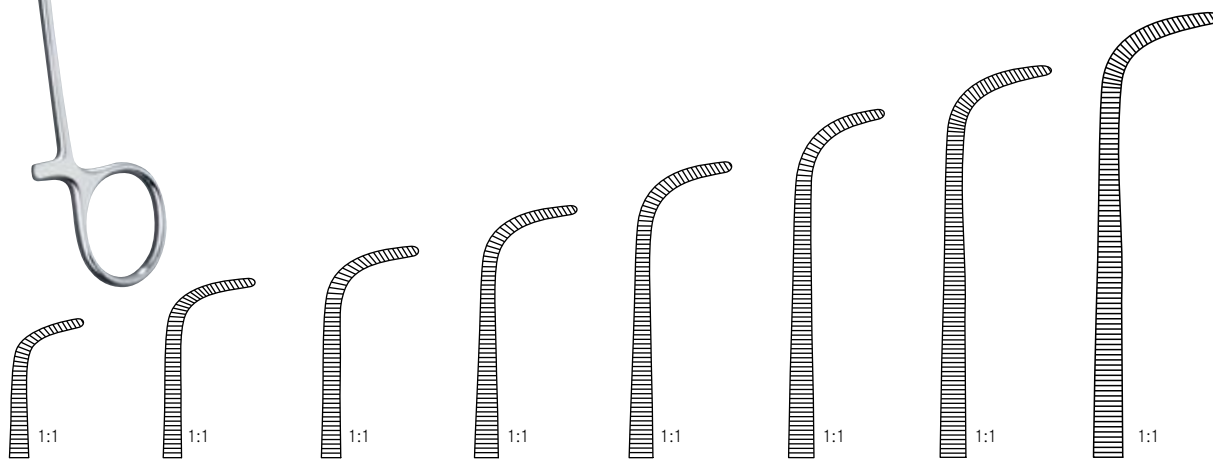

130 mm - 5 "	160 mm - 6¼ "	180 mm - 7 "	200 mm - 8 "	230 mm - 9 "	250 mm - 9¾ "	280 mm - 11 "	350 mm - 14 "
<b>tk 12290-13</b>	<b>tk 12290-16</b>	<b>tk 12290-18</b>	<b>tk 12290-20</b>	<b>tk 12290-23</b>	<b>tk 12290-25</b>	<b>tk 12290-28</b>	<b>tk 12290-35</b>



**MINI-GEMINI**

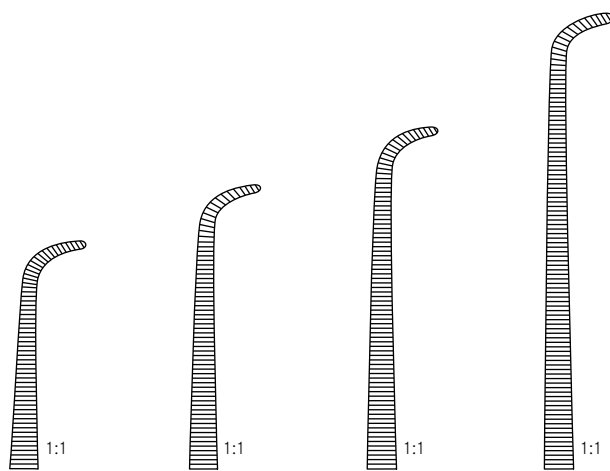

180 mm - 7 "	220 mm - 8¾ "	250 mm - 9¾ "	280 mm - 11 "
<b>tk 12291-18</b>	<b>tk 12291-22</b>	<b>tk 12291-25</b>	<b>tk 12291-28</b>

**Lungenfazzangen**  
*Lung grasping forceps*

Pinces-clamps pour poumons  
*Pinzas para coger pulmónes*  
Pinza per afferrare il polmone

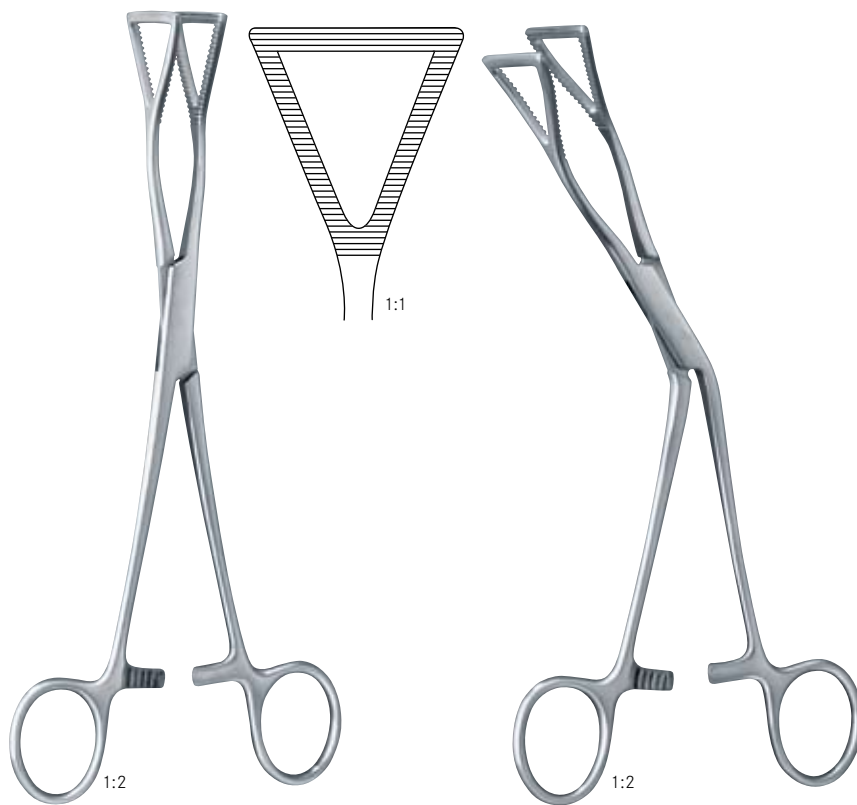

**LOVELACE**

200 mm - 8"

**tk 12495-20**

**tk 12496-20**

**Bronchus- und Gefäßklemmen**  
**Bronchus- and vascular clamps**

Pinces vasculaires et pour bronches  
Pinzas vasculares y bronquiales  
Pinze vascolari e per bronchi



PRICE-  
THOMAS

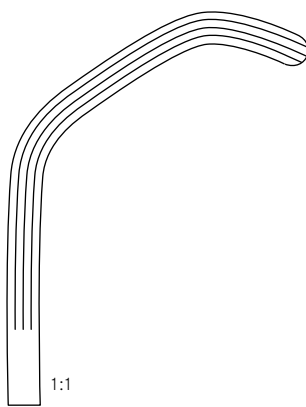

220 mm - 8 3/4" tk 12500-22



PRICE-  
THOMAS

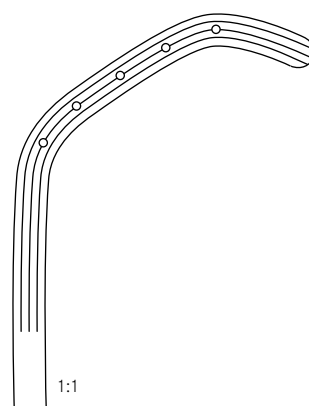
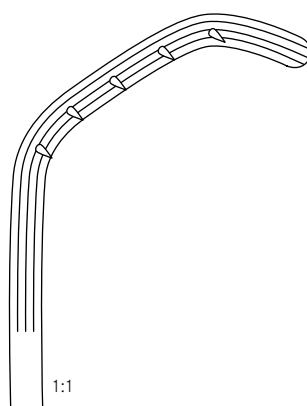

220 mm - 8 3/4" tk 12502-01

tk 12502-02

Stifte links  
Pins left

Goupilles à gauche  
Pernos izquierda  
Perni a sinistra

Stifte rechts  
Pins right

Goupilles à droit  
Pernos derecha  
Perni a destra

Bronchus- und Gefäßklemmen  
Bronchus- and vascular clamps

Pinces vasculaires et pour bronches  
Pinza clamps vasculares y bronquiales  
Pinze vascolari e per bronchi



1:2

SAROT

230 mm - 9"

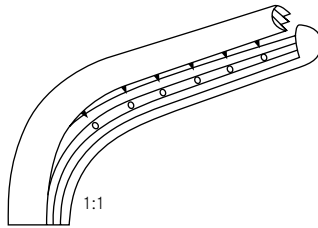

1:1

tk 12503-23

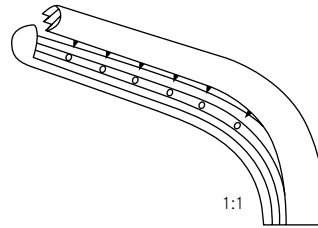

1:1

tk 12504-23

Stifte links  
Pins left

Goupilles à gauche  
Pernos izquierda  
Perni a sinistra

Stifte rechts  
Pins right

Goupilles à droit  
Pernos derecha  
Perni a destra



1:2

SEMB

240 mm - 9 1/2"

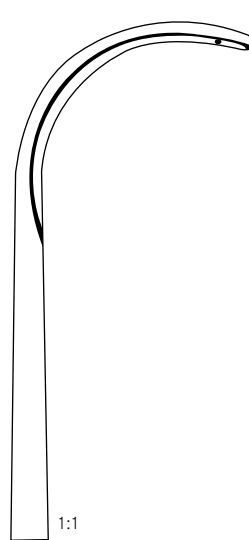

1:1

tk 12505-24



1:1

tk 12510-24



**Bronchus- und Gefäßklemmen**  
**Bronchus- and vascular clamps**

Pinces vasculaires et pour bronches  
Pinzas vasculares y bronquiales  
Pinze vascolari e per bronchi



**BABY-SATINSKY**

150 mm - 6"

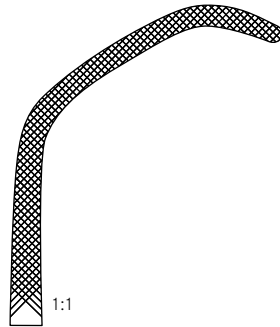

1:1

**tk 12545-15**

1:2



**SATINSKY**

265 mm - 10 1/2"

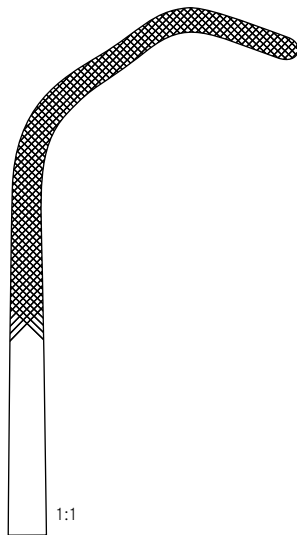

1:1

**tk 12550-01**

**tk 12551-01**

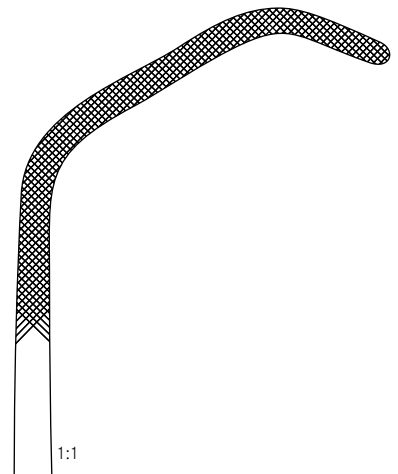

1:1

**tk 12550-02**

**tk 12551-02**

S-förmig gebogen  
*S-curved*  
courbe en S  
*curva en S*  
curva a forma di S

S-förmig gebogen  
*S-curved*  
courbe en S  
*curva en S*  
curva a forma di S

1:2

Gewebe- und Darmfazzangen  
Tissue and intestinal holding forceps

Pinces intestinales et de tissue  
Pinzas para tejidos y intestinos  
Pinze per tessuti ed intestino



ALLIS-BABY

130 mm - 5"	<b>tk 28100-14</b>
-------------	--------------------

Zähne 4x5

Teeth

Dents

Dientes

Denti



ALLIS

150 mm - 6"	<b>tk 28140-15</b>	<b>tk 28160-15</b>
-------------	--------------------	--------------------

190 mm - 7½"		<b>tk 28160-19</b>
--------------	--	--------------------

250 mm - 9¾"		<b>tk 28160-25</b>
--------------	--	--------------------

Zähne 4x5

5x6

Teeth

Dents

Dientes

Denti



ALLIS-ADAIR

155 mm - 6"	<b>tk 28167-15</b>
-------------	--------------------

Zähne 10x11

Teeth

Dents

Dientes

Denti



THOMS-ALLIS

200 mm - 8"	<b>tk 28180-20</b>
-------------	--------------------

6x7



LOCKWOOD

200 mm - 8"	<b>tk 28190-20</b>
-------------	--------------------

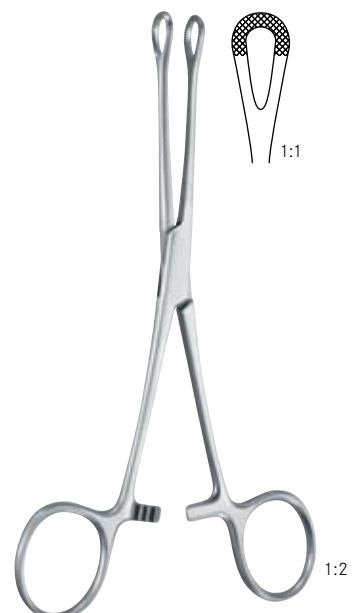

WILLIAMS

160 mm - 6¼"	<b>tk 28192-16</b>
--------------	--------------------

**Gewebe- und Darmfasszangen**  
**Tissue and intestinal holding forceps**

Pinces intestinales et de tissu  
 Pinzas para tejidos y intestinos  
 Pinze per tessuti ed intestino



**LITTLEWOOD**

190 mm - 7½" **tk 11955-19**

Zähne 2x3  
 Teeth

Dents  
 Dientes  
 Denti



**BOYS-ALLIS**

150 mm - 6" **tk 28210-15**

Zähne 5x6  
 Teeth

Dents  
 Dientes  
 Denti



**JUDD-ALLIS**

150 mm - 6" **tk 28250-15**  
 190 mm - 7½" **tk 28250-19**

Zähne 3x4  
 Teeth

Dents  
 Dientes  
 Denti



**BABCOCK**

160 mm - 6¼"	200 mm - 8"
<b>tk 28285-16</b>	<b>tk 28285-20</b>



**BABCOCK**

160 mm - 6¼"	<b>tk 28280-16</b>
180 mm - 7"	<b>tk 28280-18</b>
200 mm - 8"	<b>tk 28280-20</b>
240 mm - 9½"	<b>tk 28280-24</b>

Gewebe- und Darmfazzangen  
*Tissue and intestinal holding forceps*

Pinces intestinales et de tissue  
*Pinzas para tejidos y intestinos*  
Pinze per tessuti ed intestino

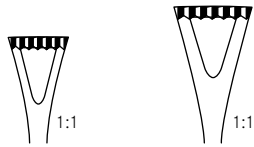
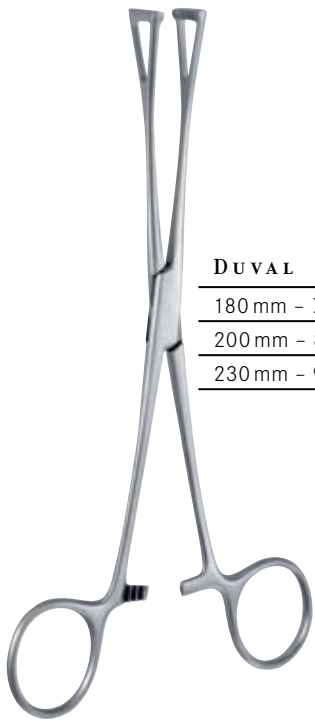

DUVAL

180 mm - 7"	<b>tk 28290-18</b>	
200 mm - 8"	<b>tk 28290-20</b>	<b>tk 28292-20</b>
230 mm - 9"	<b>tk 28290-23</b>	<b>tk 28292-23</b>

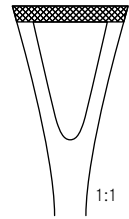

DUVAL

200 mm - 8"	<b>tk 28293-20</b>
-------------	--------------------

**TUCAR**

Gewebe- und Darmfazzangen  
*Tissue and intestinal holding forceps*

Pinces intestinales et de tissue  
*Pinzas para tejidos y intestinos*  
 Pinze per tessuti ed intestino

**ATRAUMTK**



**BABCOCK-  
 ATRAUMA**



1:1



1:1

160 mm - 6¼"	200 mm - 8"
<b>tk 22452-16</b>	<b>tk 22452-20</b>



**ALLIS-  
 ATRAUMA**

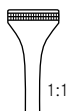

1:1



1:1







1:1





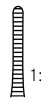
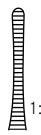
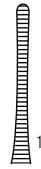

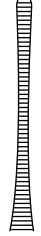
160 mm - 6¼"	200 mm - 8"	250 mm - 9¾"
<b>tk 22450-16</b>	<b>tk 22450-20</b>	<b>tk 22450-25</b>

**Bulldogklemmen**  
*Bulldog clamps*

Clamps Bulldog  
*Clamps Bulldog*  
Pinze Bulldog



JOHNS HOPKINS	 1:1	 1:1	 1:1	 1:1	 1:1	 1:1	 1:1
	38 mm - 1½"	50 mm - 2"	55 mm - 2¼"	65 mm - 2½"	70 mm - 2¾"	75 mm - 3"	90 mm - 3½"
	<b>tk 11946-38</b>	<b>tk 11946-50</b>	<b>tk 11946-55</b>	<b>tk 11946-65</b>	<b>tk 11946-70</b>	<b>tk 11946-75</b>	<b>tk 11946-90</b>

JOHNS HOPKINS	 1:1	 1:1	 1:1	 1:1	 1:1	 1:1	 1:1
	38 mm - 1½"	50 mm - 2"	55 mm - 2¼"	65 mm - 2½"	70 mm - 2¾"	75 mm - 3"	90 mm - 3½"
	<b>tk 11947-38</b>	<b>tk 11947-50</b>	<b>tk 11947-55</b>	<b>tk 11947-65</b>	<b>tk 11947-70</b>	<b>tk 11947-75</b>	<b>tk 11947-90</b>



235 mm - 9¼"  
**tk 11948-23**

Anlegezange für John Hopkins und De Bakey Bulldogklemmen  
*Applying forceps for John Hopkins and De Bakey bulldog clamps*  
Pince pour poser les clamps Bulldog (John Hopkins et De Bakey)  
*Pinza aplicadora para clamps Bulldog (John Hopkins y De Bakey)*  
Pinza per posizionare le pinze Bulldog (John Hopkins e De Bakey)

**Bulldogklemmen**  
*Bulldog clamps*

Clamps Bulldog  
*Clamps Bulldog*  
Pinze Bulldog



**DIEFFENBACH**

35 mm - 1½"	<b>tk 11930-03</b>	<b>tk 11931-03</b>
50 mm - 2"	<b>tk 11930-05</b>	<b>tk 11931-05</b>
60 mm - 2¼"	<b>tk 11930-06</b>	<b>tk 11931-06</b>



**JOHNS HOPKINS**

50 mm - 2"	<b>tk 11935-05</b>
65 mm - 2½"	<b>tk 11935-06</b>
75 mm - 3"	<b>tk 11935-07</b>



**DIETRICH**

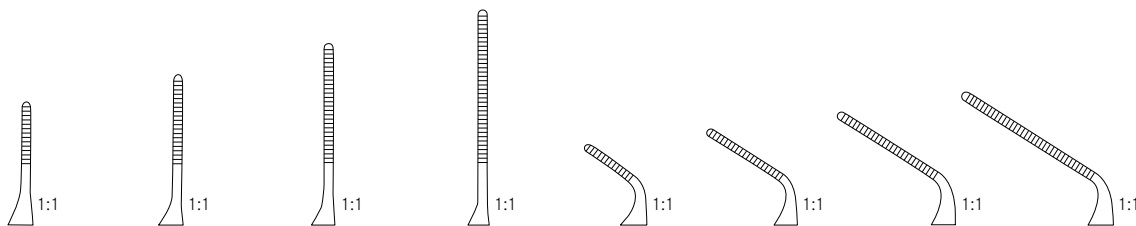

<b>x =</b>	50 mm - 2"	50 mm - 2"	50 mm - 2"	60 mm - 2¼"	50 mm - 2"	50 mm - 2"	50 mm - 2"	60 mm - 2¼"
<b>y =</b>	8 mm	12 mm	16 mm	20 mm	8 mm	12 mm	16 mm	20 mm
	gms = 50							
	<b>tk 11940-08</b>	<b>tk 11940-12</b>	<b>tk 11940-16</b>	<b>tk 11940-20</b>	<b>tk 11941-08</b>	<b>tk 11941-12</b>	<b>tk 11941-16</b>	<b>tk 11941-20</b>

<b>x = Länge</b> <i>Length</i>	<b>y = geriefte Maullänge</b> <i>serated jaw part</i>	<b>gms = Schließkraft</b> <i>closing force</i>
Longueur	partie striée du mors	force de fermeture
Longitud	parte estriada de la boca	presión
Lunghezza	morso zigrinato	pressione di chiusura

**Bulldogklemmen** | Clamps Bulldog  
*Bulldog clamps* | *Clamps Bulldog*  
 Pinze Bulldog

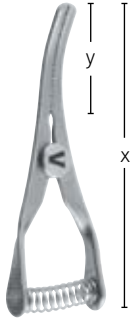

MINI - GLOVER

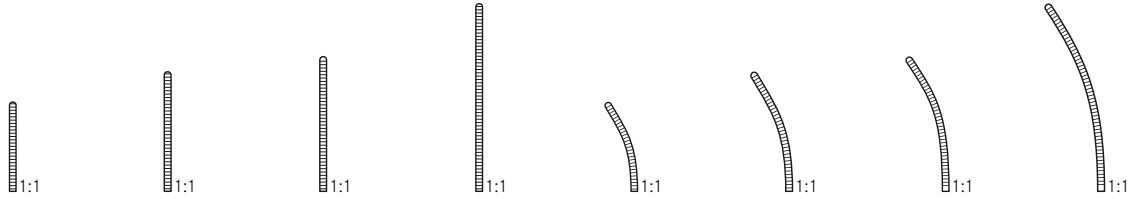

<b>x=</b>	30 mm - 1¼"	35 mm - 1½"	40 mm - 1½"	50 mm - 2"	30 mm - 1¼"	35 mm - 1½"	40 mm - 1½"	50 mm - 2"
<b>y=</b>	11 mm	15 mm	17 mm	24 mm	11 mm	15 mm	17 mm	24 mm
for Veins	gms = 110							
for Arteries	gms = 220							
for Veins	<b>tk 11933-01</b>	<b>tk 11933-02</b>	<b>tk 11933-03</b>	<b>tk 11933-04</b>	<b>tk 11933-05</b>	<b>tk 11933-06</b>	<b>tk 11933-07</b>	<b>tk 11933-08</b>
for Arteries	<b>tk 11934-01</b>	<b>tk 11934-02</b>	<b>tk 11934-03</b>	<b>tk 11934-04</b>	<b>tk 11934-05</b>	<b>tk 11934-06</b>	<b>tk 11934-07</b>	<b>tk 11934-08</b>



**x = Länge**      **y = geriefte Maullänge**      **gms = Schließkraft**  
*Length*              *serated jaw part*              *closing force*  
 Longueur            partie striée du mors            force de fermeture  
 Longitud            parte estriada de la boca       presión  
 Lunghezza        morso zigrinato                  pressione di chiusura

MINI - GLOVER

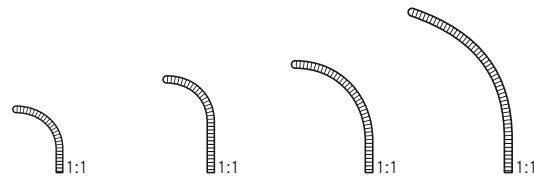

<b>x=</b>	30 mm - 1¼"	35 mm - 1½"	40 mm - 1½"	50 mm - 2"
<b>y=</b>	11 mm	15 mm	17 mm	24 mm
for Veins	gms = 110			
for Arteries	gms = 220			
for Veins	<b>tk 11933-09</b>	<b>tk 11933-10</b>	<b>tk 11933-11</b>	<b>tk 11933-12</b>
for Arteries	<b>tk 11934-09</b>	<b>tk 11934-10</b>	<b>tk 11934-11</b>	<b>tk 11934-12</b>



**x = Länge**      **y = geriefte Maullänge**      **gms = Schließkraft**  
*Length*              *serated jaw part*              *closing force*  
 Longueur            partie striée du mors            force de fermeture  
 Longitud            parte estriada de la boca       presión  
 Lunghezza        morso zigrinato                  pressione di chiusura



230 mm - 9"

**tk 11935-00**

Anlegezange für Mini-Glover Bulldogklemmen  
*Applying forceps for Mini-Glover bulldog clamps*  
 Pince à poser pour les clamps Bulldog (Mini-Glover)  
*Aplicadora para clamps Bulldog (Mini-Glover)*  
 Pinza per posizionare le pinze Bulldog (Mini-Glover)



**Bulldogklemmen** | Clamps Bulldog  
*Bulldog clamps* | *Clamps Bulldog*  
 Pinze Bulldog

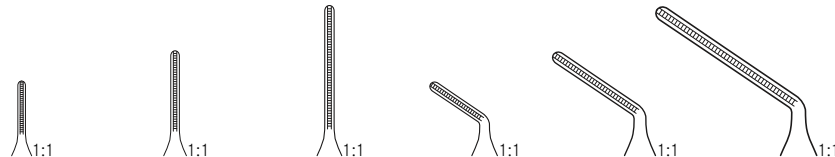
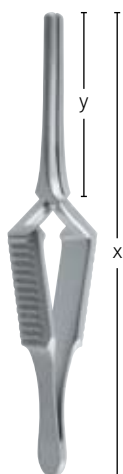

**DE BAKEY - DIETRICH**

<b>x=</b>	49 mm - 2"	53 mm - 2"	59 mm - 2¼"	44 mm - 1¾"	46 mm - 1¾"	49 mm - 2"
<b>y=</b>	10 mm	14 mm	20 mm	10 mm	14 mm	20 mm
	gms = 180					
	<b>tk 11949-01</b>	<b>tk 11949-02</b>	<b>tk 11949-03</b>	<b>tk 11949-04</b>	<b>tk 11949-05</b>	<b>tk 11949-06</b>

**x = Länge**      **y = geriefte Maullänge**      **gms = Schließkraft**  
*Length*              *serrated jaw part*              *closing force*  
 Longueur          partie striée du mors              force de fermeture  
 Longitud          parte estriada de la boca              presión  
 Lunghezza          morso zigrinato              pressione di chiusura

Bulldogklemmen  
*Bulldog clamps*

Clamps Bulldog  
*Clamps Bulldog*  
Pinze Bulldog

**ATRAUMTK**



DE BAKEY

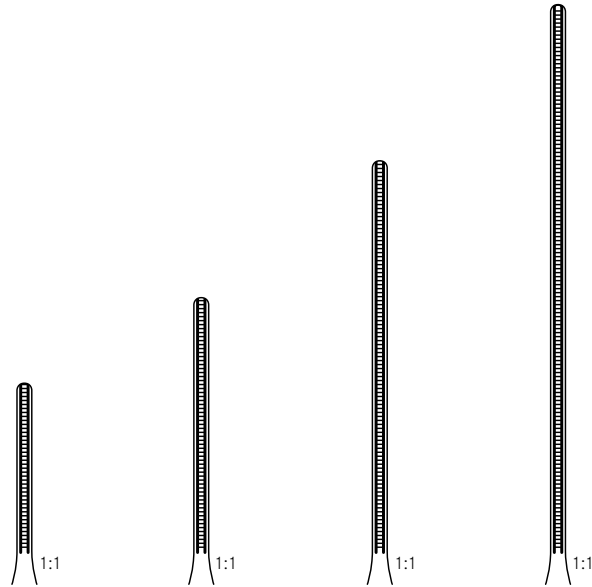

75 mm - 3"	85 mm - 3 1/4"	105 mm - 4 1/4"	120 mm - 4 3/4"
<b>tk 11950-08</b>	<b>tk 11950-09</b>	<b>tk 11950-10</b>	<b>tk 11950-12</b>



DE BAKEY

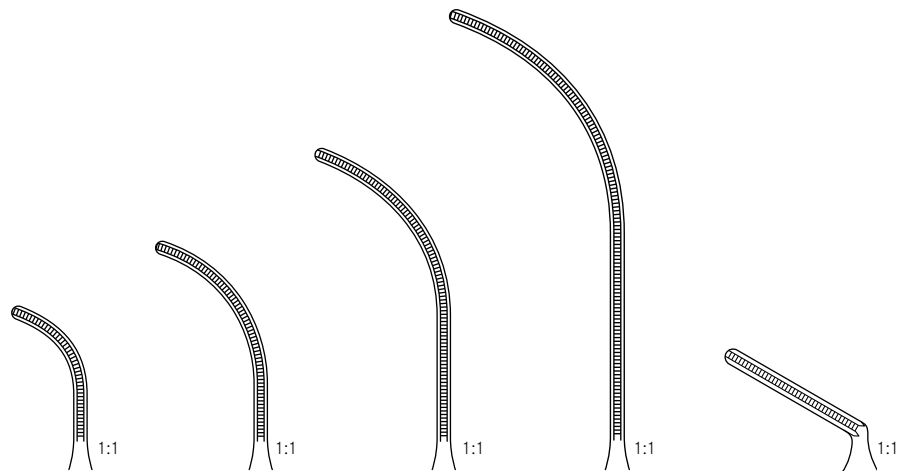

70 mm - 2 3/4"	80 mm - 3 1/4"	100 mm - 4"	115 mm - 4 1/2"	55 mm - 2 1/4"
<b>tk 11951-08</b>	<b>tk 11951-09</b>	<b>tk 11951-10</b>	<b>tk 11951-12</b>	<b>tk 11951-05</b>

abgewinkelt  
*angled on flat*  
coudée sur le plat  
*angulado*  
angolato

**Bulldogklemmen**  
*Bulldog clamps*

Clamps Bulldog  
*Clamps Bulldog*  
Pinze Bulldog



GLOVER				
	60 mm - 2 1/2"	70 mm - 2 3/4"	90 mm - 3 1/2"	110 mm - 4 1/4"
	<b>tk 11944-06</b>	<b>tk 11944-07</b>	<b>tk 11944-09</b>	<b>tk 11944-11</b>



GLOVER					
	55 mm - 2 1/4"	65 mm - 2 1/2"	85 mm - 3 1/4"	105 mm - 4 1/4"	50 mm - 2"
	<b>tk 11945-06</b>	<b>tk 11945-07</b>	<b>tk 11945-09</b>	<b>tk 11945-11</b>	<b>tk 11945-05</b>

abgewinkelt  
*angled on flat*  
coudée sur le plat  
*angulado*  
angolato

Bulldogklemmen  
*Bulldog clamps*

Clamps Bulldog  
*Clamps Bulldog*  
Pinze Bulldog

**ATRAUMTK**

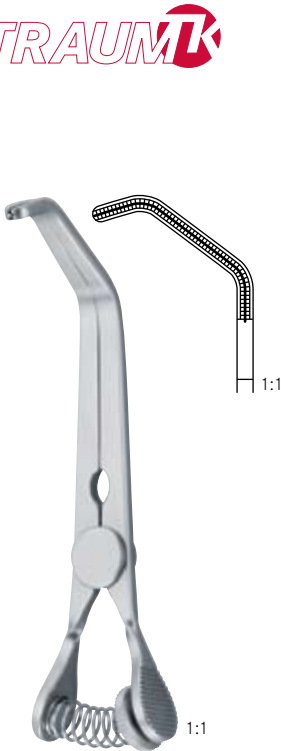

**DE BAKEY-SATINSKY**

70 mm - 2¾"

**tk 11953-07**



**DE BAKEY-CAROTIS**

90 mm - 3½"

**tk 11953-09**

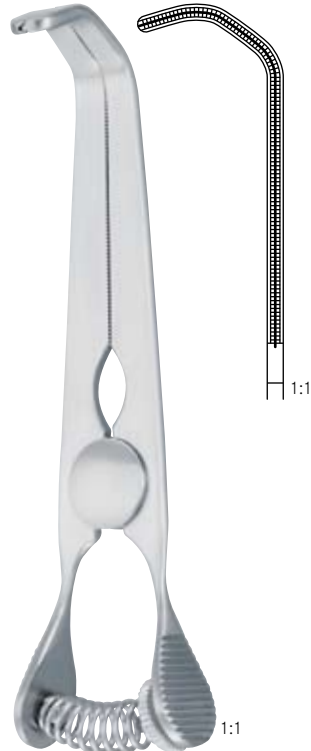

**DE BAKEY-SATINSKY**

100 mm - 4"

**tk 11953-10**

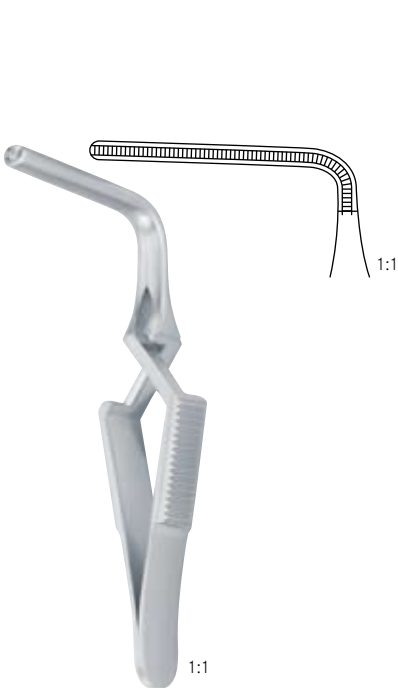

**SANTULLI**

70 mm - 2¾"

**tk 11957-07**

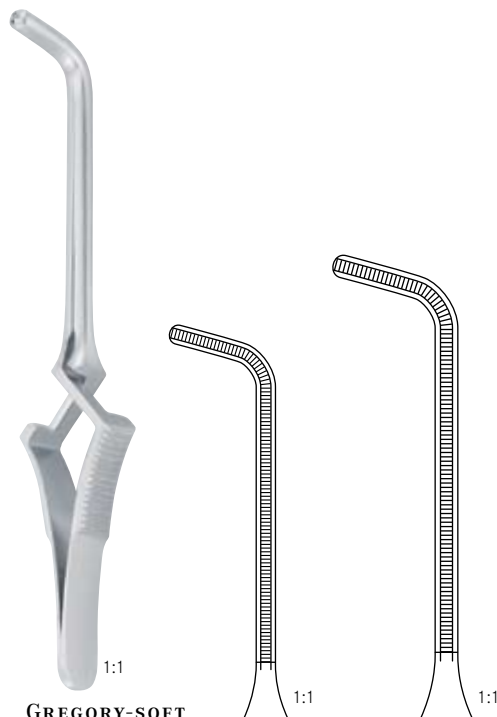

**GREGORY-SOFT**

90 mm - 3½"

**tk 11959-09**

110 mm - 4¼"

**tk 11959-11**

**Bulldogklemmen**  
*Bulldog clamps*

Clamps Bulldog  
*Clamps Bulldog*  
Pinze Bulldog



<b>COOLEY</b>				
	80 mm - 3 1/4"	90 mm - 3 1/2"	105 mm - 4 1/4"	125 mm - 5"
	<b>tk 11942-08</b>	<b>tk 11942-09</b>	<b>tk 11942-10</b>	<b>tk 11942-12</b>

<b>COOLEY</b>				
	75 mm - 3"	85 mm - 3 1/4"	95 mm - 3 3/4"	115 mm - 4 1/2"
	<b>tk 11943-07</b>	<b>tk 11943-08</b>	<b>tk 11943-09</b>	<b>tk 11943-11</b>



**ENDOSCOPY**



Endoskopie | Endoscopie  
Endoscopy | Endoscopia  
Endoscopia



Bitte fordern Sie unsere Endoskopiekataloge an.  
*Please ask for our endoscopy catalogues.*

Veuillez demander pour notre catalogue endoscopie.  
*Por favor preguntan para el catalogo endoscopio.*

Per favore domandate per il nostro catalogo endoscopia.

**Mehrzweck - Gefäßklemmen**  
*Multi purpose vascular clamps*

Pinces vasculaires universelles  
*Pinzas vasculares de usos múltiples*  
 Pinze vascolari universali



**BAINBRIDGE,  
 LIGHT**

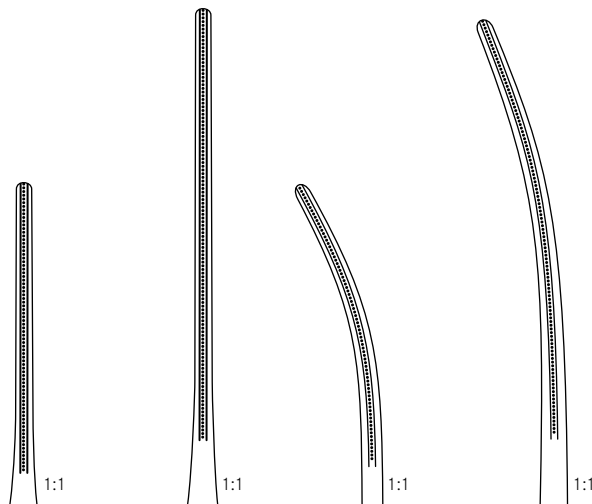

150 mm - 6"	180 mm - 7"	150 mm - 6"	180 mm - 7"
<b>tk 22045-15</b>	<b>tk 22045-18</b>	<b>tk 22046-15</b>	<b>tk 22046-18</b>

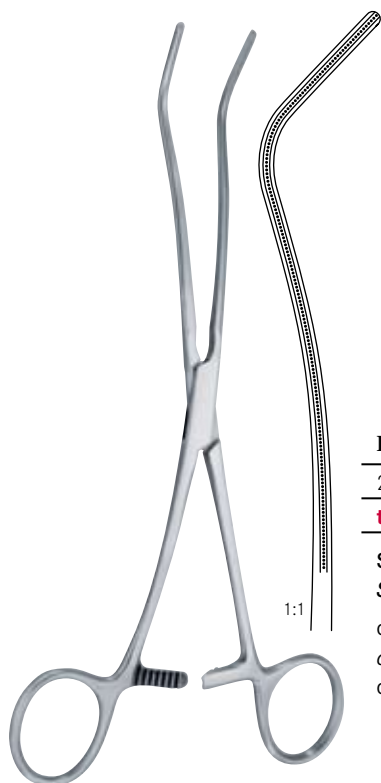

**DE BAKEY**

200 mm - 8"

**tk 22047-20**

**S-förmig gebogen**  
*S-curved*

*courbe en S*  
*curva en S*  
*curva a forma S*

1:1

1:2

Mehrzweck - Gefäßklemmen  
*Multi purpose vascular clamps*

Pinces vasculaires universelles  
*Pinzas vasculares de usos múltiples*  
Pinze vascolari universali

**ATRAUM**TK

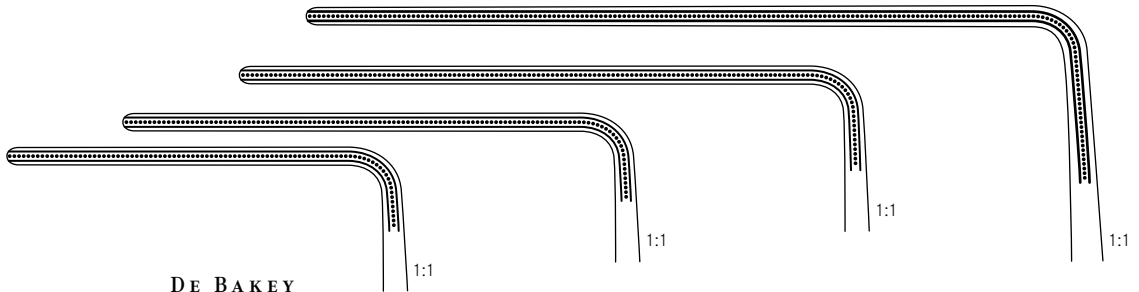

DE BAKEY

180 mm - 7"	190 mm - 7½"	230 mm - 9"	270 mm - 10¾"
<b>tk 22110-18</b>	<b>tk 22110-19</b>	<b>tk 22110-23</b>	<b>tk 22110-27</b>

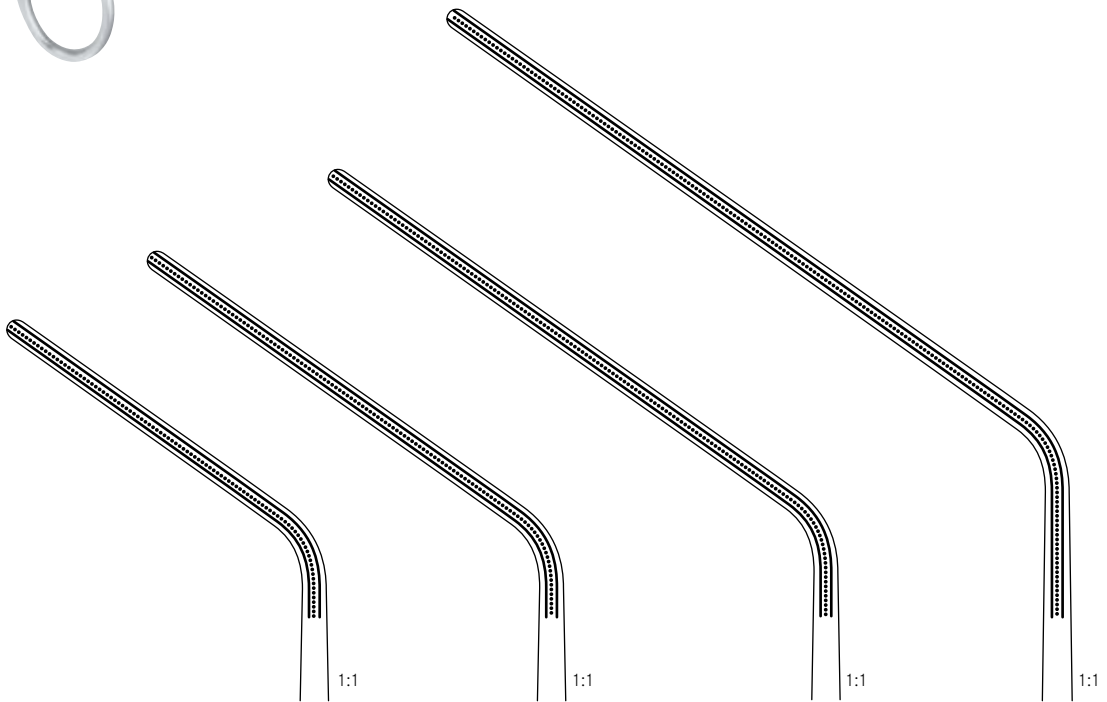

200 mm - 8"	210 mm - 8¼"	250 mm - 9¾"	300 mm - 12"
<b>tk 22112-20</b>	<b>tk 22112-21</b>	<b>tk 22112-25</b>	<b>tk 22112-29</b>



Mehrzweck - Gefäßklemmen  
*Multi purpose vascular clamps*

Pinces vasculaires universelles  
*Pinzas vasculares de usos múltiples*  
 Pinze vascolari universali



DE BAKEY

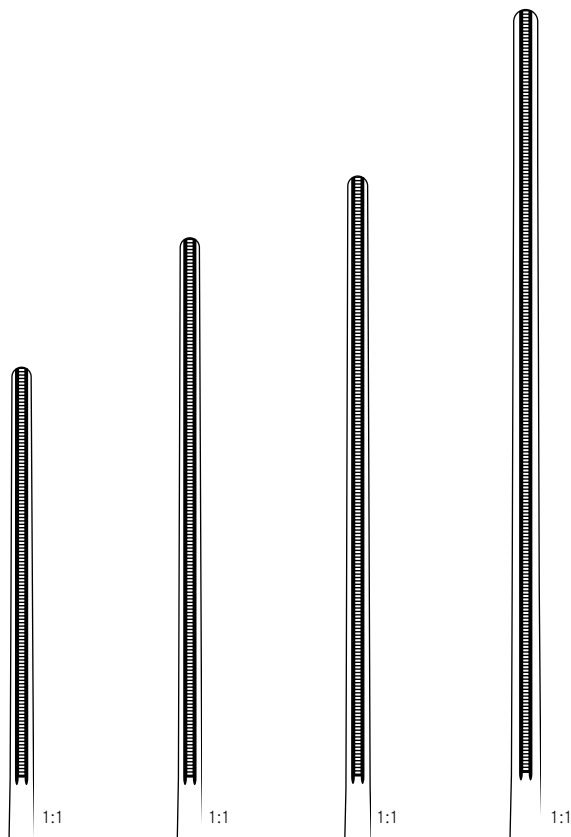

215 mm - 8½"	230 mm - 9"	270 mm - 10¾"	315 mm - 12½"
<b>tk 22133-21</b>	<b>tk 22133-23</b>	<b>tk 22133-27</b>	<b>tk 22133-31</b>

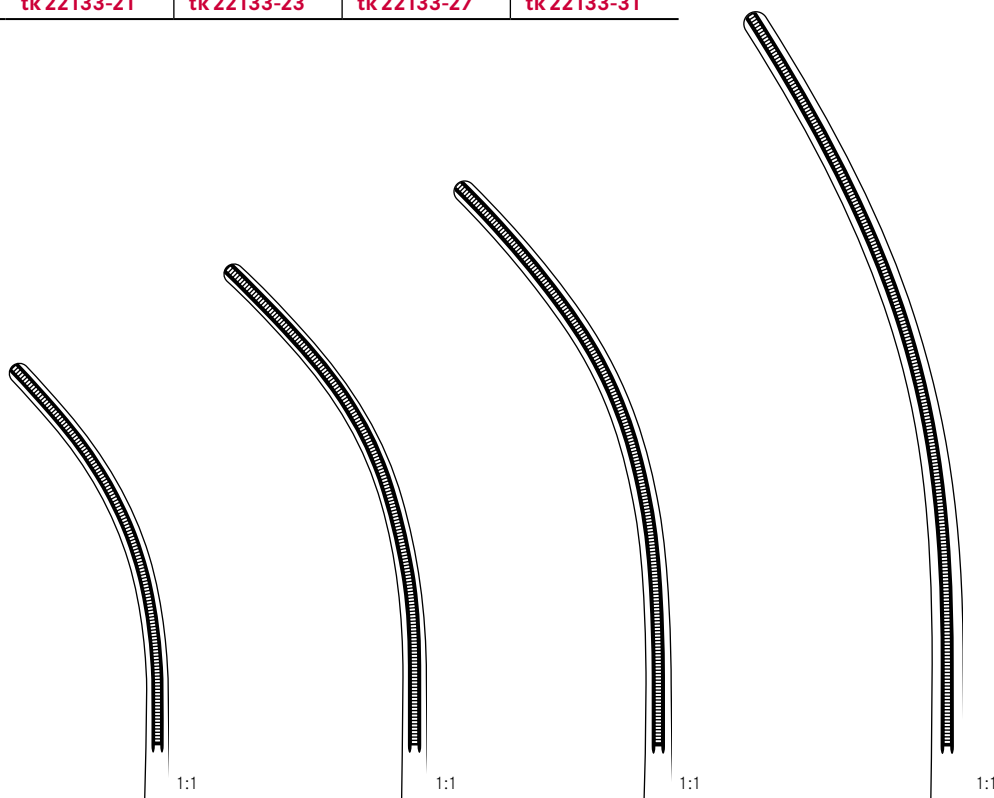

215 mm - 8½"	230 mm - 9"	270 mm - 10¾"	315 mm - 12½"
<b>tk 22135-21</b>	<b>tk 22135-23</b>	<b>tk 22135-27</b>	<b>tk 22135-31</b>

**Mehrzweck-Gefäßklemmen**  
*Multi purpose vascular clamps*

Pinces vasculaires universelles  
*Pinzas vasculares de usos múltiples*  
Pinze vascolari universali

**ATRAUMTK**



<b>DARDIK</b>				
	1:1	1:1	1:1	1:1
	0°	15°	30°	45°
170 mm - 6 3/4"	<b>tk 22545-00</b>	<b>tk 22545-15</b>	<b>tk 22545-30</b>	<b>tk 22545-45</b>

	1:1
	90°
160 mm - 6 1/4"	<b>tk 22545-90</b>

**Mehrzweck - Gefäßklemmen**  
**Multi purpose vascular clamps**

Pinces vasculaires universelles  
 Pinzas vasculares de usos múltiples  
 Pinze vascolari universali

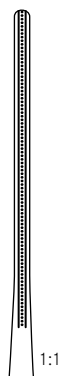

DE BAKEY

170 mm - 6 3/4"
<b>tk 22037-01</b>

gerade  
 straight  
 droite  
 recta  
 retta

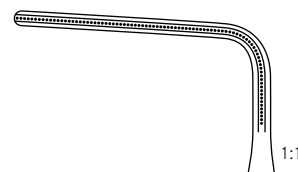
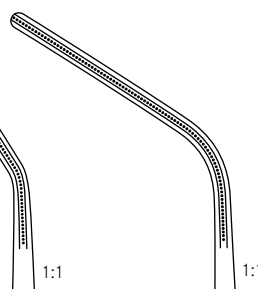
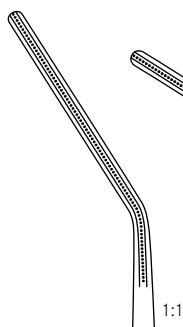
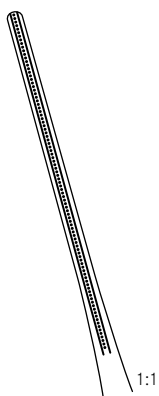

DE BAKEY

170 mm - 6 3/4"	160 mm - 6 1/4"	150 mm - 6"	140 mm - 5 1/2"
<b>tk 22043-17</b>	<b>tk 22039-16</b>	<b>tk 22041-15</b>	<b>tk 22042-15</b>

kniegebogen  
 angled on flat  
 coudée sur le plat  
 acodada  
 angolata



Mehrzweck-Gefäßklemmen  
*Multi purpose vascular clamps*

Pinces vasculaires universelles  
*Pinzas vasculares de usos múltiples*  
Pinze vascolari universali

**ATRAUM**TK



**GLOVER**

		
1:1	1:1	1:1
205 mm - 8"	220 mm - 8¾"	260 mm - 10¼"
<b>tk 22060-20</b>	<b>tk 22060-22</b>	<b>tk 22060-26</b>

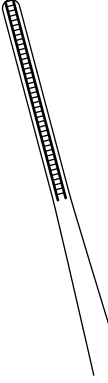
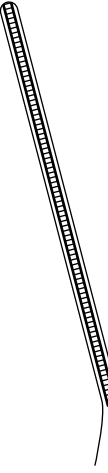
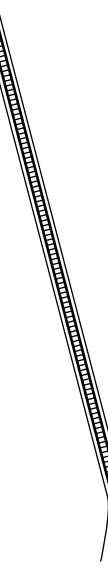
		
1:1	1:1	1:1
205 mm - 8"	220 mm - 8¾"	260 mm - 10¼"
<b>tk 22061-20</b>	<b>tk 22061-22</b>	<b>tk 22061-26</b>
abgewinkelt <i>angled on flat</i> coudé sur le plat <i>angulado</i> angolato	abgewinkelt <i>angled on flat</i> coudé sur le plat <i>angulado</i> angolato	abgewinkelt <i>angled on flat</i> coudé sur le plat <i>angulado</i> angolato

Mehrzweck - Gefäßklemmen  
*Multi purpose vascular clamps*

Pinces vasculaires universelles  
*Pinzas vasculares de usos múltiples*  
 Pinze vascolari universali

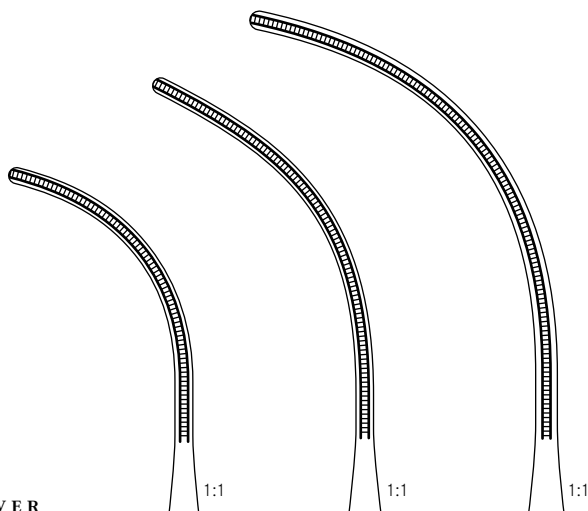

**GLOVER**

170 mm - 6 <sup>3</sup> / <sub>4</sub> "	210 mm - 8 <sup>1</sup> / <sub>4</sub> "	240 mm - 9 <sup>1</sup> / <sub>2</sub> "
<b>tk 22079-17</b>	<b>tk 22079-22</b>	<b>tk 22079-24</b>

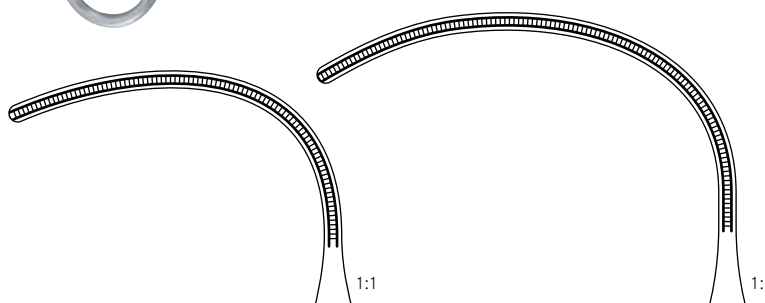

185 mm - 7 <sup>1</sup> / <sub>4</sub> "	220 mm - 8 <sup>3</sup> / <sub>4</sub> "
<b>tk 22078-18</b>	<b>tk 22078-22</b>

Mehrzweck-Gefäßklemmen  
Multi purpose vascular clamps

Pinces vasculaires universelles  
Pinzas vasculares de usos múltiples  
Pinze vascolari universali

ATRAUMTK



COOLEY			
120 mm - 4 <sup>3</sup> / <sub>4</sub> "	<b>tk 22562-01</b>	<b>tk 22562-02</b>	<b>tk 22562-03</b>
gerade <i>straight</i> droit <i>recta</i> retta	gebogen <i>curved</i> courbe <i>curva</i> curva	S-förmig gebogen <i>S-curved</i> courbe en S <i>curva en S</i> curva a forma S	
COOLEY			
120 mm - 4 <sup>3</sup> / <sub>4</sub> "	<b>tk 22562-04</b>	<b>tk 22562-05</b>	<b>tk 22562-06</b>
seitlich gewinkelt <i>sidewards angled</i> coudé vers la coté <i>angulado al lado</i> angolata lateralmente	abgewinkelt <i>angled on flat</i> coudé sur le plat <i>angulado</i> angolato	90° abgewinkelt <i>90° angled on flat</i> 90° coudé sur le plat <i>90° angulado</i> 90° angolato	

Mehrzweck - Gefäßklemmen  
*Multi purpose vascular clamps*

Pinces vasculaires universelles  
*Pinzas vasculares de usos múltiples*  
 Pinze vascolari universali

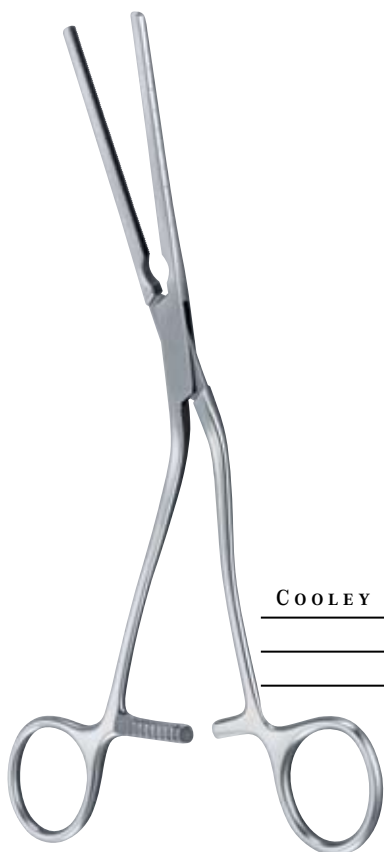

COOLEY

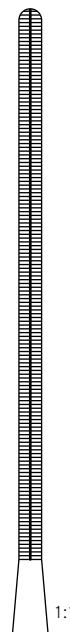
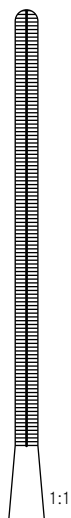

210 mm - 8 1/4"	250 mm - 9 3/4"
<b>tk 22552-21</b>	<b>tk 22552-25</b>

seitwärts abgewinkelt  
*sidewards angled on flat*  
 coudé vers la coté  
*angulado al lado*  
 angolata lateralmente

seitwärts abgewinkelt  
*sidewards angled on flat*  
 coudé vers la coté  
*angulado al lado*  
 angolata lateralmente



COOLEY

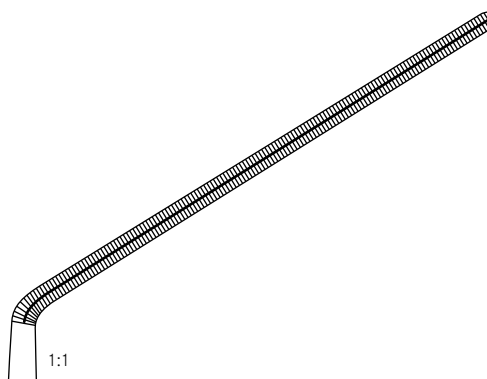
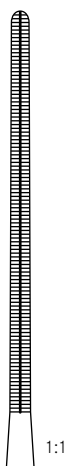

180 mm - 7"	185 mm - 7 1/4"
<b>tk 22560-18</b>	<b>tk 22561-18</b>

gerade  
*straight*  
 droite  
*recta*  
 retta

abgewinkelt  
*angled on flat*  
 coudé sur le plat  
*angulado*  
 angolata

Mehrzweck-Gefäßklemmen  
*Multi purpose vascular clamps*

Pinces vasculaires universelles  
*Pinzas vasculares de usos múltiples*  
Pinze vascolari universali

**ATRAUMTK**

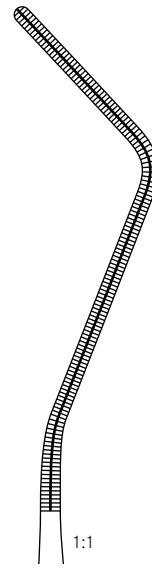
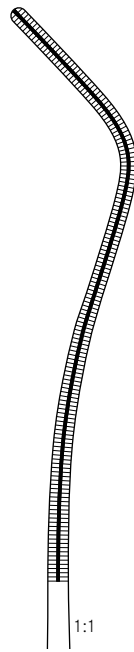

COOLEY

200 mm - 8"	195 mm - 7¾"
<b>tk 22505-20</b>	<b>tk 22505-19</b>

graduiert  
*graduated*  
gradué  
*graduado*  
graduato



Mehrzweck - Gefäßklemmen  
*Multi purpose vascular clamps*

Pinces vasculaires universelles  
*Pinzas vasculares de usos múltiples*  
 Pinze vascolari universali

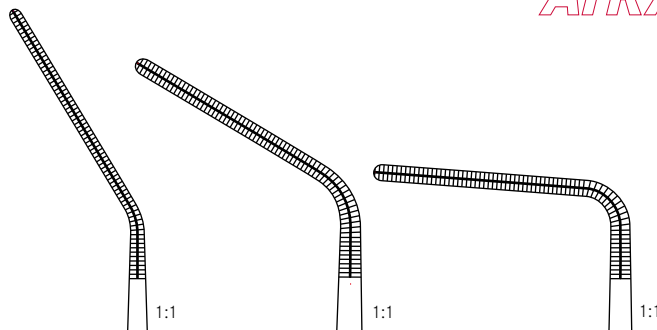

COOLEY			
	165 mm - 6½"	160 mm - 6¼"	145 mm - 5¾"
	25°	45°	90°
	<b>tk 22500-17</b>	<b>tk 22501-15</b>	<b>tk 22502-15</b>

graduiert  
*graduated*  
 gradué  
*graduado*  
 graduato

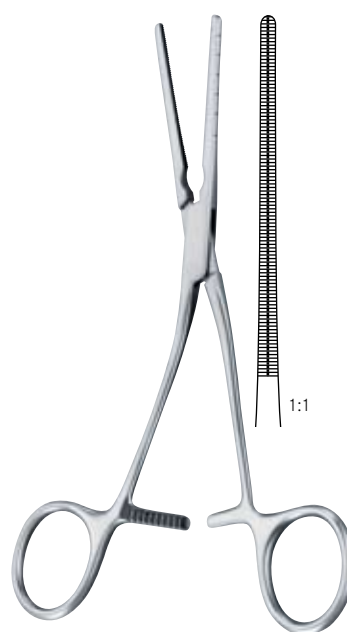

COOLEY  
 PATENT DUCTUS CLAMP

160 mm - 6¼"	<b>tk 22520-01</b>	<b>tk 22607-16</b>
170 mm - 6¾"	<b>tk 22610-17</b>	<b>tk 22524-17</b>
200 mm - 8"	<b>tk 22610-20</b>	
210 mm - 8¼"	<b>tk 22507-21</b>	
230 mm - 9"	<b>tk 22610-23</b>	<b>tk 22607-23</b>

graduiert  
*graduated*  
 gradué  
*graduado*  
 graduato

abgewinkelt, graduiert  
*angled on flat, graduated*  
 coudée sur le plat, graduée  
*angulada, graduada*  
 angolata, graduata

Mehrzweck - Gefäßklemmen  
*Multi purpose vascular clamps*

Pinces vasculaires universelles  
*Pinzas vasculares de usos múltiples*  
Pinze vascolari universali

**ATRAUMTK**

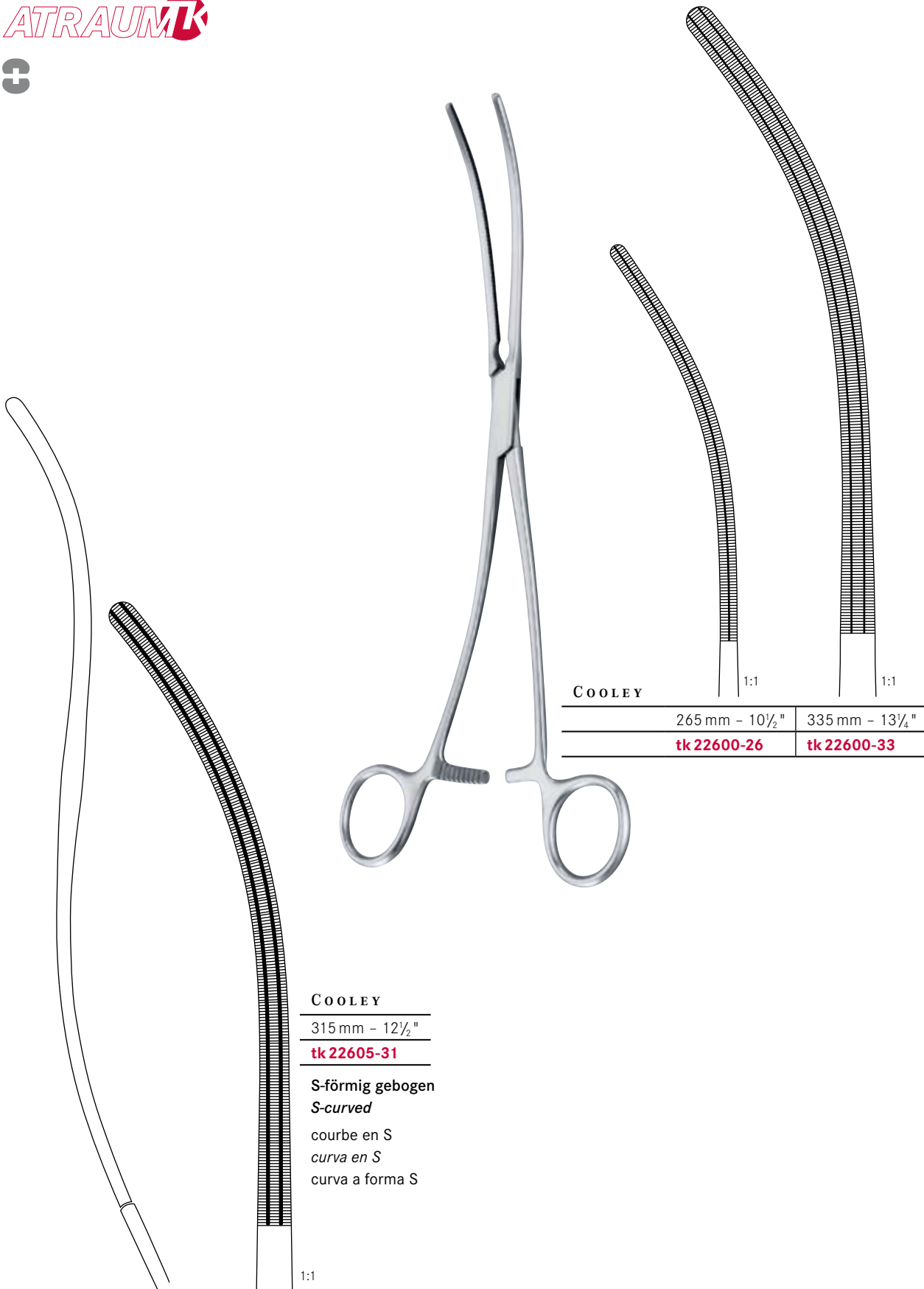

COOLEY	
265 mm - 10½"	335 mm - 13¼"
<b>tk 22600-26</b>	<b>tk 22600-33</b>

COOLEY
315 mm - 12½"
<b>tk 22605-31</b>

S-förmig gebogen  
*S-curved*  
courbe en S  
*curva en S*  
curva a forma S

1:1

**Anastomoseklemmen**  
*Anastomosis clamps*

Pinces-clamps pour anastomose  
*Pinzas para anastomosis*  
Pinze per anastomosi



**DERRA**

160 mm - 6¼"	170 mm - 6¾"	180 mm - 7"
<b>tk 22052-16</b>	<b>tk 22052-17</b>	<b>tk 22052-18</b>



**BECK**

170 mm - 6¾"
<b>tk 22065-17</b>



**POTTS**

220 mm - 8¾"
<b>tk 22081-22</b>

Anastomoseklemmen  
*Anastomosis clamps*

Pinces-clamps pour anastomose  
*Pinzas para anastomosis*  
Pinze per anastomosi

**ATRAUMTK**

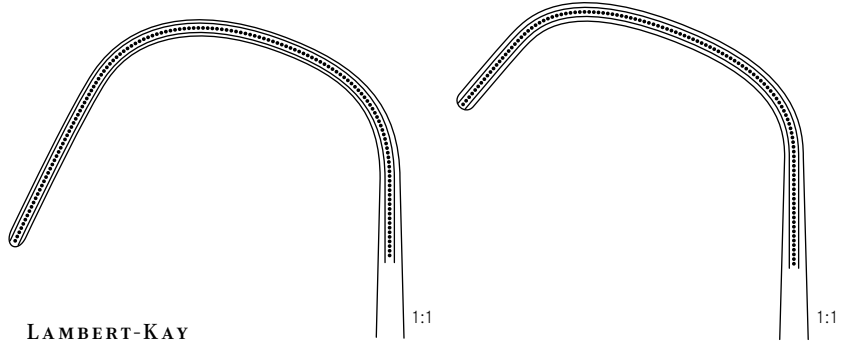

LAMBERT-KAY

200 mm - 8"

**tk 22138-21**

**tk 22139-21**

Anastomoseklemmen  
*Anastomosis clamps*

Pinces-clamps pour anastomose  
*Pinzas para anastomosis*  
 Pinze per anastomosi

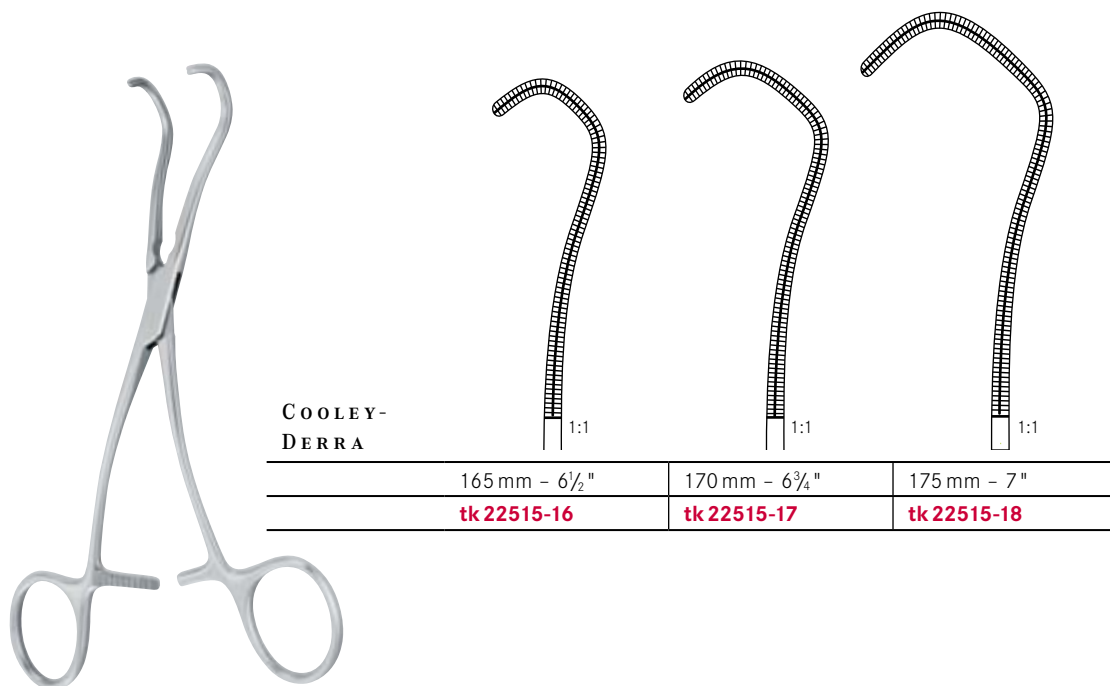

**COOLEY-DERRA**

165 mm - 6½"	170 mm - 6¾"	175 mm - 7"
<b>tk 22515-16</b>	<b>tk 22515-17</b>	<b>tk 22515-18</b>

Anastomoseklemmen  
*Anastomosis clamps*

Pinces-clamps pour anastomose  
*Pinzas para anastomosis*  
Pinze per anastomosi

**ATRAUM**TK



COOLEY-  
BECK

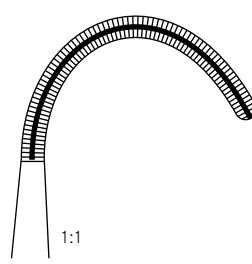

1:1

150 mm - 6"

**tk 22555-15**

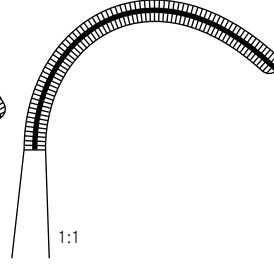

1:1

155 mm - 6"

**tk 22555-16**



COOLEY

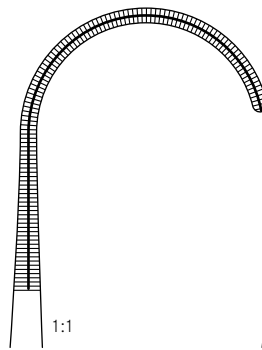

1:1

150 mm - 6"

**tk 22522-16**

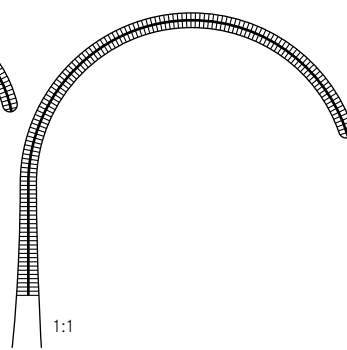

1:1

160 mm - 6 $\frac{1}{4}$ "

**tk 22522-17**

**Aortaklemmen**  
**Aorta clamps**

Pinces-clamps pour l'aorte  
Pinzas aórticas  
Pinze per aorta

**ATRAUMTK**

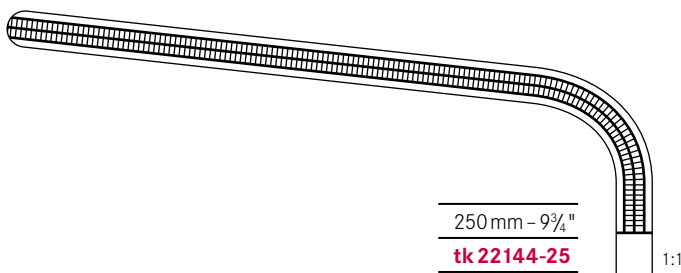
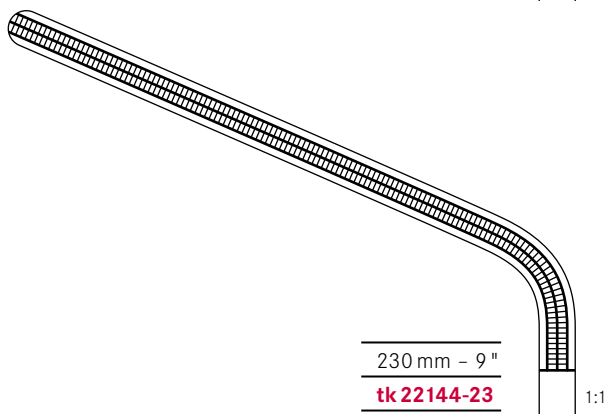
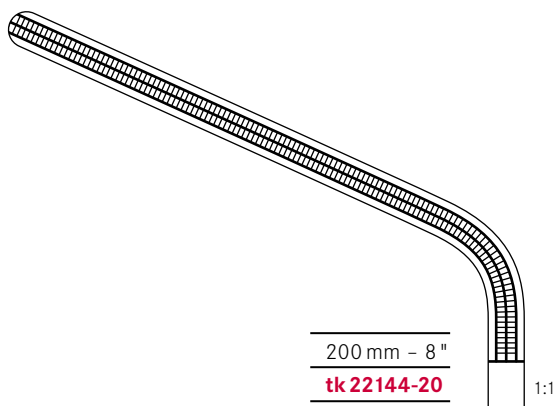
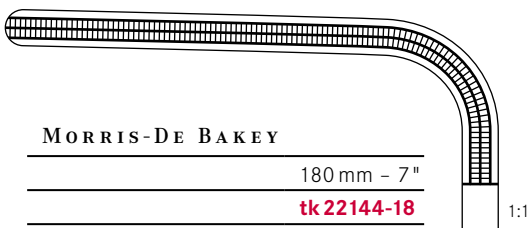

Aortaklemmen  
*Aorta clamps*

Pinces-clamps pour l'aorte  
*Pinzas aórticas*  
Pinze per aorta

**ATRAUM**TK



WEBER

260 mm - 10 $\frac{1}{4}$ "

**tk 22140-26**

links gebogen  
*curved left*

courbe à gauche  
*curva a la izquierda*  
curvata a sinistra



260 mm - 10 $\frac{1}{4}$ "

**tk 22141-26**

rechts gebogen  
*curved right*

courbe à droite  
*curva a la derecha*  
curvata a destra



**Aortaklemmen**  
**Aorta clamps**

Pinces-clamps pour l'aorte  
Pinzas aórticas  
Pinze per aorta

**ATRAUMTK**

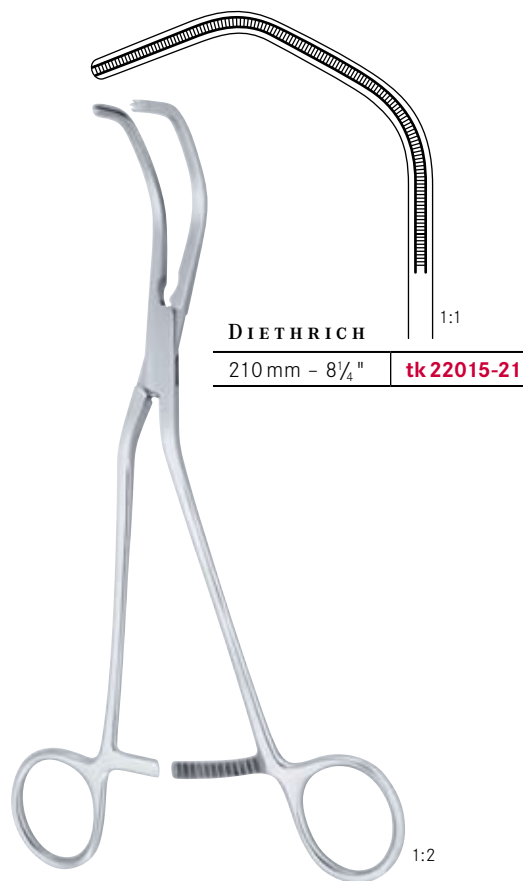
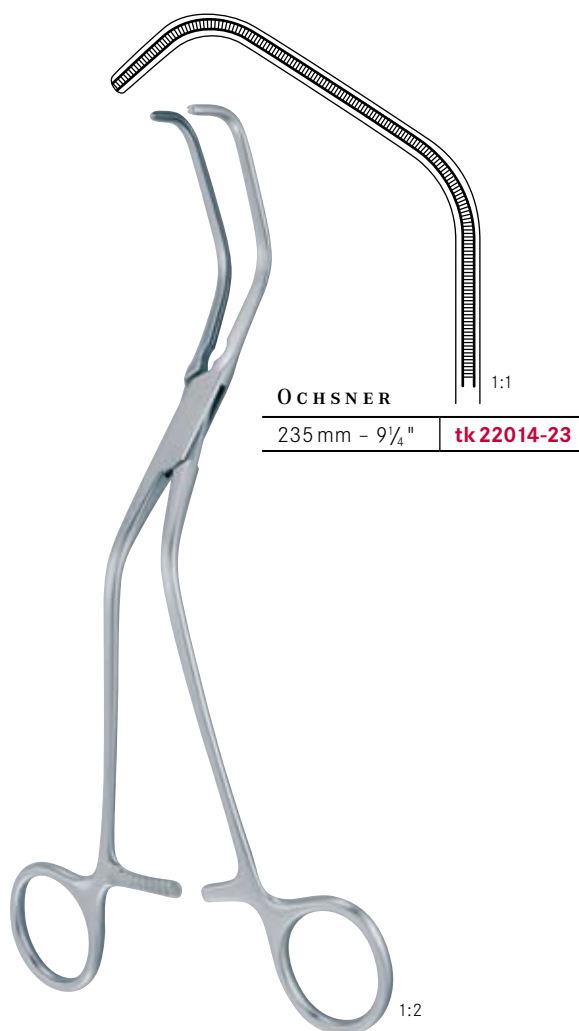

Aortaklemmen  
*Aorta clamps*

Pinces-clamps pour l'aorte  
*Pinzas aórticas*  
Pinze per aorta

**ATRAUMTK**

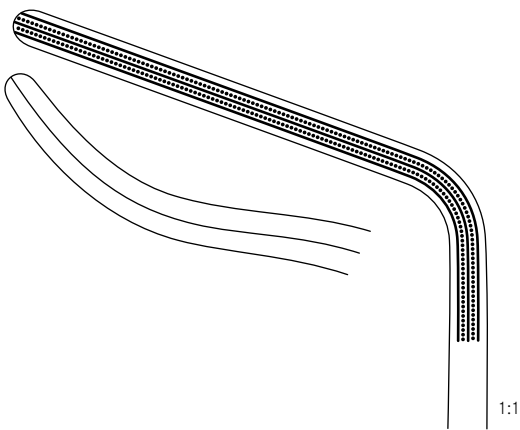

**DE B AKEY**

270 mm - 10<sup>3</sup>/<sub>4</sub>"

**tk 22116-27**

**Aorta-Aneurysmenklemmen**  
**Aorta aneurysm clamps**

Pinces-clamps pour anévrismes de l'aorte  
*Pinzas para aneurisma aórtica*  
Pinze per aneurisma della aorta

**ATRAUMTK**



**DE BAKEY**

280 mm - 11"

**tk 22136-28**

300 mm - 11<sup>3</sup>/<sub>4</sub>"

**tk 22137-30**

**S-förmig gebogen**

**S-curved**

*courbe en S*

*curva en S*

*curva a forma S*

Aorta-Aneurysmenklemmen  
*Aorta aneurysm clamps*

Pinces-clamps pour anévrismes de l'aorte  
*Pinzas para aneurisma aórtica*  
Pinze per aneurisma della aorta

**ATRAUM**TK

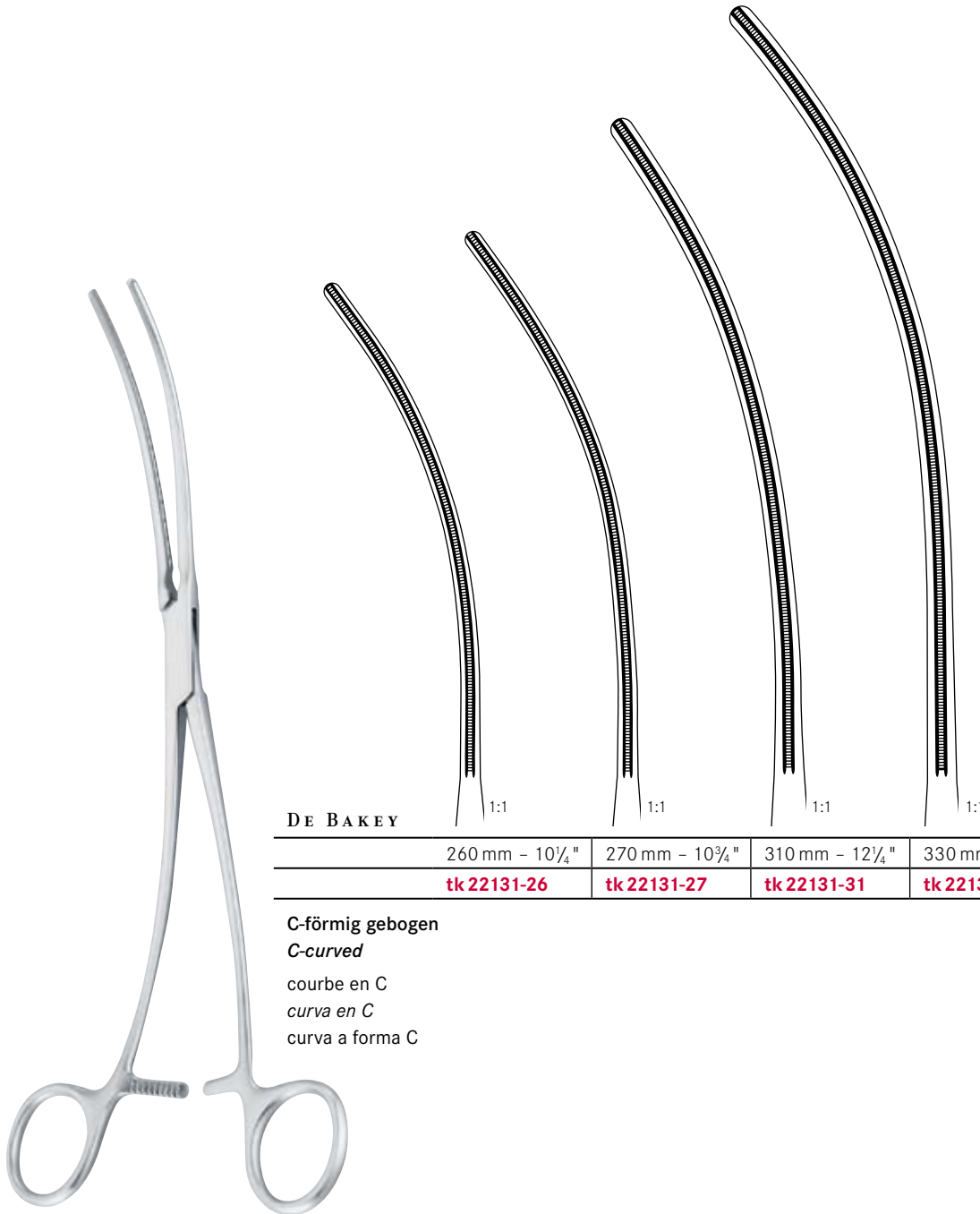

DE BAKEY

260 mm - 10 $\frac{1}{4}$ "	270 mm - 10 $\frac{3}{4}$ "	310 mm - 12 $\frac{1}{4}$ "	330 mm - 13 $\frac{3}{4}$ "
<b>tk 22131-26</b>	<b>tk 22131-27</b>	<b>tk 22131-31</b>	<b>tk 22131-33</b>

C-förmig gebogen

*C-curved*

*courbe en C*

*curva en C*

*curva a forma C*

**Aneurysmenklemmen**  
*Aneurysm clamps*

Pinces-clamps pour anévrismes  
*Pinzas para aneurisma*  
Pinze per aneurisma

**ATRAUMTK**



DE BAKKEY-  
BAHNSON

240 mm - 9½"	250 mm - 9¾"	260 cm - 10¼"
<b>tk 22145-23</b>	<b>tk 22145-24</b>	<b>tk 22145-25</b>

Tangentialklemmen  
*Tangential occlusion clamps*

Pinces-clamps pour l'occlusion tangentielle  
*Pinzas para oclusión tangencial*  
Pinze per occlusione tangenziale

**ATRAUM**TK

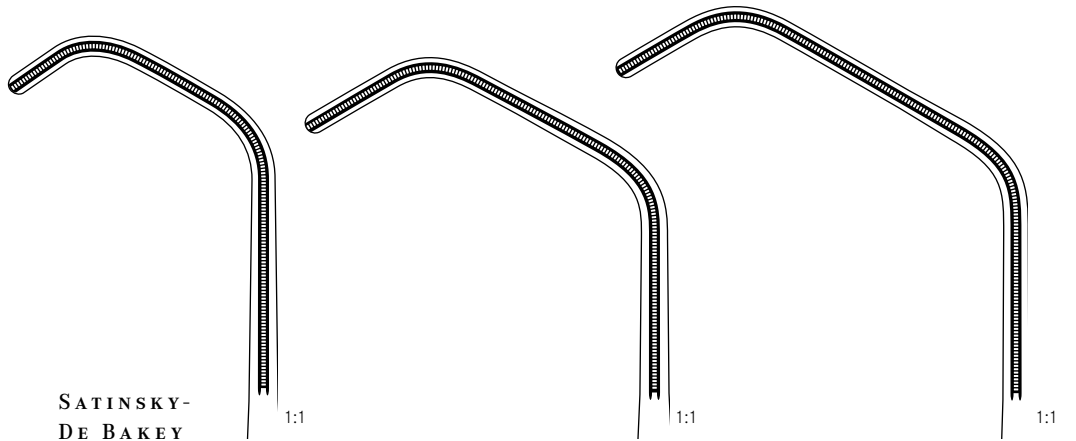

SATINSKY-  
DE BAKEY

205 mm - 8"	240 mm - 9 <sup>3</sup> / <sub>4</sub> "	250 mm - 10"
<b>tk 22125-20</b>	<b>tk 22125-24</b>	<b>tk 22125-25</b>

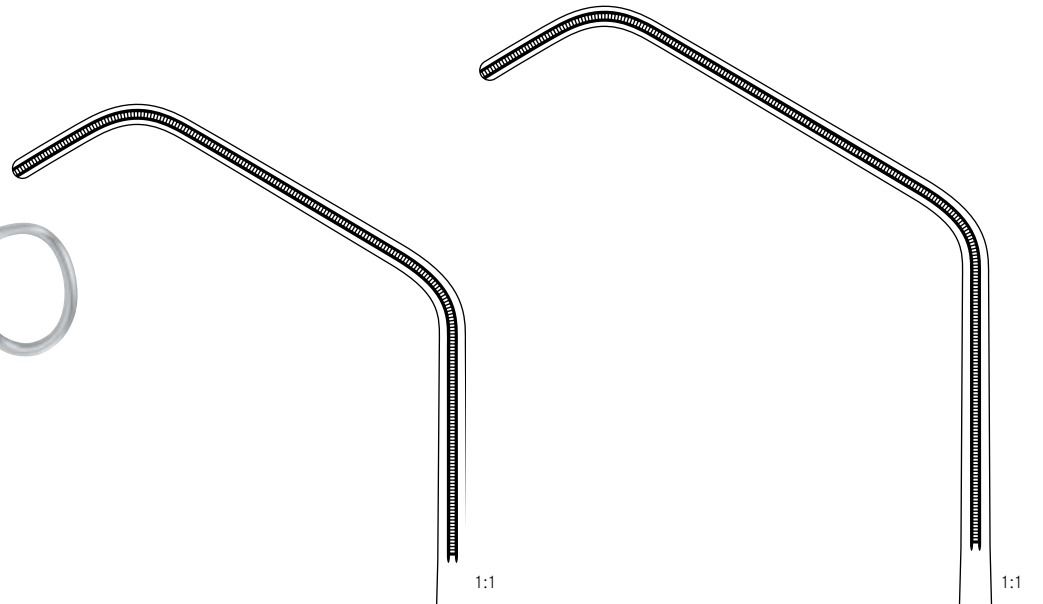

265 mm - 10 <sup>1</sup> / <sub>2</sub> "	275 mm - 10 <sup>3</sup> / <sub>4</sub> "
<b>tk 22125-26</b>	<b>tk 22125-27</b>

**Tangentialklammern**  
*Tangential occlusion clamps*

Pinces-clamps pour l'occlusion tangentielle  
*Pinzas para oclusión tangencial*  
Pinze per occlusione tangenziale

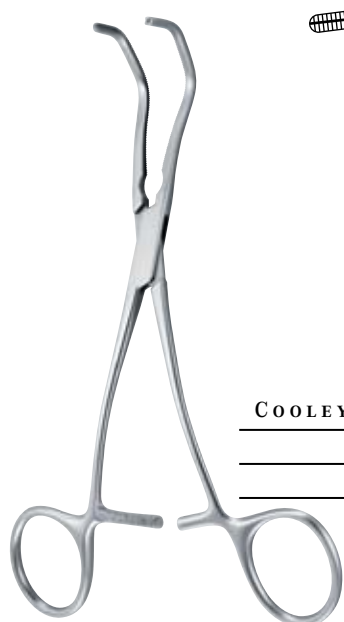

**COOLEY**

175 mm - 7"	175 mm - 7"	165 mm - 6½"
<b>tk 22565-17</b>	<b>tk 22566-17</b>	<b>tk 22567-01</b>

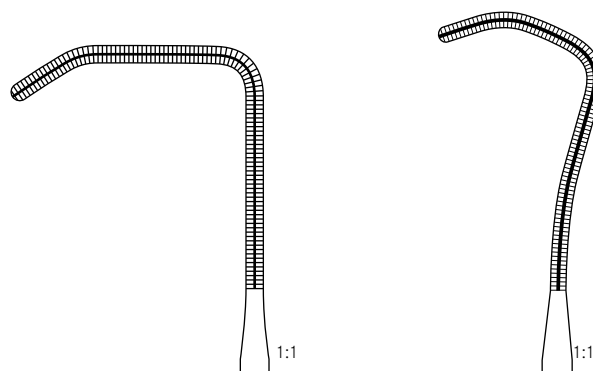

165 mm - 6½"	170 mm - 6¾"
<b>tk 22567-02</b>	<b>tk 22508-16</b>

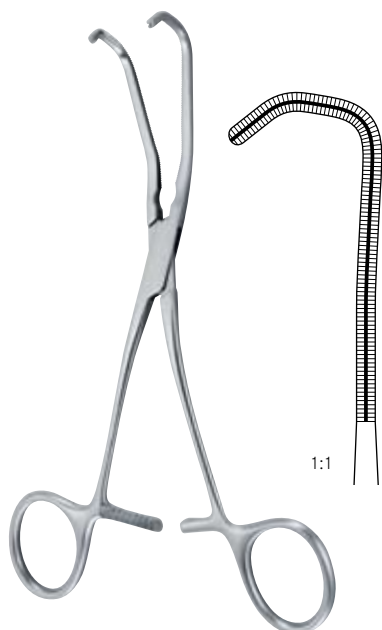

**COOLEY**

170 mm - 6¾"

**tk 22509-17**

seitlich abgewinkelt  
*sidewards angled*  
coudé vers la coté  
*angulado al lado*  
angolata lateralmente

Tangentialklemmen  
*Tangential occlusion clamps*

Pinces-clamps pour l'occlusion tangentielle  
*Pinzas para oclusión tangencial*  
Pinze per occlusione tangenziale

**ATRAUMTK**



COOLEY-  
TANGENTIAL

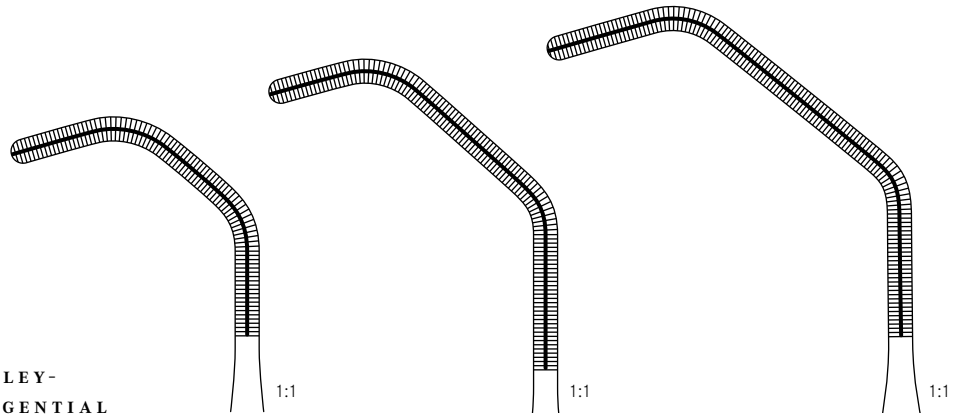

195 mm - 7 <sup>3</sup> / <sub>4</sub> "	255 mm - 10"	260 mm - 10 <sup>1</sup> / <sub>4</sub> "
<b>tk 22550-19</b>	<b>tk 22550-25</b>	<b>tk 22550-26</b>

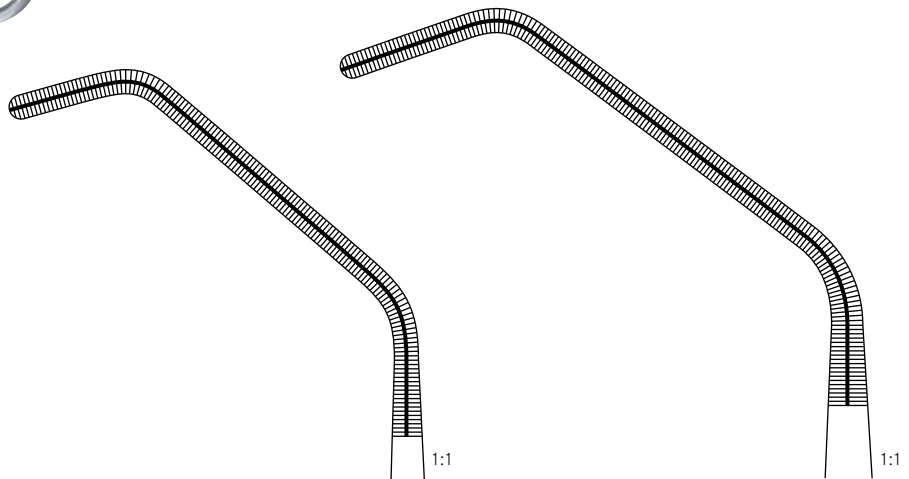

265 mm - 10 <sup>1</sup> / <sub>2</sub> "	270 mm - 10 <sup>3</sup> / <sub>4</sub> "
<b>tk 22550-27</b>	<b>tk 22550-28</b>



Peripheral-Gefäßklemmen  
*Peripheral vascular clamps*

Pinces-clamps vasculaires périphériques  
*Pinzas para vasos periféricos*  
 Pinze vascolari periferali

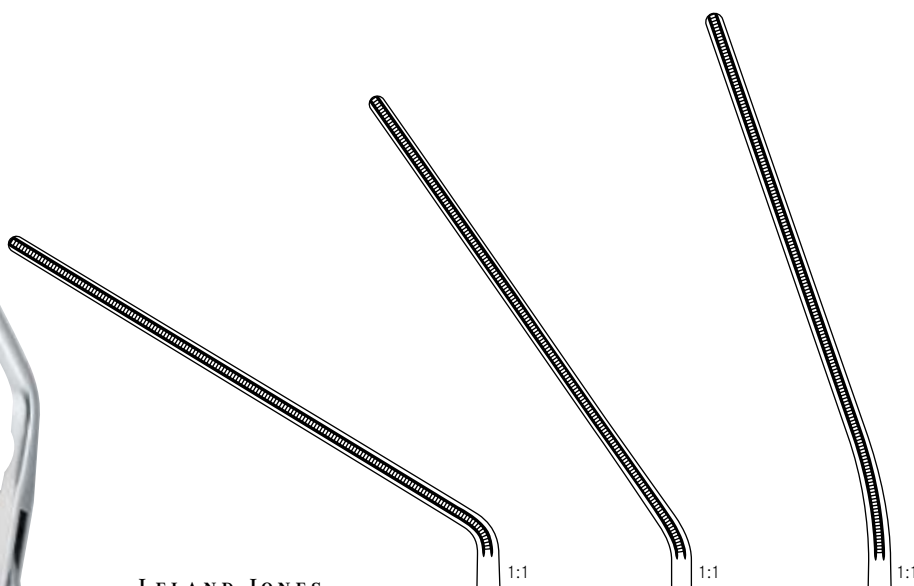

<b>LELAND-JONES</b>		
180 mm - 7"	190 mm - 7½"	200 mm - 8"
<b>tk 22056-04</b>	<b>tk 22056-02</b>	<b>tk 22056-03</b>

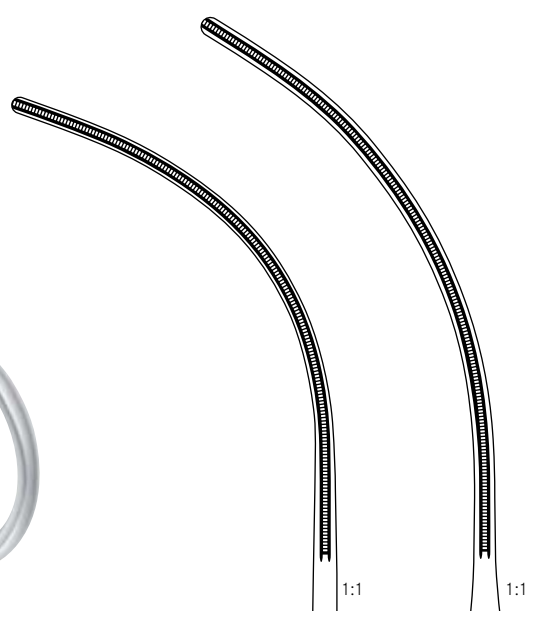

190 mm - 7½"	200 mm - 8"
<b>tk 22049-19</b>	<b>tk 22049-20</b>

Peripheral-Gefäßklemmen  
*Peripheral vascular clamps*

Pinces-clamps vasculaires périphériques  
*Pinzas para vasos periféricos*  
Pinze vascolari periferali

**ATRAUMTK**

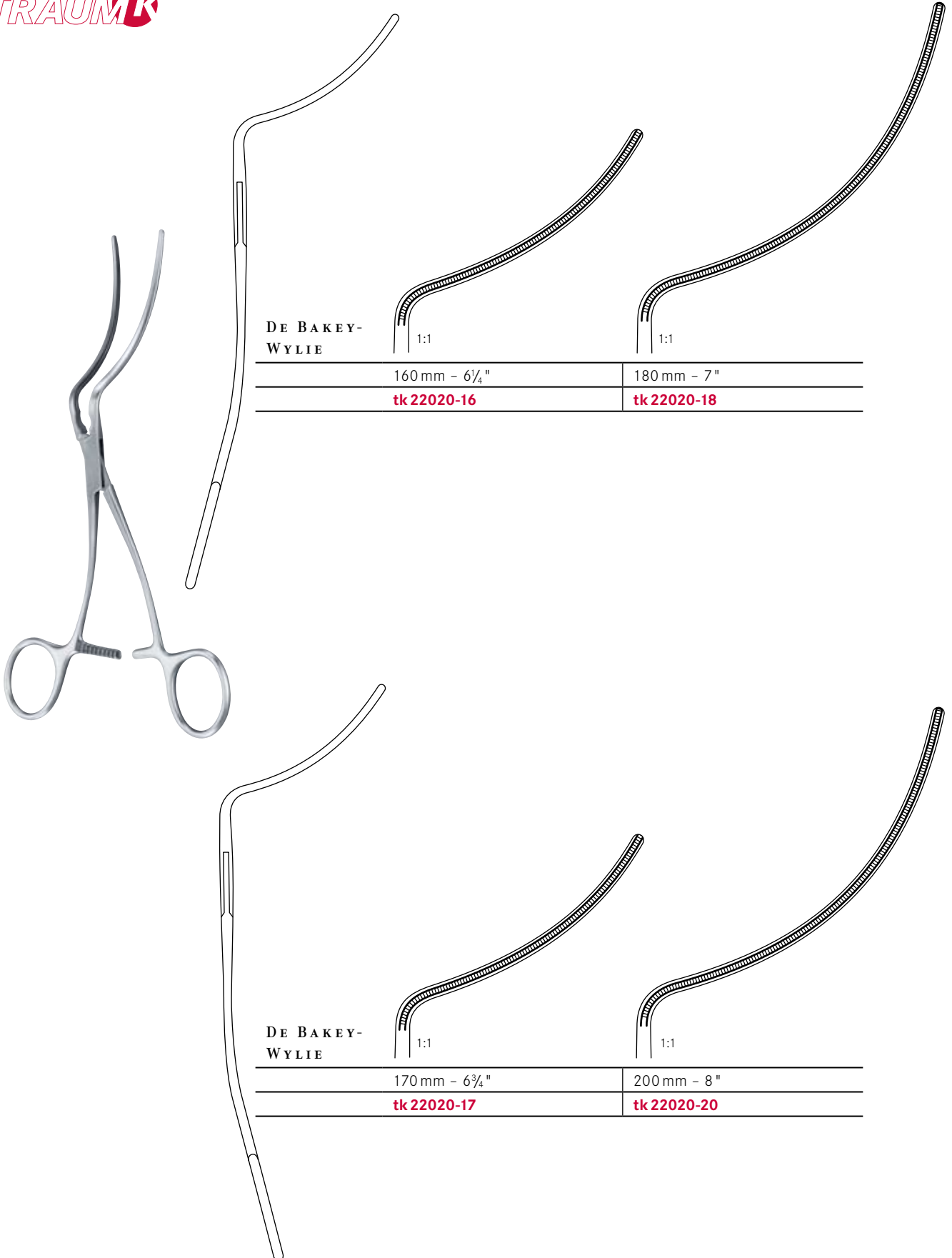

DE BAKEY-  
WYLIE

1:1

160 mm - 6¼"

**tk 22020-16**

1:1

180 mm - 7"

**tk 22020-18**

DE BAKEY-  
WYLIE

1:1

170 mm - 6¾"

**tk 22020-17**

1:1

200 mm - 8"

**tk 22020-20**

Peripheral-Gefäßklemmen  
*Peripheral vascular clamps*

Pinces-clamps vasculaires périphériques  
*Pinzas para vasos periféricos*  
 Pinze vascolari periferali

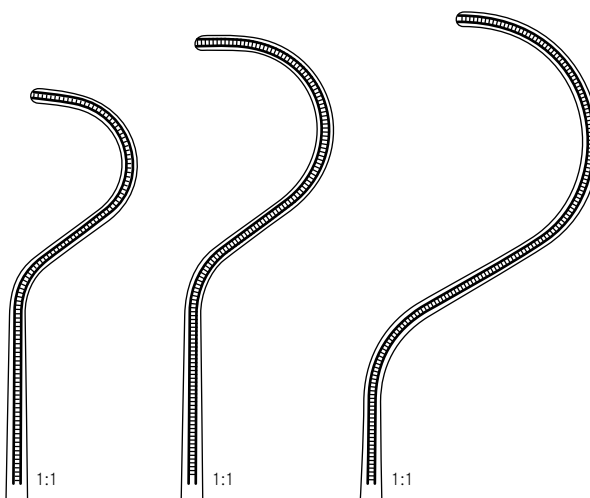

DALE	170 mm - 6 <sup>3</sup> / <sub>4</sub> "	175 mm - 7"	185 mm - 7 <sup>1</sup> / <sub>4</sub> "
	<b>tk 22017-17</b>	<b>tk 22017-18</b>	<b>tk 22017-19</b>

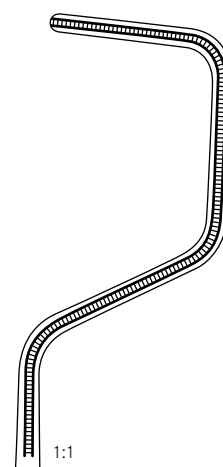

185 mm - 7 <sup>1</sup> / <sub>4</sub> "
<b>tk 22016-18</b>

Präparier- und Ligaturklemmen  
*Dissecting and ligature forceps*

Pinces à disséquer et à ligatures  
*Pinzas para preparaciones y ligaduras*  
Pinze per preparazioni e legature

**ATRAUMTK**



**Ligaturklemmen**  
**Ligature forceps**

Pinces à ligatures  
Pinzas para ligaduras  
Pinze per legature

**ATRAUMTK**



1:2

**DE BAKY-SEMB**

240 mm - 9½"

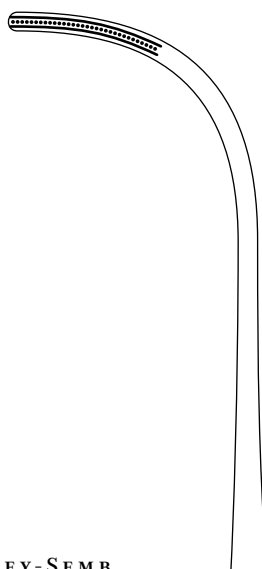

1:1

**tk 22117-24**

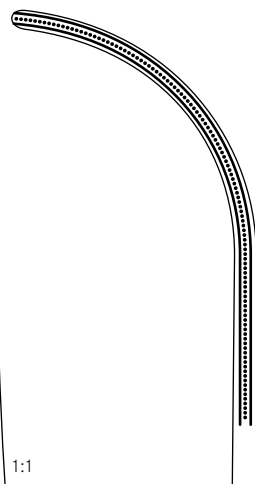

1:1

**tk 22118-24**



**DE BAKY**

250 mm - 10"

**tk 22120-25**



1:1

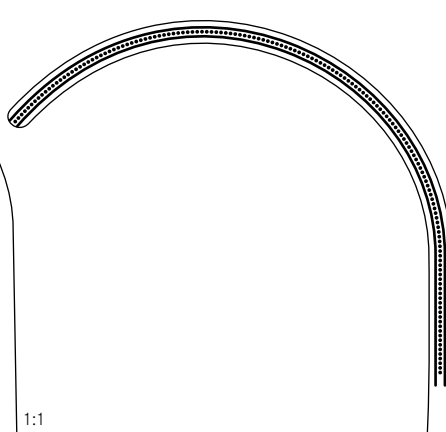

1:1

260 mm - 10¼"

**tk 22120-26**

Bronchusklemmen  
*Bronchus clamps*

Pinces-clamps à bronches  
*Pinzas bronquiales*  
Pinze per bronchi

**ATRAUM**TK

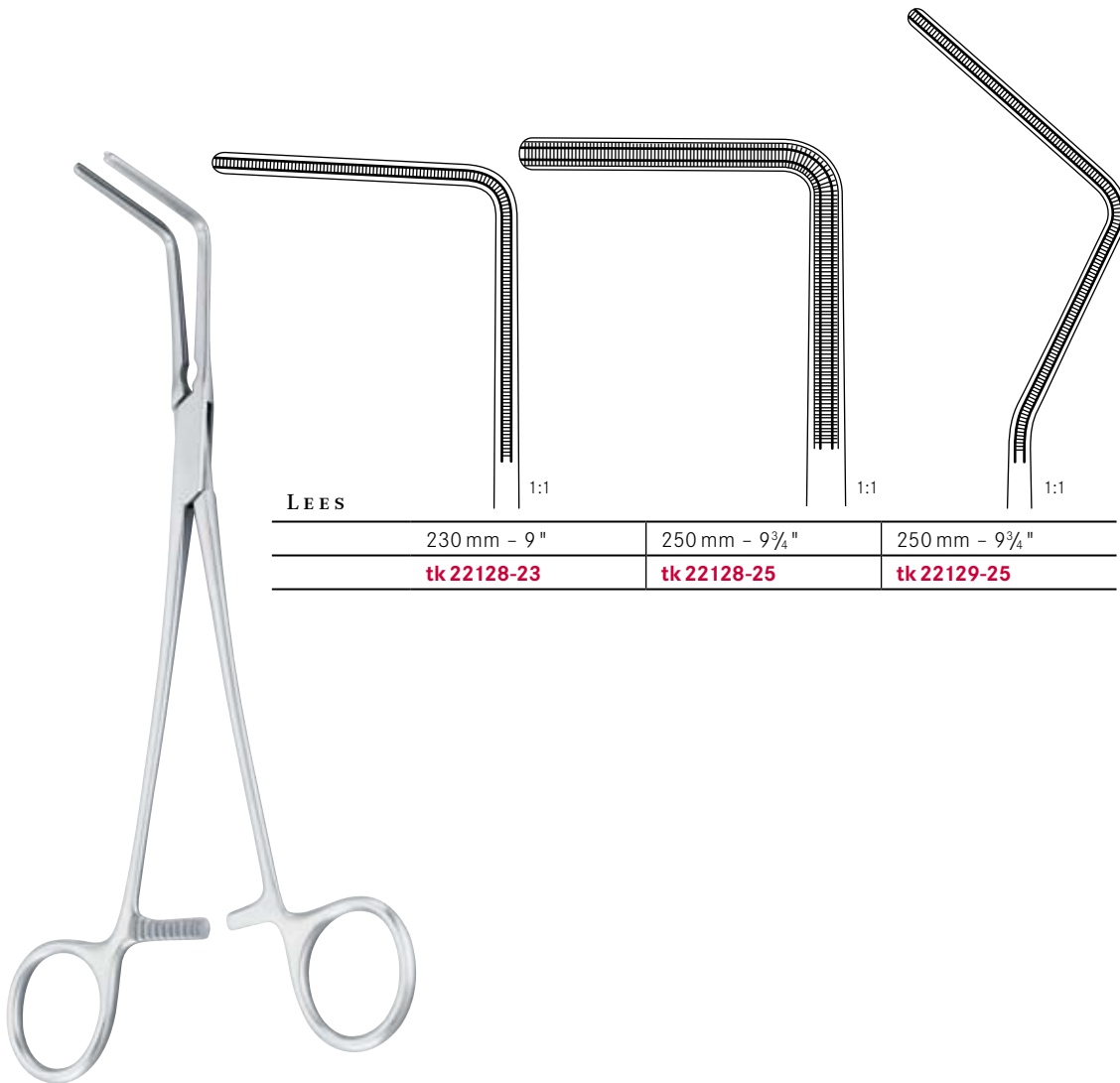

LEES

1:1

1:1

1:1

230 mm - 9"

250 mm - 9¾"

250 mm - 9¾"

**tk 22128-23**

**tk 22128-25**

**tk 22129-25**

Coarctationsklemmen  
Coarctation clamps

Pinces-clamps pour coarctation  
Pinzas para coarctación  
Pinze per coartazione

**ATRAUMTK**

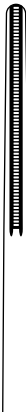
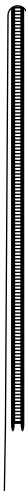
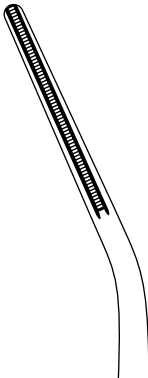
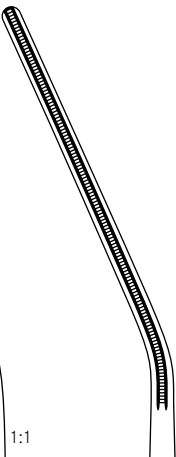

<b>POTTS</b>				
	1:1	1:1	1:1	1:1
	200 mm - 8"	220 mm - 8¾"	200 mm - 8"	220 mm - 8¾"
	<b>tk 22070-21</b>	<b>tk 22070-22</b>	<b>tk 22075-21</b>	<b>tk 22075-22</b>

**Carotis - Shuntklemmen**  
*Carotid shunt clamps*

Pinces pour carotide  
*Pinzas para shunt carótido*  
Pinze carotis

**ATRAUM**TK

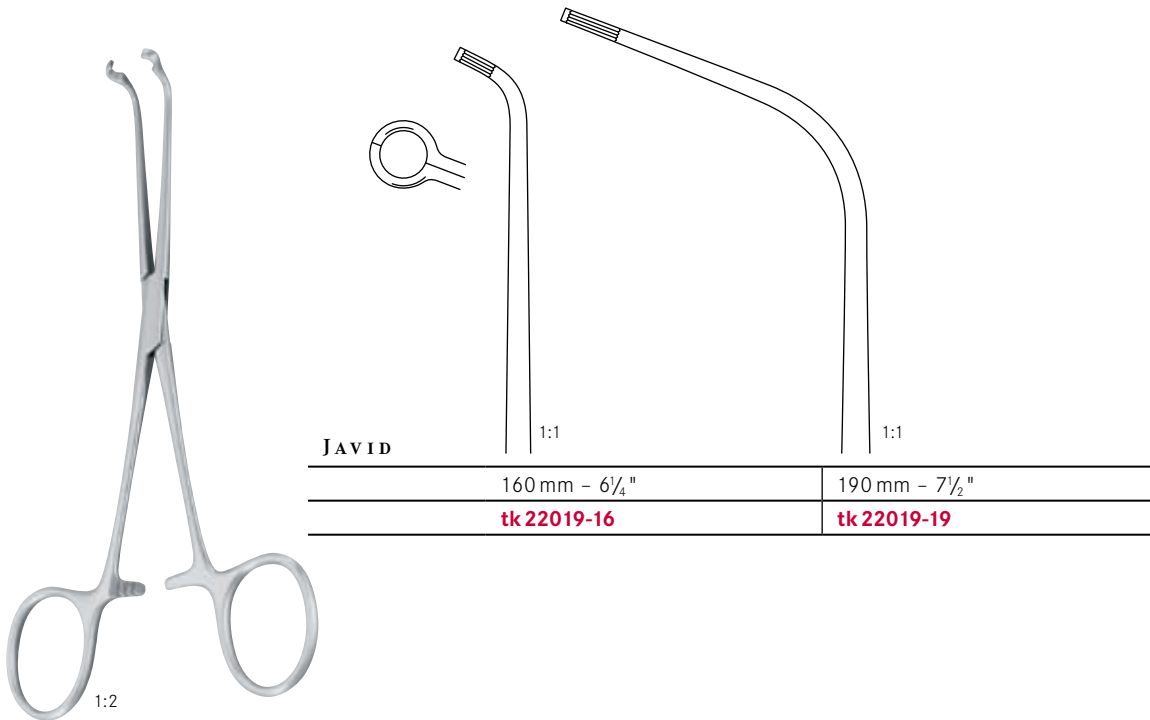



**Profundaklemmen**  
*Profunda clamps*

Pinces fémorale  
*Pinzas para la profunda*  
Pinze profunda

**ATRAUMTK**

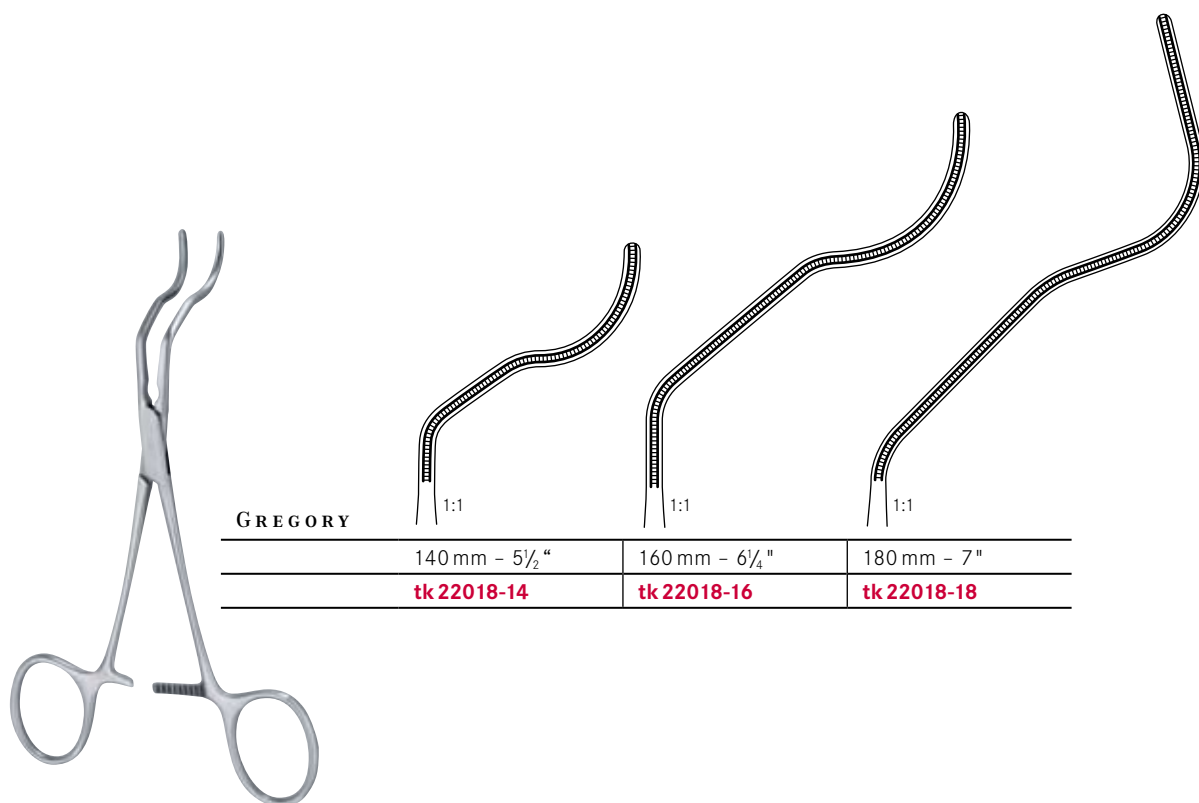

**GREGORY**

140 mm - 5½"	160 mm - 6¼"	180 mm - 7"
<b>tk 22018-14</b>	<b>tk 22018-16</b>	<b>tk 22018-18</b>

**Bulldogklemmen mit Ringgriff**  
*Ring handle bulldog clamps*

**Clamps Bulldog, manches à anneaux**  
*Clamps Bulldog, mangos con anillos*  
*Pinze Bulldog con manici ad anelli*

**ATRAUM**TK



**Neonatal- u. Kinderklemmen, extra feine Modelle**  
*Neonatal and children's clamps, extra delicate patterns*

Pinces pour nouveaux-nés et enfants, modèles très fins  
*Pinzas para recién nacidos y niños, modelos muy finos*  
 Pinze per bambini e neonati, molto fine



CASTAÑEDA			
110 mm - 4 1/4"			<b>tk 22001-03</b>
130 mm - 5"	<b>tk 22001-01</b>	<b>tk 22001-02</b>	
120 mm - 4 3/4"	<b>tk 22001-04</b>	<b>tk 22001-05</b>	<b>tk 22001-06</b>
150 mm - 6"			<b>tk 22001-07</b>

Neonatal- u. Kinderklemmen, extra feine Modelle  
*Neonatal and children's clamps, extra delicate patterns*

Pincés pour nouveaux-nés et enfants, modèles très fins  
*Pinzas para recién nacidos y niños, modelos muy finos*  
 Pinze per bambini e neonati, molto fine

**ATRAUM**TK

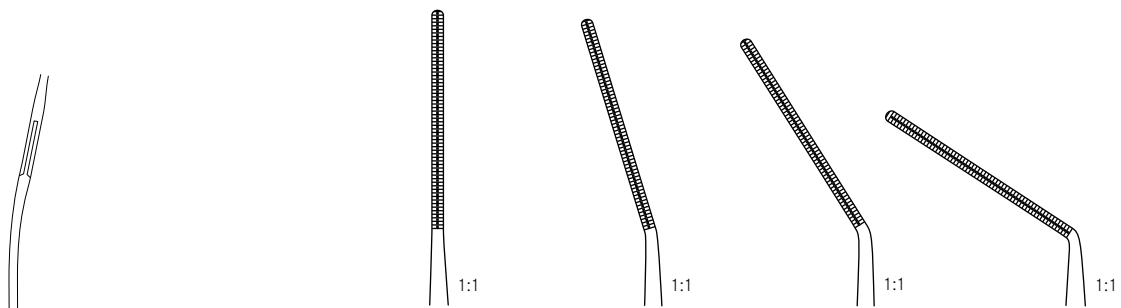

	Fig. 1	Fig. 2	Fig. 3	Fig. 4
115 mm - 4½"	Cooley <b>tk 22541-01</b>	Cooley <b>tk 22541-02</b>	Cooley <b>tk 22541-03</b>	Cooley <b>tk 22541-04</b>
	De Bakey <b>tk 22741-01</b>	De Bakey <b>tk 22741-02</b>	De Bakey <b>tk 22741-03</b>	De Bakey <b>tk 22741-04</b>

gebogen  
*curved*  
 courbe  
*curva*  
 curve

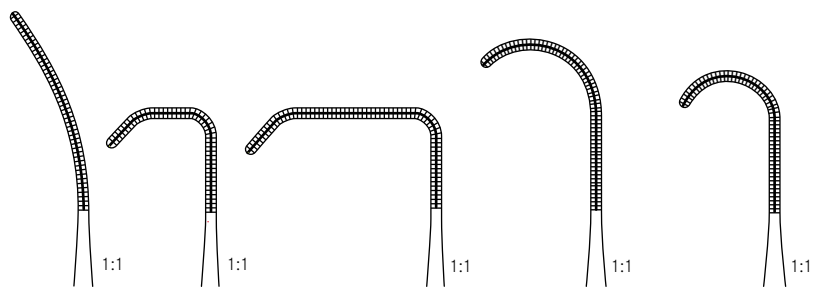

	Fig. 5	Fig. 6	Fig. 7	Fig. 8	Fig. 9
	Cooley <b>tk 22541-05</b>	Cooley <b>tk 22541-06</b>	Cooley <b>tk 22541-07</b>	Cooley <b>tk 22541-08</b>	Cooley <b>tk 22541-09</b>
	De Bakey <b>tk 22741-05</b>	De Bakey <b>tk 22741-06</b>	De Bakey <b>tk 22741-07</b>	De Bakey <b>tk 22741-08</b>	De Bakey <b>tk 22741-09</b>

**Neonatal- u. Kinderklemmen, extra feine Modelle**  
**Neonatal and children's clamps, extra delicate patterns**

Pinces pour nouveaux-nés et enfants, modèles très fins  
 Pinzas para recién nacidos y niños, modelos muy finos  
 Pinze per bambini e neonati, molto fine

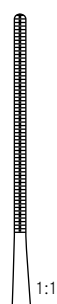









	Fig. 1	Fig. 2	Fig. 3	Fig. 4
115 mm - 4 1/2"	Cooley tk 22540-01	tk 22540-02	tk 22540-03	tk 22540-04
	De Bakey tk 22740-01	tk 22740-02	tk 22740-03	tk 22740-04











	Fig. 5	Fig. 6	Fig. 7	Fig. 8	Fig. 9
115 mm - 4 1/2"	Cooley tk 22540-05	tk 22540-06	tk 22540-07	tk 22540-08	tk 22540-09
	De Bakey tk 22740-05	tk 22740-06	tk 22740-07	tk 22740-08	tk 22740-09

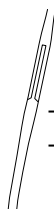
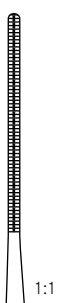









	Fig. 1	Fig. 2	Fig. 3	Fig. 4
115 mm - 4 1/2"	Cooley tk 22542-01	tk 22542-02	tk 22542-03	tk 22542-04
	De Bakey tk 22742-01	tk 22742-02	tk 22742-03	tk 22742-04

abgewinkelt  
 angled on flat  
 coudé sur le plat  
 anulado  
 angolato













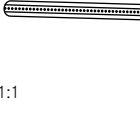

	Fig. 5	Fig. 6	Fig. 7	Fig. 8	Fig. 9
115 mm - 4 1/2"	Cooley tk 22542-05	tk 22542-06	tk 22542-07	tk 22542-08	tk 22542-09
	De Bakey tk 22742-05	tk 22742-06	tk 22742-07	tk 22742-08	tk 22742-09

Kinder-Gefäßklemmen  
*Pediatric vascular clamps*

Pinces vasculaires pédiatriques  
*Pinzas vasculares pediátricas*  
Pinze vascolari pediatriche

**ATRAUM**TK

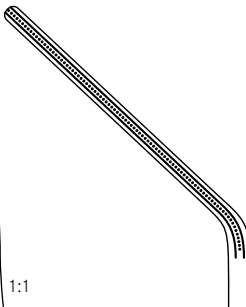

DE BAKEY					
	1:1	1:1	1:1	1:1	1:1
	120 mm - 4¾"	110 mm - 4¼"	100 mm - 4"	120 mm - 4¾"	130 mm - 5"
	<b>tk 22028-12</b>	<b>tk 22029-11</b>	<b>tk 22032-13</b>	<b>tk 22035-12</b>	<b>tk 22041-13</b>

Neonatal- u. Kinderklemmen, extra feine Modelle  
*Neonatal and children's clamps, extra delicate patterns*

Pinces pour nouveaux-nés et enfants, modèles très fins  
*Pinzas para recién nacidos y niños, modelos muy finos*  
 Pinze per bambini e neonati, molto fine

**ATRAUMTK**



1:2

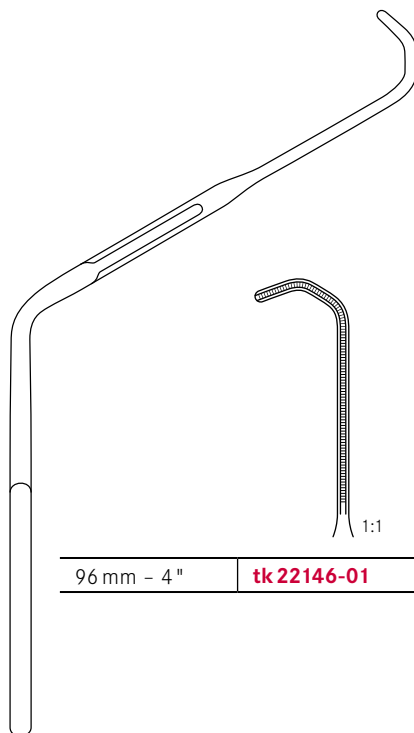

1:1

96 mm - 4"

**tk 22146-01**



1:2

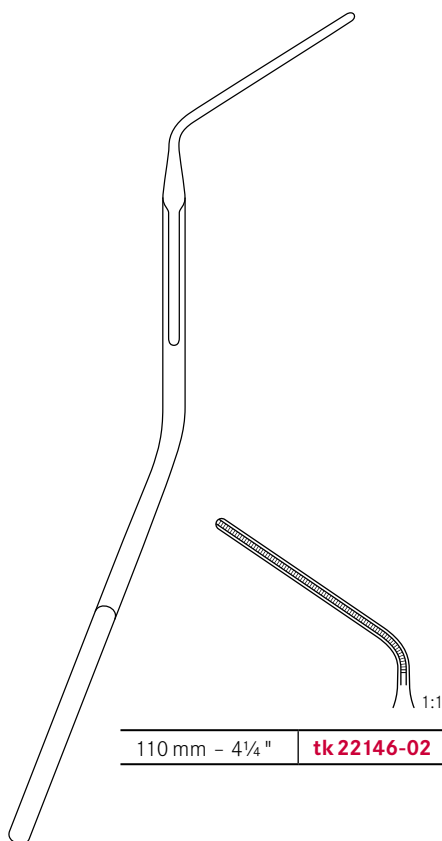

1:1

110 mm - 4¼"

**tk 22146-02**

Neonatal- u. Kinderklemmen, extra feine Modelle  
*Neonatal and children's clamps, extra delicate patterns*

Pinces pour nouveaux-nés et enfants, modèles très fins  
*Pinzas para recién nacidos y niños, modelos muy finos*  
Pinze per bambini e neonati, molto fine

**ATRAUMTK**



1:2



1:1

120 mm - 4¾"

**tk 22146-03**

löffelförmig  
*spoon shaped*  
en forme de cuillère  
*forma de cucharilla*  
forme di cucchaio



1:2

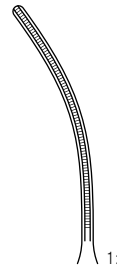

1:1

120 mm - 4¾"

**tk 22146-04**



1:2

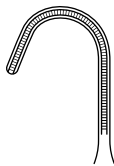

1:1

104 mm - 4"

**tk 22146-05**



1:2

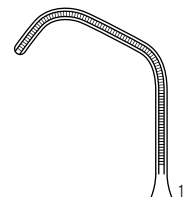

1:1

110 mm - 4¼"

**tk 22146-06**



Neonatal- u. Kinderklemmen, extra feine Modelle  
*Neonatal and children's clamps, extra delicate patterns*

Pinces pour nouveaux-nés et enfants, modèles très fins  
*Pinzas para recién nacidos y niños, modelos muy finos*  
 Pinze per bambini e neonati, molto fine

**ATRAUMTK**

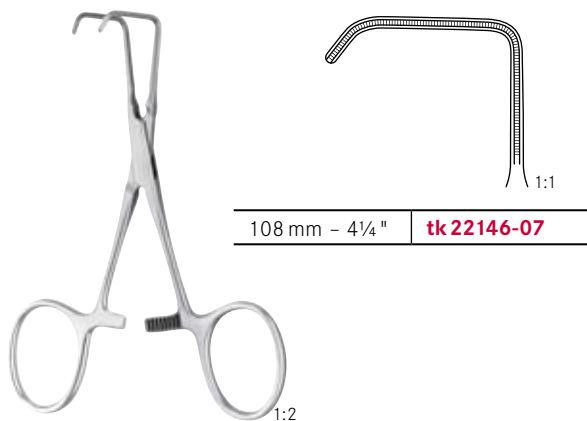

108 mm - 4¼" **tk 22146-07**



126 mm - 5" **tk 22146-09**

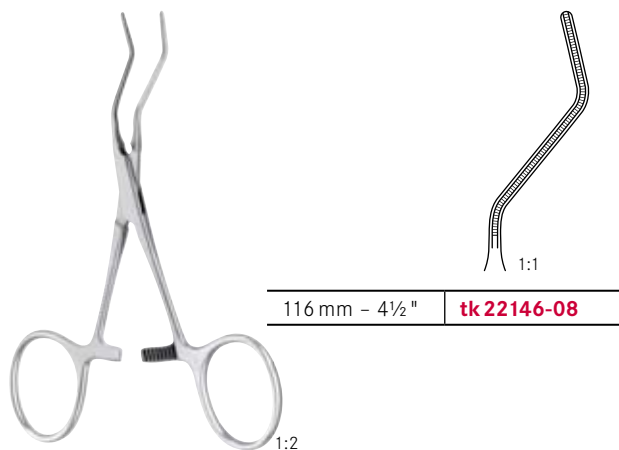

116 mm - 4½" **tk 22146-08**

Neonatal- u. Kinderklemmen, extra feine Modelle  
*Neonatal and children's clamps, extra delicate patterns*

Pinces pour nouveaux-nés et enfants, modèles très fins  
*Pinzas para recién nacidos y niños, modelos muy finos*  
Pinze per bambini e neonati, molto fine

**ATRAUMTK**



1:2

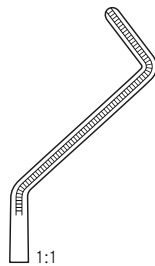

1:1

**KITZMILLER**

140 mm - 5½"

**tk 22531-01**

rechts  
*right*  
à droit  
*derecha*  
destra



1:2

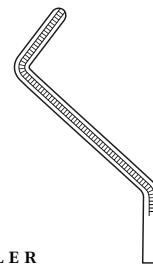

1:1

**KITZMILLER**

140 mm - 5½"

**tk 22531-02**

links  
*left*  
à gauche  
*izquierda*  
sinistra

Neonatal- u. Kinderklemmen, extra feine Modelle  
*Neonatal and children's clamps, extra delicate patterns*

Pinces pour nouveaux-nés et enfants, modèles très fins  
*Pinzas para recién nacidos y niños, modelos muy finos*  
 Pinze per bambini e neonati, molto fine

**ATRAUMTK**



**MARTINEZ**  
 180 mm - 7" | **tk 22531-03**

rechts  
*right*  
 à droite  
*derecha*  
 destra



**MARTINEZ**  
 180 mm - 7" | **tk 22531-04**

links  
*left*  
 à gauche  
*izquierda*  
 sinistra

Mikroscheren  
Micro scissors

Micro ciseaux  
Micro tijeras  
Micro forbici



1:1

NOYES



1:1



1:1



1:1

	Fig. 1	Fig. 2	Fig. 3
120 mm - 4 <sup>3</sup> / <sub>4</sub> "	<b>tk 9222-01</b>	<b>tk 9222-02</b>	<b>tk 9222-03</b>
gerade <i>straight</i>	spitz - spitz <i>sharp - sharp</i>	spitz - stumpf <i>sharp - blunt</i>	stumpf - stumpf <i>blunt - blunt</i>
droits <i>recta</i> rette	pointue - pointue <i>roma - roma</i> acuta - acuta	pointue - mousse <i>roma - aguda</i> acuta - smussa	mousse - mousse <i>aguda - aguda</i> smussa - smussa



1:1

NOYES



1:1

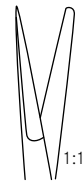

1:1

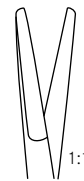

1:1

	Fig. 1	Fig. 2	Fig. 3
120 mm - 4 <sup>3</sup> / <sub>4</sub> "	<b>tk 9223-01</b>	<b>tk 9223-02</b>	<b>tk 9223-03</b>
abgewinkelt <i>angulated</i>	spitz - spitz <i>sharp - sharp</i>	spitz - stumpf <i>sharp - blunt</i>	stumpf - stumpf <i>blunt - blunt</i>
coudé <i>angulado</i> angolate	pointue - pointue <i>roma - roma</i> acuta - acuta	pointue - mousse <i>roma - aguda</i> acuta - smussa	mousse - mousse <i>aguda - aguda</i> smussa - smussa

**Mikro-Federscheren**  
*Micro scissors*

Micro ciseaux à ressorts  
*Micro tijeras con resorte*  
Forbici per microchirurgia



**YASARGIL**

185 mm - 7 1/4"



1:1

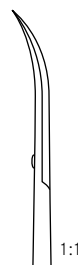

1:1

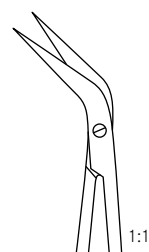

1:1

	<b>tk 25500-18</b>	<b>tk 25501-18</b>	<b>tk 25502-18</b>
gerade <i>straight</i>		gebogen <i>curved</i>	kniegebogen <i>angled on flat</i>
droits <i>recta</i>		courbes <i>curva</i>	angulaires <i>acodada</i>
retta		curva	angolata

Mikro-Federscheren  
*Micro scissors*

Micro ciseaux  
*Micro tijeras*  
Forbici per micro chirurgia



YASARGIL

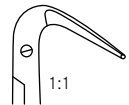
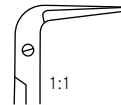
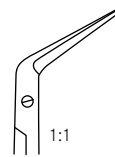
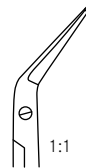

	25°	45°	60°	90°	125°
170 mm - 6 <sup>3</sup> / <sub>4</sub> "	<b>tk 25754-25</b>	<b>tk 25754-45</b>	<b>tk 25754-60</b>	<b>tk 25754-90</b>	<b>tk 25754-12</b>

mit Knopf  
*with ball*  
avec bouton  
*con botón*  
con bottone

YASARGIL

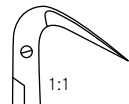
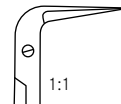
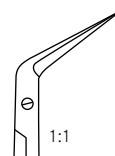
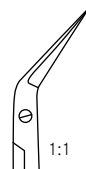

	25°	45°	60°	90°	125°
170 mm - 6 <sup>3</sup> / <sub>4</sub> "	<b>tk 25755-25</b>	<b>tk 25755-45</b>	<b>tk 25755-60</b>	<b>tk 25755-90</b>	<b>tk 25755-12</b>

ohne Knopf  
*without ball*  
sans bouton  
*sin botón*  
senza bottone

1:1

**Mikro-Präparierscheren**  
*Micro dissecting scissors*

Micro ciseaux à dissection  
*Micro tijeras de disección*  
Forbici per micro chirurgia

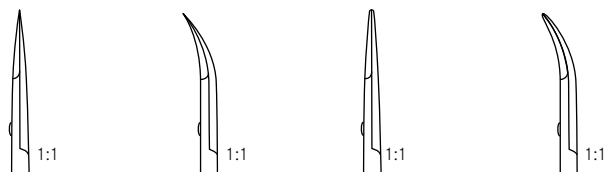

145 mm - 5¾"	<b>tk 25602-01</b>	<b>tk 25603-01</b>	<b>tk 25602-02</b>	<b>tk 25603-02</b>
180 mm - 7"	<b>tk 25610-01</b>	<b>tk 25611-01</b>	<b>tk 25610-02</b>	<b>tk 25611-02</b>

kurze Schneide 8 mm, glatt  
*short blades 8 mm, smooth*  
lames courtes 8 mm, lisses  
*hojas cortas 8 mm, lisos*  
lama corta 8 mm, liscia

gerade, spitz  
*straight, sharp*  
droites, pointues  
*rectas, agudas*  
retta, acuta

gebogen, spitz  
*curved, sharp*  
courbes, pointues  
*curvas, agudas*  
curva, acuta

gerade, stumpf  
*straight, blunt*  
droites, mousses  
*rectas, romas*  
retta, smussa

gebogen, stumpf  
*curved, blunt*  
courbes, mousses  
*curvas, romas*  
curva, smussa

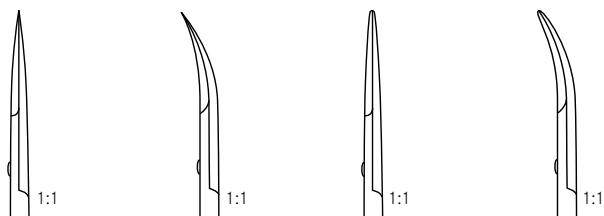

145 mm - 5¾"	<b>tk 25602-03</b>	<b>tk 25603-03</b>	<b>tk 25602-04</b>	<b>tk 25603-04</b>
180 mm - 7"	<b>tk 25610-03</b>	<b>tk 25611-03</b>	<b>tk 25610-04</b>	<b>tk 25611-04</b>

lange Schneide 14 mm, glatt  
*long blades 14 mm, smooth*  
lames longues 14 mm, lisses  
*hojas largas 14 mm, lisos*  
lama lunga 14 mm, liscia

gerade, spitz  
*straight, sharp*  
droites, pointues  
*rectas, agudas*  
retta, acuta

gebogen, spitz  
*curved, sharp*  
courbes, pointues  
*curvas, agudas*  
curva, acuta

gerade, stumpf  
*straight, blunt*  
droites, mousses  
*rectas, romas*  
retta, smussa

gebogen, stumpf  
*curved, blunt*  
courbes, mousses  
*curvas, romas*  
curva, smussa

Mikroscheren mit Rundgriff  
*Micro scissors with round handle*

Micro ciseaux avec manche ronde  
*Micro tijeras con mango redondo*  
 Forbici per micro chirurgia con manico rotondo

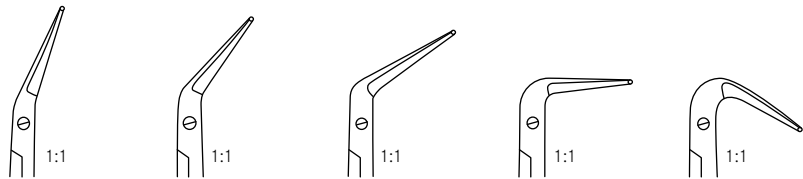

8 mm Ø	25°	45°	60°	90°	125°
180 mm - 7"	<b>tk 25758-25</b>	<b>tk 25758-45</b>	<b>tk 25758-60</b>	<b>tk 25758-90</b>	<b>tk 25758-12</b>

Schneide 10 mm, mit Knopf, spitz  
*Blade 10 mm, with ball, sharp*

Lames 10 mm, avec bouton, pointues  
*Hojas 10 mm, con botón, agudas*  
 Lama 10 mm, con bottone, acuta

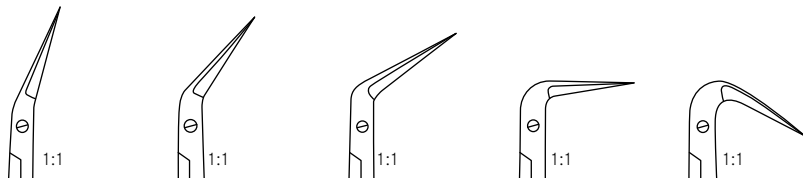

8 mm Ø	25°	45°	60°	90°	125°
180 mm - 7"	<b>tk 25759-25</b>	<b>tk 25759-45</b>	<b>tk 25759-60</b>	<b>tk 25759-90</b>	<b>tk 25759-12</b>

Schneide 10 mm, ohne Knopf, spitz  
*Blade 10 mm, without ball, sharp*

Lames 10 mm, sans bouton, pointues  
*Hojas 10 mm, sin botón, agudas*  
 Lama 10 mm, senza bottone, acuta



mit gedrehtem Schluss  
*90° twisted*  
 tordus de 90°  
 giradas de 90°  
 girato 90°



**Mikroscheren mit Rundgriff**  
*Micro scissors with round handle*

Micro ciseaux avec manche ronde  
*Micro tijeras con mango redondo*  
Forbici per micro chirurgia con manico rotondo

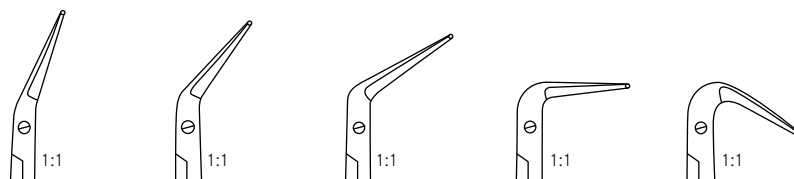

8 mm Ø	25°	45°	60°	90°	125°
180 mm - 7"	<b>tk 25756-25</b>	<b>tk 25756-45</b>	<b>tk 25756-60</b>	<b>tk 25756-90</b>	<b>tk 25756-12</b>

**mit Knopf**  
*with ball*  
avec bouton  
*con botón*  
con bottone

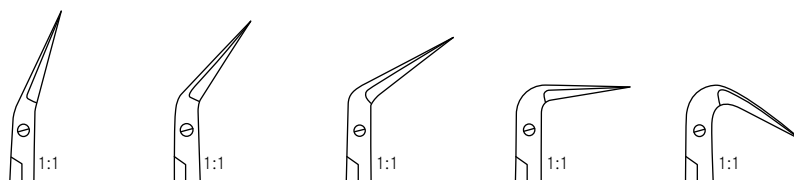

8 mm Ø	25°	45°	60°	90°	125°
180 mm - 7"	<b>tk 25757-25</b>	<b>tk 25757-45</b>	<b>tk 25757-60</b>	<b>tk 25757-90</b>	<b>tk 25757-12</b>

**ohne Knopf**  
*without ball*  
sans bouton  
*sin botón*  
senza bottone

Atraumatische Mikropinzetten  
*Atraumatic micro forceps*

Micro pinces atraumatiques  
*Micro pinces atraumaticas*  
 Micro pinze atraumatiche

ATRAUMTK

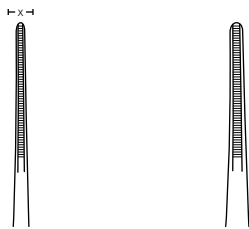

	x = 1.2 mm	x = 2.0 mm	x = 1.2 mm	x = 2.0 mm
150 mm - 6"	<b>tk 25690-01</b>	<b>tk 25690-02</b>	<b>tk 25690-03</b>	<b>tk 25690-04</b>
180 mm - 7"	<b>tk 25690-05</b>	<b>tk 25690-06</b>	<b>tk 25690-07</b>	<b>tk 25690-08</b>
210 mm - 8¼"	<b>tk 25690-09</b>	<b>tk 25690-10</b>	<b>tk 25690-11</b>	<b>tk 25690-12</b>
230 mm - 9"	<b>tk 25690-13</b>	<b>tk 25690-14</b>	<b>tk 25690-15</b>	<b>tk 25690-16</b>

gerade  
*straight*

gerade  
*straight*

abgewinkelt  
*angled*

abgewinkelt  
*angled*

droit  
*recta*  
 retta

droit  
*recta*  
 retta

angulaire  
*acodada*  
 angolata

angulaire  
*acodada*  
 angolata

**Mikro-Knüppfzangen**  
**Micro suture tying forceps**

Micro pinces pour sutures  
Micro pinzas para suturas  
Pinze per micro-sutura

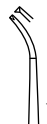

	9 mm Ø	9 mm Ø	9 mm Ø	9 mm Ø
180 mm - 7"	<b>tk 25695-01</b>	<b>tk 25695-02</b>	<b>tk 25695-05</b>	<b>tk 25695-06</b>

Fadenplatte 6,0 mm x 0,4 mm, glatt  
*Tying platform 6.0 mm x 0.4 mm, smooth*

1x2                      1x2

Plate-forme 6.0 mm x 0.4 mm, lisse  
*Plataforma 6.0 mm x 0.4 mm, lisa*  
Piano per sutura 6.0 mm x 0.4 mm, liscio

	9 mm Ø	9 mm Ø	9 mm Ø	9 mm Ø
180 mm - 7"	<b>tk 25695-09</b>	<b>tk 25695-10</b>	<b>tk 25695-13</b>	<b>tk 25695-14</b>

Fadenplatte 6,0 mm x 0,4 mm, diamantiert  
*Tying platform 6.0 mm x 0.4 mm, diamond coated*

1x2                      1x2

Plate-forme 6.0 mm x 0.4 mm, diamanté  
*Plataforma 6.0 mm x 0.4 mm, diamantada*  
Piano per sutura 6.0 mm x 0.4 mm, diamantata



	9 mm Ø	9 mm Ø	9 mm Ø	9 mm Ø
180 mm - 7"	<b>tk 25695-03</b>	<b>tk 25695-04</b>	<b>tk 25695-07</b>	<b>tk 25695-08</b>

Fadenplatte 6,0 mm x 0,8 mm, glatt  
*Tying platform 6.0 mm x 0.8 mm, smooth*

1x2                      1x2

Plate-forme 6.0 mm x 0.8 mm, lisse  
*Plataforma 6.0 mm x 0.8 mm, lisa*  
Piano per sutura 6.0 mm x 0.8 mm, liscio

	9 mm Ø	9 mm Ø	9 mm Ø	9 mm Ø
180 mm - 7"	<b>tk 25695-11</b>	<b>tk 25695-12</b>	<b>tk 25695-15</b>	<b>tk 25695-16</b>

Fadenplatte 6,0 mm x 0,8 mm, diamantiert  
*Tying platform 6.0 mm x 0.8 mm, diamond coated*

1x2                      1x2

Plate-forme 6.0 mm x 0.8 mm, diamanté  
*Plataforma 6.0 mm x 0.8 mm, diamantada*  
Piano per sutura 6.0 mm x 0.8 mm, diamantata

Mikronadelhalter mit Rundgriff  
*Micro needle holders with round handle*

Micro porte aiguilles avec manche ronde  
*Micro porta agujas con mango redondo*  
 Micro porta aghi con manico rotondo



110 mm - 4 1/4"	8 mm Ø	<b>tk 25637-11</b>	<b>tk 25638-11</b>
125 mm - 5"	7 mm Ø	<b>tk 25654-12</b>	<b>tk 25655-12</b>
130 mm - 5"	8 mm Ø	<b>tk 25658-13</b>	<b>tk 25659-13</b>
130 mm - 5"	10 mm Ø	<b>tk 25652-13</b>	<b>tk 25653-13</b>
150 mm - 6"	8 mm Ø	<b>tk 25640-15</b>	<b>tk 25641-15</b>
180 mm - 7"	8 mm Ø	<b>tk 25664-18</b>	<b>tk 25665-18</b>
180 mm - 7"	10 mm Ø	<b>tk 25668-18</b>	<b>tk 25669-18</b>

ohne Sperre  
*without ratchet*

sans crémaillère  
*sin cremallera*  
 senza cremagliera

gerade  
*straight*

droit  
*recta*  
 retto

gebogen  
*curved*

courbe  
*curva*  
 curvo

110 mm - 4 1/4"	8 mm Ø	<b>tk 25635-11</b>	<b>tk 25636-11</b>
125 mm - 5"	7 mm Ø	<b>tk 25656-12</b>	<b>tk 25657-12</b>
130 mm - 5"	8 mm Ø	<b>tk 25662-13</b>	<b>tk 25663-13</b>
130 mm - 5"	10 mm Ø	<b>tk 25645-13</b>	<b>tk 25646-13</b>
150 mm - 6"	8 mm Ø	<b>tk 25642-15</b>	<b>tk 25643-15</b>
180 mm - 7"	8 mm Ø	<b>tk 25666-18</b>	<b>tk 25667-18</b>
180 mm - 7"	10 mm Ø	<b>tk 25670-18</b>	<b>tk 25671-18</b>

mit Sperre  
*with ratchet*

avec crémaillère  
*con cremallera*  
 con cremagliera

gerade  
*straight*

droit  
*recta*  
 retto

gebogen  
*curved*

courbe  
*curva*  
 curvo

**Mikronadelhalter**  
*Micro needle holders*

Micro porte aiguilles  
*Micro porta agujas*  
Micro porta aghi

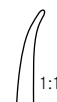

	0.3 mm x 0.4 mm	0.3 mm x 0.4 mm
180 mm - 7"	<b>tk 25685-07</b>	<b>tk 25685-08</b>

**Titan, mit Sperre**  
*Titanium, with ratchet*  
Titane, avec crémaillère  
*Titano, con cremallera*  
Titanio, con cremagliera

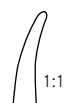

	0.8 mm x 0.8 mm	0.8 mm x 0.8 mm
185 mm - 7 1/4"	<b>tk 25685-09</b>	<b>tk 25685-10</b>

**Titan, mit Sperre**  
*Titanium, with ratchet*  
Titane, avec crémaillère  
*Titano, con cremallera*  
Titanio, con cremagliera

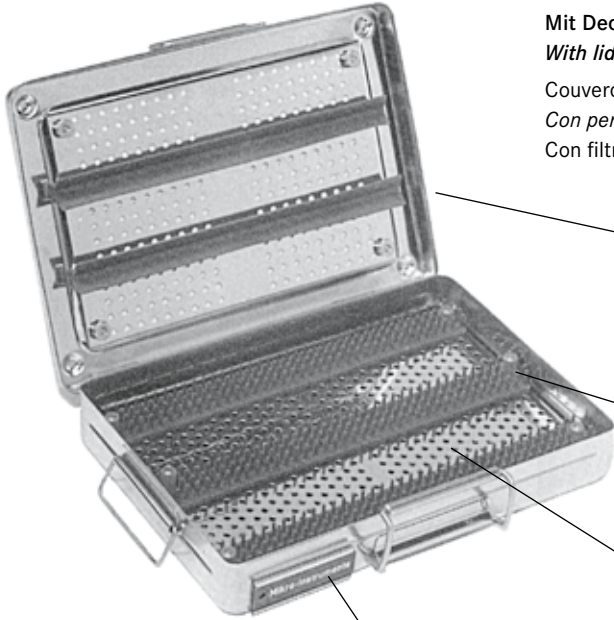
**Instrumenten-Kassetten aus Edelstahl**  
*Instrument trays made of stainless steel*
**Contenaires d'instruments en acier inox**  
*Cajas para instrumental en acero inox*  
**Scatole per sterilizzazione di acciaio inossidabile**

Mit Deckel- und Bodenlochung mit Textil-Langzeitfiltern für Dampfsterilisation  
*With lid and bottom perforation with textil "Longterm" filters for steam sterilisation*  
 Couvercle et boîtier perforé avec filtre en textile pour stérilisation à vapeur  
*Con perforación en tapa y fondo, con filtros en tejido para esterilización a vapor*  
 Con filtri tessili, per la sterilizzazione a vapore

**Silikon-Andrückleisten zum Fixieren der Instrumente**  
*Silicone protective strips for fixation of instruments*

Tapis en silicone pour fixer les instruments  
*Tiras de silicon para fijar los instrumentos*  
 Righe di silicone per fissare gli strumenti

**Silikon-Noppenstreifen zur schonenden Auflage der Instrumente**  
*Silicon strips for a soft and protective storage of the instruments*

Tapis en silicone pour la protection des instruments  
*Matas de silicon para proteger los instrumentos*  
 Stuoie di silicone per proteggere gli strumenti

**1 herausnehmbare Siebplatte**  
*1 removable tray insert*

1 tableau pour sortir  
*1 placa para sacar*  
 1 cestello

**Kennzeichnungsschilder nach Wahl (Farbe und Text)**  
*Marking plate for selection: colour and description*

Plaquette d'identification (texte et couleur selon demande)  
*Placas de identificación a opción (color y texto)*  
 Placche d'identificazione (colore a scelta)

280 x 195 x 55 mm	265 x 255 x 55 mm	380 x 260 x 55 mm	200 x 140 x 55 mm	470 x 250 x 55 mm
<b>tk 85100-01</b>	<b>tk 85101-01</b>	<b>tk 85102-01</b>	<b>tk 85103-01</b>	<b>tk 85104-01</b>

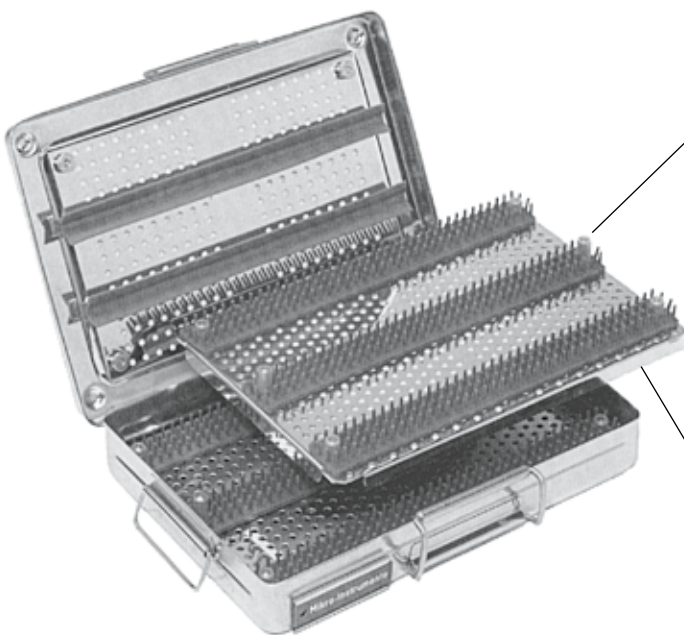

**wärmeisolierende Halteknöpfe zum Herausheben**  
*heatisolated handles*

pins isolés pour sortir des tableaux  
*pernos aislados para sacar las placas*  
 maniglia a forma di botone

**2 herausnehmbare Siebplatten**  
*2 removable tray inserts*

2 tableaux detachables  
*2 placas para sacar*  
 2 cestelli

**Silikon-Andrückleisten an der Unterseite des Siebes**  
*Silicone protective strips at the lower side of the tray*

Tapis de silicone à la partie inférieure des tableaux  
*Tiras de silicon a bajo de las placas*  
 Righe di silicone

280 x 195 x 65 mm	265 x 255 x 65 mm	380 x 260 x 65 mm	200 x 140 x 65 mm	470 x 250 x 65 mm
<b>tk 85100-03</b>	<b>tk 85101-03</b>	<b>tk 85102-03</b>	<b>tk 85103-03</b>	<b>tk 85104-03</b>



**STERILIZATION**



Steril Container - System II  
Steril Container - System II

Contenaires pour stérilisation - système II  
Contenedores para esterilización - sistema II  
Cestelli per sterilizzazione - sistema II



Bitte fordern Sie unseren Spezialkatalog an.  
*Please ask for our special catalogue.*

Veuillez demander pour notre catalogue spécial.  
*Por favor preguntan para el catalogo especial.*

Per favore domandate per il nostro catalogo speciale

Anlegepinzetten für Gefäßclips  
*Applying forceps for vessel clips*

Pinces à poser des clips  
*Aplicadoras para clips*  
 Pinze per mettere clips



140 mm - 5½"

**tk 25059-01**

**tk 25059-02**

mit Schloß  
*with lock*  
 avec serrure  
*con cierre*  
 con cremagliera



140 mm - 5½"

**tk 25059-03**

für Approximatoren und Doppelklemmen  
*for approximators and double-clips*  
 pour approximateurs et clips doubles  
*para aproximadores y clips dobles*  
 per approssimatori e clips doppi

für Clips tk 25060-01 bis tk 27075-04  
*for clips tk 25060-01 to tk 27075-04*  
 pour clips tk 25060-01 a tk 27075-04  
*para clips tk 25060-01 a tk 27075-04*  
 per clips tk 25060-01 a tk 27075-04

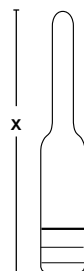

x	Ø	V	A
Länge <i>Length</i>	Gefäß <i>Vessel</i>	Vene <i>Vein</i>	Arterie <i>Artery</i>
Longueur <i>Longitud</i>	Vaisseau <i>Vaso</i>	Veine <i>Vena</i>	Artère <i>Arteria</i>
Lunghezza	Vaso	Vena	Arteria







Weitere Modelle und Ausführungen auf Anfrage.  
*Other models and executions upon request.*  
 Autres modèles et exécutions sur demande.  
*Otros modelos y ejecuciones segun demanda.*  
 Altri modelli a richiesta.



**Approximatoren, Gefäßclips**  
*Approximators, clips*

Approximateurs, clips  
*Aproximadores, clips*  
Approssimatori, clips vascolari

x = 8 mm

V	<b>tk 25060-01</b>	<b>tk 25060-02</b>	<b>tk 25060-03</b>	<b>tk 25060-04</b>
A	<b>tk 25070-01</b>	<b>tk 25070-02</b>	<b>tk 25070-03</b>	<b>tk 25070-04</b>

Ø = 0,4 mm - 1 mm

x = 11 mm

V	<b>tk 25061-01</b>	<b>tk 25061-02</b>	<b>tk 25061-03</b>	<b>tk 25061-04</b>
A	<b>tk 25071-01</b>	<b>tk 25071-02</b>	<b>tk 25071-03</b>	<b>tk 25071-04</b>

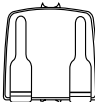
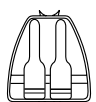
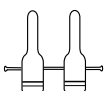
Ø = 0,6 mm - 1,5 mm

x = 14 mm

V	<b>tk 25062-01</b>	<b>tk 25062-02</b>	<b>tk 25062-03</b>	<b>tk 25062-04</b>
A	<b>tk 25072-01</b>	<b>tk 25072-02</b>	<b>tk 25072-03</b>	<b>tk 25072-04</b>

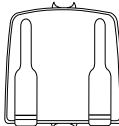
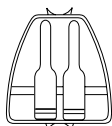
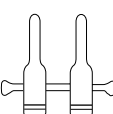
Ø = 1 mm - 2 mm

x = 17 mm

V	<b>tk 25063-01</b>	<b>tk 25063-02</b>	<b>tk 25063-03</b>	<b>tk 25063-04</b>
A	<b>tk 25073-01</b>	<b>tk 25073-02</b>	<b>tk 25073-03</b>	<b>tk 25073-04</b>

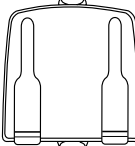
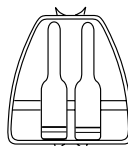
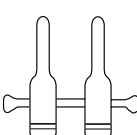
Ø = 1 mm - 2,25 mm

x = 25 mm

V	<b>tk 25064-01</b>	<b>tk 25064-02</b>	<b>tk 25064-03</b>	<b>tk 25064-04</b>
A	<b>tk 25074-01</b>	<b>tk 25074-02</b>	<b>tk 25074-03</b>	<b>tk 25074-04</b>

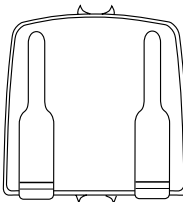
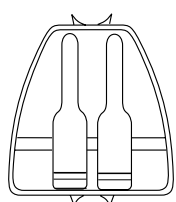
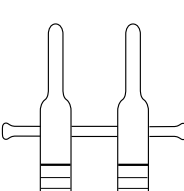
Ø = 1,5 mm - 3,5 mm

x = 36 mm

V	<b>tk 25065-01</b>	<b>tk 25065-02</b>	<b>tk 25065-03</b>	<b>tk 25065-04</b>
A	<b>tk 25075-01</b>	<b>tk 25075-02</b>	<b>tk 25075-03</b>	<b>tk 25075-04</b>

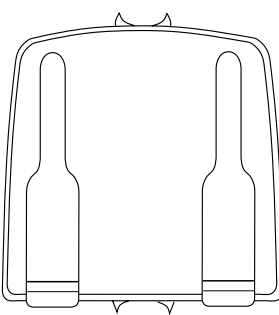
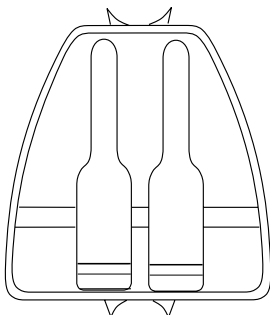
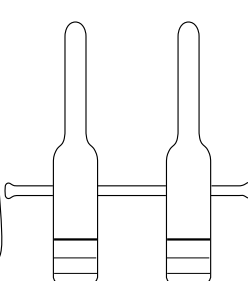
Ø = 1,5 mm - 3,5 mm

Approximatoren, Gefäßclips nach Biemer  
*Approximators, Biemer clips*

Approximateurs, clips selon Biemer  
*Aproximadores, Biemer clips*  
Approssimatori, clips vascolari Biemer



BIEMER

**tk 25209-02**

Anlegepinzette mit Schloss  
*Applying forceps with lock*

Pince à poser avec verrou  
*Aplicadora con cierre*

Pinza posa clips con cremagliera

**tk 25209-01**

Anlegepinzette ohne Schloss  
*Applying forceps without lock*

Pince à poser sans verrou  
*Aplicadora sin cierre*

Pinza posa clips senza cremagliera

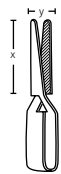

x	y	gms
Maullänge <i>Jaw length</i>	max. Maulöffnung <i>max. jaw opening</i>	Schließkraft <i>Closing pressure</i>
Longueur du mors <i>Longitud de la boca</i>	ouverture max. du mors <i>apertura max. de la boca</i>	Force de fermeture <i>Fuerza de cierre</i>
Lunghzza del morso	apertura mass.	Pressione



**tk 25210-00**

x = 6 mm  
y = 4 mm  
gms = 30-40

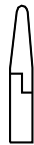

**tk 25211-00**

x = 9 mm  
y = 5 mm  
gms = 30-40

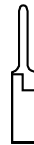

**tk 25212-00**

x = 9 mm  
y = 5 mm  
gms = 20-25

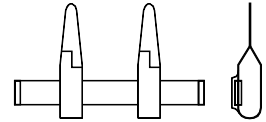

**tk 25213-00**

x = 4.5 mm  
y = 3.0 mm  
gms = 30-40

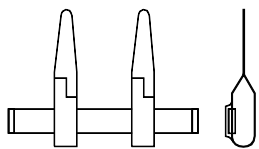

**tk 25214-00**

x = 9 mm  
y = 5 mm  
gms = 30-40

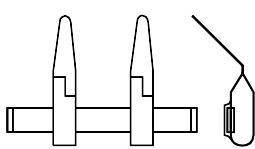

**tk 25215-00**

x = 9 mm  
y = 5 mm  
gms = 30-40

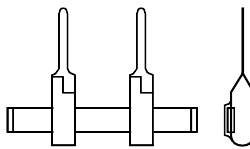

**tk 25216-00**

x = 9 mm  
y = 5 mm  
gms = 20-25

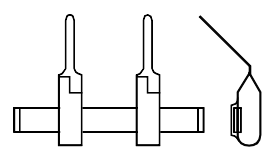

**tk 25217-00**

x = 9 mm  
y = 5 mm  
gms = 30-40

Für temporären Gebrauch, (gekennzeichnet durch gelb eingefärbte Federenden) für Gefäße mit 0,5 mm – 2,0 mm Ø. Maulinnenflächen schräg gerieft für schonendes und sicheres Festhalten der Gefäße. Der fest eingestellte Schließdruck gewährt risikofreie Anwendung.

*For temporary occlusion, (identified by yellow coloured spring ends) for vessels of 0,5 mm – 2,0 mm Ø. Blade gripping surface with oblique serrations for save but careful gripping of vessels. No risk due to rigidly fixed pressure measure.*

Pour usage temporaire, (ressorts couleur jaune) pour vaisseaux de 0,5 mm – 2,0 mm Ø. Mors striés pour fixation sûr et menagement. Force du fermeture non changeable.

*Para oclusión temporal (ressortes amarillos) para vasos de 0,5 mm – 2,0 mm Ø. Boca estriada para fijación segura y moderada de los vasos. Utilización sin riesgo con fuerza de oclusión fijo.*

Per uso temporaneo, con finale della molla giallo, per vasi di 0,5 mm – 2,0 mm Ø. Morso zigrinato per una presa sicura, non traumatica.

**Approximatoren, Gefäßclips nach Müller**  
*Approximators, Müller clips*

Approximateurs, clips selon Müller  
*Aproximadores, Müller clips*  
Approssimatori, clips vascolari Müller



**MÜLLER**

**tk 25076-50**

**tk 25076-51**

**Anlegepinzette ohne Schloss**  
*Applying forceps without lock*

**Anlegepinzette mit Schloss**  
*Applying forceps with lock*

Pince à poser sans verrou

Pince à poser avec verrou

Aplicadora sin cierre

Aplicadora con cierre

Pinza posa clips senza cremagliera

Pinza posa clips con cremagliera



**gms**

**Schließkraft**  
*Closing pressure*

Force de fermeture

Fuerza de cierre

Pressione

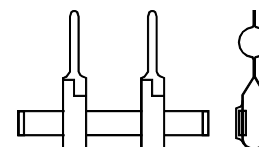
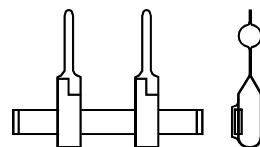
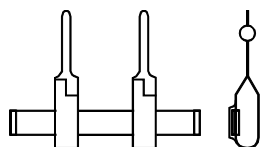
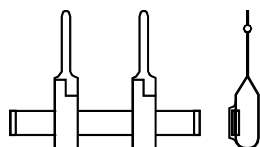

**tk 25076-01**

**tk 25076-02**

**tk 25076-03**

**tk 25076-04**

Ø = 1 mm  
gms = 10-15

Ø = 2 mm  
gms = 10-15

Ø = 3 mm  
gms = 15-20

Ø = 4 mm  
gms = 15-20

Für temporären Gebrauch, für Gefäße mit 0,5 mm – 2,0 mm Ø. Maulinnenflächen schräg gerieft für schonendes und sicheres Festhalten der Gefäße. Der fest eingestellte Schließdruck gewährt risikofreie Anwendung.

*For temporary occlusion, for vessels of 0,5 mm – 2,0 mm Ø. Blade gripping surface with oblique serrations for save but careful gripping of vessels. No risk due to rigidly fixed pressure measure.*

Pour usage temporaire, pour vaisseaux de 0,5 mm – 2,0 mm Ø. Mors striés pour fixation sûr et menagement. Force du fermeture non changeable.

*Para oclusión temporal para vasos de 0,5 mm – 2,0 mm Ø. Boca estriada para fijación segura y moderada de los vasos. Utilización sin riesgo con fuerza de oclusión fijo.*

Per uso temporaneo, per vasi di 0,5 mm – 2,0 mm Ø. Morso zigrinato per una presa sicura, non traumatica.

Gefäßclips nach Mehdorn, Anlegepinzette  
Mehdorn vessel clips, applying forceps

Clips selon Mehdorn, pince à poser  
Mehdorn clips, aplicadora  
Clips vascolari Mehdorn, pinza posa clips



MEHDORN

tk 25077-50

Anlegepinzette  
Applying forceps

Pince à poser des clips  
Aplicadora  
Pinza posa clips



x	y	gms
Maullänge Jaw length	max. Maulöffnung max. jaw opening	Schließkraft Closing pressure
Longueur du mors Longitud de la boca Lunghezza del morso	ouverture max. du mors apertura max. de la boca apertura mass.	Force de fermeture Fuerza de cierre Pressione

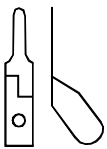

tk 25077-01

x = 4 mm  
y = 1 mm  
gms = 10-15

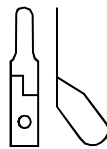

tk 25277-02

x = 4.0 mm  
y = 1.4 mm  
gms = 10-15

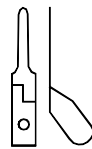

tk 25277-03

x = 6 mm  
y = 1 mm  
gms = 15-20

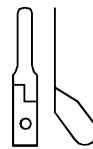

tk 25277-04

x = 6.0 mm  
y = 1.4 mm  
gms = 15-20

Für temporären Gebrauch, (gekennzeichnet durch gelb eingefärbte Federenden) für Gefäße mit 0,5 mm – 2,0 mm Ø. Maulinnenflächen schräg gerieft für schonendes und sicheres Festhalten der Gefäße. Der fest eingestellte Schließdruck gewährt risikofreie Anwendung.

For temporary occlusion, (identified by yellow coloured spring ends) for vessels of 0,5 mm – 2,0 mm Ø. Blade gripping surface with oblique serrations for save but careful gripping of vessels. No risk due to rigidly fixed pressure measure.

Pour usage temporaire, (ressorts couleur jaune) pour vaisseaux de 0,5 mm – 2,0 mm Ø. Mors striés pour fixation sûr et menagement. Force du fermeture non changeable.

Para oclusión temporal (ressortes amarillos) para vasos de 0,5 mm – 2,0 mm Ø. Boca estriada para fijación segura y moderada de los vasos. Utilización sin riesgo con fuerza de oclusión fija.

Per uso temporaneo, con finale della molla giallo, per vasi di 0,5 mm – 2,0 mm Ø. Morso zigrinato per una presa sicura, non traumatica.

**Mikro-Gefäßclips** | Micro clips pour vaisseaux  
**Micro vessel clips** | *Micro clips para vasos*  
 Micro clips per vasi

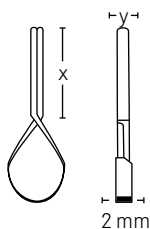

x	y	gms
<b>Maullänge</b> <i>Jaw length</i>	<b>max. Maulöffnung</b> <i>max. jaw opening</i>	<b>Schließkraft</b> <i>Closing pressure</i>
Longueur du mors <i>Longitud de la boca</i>	ouverture max. du mors <i>apertura max. de la boca</i>	Force de fermeture <i>Fuerza de cierre</i>
Lunghezza del morso	apertura mass.	Pressione

**für temporären Verschluss**  
*for temporary closure*  
 pour fermeture temporaire  
*para oclusión temporal*  
 per chiusura temporanea

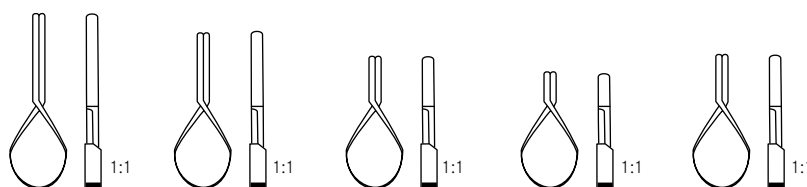

x = 10.0 mm	x = 8.0 mm	x = 6.0 mm	x = 4.0 mm	x = 6.0 mm
y = 1.5 mm	y = 1.0 mm	y = 0.8 mm	y = 0.75 mm	y = 1.0 mm
gms = 70	gms = 70	gms = 70	gms = 70	gms = 70
<b>tk 25723-01</b>	<b>tk 25723-02</b>	<b>tk 25723-03</b>	<b>tk 25723-04</b>	<b>tk 25723-05</b>

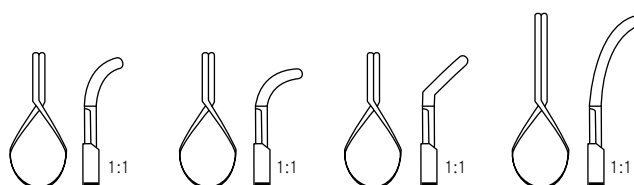

x = 6.0 mm	x = 6.0 mm	x = 6.0 mm	x = 10.0 mm
y = 1.0 mm	y = 1.0 mm	y = 1.0 mm	y = 1.0 mm
gms = 70	gms = 70	gms = 70	gms = 70
<b>tk 25724-01</b>	<b>tk 25724-02</b>	<b>tk 25724-03</b>	<b>tk 25724-04</b>



150 mm - 6" **tk 25720-13**

**mit Sperre**  
*with ratchet*  
 avec crémaillère  
*con cierre*  
 con cremagliera

180 mm - 7" **tk 25722-18**

**mit Sperre, bajonettförmig**  
*with ratchet, bayonet shaped*  
 avec crémaillère, en forme de baionette  
*con cierre, en forma de bayoneta*  
 con cremagliera, a forma baionetta

für Clips tk 25723-01 bis tk 25726-04  
*for clips tk 25723-01 to tk 25726-04*  
 pour clips tk 25723-01 a tk 25726-04  
*para clips tk 25723-01 a tk 25726-04*  
 per clips tk 25723-01 a tk 25726-04

**Mikro-Gefäßclips**  
**Micro vessel clips**

Micro clips pour vaisseaux  
*Micro clips para vasos*  
Micro clips per vasi

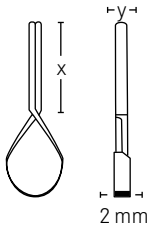

x	y	gms
<b>Maullänge</b> <i>Jaw length</i>	<b>max. Maulöffnung</b> <i>max. jaw opening</i>	<b>Schließkraft</b> <i>Closing pressure</i>
Longueur du mors <i>Longitud de la boca</i>	ouverture max. du mors <i>apertura max. de la boca</i>	Force de fermeture <i>Fuerza de cierre</i>
Lunghezza del morso	apertura mass.	Pressione

**für temporären Verschluss**  
**for temporary closure**

pour fermeture temporaire  
*para oclusión temporal*  
per chiusura temporanea

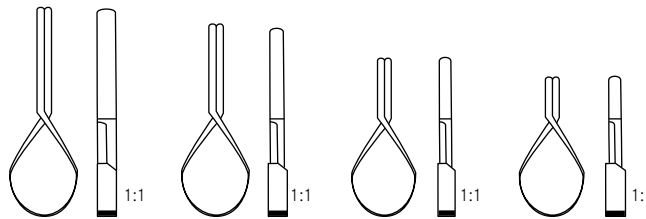

x = 10.0 mm	x = 8.0 mm	x = 6.0 mm	x = 4.0 mm
y = 2.0 mm	y = 2.0 mm	y = 1.0 mm	y = 0.75 mm
gms = 150	gms = 150	gms = 150	gms = 150
<b>tk 25725-01</b>	<b>tk 25725-02</b>	<b>tk 25725-03</b>	<b>tk 25725-04</b>

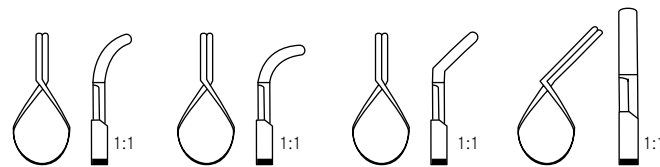

x = 6.0 mm	x = 6.0 mm	x = 6.0 mm	x = 8.0 mm
y = 1.0 mm	y = 1.0 mm	y = 1.0 mm	y = 2.0 mm
gms = 150	gms = 150	gms = 150	gms = 150
<b>tk 25726-01</b>	<b>tk 25726-02</b>	<b>tk 25726-03</b>	<b>tk 25726-04</b>

**Gefäßclips nach Müller**  
*Müller vessel clips*

Clips selon Müller  
*Müller clips*  
Clips vascolari Müller

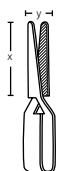

gms

Schließkraft  
*Closing pressure*  
Force de fermeture  
*Fuerza de cierre*  
Pressione

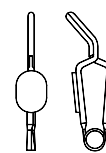
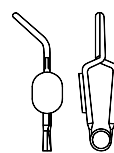
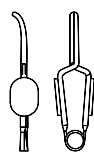
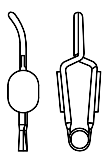
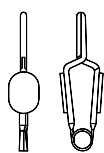

gms = 50	<b>tk 25066-01</b>	<b>tk 25066-03</b>	<b>tk 25066-05</b>	<b>tk 25066-07</b>	<b>tk 25066-09</b>
gms = 80	<b>tk 25066-02</b>	<b>tk 25066-04</b>	<b>tk 25066-06</b>	<b>tk 25066-08</b>	<b>tk 25066-10</b>

Für temporären Gebrauch, für Gefäße mit 0,5 mm – 2,0 mm Ø. Maulinnenflächen schräg gerieft für schonendes und sicheres Festhalten der Gefäße. Der fest eingestellte Schließdruck gewährt risikofreie Anwendung.

*For temporary occlusion, for vessels of 0,5 mm – 2,0 mm Ø. Blade gripping surface with oblique serrations for save but careful gripping of vessels. No risk due to rigidly fixed pressure measure.*

Pour usage temporaire, pour vaisseaux de 0,5 mm – 2,0 mm Ø. Mors striés pour fixation sûr et menagement. Force du fermeture non changeable.

*Para oclusión temporal para vasos de 0,5 mm – 2,0 mm Ø. Boca estriada para fijación segura y moderada de los vasos. Utilización sin riesgo con fuerza de oclusión fija.*

Per uso temporaneo, per vasi di 0,5 mm – 2,0 mm Ø. Morso zigrinato per una presa sicura, non traumatica.

Schlauchklemmen  
Tubing clamps

Presse-tubes  
Pinzas para tubos  
Pinze serratubi



150 mm - 6 "	<b>tk 14100-15</b>
160 mm - 6 1/4 "	<b>tk 14100-16</b>
190 mm - 7 1/2 "	<b>tk 14100-19</b>
240 mm - 9 1/2 "	<b>tk 14100-24</b>

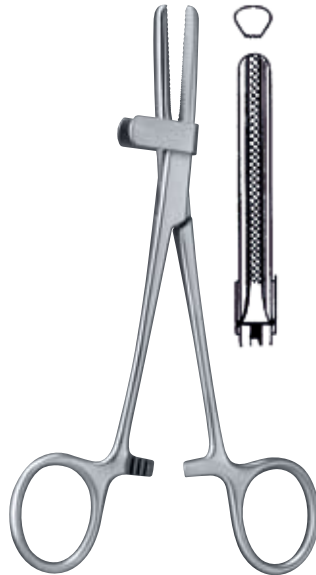

150 mm - 6 "	<b>tk 14101-15</b>
160 mm - 6 1/4 "	<b>tk 14101-16</b>
190 mm - 7 1/2 "	<b>tk 14101-19</b>

mit Schutzbügel  
*with protection*  
avec protection  
*con protector*  
con protettore



165 mm - 6 1/2 "	<b>tk 14110-16</b>
180 mm - 7 "	<b>tk 14110-18</b>

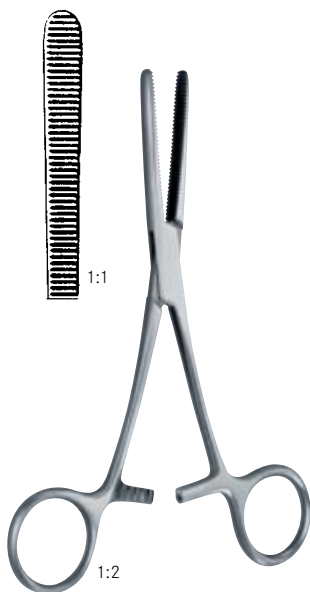

KLINIKUM-  
BERLIN

145 mm - 5 3/4 "	<b>tk 14120-14</b>	<b>tk 14114-14</b>
------------------	--------------------	--------------------

mit extra langer Sperre  
*with extra long ratchet*  
avec crémaillère extra longue  
*con cremallera extra larga*  
con cremagliera extra lunga



Schlauchklemmen  
*Tubing clamps*

Presse-tubes  
*Pinzas para tubos*  
 Pinze serratubi



**GUNNAR**

185 mm - 7 1/4"    **tk 14160-18**



**ROSS**

130 mm - 5"    **tk 24847-14**

Wundhaken | Ecarteurs  
 Retractors | Separadores  
 Divaricatori



1:2

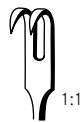

1:1



1:1



1:1

160 mm - 6 1/4"	<b>tk 17021-16</b>	<b>tk 17022-16</b>	<b>tk 17024-16</b>
-----------------	--------------------	--------------------	--------------------

flexibel, scharf  
*flexible, sharp*  
 flexible, pointu  
*flexible, agudo*  
 flessibile, acuto

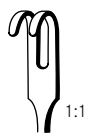

1:1



1:1



1:1

160 mm - 6 1/4"	<b>tk 17031-16</b>	<b>tk 17032-16</b>	<b>tk 17034-16</b>
-----------------	--------------------	--------------------	--------------------

flexibel, stumpf  
*flexible, blunt*  
 flexible, mousse  
*flexible, romo*  
 flessibile, smusso

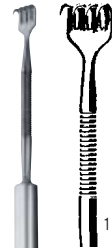

1:1

1:2

**KNAPP  
 (ROLLET)**

160 mm - 6 1/4"

**tk 17025-16**

flexibel, scharf  
*flexible, sharp*  
 flexible, pointu  
*flexible, agudo*  
 flessibile, acuto



1:2

1:1



1:1



1:1



1:1

**DESMARRES**

	x = 8 mm	x = 10 mm	x = 12 mm
160 mm - 6 1/4"	<b>tk 17038-08</b>	<b>tk 17038-10</b>	<b>tk 17038-12</b>



1:1



1:1

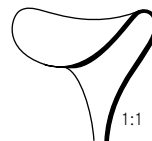

1:1

	x = 14 mm	x = 16 mm	x = 18 mm
160 mm - 6 1/4"	<b>tk 17038-14</b>	<b>tk 17038-16</b>	<b>tk 17038-18</b>

Wundhaken | Ecarteurs  
 Retractors | Separadores  
 Divaricatori



**CUSHING**



	x = 8 mm	x = 10 mm	x = 12 mm	x = 14 mm	x = 16 mm	x = 18 mm
200 mm - 8"	<b>tk 17200-08</b>	<b>tk 17200-10</b>	<b>tk 17200-12</b>	<b>tk 17200-14</b>	<b>tk 17200-16</b>	<b>tk 17200-18</b>
240 mm - 9½"	<b>tk 17201-08</b>	<b>tk 17201-10</b>	<b>tk 17201-12</b>	<b>tk 17201-14</b>	<b>tk 17201-16</b>	<b>tk 17201-18</b>



**GIL-VERNET**

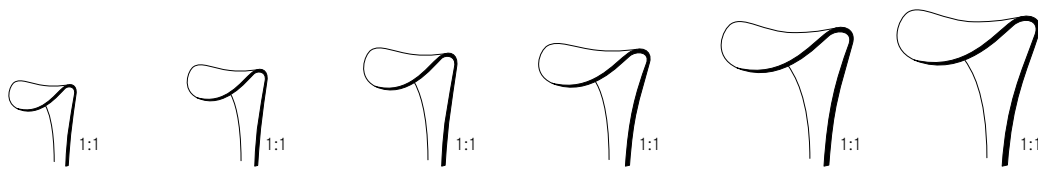





	x = 8 mm	x = 11 mm	x = 15 mm	x = 17 mm	x = 20 mm	x = 23 mm
240 mm - 9½"	<b>tk 17203-08</b>	<b>tk 17203-11</b>	<b>tk 17203-15</b>	<b>tk 17203-17</b>	<b>tk 17203-20</b>	<b>tk 17203-23</b>

**biegsam**  
*malleable*  
 malléable  
*maleable*  
 malleabile

Wundhaken | Ecarteurs  
 Retractors | Separadores  
 Divaricatori









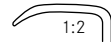

**LANGENBECK**

	 1:1	 1:1	 1:1
	Fig. 1	Fig. 2	Fig. 3
	30 mm x 11 mm	30 mm x 14 mm	30 mm x 16 mm
210 mm - 8 1/4"	<b>tk 17112-01</b>	<b>tk 17112-02</b>	<b>tk 17112-03</b>
	 1:1	 1:1	
	Fig. 4	Fig. 5	
	40 mm x 11 mm	50 mm x 11 mm	
210 mm - 8 1/4"	<b>tk 17112-04</b>	<b>tk 17112-05</b>	



**KOCHER-LANGENBECK (OBWEGESER)**

	 1:2	 1:2	 1:2	 1:2
	25 mm x 7 mm	35 mm x 8 mm	35 mm x 11 mm	35 mm x 15 mm
215 mm - 8 1/2"	<b>tk 17114-01</b>	<b>tk 17114-02</b>	<b>tk 17114-03</b>	<b>tk 17114-04</b>
	 1:2	 1:2	 1:2	
	42 mm x 10 mm	55 mm x 12 mm	70 mm x 14 mm	
215 mm - 8 1/2"	<b>tk 17114-05</b>	<b>tk 17114-06</b>	<b>tk 17114-07</b>	
	 1:2	 1:2		
	80 mm x 12 mm	80 mm x 16 mm		
215 mm - 8 1/2"	<b>tk 17114-08</b>	<b>tk 17114-09</b>		

Wundhaken  
Retractors

Ecarteurs  
Separadores  
Divaricatori



**OBWEGESER**

	42 mm x 13 mm	60 mm x 12 mm
220 mm - 8 <sup>3</sup> / <sub>4</sub> "	<b>tk 52715-01</b>	<b>tk 52715-02</b>

	80 mm x 16 mm
220 mm - 8 <sup>3</sup> / <sub>4</sub> "	<b>tk 52715-03</b>

**SAUERBRUCH**

	45 mm x 15 mm	75 mm x 20 mm
225 mm - 8 <sup>3</sup> / <sub>4</sub> "	<b>tk 17120-22</b>	<b>tk 17121-22</b>

	60 mm x 23 mm
220 mm - 8 <sup>3</sup> / <sub>4</sub> "	<b>tk 17122-22</b>

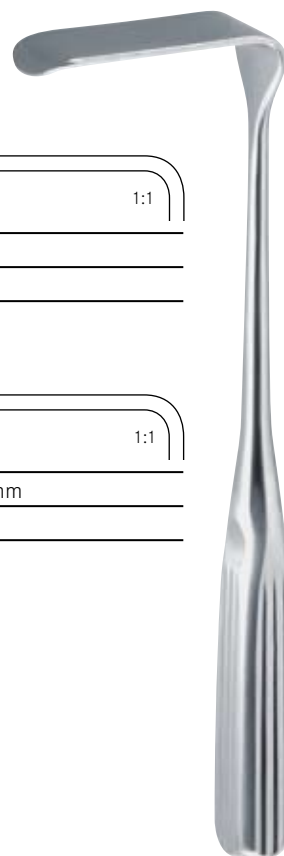

Wundhaken  
Retractors

Ecarteurs  
Separadores  
Divaricatori



LAHEY

190 mm - 7½"

28 mm x 6 mm

**tk 17118-19**



KOCHER

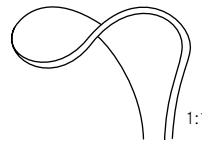
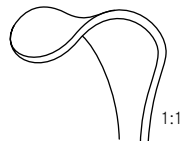

19 mm x 12 mm

21 mm x 14 mm

190 mm - 7½"

**tk 17125-01**

**tk 17125-02**



KOCHER

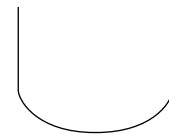
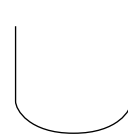

40 mm x 10 mm

40 mm x 15 mm

40 mm x 20 mm

220 mm - 8¾"

**tk 17127-01**

**tk 17127-02**

**tk 17127-03**

<p><b>Wundhaken</b> <i>Retractors</i></p>	<p>Ecarteurs <i>Separadores</i> Divaricatori</p>
---	--



**MORRIS**

	70 mm x 40 mm	70 mm x 50 mm	70 mm x 65 mm
245 mm - 9 <sup>3</sup> / <sub>4</sub> "	<b>tk 17900-40</b>	<b>tk 17900-50</b>	<b>tk 17900-65</b>

Wundhaken  
Retractors

Ecarteurs  
Separadores  
Divaricatori

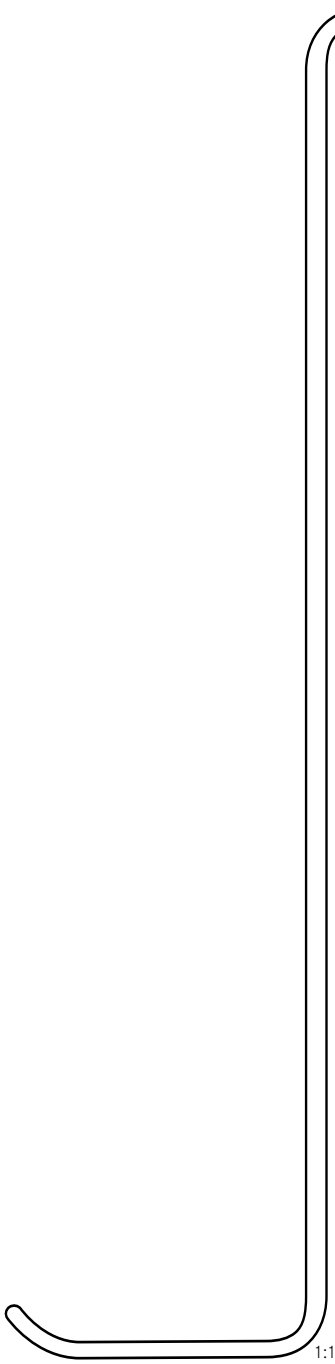

**CZERNY**

155 mm - 6 3/4"

**tk 17255-01**



**BLALOCK**

240 mm - 9 1/2"

**tk 16940-01**



**BROMPTON**

26 mm x 15 mm

190 mm - 7 1/2"

**tk 17195-01**



**BROCKS**

28 mm x 13 mm

190 mm - 7 1/2"

**tk 17119-01**



**Wundhaken**  
**Retractors**

Ecarteurs  
Separadores  
Divaricatori



**SIMON**

	115 mm x 22 mm	115 mm x 27 mm
280 mm - 11"	<b>tk 17160-28</b>	<b>tk 17161-28</b>

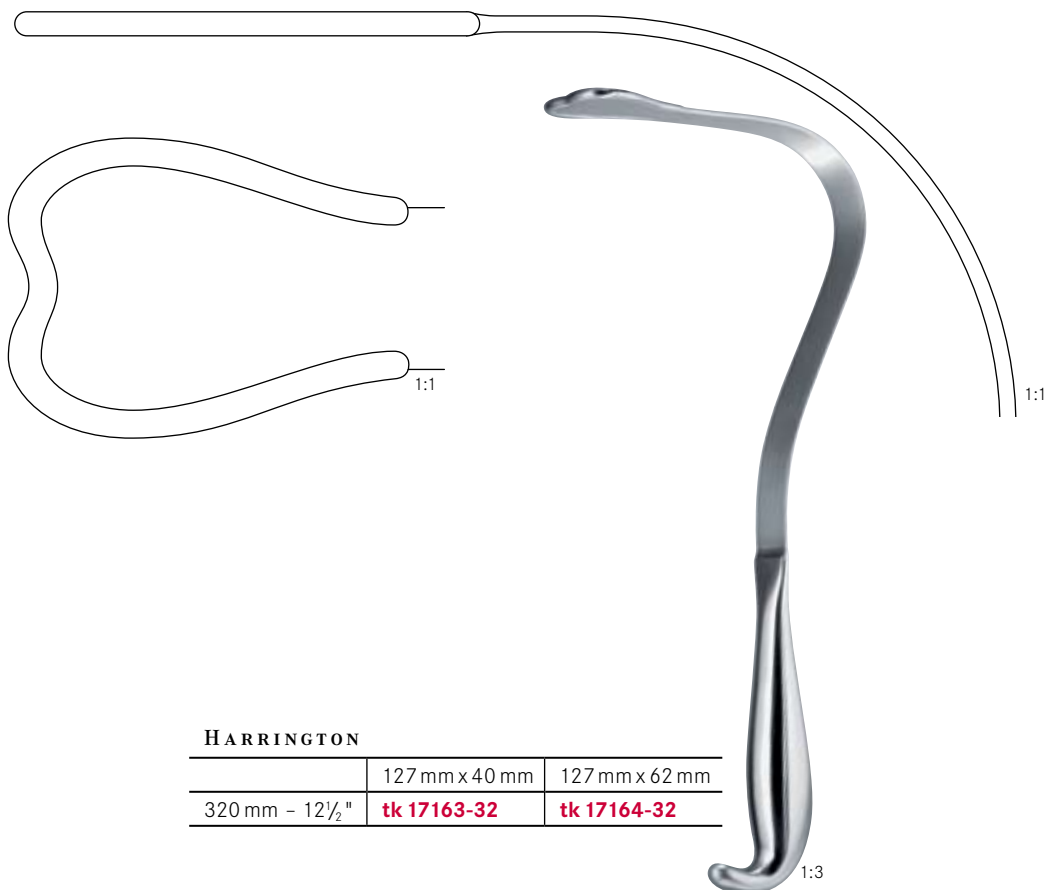

**HARRINGTON**

	127 mm x 40 mm	127 mm x 62 mm
320 mm - 12½"	<b>tk 17163-32</b>	<b>tk 17164-32</b>

Wundhaken  
Retractors

Ecarteurs  
Separadores  
Divaricatori



1:2

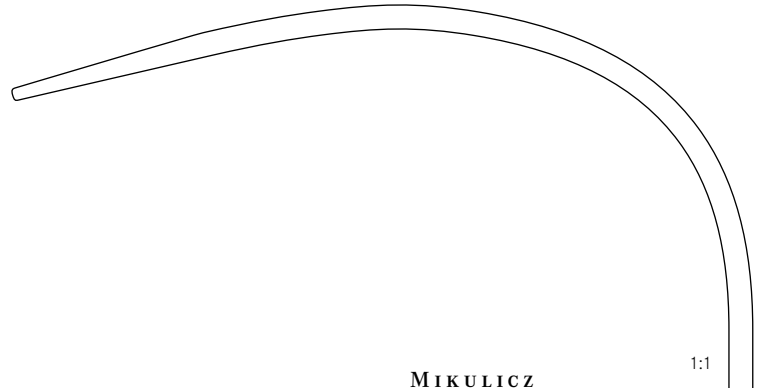

1:1

MIKULICZ

	95 mm x 35 mm
260 mm - 10 1/4"	<b>tk 17170-26</b>

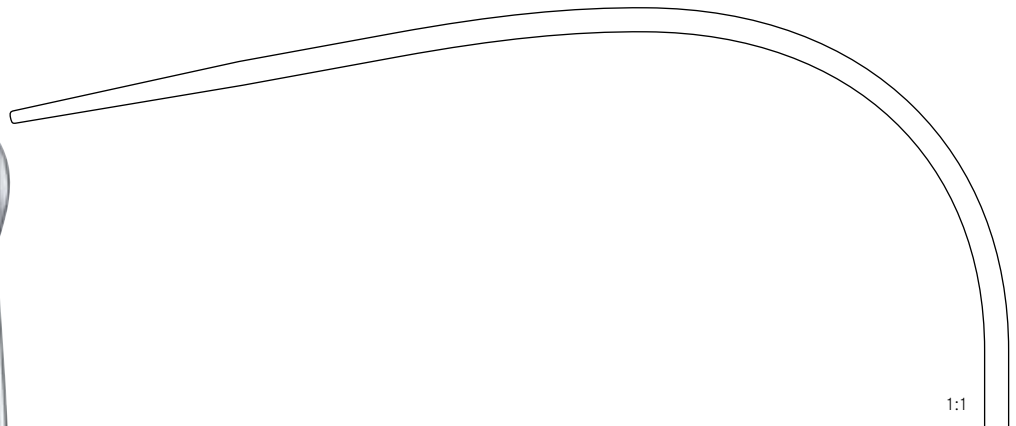

1:1

120 mm x 50 mm

**tk 17171-26**

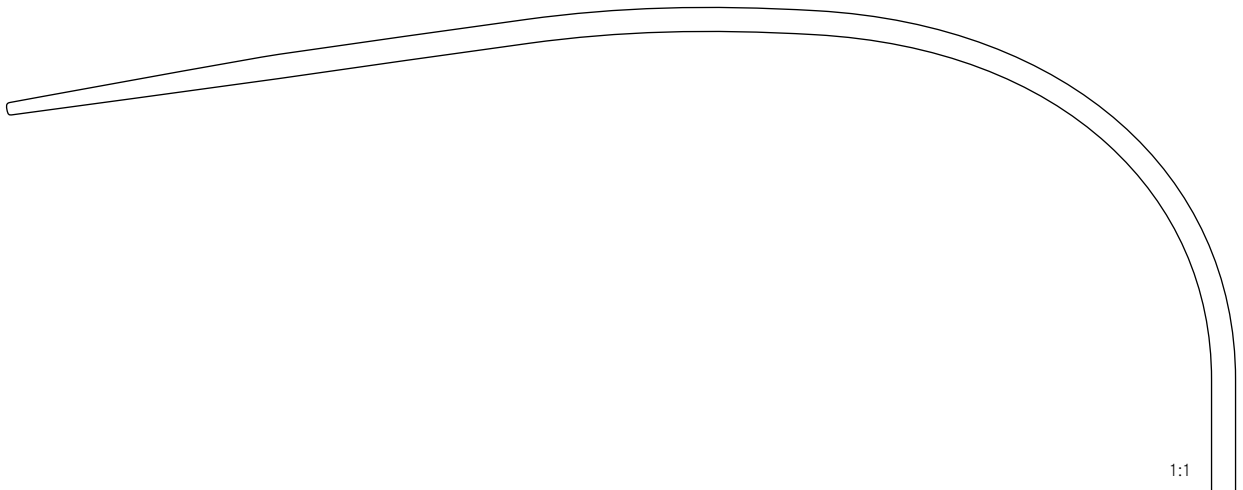

1:1

150 mm x 50 mm

**tk 17172-26**

Wundhaken  
Retractors

Ecarteurs  
Separadores  
Divaricatori



**MIKULICZ**

260 mm - 10 1/4"

90 mm x 50 mm

**tk 17174-26**

1:2

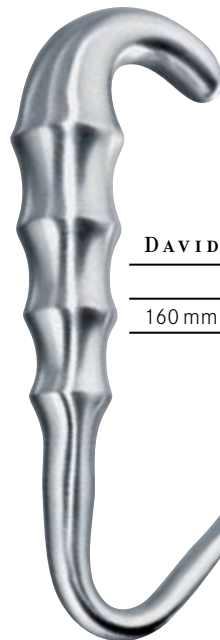

**DAVIDSON**

	a = 75 mm - b = 50 mm	a = 75 mm - b = 90 mm
--	-----------------------	-----------------------

160 mm - 6 1/4"	<b>tk 17176-01</b>	<b>tk 17176-02</b>
-----------------	--------------------	--------------------

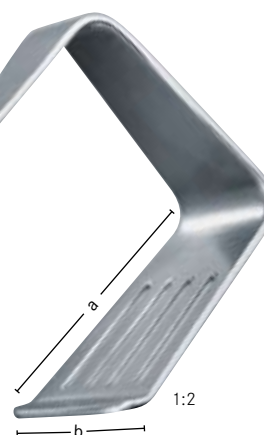

1:2

Wundhaken  
Retractors

Ecarteurs  
Separadores  
Divaricatori

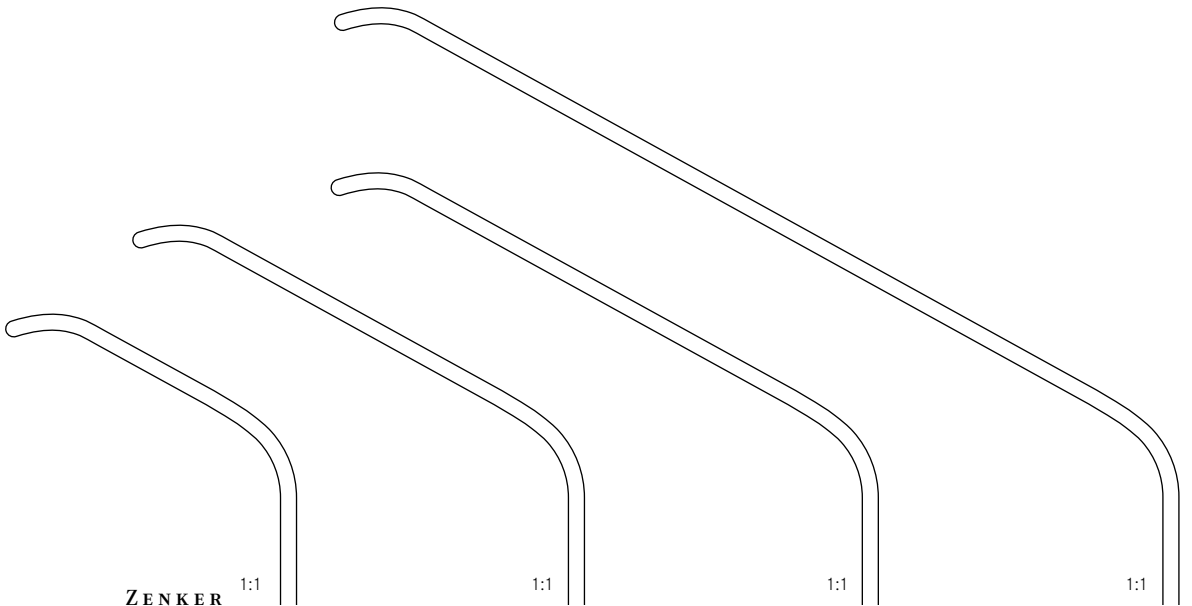

ZENKER 1:1	1:1	1:1	1:1
250 mm - 9¾"	260 mm - 10¼"	275 mm - 10¾"	290 mm - 11½"
35 mm x 8 mm	60 mm x 12 mm	75 mm x 12 mm	120 mm x 12 mm
<b>tk 17179-01</b>	<b>tk 17179-02</b>	<b>tk 17179-03</b>	<b>tk 17179-04</b>

Wundhaken  
Retractors

Ecarteurs  
Separadores  
Divaricatori

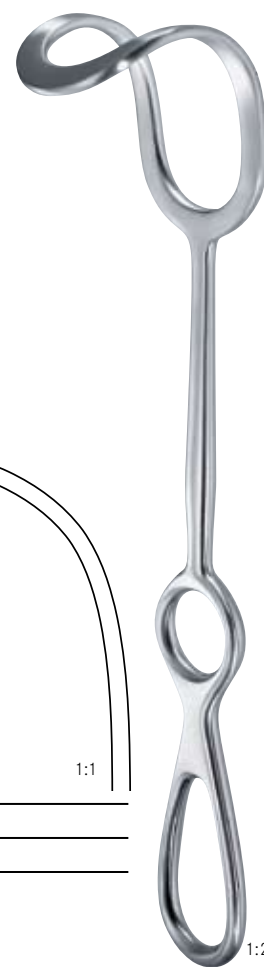
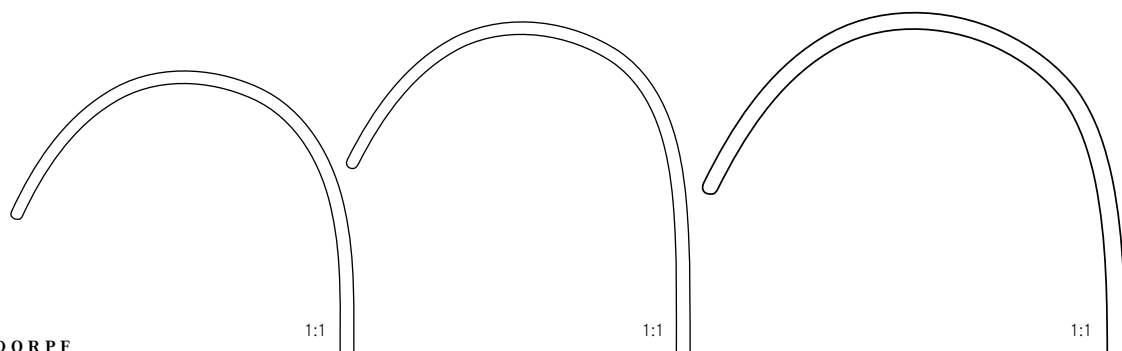

MIDDELDORPF

1:1

1:1

1:1

	45 mm x 45 mm	45 mm x 50 mm	55 mm x 70 mm
255 mm - 10"	<b>tk 17181-01</b>	<b>tk 17181-02</b>	<b>tk 17181-03</b>

Wundhaken  
Retractors

Ecarteurs  
Separadores  
Divaricatori



ST. MARKS

290 mm - 11½"	325 mm - 12¾"	330 mm - 13"
130 mm x 60 mm	180 mm x 60 mm	180 mm x 60 mm
<b>tk 17214-01</b>	<b>tk 17214-02</b>	<b>tk 17214-03</b>

**Wundhaken**  
**Retractors**

Ecarteurs  
Separadores  
Divaricatori



<b>COOLEY</b>			
	a = 48 mm - b = 45 mm	a = 48 mm - b = 45 mm	a = 48 mm - b = 30 mm
240 mm - 9½"	<b>tk 17180-01</b>	<b>tk 17180-02</b>	-
290 mm - 11½"	-	-	<b>tk 17180-03</b>
	rechts <i>right</i> droite <i>derecha</i> destra	rechts, gerieft <i>right, serrated</i> droite, strié <i>derecha, estriada</i> destra, zigrinato	links <i>left</i> gauche <i>izquierda</i> sinistra

Wundhaken  
Retractors

Ecarteurs  
Separadores  
Divaricatori

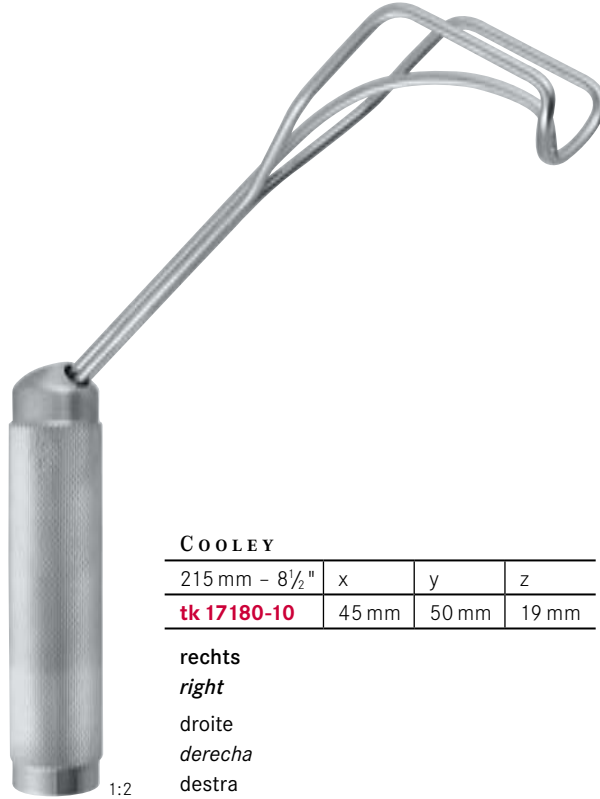
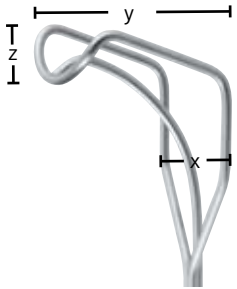

**COOLEY**

215 mm - 8 1/2"	x	y	z
<b>tk 17180-10</b>	45 mm	50 mm	19 mm

rechts  
right  
droite  
derecha  
destra

1:2



1:2

	x	y	z
<b>tk 17180-12</b>	35 mm	38 mm	15 mm



1:2

	x	y	z
<b>tk 17180-14</b>	45 mm	40 mm	22 mm



1:2

	x	y	z
<b>tk 17180-16</b>	18 mm	30 mm	8 mm



Wundhaken  
Retractors

Ecarteurs  
Separadores  
Divaricatori

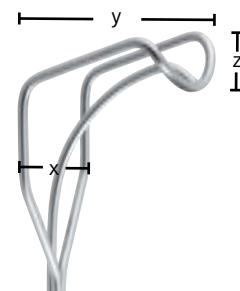
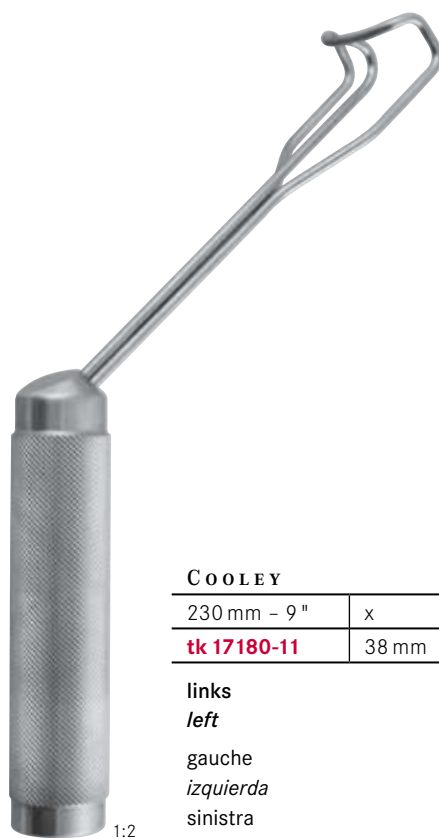

**COOLEY**

230 mm - 9"	x	y	z
<b>tk 17180-11</b>	38 mm	19 mm	14 mm

links  
left  
gauche  
izquierda  
sinistra



	x	y	z
<b>tk 17180-13</b>	45 mm	20 mm	20 mm



	x	y	z
<b>tk 17180-15</b>	17 mm	19 mm	9 mm

Wundhaken  
*Retractors*

Ecarteurs  
*Separadores*  
Divaricatori



**BOROWSKI**

1:2

	270 mm - 10 <sup>3</sup> / <sub>4</sub> "
x = 17 mm - y = 21 mm	<b>tk 17186-01</b>
x = 16 mm - y = 23 mm	<b>tk 17186-02</b>
x = 20 mm - y = 25 mm	<b>tk 17186-03</b>
x = 24 mm - y = 27 mm	<b>tk 17186-04</b>
x = 28 mm - y = 20 mm	<b>tk 17186-05</b>
x = 28 mm - y = 29 mm	<b>tk 17186-06</b>

**biegsam**  
**malleable**  
malléable  
**maleable**  
maleabile

**Wundsperrer**  
**Self-retaining retractors**

Ecarteurs autostatiques  
Separadores autoestáticos  
Divaricatori autostatici

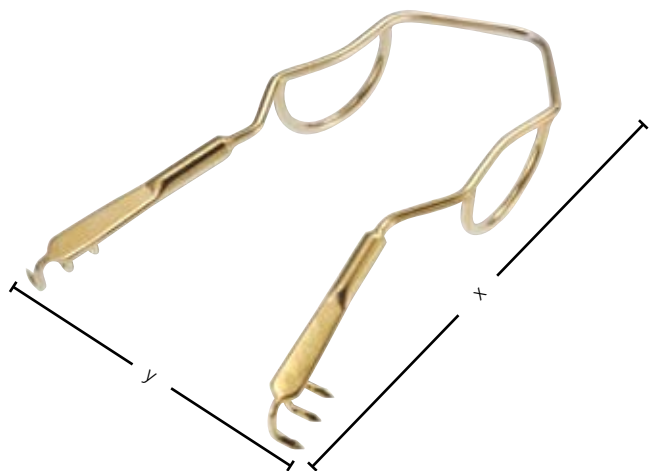

x	y
Länge <i>Length</i>	max. Öffnung <i>max. opening</i>
Longueur <i>Longitud</i>	Ouverture max. <i>Apertura max.</i>
Lunghezza	Apertura mass.

Mini	Small	Medium	Large
x = 29.0 mm	x = 34.0mm	x = 42.0 mm	x = 47.0 mm
y = 27.0 mm	y = 30.0 mm	y = 36.0 mm	y = 39.0 mm
<b>tk 17396-01</b>	<b>tk 17396-02</b>	<b>tk 17396-03</b>	<b>tk 17396-04</b>

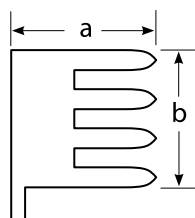

**WEITLANER-LOKTITE**

105 mm - 4 1/4"	a = 17 mm - b = 13 mm	<b>tk 17400-10</b>	<b>tk 17400-20</b>	<b>tk 17401-10</b>			
130 mm - 5"	a = 17 mm - b = 17 mm				<b>tk 17402-13</b>	<b>tk 17402-23</b>	<b>tk 17403-13</b>
165 mm - 6 1/2"	a = 17 mm - b = 17 mm				<b>tk 17402-16</b>	<b>tk 17402-26</b>	<b>tk 17403-16</b>
200 mm - 8"	a = 20 mm - b = 19 mm				<b>tk 17404-20</b>	<b>tk 17404-30</b>	<b>tk 17405-20</b>
260 mm - 10 1/4"	a = 26 mm - b = 21 mm				<b>tk 17404-26</b>	<b>tk 17404-36</b>	<b>tk 17405-26</b>

2 x 3	2 x 3	2 x 3	3 x 4	3 x 4	3 x 4
<b>scharf</b>	<b>halbscharf</b>	<b>stumpf</b>	<b>scharf</b>	<b>halbscharf</b>	<b>stumpf</b>
<b>sharp</b>	<b>semi sharp</b>	<b>blunt</b>	<b>sharp</b>	<b>semi sharp</b>	<b>blunt</b>
pointu	semi pointu	mousse	pointu	semi pointu	mousse
agudo	semi agudo	romo	agudo	semi agudo	romo
acuto	semi acuto	smusso	acuto	semi acuto	smusso

## Nadelhalter mit Hartmetalleinsätzen im Maulbereich Needle holders with tungsten-carbide inserts in the jaws

Porte-aiguilles avec des inserts de carbure de tungstène dans les mors  
Porte-agujas con insertos de carburo tungsteno en las bocas  
Port'aghi con inserti in carburo di tungsteno



Alle Nadelhalter mit „tucar“ Hartmetalleinsätzen bieten einen sicheren, festen Halt der Nadel und verhindern deren Verdrehen. Zur Kennzeichnung sind alle Hartmetall-Nadelhalter an den Ringgriffen bzw. den Branchen vergoldet.

All the needle holders with „tucar“ tungsten-carbide inserts offer a safe and secure grip of the needle and prevent the twisting of the same. Needle holders with tungsten-carbide inserts are identified by gold-plated rings or handles.

Tous les porte-aiguilles avec des inserts «tucar» de carbure de tungstène garantissent que les aiguilles sont tenues sûres et fortes et qu'elles ne peuvent pas se tordre. Les portes-aiguilles avec des inserts de tungstène de carbure peuvent être reconnus à leurs bagues ou manches dorées.

Todas las porta-agujas „tucar“ con los insertos de carburo tungsteno aseguran la sujeción firme y seguro de las agujas que evita la torsión de las cuales. Porta-agujas con insertos de carburo de tungsteno se reconocen por los anillos o mangos dorados.

Tutti i portaaghi con inserti in carburo di tungsteno „tucar“ (tungsten-carbide) assicurano una presa dell'ago sicura e forte, che previene la torsione dall'ago stesso. I port'aghi con inserto in carburo di tungsteno sono riconoscibili per la doratura del manico o degli anelli.

0.5 mm

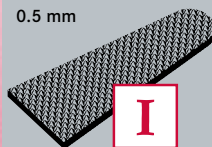

**I**

Normal für Nadeln und Nahtmaterial bis Stärke 4-0  
Regular for use with needles and sutures up to size 4-0

Normale pour aiguilles et matériel à suture jusqu'à l'épaisseur de 4-0  
Normal para agujas y material de suturar hasta el espesor de 4-0  
Normale per aghi e materiale per sutura fino ad uno spessore di 4-0

0.4 mm

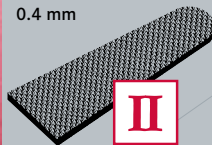

**II**

Fein für feine Nadeln und Nahtmaterial Stärke 5-0 + 6-0  
Fine for delicate needles and sutures sizes 5-0 + 6-0

Fino pour aiguilles fines et matériel à suture à l'épaisseur 5-0 + 6-0  
Fine para agujas finas y material de suturar espesores 5-0 + 6-0  
Fine per aghi fini e materiale per sutura con spessore 5-0 + 6-0

0.3 mm

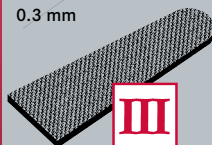

**III**

Extrafein für Mikro-Nadeln und Nahtmaterial Stärke 7-0 bis 10-0  
Extrafine for use with micro-needles and sutures size 7-0 and 10-0

Extrafino pour micro-aiguilles et matériel à suture à l'épaisseur 7-0 à 10-0  
Extrafine para micro-agujas y material de suturas espesor 7-0 y 10-0  
Extrafine per micro-aghi e materiale per sutura 7-0 e 10-0

Glatt für feine Nadeln und Nahtmaterial Stärke 7-0 bis 12-0  
Smooth for delicate needles and sutures sizes 7-0 and 12-0

Liso pour aiguilles fines et matériel à suture à l'épaisseur 7-0 à 12-0  
Lisse para agujas finas y material de suturas espesor 7-0 y 12-0  
Liscia per aghi fini e materiale per sutura 7-0 e 12-0

**IV**

**Nadelhalter**  
**Needle holders**

Porte-aiguilles  
Porta-agujas  
Porta aghi



**I**  
**HEGAR-BAUMGARTNER**  
140 mm - 5½"  
**tk 20503-14 tucar**



**II**  
**BABY-CRILE-WOOD**  
150 mm - 6"  
**tk 20504-15 tucar**

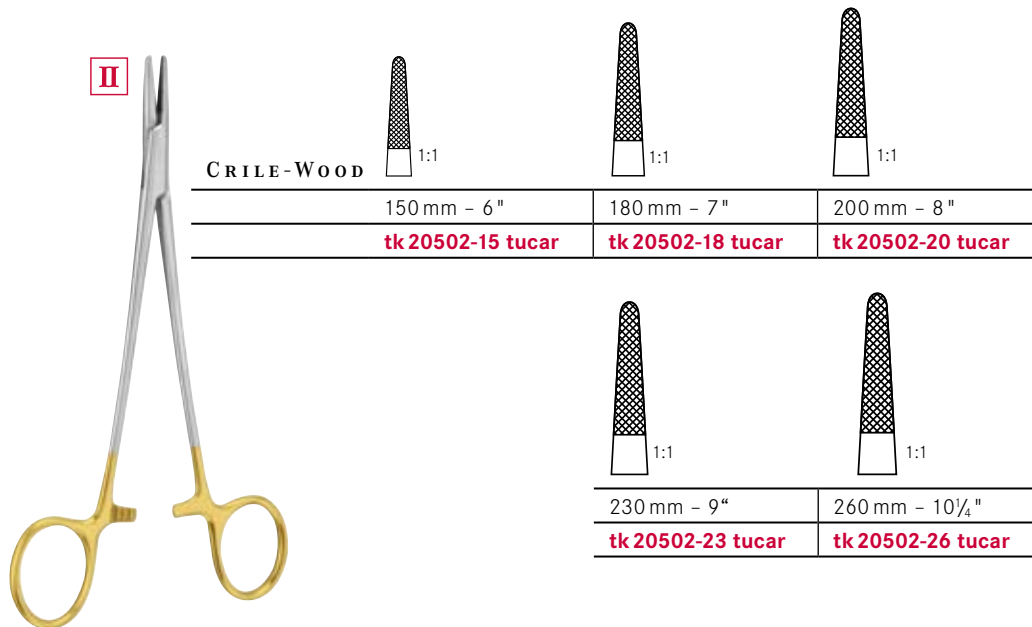

Nadelhalter  
Needle holders

Porte-aiguilles  
Porta-agujas  
Porta aghi

**TUCAR** **TK**



**DERF (WRIGHT)**

120 mm - 4¾"

**tk 20508-12 tucar**



**WEBSTER**

130 mm - 5"

**tk 20509-13 tucar**

glatt  
*smooth*

lisse  
*lisa*  
liscio

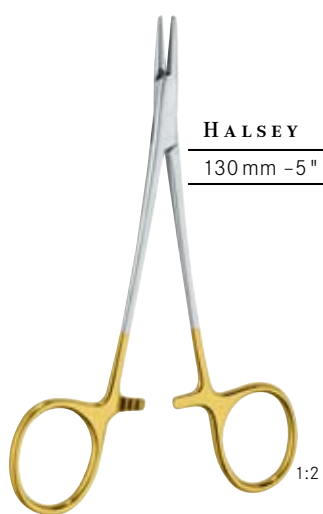

**HALSEY**

130 mm - 5"



glatt  
*smooth*  
lisse  
*lisa*  
liscio



gerieft  
*serrated*  
strié  
*estriada*  
zigrinato



**I**

**KILNER**

135 mm - 5¼"

**tk20533-13 tucar**

**Nadelhalter**  
**Needle holders**

Porte-aiguilles  
Porta-agujas  
Porta aghi



**I**

**MAYO-HEGAR**

140 mm - 5½"	160 mm - 6¼"	180 mm - 7"	200 mm - 8"	240 mm - 9½"	260 mm - 10¼"	300 mm - 12"
<b>tk 20512-14</b>	<b>tk 20512-16</b>	<b>tk 20512-18</b>	<b>tk 20512-20</b>	<b>tk 20512-24</b>	<b>tk 20512-26</b>	<b>tk 20512-30</b>

**III**

**NEIVERT (MASING)**

130 mm - 5"

**tk 20517-13 tucar**

ein Ring abgewinkelt  
*one ring angled*

une bague coudée  
*un anillo acodado*  
un anello angolato

**III**

**CONVERSE**

130 mm - 5"

**tk 20518-13 tucar**

**II**

**MATHIEU-OLSEN**

140 mm - 5½"

**tk 20516-14 tucar**

170 mm - 6¾"

**tk 20516-17 tucar**

200 mm - 8"

**tk 20516-20 tucar**

Nadelhalter  
Needle holders

Porte-aiguilles  
Porta-agujas  
Porta aghi

**TUCAR**TK

**II**



**STRATTE**

230 mm - 9"

**tk 20507-23 tucar**

**I**



**HEANEY**

160 mm - 6¼"

**tk 20515-16 tucar**

180 mm - 7"

**tk 20515-18 tucar**

200 mm - 8"

**tk 20515-20 tucar**

**I**



**BOZEMANN  
(WERTHEIM)**



200 mm - 8"

**tk 20530-20 tucar**



240 mm - 9½"

**tk 20530-24 tucar**



260 mm - 10¼"

**tk 20530-26 tucar**



300 mm - 12"

**tk 20530-30 tucar**



**Nadelhalter** | Porte-aiguilles  
**Needle holders** | Porta-agujas  
 Porta aghi



**MASSON**

270 mm - 10<sup>3</sup>/<sub>4</sub>"

**tk 20505-27 tucar**



**FINOCHIETTO**

270 mm - 10<sup>3</sup>/<sub>4</sub>"

**tk 20506-27 tucar**



**WANGENSTEEN**

270 mm - 10<sup>3</sup>/<sub>4</sub>"

**tk 20526-27 tucar**



Nadelhalter  
Needle holders

Porte-aiguilles  
Porta-agujas  
Porta aghi

TUCAR<sup>TK</sup>

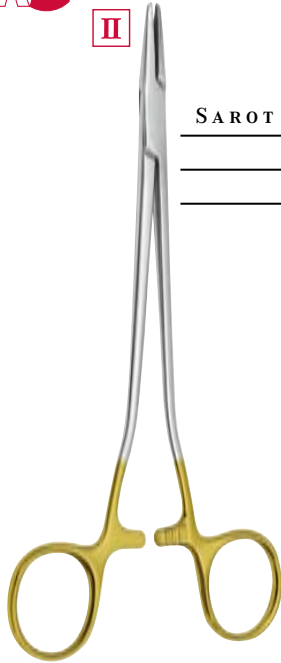



II

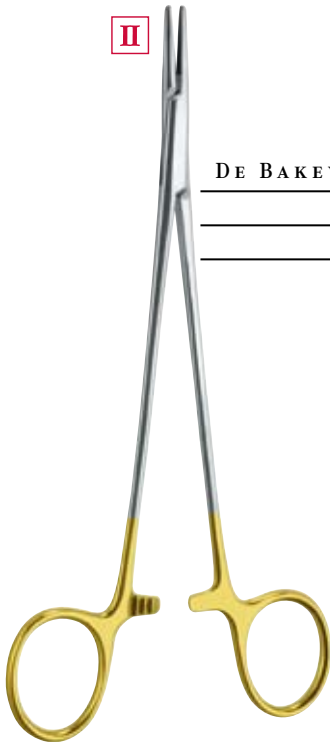

SAROT	 1:1	 1:1	 1:1
	180 mm - 7"	200 mm - 8"	260 mm - 10¼"
	<b>tk 20524-18 tucar</b>	<b>tk 20524-20 tucar</b>	<b>tk 20524-26 tucar</b>



II

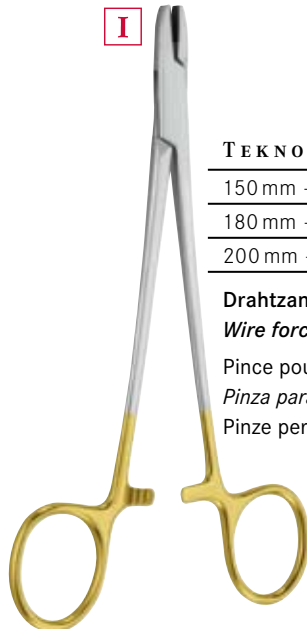

DE BAKEY	 1:1	 1:1	 1:1	 1:1
	180 mm - 7"	200 mm - 8"	230 mm - 9"	260 mm - 10¼"
	<b>tk 20522-18 tucar</b>	<b>tk 20522-20 tucar</b>	<b>tk 20522-23 tucar</b>	<b>tk 20522-26 tucar</b>

I



TEKNO-TWIST		
150 mm - 6"	<b>tk 20800-15 tucar</b>	<b>tk 20801-15 tucar</b>
180 mm - 7"	<b>tk 20800-18 tucar</b>	<b>tk 20801-18 tucar</b>
200 mm - 8"	<b>tk 20800-20 tucar</b>	<b>tk 20801-20 tucar</b>

Drahtzange

Wire forceps

Pince pour fils d'acier

Pinza para hilos

Pinze per fili d'acciaio

**Nadelhalter** | Porte-aiguilles  
**Needle holders** | Porta-agujas  
 Porta aghi



**III**

**VASCULAR**

140 mm - 5½"	180 mm - 7"	200 mm - 8"	230 mm - 9"
<b>tk 20525-14 tucar</b>	<b>tk 20525-18 tucar</b>	<b>tk 20525-20 tucar</b>	<b>tk 20525-23 tucar</b>

**II**

**RYDER**

130 mm - 5"	<b>tk 20540-13 tucar</b>
150 mm - 6"	<b>tk 20540-15 tucar</b>
180 mm - 7"	<b>tk 20540-18 tucar</b>
200 mm - 8"	<b>tk 20540-20 tucar</b>
230 mm - 9"	<b>tk 20540-23 tucar</b>
260 mm - 10¼"	<b>tk 20540-26 tucar</b>

**III**

**MINI-RYDER**

<b>tk 20542-13 tucar</b>
<b>tk 20542-15 tucar</b>
<b>tk 20542-18 tucar</b>
<b>tk 20542-20 tucar</b>
<b>tk 20542-23 tucar</b>
<b>tk 20542-26 tucar</b>

**III**

**DIETRICH**

160 mm - 6¼"	<b>tk 20560-16 tucar</b>
180 mm - 7"	<b>tk 20560-18 tucar</b>
200 mm - 8"	<b>tk 20560-20 tucar</b>
230 mm - 9"	<b>tk 20560-23 tucar</b>
250 mm - 9¾"	<b>tk 20560-25 tucar</b>

Nadelhalter  
Needle holders

Porte-aiguilles  
Porta-agujas  
Porta aghi

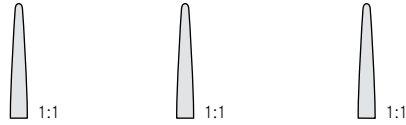

130 mm - 5"	150 mm - 5 $\frac{3}{4}$ "	170 mm - 6 $\frac{3}{4}$ "
<b>tk 20570-13</b>	<b>tk 20570-15</b>	<b>tk 20570-17</b>

mit Spezialbeschichtung im Maul  
*with special coated jaw*

mors avec couche special  
*boca con capa especial*  
morso con spalmatura speciale

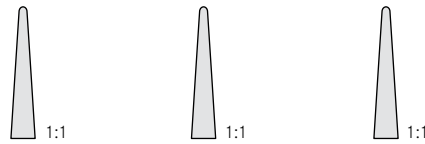

180 mm - 7"	200 mm - 8"	230 mm - 9"
<b>tk 20570-18</b>	<b>tk 20570-20</b>	<b>tk 20570-23</b>

mit Spezialbeschichtung im Maul  
*with special coated jaw*

mors avec couche special  
*boca con capa especial*  
morso con spalmatura speciale

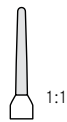

<b>RYDER</b>	
130 mm - 5"	<b>tk 20541-13</b>
150 mm - 6"	<b>tk 20541-15</b>
180 mm - 7"	<b>tk 20541-18</b>
200 mm - 8"	<b>tk 20541-20</b>
230 mm - 9"	<b>tk 20541-23</b>

mit Spezialbeschichtung im Maul  
*with special coated jaw*

mors avec couche special  
*boca con capa especial*  
morso con spalmatura speciale

**Nadelhalter** | Porte-aiguilles  
**Needle holders** | Porta-agujas  
 Porta aghi



**IV**



**CASTROVIEJO-  
JACOBSON**



140 mm - 5½"		<b>tk 20710-14 tucar</b>		<b>tk 20711-14 tucar</b>
150 mm - 6"	<b>tk 20704-15 tucar</b>	<b>tk 20710-15 tucar</b>	<b>tk 20705-15 tucar</b>	<b>tk 20711-15 tucar</b>
180 mm - 7"	<b>tk 20704-18 tucar</b>	<b>tk 20710-18 tucar</b>	<b>tk 20705-18 tucar</b>	<b>tk 20711-18 tucar</b>
210 mm - 8¼"	<b>tk 20704-21 tucar</b>	<b>tk 20710-21 tucar</b>	<b>tk 20705-21 tucar</b>	<b>tk 20711-21 tucar</b>

<b>glattes Maul</b> <i>smooth jaws</i>	<b>gerade, ohne Sperre</b> <i>straight, without ratchet</i>	<b>gerade, mit Sperre</b> <i>straight, with ratchet</i>	<b>gebogen, ohne Sperre</b> <i>curved, without ratchet</i>	<b>gebogen, mit Sperre</b> <i>curved, with ratchet</i>
<b>mors lisse</b> <i>boca lisa</i> <b>morso liscio</b>	<b>droit, sans crémaillère</b> <i>recta, sin cremallera</i> <b>retto, senza cremagliera</b>	<b>droit, avec crémaillère</b> <i>recta, con cremallera</i> <b>retto, con cremagliera</b>	<b>courbe, sans crémaillère</b> <i>curva, sin cremallera</i> <b>curvo, senza cremagliera</b>	<b>courbe, avec crémaillère</b> <i>curva, con cremallera</i> <b>curvo, con cremagliera</b>

**III**



**VASCULAR**



180 mm - 7"	<b>tk 20716-18 tucar</b>	<b>tk 20714-18 tucar</b>	<b>tk 20717-18 tucar</b>	<b>tk 20715-18 tucar</b>
-------------	--------------------------	--------------------------	--------------------------	--------------------------

<b>gerade, ohne Sperre</b> <i>straight, without ratchet</i>	<b>gerade, mit Sperre</b> <i>straight, with ratchet</i>	<b>gebogen, ohne Sperre</b> <i>curved, without ratchet</i>	<b>gebogen, mit Sperre</b> <i>curved, with ratchet</i>
<b>droit, sans crémaillère</b> <i>recta, sin cremallera</i> <b>retto, senza cremagliera</b>	<b>droit, avec crémaillère</b> <i>recta, con cremallera</i> <b>retto, con cremagliera</b>	<b>courbe, sans crémaillère</b> <i>curva, sin cremallera</i> <b>curvo, senza cremagliera</b>	<b>courbe, avec crémaillère</b> <i>curva, con cremallera</i> <b>curvo, con cremagliera</b>

1:2

**Gefäßstripper** | Tire-veines  
**Vein stripper** | Fleboextractores  
 Tiravene



	○ 1:1 2 mm Ø	○ 1:1 3 mm Ø	○ 1:1 4 mm Ø	○ 1:1 5 mm Ø	○ 1:1 6 mm Ø
500 mm - 20"	<b>tk 18147-02</b>	<b>tk 18147-03</b>	<b>tk 18147-04</b>	<b>tk 18147-06</b>	<b>tk 18147-07</b>

	○ 1:1 8.5 mm Ø	○ 1:1 10 mm Ø	○ 1:1 12 mm Ø	○ 1:1 14 mm Ø
500 mm - 20"	<b>tk 18147-08</b>	<b>tk 18147-10</b>	<b>tk 18147-12</b>	<b>tk 18147-14</b>



120 mm - 4¾" **tk 18147-30**

Griff für tk 18147-02 - tk 18147-14  
 Handle for tk 18147-02 - tk 18147-14  
 Manche pour tk 18147-02 - tk 18147-14  
 Mango para tk 18147-02 - tk 18147-14  
 Manico per tk 18147-02 - tk 18147-14

1:2



**RUMEL-BELMONT**

	3.2 mm Ø	6.4 mm Ø
325 mm - 12¾"	<b>tk 24845-32</b>	<b>tk 24845-64</b>

Tourniquet	für Kinder	für Erwachsene
<i>Tourniquet</i>	<i>for children</i>	<i>for adults</i>
Tourniquet	pour enfants	pour adultes
<i>Tourniquete</i>	<i>para niños</i>	<i>para adultos</i>
Tourniquet	per bambini	per adulti

**Krampfaderbesteck**  
**Varicose vein probe set**

Trousse à varices  
Juego para várices  
Astuccio per varici



1:2

**NABATOFF**

135 mm x 100 mm x 25 mm

**tk 18145-00**

**komplett**  
**complete**  
complet  
**completo**  
completo

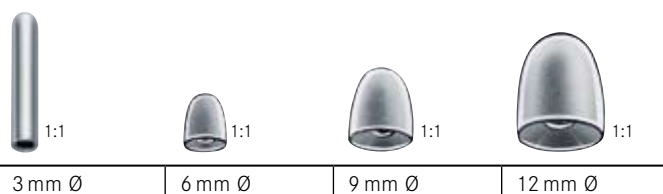
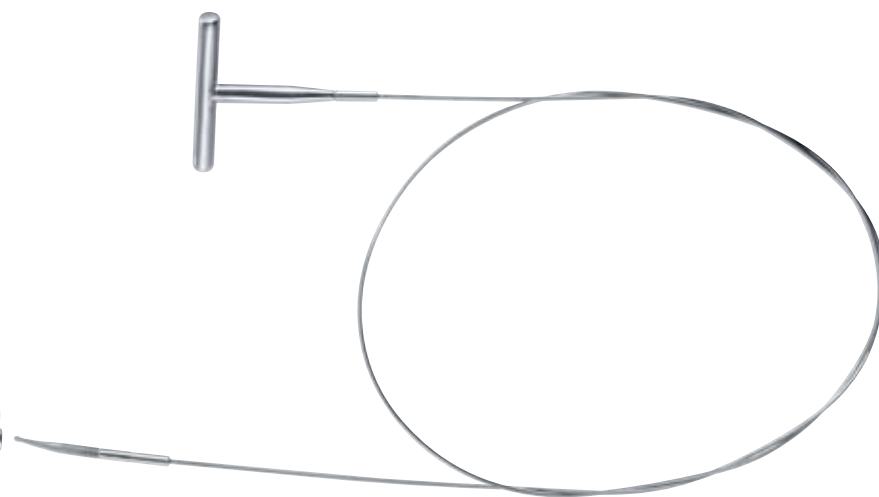

1:1

1:1

1:1

1:1

3 mm Ø

6 mm Ø

9 mm Ø

12 mm Ø

<b>tk 18145-95</b>	<b>tk 18145-80</b>	<b>tk 18145-90</b>	<b>tk 18145-02</b>
Metalletui <i>Metal case</i>	Griff <i>Handle</i>	Zugseil 900 mm <i>Cable 900 mm</i>	Sondenspitze, Kunststoff <i>Probe tip in plastic</i>
Boîte métal <i>Estuche</i>	Manche <i>Mango</i>	Corde à traction 900 mm <i>Cordón 900 mm</i>	Sonde en plastique <i>Extremidad de sonda, plastica</i>
Astuccio	Manico	Fune di trazione 900 mm	Punta di plastica



1:1

1:1

1:1

1:1

1:1

3 mm Ø

6 mm Ø

9 mm Ø

12 mm Ø

15 mm Ø

**tk 18145-03**

**tk 18145-06**

**tk 18145-09**

**tk 18145-12**

**tk 18145-15**

Sonde  
*Probe*  
Sonde  
*Sonda*  
Sonda

Olive  
*Olive*  
Olive  
*Oliva*  
Oliva

Dissektoren  
*Dissectors*

Dissecteurs  
*Disectores*  
Dissettori

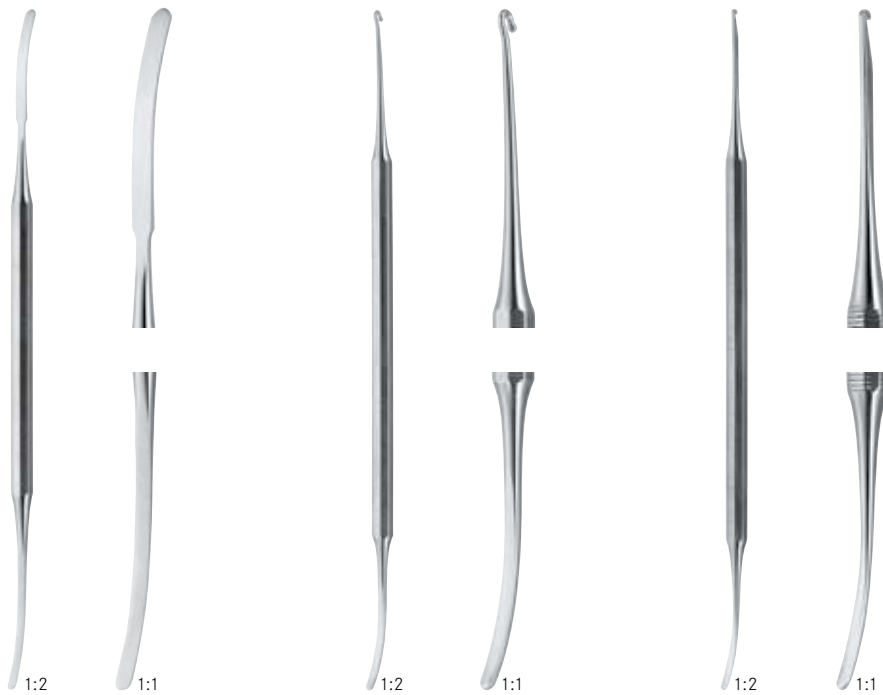

VARADY

180 mm – 7"

**tk 18148-01**

Phlebodissektor  
*Phlebodissektor*  
Dissecteur phlébite  
*Disector de flebo*  
Dissettore flebo

**tk 18148-02**

Phleboextraktor  
*Phleboextraktor*  
Extracteur phlébite  
*Extractor de flebo*  
Estrattore flebo

**tk 18148-03**

Phleboextraktor  
*Phleboextraktor*  
Extracteur phlébite  
*Extractor de flebo*  
Estrattore flebo



**Gefäß-Dilatatoren**  
**Vascular dilators**

Dilatateurs vasculaires  
*Dilatadores vasculares*  
Dilatatori vascolari



<b>DE BAKEY</b>		0.5 mm Ø	1.0 mm Ø	1.5 mm Ø	2.0 mm Ø	2.5 mm Ø	3.0 mm Ø
190 mm - 7½"	<b>tk 24840-05</b>	<b>tk 24840-10</b>	<b>tk 24840-15</b>	<b>tk 24840-20</b>	<b>tk 24840-25</b>	<b>tk 24840-30</b>	
350 mm - 13¾"	<b>tk 24841-05</b>	<b>tk 24841-10</b>	<b>tk 24841-15</b>	<b>tk 24841-20</b>	<b>tk 24841-25</b>	<b>tk 24841-30</b>	

<b>biegsam malleable malléable maleable flessibile</b>		3.5 mm Ø	4.0 mm Ø	4.5 mm Ø	5.0 mm Ø	7.0 mm Ø	9.0 mm Ø
190 mm - 7½"	<b>tk 24840-35</b>	<b>tk 24840-40</b>	<b>tk 24840-45</b>	<b>tk 24840-50</b>	<b>tk 24840-70</b>	<b>tk 24840-90</b>	
350 mm - 13¾"	<b>tk 24841-35</b>	<b>tk 24841-40</b>	<b>tk 24841-45</b>	<b>tk 24841-50</b>	<b>tk 24841-70</b>	<b>tk 24841-90</b>	



<b>COOLEY</b>		0.5 mm Ø	1.0 mm Ø	1.5 mm Ø	2.0 mm Ø
130 mm - 5"	<b>tk 24844-05</b>	<b>tk 24844-10</b>	<b>tk 24844-15</b>	<b>tk 24844-20</b>	

  

<b>biegsam malleable malléable maleable flessibile</b>		2.5 mm Ø	3.0 mm Ø	4.0 mm Ø	5.0 mm Ø
130 mm - 5"	<b>tk 24844-25</b>	<b>tk 24844-30</b>	<b>tk 24844-40</b>	<b>tk 24844-50</b>	

**Gefäß-Dilatatoren** | Dilatateurs vasculaires  
*Vascular dilators* | *Dilatadores vasculares*  
 Dilatatori vascolari

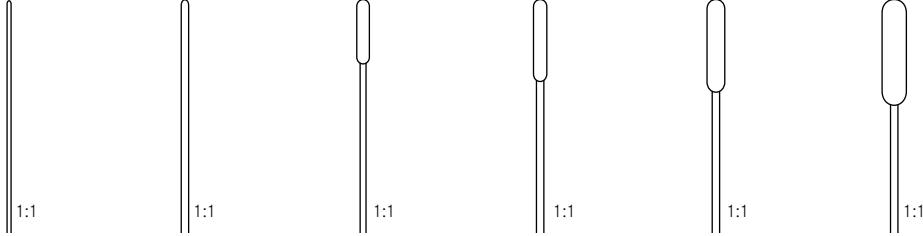

GARRETT						
	0.5 mm Ø	1.0 mm Ø	1.5 mm Ø	2.0 mm Ø	2.5 mm Ø	3.0 mm Ø
140 mm – 5½" "	<b>tk 24842-05</b>	<b>tk 24842-10</b>	<b>tk 24842-15</b>	<b>tk 24842-20</b>	<b>tk 24842-25</b>	<b>tk 24842-30</b>
190 mm – 7½" "	<b>tk 24843-05</b>	<b>tk 24843-10</b>	<b>tk 24843-15</b>	<b>tk 24843-20</b>	<b>tk 24843-25</b>	<b>tk 24843-30</b>
210 mm – 8¼" "	<b>tk 24847-05</b>	<b>tk 24847-10</b>	<b>tk 24847-15</b>	<b>tk 24847-20</b>	<b>tk 24847-25</b>	<b>tk 24847-30</b>
350 mm – 13¾" "	<b>tk 24848-05</b>	<b>tk 24848-10</b>	<b>tk 24848-15</b>	<b>tk 24848-20</b>	<b>tk 24848-25</b>	<b>tk 24848-30</b>

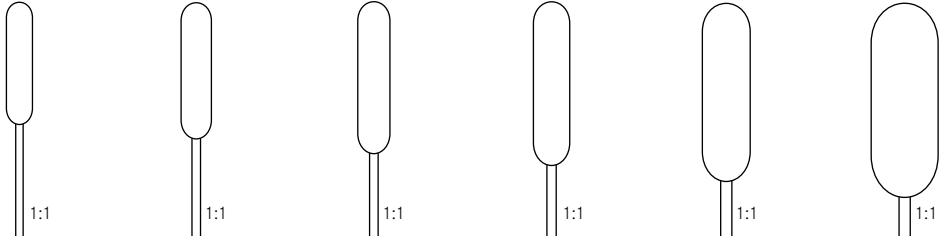
GARRETT						
	3.5 mm Ø	4.0 mm Ø	4.5 mm Ø	5.0 mm Ø	7.0 mm Ø	9.0 mm Ø
140 mm – 5½" "	<b>tk 24842-35</b>	<b>tk 24842-40</b>	<b>tk 24842-45</b>	<b>tk 24842-50</b>	-	-
190 mm – 7½" "	<b>tk 24843-35</b>	<b>tk 24843-40</b>	<b>tk 24843-45</b>	<b>tk 24843-50</b>	<b>tk 24843-70</b>	<b>tk 24843-90</b>
210 mm – 8¼" "	<b>tk 24847-35</b>	<b>tk 24847-40</b>	<b>tk 24847-45</b>	<b>tk 24847-50</b>	<b>tk 24847-70</b>	<b>tk 24847-90</b>
350 mm – 13¾" "	<b>tk 24848-35</b>	<b>tk 24848-40</b>	<b>tk 24848-45</b>	<b>tk 24848-50</b>	<b>tk 24848-70</b>	<b>tk 24848-90</b>

GARRETT		
140 mm – 5½" "	10	<b>tk 24842-00</b>
190 mm – 7½" "	12	<b>tk 24843-00</b>
210 mm – 8¼" "	12	<b>tk 24847-00</b>
350 mm – 13¾" "	12	<b>tk 24848-00</b>

Stück per Satz  
 Pieces per set  
 Pièces per jeu  
 Piezas para juego  
 Pezzi per serie

**Dilatatoren** | Dilatateurs  
*Dilators* | *Dilatadores*  
Dilatatori



**HEGAR**

1.0 mm Ø	<b>tk 34250-10</b>
1.5 mm Ø	<b>tk 34250-15</b>
2.0 mm Ø	<b>tk 34250-20</b>
2.5 mm Ø	<b>tk 34250-25</b>
3.0 mm Ø	<b>tk 34250-30</b>
3.5 mm Ø	<b>tk 34250-35</b>
4.0 mm Ø	<b>tk 34250-40</b>
4.5 mm Ø	<b>tk 34250-45</b>
5.0 mm Ø	<b>tk 34250-50</b>
5.5 mm Ø	<b>tk 34250-55</b>
6.0 mm Ø	<b>tk 34250-60</b>
6.5 mm Ø	<b>tk 34250-65</b>
7.0 mm Ø	<b>tk 34250-70</b>
7.5 mm Ø	<b>tk 34250-75</b>
8.0 mm Ø	<b>tk 34250-80</b>
8.5 mm Ø	<b>tk 34250-85</b>
9.0 mm Ø	<b>tk 34250-90</b>
9.5 mm Ø	<b>tk 34250-95</b>

10.0 mm Ø	<b>tk 34251-00</b>
10.5 mm Ø	<b>tk 34251-05</b>
11.0 mm Ø	<b>tk 34251-10</b>
11.5 mm Ø	<b>tk 34251-15</b>
12.0 mm Ø	<b>tk 34251-20</b>
12.5 mm Ø	<b>tk 34251-25</b>
13.0 mm Ø	<b>tk 34251-30</b>
13.5 mm Ø	<b>tk 34251-35</b>
14.0 mm Ø	<b>tk 34251-40</b>
14.5 mm Ø	<b>tk 34251-45</b>
15.0 mm Ø	<b>tk 34251-50</b>
15.5 mm Ø	<b>tk 34251-55</b>
16.0 mm Ø	<b>tk 34251-60</b>
16.5 mm Ø	<b>tk 34251-65</b>
17.0 mm Ø	<b>tk 34251-70</b>
17.5 mm Ø	<b>tk 34251-75</b>
18.0 mm Ø	<b>tk 34251-80</b>
18.5 mm Ø	<b>tk 34251-85</b>
19.0 mm Ø	<b>tk 34251-90</b>
19.5 mm Ø	<b>tk 34251-95</b>

20.0 mm Ø	<b>tk 34252-00</b>
21.0 mm Ø	<b>tk 34252-10</b>
22.0 mm Ø	<b>tk 34252-20</b>
23.0 mm Ø	<b>tk 34252-30</b>
24.0 mm Ø	<b>tk 34252-40</b>
25.0 mm Ø	<b>tk 34252-50</b>
26.0 mm Ø	<b>tk 34252-60</b>
27.0 mm Ø	<b>tk 34252-70</b>
28.0 mm Ø	<b>tk 34252-80</b>
29.0 mm Ø	<b>tk 34252-90</b>
30.0 mm Ø	<b>tk 34253-00</b>



**HEGAR**

1 / 2 mm Ø	<b>tk 34262-02</b>
3 / 4 mm Ø	<b>tk 34262-04</b>
5 / 6 mm Ø	<b>tk 34262-06</b>
7 / 8 mm Ø	<b>tk 34262-08</b>
9 / 10 mm Ø	<b>tk 34262-10</b>
11 / 12 mm Ø	<b>tk 34262-12</b>
13 / 14 mm Ø	<b>tk 34262-14</b>
15 / 16 mm Ø	<b>tk 34262-16</b>
17 / 18 mm Ø	<b>tk 34262-18</b>
19 / 20 mm Ø	<b>tk 34262-20</b>
21 / 22 mm Ø	<b>tk 34262-22</b>
23 / 24 mm Ø	<b>tk 34262-24</b>
25 / 26 mm Ø	<b>tk 34262-26</b>

Aorta-Dilatatoren  
*Aorta dilators*

Dilatateurs aortiques  
*Dilatadores de aorta*  
Dilatatori per aorta

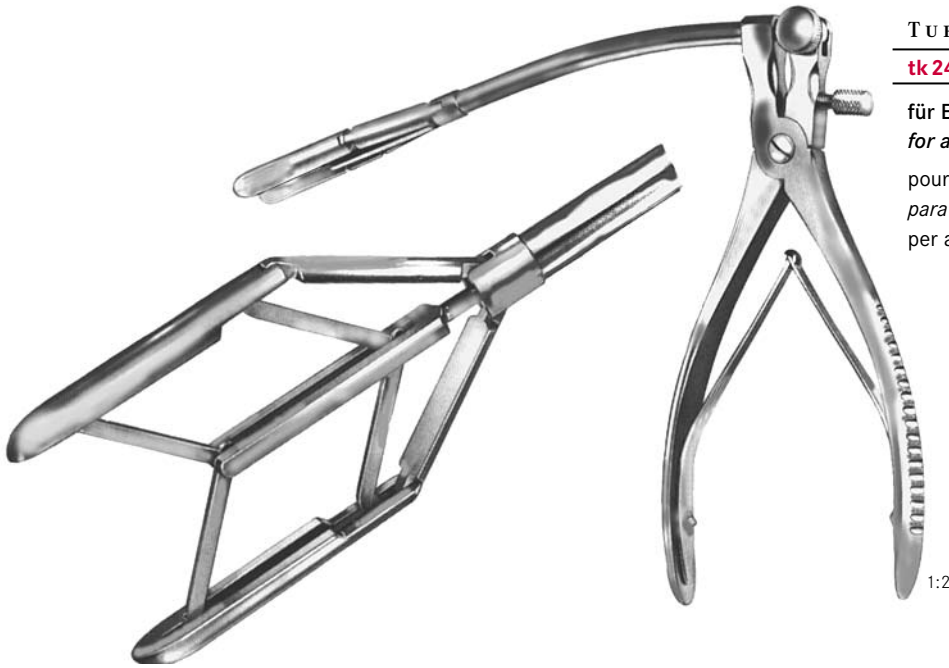

**TUBBS**

**tk 24838-00**

für Erwachsene, Spreizweite 8 mm – 42 mm  
*for adults, blade opening from 8 mm – 42 mm*  
pour adultes, écartement de 8 mm – 42 mm  
*para adultos, apertura de 8 mm – 42 mm*  
per adulti, apertura da 8 mm – 42 mm

1:2

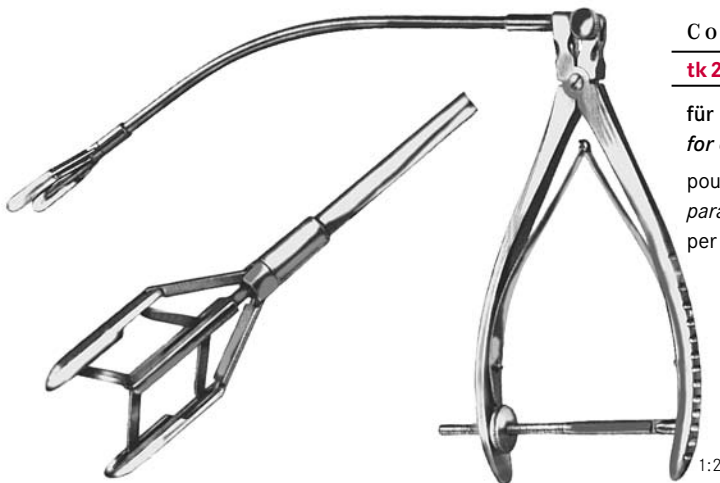

**COOLEY**

**tk 24839-00**

für Kinder, Spreizweite 6 mm – 15 mm  
*for children, blade opening from 6 mm – 15 mm*  
pour enfants, écartement de 6 mm – 15 mm  
*para niños, apertura de 6 mm – 15 mm*  
per bambini, apertura da 6 mm – 15 mm

1:2

**Tunnelierbesteck**  
*Tunneling set*

Jeu pour tunnelisation  
*Juego de tunelizacion*  
Set per tunnelizzazione



**tk 24846-00**

**Satz komplett**  
*Set complete*

Jeu complet  
*Juego completo*  
Set completo

Tunnelierbesteck  
Tunneling set

Jeu pour tunnelisation  
Juego de tunelización  
Set per tunnelizzazione

Oliven, Paar  
Olives, pair  
Olives, paire  
Olives, par  
Olive, paio

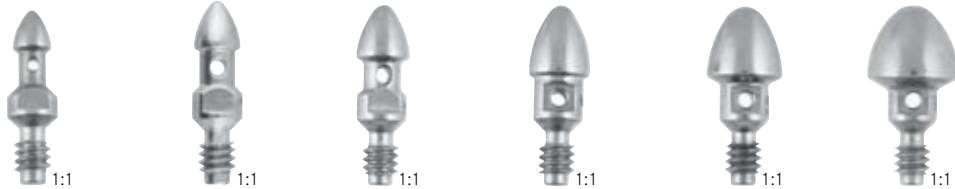

5 mm	6 mm	7 mm	8 mm	10 mm	12 mm
<b>tk 24846-05</b>	<b>tk 24846-06</b>	<b>tk 24846-07</b>	<b>tk 24846-08</b>	<b>tk 24846-10</b>	<b>tk 24846-12</b>

Tunnelierschäfte  
Tunneling sheaths

Gaines de tunnelisation  
Vástagos de tunelización  
Guaine di tunnelizzazione



245 mm - 9¾"

**tk 24846-01**



245 mm - 9¾"

**tk 24846-02**

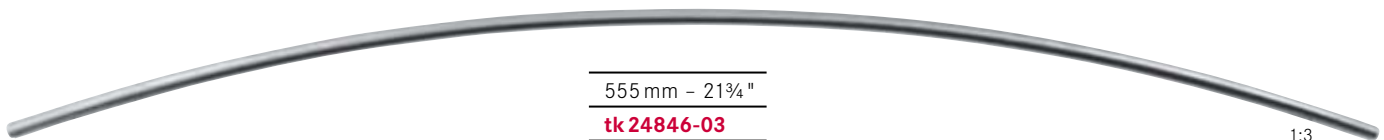

555 mm - 21¾"

**tk 24846-03**

**Tunnelierbesteck**  
*Tunneling set*

Jeu pour tunnelisation  
*Juego de tunelizacion*  
Set per tunnelizzazione



1:1

**tk 24846-15**

**Venenaufsatz**  
*Vein tip*

Embout pour veines  
*Punta para veines*  
Inserto per vena



1:1

125 mm - 5"

**tk 24846-04**

**Griff, Paar**  
*Handle, pair*  
Manche, paire  
*Mango, par*  
Manico, paio



1:1

100 mm - 4"

**tk 24846-17**

**Gabelschlüssel**  
*Wrench*  
Clé à fourche  
*Llave de tuercas*  
Chiave a forchetta



1:1

**tk 24846-16**

**Luer Adapter**  
*Luer adapter*

Adaptateur Luer  
*Adaptador Luer*  
Adattatore Luer

**tk 24846-20**

**Etui allein**  
*Case only*  
Boîte seule  
*Caja suelta*  
Scatola sola

**Aortastanzen**  
**Aorta punches**

Perforateurs pour l'aorte  
Perforadores para aorta  
Perforatori per aorta



	x = 4 mm	x = 5 mm	x = 6 mm
150 mm - 6 $\frac{3}{4}$ "	<b>tk 24847-02</b>	<b>tk 24847-03</b>	<b>tk 24847-04</b>



Hohlmeißelzangen  
*Bone rongeurs*

Pinces gouges  
*Pinzas gubias*  
 Pinze sgorbie



**BEYER**  
 180 mm - 7"  
**tk 24615-18**



**RUSKIN**  
 180 mm - 7" **tk 24616-05** **tk 24616-04**



**MAYFIELD**  
 175 mm - 7"  
**tk 24627-17**

Hohlmeißelzangen  
*Bone rongeurs*

Pinces gouges  
*Pinzas gubias*  
Pinze sgorbie



STILLE-  
RUSKIN

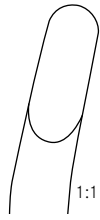

1:1

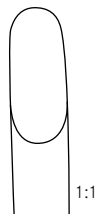

1:1

230 mm - 9"

**tk 24617-23**

**tk 24618-23**

1:2



STILLE



1:1



1:1



1:1

4 mm

6 mm

8 mm

230 mm - 9"

**tk 24619-04**

**tk 24619-06**

**tk 24619-08**



1:2

Hohlmeißelzangen  
Bone rongeurs

Pinces gouges  
Pinzas gubias  
Pinze sgorbie



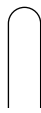

1:2

LEKSELL	 1:1	 1:1	 1:1
	4 mm	6 mm	8 mm
240 mm - 9½"	<b>tk 24621-04</b>	<b>tk 24621-06</b>	<b>tk 24621-08</b>



1:2

STILLE-LUER	 1:1	 1:1
220 mm - 8¾"	<b>tk 24624-22</b>	<b>tk 24625-22</b>

Hohlmeißelzangen  
*Bone rongeurs*

Pinces gouges  
*Pinzas gubias*  
Pinze sgorbie



**RÖTTGEN-  
RUSKIN**

230 mm - 9"

**tk 24629-23**

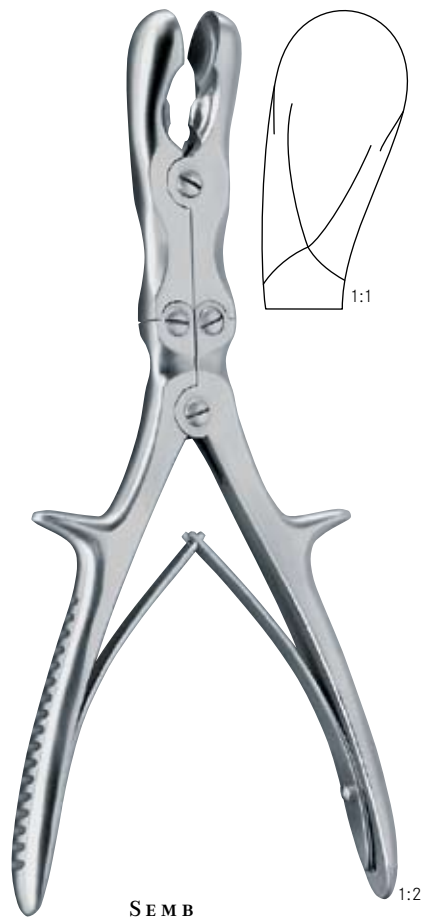

**SEMB**

240 mm - 9½"

**tk 24630-23**

Hohlmeißelzangen | Pinces gouges  
*Bone rongeurs* | *Pinzas gubias*  
 Pinze sgorbie

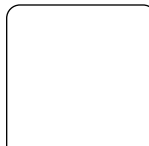
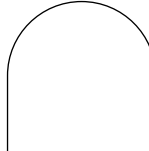

SAUERBRUCH	 1:1	 1:1
	Fig. 1	Fig. 2
300 mm - 12"	<b>tk 24633-01</b>	<b>tk 24633-02</b>

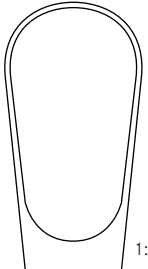
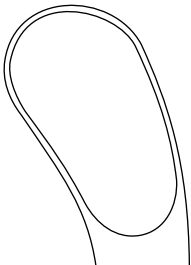

LUER-STILLE	 1:1	 1:1
	270 mm - 10 <sup>3</sup> / <sub>4</sub> "	<b>tk 24646-27</b>

**Knochensplitterzangen**  
*Bone cutting forceps*

Pinces coupantes à os  
*Pinzas cortantes para huesos*  
Cesoie per ossa



**BÖHLER**

150 mm - 6"

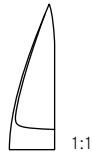

**tk 24654-15**

**tk 24655-15**

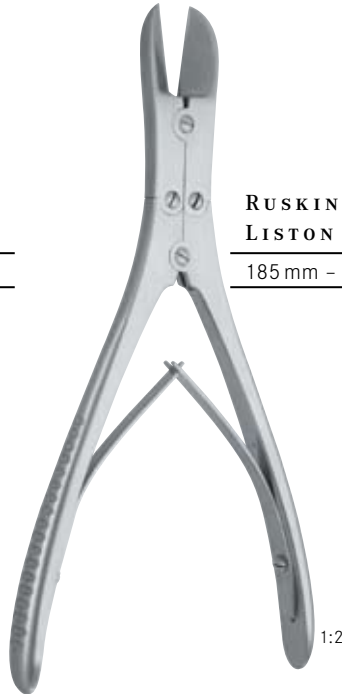

**RUSKIN-  
LISTON**

185 mm - 7 $\frac{1}{4}$ "

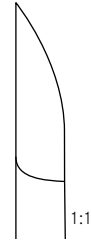

**tk 24660-18**

**tk 24661-18**



**STILLE-  
LISTON**

270 mm - 10 $\frac{3}{4}$ "

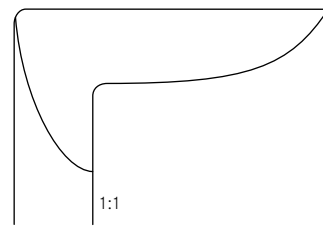
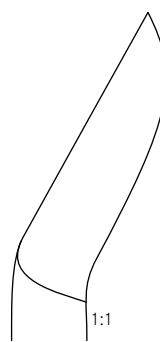
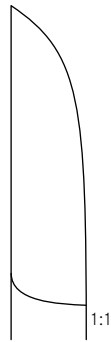

**tk 24670-27**

**tk 24671-27**

**tk 24673-27**

**Knochensplitterzangen**  
*Bone cutting forceps*

Pinces coupantes à os  
*Pinzas cortantes para huesos*  
 Cesoie per ossa



Knochenhaltezangen  
*Bone holding forceps*

Daviers porte-os  
*Pinzas para huesos*  
Tenaglie per ossa



**FERGUSSON**

210 mm - 8 1/4"

**tk 24700-21**



**VAN BUREN**

230 mm - 9"

**tk 24701-23**



**Knochenhaltezangen**  
*Bone holding forceps*

Daviers porte-os  
*Pinzas para huesos*  
Tenaglie per ossa



**LANGENBECK**

210 mm - 8 1/4"

**tk 24702-21**

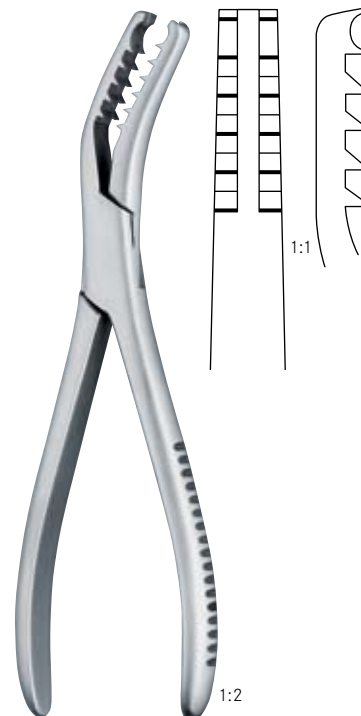

**SEMB**

190 mm - 7 1/2"

**tk 24704-19**

**Raspatorien – Elevatorien**  
*Periosteal raspatories – Elevators*

**Rugines – Elevateurs**  
*Raspatorios – Elevadores*  
Periostotomi – Elevatori

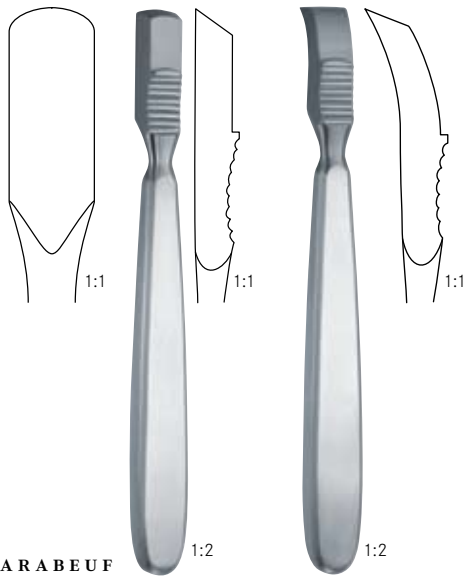

<b>FARABEUF</b>	
150 mm - 6"	<b>tk 24520-15</b> <b>tk 24521-15</b>
gerade <i>straight</i>	gebogen <i>curved</i>
droit <i>recta</i>	courbe <i>curva</i>
retto	curvo



<b>LAMBOTTE</b>	
	210 mm - 8 1/4"
x = 5 mm	<b>tk 24523-05</b>
x = 10 mm	<b>tk 24523-10</b>
x = 15 mm	<b>tk 24523-15</b>
x = 20 mm	<b>tk 24523-20</b>
x = 25 mm	<b>tk 24523-25</b>

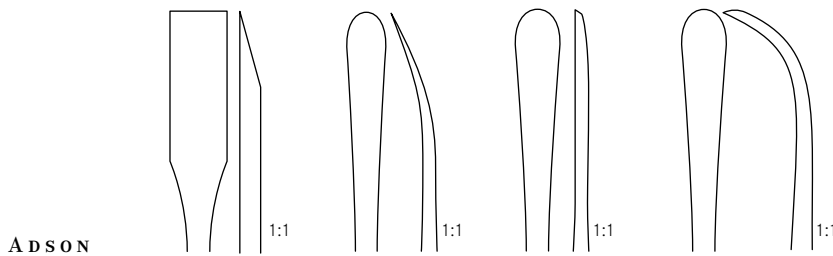

<b>ADSON</b>	Fig. 1	Fig. 2	Fig. 3	Fig. 4
170 mm - 6 3/4"	<b>tk 24535-01</b>	<b>tk 24535-02</b>	<b>tk 24535-03</b>	<b>tk 24535-04</b>

**Raspatorien – Elevatorien**  
*Periosteal raspatories – Elevators*

**Rugines – Elevateurs**  
*Raspatorios – Elevadores*  
 Periostotomi – Elevatori

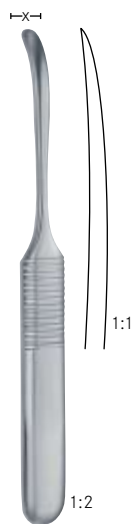

<b>WILLIGER</b>	
	x = 5 mm
130 mm – 5"	<b>tk 24525-13</b>



<b>WILLIGER</b>	
	160 mm – 6¼"
x = 4 mm	<b>tk 24525-16</b>
x = 6 mm	<b>tk 24526-16</b>

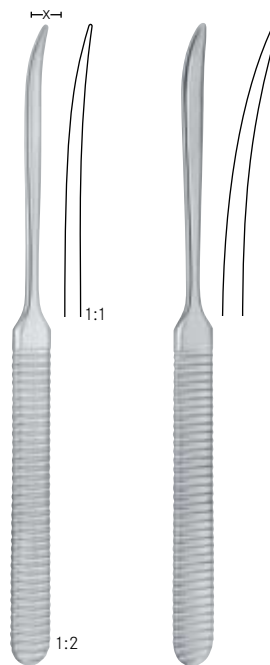

<b>WILLIGER</b>		
	x = 5 mm	x = 6.5 mm
160 mm – 6¼"	<b>tk 24532-16</b>	<b>tk 24533-17</b>



<b>FARABEUF-COLLIN</b>	
	x = 11 mm
160 mm – 6¼"	<b>tk 24528-01</b>



	x = 11 mm
	<b>tk 24528-02</b>

Rippenscheren  
*Rib shears*

Costotomes  
*Costótomos*  
Costotomi



Rippenscheren  
*Rib shears*

Costotomes  
*Costótomos*  
Costotomi



1:3

**LEBSCHE**

245 mm - 9¾"

**tk 24680-24**



1:3

**BRUNNER**

320 mm - 12½"

**tk 24681-32**

für die rechte Hand  
*for the right hand*  
pour la main droite  
*para la mano derecha*  
per la mano destra



1:3

**SAUERBRUCH-FREY**

360 mm - 14¼"

**tk 24683-36**

für die linke Hand  
*for the left hand*  
pour la main gauche  
*para la mano izquierda*  
per la mano sinistra

Rippenscheren  
*Rib shears*

Costotomes  
*Costótomos*  
Costotomi



1:3

**SAUERBRUCH**

260 mm - 10<sup>3</sup>/<sub>4</sub>" **tk 24685-26**

für Erwachsene  
*for adults*  
pour adulte  
*para adultos*  
per adulti

240 mm - 9<sup>1</sup>/<sub>2</sub>" **tk 24685-24**

für Kinder  
*for childs*  
pour enfants  
*para hijos*  
per bambini



1:3

**GIERTZ-STILLE**

270 mm - 10<sup>3</sup>/<sub>4</sub>" **tk 24688-27**



1:3

**BETHUNE**

340 mm - 13<sup>1</sup>/<sub>2</sub>" **tk 24694-34**

Rippenscheren  
*Rib shears*

Costotomes  
*Costótomos*  
Costotomi



**VEHMEHREN**

270 mm - 10½"

**tk 24687-26**



## Rippensperrer aus Aluminium *Rib spreaders made of aluminium*

Écarteurs de côtes en aluminium  
*Separadores costales en aluminio*  
Divaricatori costali in alluminio

Rippensperrer aus Aluminium zeichnen sich besonders durch ihre hohe mechanische Festigkeit aus. Aufgrund des geringen Gewichts sind Aluminium Instrumente für den Einsatz in der Kinder- und Neugeborenen-Chirurgie besonders geeignet. In der Erwachsenen-Chirurgie kommt es durch das geringere Gewicht der Aluminium-Instrumente ebenfalls zu einer erheblichen Entlastung des Operateurs und des Personals. Bei bildgebenden Verfahren, kommt es wegen der nicht-magnetischen Eigenschaft von Aluminium zu keinerlei Störungen. Aluminium ist bedingt durchlässig für Röntgenstrahlen und somit ebenfalls für die Orthopädie und Neurochirurgie geeignet.

*Rib Spreaders made of aluminium present an outstanding mechanical resistance. Because of their low weight, aluminium instruments are perfectly suited for the children and neonatal surgery. Also in adult surgery, the low weight leads to considerable relief for the surgeon and the staff in the operation theatre. Imaging processes are also not disturbed, due to the non magnetic attribute of aluminium. As aluminium is partly translucent for X-rays, it is well suited for orthopedic and neurosurgical application.*

Ecarteurs des côtes en aluminium se distinguent pour leur haute résistance mécanique. À cause de leur petit poids, des instruments en aluminium sont très convenients pour la chirurgie pédiatrique et des nouveaux-nés. Dans la chirurgie des adultes, le petit poids est un soulagement considérable du travail des chirurgiens et du personnel dans les bloc opératoires. Grâce à sa propriété anti-magnétique, l'aluminium n'a aucune influence négative sur des processus MRI (magnetic resonance imaging systems). Donc l'aluminium est partiellement perméable pour des rayons X, des instruments en aluminium sont bien utilisables pour des applications orthopédiques et neurochirurgicales.

*Separadores costales en aluminio se distinguen especialmente por su alta resistencia mecánica. Por su poco peso, el instrumental en aluminio esta perfectamente apropiado para la cirugía de niños y neonatales. En la cirugía de adultos, el bajo peso implica también una facilitación considerable por el cirujano y el personal en el quirófano. Por su característica anti-magnética, el instrumental en aluminio no tiene ninguna influencia negativa sobre los procesos MRI (magnetic resonance imaging systems). La permeabilidad limitada del aluminio para los rayos X, permite el uso del instrumental en aluminio también para la ortopedia y neurocirugía.*

Divaricatori costali Tekno in alluminio si distinguono per l'alta resistenza meccanica. Grazie al peso ridotto gli strumenti di alluminio sono perfetti per la chirurgia pediatrica e neonatale. Anche nella chirurgia tradizionale la leggerezza garantisce considerevoli vantaggi al chirurgo ed allo staff della camera operatoria. Essendo un metallo anti-magnetico l'alluminio è utilizzabile durante esami con risonanza magnetica (MRI). Grazie alla particolare permeabilità ai raggi X, gli strumenti di alluminio sono indicati per la neurochirurgia e per la chirurgia ortopedica.





**Rippensperrer**  
**Rib retractors**

**Ecarteurs des côtes**  
**Separadores costales**  
**Divaricatori costali**

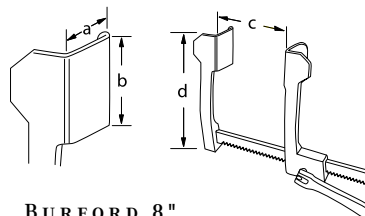

**BURFORD 8"**

	a	b	c	d
<b>tk 24806-01</b>	45 mm	62 mm	165 mm	200 mm
	65 mm	62 mm		

**für Erwachsene, mit 2 Paar auswechselbaren Valven, Aluminium**  
**for adults, with 2 pairs of interchangeable blades, aluminium**  
pour adultes, avec 2 paires de valves interchangeables, aluminium  
para adultos, con 2 pares de valvas intercambiables, aluminio  
per adulti, con 2 paia di valve intercambiabili, alluminio

**BURFORD 10"**

	a	b	c	d
<b>tk 24806-02</b>	45 mm	62 mm	250 mm	200 mm
	65 mm	62 mm		

**für Erwachsene, mit 2 Paar auswechselbaren Valven, Aluminium**  
**for adults, with 2 pairs of interchangeable blades, aluminium**  
pour adultes, avec 2 paires de valves interchangeables, aluminium  
para adultos, con 2 pares de valvas intercambiables, aluminio  
per adulti, con 2 paia di valve intercambiabili, alluminio

**BURFORD 12"**

	a	b	c	d
<b>tk 24806-03</b>	45 mm	62 mm	290 mm	200 mm
	62 mm	62 mm		

**für Erwachsene, mit 2 Paar auswechselbaren Valven, Aluminium**  
**for adults, with 2 pairs of interchangeable blades, aluminium**  
pour adultes, avec 2 paires de valves interchangeables, aluminium  
para adultos, con 2 pares de valvas intercambiables, aluminio  
per adulti, con 2 paia di valve intercambiabili, alluminio

**BURFORD**

	a	b	c	d
<b>tk 24806-05</b>	30 mm	42 mm	130 mm	117 mm
	41 mm	42 mm		

**für Kinder, mit 2 Paar auswechselbaren Valven, Aluminium**  
**for children, with 2 pairs of interchangeable blades, aluminium**  
pour enfants, avec 2 paires de valves interchangeables, aluminium  
para niños, con 2 pares de valvas intercambiables, aluminio  
per bambini, con 2 paia di valve intercambiabili, alluminio

Rippensperrer  
Rib retractors

Ecarteurs des côtes  
Separadores costales  
Divaricatori costali

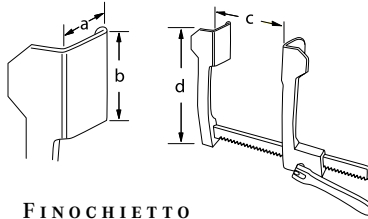

FINOCHIETTO

	a	b	c	d
<b>tk24808-01</b>	40 mm	45 mm	165 mm	110 mm

kleines Modell, auch für Kinder geeignet, Aluminium  
*small size, for children too, aluminium*

petit modèle, également pour enfants, aluminium  
*modelo pequeño, también para niños, aluminio*  
*modello piccolo, pure per bambini, alluminio*

1:2

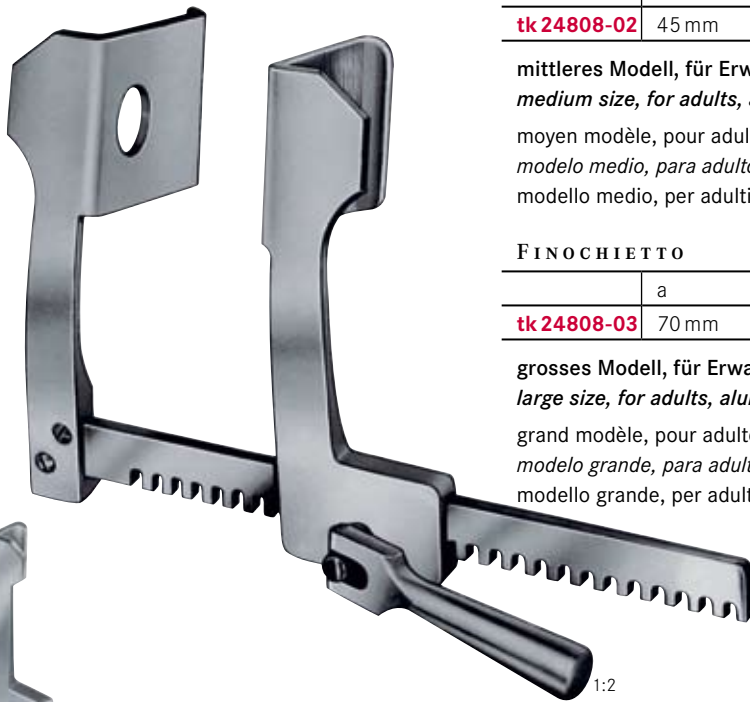

FINOCHIETTO

	a	b	c	d
<b>tk24808-02</b>	45 mm	65 mm	200mm	140 mm

mittleres Modell, für Erwachsene, Aluminium  
*medium size, for adults, aluminium*

moyen modèle, pour adultes, aluminium  
*modelo medio, para adultos, aluminio*  
*modello medio, per adulti, alluminio*

FINOCHIETTO

	a	b	c	d
<b>tk24808-03</b>	70 mm	65 mm	250 mm	140 mm

grosses Modell, für Erwachsene, Aluminium  
*large size, for adults, aluminium*

grand modèle, pour adultes, aluminium  
*modelo grande, para adultos, aluminio*  
*modello grande, per adulti, alluminio*

1:2

FINOCHIETTO-  
BABY-HAIGHT

	a	b	c	d
<b>tk24809-01</b>	27 mm	30 mm	95 mm	80 mm

für Kinder, Aluminium  
*for children, aluminium*  
pour enfants, aluminium  
*para niños, aluminio*  
per bambini, alluminio

FINOCHIETTO-  
INFANT

	a	b	c	d
<b>tk24808-05</b>	12 mm	15 mm	70 mm	55 mm

für Säuglinge, Aluminium  
*for infants, aluminium*  
pour nourissons, aluminium  
*para lactantes, aluminio*  
per lattanti, alluminio

**Rippensperrer**  
**Rib retractors**

Ecarteurs des côtes  
*Separadores costales*  
Divaricatori costali

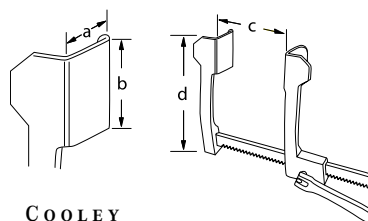

**COOLEY**

	a	b	c	d
<b>tk 24812-00</b>	35 mm	100 mm	180 mm	180 mm

für Erwachsene, Aluminium  
*for adults, aluminium*  
pour adultes, aluminium  
*para adultos, aluminio*  
per adulti, alluminio

**COOLEY**

	a	b	c	d
<b>tk 24812-01</b>	35 mm	115 mm	230 mm	205 mm

extra gross, für Erwachsene, Aluminium  
*extra large, for adults, aluminium*  
extra grand, pour adultes, aluminium  
*extra grande, para adultos, aluminio*  
extra grande, per adulti, alluminio



**COOLEY**

	a	b	c	d
<b>tk 24812-02</b>	30 mm	50 mm	185 mm	145 mm

für Erwachsene, Standardgröße, modifiziert, Aluminium  
*for adults, standard size, modified, aluminium*  
pour adultes, standard, modifié, aluminium  
*para adultos, estandard, modificado, aluminio*  
per adulti, standard, modificato, alluminio

**COOLEY**

	a	b	c	d
<b>tk 24812-03</b>	20 mm	45 mm	140 mm	110 mm

für Kinder, modifiziert, Aluminium  
*for children, modified, aluminium*  
pour enfants, modifié, aluminium  
*para niños, modificado, aluminio*  
per bambini, modificato, alluminio

Rippensperrer  
Rib retractors

Ecarteurs des côtes  
Separadores costales  
Divaricatori costali

**ALUK**

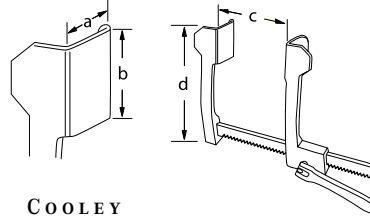

**COOLEY**

	a	b	c	d
<b>tk 24812-04</b>	30 mm	35 mm	140 mm	110 mm

für Kinder, Aluminium  
*for children, aluminium*

pour enfants, aluminium  
*para niños, aluminio*  
per bambini, alluminio

**COOLEY**

	a	b	c	d
<b>tk 24812-05</b>	20 mm	25 mm	100 mm	80 mm

für Säuglinge, Aluminium  
*for infants, aluminium*

pour nourissons, aluminium  
*para lactantes, aluminio*  
per lattanti, alluminio

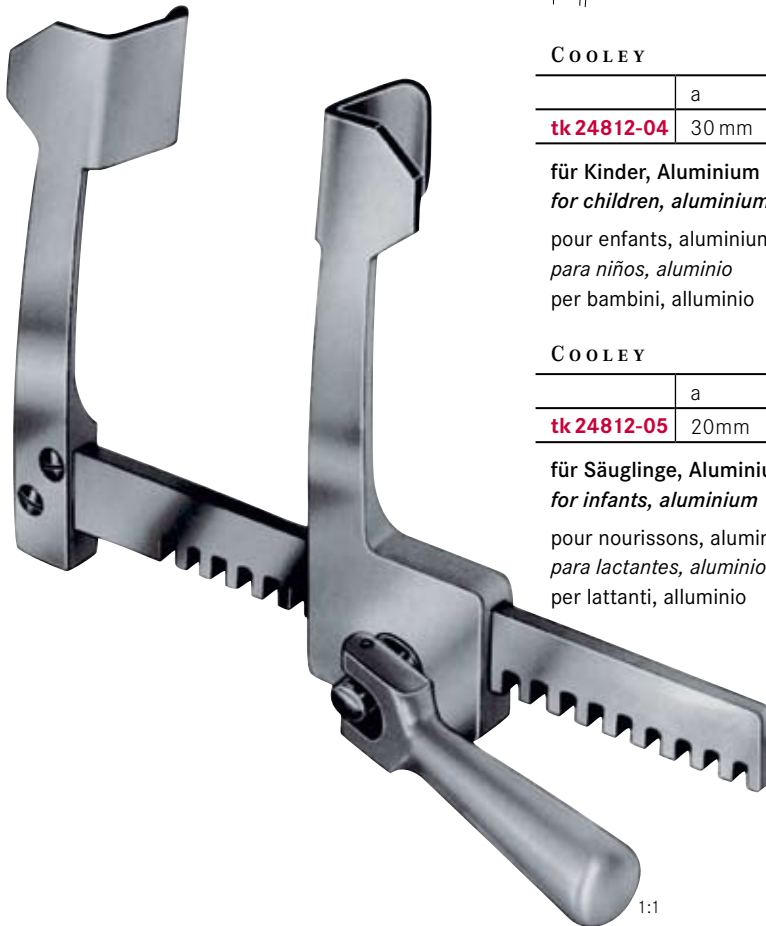

**COOLEY**

	a	b	c	d
<b>tk 24814-00</b>	12 mm	15 mm	70 mm	55 mm

für Neugeborene, Aluminium  
*for newbornes, aluminium*

pour nouveau-nés, aluminium  
*para recién nacidos, aluminio*  
per neonati, alluminio

**Rippensperrer**  
**Rib retractors**

**Ecarteurs des côtes**  
**Separadores costales**  
**Divaricatori costali**

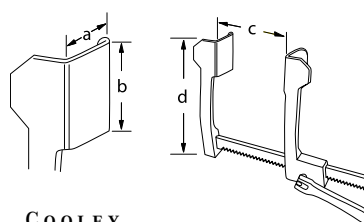

**COOLEY**

	a	b	c	d
<b>tk 24815-00</b>	15 mm	30 mm	115 mm	80 mm

für Kinder, Sternotomiespreizer, leicht aber trotzdem kräftig, Aluminium  
*for children, sternal spreader, light-weight but sturdy, aluminium*

pour enfants, écarteur sternal, léger mais fort, aluminium  
*para niños, separador sternal, ligero y fuerte, aluminio*  
per bambini, divaricatore sternale, leggero ma forte, alluminio

**COOLEY**

	a	b	c	d
<b>tk 24815-01</b>	14 mm	16 mm	85 mm	55 mm

für Neugeborene, Aluminium  
*for newbornes, aluminium*

pour nouveau-nés, aluminium  
*para recién nacidos, aluminio*  
per neonati, alluminio

**COOLEY**

	a	b	c	d
<b>tk 24812-06</b>	15 mm	20 mm	100 mm	80 mm

für Säuglinge, Sternotomiespreizer mit Dornen, Aluminium  
*for infants, sternal spreader with prongs, aluminium*

pour nourissons, écarteur sternal avec poinçons, aluminium  
*para lactantes, separador sternal con espigas, aluminio*  
per lattanti, divaricatore sternale con spine, alluminio

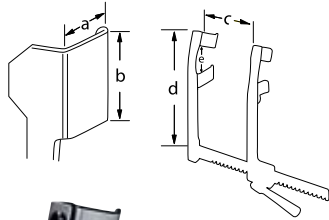
**Rippensperrer**  
**Rib retractors**
**Ecarteurs des côtes**  
**Separadores costales**  
**Divaricatori costali**
**ALUK**

**MORSE STERNAL**

	a	b	c	d	e
<b>tk 24816-04</b>	20 mm	20 mm	155 mm	120 mm	50 mm

**mit 2 Paar beweglichen Valven, für Kinder,**
**Biegung der Spreizarme zwischen den Valven, Aluminium**
*with 2 pairs movable blades, for children, arms curved between blades, aluminium*
*avec 2 paires de valves mobiles, pour enfants, courbure entre les valves, aluminium*
*con 2 pares de valvas móviles, para niños, curvado entre las valvas, aluminio*
*con 2 paia di valve mobili, per bambini, branche curvate, alluminio*
**MORSE-FAVALORO STERNAL**

	a	b	c	d	e
<b>tk 24816-02</b>	40 mm	20 mm	155 mm	175 mm	65 mm

**mit 2 Paar beweglichen Valven, für Erwachsene,**
**Biegung der Spreizarme zwischen den Valven, Aluminium**
*with 2 pairs movable blades, for adults, arms curved between blades, aluminium*
*avec 2 paires de valves mobiles, pour adultes, courbure entre les valves, aluminium*
*con 2 pares de valvas móviles, para adultos, curvado entre las valvas, aluminio*
*con 2 paia di valve mobili, per adulti, branche curvate, alluminio*
**MORSE-FAVALORO STERNAL**

	a	b	c	d	e
<b>tk 24816-01</b>	12 mm	20 mm	155 mm	120 mm	50 mm

**mit 2 Paar beweglichen Valven, für Kinder, Biegung der Spreizarme zwischen den Valven, Aluminium**
*with 2 pairs movable blades, for children, arms curved between blades, aluminium*
*avec 2 paires de valves mobiles, pour enfants, courbure entre les valves, aluminium*
*con 2 pares de valvas móviles, para niños, curvado entre las valvas, aluminio*
*con 2 paia di valve mobili, per bambini, branche curvate, alluminio*

Rippensperrer  
Rib retractors

Ecarteurs des côtes  
Separadores costales  
Divaricatori costali



## MORSE STERNAL

	a	b	c	d	e
<b>tk 24816-00</b>	20 mm	28 mm	210 mm	155 mm	72 mm

mit 2 Paar beweglichen Valven, für Erwachsene,

Biegung der Spreizarme zwischen Zahnstange und Valven, Aluminium

*with 2 pairs movable blades, for adults, arms curved between rack and blades, aluminium*

avec 2 paires de valves mobiles, pour adultes, courbure entre la base et les valves, aluminium

*con 2 pares de valvas móviles, para adultos, curvado entre la base y las valvas, aluminio*

con 2 paia di valve mobili, per adulti, branche curvate, alluminio

## MORSE STERNAL

	a	b	c	d	e
<b>tk 24816-03</b>	20 mm	20 mm	155 mm	120 mm	50 mm

mit 2 Paar beweglichen Valven, für Kinder,

Biegung der Spreizarme zwischen Zahnstange und Valven, Aluminium

*with 2 pairs movable blades, for children, arms curved between rack and blades, aluminium*

avec 2 paires de valves mobiles, pour enfants, courbure entre la base et les valves, aluminium

*con 2 pares de valvas móviles, para niños, curvado entre la base y las valvas, aluminio*

con 2 paia di valve mobili, per bambini, branche curvate, alluminio

Rippensperrer  
Rib retractors

Ecarteurs des côtes  
Separadores costales  
Divaricatori costali

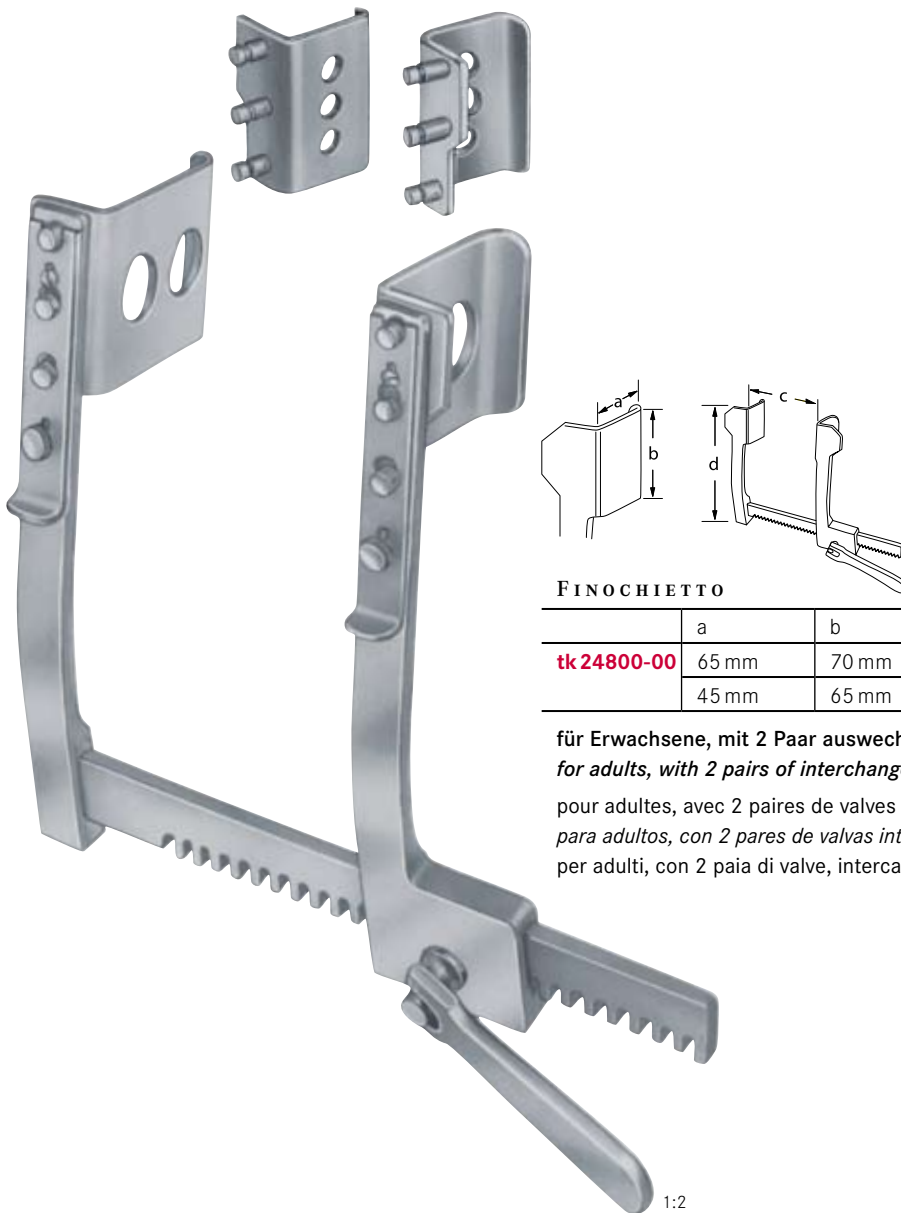

FINOCHIETTO

	a	b	c	d
<b>tk 24800-00</b>	65 mm	70 mm	200 mm	140 mm
	45 mm	65 mm		

für Erwachsene, mit 2 Paar auswechselbaren Valven, rostfrei  
for adults, with 2 pairs of interchangeable blades, stainless steel  
pour adultes, avec 2 paires de valves interchangeables, inoxydable  
para adultos, con 2 pares de valvas intercambiables, inoxidable  
per adulti, con 2 paia di valve, intercambiabili, inossidabile

1:2



BABY-HAIGHT

	a	b	c	d
<b>tk 24801-01</b>	28 mm	30 mm	85 mm	70 mm
<b>tk 24801-02</b>	28 mm	30 mm	100 mm	75 mm

rostfrei  
stainless steel  
acier inoxydable  
acero inoxidable  
acciaio inossidabile

1:2



**Rippensperrer**  
**Rib retractors**

Ecarteurs des côtes  
*Separadores costales*  
Divaricatori costali

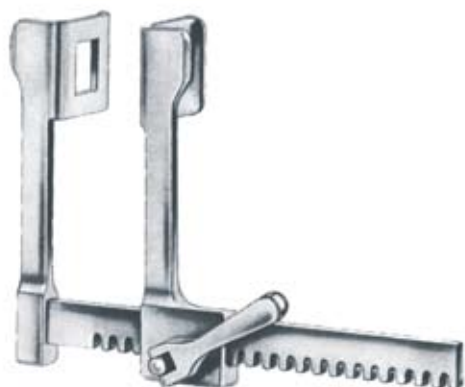

1:2

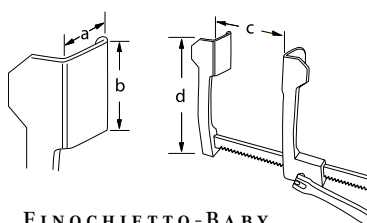

**FINOCHIETTO-BABY**

	a	b	c	d
<b>tk 24802-07</b>	14 mm	15 mm	75 mm	55 mm
<b>tk 24802-08</b>	21 mm	25 mm	75 mm	75 mm

rostfrei  
*stainless steel*  
acier inoxydable  
*acero inoxidable*  
acciaio inossidabile

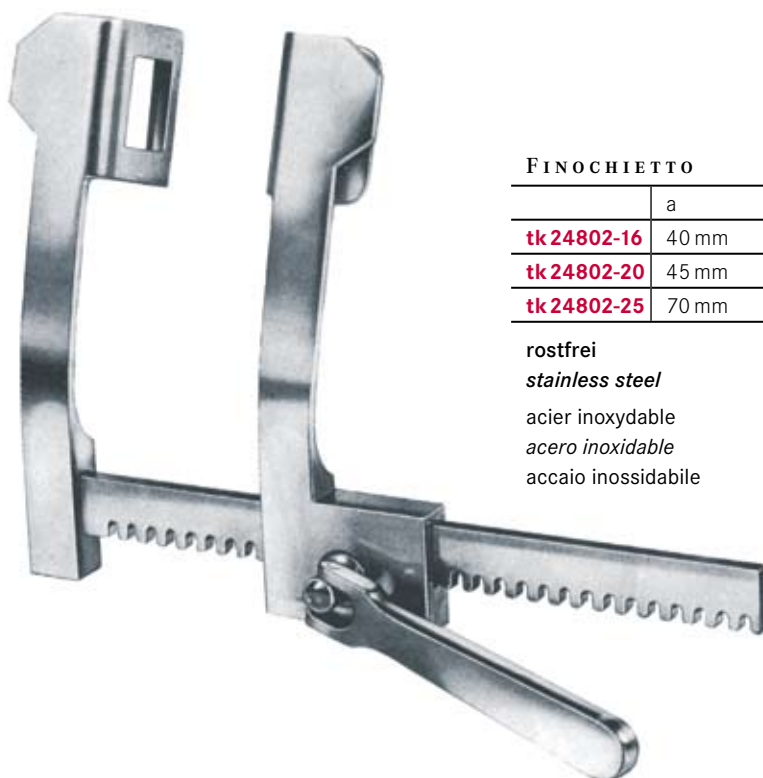

**FINOCHIETTO**

	a	b	c	d
<b>tk 24802-16</b>	40 mm	40 mm	165 mm	110 mm
<b>tk 24802-20</b>	45 mm	65 mm	200 mm	140 mm
<b>tk 24802-25</b>	70 mm	65 mm	250 mm	140 mm

rostfrei  
*stainless steel*  
acier inoxydable  
*acero inoxidable*  
acciaio inossidabile

Rippensperrer  
Rib retractors

Ecarteurs des côtes  
Separadores costales  
Divaricatori costali

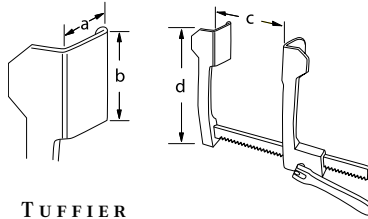

TUFFIER

	a	b	c	d
<b>tk 24803-00</b>	50 mm	45 mm	165 mm	110 mm

rostfrei  
stainless steel  
acier inoxydable  
acero inoxidable  
acciaio inossidabile

1:2



FINOCHIETTO-INFANT

	a	b	c	d
<b>tk 24804-05</b>	14 mm	15 mm	55 mm	25 mm

rostfrei  
stainless steel  
acier inoxydable  
acero inoxidable  
acciaio inossidabile

1:2



DE BOER (STERNAL)

	a	b	c	d
<b>tk 24805-01</b>	30 mm	100 mm	210 mm	185 mm

rostfrei  
stainless steel  
acier inoxydable  
acero inoxidable  
acciaio inossidabile

1:2

**Rippensperrer**  
**Rib retractors**

Ecarteurs des côtes  
*Separadores costales*  
Divaricatori costali

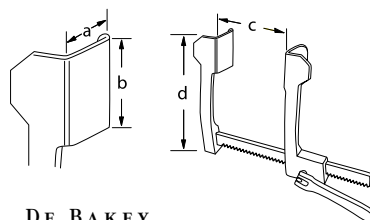

DE BAKEY

	a	b	c	d
<b>tk 24817-01</b>	20 mm	30 mm	120 mm	130 mm
	30 mm	30 mm		

für Kinder, mit 2 Paar auswechselbaren Valven, rostfrei  
*for children, with 2 pairs of interchangeable blades, stainless steel*  
pour enfants, 2 paires de valves, interchangeables, inoxydable  
*para niños, 2 pares de valvas intercambiables, inoxidable*  
per bambini, 2 paia di valve intercambiabili, inossidabile



DE BAKEY

	a	b	c	d
<b>tk 24817-02</b>	30 mm	60 mm	200 mm	190 mm
	48 mm	60 mm		

für Erwachsene, mit 2 Paar auswechselbaren Valven, rostfrei  
*for adults, with 2 pairs of interchangeable blades, stainless steel*  
pour adultes, 2 paires de valves, interchangeables, inoxydable  
*para adultos, 2 pares de valvas intercambiables, inoxidable*  
per adulti, 2 paia di valve intercambiabili, inossidabile



	a	b
<b>tk 24817-06</b>	30 mm	30 mm
<b>tk 24817-07</b>	30 mm	60 mm
<b>tk 24817-08</b>	48 mm	60 mm

Valven-Paar, rostfrei  
*Pair of blades, stainless steel*

Paire de valves, acier inoxydable  
*Par de valvas, acero inoxidable*  
Paia di valve, acciaio inossidabile

Rippensperrer  
*Rib retractors*

Ecarteurs des côtes  
*Separadores costales*  
Divaricatori costali

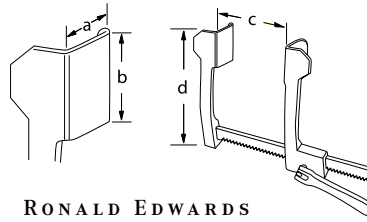
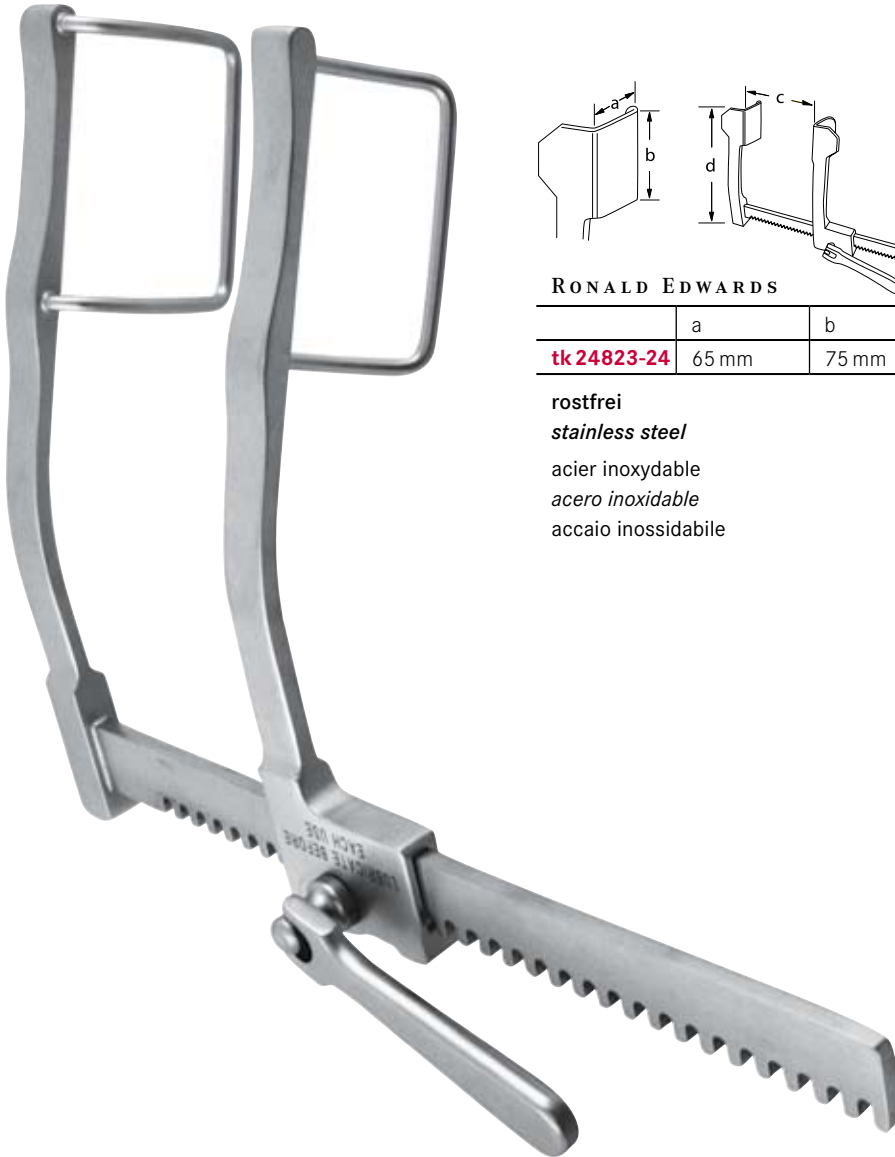

RONALD EDWARDS

	a	b	c	d
<b>tk 24823-24</b>	65 mm	75 mm	245 mm	240 mm

rostfrei  
*stainless steel*  
acier inoxydable  
*acero inoxidable*  
acciaio inossidabile

**Rippensperrer** | Ecarteurs des côtes  
**Rib retractors** | Separadores costales  
 Divaricatori costali

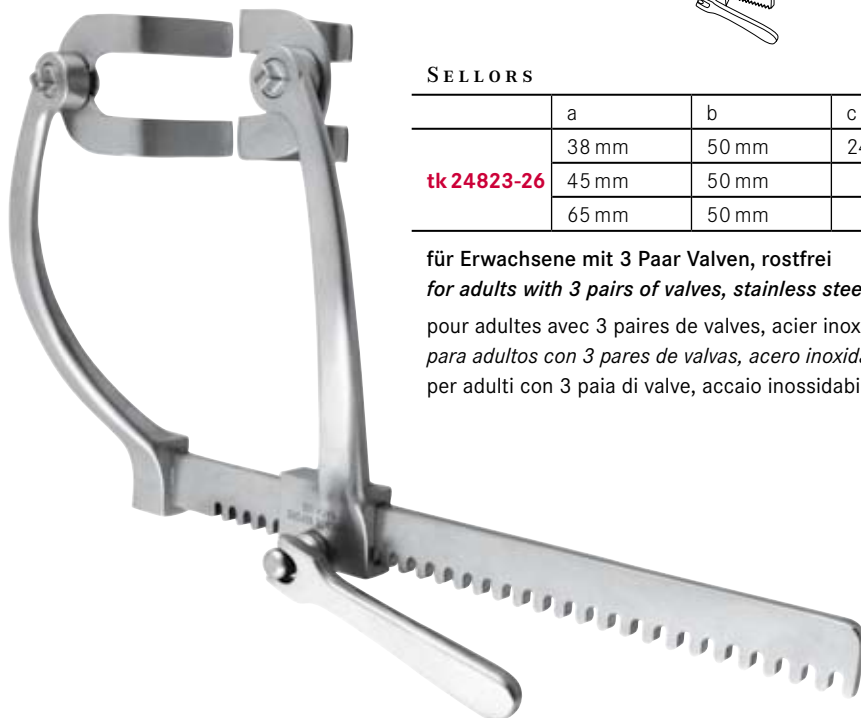
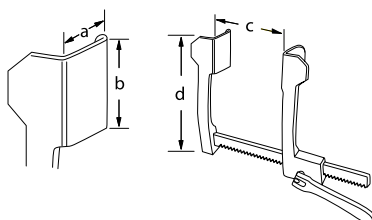

**SELLORS**

	a	b	c	d
	38 mm	50 mm	240 mm	240 mm
<b>tk 24823-26</b>	45 mm	50 mm		
	65 mm	50 mm		

für Erwachsene mit 3 Paar Valven, rostfrei  
 for adults with 3 pairs of valves, stainless steel  
 pour adultes avec 3 paires de valves, acier inoxydable  
 para adultos con 3 pares de valvas, acero inoxidable  
 per adulti con 3 paia di valve, acciaio inossidabile

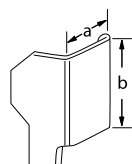

**SELLORS**

		a	b
<b>tk 24823-27</b>	Small	38 mm	50 mm
<b>tk 24823-28</b>	Medium	45 mm	50 mm
<b>tk 24823-29</b>	Large	65 mm	50 mm

rostfrei  
 stainless steel  
 acier inoxydable  
 acero inoxidable  
 acciaio inossidabile



**tk 24824-10**

Schlüssel für tk 24823-26  
 Key for tk 24823-26  
 Clé pour tk 24823-26  
 Llave para tk 24823-26  
 Chiave per tk 24823-26

Rippensperrer  
Rib retractors

Ecarteurs des côtes  
Separadores costales  
Divaricatori costali

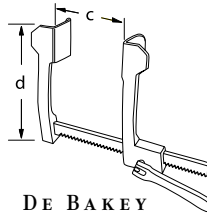

DE BAKEY

	a	b	c	d
	40 mm	100 mm	200 mm	225 mm
<b>tk 24817-10</b>	50 mm	80 mm		
	200 mm	200 mm		

für Erwachsene mit 3 Paar Valven, rostfrei  
for adults with 3 pairs of valves, stainless steel

pour adultes avec 3 paires de valves, acier inoxydable  
para adultos con 3 pares de valvas, acero inoxidable  
per adulti con 3 paia di valve, acciaio inossidabile

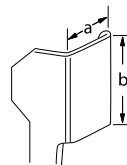

	a	b
<b>tk 24817-23</b>	50 mm	66 mm
<b>tk 24817-25</b>	60 mm	60 mm
<b>tk 24817-26</b>	40 mm	100 mm
<b>tk 24817-27</b>	50 mm	80 mm
<b>tk 24817-29</b>	80 mm	60 mm

1 Paar Valven  
1 Pair valves

1 Paire valves

1 Par valvas

1 Paia valvole

**Rippensperrer**  
**Rib retractors**

Ecarteurs des côtes  
*Separadores costales*  
Divaricatori costali



**tk 24828-00**

**T-Haltearm für zwei Atrial Retraktoren**  
**T-bar for two atrial retractors**

Fixateur en T pour deux retracteurs atriaux  
*Fijador en T para dos retractores atriales*  
Fissatore a T per due retrattori atriali



**tk 24828-01**

**Atrial Retraktor, klein**  
**Atrial retractor, small**

Retracteur atrial, petit  
*Retractor atrial, pequeño*  
Retrattore atriale piccolo



**tk 24828-02**

**Atrial Retraktor, groß**  
**Atrial retractor, big**

Retracteur atrial, grand  
*Retractor atrial, grande*  
Retrattore atriale grande

Rippensperrer  
Rib retractors

Ecarteurs des côtes  
Separadores costales  
Divaricatori costali

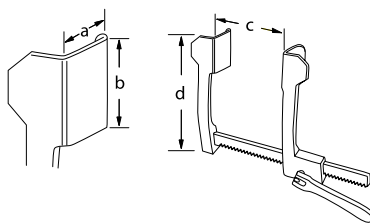

MERCEDES THORAXSPERRER

	a	b	c	d
<b>tk 24819-00</b>	45 mm	68 mm	285 mm	185 mm
	70 mm	75 mm		

für Erwachsene, mit 2 Paar auswechselbaren Valven mit Kugelschnellverschluss, rostfrei  
for adults, with 2 pairs of interchangeable blades with ball snap system, stainless steel  
pour adultes, avec 2 paires de valves interchangeables fermeture à boules, inoxydable  
para adultos, con 2 pares de valvas intercambiables fijación con bolas, inoxidable  
per adulti, con 2 paia di valve intercambiabili, inossidabile

	a	b
<b>tk 24819-01</b>	45 mm	68 mm
<b>tk 24819-02</b>	70 mm	75 mm

Valven-Paar, rostfrei

Pair of blades, stainless steel

Paire de valves, acier inoxydable

Par de valvas, acero inoxidable

Paia di valve, acciaio inossidabile



**I.M.A. Thoraxsperrer**  
*Thoracic and I.M.A. retractor*

Ecarteur thoracique et I.M.A.  
*Separador torácico e I.M.A.*  
Divaricatore per il torace ed I.M.A.

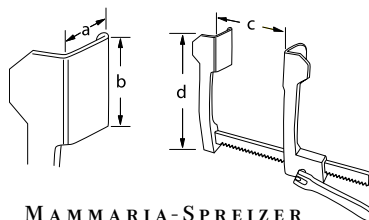

**MAMMARIA-SPREIZER**

	a	b	c	d
<b>tk 24821-00</b>	55 mm	100 mm	170 mm	130 mm

mit abnehmbarer Kippvalve und Stellschraube zum Anheben der Brustwand bei der Mammaria-Dissektion, rostfrei

*with detachable tilting IMA-blade and set-screw to lift the sternal margin for the dissection of the IMA, stainless steel*

avec valve mobile, démontable, écrou pour soulever le thorax pendant des dissections IMA, inoxydable

*con valva móvil y desmontable, rosca para levantar el tórax durante la dissection IMA, inoxidable*

con valve smontabili e vite di fissaggio per alzare lo sterno per dissezione IMA, inossidabile

1:2

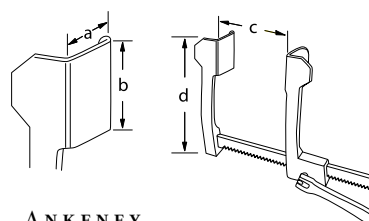

**ANKENEY**

	a	b	c	d
<b>tk 24829-30</b>	33 mm	35 mm	180 mm	300 mm

Valven abnehmbar mit Fadenfänger, rostfrei

*Detachable blades with suture catcher, stainless steel*

Valves démontables avec porte-fils, inoxydable

*Valvas desmontables con captador de hilos, inoxidable*

Valve smontabili con porta legature, inossidabile

Rippensperrer  
Rib retractors

Ecarteurs des côtes  
Separadores costales  
Divaricatori costali

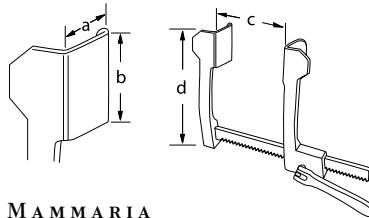

MAMMARIA

	a	b	c	d
<b>tk 24823-00</b>	30 mm	120 mm	215 mm	140 mm
	30 mm	50 mm		

**Mammaria Sperrer, komplett mit 2 Valven, rostfrei**  
*Mammaria retractor, complete with 2 pairs of valves, stainless steel*

Ecarteurs à mammaria, complet avec 2 paires de valves, inoxydable  
*Seperadores mammaria, completo con 2 pares de valvas, inoxidable*  
Divaricatori per mammaria, completo con 2 paia di valve, inossidabile

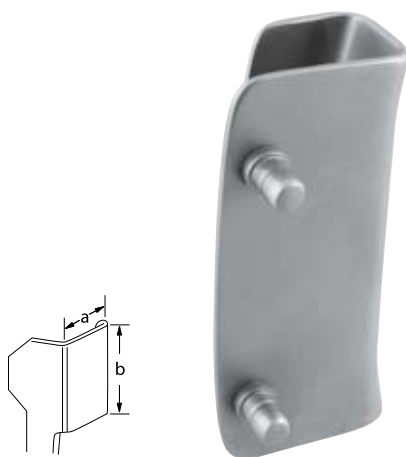

	a	b
<b>tk 24823-02</b>	30 mm	100 mm
<b>tk 24823-03</b>	40 mm	100 mm

**Sternumvalve**  
*Sternum blades*  
Valve pour le sternum  
*Valva sternal*  
Valva sternale

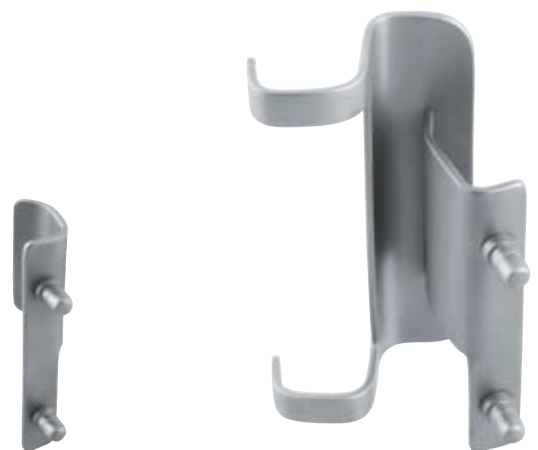

<b>tk 24823-01</b>	a = 30 mm	a = 30 mm
	b = 50 mm	b = 120 mm

**Mammariavalle, komplett mit Aufnahmeblatt links und rechts**  
*Mammaria blade, complete with holding blades left and right*

Valve mammaria complete avec valves droite et gauche  
*Valva mamaria completa con valvas izquierda y derecha*  
Valva completa per mammaria con valve sinistra e destra

**Lungenspatel**  
*Lung spatula*

Spatules pulmonaires  
*Espátulas pulmonares*  
Spatole polmonare



**ALLISON**

300 mm - 12"	<b>tk 24825-30</b>
320 mm - 12½"	<b>tk 24825-32</b>

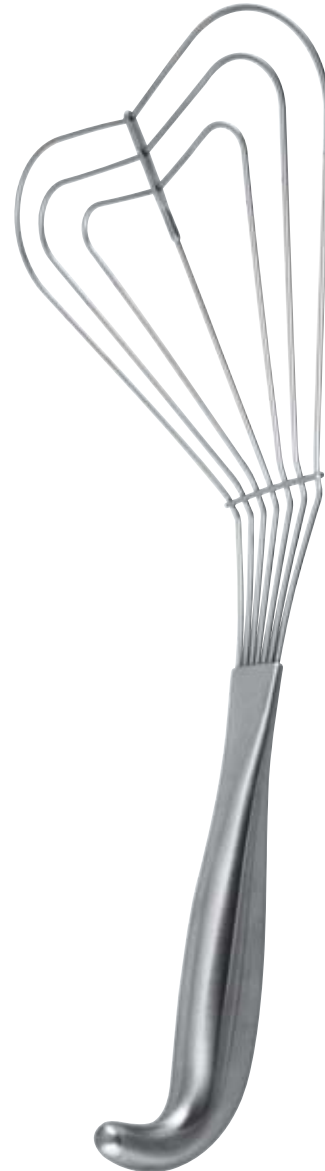

**ALLISON**

260 mm - 10¼"	<b>tk 24825-26</b>
310 mm - 12¼"	<b>tk 24825-31</b>

**Rippenkontraktoren**  
*Rib contractors*

Rapprocheurs des côtes  
*Aproximadores para costillas*  
Approssimatori costali



**BAILEY-BABY** 1:2  
140 mm - 5½" **tk24831-14**



**BAILEY** 1:2  
160 mm - 6¼" **tk 24830-16**



**BAILEY-GIBBON** 1:2  
160 mm - 6¼" **tk24833-16**



**LEMMON**  
145 mm - 5¾" **tk24835-14**  
180 mm - 7" **tk24835-18**



**SELLORS** 1:2  
190 mm - 7½" **tk 24837-19**



**CRAFOORD** 1:2  
260 mm - 10¼" **tk24829-26**

**Draht-Instrumentarium**  
*Wire instruments*

Instruments pour cerclage  
*Instrumental para cerclaje*  
Strumenti per filo di cerchiaggio



<b>DEMEL</b>	1:2
	280 mm - 11"
x = 32 mm	<b>tk 38517-01</b>
x = 45 mm	<b>tk 38517-02</b>
x = 62 mm	<b>tk 38517-03</b>



<b>DEMEL</b>	1:2
	280 mm - 11"
	<b>tk 38518-28</b>

Draht-Instrumentarium  
Wire instruments

Instruments pour cerclage  
Instrumental para cerclaje  
Strumenti per filo di cerchiaggio



LOUTE

210 mm - 8 1/4"

tk 38520-21

1:2



130 mm - 5"

tk 38532-13

1:2



0.2 mm Ø	tk 38550-02
0.3 mm Ø	tk 38550-03
0.4 mm Ø	tk 38550-04
0.5 mm Ø	tk 38550-05
0.6 mm Ø	tk 38550-06
0.7 mm Ø	tk 38550-07
0.8 mm Ø	tk 38550-08
0.9 mm Ø	tk 38550-09
1.0 mm Ø	tk 38550-10
1.2 mm Ø	tk 38550-12
1.5 mm Ø	tk 38550-15

Knochendraht, weich, in Ringen à 10 m

Bone wire, soft, in coils of 10 m

Fil de cerclage, souple, de 10 m

Alambre de cerclaje, blando, de 10 m

Filo per ossa, morbida, anelli da 10 m



0.8 mm Ø x 280 mm	tk 38552-08
1.0 mm Ø x 280 mm	tk 38552-10
1.2 mm Ø x 280 mm	tk 38552-12
1.0 mm Ø x 600 mm	tk 38553-10
1.2 mm Ø x 600 mm	tk 38553-12

Knochendraht mit Auge, weich, Packung à 10 Stück

Bone wire with eye, soft, package of 10 pieces

Fil de cerclage, souple, paquet de 10 pièces

Alambre de cerclaje, blando, paquete de 10 piezas

Filo per ossa con ansa, morbida, pacchetto di 10 pezzi

**Drahtschneidezangen**  
**Wire cutting forceps**

Pinces coupantes  
Alicates para cortar alambre  
Pinze taglia filo



220 mm - 8 3/4" **tk38561-22 tucar**

für harte Drähte bis 2.2 mm Ø, für weiche Drähte bis 3 mm Ø  
for hard wires up to 2.2 mm Ø, for soft wires up to 3 mm Ø  
pour fils durs à diam. 2.2 mm Ø, pour fils souples à 3 mm Ø  
para alambres duros hasta 2.2 mm Ø, y alambres blandos de 3 mm Ø  
per fili duri fina 2.2 mm Ø, per fili morbidi fino a 3 mm Ø



220 mm - 8 3/4" **tk38554-22 tucar**

für harte Drähte bis 2.2 mm Ø, für weiche Drähte bis 2.8 mm Ø  
for hard wires up to 2.2 mm Ø, for soft wires up to 2.8 mm Ø  
pour fils durs à 2.2 mm Ø, pour fils souples à 2.8 mm Ø  
para alambres duros hasta 2.2 mm Ø, y alambres blandos de 2.8 mm Ø  
per fili duri fina 2.2 mm Ø, per fili morbidi fino a 2.8 mm Ø



230 mm - 9" **tk38554-23 tucar**

für harte Drähte bis 2.2 mm Ø, für weiche Drähte bis 3 mm Ø  
for hard wires up to 2.2 mm Ø, for soft wires up to 3 mm Ø  
pour fils durs à 2.2 mm Ø, pour fils souples à 3 mm Ø  
para alambres duros hasta 2.2 mm Ø, y alambres blandos de 3 mm Ø  
per fili duri fina 2.2 mm Ø, per fili morbidi fino a 3 mm Ø

Drahtschneidezangen  
Wire cutting forceps

Pinces coupantes  
Alicates para cortar alambre  
Pinze taglia filo

TUCARTK



180 mm - 7"

tk38555-18 tucart

für harte Drähte bis 1.5 mm Ø, für weiche Drähte bis 2 mm Ø  
for hard wires up to 1.5 mm Ø, for soft wires up to 2 mm Ø  
pour fils durs à 1.5 mm Ø, pour fils souples à 2 mm Ø  
para alambres duros hasta 1.5 mm Ø, y alambres blandos de 2 mm Ø  
per fili duri fina 1.5 mm Ø, per fili duri morbidi fino a 2 mm Ø



180 mm - 7"

tk38557-18 tucart

für harte Drähte bis 1.7 mm Ø, für weiche Drähte bis 2 mm Ø  
for hard wires up to 1.7 mm Ø, for soft wires up to 2 mm Ø  
pour fils durs à 1.7 mm Ø, pour fils souples à 2 mm Ø  
para alambres duros hasta 1.7 mm Ø, y alambres blandos de 2 mm Ø  
per fili fina 1.7 mm Ø, per fili morbidi fino a 2 mm Ø



150 mm - 6"

tk38556-15 tucart

für harte Drähte bis 1 mm Ø, für weiche Drähte bis 1.5 mm Ø  
for hard wires up to 1 mm Ø, for soft wires up to 1.5 mm Ø  
pour fils durs à 1 mm Ø, pour fils souples à 1.5 mm Ø  
para alambres duros hasta 1 mm Ø, y alambres blandos de 1.5 mm Ø  
per fili duri fina 1 mm Ø, per fili morbidi fino a 1.5 mm Ø



145 mm - 5<sup>3</sup>/<sub>4</sub>"

tk38561-14 tucart

für harte Drähte bis 1 mm Ø  
for hard wires up to 1 mm Ø  
pour fils durs à 1 mm Ø  
para alambres duros hasta 1 mm Ø  
per fili duri fino a 1 mm Ø



Technische Zangen | Pincés técnicas  
 Technical forceps | Pinzas técnicas  
 Pinze tecniche



130 mm - 5"	<b>tk 38562-13</b>
180 mm - 7"	<b>tk 38562-18</b>



140 mm - 5½"	<b>tk 38563-14</b>
170 mm - 6¾"	<b>tk 38563-17</b>



	180 mm - 7"	180 mm - 7"
x = 5 mm	<b>tk 38564-05</b>	<b>tk 38571-05 tucar</b>
x = 7 mm	<b>tk 38564-07</b>	<b>tk 38571-07 tucar</b>



Nummernverzeichnis  
Numerical index

Index numériques  
Indice numerico

Indice dei numeri d'articolo

tk 6251-01 ..... 10	tk 7210-24T ..... 13	tk 8329-14 TC ..... 40	tk 8349-23 TC ..... 40	tk 8371-20 TC ..... 42	tk 8603-18 SU ..... 45
tk 6251-02 ..... 10	tk 8122-16 ..... 38	tk 8333-11 ..... 41	tk 8352-18 ..... 43	tk 8371-23 TC ..... 42	tk 8652-09 ..... 44
tk 6251-03 ..... 10	tk 8122-16 SU ..... 38	tk 8333-11-A ..... 19	tk 8352-18 SU ..... 43	tk 8372-14 ..... 42	tk 8652-10 ..... 44
tk 6251-04 ..... 10	tk 8122-21 ..... 38	tk 8333-11-B ..... 19	tk 8353-15 ..... 41	tk 8372-14 SU ..... 42	tk 8652-10 SU ..... 44
tk 6252-01 ..... 10	tk 8123-16 ..... 38	tk 8333-11-C ..... 19	tk 8353-15-A ..... 18	tk 8373-14 ..... 42	tk 8652-11 ..... 44
tk 6252-02 ..... 10	tk 8123-16-A ..... 20	tk 8333-11-D ..... 19	tk 8353-15-B ..... 18	tk 8373-14-A ..... 19	tk 8653-09 ..... 44
tk 6252-03 ..... 10	tk 8123-16-B ..... 20	tk 8333-11-E ..... 19	tk 8353-18 ..... 41	tk 8373-14-B ..... 19	tk 8653-10 ..... 44
tk 6253-01 ..... 10	tk 8123-16-C ..... 20	tk 8333-14 ..... 41	tk 8353-18-A ..... 18	tk 8373-14-C ..... 19	tk 8653-10 SU ..... 44
tk 6253-02 ..... 10	tk 8123-16-D ..... 20	tk 8333-14-A ..... 18	tk 8353-18-B ..... 18	tk 8373-14-E ..... 19	tk 8653-11 ..... 44
tk 6253-03 ..... 10	tk 8123-16-E ..... 20	tk 8333-14-B ..... 18	tk 8353-18-C ..... 18	tk 8373-14 SU ..... 42	tk 8692-14 ..... 46
tk 6254-01 ..... 10	tk 8123-16 SU ..... 38	tk 8333-14-C ..... 18	tk 8353-18-E ..... 18	tk 8374-14 ..... 42	tk 8693-14 ..... 46
tk 6254-02 ..... 10	tk 8123-21 ..... 38	tk 8333-14-E ..... 18	tk 8353-18 SU ..... 41	tk 8375-14 ..... 42	tk 8693-14-A ..... 22
tk 6254-03 ..... 10	tk 8125-16-C ..... 20	tk 8333-14 SU ..... 41	tk 8353-20 ..... 41	tk 8380-18 ..... 42	tk 8693-14-B ..... 22
tk 6255-01 ..... 10	tk 8125-16-D ..... 20	tk 8334-14 ..... 41	tk 8353-20-A ..... 18	tk 8380-18 SU ..... 42	tk 8697-12 ..... 45
tk 6255-02 ..... 10	tk 8125-16-E ..... 20	tk 8335-14 ..... 41	tk 8353-20-B ..... 18	tk 8380-20 ..... 42	tk 8697-12 SU ..... 45
tk 6255-03 ..... 10	tk 8138-16 TC ..... 38	tk 8337-11 TC ..... 41	tk 8353-20-C ..... 18	tk 8380-20 SU ..... 42	tk 8697-15 ..... 45
tk 6255-04 ..... 10	tk 8139-16 TC ..... 38	tk 8337-14 TC ..... 41	tk 8353-20-E ..... 18	tk 8380-23 ..... 42	tk 8697-15 SU ..... 45
tk 6291-35 ..... 7	tk 8193-14 TC ..... 39	tk 8338-14 TC ..... 41	tk 8353-20 SU ..... 41	tk 8380-23 SU ..... 42	tk 8697-18 SU ..... 45
tk 6292-31 ..... 7	tk 8197-14 SU TC ..... 39	tk 8339-14 TC ..... 41	tk 8353-23 ..... 41	tk 8381-18 ..... 42	tk 8697-20 SU ..... 45
tk 6293-30 ..... 7	tk 8198-14 ..... 39	tk 8343-15 ..... 40	tk 8353-23-A ..... 18	tk 8381-18-A ..... 19	tk 8698-12 TC ..... 45
tk 6294-33 ..... 7	tk 8198-14 SU ..... 39	tk 8343-18 ..... 40	tk 8353-23-B ..... 18	tk 8381-18-B ..... 19	tk 8698-15 TC ..... 45
tk 6295-01 ..... 8	tk 8272-14 ..... 37	tk 8343-18-A ..... 18	tk 8353-23-C ..... 18	tk 8381-18-C ..... 19	tk 8702-20 ..... 46
tk 6295-02 ..... 8	tk 8272-14 SU ..... 37	tk 8343-18-B ..... 18	tk 8353-23-E ..... 18	tk 8381-18-D ..... 19	tk 8702-23 ..... 46
tk 6295-03 ..... 8	tk 8272-15 ..... 37	tk 8343-18-C ..... 18	tk 8353-23 SU ..... 41	tk 8381-18-E ..... 19	tk 8703-20 ..... 46
tk 6296-00 ..... 8	tk 8272-15 SU ..... 37	tk 8343-18-E ..... 18	tk 8353-25 ..... 41	tk 8381-18 SU ..... 42	tk 8703-23 ..... 46
tk 6308-22 ..... 6	tk 8272-17 ..... 37	tk 8343-18 SU ..... 40	tk 8353-25-E ..... 18	tk 8381-20 ..... 42	tk 8704-18 SU ..... 46
tk 6310-22 ..... 6	tk 8272-17 SU ..... 37	tk 8343-20 ..... 40	tk 8353-28 ..... 41	tk 8381-20-A ..... 19	tk 8704-23 SU ..... 46
tk 6320-23 ..... 6	tk 8272-23 ..... 37	tk 8343-20-A ..... 18	tk 8353-30 ..... 41	tk 8381-20-B ..... 19	tk 8705-18 SU ..... 46
tk 6325-27 ..... 6	tk 8272-23 SU ..... 37	tk 8343-20-B ..... 18	tk 8354-18 ..... 41	tk 8381-20-C ..... 19	tk 8705-23 SU ..... 46
tk 6350-02 ..... 6	tk 8273-14 ..... 37	tk 8343-20-C ..... 18	tk 8354-20 ..... 41	tk 8381-20-E ..... 19	tk 8722-14 ..... 26
tk 6350-27 ..... 6	tk 8273-14 SU ..... 37	tk 8343-20-E ..... 18	tk 8354-23 ..... 41	tk 8381-20 SU ..... 42	tk 8724-17 ..... 26
tk 7100-04 ..... 11	tk 8273-15 ..... 37	tk 8343-20 SU ..... 40	tk 8354-25 ..... 41	tk 8381-23 ..... 42	tk 8725-17 ..... 26
tk 7101-04 ..... 11	tk 8273-15 SU ..... 37	tk 8343-23 ..... 40	tk 8354-28 ..... 41	tk 8381-23 SU ..... 42	tk 8727-11 ..... 26
tk 7102-04 ..... 11	tk 8273-17 ..... 37	tk 8343-23 SU ..... 40	tk 8354-30 ..... 41	tk 8462-16 ..... 38	tk 8728-18 ..... 30
tk 7105-08 ..... 11	tk 8273-17 SU ..... 37	tk 8343-25 ..... 40	tk 8356-18 ..... 41	tk 8462-18 ..... 38	tk 8728-21 ..... 30
tk 7110-03 ..... 12	tk 8273-23 ..... 37	tk 8343-28 ..... 40	tk 8356-20 ..... 41	tk 8463-13-A ..... 23	tk 8728-24 ..... 30
tk 7110-07 ..... 12	tk 8273-23 SU ..... 37	tk 8343-30 ..... 40	tk 8356-23 ..... 41	tk 8463-13-B ..... 23	tk 8730-17 ..... 26
tk 7110-71 ..... 12	tk 8278-14 TC ..... 37	tk 8344-18 ..... 40	tk 8356-25 ..... 41	tk 8463-16 ..... 38	tk 8732-19 ..... 26
tk 7111-03 ..... 12	tk 8278-17 TC ..... 37	tk 8344-20 ..... 40	tk 8356-28 ..... 41	tk 8463-16-A ..... 22	tk 8740-15 ..... 27
tk 7112-03 ..... 12	tk 8278-23 TC ..... 37	tk 8344-23 ..... 40	tk 8356-30 ..... 41	tk 8463-16-B ..... 22	tk 8741-15 ..... 27
tk 7113-03 ..... 11	tk 8279-14 TC ..... 37	tk 8344-25 ..... 40	tk 8357-18 TC ..... 41	tk 8463-16-C ..... 22	tk 8742-15 ..... 27
tk 7113-05 ..... 12	tk 8279-17 TC ..... 37	tk 8344-28 ..... 40	tk 8357-20 TC ..... 41	tk 8463-16-D ..... 22	tk 8744-22 ..... 27
tk 7115-03 ..... 12	tk 8279-23 TC ..... 37	tk 8344-30 ..... 40	tk 8357-23 TC ..... 41	tk 8463-16-E ..... 22	tk 8745-16 ..... 27
tk 7116-03 ..... 12	tk 8283-17-A ..... 21	tk 8345-18 ..... 40	tk 8357-25 TC ..... 41	tk 8463-18 ..... 38	tk 8745-23 ..... 27
tk 7120-13 ..... 14	tk 8283-17-B ..... 21	tk 8345-20 ..... 40	tk 8357-28 TC ..... 41	tk 8572-14 ..... 39	tk 8745-28 ..... 27
tk 7121-03 ..... 14	tk 8283-17-C ..... 21	tk 8345-23 ..... 40	tk 8357-30 TC ..... 41	tk 8573-14 ..... 39	tk 8746-16 ..... 27
tk 7121-04 ..... 14	tk 8283-17-D ..... 21	tk 8345-25 ..... 40	tk 8358-18 TC ..... 41	tk 8582-16 ..... 43	tk 8746-23 ..... 27
tk 7121-07 ..... 14	tk 8283-17-E ..... 21	tk 8345-28 ..... 40	tk 8358-20 TC ..... 41	tk 8587-16 ..... 43	tk 8746-28 ..... 27
tk 7121-09 ..... 14	tk 8323-11 ..... 40	tk 8345-30 ..... 40	tk 8358-23 TC ..... 41	tk 8592-12 ..... 43	tk 8747-16 ..... 27
tk 7210-10T ..... 13	tk 8323-14 ..... 40	tk 8347-18 TC ..... 40	tk 8359-18 TC ..... 41	tk 8597-12 ..... 43	tk 8747-19 ..... 33
tk 7210-11T ..... 13	tk 8323-14-A ..... 18	tk 8347-20 TC ..... 40	tk 8359-20 TC ..... 41	tk 8602-16 ..... 45	tk 8747-23 ..... 27
tk 7210-12DT ..... 13	tk 8323-14-B ..... 18	tk 8347-23 TC ..... 40	tk 8359-23 TC ..... 41	tk 8602-16 SU ..... 45	tk 8747-28 ..... 27
tk 7210-12T ..... 13	tk 8323-14-C ..... 18	tk 8347-25 TC ..... 40	tk 8363-14 TC ..... 42	tk 8602-18 ..... 45	tk 8752-19 ..... 33
tk 7210-15CT ..... 13	tk 8323-14-E ..... 18	tk 8347-28 TC ..... 40	tk 8365-14 TC ..... 42	tk 8602-18 SU ..... 45	tk 8753-19 ..... 33
tk 7210-15T ..... 13	tk 8323-14 SU ..... 40	tk 8347-30 TC ..... 40	tk 8366-14 TC ..... 42	tk 8603-14-A ..... 21	tk 8754-14 ..... 29
tk 7210-18T ..... 13	tk 8324-14 ..... 40	tk 8348-18 TC ..... 40	tk 8367-14 TC ..... 42	tk 8603-16 ..... 45	tk 8754-16 ..... 29
tk 7210-20T ..... 13	tk 8325-14 ..... 40	tk 8348-20 TC ..... 40	tk 8370-18 TC ..... 42	tk 8603-16-A ..... 21	tk 8754-19 ..... 29
tk 7210-21T ..... 13	tk 8327-11 TC ..... 40	tk 8348-23 TC ..... 40	tk 8370-20 TC ..... 42	tk 8603-16-E ..... 21	tk 8755-14 ..... 29
tk 7210-22T ..... 13	tk 8327-14 TC ..... 40	tk 8349-18 TC ..... 40	tk 8370-23 TC ..... 42	tk 8603-16 SU ..... 45	tk 8755-16 ..... 29
tk 7210-23T ..... 13	tk 8328-14 TC ..... 40	tk 8349-20 TC ..... 40	tk 8371-18 TC ..... 42	tk 8603-18 ..... 45	tk 8755-19 ..... 29

Nummernverzeichnis  
Numerical index

Index numériques  
Indice numerico

Indice dei numeri d'articolo

tk 8756-14.....29	tk 9482-11.....44	tk 11934-06.....78	tk 11950-12.....80	tk 11975-24.....51	tk 12039-13.....62
tk 8756-16.....29	tk 9482-11 SU.....44	tk 11934-07.....78	tk 11951-05.....80	tk 11976-16.....51	tk 12039-15.....62
tk 8756-19.....29	tk 9483-11.....44	tk 11934-08.....78	tk 11951-08.....80	tk 11976-20.....51	tk 12040-14.....63
tk 8757-14.....29	tk 9483-11 SU.....44	tk 11934-09.....78	tk 11951-09.....80	tk 11976-24.....51	tk 12040-14-P.....57
tk 8757-16.....29	tk 9718-17 TC.....36	tk 11934-10.....78	tk 11951-10.....80	tk 11977-14.....47	tk 12040-16.....63
tk 8757-19.....29	tk 9822-23.....202	tk 11934-11.....78	tk 11951-12.....80	tk 11977-20.....47	tk 12040-16-P.....57
tk 8758-14.....29	tk 9827-22.....202	tk 11934-12.....78	tk 11953-07.....82	tk 11977-25.....47	tk 12041-14.....63
tk 8758-16.....29	tk 9842-19.....202	tk 11935-00.....78	tk 11953-09.....82	tk 11977-30.....47	tk 12041-14-P.....57
tk 8758-19.....29	tk 9842-22.....202	tk 11935-05.....77	tk 11953-10.....82	tk 11978-15.....53	tk 12041-16.....63
tk 8762-24.....34	tk 9847-21.....202	tk 11935-06.....77	tk 11955-19.....73	tk 11978-20.....53	tk 12041-16-P.....57
tk 8767-23.....34	tk 10327-15.....52	tk 11935-07.....77	tk 11957-07.....82	tk 11978-24.....53	tk 12050-14.....63
tk 8769-22.....34	tk 10327-18.....52	tk 11940-08.....77	tk 11959-09.....82	tk 11979-15.....53	tk 12050-14-P.....57
tk 8771-12.....28	tk 10328-18.....52	tk 11940-12.....77	tk 11959-11.....82	tk 11979-20.....53	tk 12050-16.....63
tk 8771-25.....28	tk 10328-20.....52	tk 11940-16.....77	tk 11960-12.....50	tk 11979-24.....53	tk 12050-16-P.....57
tk 8771-45.....28	tk 10402-17.....47	tk 11940-20.....77	tk 11960-14.....50	tk 12000-10.....60	tk 12051-14.....63
tk 8771-60.....28	tk 10415-18.....47	tk 11941-08.....77	tk 11960-16.....50	tk 12000-10-P.....56	tk 12051-14-P.....57
tk 8772-12.....28	tk 10502-12.....47	tk 11941-12.....77	tk 11960-20.....50	tk 12001-10.....60	tk 12051-16.....63
tk 8772-25.....28	tk 10502-15.....47	tk 11941-16.....77	tk 11960-24.....50	tk 12001-10-P.....56	tk 12051-16-P.....57
tk 8772-45.....28	tk 10504-12.....48	tk 11941-20.....77	tk 11962-15.....53	tk 12006-08.....60	tk 12052-14.....63
tk 8772-60.....28	tk 10504-15.....48	tk 11942-08.....83	tk 11962-20.....53	tk 12010-12.....60	tk 12053-14.....63
tk 8772-90.....28	tk 10506-12.....48	tk 11942-09.....83	tk 11962-24.....53	tk 12010-12-P.....56	tk 12054-16.....63
tk 8773-25.....31	tk 10506-15.....48	tk 11942-10.....83	tk 11963-15.....53	tk 12010-14.....60	tk 12055-16.....63
tk 8773-45.....31	tk 10508-12.....48	tk 11942-12.....83	tk 11963-20.....53	tk 12010-14-P.....56	tk 12058-13-P.....58
tk 8773-60.....31	tk 10510-12.....52	tk 11943-07.....83	tk 11963-24.....53	tk 12011-12.....60	tk 12058-14-P.....58
tk 8774-12.....28	tk 10610-15.....47	tk 11943-08.....83	tk 11964-14.....50	tk 12011-12-P.....56	tk 12058-16-P.....58
tk 8774-25.....28	tk 10610-23.....47	tk 11943-09.....83	tk 11964-16.....50	tk 12011-14.....60	tk 12059-13-P.....58
tk 8774-45.....28	tk 11638-15.....48	tk 11943-11.....83	tk 11964-20.....50	tk 12011-14-P.....56	tk 12059-14-P.....58
tk 8774-60.....28	tk 11640-15.....47	tk 11944-06.....81	tk 11964-24.....50	tk 12012-12.....60	tk 12059-16-P.....58
tk 8774-90.....28	tk 11652-18.....47	tk 11944-07.....81	tk 11964-30.....50	tk 12012-12-P.....56	tk 12062-14-P.....59
tk 8775-16.....31	tk 11652-21.....47	tk 11944-09.....81	tk 11965-16.....50	tk 12012-14.....60	tk 12062-16-P.....59
tk 8775-23.....31	tk 11652-25.....47	tk 11944-11.....81	tk 11965-20.....50	tk 12012-14-P.....56	tk 12062-18-P.....59
tk 8775-28.....31	tk 11690-14.....48	tk 11945-05.....81	tk 11965-24.....50	tk 12013-12.....60	tk 12063-14-P.....59
tk 8776-16.....31	tk 11690-16.....48	tk 11945-06.....81	tk 11965-30.....50	tk 12013-12-P.....56	tk 12063-16-P.....59
tk 8776-23.....31	tk 11690-18.....48	tk 11945-07.....81	tk 11965-35.....50	tk 12013-14.....60	tk 12063-18-P.....59
tk 8776-28.....31	tk 11690-20.....48	tk 11945-09.....81	tk 11966-16.....50	tk 12013-14-P.....56	tk 12078-13-P.....58
tk 8777-16.....31	tk 11690-25.....48	tk 11945-11.....81	tk 11966-20.....50	tk 12020-10.....61	tk 12078-14-P.....58
tk 8777-23.....31	tk 11690-30.....48	tk 11946-38.....76	tk 11966-24.....50	tk 12020-10-P.....56	tk 12078-16-P.....58
tk 8777-28.....31	tk 11930-03.....77	tk 11946-50.....76	tk 11966-30.....50	tk 12020-12.....61	tk 12079-13-P.....58
tk 8859-17 TC.....36	tk 11930-05.....77	tk 11946-55.....76	tk 11967-14.....50	tk 12020-12-P.....56	tk 12079-14-P.....58
tk 8882-30.....32	tk 11930-06.....77	tk 11946-65.....76	tk 11967-16.....50	tk 12020-14.....61	tk 12079-16-P.....58
tk 8892-25.....32	tk 11931-03.....77	tk 11946-70.....76	tk 11967-20.....50	tk 12021-10.....61	tk 12082-14-P.....59
tk 8892-28.....32	tk 11931-05.....77	tk 11946-75.....76	tk 11967-24.....50	tk 12021-10-P.....56	tk 12082-16-P.....59
tk 8893-25.....32	tk 11931-06.....77	tk 11946-90.....76	tk 11967-30.....50	tk 12021-12.....61	tk 12082-18-P.....59
tk 8893-28.....32	tk 11933-01.....78	tk 11947-38.....76	tk 11968-15.....49	tk 12021-12-P.....56	tk 12083-14-P.....59
tk 8912-27.....32	tk 11933-02.....78	tk 11947-50.....76	tk 11968-19.....49	tk 12021-14.....61	tk 12083-16-P.....59
tk 8939-25.....32	tk 11933-03.....78	tk 11947-55.....76	tk 11968-24.....49	tk 12022-10.....61	tk 12083-18-P.....59
tk 9193-14 TC.....39	tk 11933-04.....78	tk 11947-65.....76	tk 11969-15.....49	tk 12022-10-P.....56	tk 12110-12.....60
tk 9197-14 SU TC.....39	tk 11933-05.....78	tk 11947-70.....76	tk 11969-19.....49	tk 12022-12.....61	tk 12111-12.....60
tk 9198-14.....39	tk 11933-06.....78	tk 11947-75.....76	tk 11969-24.....49	tk 12022-12-P.....56	tk 12112-12.....60
tk 9198-14 SU.....39	tk 11933-07.....78	tk 11947-90.....76	tk 11970-16.....51	tk 12023-10.....61	tk 12113-12.....60
tk 9222-01.....130	tk 11933-08.....78	tk 11948-23.....76	tk 11970-20.....51	tk 12023-10-P.....56	tk 12140-14.....63
tk 9222-02.....130	tk 11933-09.....78	tk 11949-01.....79	tk 11970-24.....51	tk 12023-12.....61	tk 12141-14.....63
tk 9222-03.....130	tk 11933-10.....78	tk 11949-02.....79	tk 11971-16.....51	tk 12023-12-P.....56	tk 12195-15.....62
tk 9223-01.....130	tk 11933-11.....78	tk 11949-03.....79	tk 11971-20.....51	tk 12030-14.....61	tk 12196-15.....62
tk 9223-02.....130	tk 11933-12.....78	tk 11949-04.....79	tk 11971-24.....51	tk 12031-12.....61	tk 12235-01.....66
tk 9223-03.....130	tk 11934-01.....78	tk 11949-05.....79	tk 11972-16.....51	tk 12032-14.....61	tk 12235-02.....66
tk 9352-11.....35	tk 11934-02.....78	tk 11949-06.....79	tk 11972-20.....51	tk 12034-15.....62	tk 12235-03.....66
tk 9357-11.....35	tk 11934-03.....78	tk 11950-08.....80	tk 11972-24.....51	tk 12035-15.....62	tk 12235-04.....66
tk 9434-11-B.....23	tk 11934-04.....78	tk 11950-09.....80	tk 11975-16.....51	tk 12036-15.....62	tk 12235-21.....66
tk 9434-11-C.....23	tk 11934-05.....78	tk 11950-10.....80	tk 11975-20.....51	tk 12037-15.....62	tk 12238-28.....66





**Nummernverzeichnis**  
*Numerical index*

**Index numériques**  
*Indice numerico*

**Indice dei numeri d'articolo**

tk 24844-10.....183	tk 25060-03.....143	tk 25076-50.....145	tk 25652-13.....138	tk 25723-05.....147	tk 28280-18.....73
tk 24844-15.....183	tk 25060-04.....143	tk 25076-51.....145	tk 25653-13.....138	tk 25724-01.....147	tk 28280-18-P.....55
tk 24844-20.....183	tk 25061-01.....143	tk 25077-01.....146	tk 25654-12.....138	tk 25724-02.....147	tk 28280-20.....73
tk 24844-25.....183	tk 25061-02.....143	tk 25077-50.....146	tk 25655-12.....138	tk 25724-03.....147	tk 28280-20-P.....55
tk 24844-30.....183	tk 25061-03.....143	tk 25209-01.....144	tk 25656-12.....138	tk 25724-04.....147	tk 28280-24.....73
tk 24844-40.....183	tk 25061-04.....143	tk 25209-02.....144	tk 25657-12.....138	tk 25725-01.....148	tk 28285-16.....73
tk 24844-50.....183	tk 25062-01.....143	tk 25210-00.....144	tk 25658-13.....138	tk 25725-02.....148	tk 28285-20.....73
tk 24845-32.....180	tk 25062-02.....143	tk 25211-00.....144	tk 25659-13.....138	tk 25725-03.....148	tk 28290-18.....74
tk 24845-64.....180	tk 25062-03.....143	tk 25212-00.....144	tk 25662-13.....138	tk 25725-04.....148	tk 28290-20.....74
tk 24846-00.....187	tk 25062-04.....143	tk 25213-00.....144	tk 25663-13.....138	tk 25726-01.....148	tk 28290-23.....74
tk 24846-01.....188	tk 25063-01.....143	tk 25214-00.....144	tk 25664-18.....138	tk 25726-02.....148	tk 28292-20.....74
tk 24846-02.....188	tk 25063-02.....143	tk 25215-00.....144	tk 25665-18.....138	tk 25726-03.....148	tk 28292-23.....74
tk 24846-03.....188	tk 25063-03.....143	tk 25216-00.....144	tk 25666-18.....138	tk 25726-04.....148	tk 28293-20.....74
tk 24846-04.....189	tk 25063-04.....143	tk 25217-00.....144	tk 25667-18.....138	tk 25754-12.....132	tk 34250-10.....185
tk 24846-05.....188	tk 25064-01.....143	tk 25228-06.....9	tk 25668-18.....138	tk 25754-25.....132	tk 34250-15.....185
tk 24846-06.....188	tk 25064-02.....143	tk 25228-07.....9	tk 25669-18.....138	tk 25754-45.....132	tk 34250-20.....185
tk 24846-07.....188	tk 25064-03.....143	tk 25228-08.....9	tk 25670-18.....138	tk 25754-60.....132	tk 34250-25.....185
tk 24846-08.....188	tk 25064-04.....143	tk 25228-09.....9	tk 25671-18.....138	tk 25754-90.....132	tk 34250-30.....185
tk 24846-10.....188	tk 25065-01.....143	tk 25228-10.....9	tk 25685-07.....139	tk 25755-12.....132	tk 34250-35.....185
tk 24846-12.....188	tk 25065-02.....143	tk 25228-12.....9	tk 25685-08.....139	tk 25755-25.....132	tk 34250-40.....185
tk 24846-15.....189	tk 25065-03.....143	tk 25228-15.....9	tk 25685-09.....139	tk 25755-45.....132	tk 34250-45.....185
tk 24846-16.....189	tk 25065-04.....143	tk 25230-06.....9	tk 25685-10.....139	tk 25755-60.....132	tk 34250-50.....185
tk 24846-17.....189	tk 25066-01.....149	tk 25230-07.....9	tk 25690-01.....136	tk 25755-90.....132	tk 34250-55.....185
tk 24846-20.....189	tk 25066-02.....149	tk 25230-08.....9	tk 25690-02.....136	tk 25756-12.....135	tk 34250-60.....185
tk 24847-00.....184	tk 25066-03.....149	tk 25230-09.....9	tk 25690-03.....136	tk 25756-25.....135	tk 34250-65.....185
tk 24847-02.....190	tk 25066-04.....149	tk 25230-10.....9	tk 25690-04.....136	tk 25756-45.....135	tk 34250-70.....185
tk 24847-03.....190	tk 25066-05.....149	tk 25230-12.....9	tk 25690-05.....136	tk 25756-60.....135	tk 34250-75.....185
tk 24847-04.....190	tk 25066-06.....149	tk 25230-15.....9	tk 25690-06.....136	tk 25756-90.....135	tk 34250-80.....185
tk 24847-05.....184	tk 25066-07.....149	tk 25277-02.....146	tk 25690-07.....136	tk 25757-12.....135	tk 34250-85.....185
tk 24847-06.....190	tk 25066-08.....149	tk 25277-03.....146	tk 25690-08.....136	tk 25757-25.....135	tk 34250-90.....185
tk 24847-10.....184	tk 25066-09.....149	tk 25277-04.....146	tk 25690-09.....136	tk 25757-45.....135	tk 34250-95.....185
tk 24847-14.....151	tk 25066-10.....149	tk 25500-18.....131	tk 25690-10.....136	tk 25757-60.....135	tk 34251-00.....185
tk 24847-15.....184	tk 25070-01.....143	tk 25501-18.....131	tk 25690-11.....136	tk 25757-90.....135	tk 34251-05.....185
tk 24847-20.....184	tk 25070-02.....143	tk 25502-18.....131	tk 25690-12.....136	tk 25758-12.....134	tk 34251-10.....185
tk 24847-25.....184	tk 25070-03.....143	tk 25602-01.....133	tk 25690-13.....136	tk 25758-25.....134	tk 34251-15.....185
tk 24847-30.....184	tk 25070-04.....143	tk 25602-02.....133	tk 25690-14.....136	tk 25758-45.....134	tk 34251-20.....185
tk 24847-35.....184	tk 25071-01.....143	tk 25602-03.....133	tk 25690-15.....136	tk 25758-60.....134	tk 34251-25.....185
tk 24847-40.....184	tk 25071-02.....143	tk 25602-04.....133	tk 25690-16.....136	tk 25758-90.....134	tk 34251-30.....185
tk 24847-45.....184	tk 25071-03.....143	tk 25603-01.....133	tk 25695-01.....137	tk 25759-12.....134	tk 34251-35.....185
tk 24847-50.....184	tk 25071-04.....143	tk 25603-02.....133	tk 25695-02.....137	tk 25759-25.....134	tk 34251-40.....185
tk 24847-70.....184	tk 25072-01.....143	tk 25603-03.....133	tk 25695-03.....137	tk 25759-45.....134	tk 34251-45.....185
tk 24847-90.....184	tk 25072-02.....143	tk 25603-04.....133	tk 25695-04.....137	tk 25759-60.....134	tk 34251-50.....185
tk 24848-00.....184	tk 25072-03.....143	tk 25610-01.....133	tk 25695-05.....137	tk 25759-90.....134	tk 34251-55.....185
tk 24848-05.....184	tk 25072-04.....143	tk 25610-02.....133	tk 25695-06.....137	tk 28100-14.....72	tk 34251-60.....185
tk 24848-10.....184	tk 25073-01.....143	tk 25610-03.....133	tk 25695-07.....137	tk 28140-15.....72	tk 34251-65.....185
tk 24848-15.....184	tk 25073-02.....143	tk 25610-04.....133	tk 25695-08.....137	tk 28140-15-P.....55	tk 34251-70.....185
tk 24848-20.....184	tk 25073-03.....143	tk 25611-01.....133	tk 25695-09.....137	tk 28160-15.....72	tk 34251-75.....185
tk 24848-25.....184	tk 25073-04.....143	tk 25611-02.....133	tk 25695-10.....137	tk 28160-15-P.....55	tk 34251-80.....185
tk 24848-30.....184	tk 25074-01.....143	tk 25611-03.....133	tk 25695-11.....137	tk 28160-19.....72	tk 34251-85.....185
tk 24848-35.....184	tk 25074-02.....143	tk 25611-04.....133	tk 25695-12.....137	tk 28160-19-P.....55	tk 34251-90.....185
tk 24848-40.....184	tk 25074-03.....143	tk 25635-11.....138	tk 25695-13.....137	tk 28160-25.....72	tk 34251-95.....185
tk 24848-45.....184	tk 25074-04.....143	tk 25636-11.....138	tk 25695-14.....137	tk 28167-15.....72	tk 34252-10.....185
tk 24848-50.....184	tk 25075-01.....143	tk 25637-11.....138	tk 25695-15.....137	tk 28180-20.....72	tk 34252-20.....185
tk 24848-70.....184	tk 25075-02.....143	tk 25638-11.....138	tk 25695-16.....137	tk 28190-20.....72	tk 34252-30.....185
tk 24848-90.....184	tk 25075-03.....143	tk 25640-15.....138	tk 25720-13.....147	tk 28192-16.....72	tk 34252-40.....185
tk 25059-01.....142	tk 25075-04.....143	tk 25641-15.....138	tk 25722-18.....147	tk 28210-15.....73	tk 34252-50.....185
tk 25059-02.....142	tk 25076-01.....145	tk 25642-15.....138	tk 25723-01.....147	tk 28250-15.....73	tk 34252-60.....185
tk 25059-03.....142	tk 25076-02.....145	tk 25643-15.....138	tk 25723-02.....147	tk 28250-19.....73	tk 34252-70.....185
tk 25060-01.....143	tk 25076-03.....145	tk 25645-13.....138	tk 25723-03.....147	tk 28280-16.....73	tk 34252-80.....185
tk 25060-02.....143	tk 25076-04.....145	tk 25646-13.....138	tk 25723-04.....147	tk 28280-16-P.....55	

Nummernverzeichnis  
Numerical index

Index numériques  
Indice numerico  
Indice dei numeri d'articolo

tk 34252-90.....	185	tk 85102-03 .....	140
tk 34253-00.....	185	tk 85103-01 .....	140
tk 34262-02.....	185	tk 85103-03 .....	140
tk 34262-04.....	185	tk 85104-01 .....	140
tk 34262-06.....	185	tk 85104-03 .....	140
tk 34262-08.....	185		
tk 34262-10.....	185		
tk 34262-12.....	185		
tk 34262-14.....	185		
tk 34262-16.....	185		
tk 34262-18.....	185		
tk 34262-20.....	185		
tk 34262-22.....	185		
tk 34262-24.....	185		
tk 34262-26.....	185		
tk 38517-01.....	227		
tk 38517-02 .....	227		
tk 38517-03 .....	227		
tk 38518-28 .....	227		
tk 38520-21 .....	228		
tk 38532-13.....	228		
tk 38550-02.....	228		
tk 38550-03.....	228		
tk 38550-04.....	228		
tk 38550-05.....	228		
tk 38550-06.....	228		
tk 38550-07.....	228		
tk 38550-08.....	228		
tk 38550-09.....	228		
tk 38550-10.....	228		
tk 38550-12.....	228		
tk 38550-15.....	228		
tk 38552-08.....	228		
tk 38552-10.....	228		
tk 38552-12.....	228		
tk 38553-10.....	228		
tk 38553-12.....	228		
tk 38554-22 tucar ...	229		
tk 38554-23 tucar ...	229		
tk 38555-18 tucar ...	230		
tk 38556-15 tucar ...	230		
tk 38557-18 tucar ...	230		
tk 38561-14 tucar....	230		
tk 38561-22 tucar ...	229		
tk 38562-13.....	231		
tk 38562-18.....	231		
tk 38563-14.....	231		
tk 38563-17.....	231		
tk 38564-05.....	231		
tk 38564-07.....	231		
tk 38571-05 tucar ...	231		
tk 38571-07 tucar....	231		
tk 52715-01.....	155		
tk 52715-02 .....	155		
tk 52715-03 .....	155		
tk 85100-01 .....	140		
tk 85100-03 .....	140		
tk 85101-01.....	140		
tk 85101-03 .....	140		
tk 85102-01 .....	140		

**Inhaltsverzeichnis  
Index**
**Tables de matières  
Indice  
Indice**

<b>A</b>	
Absaugaufsätze .....	10
ADSON Pinzetten .....	47, 48
ADSON Raspatorien .....	200
ADSON-BROWN Pinzette .....	48
ADSON-MIKRO Pinzetten .....	48
ALLIS Darmfasszangen .....	72
ALLIS Darmfasszangen <b>PRIMUSLINE</b> .....	55
ALLIS-ADAIR Darmfasszange .....	72
ALLIS-ATRAUMA Darmfasszangen .....	75
ALLIS-BABY Darmfasszange .....	72
ALLISON Lungenspatel .....	225
Anastomoseklemmen .....	97-100
Anatomische Pinzetten .....	47
ANDREWS-PYNCHON Saugrohr .....	6
Aneurysmenklemmen .....	107
ANKENEY Rippensperrerr .....	223
Anlegezange für Gefäßclips .....	142
Anlegezangen für Bulldogklemmen .....	78, 86
Aorta-Aneurysmenklemmen .....	105, 106
Aorta-Dilatatoren .....	186
Aortaklemmen .....	101-104
Aortastanzen .....	190
Approximatoren, Gefäßclips .....	143
Approximatoren, Gefäßclips nach Biemer .....	144
Approximatoren, Gefäßclips nach Müller .....	145
Arterienklemmen .....	56-63
Arterienklemmen <b>PRIMUSLINE</b> .....	56-59
Atraumatische Mikro-Pinzetten .....	136
Atraumatische Pinzetten .....	49-53
<b>B</b>	
BABCOCK Darmfasszangen .....	73
BABCOCK Darmfasszangen <b>PRIMUSLINE</b> .....	55
BABCOCK-ATRAUMA Darmfasszangen .....	75
BABY METZENBAUM Scheren <b>PRIMUSLINE</b> .....	19
BABY-CRILE-WOOD Nadelhalter .....	171
BABY-HAIGHT Rippensperrerr .....	214
BABY-SATINSKY Bronchusklemme .....	71
BAILEY Rippenkontraktor .....	226
BAILEY-BABY Rippenkontraktor .....	226
BAILEY-GIBBON Rippenkontraktor .....	226
BAINBRIDGE, LIGHT Gefäßklemmen .....	85
BARRON Skalpellgriff .....	11
BECK Anastomoseklemme .....	97
BETHUNE Rippenschere .....	204
BEYER Hohlmeißelzange .....	191
BIEMER Gefäßclips .....	144
BLALOCK Wundhaken .....	158
BÖHLER Knochensplitterzangen .....	196
BOROWSKI Wundhaken .....	168
BOYS-ALLIS Darmfasszange .....	73
BOZEMANN (WERTHEIM) Nadelhalter .....	174
BRIDGE Präparier- und Ligaturklemmen .....	66
BROCKS Wundhaken .....	158
BROMPTON Wundhaken .....	158
Bronchus- und Gefäßklemmen .....	69-71
Bronchusklemmen, atraumatisch .....	116
BROPHY (SULLIVAN) Scheren .....	39
BRUNNER Rippenscheren .....	203

Bulldogklemmen .....	76-83
Bulldogklemmen mit Ringgriff .....	120
BURFORD Rippensperrerr .....	207
<b>C</b>	
Carotis-Shuntklemmen .....	118
CASTAÑEDA Neonatalklemmen .....	121
CASTROVIEJO-JACOBSON Nadelhalter .....	179
Chirurgische Pinzetten .....	48
Chirurgische Scheren .....	37-39
Chirurgische Scheren - Präparierscheren .....	40-42
CHRISTOPHE Arterienklemmen .....	62
Coarctationsklemmen .....	117
COLLIN Skalpellgriff .....	11
CONVERSE Nadelhalter .....	173
COOLEY Anastomoseklemmen .....	100
COOLEY Aorta-Dilatator .....	186
COOLEY Bulldogklemmen .....	83
COOLEY Gefäßdilatoren .....	183
COOLEY Mehrzweck-Gefäßklemmen .....	92-96
COOLEY PATENT DUCTUS CLAMP .....	95
COOLEY Rippensperrerr .....	209-211
COOLEY Saugrohre .....	7
COOLEY Tangentialklemmen .....	109, 110
COOLEY Wundhaken .....	165-167
COOLEY-BECK Anastomoseklemmen .....	100
COOLEY-DERRA Anastomoseklemmen .....	99
CRAFOORD Lungenschere .....	32
CRAFOORD Rippenkontraktor .....	226
CRILE Arterienklemmen .....	63
CRILE Arterienklemmen <b>PRIMUSLINE</b> .....	57
CRILE-RANKIN Arterienklemmen .....	63
CRILE-RANKIN Arterienklemmen <b>PRIMUSLINE</b> .....	57
CRILE-WOOD Nadelhalter .....	171
CUSHING anatomische Pinzette .....	47
CUSHING Wundhaken .....	153
CZERNY Wundhaken .....	158
<b>D</b>	
DALE Peripheral-Gefäßklemmen .....	113
DANDY Arterienklemmen .....	61
DARDIK Mehrzweck-Gefäßklemmen .....	88
DAVIDSON Wundhaken .....	161
DE BAKEY Aorta-Aneurysmenklemmen .....	105, 106
DE BAKEY Aortaklemme .....	104
DE BAKEY atraumatische Pinzetten .....	49-51
DE BAKEY BAYONET atraumatische Pinzetten .....	52
DE BAKEY Bulldogklemmen .....	80
DE BAKEY Gefäßdilatoren .....	183
DE BAKEY Gefäßscheren .....	27, 31
DE BAKEY Kinder-Gefäßklemmen .....	124
DE BAKEY Ligaturklemmen .....	115
DE BAKEY Mehrzweck-Gefäßklemmen .....	85-87, 89
DE BAKEY Nadelhalter .....	176
DE BAKEY Präparier- und Ligaturklemmen .....	114
DE BAKEY Rippensperrerr .....	217, 220
DE BAKEY Saugrohr .....	6
DE BAKEY-ADSON atraumatische Pinzette .....	52
DE BAKEY-BAHNSON Aneurysmenklemmen .....	107
DE BAKEY-CAROTIS Bulldogklemme .....	82



## Inhaltsverzeichnis Index

## Tables de matières Indice Indice

DE BAKEY-DIETRICH Bulldogklemmen .....	79	<b>H</b>	
DE BAKEY-GERALD atraumatische Pinzetten .....	52	HALSEY Nadelhalter .....	172
DE BAKEY-SATINSKY Bulldogklemme .....	82	HALSTED-MOSQUITO Arterienklemmen.....	60
DE BAKEY-SEMB Ligaturklemmen.....	115	HALSTED-MOSQUITO Arterienklemmen <b>PRIMUSLINE</b> .....	56
DE BAKEY-WYLIE Peripheral-Gefäßklemmen.....	112	HAMMERSMITH Saugrohre .....	8
DE BOER (Sternal) Rippensperrer .....	216	HARRINGTON Wundhaken.....	159
DEAN Tonsillenschere .....	36	HARTMANN Arterienklemmen .....	60
DEMEL Drahtspannzange .....	227	HARTMANN Arterienklemmen <b>PRIMUSLINE</b> .....	56
DEMEL Umföhrungsnadel.....	227	HEANEY Nadelhalter .....	174
DERF (WRIGHT) Nadelhalter.....	172	HEGAR Gefäßdilatatoren .....	185
DERRA Anastomoseklemmen .....	97	HEGAR-BAUMGARTNER Nadelhalter .....	171
DESMARRES Wundhaken .....	152	HOHENFELLNER Gefäßscheren .....	30
DIEFFENBACH Bulldogklemmen.....	77	Hohlmeißelzangen .....	191-195
DIETRICH Aortaklemme.....	103	<b>I</b>	
DIETRICH Bulldogklemmen.....	77	I.M.A. Thoraxsperrer .....	223
DIETRICH Nadelhalter.....	177	Instrumenten-Kassetten aus Edelstahl .....	140
DIETRICH-HEGEMANN Gefäßscheren .....	29	Irisscheren <b>PRIMUSLINE</b> .....	23
Dissektoren .....	182	<b>J</b>	
Draht-Instrumentarium .....	227, 228	JAVID Carotis-Shuntklemmen .....	118
Drahtschneidezangen.....	229, 230	JOHNS-HOPKINS Bulldogklemmen .....	76, 77
DUVAL Darmfasszangen .....	74	JORGENSEN Thoraxschere .....	34
<b>F</b>		JOSEPH Schere <b>PRIMUSLINE</b> .....	22
FARABEUF Raspatorien.....	200	JOSEPH Scheren.....	46
FARABEUF-COLLIN Raspatorien .....	201	JUDD-ALLIS Darmfasszangen .....	73
FAVALORO Gefäßschere.....	27	<b>K</b>	
Feine Scheren – Irisscheren.....	43-44	KELLY Arterienklemmen .....	63
FERGUSSON Knochenhaltezange .....	198	KELLY Arterienklemmen <b>PRIMUSLINE</b> .....	57
FERGUSSON Saugrohre .....	9	KELLY Scheren .....	38
FINOCHIETTO Lungenschere .....	32	KELLY Scheren <b>PRIMUSLINE</b> .....	22
FINOCHIETTO Nadelhalter .....	175	KELLY-RANKIN Arterienklemmen .....	63
FINOCHIETTO Rippensperrer .....	208, 214, 215	KELLY-RANKIN Arterienklemmen <b>PRIMUSLINE</b> .....	57
FINOCHIETTO-BABY Rippensperrer .....	215	KILNER (RAGNELL) Scheren.....	45
FINOCHIETTO-BABY-HAIGHT Rippensperrer .....	208	KILNER Nadelhalter.....	172
FINOCHIETTO-INFANT Rippensperrer.....	208, 216	Kinder-Gefäßklemmen .....	124
FRAZIER Saugkanülen .....	9	KITZMILLER Neonatalklemmen.....	128
FULTON Gefäßschere .....	26	KLINIKUM BERLIN Schlauchklemme.....	150
<b>G</b>		KLINKENBERG-LOTH Thoraxschere .....	34
GARRETT Gefäßdilatatoren .....	184	KNAPP (ROLLET) Wundhaken.....	152
Gefäßclips nach Biemer .....	144	Knochenhaltezangen .....	198, 199
Gefäßclips nach Mehdorn, Anlegepinzette .....	146	Knochensplitterzangen .....	196, 197
Gefäßclips nach Müller.....	149	Knorpelscheren .....	33
Gefäßdilatatoren .....	183-185	KOCHER Arterienklemmen.....	58
Gefäßklemmen .....	85-129	KOCHER Wundhaken .....	156
Gefäßscheren .....	26-31	KOCHER-FINO Arterienklemmen .....	59
Gefäßstripper .....	180	KOCHER-LANGENBECK (OBWEGESER) Wundhaken.....	154
GEMINI Präparier- und Ligaturklemmen.....	67	Krampfaderbesteck.....	181
Gewebe- und Darmfasszangen .....	72-75	<b>L</b>	
Gewebe- und Darmfasszangen <b>PRIMUSLINE</b> .....	55	LAHEY Wundhaken.....	156
GIERTZ-STILLE Rippenschere .....	204	LAMBERT-KAY Anastomoseklemmen .....	98
GILLIES chirurgische Pinzette .....	48	LAMBOTTE Raspatorien .....	200
GIL-VERNET Wundhaken .....	153	LANGENBECK Knochenhaltezange .....	199
GLOVER Bulldogklemmen .....	81	LANGENBECK Wundhaken .....	154
GLOVER Mehrzweck-Gefäßklemmen .....	90, 91	LEBSCHE Haken .....	203
GLUCK Rippenscheren.....	202	LEES Bronchusklemmen.....	116
GORNEY Scheren .....	46	LEKSELL Hohlmeißelzangen .....	193
GREGORY Profundaklemmen .....	119	LELAND-JONES Peripheral-Gefäßklemmen .....	111
GREGORY-SOFT Bulldogklemmen.....	82		
GUNNAR Schlauchklemme .....	151		

Inhaltsverzeichnis  
Index

Tables de matières  
Indice  
Indice

**L**

LEMMON Rippenkontraktoren .....226

LERICHE Arterienklemmen.....62

LEXER Scheren.....38

LEXER Scheren **PRIMUSLINE**.....20

Ligaturklemmen.....115

LINCOLN Gefäßscheren .....26

LISTON-KEY HORSLEY Knochensplitterzange .....197

LITTLEWOOD Darmfasszange .....73

LOCKLIN Scheren.....43

LOCKWOOD Darmfasszange .....72

LOUTE Drahtspanninstrument .....228

LOVELACE Arterienklemmen .....62

LOVELACE Lungenfasszangen.....68

LUER-STILLE Hohlmeißelzangen .....195

Lungenfasszangen.....68

Lungenscheren.....32

Lungenspatel .....225

**M**

Mammaria Rippensperrer.....224

Mammaria-Spreizer .....223

MARTIN-CARTILAGE Knorpelschere .....33

MARTINEZ Neonatalklemmen .....129

MASSON Nadelhalter .....175

MATHIEU-OLSEN Nadelhalter .....173

MAYFIELD Hohlmeißelzange .....191

MAYO Scheren.....37

MAYO-HEGAR Nadelhalter .....173

MAYO-LEXER Scheren **PRIMUSLINE** .....20

MAYO-STILLE Scheren **PRIMUSLINE** .....21

MC INDOE Knorpelschere .....33

MC INDOE Pinzette .....47

MC INDOE (METZENBAUM) Scheren .....43

MEHDORN Gefäßclips .....146

Mehrzweck-Gefäßklemmen .....85-96

MERCEDES Thoraxsperrer.....222

METZENBAUM Schere **PRIMUSLINE** .....18

METZENBAUM-FINO Scheren .....42

METZENBAUM-FINO Scheren **PRIMUSLINE**.....19

METZENBAUM-NELSON Scheren .....40, 41

MICRO-MOSQUITO Arterienklemmen.....61

MICRO-MOSQUITO Arterienklemmen **PRIMUSLINE**.....56

MIDDELDORPF Wundhaken .....163

Mikro-Federscheren.....131, 132

Mikro-Gefäßclips.....147, 148

Mikro-Klingenthalter – Mikro-Klingen .....14

Mikro-Knüpppinzetten .....137

Mikro-Nadelhalter .....138, 139

Mikro-Pinzetten, atraumatisch.....136

Mikro-Präparierscheren .....133

Mikro-Scheren.....130-135

Mikro-Wundsperrer .....168

MIKULICZ Wundhaken.....160, 161

MILLS Gefäßschere .....27

MINI-GEMINI Präparier- und Ligaturklemmen .....67

MINI-GLOVER Bulldogklemmen .....78

MINI-RYDER Nadelhalter .....177

MORRIS Wundhaken .....157

MORRIS-DE BAKEY Aortaklemmen.....101

MORSE STERNAL Rippensperrer.....212, 213

MORSE-FAVALORO STERNAL Rippensperrer.....212

MOSQUITO-DANDY Arterienklemmen .....61

MÜLLER Gefäßclips .....145

**N**

NABATOFF Krampfaderbesteck .....181

Nadelhalter.....171-179

Nadelhalter, Mikro-.....138, 139

NEIVERT (MASING) Nadelhalter .....173

Neonatal- u. Kinderklemmen, extra feine Modelle.....121-129

NEUMANN Schere.....43

NOYES Mikro-Scheren .....130

**O**

OBWEGESER Wundhaken .....155

OCHSNER Aortaklemmen .....103

OEHLER chirurgische Pinzetten .....48

OVERHOLT Präparier- und Ligaturklemmen .....65

OVERHOLT-FINO Präparier- und Ligaturklemmen.....65

OVERHOLT-GEISSENDOERFER Präparier- und Ligaturklemmen.....64

OVERHOLT-MIXTER Präparier- und Ligaturklemme .....66

OVERHOLT-MODIFIZIERT Präparier- und Ligaturklemmen.....66

**P**

PÉAN Arterienklemmen **PRIMUSLINE** .....58

PÉAN-FINO Arterienklemmen **PRIMUSLINE**.....59

PECK-JOSEF Scheren.....39

Peripheral-Gefäßklemmen .....111-113

Pinzetten, anatomisch.....47, 48

Pinzetten, atraumatisch .....49-53

Pinzetten, chirurgisch.....48

Pinzetten, Mikro- .....136, 137

POOLE Saugrohre.....6

POTTS Anastomoseklemme .....97

POTTS Bulldogklemmen mit Ringgriff .....120

POTTS Coarctationsklemmen .....117

POTTS-DE MARTEL Gefäßscheren .....28, 31

POTTS-SMITH (DE MARTEL) Gefäßschere .....26

POTTS-SMITH anatomische Pinzetten .....47

POTTS-SMITH Knorpelschere .....33

Präparier- und Ligaturklemmen.....64-67

Präparier- und Ligaturklemmen, atraumatisch.....114

PRICE-THOMAS Bronchusklemmen .....69

Profundaklemmen .....119

PROVIDENCE HOSPITAL Arterienklemmen.....61

**Q**

QUINBY Schere .....43

**R**

Raspatorien – Elevatorien .....200, 201

RESANO Schere.....32

REYNOLDS (JAMESON) Scheren .....45

REYNOLDS Scheren **PRIMUSLINE**.....21

Rippenkontraktoren .....226

Rippenscheren .....202-205

Rippensperrer.....207-224

Rippensperrer aus Aluminium .....206

RONALD-EDWARDS Rippensperrer .....218

ROSS Absaugaufsätze .....10

## Inhaltsverzeichnis Index

## Tables de matières

## Indice

## Indice

ROSS Schlauchklemme .....	151	Technische Zangen .....	231
RÖTTGEN-RUSKIN Hohlmeißelzange .....	194	TEKNO-TWIST Nadelhalter .....	176
RUMEL-BELMONT Tourniquet.....	180	TERRIER Arterienklemme .....	60
RUSKIN Hohlmeißelzangen .....	191	THOMS-ALLIS Darmfasszange.....	72
RUSKIN-LISTON Knochensplitterzangen .....	196	Thoraxscheren.....	34
RYDER Nadelhalter .....	177, 178	TOENNIS-ADSON Tonsillenschere .....	36
<b>S</b>		Tonsillenscheren.....	36
SANTULLI Bulldogklemme.....	82	Tourniquet .....	180
SAROT Bronchusklemmen.....	70	TUBBS Aorta-Dilatator .....	186
SAROT Nadelhalter .....	176	TUFFIER Rippensperrerr .....	216
SATINSKY Bronchusklemmen .....	71	Tunnelierbesteck .....	187-189
SATINSKY Thoraxschere .....	34	<b>V</b>	
SATINSKY-DE BAKEY Tangentialklemmen.....	108	VAN BUREN Knochenhaltezeuge.....	198
SAUERBRUCH Hohlmeißelzangen.....	195	VARADY Dissektoren.....	182
SAUERBRUCH Rippenschere .....	204	VASCULAR Nadelhalter.....	177, 179
SAUERBRUCH Wundhaken.....	155	VEHMEHREN Rippenschere .....	205
SAUERBRUCH-FREY Rippenschere.....	203	<b>W</b>	
Saugrohre .....	6-9	WANGENSTEEN anatomische Pinzetten .....	47
Scheren .....	15-46	WANGENSTEEN Nadelhalter .....	175
Scheren für die plastische Chirurgie .....	45, 46	WEBER Aortaklemmen .....	102
Scheren, chirurgische .....	37-42	WEBSTER Nadelhalter .....	172
Scheren, feine .....	43, 44	WEITLANER-LOCKTITE Wundsperrerr .....	169
Scheren, Gefäß- .....	26-31	WESTCOTT Sehnenscheren.....	35
Scheren, Knorpel- .....	33	WILLAUER Lungenschere .....	32
Scheren, Lungen- .....	32	WILLIAMS Darmfasszange .....	72
Scheren, Mikro-.....	130-135	WILLIGER Elevatorien .....	201
Scheren, Präparier- .....	40-42	Wundhaken.....	152-168
Scheren, <b>PRIMUSLINE</b> .....	15-23	Wundsperrerr.....	169
Scheren, Rippen .....	202-205	<b>Y</b>	
Scheren, Sehnen-.....	35	YANKAUER Saugrohr.....	6
Scheren, Thorax- .....	34	YASARGIL Mikro-Federschere.....	131, 132
Scheren, Tonsillen-.....	36	<b>Z</b>	
Schlauchklemmen .....	150, 151	ZENKER Wundhaken.....	162
Sehnenscheren.....	35		
SELLORS Rippenkontraktor.....	226		
SELLORS Rippensperrerr.....	219		
SEMB Bronchusklemmen .....	70		
SEMB Hohlmeißelzange.....	194		
SEMB Knochenhaltezeuge.....	199		
SEMB Knochensplitterzange .....	197		
SIMON Wundhaken .....	159		
Skalpellgriffe .....	11, 12		
Skalpellklingen .....	13		
SOUTHAMPTON Saugrohr.....	8		
ST. MARKS Wundhaken .....	164		
STANDARD anatomische Pinzetten.....	47		
STANDARD Skalpellgriffe .....	11		
STEVENS Scheren <b>PRIMUSLINE</b> .....	23		
STILLE Hohlmeißelzangen .....	192		
STILLE Rippenscheren.....	202		
STILLE-LISTON Knochensplitterzangen .....	196		
STILLE-LUER Hohlmeißelzangen .....	193		
STILLE-RUSKIN Hohlmeißelzangen .....	192		
Strabismus-Scheren.....	44		
STRATTE Nadelhalter.....	174		
<b>T</b>			
Tangentialklemmen .....	108-110		
TAYLOR anatomische Pinzette.....	47		

Inhaltsverzeichnis  
Index

Tables de matières  
Indice  
Indice

**A**

ADSON forceps ..... 47, 48

ADSON raspatories ..... 200

ADSON-BROWN forceps ..... 48

ADSON-MICRO forceps ..... 48

ALLIS tissue holding forceps ..... 72

ALLIS tissue holding forceps **PRIMUSLINE** ..... 55

ALLIS-ADAIR tissue holding forceps ..... 72

ALLIS-ATRAUMA tissue holding forceps ..... 75

ALLIS-BABY tissue holding forceps ..... 72

ALLISON lung spatula ..... 225

Anastomosis clamps ..... 97-100

ANDREWS-PYNCHON suction tube ..... 6

Aneurysm clamps ..... 107

ANKENEY rib retractor ..... 223

Aorta clamps ..... 101-104

Aorta dilators ..... 186

Aorta punches ..... 190

Aorta-aneurysm clamps ..... 105, 106

Applying forceps for bulldog clamps ..... 78, 86

Applying forceps for vessel clips ..... 142

Approximators, Biemer vessel clips ..... 144

Approximators, Müller vessel clips ..... 145

Approximators, vessel clips ..... 143

Atraumatic forceps ..... 49-53

Atraumatic micro forceps ..... 136

Atraumatic tissue forceps ..... 48

**B**

BABCOCK tissue holding forceps ..... 73

BABCOCK tissue holding forceps **PRIMUSLINE** ..... 55

BABCOCK-ATRAUMA tissue holding forceps ..... 75

BABY METZENBAUM scissors **PRIMUSLINE** ..... 19

BABY-CRILE-WOOD needle holder ..... 171

BABY-HAIGHT rib retractors ..... 214

BABY-SATINSKY bronchus clamps ..... 71

BAILEY rib contractor ..... 226

BAILEY-BABY rib contractor ..... 226

BAILEY-GIBBON rib contractor ..... 226

BAINBRIDGE, LIGHT vascular clamps ..... 85

BARRON scalpel handel ..... 11

BECK anastomosis clamps ..... 97

BETHUNE rib shear ..... 204

BEYER bone rongeur ..... 191

BIEMER vessel clips ..... 144

BLALOCK retractor ..... 158

BÖHLER bone cutting forceps ..... 196

Bone cutting forceps ..... 196, 197

Bone holding forceps ..... 198, 199

Bone rongeurs ..... 191-195

BOROWSKI retractors ..... 168

BOYS-ALLIS tissue holding forceps ..... 73

BOZEMANN (WERTHEIM) needle holder ..... 174

BRIDGE dissecting and ligature forceps ..... 66

BROCKS retractor ..... 158

BROMPTON retractor ..... 158

Bronchus and vascular clamps ..... 69-71

Bronchus clamps, atraumatic ..... 116

BROPHY (SULLIVAN) scissors ..... 39

BRUNNER rib shears ..... 203

Bulldog clamps ..... 76-83

Bulldog clamps with ring handle ..... 120

BURFORD rib retractors ..... 207

**C**

Carotid-shunt clamps ..... 118

Cartilage scissors ..... 33

CASTAÑEDA neonatal clamps ..... 121

CASTROVIEJO-JACOBSON needle holders ..... 179

CHRISTOPHE haemostatic forceps ..... 62

Coarctation clamps ..... 117

COLLIN scalpel handel ..... 11

CONVERSE needle holder ..... 173

COOLEY anastomosis clamps ..... 100

COOLEY aorta dilatator ..... 186

COOLEY bulldog clamps ..... 83

COOLEY multi purpose vascular clamps ..... 92-96

COOLEY PATENT DUCTUS CLAMP ..... 95

COOLEY retractors ..... 165-167

COOLEY rib retractors ..... 209-211

COOLEY suction tubes ..... 7

COOLEY tangential occlusion clamps ..... 109, 110

COOLEY vascular dilators ..... 183

COOLEY-BECK anastomosis clamps ..... 100

COOLEY-DERRA anastomosis clamps ..... 99

CRAFOORD lobectomy scissors ..... 32

CRAFOORD rib contractor ..... 226

CRILE haemostatic forceps ..... 63

CRILE haemostatic forceps **PRIMUSLINE** ..... 57

CRILE-RANKIN haemostatic forceps ..... 63

CRILE-RANKIN haemostatic forceps **PRIMUSLINE** ..... 57

CRILE-WOOD needle holders ..... 171

CUSHING dressing forceps ..... 47

CUSHING retractors ..... 153

CZERNY retractor ..... 158

**D**

DALE peripheral-vascular clamps ..... 113

DANDY haemostatic forceps ..... 61

DARDIK multi purpose vascular clamps ..... 88

DAVIDSON retractors ..... 161

DE BAKEY aorta clamp ..... 104

DE BAKEY aorta-aneurysm clamps ..... 105, 106

DE BAKEY atraumatic forceps ..... 49-51

DE BAKEY BAYONET atraumatic forceps ..... 52

DE BAKEY bulldog clamps ..... 80

DE BAKEY dissecting and ligature forceps ..... 114

DE BAKEY ligature clamps ..... 115

DE BAKEY multi purpose vascular clamps ..... 85-87, 89

DE BAKEY needle holders ..... 176

DE BAKEY pediatric vascular clamps ..... 124

DE BAKEY rib retractors ..... 217, 220

DE BAKEY suction tube ..... 6

DE BAKEY vascular dilators ..... 183

DE BAKEY vascular scissors ..... 27, 31

DE BAKEY-ADSON atraumatic forceps ..... 52

DE BAKEY-BAHNSON aneurysm clamps ..... 107

DE BAKEY-CAROTIS bulldog clamp ..... 82

DE BAKEY-DIETHRICH bulldog clamps ..... 79

DE BAKEY-GERALD atraumatic forceps ..... 52

English

## Inhaltsverzeichnis Index

## Tables de matières Indice Indice

DE BAKEY-SATINSKY bulldog clamp .....	82	HAMMERSMITH suction tubes .....	8
DE BAKEY-SEMB ligature clamps .....	115	HARRINGTON retractors .....	159
DE BAKEY-WYLIE peripheral vascular clamps .....	112	HARTMANN haemostatic forceps .....	60
DE BOER (Sternal) rib retractor .....	216	HARTMANN haemostatic forceps <b>PRIMUSLINE</b> .....	56
DEAN tonsil scissors .....	36	HEANEY needle holder .....	174
DEMEL guide needle .....	227	HEGAR vascular dilators .....	185
DEMEL wire tightening forceps .....	227	HEGAR-BAUMGARTNER needle holder .....	171
DERF (WRIGHT) needle holder .....	172	HOHENFELLNER vascular scissors .....	30
DERRA anastomosis clamps .....	97		
DESMARRES retractors .....	152	<b>I</b>	
DIEFFENBACH bulldog clamps .....	77	Instrument trays, stainless steel .....	140
DIETHRICH aorta clamp .....	103	Iris scissors <b>PRIMUSLINE</b> .....	23
DIETHRICH bulldog clamps .....	77		
DIETHRICH needle holders .....	177	<b>J</b>	
DIETHRICH-HEGEMANN vascular scissors .....	29	JAVID carotis-shuntclamps .....	118
Dissecting and ligature forceps .....	64-67	JOHNS-HOPKINS bulldog clamps .....	76, 77
Dissecting and ligature forceps, atraumatic .....	114	JORGENSEN thorax scissors .....	34
Dissectors .....	182	JOSEPH scissors .....	46
Dressing forceps .....	47, 48	JOSEPH scissors <b>PRIMUSLINE</b> .....	22
DUVAL tissue holding forceps .....	74	JUDD-ALLIS tissue holding forceps .....	73
<b>F</b>		<b>K</b>	
FARABEUF raspatories .....	200	KELLY haemostatic forceps .....	63
FARABEUF-COLLIN raspatories .....	201	KELLY haemostatic forceps <b>PRIMUSLINE</b> .....	57
FAVALORO vascular scissors .....	27	KELLY scissors .....	38
FERGUSSON bone holding forceps .....	198	KELLY scissors <b>PRIMUSLINE</b> .....	22
FERGUSSON suction tubes .....	9	KELLY-RANKIN haemostatic forceps .....	63
Fine scissors - Iris scissors .....	43-44	KELLY-RANKIN haemostatic forceps <b>PRIMUSLINE</b> .....	57
FINOCHIETTO lobectomy scissors .....	32	KILNER (RAGNELL) scissors .....	45
FINOCHIETTO needle holder .....	175	KILNER needle holder .....	172
FINOCHIETTO rib retractors .....	208, 214, 215	KITZMILLER neonatal clamps .....	128
FINOCHIETTO-BABY rib retractors .....	215	KLINIKUM BERLIN tubing clamp .....	150
FINOCHIETTO-BABY-HAIGHT rib retractor .....	208	KLINKENBERG-LOTH thorax scissors .....	34
FINOCHIETTO-INFANT rib retractor .....	208, 216	KNAPP (ROLLET) retractors .....	152
Forceps, atraumatic .....	49-53	KOCHER haemostatic forceps .....	58
Forceps, dressing .....	47, 48	KOCHER retractors .....	156
Forceps, micro- .....	136, 137	KOCHER-FINO haemostatic forceps .....	59
FRAZIER suction tubes .....	9	KOCHER-LANGENBECK (OBWEGESER) retractors .....	154
FULTON vascular scissors .....	26		
		<b>L</b>	
<b>G</b>		LAHEY retractor .....	156
GARRETT vascular dilators .....	184	LAMBERT-KAY anastomosis clamps .....	98
GEMINI dissecting and ligature forceps .....	67	LAMBOTTE raspatories .....	200
GIERTZ-STILLE rib shear .....	204	LANGENBECK bone holding forceps .....	199
GILLIES dressing forceps .....	48	LANGENBECK retractors .....	154
GIL-VERNET retractors .....	153	LEBSCHE hook .....	203
GLOVER bulldog clamps .....	81	LEES bronchus clamps .....	116
GLOVER multi purpose vascular clamps .....	90, 91	LEKSELL bone rongeurs .....	193
GLUCK rib shear .....	202	LELAND-JONES peripheral vascular clamps .....	111
GORNEY scissors .....	46	LEMMON rib contractors .....	226
GREGORY profunda clamps .....	119	LERICHE haemostatic forceps .....	62
GREGORY-SOFT bulldog clamps .....	82	LEXER scissors .....	38
GUNNAR tubing clamp .....	151	LEXER scissors <b>PRIMUSLINE</b> .....	20
		Ligature clamps .....	115
<b>H</b>		LINCOLN vascular scissors .....	26
Haemostatic forceps .....	56-63	LISTON-KEY HORSLEY bone cutting forceps .....	197
Haemostatic forceps <b>PRIMUSLINE</b> .....	56-59	LITTLEWOOD tissue holding forceps .....	73
HALSEY needle holder .....	172	Lobectomy scissors .....	32
HALSTED-MOSQUITO haemostatic forceps .....	60	LOCKLIN scissors .....	43
HALSTED-MOSQUITO haemostatic forceps <b>PRIMUSLINE</b> .....	56	LOCKWOOD tissue holding forceps .....	72

Inhaltsverzeichnis  
Index

Tables de matières  
Indice  
Indice

LOUTE wire tightener .....228  
 LOVELACE haemostatic forceps .....62  
 LOVELACE lung grasping forceps.....68  
 LUER-STILLE bone rongeurs.....195  
 Lung grasping forceps.....68  
 Lung spatula .....225

**M**

Mammaria retractor .....223  
 Mammaria rib retractor .....224  
 MARTIN-CARTILAGE cartilage scissors .....33  
 MARTINEZ neonatal clamps .....129  
 MASSON needle holder.....175  
 MATHIEU-OLSEN needle holders .....173  
 MAYFIELD bone rongeur.....191  
 MAYO scissors.....37  
 MAYO-HEGAR needle holders .....173  
 MAYO-LEXER scissors **PRIMUSLINE** .....20  
 MAYO-STILLE scissors **PRIMUSLINE** .....21  
 MC INDOE cartilage scissors .....33  
 MC INDOE forceps .....47  
 MC INDOE (METZENBAUM) scissors .....43  
 MEHDORN vessel clips.....146  
 MERCEDES rib retractor.....222  
 METZENBAUM scissors **PRIMUSLINE** .....18  
 METZENBAUM-FINO scissors .....42  
 METZENBAUM-FINO scissors **PRIMUSLINE** .....19  
 METZENBAUM-NELSON scissors.....40, 41  
 Micro needle holders.....138, 139  
 Micro retractors .....168  
 Micro scissors .....130-135  
 Micro tying forceps .....137  
 Micro vessel clips.....147, 148  
 Micro-blade holder – Micro-blades.....14  
 Micro-dissecting scissors .....133  
 Micro-forceps, atraumatic.....136  
 MICRO-MOSQUITO haemostatic forceps .....61  
 MICRO-MOSQUITO haemostatic forceps **PRIMUSLINE** .....56  
 MIDDELDORPF retractors .....163  
 MIKULICZ retractors .....160, 161  
 MILLS vascular scissors.....27  
 MINI-GEMINI dissecting and ligature forceps.....67  
 MINI-GLOVER bulldog clamps .....78  
 MINI-RYDER needle holders.....177  
 MORRIS retractors .....157  
 MORRIS-DE BAKEY aorta clamps .....101  
 MORSE STERNAL rib retractors .....212, 213  
 MORSE-FAVALORO STERNAL rib retractors .....212  
 MOSQUITO-DANDY haemostatic forceps .....61  
 MÜLLER vessel clips.....145  
 Multi purpose vascular clamps.....85-96

**N**

NABATOFF varicose vein probe set .....181  
 Needle holders .....171-179  
 Needle holders, micro-.....138, 139  
 NEIVERT (MASING) needle holder .....173  
 Neonatal- and children's clamps, extra delicate patterns .....121-129  
 NEUMANN scissors.....43  
 NOYES micro scissors.....130

**O**

OBWEGESER retractors.....155  
 OCHSNER aorta clamps .....103  
 OEHLER dressing forceps.....48  
 Operating scissors .....37-39  
 Operating scissors – Dissecting scissors .....40-42  
 OVERHOLT dissecting and ligature forceps .....65  
 OVERHOLT-FINO dissecting and ligature forceps .....65  
 OVERHOLT-GEISSENDOERFER dissecting and ligature forceps .....64  
 OVERHOLT-MIXTER dissecting and ligature forceps.....66  
 OVERHOLT-MODIFIZIERT dissecting and ligature forceps.....66

**P**

PÉAN haemostatic forceps **PRIMUSLINE** .....58  
 PÉAN-FINO haemostatic forceps **PRIMUSLINE**.....59  
 PECK-JOSEF scissors.....39  
 Pediatric vascular clamps.....124  
 Peripheral vascular clamps .....111-113  
 POOLE suction tubes.....6  
 POTTS anastomosis clamp .....97  
 POTTS bulldog clamps with ring handle .....120  
 POTTS coarctation clamps .....117  
 POTTS-DE MARTEL vascular scissors .....28, 31  
 POTTS-SMITH (DE MARTEL) vascular scissors .....26  
 POTTS-SMITH cartilage scissors.....33  
 POTTS-SMITH dressing forceps .....47  
 PRICE-THOMAS bronchus clamps.....69  
 Profunda clamps.....119  
 Profusion vents.....10  
 PROVIDENCE HOSPITAL haemostatic forceps.....61

**Q**

QUINBY scissors .....43

**R**

Raspatories – Elevators.....200, 201  
 RESANO lobectomy scissors.....32  
 Retractors.....152-168  
 Retractors, self-retaining .....169  
 REYNOLDS (JAMESON) scissors .....45  
 REYNOLDS scissors **PRIMUSLINE**.....21  
 Rib contractors.....226  
 Rib retractors .....207-224  
 Rib retractors, aluminium.....206  
 Rib shears.....202-205  
 RONALD EDWARDS rib retractors.....218  
 ROSS profusion vents.....10  
 ROSS tubing clamp.....151  
 RÖTTGEN-RUSKIN bone rongeur .....194  
 RUMEL-BELMONT tourniquet.....180  
 RUSKIN bone rongeurs.....191  
 RUSKIN-LISTON bone cutting forceps .....196  
 RYDER needle holders.....177, 178

**S**

SANTULLI bulldog clamp .....82  
 SAROT bronchus clamps .....70  
 SAROT needle holders.....176  
 SATINSKY bronchus clamps.....71  
 SATINSKY thorax scissors.....34

English

## Inhaltsverzeichnis Index

## Tables de matières

### Indice

### Indice

SATINSKY-DE BAKEY tangential occlusion clamps .....	108	Tubing clamps.....	150, 151
SAUERBRUCH bone rongeurs .....	195	TUFFIER rib retractors.....	216
SAUERBRUCH retractors.....	155	Tunneling set .....	187-189
SAUERBRUCH rib shear .....	204		
SAUERBRUCH-FREY rib shear.....	203	<b>V</b>	
Scalpel blades .....	13	VAN BUREN bone holding forceps .....	198
Scalpel handels .....	11, 12	VARADY dissectors .....	182
Scissors.....	15-46	Varicose veine probe set.....	181
Scissors for plastic surgery.....	45, 46	Vascular clamps .....	85-129
Scissors, cartilage.....	33	Vascular dilators.....	183-185
Scissors, dissecting.....	37-42	VASCULAR needle holders.....	177, 179
Scissors, fine.....	43, 44	Vascular scissors.....	26-31
Scissors, lobectomy .....	32	VEHMEHREN rib shear .....	205
Scissors, micro.....	130-135	Vein stripper.....	180
Scissors, <b>PRIMUSLINE</b> .....	15-23	Vessel clips Biemer .....	144
Scissors, rib.....	202-205	Vessel clips Mehdorn, applying forceps.....	146
Scissors, tendon.....	35	Vessel clips Müller.....	149
Scissors, thorax.....	34		
Scissors, tonsil.....	36	<b>W</b>	
Scissors, vascular.....	26-31	WANGENSTEEN dressing forceps .....	47
Self retaining retractors .....	168, 169	WANGENSTEEN needle holder.....	175
SELLORS rib contractor.....	226	WEBER aorta clamps.....	102
SELLORS rib retractors .....	219	WEBSTER needle holder.....	172
SEMB bone cutting forceps.....	197	WEITLANER-LOCKTITE self-retaining retractor.....	169
SEMB bone holding forceps .....	199	WESTCOTT tenotomy scissors .....	35
SEMB bone rongeur.....	194	WILLAUER lobectomy scissors.....	32
SEMB bronchus clamps.....	70	WILLIAMS tissue holding forceps.....	72
SIMON retractors .....	159	WILLIGER elevators .....	201
SOUTHAMPTON suction tube .....	8	Wire cutting forceps.....	229, 230
ST. MARKS retractors.....	164	Wire instruments .....	227, 228
STANDARD dressing forceps.....	47		
STANDARD scalpel handels.....	11	<b>Y</b>	
STEVENS scissors <b>PRIMUSLINE</b> .....	23	YANKAUER suction tube.....	6
STILLE bone rongeurs .....	192	YASARGIL micro-scissors.....	131, 132
STILLE rib shear.....	202		
STILLE-LISTON bone cutting forceps.....	196	<b>Z</b>	
STILLE-LUER bone rongeurs.....	193	ZENKER retractors.....	162
STILLE-RUSKIN bone rongeurs .....	192		
Strabismus scissors .....	44		
STRATTE needle holder .....	174		
Suction tubes .....	6-9		
<b>T</b>			
Tangential occlusion clamps .....	108-110		
TAYLOR dressing forceps .....	47		
Technical forceps .....	231		
TEKNO-TWIST needle holder.....	176		
Tenotomy scissors.....	35		
TERRIER haemostatic forceps.....	60		
THOMS-ALLIS tissue holding forceps .....	72		
Thoracic and I.M.A. retractor .....	223		
Thorax scissors .....	34		
Tissue and intestinal holding forceps.....	72-75		
Tissue and intestinal holding forceps <b>PRIMUSLINE</b> .....	55		
Tissue forceps .....	48		
Tissue forceps, atraumatic.....	48		
TOENNIS-ADSON tonsil scissors .....	36		
Tonsil scissors .....	36		
Tourniquet .....	180		
TUBBS aorta-dilatator .....	186		

**Inhaltsverzeichnis  
Index**
**Tables de matières  
Indice  
Indice**

<b>A</b>	
ADSON pinces à dissection.....	47, 48
ADSON rugines.....	200
ADSON-BROWN pince à dissection .....	48
ADSON-MICRO pinces à dissection .....	48
ALLIS pinces intestinales .....	72
ALLIS pinces intestinales <b>PRIMUSLINE</b> .....	55
ALLIS-ADAIR pince intestinale .....	72
ALLIS-ATRAUMA pinces intestinales.....	75
ALLIS-BABY pince intestinale.....	72
ALLISON spatules pulmonaires.....	225
ANDREWS-PYNCHON canule d'aspiration.....	6
ANKENEY écarteur des côtes.....	223
Approximateurs, clips.....	143
Approximateurs, clips selon Biemer.....	144
Approximateurs, clips selon Müller.....	145
<b>B</b>	
BABCOCK pinces intestinales .....	73
BABCOCK pinces intestinales <b>PRIMUSLINE</b> .....	55
BABCOCK-ATRAUMA pinces intestinales.....	75
BABY METZENBAUM ciseaux <b>PRIMUSLINE</b> .....	19
BABY-CRILE-WOOD porte-aiguilles.....	171
BABY-HAIGHT écarteur des côtes.....	214
BABY-SATINSKY pince pour bronches .....	71
BAILEY rapprocheur des côtes.....	226
BAILEY-BABY rapprocheur des côtes.....	226
BAILEY-GIBBON rapprocheur des côtes .....	226
BAINBRIDGE, LIGHT pinces vasculaires.....	85
BARRON manche pour bistouris.....	11
BECK pince-clamp pour anastomose .....	97
BETHUNE costotome.....	204
BEYER pince gouge.....	191
BIEMER clips.....	144
BLALOCK écarteur .....	158
BÖHLER pinces coupantes à os .....	196
BOROWSKI écarteurs .....	168
BOYS-ALLIS pince intestinale.....	73
BOZEMANN (WERTHEIM) porte-aiguilles .....	174
BRIDGE pinces à disséquer et à sutures .....	66
BROCKS écarteur .....	158
BROMPTON écarteur.....	158
BROPHY (SULLIVAN) ciseaux.....	39
BRUNNER costotomes .....	203
BURFORD écarteur des côtes .....	207
<b>C</b>	
Canules d'aspiration.....	6-9
CASTAÑEDA pinces pour nouveaux-nés .....	124
CASTROVIEJO-JACOBSON porte-aiguilles.....	179
CHRISTOPHE pinces hémostatiques.....	62
Ciseaux.....	15-46
Ciseaux à chirurgie - Ciseaux à dissection .....	37-42
Ciseaux à iridectomie <b>PRIMUSLINE</b> .....	23
Ciseaux à lobectomie .....	32
Ciseaux à strabisme.....	44
Ciseaux à ténotomie.....	35
Ciseaux fins - Ciseaux à iridectomie .....	43-44
Ciseaux micro.....	130-135
Ciseaux pour cartilages.....	33

Ciseaux pour la chirurgie plastique.....	45, 46
Ciseaux pour le thorax .....	34
Ciseaux pour les amygdales .....	36
Ciseaux <b>PRIMUSLINE</b> .....	15-23
Ciseaux vasculaires.....	26-31
Clamps bulldog.....	76-83
Clamps bulldog, manches à anneaux.....	120
Clips selon Biemer.....	144
Clips selon Mehdorn, pince à poser des clips.....	146
Clips selon Müller.....	149
COLLIN manche pour bistouris .....	11
Contenaires d'instruments en acier inox .....	140
CONVERSE porte-aiguilles .....	173
COOLEY canules d'aspiration.....	7
COOLEY clamps bulldog.....	83
COOLEY dilateur aortique .....	186
COOLEY dilateurs vasculaires.....	183
COOLEY écarteur des côtes.....	209-211
COOLEY écarteurs .....	165-167
COOLEY PATENT DUCTUS CLAMP.....	95
COOLEY pinces vasculaires universelles .....	92-96
COOLEY pinces-clamps pour anastomose.....	100
COOLEY pinces-clamps pour l'occlusion tangentielle .....	109, 110
COOLEY-BECK pinces-clamps pour anastomose.....	100
COOLEY-DERRA pinces-clamps pour anastomose .....	99
Costotomes .....	202-205
CRAFOORD ciseaux à lobectomie.....	32
CRAFOORD rapprocheur des côtes .....	226
CRILE pinces hémostatiques .....	63
CRILE pinces hémostatiques <b>PRIMUSLINE</b> .....	57
CRILE-RANKIN pinces hémostatiques .....	63
CRILE-RANKIN pinces hémostatiques <b>PRIMUSLINE</b> .....	57
CRILE-WOOD porte-aiguilles.....	171
CUSHING écarteurs .....	153
CUSHING pince à dissection.....	47
CZERNY écarteur.....	158
<b>D</b>	
DALE pinces vasculaires périphériques .....	113
DANDY pinces hémostatiques.....	61
DARDIK pinces vasculaires universelles .....	88
DAVIDSON écarteurs .....	161
Daviers porte-os.....	198, 199
DE BAKEY BAYONET pince à dissection atraumatique .....	52
DE BAKEY canule d'aspiration.....	6
DE BAKEY ciseaux vasculaires .....	27, 31
DE BAKEY clamps bulldog .....	80
DE BAKEY dilateurs vasculaires .....	183
DE BAKEY écarteur des côtes .....	217, 220
DE BAKEY pince-clamp pour l'aorte.....	104
DE BAKEY pinces à dissection atraumatiques .....	49-51
DE BAKEY pinces à disséquer et à ligatures .....	114
DE BAKEY pinces à ligatures .....	115
DE BAKEY pinces vasculaires pour enfants .....	124
DE BAKEY pinces vasculaires universelles .....	85-87, 89
DE BAKEY pinces-clamps pour anévrismes de l'aorte.....	105, 106
DE BAKEY porte-aiguilles.....	176
DE BAKEY-ADSON pince à dissection atraumatique.....	52
DE BAKEY-BAHNSON pinces-clamps pour anévrismes .....	107
DE BAKEY-CAROTIS clamp bulldog .....	82



## Inhaltsverzeichnis Index

## Tables de matières

### Indice

### Indice

DE BAKEY-DIETHRICH clamps bulldog.....	79	HALSTED-MOSQUITO pinces hémostatiques .....	60
DE BAKEY-GERALD pinces à dissection atraumatiques .....	52	HALSTED-MOSQUITO pinces hémostatiques <b>PRIMUSLINE</b> .....	56
DE BAKEY-SATINSKY clamp bulldog .....	82	HAMMERSMITH canules d'aspiration .....	8
DE BAKEY-SEMB pinces à ligatures .....	115	HARRINGTON écarteurs.....	159
DE BAKEY-WYLIE pinces vasculaires périphériques .....	112	HARTMANN pinces hémostatiques .....	60
DE BOER (Sternal) écarteur des côtes .....	216	HARTMANN pinces hémostatiques <b>PRIMUSLINE</b> .....	56
DEAN ciseaux pour les amygdales .....	36	HEANEY porte-aiguilles.....	174
DEMEL aiguilles de cerclage .....	227	HEGAR dilateurs vasculaires.....	185
DEMEL pince pour cerclage .....	227	HEGAR-BAUMGARTNER porte-aiguilles.....	171
DERF (WRIGHT) porte-aiguilles.....	172	HOHENFELLNER ciseaux vasculaires.....	30
DERRA pinces-clamps pour anastomose.....	97		
DESMARRES écarteurs .....	152	<b>I</b>	
DIEFFENBACH clamps bulldog .....	77	Instruments de cerclage.....	227, 228
DIETHRICH clamps bulldog .....	77		
DIETHRICH pince-clamp pour l'aorte.....	103	<b>J</b>	
DIETHRICH porte-aiguilles .....	177	JAVID pinces pour carotide .....	118
DIETHRICH-HEGEMANN ciseaux vasculaires .....	29	Jeu pour tunnelisation .....	187-189
Dilatateurs aortiques.....	186	JOHNS-HOPKINS clamps bulldog.....	76, 77
Dilatateurs vasculaires.....	183-185	JORGENSEN ciseaux pour le thorax .....	34
Dissecteurs.....	182	JOSEPH ciseaux .....	46
DUVAL pinces intestinales .....	74	JOSEPH ciseaux <b>PRIMUSLINE</b> .....	22
		JUDD-ALLIS pinces intestinales .....	73
<b>E</b>			
Écarteur des côtes .....	207-224	<b>K</b>	
Écarteur des côtes, aluminium.....	206	KELLY ciseaux.....	38
Ecarteur thoracique et I.M.A.....	223	KELLY ciseaux <b>PRIMUSLINE</b> .....	22
Écarteurs.....	152-168	KELLY pinces hémostatiques .....	63
Écarteurs autostatiques .....	169	KELLY pinces hémostatiques <b>PRIMUSLINE</b> .....	57
		KELLY-RANKIN pinces hémostatiques .....	63
<b>F</b>		KELLY-RANKIN pinces hémostatiques <b>PRIMUSLINE</b> .....	57
FARABEUF rugines .....	200	KILNER (RAGNELL) ciseaux.....	45
FARABEUF-COLLIN rugines .....	201	KILNER porte-aiguilles .....	172
FAVALORO ciseaux vasculaires.....	27	KITZMILLER pinces pour nouveaux-nés .....	128
FERGUSSON canules d'aspiration.....	9	KLINIKUM BERLIN presse-tubes.....	150
FERGUSSON davier porte-os .....	198	KLINKENBERG-LOTH ciseaux pour le thorax .....	34
FINOCHIETTO ciseaux à lobectomie .....	32	KNAPP (ROLLET) écarteurs.....	152
FINOCHIETTO écarteur des côtes.....	208, 214, 215	KOCHER écarteurs .....	156
FINOCHIETTO porte-aiguilles.....	175	KOCHER pinces hémostatiques .....	58
FINOCHIETTO-BABY écarteur des côtes.....	215	KOCHER-FINO pinces hémostatiques.....	59
FINOCHIETTO-BABY-HAIGHT écarteur des côtes.....	208	KOCHER-LANGENBECK (OBWEGESER) écarteurs .....	154
FINOCHIETTO-INFANT écarteur des côtes .....	208, 216		
FRAZIER canules d'aspiration .....	9	<b>L</b>	
FULTON ciseaux vasculaires .....	26	LAHEY écarteurs .....	156
		LAMBERT-KAY pinces-clamps pour anastomose.....	98
<b>G</b>		LAMBOTTE rugines.....	200
GARRETT dilateurs vasculaires .....	184	Lames pour bistouris.....	13
GEMINI pinces à disséquer et à ligatures.....	67	LANGENBECK davier porte-os.....	199
GIERTZ-STILLE costotome.....	204	LANGENBECK écarteurs .....	154
GILLIES pince à dissection à griffes.....	48	LEBSCHÉ crochet .....	203
GIL-VERNET écarteurs.....	153	LEES pinces pour bronches.....	116
GLOVER clamps bulldog.....	81	LEKSELL pinces gouges.....	193
GLOVER pinces vasculaires universelles .....	90, 91	LELAND-JONES pinces vasculaires périphériques.....	111
GLUCK costotomes .....	202	LEMMON rapprocheurs des côtes .....	226
GORNEY ciseaux .....	46	LERICHE pinces hémostatiques .....	62
GREGORY pinces fémorales.....	119	LEXER ciseaux.....	38
GREGORY-SOFT clamps bulldog .....	82	LEXER ciseaux <b>PRIMUSLINE</b> .....	20
GUNNAR presse-tubes.....	151	LINCOLN ciseaux vasculaires.....	26
		LISTON-KEY HORSLEY pince coupante à os.....	197
<b>H</b>		LITTLEWOOD pince intestinale.....	73
HALSEY porte-aiguilles .....	172	LOCKLIN ciseaux.....	43

**Inhaltsverzeichnis  
Index**
**Tables de matières  
Indice  
Indice**

LOCKWOOD pince intestinale .....	72
LOUTE serre-fils .....	228
LOVELACE pinces hémostatiques .....	62
LOVELACE pinces-clamps pour poumons.....	68
LUER-STILLE pinces gouges.....	195

**M**

Mammaria écarteur des côtes .....	224
Manches pour bistouris .....	11, 12
MARTIN-CARTILAGE ciseaux pour cartilages .....	33
MARTINEZ pinces pour nouveaux-nés .....	129
MASSON porte-aiguilles.....	175
MATHIEU-OLSEN porte-aiguilles.....	173
MAYFIELD pince gouge.....	191
MAYO ciseaux.....	37
MAYO-HEGAR porte-aiguilles.....	173
MAYO-LEXER ciseaux <b>PRIMUSLINE</b> .....	20
MAYO-STILLE ciseaux <b>PRIMUSLINE</b> .....	21
MC INDOE (METZENBAUM) ciseaux .....	43
MC INDOE ciseaux pour cartilages .....	33
MC INDOE pince à dissection .....	47
MEHDORN clips.....	146
MERCEDES écarteur des côtes .....	222
METZENBAUM ciseaux <b>PRIMUSLINE</b> .....	18
METZENBAUM-FINO ciseaux .....	42
METZENBAUM-FINO ciseaux <b>PRIMUSLINE</b> .....	19
METZENBAUM-NELSON ciseaux.....	40, 41
Micro ciseaux .....	130-135
Micro ciseaux à dissection .....	133
Micro clips.....	147, 148
Micro écarteurs .....	168
Micro pinces à dissection, atraumatiques .....	136
Micro pinces à dissection, atraumatiques .....	136
Micro pinces pour sutures.....	137
Micro porte-aiguilles .....	138, 139
Micro porte-lames – Micro-lames.....	14
MICRO-MOSQUITO pinces hémostatiques .....	61
MICRO-MOSQUITO pinces hémostatiques <b>PRIMUSLINE</b> .....	56
MIDDELORPF écarteurs.....	163
MIKULICZ écarteurs.....	160, 161
MILLS ciseaux vasculaires .....	27
MINI-GEMINI pinces à disséquer et à ligatures .....	67
MINI-GLOVER clamps bulldog.....	78
MINI-RYDER porte-aiguilles .....	177
MORRIS écarteurs.....	157
MORRIS-DE BAKEY pinces-clamps pour l'aorte .....	101
MORSE STERNAL écarteur des côtes .....	212, 213
MORSE-FAVALORO STERNAL écarteur des côtes.....	212
MOSQUITO-DANDY pinces hémostatiques.....	61
MÜLLER clips.....	145

**N**

NABATOFF trousse à varices.....	181
NEIVERT (MASING) porte-aiguilles.....	173
NEUMANN ciseaux.....	43
NOYES micro-ciseaux.....	130

**O**

OBWEGESER écarteurs .....	155
OCHSNER pinces-clamps pour l'aorte .....	103

OEHLER pinces à dissection à griffes .....	48
OVERHOLT pinces à disséquer et à ligatures .....	65
OVERHOLT-FINO pinces à disséquer et à ligatures.....	65
OVERHOLT-GEISSENDOERFER pinces à disséquer et à ligatures.....	64
OVERHOLT-MIXTER pince à disséquer et à ligatures.....	66
OVERHOLT-MODIFIZIERT pinces à disséquer et à ligatures.....	66

**P**

PÉAN pinces hémostatiques <b>PRIMUSLINE</b> .....	58
PÉAN-FINO pinces hémostatiques <b>PRIMUSLINE</b> .....	59
PECK-JOSEF ciseaux.....	39
Perforateurs pour l'aorte.....	190
Pince à poser des clamps bulldog.....	78, 86
Pince à poser des clips.....	142
Pinces à dissection.....	47
Pinces à dissection à griffes .....	48
Pinces à dissection, atraumatiques .....	49-53
Pinces à dissection, micro- .....	136, 137
Pinces à disséquer et à ligatures.....	64-67
Pinces à disséquer et à ligatures, atraumatiques .....	114
Pinces à ligatures .....	115
Pinces coupantes .....	229, 230
Pinces coupantes à os.....	196, 197
Pinces fémorales.....	119
Pinces gouges.....	191-195
Pinces hémostatiques .....	56-63
Pinces hémostatiques <b>PRIMUSLINE</b> .....	56-59
Pinces intestinales et de tissu.....	72-75
Pinces intestinales et de tissu <b>PRIMUSLINE</b> .....	55
Pinces pour bronches.....	69-71
Pinces pour bronches, atraumatiques.....	116
Pinces pour carotide .....	118
Pinces pour nouveaux-nés et enfants, modèles très fins .....	121-129
Pinces techniques .....	231
Pinces vasculaires .....	85-129
Pinces vasculaires périphériques.....	111-113
Pinces vasculaires pour enfants.....	124
Pinces vasculaires universelles .....	85-96
Pinces-clamps pour anastomose .....	97-100
Pinces-clamps pour anévrismes .....	107
Pinces-clamps pour anévrismes d'aorte.....	105, 106
Pinces-clamps pour coarctation .....	117
Pinces-clamps pour l'aorte .....	101-104
Pinces-clamps pour l'occlusion tangentielle.....	108-110
Pinces-clamps pour poumons.....	68
POOLE canules d'aspiration .....	6
Porte-aiguilles .....	171-179
Porte-aiguilles, micro-.....	138, 139
POTTS clamps bulldog manche à anneaux.....	120
POTTS pince-clamp pour anastomose.....	97
POTTS pinces-clamps pour coarctation.....	117
POTTS-DE MARTEL ciseaux vasculaires.....	28, 31
POTTS-SMITH (DE MARTEL) ciseaux vasculaires.....	26
POTTS-SMITH ciseaux pour cartilages.....	33
POTTS-SMITH pinces à dissection .....	47
Presse-tubes .....	150, 151
PRICE-THOMAS pinces pour bronches .....	69
PROVIDENCE HOSPITAL pinces hémostatiques .....	61

## Inhaltsverzeichnis Index

## Tables de matières

### Indice

### Indice

<b>Q</b>			
QUINBY ciseaux.....	43	TUFFIER écarteur des côtes .....	216
<b>R</b>		<b>V</b>	
Raccords d'aspiration.....	10	VAN BUREN davier porte-os.....	198
Rapprocheurs des côtes.....	226	VARADY dissecteurs.....	182
RESANO ciseaux.....	32	VASCULAR porte-aiguilles .....	177, 179
REYNOLDS (JAMESON) ciseaux.....	45	VEHMEHREN costotome .....	205
REYNOLDS ciseaux <b>PRIMUSLINE</b> .....	21	<b>W</b>	
RONALD-EDWARDS écarteur des côtes .....	218	WANGENSTEEN pinces à dissection .....	47
ROSS presse-tubes .....	151	WANGENSTEEN porte-aiguilles.....	175
ROSS raccords d'aspiration .....	10	WEBER pinces-clamps pour l'aorte .....	102
RÖTTGEN-RUSKIN pince gouge .....	194	WEBSTER porte-aiguilles.....	172
Rugines - Elevateurs .....	200, 201	WEITLANER-LOCKTITE écarteur autostatiques.....	169
RUMEL-BELMONT tourniquet.....	180	WESTCOTT ciseaux à ténatomie .....	35
RUSKIN pinces gouges.....	191	WILLAUER ciseaux à lobectomie.....	32
RUSKIN-LISTON pinces coupantes à os.....	196	WILLIAMS pince intestinale.....	72
RYDER porte-aiguilles .....	177, 178	WILLIGER éleveurs .....	201
<b>S</b>		<b>Y</b>	
SANTULLI clamp bulldog.....	82	YANKAUER canule d'aspiration .....	6
SAROT pinces pour bronches.....	70	YASARGIL micro-ciseaux.....	131, 132
SAROT porte-aiguilles .....	176	<b>Z</b>	
SATINSKY ciseaux pour le thorax.....	34	ZENKER écarteurs .....	162
SATINSKY pinces pour bronches.....	71		
SATINSKY-DE BAKEY pinces-clamps pour l'occlusion tangentielle .....	108		
SAUERBRUCH costotome .....	204		
SAUERBRUCH écarteurs .....	155		
SAUERBRUCH pinces gouges.....	195		
SAUERBRUCH-FREY costotome.....	203		
SELLORS écarteur des côtes.....	219		
SELLORS rapprocheur des côtes .....	226		
SEMB davier porte-os .....	199		
SEMB pince coupante à os.....	197		
SEMB pince gouge.....	194		
SEMB pinces pour bronches .....	70		
SIMON écarteurs.....	159		
SOUTHAMPTON canule d'aspiration .....	8		
Spatules pulmonaires.....	225		
ST. MARKS écarteurs .....	164		
STANDARD manches pour bistouris.....	11		
STANDARD pinces à dissection.....	47		
STEVENS ciseaux <b>PRIMUSLINE</b> .....	23		
STILLE costotomes.....	202		
STILLE pinces gouges.....	192		
STILLE-LISTON pinces coupantes à os.....	196		
STILLE-LUER pinces gouges.....	193		
STILLE-RUSKIN pinces gouges.....	192		
STRATTE porte-aiguilles .....	174		
<b>T</b>			
TAYLOR pince à dissection .....	47		
TEKNO-TWIST porte-aiguilles.....	176		
TERRIER pince hémostatique .....	60		
THOMS-ALLIS pince intestinale .....	72		
Tire-veins.....	180		
TOENNIS-ADSON ciseaux pour les amygdales .....	36		
Tourniquet .....	180		
Trousse à varices.....	181		
TUBBS dilateur aortique.....	186		

**Inhaltsverzeichnis  
Index**
**Tables de matières  
Indice  
Indice**

<b>A</b>	
ADSON pinzas de disección .....	47, 48
ADSON raspatorios .....	200
ADSON-BROWN pinza de disección .....	48
ADSON-micro pinzas de disección .....	48
Alicates para cortar alambre .....	229, 230
ALLIS pinzas para intestinos .....	72
ALLIS pinzas para intestinos <b>PRIMUSLINE</b> .....	55
ALLIS-ADAIR pinza para intestinos .....	72
ALLIS-ATRAUMA pinza para intestinos .....	75
ALLIS-BABY pinza para intestinos .....	72
ALLISON espátulas pulmonares .....	225
ANDREWS-PYNCHON tubo de aspiración .....	6
ANKENEY separador costal .....	223
Aplicadora para clips vasculares .....	142
Aplicador para clamps Bulldog .....	78, 86
Aproximadores para costillas .....	226
Aproximadores, clips vasculares .....	143
Aproximadores, clips vasculares según Biemer .....	144
Aproximadores, clips vasculares según Müller .....	145
<b>B</b>	
BABCOCK pinza para intestinos .....	73
BABCOCK pinzas para intestinos <b>PRIMUSLINE</b> .....	55
BABCOCK-ATRAUMA pinza para intestinos .....	75
BABY METZENBAUM tijeras <b>PRIMUSLINE</b> .....	19
BABY-CRILE-WOOD porta-agujas .....	171
BABY-HAIGHT separador costal .....	214
BABY-SATINSKY pinza bronquial .....	71
BAILEY aproximador para costillas .....	226
BAILEY-BABY aproximador para costillas .....	226
BAILEY-GIBBON aproximador para costillas .....	226
BAINBRIDGE, LIGHT pinzas vasculares .....	85
BARRON mango de bisturí .....	11
BECK pinza para anastomosis .....	97
BETHUNE costótomo .....	204
BEYER pinza gubia .....	191
BIEMER clips vasculares .....	144
BLALOCK separador .....	158
BÖHLER pinzas cortantes para huesos .....	196
BOROWSKI separador .....	168
BOYS-ALLIS pinza para intestinos .....	73
BOZEMANN (WERTHEIM) porta-agujas .....	174
BRIDGE pinzas para preparación y suturas .....	66
BROCKS separador .....	158
BROMPTON separador .....	158
BROPHY (SULLIVAN) tijeras .....	39
BRUNNER costótomos .....	203
BURFORD separador costal .....	207
<b>C</b>	
CASTAÑEDA pinzas para recién nacidos .....	121
CASTROVIEJO-JACOBSON porta-agujas .....	179
CHRISTOPHE pinzas hemostáticas .....	62
Clamps Bulldog .....	76-83
Clamps Bulldog, mangos con anillos .....	120
Clips vasculares según Biemer .....	144
Clips vasculares según Mehdorn, aplicadora .....	146
Clips vasculares según Müller .....	149
COLLIN mango de bisturí .....	11

Contenedores de esterilización, acero inoxidable .....	140
CONVERSE porta-agujas .....	173
COOLEY clamps Bulldog .....	83
COOLEY dilatador de aorta .....	186
COOLEY dilatadores vasculares .....	183
COOLEY PATENT DUCTUS CLAMP .....	95
COOLEY pinzas para anastomosis .....	100
COOLEY pinzas para oclusión tangencial .....	109, 110
COOLEY pinzas vasculares de usos múltiples .....	92-96
COOLEY separador .....	165-167
COOLEY separador costal .....	209-211
COOLEY tubos de aspiración .....	7
COOLEY-BECK pinzas para anastomosis .....	100
COOLEY-DERRA pinzas para anastomosis .....	99
Costótomos .....	202-205
CRAFOORD aproximador para costillas .....	226
CRAFOORD tijera para lobectomía .....	32
CRILE pinzas hemostáticas .....	63
CRILE pinzas hemostáticas <b>PRIMUSLINE</b> .....	57
CRILE-RANKIN pinzas hemostáticas .....	63
CRILE-RANKIN pinzas hemostáticas <b>PRIMUSLINE</b> .....	57
CRILE-WOOD porta-agujas .....	171
CUSHING pinza de disección .....	47
CUSHING separadores .....	153
CZERNY separador .....	158
<b>D</b>	
DALE pinzas para vasos periféricos .....	113
DANDY pinzas hemostáticas .....	61
DARDIK pinzas vasculares de usos múltiples .....	88
DAVIDSON separador .....	161
DE BAKEY BAYONET pinzas de disección atraumáticas .....	52
DE BAKEY clamps Bulldog .....	80
DE BAKEY dilatadores vasculares .....	183
DE BAKEY pinza aórtica .....	104
DE BAKEY pinzas de disección atraumáticas .....	49-51
DE BAKEY pinzas para aneurisma aórtica .....	105, 106
DE BAKEY pinzas para ligaduras .....	115
DE BAKEY pinzas para preparación y suturas .....	114
DE BAKEY pinzas vasculares de usos múltiples .....	85-87, 89
DE BAKEY pinzas vasculares pediátricas .....	124
DE BAKEY porta-agujas .....	176
DE BAKEY separador costal .....	217, 220
DE BAKEY tijeras vasculares .....	27, 31
DE BAKEY tubo de aspiración .....	6
DE BAKEY-ADSON pinza de disección atraumática .....	52
DE BAKEY-BAHNSON pinzas para aneurisma .....	107
DE BAKEY-CAROTIS clamp Bulldog .....	82
DE BAKEY-DIETHRICH clamps Bulldog .....	79
DE BAKEY-GERALD pinzas de disección atraumática .....	52
DE BAKEY-SATINSKY clamp Bulldog .....	82
DE BAKEY-SEMB pinzas para ligaduras .....	115
DE BAKEY-WYLIE pinzas para vasos periféricos .....	112
DE BOER (Sternal) separador costal .....	216
DEAN tijera para amigdalas .....	36
DEMEL aguja de guía .....	227
DEMEL instrumento de alambre .....	227
DERF (WRIGHT) porta-agujas .....	172
DERRA pinzas para anastomosis .....	97
DESMARRES separadores .....	152

## Inhaltsverzeichnis Index

## Tables de matières Indice Indice

DIEFFENBACH clamps Bulldog.....	77
DIETHRICH clamps Bulldog.....	77
DIETHRICH pinza aórtica.....	103
DIETHRICH porta-agujas.....	177
DIETHRICH-HEGEMANN tijeras vasculares.....	29
Dilatadores de aorta.....	186
Dilatadores vasculares.....	183-185
Disectores.....	182
DUVAL pinza para intestinos.....	74

**E**

Espátulas pulmonares.....	225
---------------------------	-----

**F**

FARABEUF raspatorios.....	200
FARABEUF-COLLIN raspatorios.....	201
FAVALORO tijera vascular.....	27
FERGUSSON pinza para huesos.....	198
FERGUSSON tubos de aspiración.....	9
FINOCHIETTO porta-agujas.....	175
FINOCHIETTO separador costal.....	208, 214, 215
FINOCHIETTO tijera para lobectomía.....	32
FINOCHIETTO-BABY separador costal.....	215
FINOCHIETTO-BABY-HAIGHT separador costal.....	208
FINOCHIETTO-INFANT separador costal.....	208, 216
Fleboextractores.....	180
FRAZIER tubos de aspiración.....	9
FULTON tijera vascular.....	26

**G**

GARRETT dilatadores vasculares.....	184
GEMINI pinzas para preparación y suturas.....	67
GIERTZ-STILLE costótomo.....	204
GILLIES pinza de disección con dientes.....	48
GIL-VERNET separadores.....	153
GLOVER clamps Bulldog.....	81
GLOVER pinzas vasculares de usos múltiples.....	90, 91
GLUCK costótomos.....	202
GORNEY tijeras.....	46
GREGORY pinzas para la profundidad.....	119
GREGORY-SOFT clamps Bulldog.....	82
GUNNAR pinza para tubos.....	151

**H**

HALSEY porta-agujas.....	172
HALSTED-MOSQUITO pinzas hemostáticas.....	60
HALSTED-MOSQUITO pinzas hemostáticas <b>PRIMUSLINE</b> .....	56
HAMMERSMITH tubos de aspiración.....	8
HARRINGTON separador.....	159
HARTMANN pinzas hemostáticas.....	60
HARTMANN pinzas hemostáticas <b>PRIMUSLINE</b> .....	56
HEANEY porta-agujas.....	174
HEGAR dilatadores vasculares.....	185
HEGAR-BAUMGARTNER porta-agujas.....	171
HOHENFELLNER tijeras vasculares.....	30
Hojas de bisturí.....	13

**I**

Instrumentos para alambre.....	227, 228
--------------------------------	----------

**J**

JAVID pinzas para shunt carótido.....	118
JOHNS-HOPKINS clamps Bulldog.....	76, 77
JORGENSEN tijera para el torax.....	34
JOSEPH tijera <b>PRIMUSLINE</b> .....	22
JOSEPH tijeras.....	46
JUDD-ALLIS pinza para intestinos.....	73
Juego de tunelización.....	187-189
Juego para várices.....	181

**K**

KELLY pinzas hemostáticas.....	63
KELLY pinzas hemostáticas <b>PRIMUSLINE</b> .....	57
KELLY tijeras.....	38
KELLY tijeras <b>PRIMUSLINE</b> .....	22
KELLY-RANKIN pinzas hemostáticas.....	63
KELLY-RANKIN pinzas hemostáticas <b>PRIMUSLINE</b> .....	57
KILNER (RAGNELL) tijeras.....	45
KILNER porta-agujas.....	172
KITZMILLER pinzas para recién nacidos.....	128
KLINIKUM BERLIN pinza para tubos.....	150
KLINKENBERG-LOTH tijera para torax.....	34
KNAPP (ROLLET) separador.....	152
KOCHER pinzas hemostáticas.....	58
KOCHER separador.....	156
KOCHER-FINO pinzas hemostáticas.....	59
KOCHER-LANGENBECK (OBWEGESER) separadores.....	154

**L**

LAHEY separador.....	156
LAMBERT-KAY pinzas para anastomosis.....	98
LAMBOTTE raspatorios.....	200
LANGENBECK pinza para huesos.....	199
LANGENBECK separadores.....	154
LEBSCHE gancho.....	203
LEES pinzas bronquiales.....	116
LEKSELL pinzas gubias.....	193
LELAND-JONES pinzas para vasos periféricos.....	111
LEMMON aproximadores para costillas.....	226
LERICHE pinzas hemostáticas.....	62
LEXER tijeras.....	38
LEXER tijeras <b>PRIMUSLINE</b> .....	20
LINCOLN tijeras vasculares.....	26
LISTON-KEY HORSLEY pinza cortante para huesos.....	197
LITTLEWOOD pinza para intestinos.....	73
LOCKLIN tijeras.....	43
LOCKWOOD pinza para intestinos.....	72
LOUTE instrumento para alambres.....	228
LOVELACE pinzas hemostáticas.....	62
LOVELACE pinzas para coger pulmones.....	68
LUER-STILLE pinzas gubias.....	195

**M**

Mammaria separador costal.....	224
Mango de bisturí.....	11, 12
MARTIN-CARTILAGE tijera para cartilagos.....	33
MARTINEZ pinzas para recién nacidos.....	129
MASSON porta-agujas.....	175
MATHIEU-OLSEN porta-agujas.....	173
MAYFIELD pinza gubia.....	191

**Inhaltsverzeichnis  
Index**
**Tables de matières  
Indice  
Indice**

MAYO tijeras.....	37
MAYO-HEGAR porta-agujas .....	173
MAYO-LEXER tijeras <b>PRIMUSLINE</b> .....	20
MAYO-STILLE tijeras <b>PRIMUSLINE</b> .....	21
MC INDOE pinza de disección.....	47
MC INDOE (METZENBAUM) tijeras.....	43
MC INDOE tijera para cartilagos .....	33
MEHDORN clips vasculares.....	146
MERCEDES separador costal .....	222
METZENBAUM tijeras <b>PRIMUSLINE</b> .....	18
METZENBAUM-FINO tijeras .....	42
METZENBAUM-FINO tijeras <b>PRIMUSLINE</b> .....	19
METZENBAUM-NELSON tijeras.....	40, 41
Micro clips vasculares.....	147, 148
Micro pinzas atraumaticas .....	136
Micro pinzas de disección, atraumaticas .....	136
Micro pinzas de suturas .....	137
Micro porta-agujas.....	138, 139
Micro separador .....	168
Micro tijeras .....	130-135
MICRO-MOSQUITO pinzas hemostáticas.....	61
MICRO-MOSQUITO pinzas hemostáticas <b>PRIMUSLINE</b> .....	56
MIDDELDORPF separadores .....	163
MIKULICZ separadores .....	160, 161
MILLS tijera vascular .....	27
MINI-GEMINI pinzas para preparación y suturas.....	67
MINI-GLOVER clamps Bulldog.....	78
MINI-RYDER porta-agujas .....	177
MORRIS separadores .....	157
MORRIS-DE BAKEY pinzas aórticas .....	101
MORSE STERNAL separador costal.....	212, 213
MORSE-FAVALORO STERNAL separador costal.....	212
MOSQUITO-DANDY pinzas hemostáticas .....	61
MÜLLER clips vasculares .....	145
<b>N</b>	
NABATOFF juego para várices.....	181
NEIVERT (MASING) porta-agujas .....	173
NEUMANN tijera.....	43
NOYES micro-tijeras.....	130
<b>O</b>	
OBWEGESER separadores.....	155
OCHSNER pinzas aórticas.....	103
OEHLER pinzas de disección con dientes .....	48
OVERHOLT pinzas para preparación y suturas.....	65
OVERHOLT-FINO pinzas para preparación y suturas .....	65
OVERHOLT-GEISSENDOERFER pinzas para preparación y suturas .....	64
OVERHOLT-MIXTER pinza para preparación y suturas.....	66
OVERHOLT-MODIFIZIERT pinzas para preparación y suturas .....	66
<b>P</b>	
PÉAN pinzas hemostáticas <b>PRIMUSLINE</b> .....	58
PÉAN-FINO pinzas hemostáticas <b>PRIMUSLINE</b> .....	59
PECK-JOSEF tijeras.....	39
Perforadores aórticos .....	190
Pinzas aórticas .....	101-104
Pinzas atraumaticas .....	49-53
Pinzas bronquiales y vasculares.....	69-71
Pinzas bronquiales, atraumaticas .....	116

Pinzas cortantes para huesos .....	196, 197
Pinzas de disección .....	47, 48
Pinzas de disección con dientes .....	48
Pinzas de disección, atraumaticas .....	49-53
Pinzas de disección, micro-.....	136, 137
Pinzas gubias.....	191-195
Pinzas hemostáticas.....	56-63
Pinzas hemostáticas <b>PRIMUSLINE</b> .....	56-59
Pinzas para anastomosis.....	97-100
Pinzas para aneurisma .....	107
Pinzas para aneurisma aórtica .....	105, 106
Pinzas para coarctación .....	117
Pinzas para coger pulmones .....	68
Pinzas para huesos.....	198, 199
Pinzas para intestinos y tejidos.....	72-75
Pinzas para intestinos y tejidos <b>PRIMUSLINE</b> .....	55
Pinzas para la profundidad.....	119
Pinzas para ligaduras.....	115
Pinzas para oclusión tangencial .....	108-110
Pinzas para preparación y suturas .....	64-67
Pinzas para preparación y suturas, atraumaticas .....	114
Pinzas para recién nacidos y niños, modelos muy finos .....	121-129
Pinzas para shunt carótido.....	118
Pinzas para tubos .....	150, 151
Pinzas para vasos periféricos.....	111-113
Pinzas tecnicas.....	231
Pinzas vasculares .....	85-129
Pinzas vasculares de usos múltiples .....	85-96
Pinzas vasculares pediátricas .....	124
POOLE tubos de aspiración.....	6
Porta micro-hojas - Micro-hojas .....	14
Porta-agujas .....	171-179
Porta-agujas, micro-.....	138, 139
POTTS clamps Bulldog con mangos de anillos.....	120
POTTS pinza para anastomosis.....	97
POTTS pinzas para coarctación.....	117
POTTS-DE MARTEL tijeras vasculares.....	28, 31
POTTS-SMITH (DE MARTEL) tijera vascular .....	26
POTTS-SMITH pinzas de disección .....	47
POTTS-SMITH tijera para cartilagos.....	33
PRICE-THOMAS pinzas bronquiales .....	69
PROVIDENCE HOSPITAL pinzas hemostáticas.....	61

**Q**

QUINBY tijera .....	43
---------------------	----

**R**

Raspatorios - Elevadores.....	200, 201
RESANO tijera .....	32
REYNOLDS (JAMESON) tijeras .....	45
REYNOLDS tijeras <b>PRIMUSLINE</b> .....	21
RONALD-EDWARDS separador costal .....	218
ROSS pinza para tubos.....	151
ROSS terminales para aspiración.....	10
RÖTTGEN-RUSKIN pinza gubia.....	194
RUMEL-BELMONT tourniquete .....	180
RUSKIN pinzas gubias .....	191
RUSKIN-LISTON pinzas cortantes para huesos .....	196
RYDER porta-agujas .....	177, 178

## Inhaltsverzeichnis Index

## Tables de matières Indice Indice

<b>S</b>			
SANTULLI clamp Bulldog.....	82	Tubos de aspiración.....	6-9
SAROT pinzas bronquiales.....	70	TUFFIER separador costal.....	216
SAROT porta-agujas.....	176	<b>V</b>	
SATINSKY pinzas bronquiales.....	71	VAN BUREN pinza para huesos.....	198
SATINSKY tijera para torax.....	34	VARADY disectores.....	182
SATINSKY-DE BAKEY pinzas para oclusión tangencial.....	108	VASCULAR porta-agujas.....	177, 179
SAUERBRUCH costótomo.....	204	VEHMEHREN costótomo.....	205
SAUERBRUCH pinzas gubias.....	195	<b>W</b>	
SAUERBRUCH separador.....	155	WANGENSTEEN pinzas de disección.....	47
SAUERBRUCH-FREY costótomo.....	203	WANGENSTEEN porta-agujas.....	175
SELLORS aproximador para costillas.....	226	WEBER pinzas aórticas.....	102
SELLORS separador costal.....	219	WEBSTER porta-agujas.....	172
SEMB pinza cortante para huesos.....	197	WEITLANER-LOCKTITE separadores autoestáticos.....	169
SEMB pinza gubia.....	194	WESTCOTT tijeras para tenotomía.....	35
SEMB pinza para huesos.....	199	WILLAUER tijera para lobectomía.....	32
SEMB pinzas bronquiales.....	70	WILLIAMS pinza para intestinos.....	72
Separador costal.....	207-224	WILLIGER elevadores.....	201
Separador costal, aluminio.....	206	<b>Y</b>	
Separador torácico e I.M.A.....	223	YANKAUER tubo de aspiración.....	6
Separadores.....	152-168	YASARGIL micro-tijeras.....	131, 132
Separadores autoestáticos.....	169	<b>Z</b>	
SIMON separador.....	159	ZENKER separadores.....	162
SOUTHAMPTON tubo de aspiración.....	8		
ST. MARKS separador.....	164		
STANDARD mango de bisturí.....	11		
STANDARD pinzas de disección.....	47		
STEVENS tijeras <b>PRIMUSLINE</b> .....	23		
STILLE costótomos.....	202		
STILLE pinzas gubias.....	192		
STILLE-LISTON pinzas cortantes para huesos.....	196		
STILLE-LUER pinzas gubias.....	193		
STILLE-RUSKIN pinzas gubias.....	192		
STRATTE porta-agujas.....	174		
<b>T</b>			
TAYLOR pinza de disección.....	47		
TEKNO-TWIST porta-agujas.....	176		
Terminales para aspiración.....	10		
TERRIER pinza hemostática.....	60		
THOMS-ALLIS pinza para intestinos.....	72		
Tijeras.....	15-46		
Tijeras de disección.....	37-42		
Tijeras finas- Tijeras para iridectomía.....	43-44		
Tijeras micro.....	130-135		
Tijeras para amígdalas.....	36		
Tijeras para cartilagos.....	33		
Tijeras para cirugía.....	37-39		
Tijeras para el torax.....	34		
Tijeras para estrabismo.....	44		
Tijeras para la cirugía plástica.....	45, 46		
Tijeras para lobectomía.....	32		
Tijeras para tenotomía.....	35		
Tijeras <b>PRIMUSLINE</b> .....	15-23		
Tijeras vasculares.....	26-31		
Tijeras de cirugía - Tijeras de disección.....	40-42		
Tijeras para iridectomía <b>PRIMUSLINE</b> .....	23		
TOENNIS-ADSON tijera para amígdalas.....	36		
Tourniquete.....	180		
TUBBS dilatador de aorta.....	186		

**Inhaltsverzeichnis  
Index**
**Tables de matières  
Indice  
Indice**

<b>A</b>	
ADSON periostotomi	200
ADSON pinze	47, 48
ADSON-BROWN pinza	48
ADSON-MICRO pinze	48
ALLIS pinze per intestino	72
ALLIS pinze per intestino <b>PRIMUSLINE</b>	55
ALLIS-ADAIR pinza per intestino	72
ALLIS-ATRAUMA pinze per intestino	75
ALLIS-BABY pinza per intestino	72
ALLISON spatole polmonare	225
ANDREWS-PYNCHON tubo per aspirazione	6
ANKENEY divaricatore per il torace	223
Approssimatori costali	226
Approssimatori, clips vascolari	143
Approssimatori, clips vascolari Biemer	144
Approssimatori, clips vascolari Müller	145
Astuccio per tunnelizzazione	187-189
Astuccio per varici	181

<b>B</b>	
BABCOCK pinze per intestino	73
BABCOCK pinze per intestino <b>PRIMUSLINE</b>	55
BABCOCK-ATRAUMA pinze per intestino	75
BABY METZENBAUM forbici <b>PRIMUSLINE</b>	19
BABY-CRILE-WOOD porta aghi	171
BABY-HAIGHT divaricatore costale	214
BABY-SATINSKY pinze per bronchi	71
BAILEY approssimatore costale	226
BAILEY-BABY approssimatore costale	226
BAILEY-GIBBON approssimatore costale	226
BAINBRIDGE, LIGHT pinze vascolari	85
BARRON manico per bisturi	11
BECK pinze per anastomosi	97
BETHUNE costotomo	204
BEYER pinza sgorbia	191
BIEMER clips vascolari	144
BLALOCK divaricatore	158
BÖHLER cesoie per ossa	196
BOROWSKI divaricatori	168
BOYS-ALLIS pinza per intestino	73
BOZEMANN (WERTHEIM) porta aghi	174
BRIDGE pinze per preparazioni e suture	66
BROCKS divaricatore	158
BROMPTON divaricatore	158
BROPHY (SULLIVAN) forbici	39
BRUNNER costotomi	203
BURFORD divaricatori costali	207

<b>C</b>	
CASTAÑEDA pinze per neonati	121
CASTROVIEJO-JACOBSON porta aghi	179
Cesoie per ossa	196, 197
CHRISTOPHE pinze emostatiche	62
Clips vascolari Biemer	144
Clips vascolari Mehdorn, pinza posa clips	146
Clips vascolari Müller	149
COLLIN manico per bisturi	11
CONVERSE porta aghi	173
COOLEY dilatatore per aorta	186

COOLEY dilatatori vascolari	183
COOLEY divaricatori	165-167
COOLEY divaricatori costali	209-211
COOLEY PATENT DUCTUS CLAMP	95
COOLEY pinze Bulldog	83
COOLEY pinze per anastomosi	100
COOLEY pinze per occlusioni tangenziale	109, 110
COOLEY pinze vascolari universali	92-96
COOLEY tubi per aspirazione	7
COOLEY-BECK pinze per anastomosi	100
COOLEY-DERRA pinze per anastomosi	99
Costotomi	202-205
CRAFOORD approssimatore costale	226
CRAFOORD forbici per lobectomia	32
CRILE pinze emostatiche	63
CRILE pinze emostatiche <b>PRIMUSLINE</b>	57
CRILE-RANKIN pinze emostatiche	63
CRILE-RANKIN pinze emostatiche <b>PRIMUSLINE</b>	57
CRILE-WOOD porta aghi	171
CUSHING divaricatori	153
CUSHING pinze anatomiche	47
CZERNY divaricatore	158

<b>D</b>	
DALE pinze vascolari periferali	113
DANDY pinze emostatiche	61
DARDIK pinze vascolari universali	88
DAVIDSON divaricatore	161
DE BAKEY BAYONET pinze atraumatiche	52
DE BAKEY dilatatori vascolari	183
DE BAKEY divaricatori costali	217, 220
DE BAKEY forbici vascolari	27, 31
DE BAKEY pinze vascolari pediatriche	124
DE BAKEY pinza per aorta	104
DE BAKEY pinze atraumatiche	49-51
DE BAKEY pinze Bulldog	80
DE BAKEY pinze per legature	115
DE BAKEY pinze per preparazione e legature	114
DE BAKEY pinze vascolari universali	85-87, 89
DE BAKEY porta aghi	176
DE BAKEY tubo per aspirazione	6
DE BAKEY-ADSON pinza atraumatica	52
DE BAKEY-BAHNSON pinze per aneurisma	107
DE BAKEY-CAROTIS pinza Bulldog	82
DE BAKEY-DIETHRICH pinze Bulldog	79
DE BAKEY-GERALD pinze atraumatiche	52
DE BAKEY pinze per aneurisma della aorta	105, 106
DE BAKEY-SATINSKY pinza Bulldog	82
DE BAKEY-SEMB pinze per legature	115
DE BAKEY-WYLIE pinze vascolari periferali	112
DE BOER (Sternal) divaricatori costali	216
DEAN forbici per tonsille	36
DEMEL aghi guida	227
DEMEL strumento per filo di cerchiaggio	227
DERF (WRIGHT) porta aghi	172
DERRA pinze per anastomosi	97
DESMARRES divaricatori	152
DIEFFENBACH pinze Bulldog	77
DIETHRICH pinza per aorta	103
DIETHRICH pinze Bulldog	77



## Inhaltsverzeichnis Index

## Tables de matières Indice Indice

DIETHRICH porta aghi.....	177	HARRINGTON divaricatori.....	159
DIETHRICH-HEGEMANN forbici vascolari.....	29	HARTMANN pinze emostatiche.....	60
Dilatatori per aorta.....	186	HARTMANN pinze emostatiche <b>PRIMUSLINE</b> .....	56
Dilatatori vascolari.....	183-185	HEANEY porta aghi.....	174
Dissettori.....	182	HEGAR dilatatori vascolari.....	185
Divaricatore per il torace ed I.M.A.....	223	HEGAR-BAUMGARTNER porta aghi.....	171
Divaricatori.....	152-168	HOHENFELLNER forbici vascolari.....	30
Divaricatori autostatici.....	169		
Divaricatori costali.....	207-224	<b>J</b>	
Divaricatori costali in alluminio.....	206	JAVID pinze carotis.....	118
DUVAL pinze per intestino.....	74	JOHNS-HOPKINS pinze Bulldog.....	76, 77
		JORGENSEN forbici per torace.....	34
<b>F</b>		JOSEPH forbici.....	46
FARABEUF periostotomi.....	200	JOSEPH forbici <b>PRIMUSLINE</b> .....	22
FARABEUF-COLLIN periostotomi.....	201	JUDD-ALLIS pinze per intestino.....	73
FAVALORO forbici vascolari.....	27		
FERGUSSON tenaglie per ossa.....	198	<b>K</b>	
FERGUSSON tubo per aspirazione.....	9	KELLY forbici.....	38
FINOCHIETTO divaricatori costali.....	208, 214, 215	KELLY forbici <b>PRIMUSLINE</b> .....	22
FINOCHIETTO forbici per lobectomia.....	32	KELLY pinze emostatiche.....	63
FINOCHIETTO porta aghi.....	175	KELLY pinze emostatiche <b>PRIMUSLINE</b> .....	57
FINOCHIETTO-BABY divaricatori costali.....	215	KELLY-RANKIN pinze emostatiche.....	63
FINOCHIETTO-BABY-HAIGHT divaricatori costali.....	208	KELLY-RANKIN pinze emostatiche <b>PRIMUSLINE</b> .....	57
FINOCHIETTO-INFANT divaricatori costali.....	208, 216	KILNER (RAGNELL) forbici.....	45
Forbici.....	15-46	KILNER porta aghi.....	172
Forbici chirurgiche - Forbici per dissezione.....	37-42	KITZMILLER pinze per neonati.....	128
Forbici fini - Forbici per iridectomia.....	43-44	KLINIKUM BERLIN pinze serratubi.....	150
Forbici micro.....	130-135	KLINKENBERG-LOTH forbici per torace.....	34
Forbici per cartilagini.....	33	KNAPP (ROLLET) divaricatori.....	152
Forbici per chirurgia plastica.....	45, 46	KOCHER divaricatori.....	156
Forbici per iridectomia <b>PRIMUSLINE</b> .....	23	KOCHER pinze emostatiche.....	58
Forbici per lobectomia.....	32	KOCHER-FINO pinze emostatiche.....	59
Forbici per strabismo.....	44	KOCHER-LANGENBECK (OBWEGESER) divaricatori.....	154
Forbici per tenotomia.....	35		
Forbici per tonsille.....	36	<b>L</b>	
Forbici per torace.....	34	LAHEY divaricatori.....	156
Forbici <b>PRIMUSLINE</b> .....	15-23	LAMBERT-KAY pinze per anastomosi.....	98
Forbici vascolari.....	26-31	LAMBOTTE periostotomi.....	200
FRAZIER tubi per aspirazione.....	9	Lame per bisturi.....	13
FULTON forbici vascolari.....	26	LANGENBECK divaricatori.....	154
		LANGENBECK tenaglie per ossa.....	199
<b>G</b>		LEBSCHÉ uncino.....	203
GARRETT dilatatori vascolari.....	184	LEES pinze per bronchi.....	116
GEMINI pinze per preparazione e suture.....	67	LEKSELL pinze sgorbie.....	193
GIERTZ-STILLE costotomo.....	204	LELAND-JONES pinze vascolari periferali.....	111
GILLIES pinza chirurgica.....	48	LEMMON approssimatori costali.....	226
GIL-VERNET divaricatori.....	153	LERICHE pinze emostatiche.....	62
GLOVER pinze Bulldog.....	81	LEXER forbici.....	38
GLOVER pinze vascolari universali.....	90, 91	LEXER forbici <b>PRIMUSLINE</b> .....	20
GLUCK costotomi.....	202	LINCOLN forbici vascolari.....	26
GORNEY forbici.....	46	LISTON-KEY HORSLEY cesoia per ossa.....	197
GREGORY pinze profunda.....	119	LITTLEWOOD pinza per intestino.....	73
GREGORY-SOFT pinze Bulldog.....	82	LOCKLIN forbici.....	43
GUNNAR pinze serratubi.....	151	LOCKWOOD pinza per intestino.....	72
		LOUTE strumento per filo di cerchiaggio.....	228
<b>H</b>		LOVELACE pinze emostatiche.....	62
HALSEY porta aghi.....	172	LOVELACE pinze per afferrare il pomone.....	68
HALSTED-MOSQUITO pinze emostatiche.....	60	LUER-STILLE pinze sgorbie.....	195
HALSTED-MOSQUITO pinze emostatiche <b>PRIMUSLINE</b> .....	56		
HAMMERSMITH tubi per aspirazione.....	8		

**Inhaltsverzeichnis  
Index**
**Tables de matières  
Indice  
Indice**

<b>M</b>	
MAMMARIA divaricatori costali.....	223, 224
Manici per bisturi .....	11, 12
MARTIN-CARTILAGE forbici per cartilagini .....	33
MARTINEZ pinze per neonati.....	129
MASSON porta aghi .....	175
MATHIEU-OLSEN porta aghi .....	173
MAYFIELD pinza sgorbia.....	191
MAYO forbici.....	37
MAYO-HEGAR porta aghi.....	173
MAYO-LEXER forbici <b>PRIMUSLINE</b> .....	20
MAYO-STILLE forbici <b>PRIMUSLINE</b> .....	21
MC INDOE (METZENBAUM) forbici .....	43
MC INDOE forbici per caratalagine .....	33
MC INDOE pinza.....	47
MEHDORN clips vascolari .....	146
MERCEDES divaricatore per il torace.....	222
METZENBAUM forbici <b>PRIMUSLINE</b> .....	18
METZENBAUM-FINO forbici .....	42
METZENBAUM-FINO forbici <b>PRIMUSLINE</b> .....	19
METZENBAUM-NELSON forbici.....	40, 41
Micro clips per vasi .....	147, 148
Micro divaricatori .....	168
Micro forbici .....	130-135
Micro forbici per dissezione .....	133
Micro pinze, atraumatiche.....	136
Micro porta aghi.....	138, 139
MICRO-MOSQUITO pinze emostatiche .....	61
MICRO-MOSQUITO pinze emostatiche <b>PRIMUSLINE</b> .....	56
MIDDELDORPF divaricatori .....	163
MIKULICZ divaricatori .....	160, 161
MILLS forbici vascolari .....	27
MINI-GEMINI pinze per preparazione e suture .....	67
MINI-GLOVER pinze Bulldog.....	78
MINI-RYDER porta aghi .....	177
MORRIS divaricatori.....	157
MORRIS-DE BAKEY pinze per aorta .....	101
MORSE STERNAL divaricatori costali.....	212, 213
MORSE-FAVALORO STERNAL divaricatori costali.....	212
MOSQUITO-DANDY pinze emostatiche.....	61
MÜLLER clips vascolari .....	145
<b>N</b>	
NABATOFF astuccio per varici.....	181
NEIVERT (MASING) porta aghi.....	173
NEUMANN forbici.....	43
NOYES micro forbici.....	130
<b>O</b>	
OBWEGESER divaricatori.....	155
OCHSNER pinze per aorta.....	103
OEHLER pinze chirurgiche.....	48
OVERHOLT pinze per preparazione e suture .....	65
OVERHOLT-FINO pinze per preparazione e suture.....	65
OVERHOLT-GEISSENDOERFER pinze per preparazione e suture.....	64
OVERHOLT-MIXTER pinze per preparazione e suture .....	66
OVERHOLT-MODIFIZIERT pinze per preparazione e suture.....	66
<b>P</b>	
PÉAN pinze emostatiche <b>PRIMUSLINE</b> .....	58

PÉAN-FINO pinze emostatiche <b>PRIMUSLINE</b> .....	59
PECK-JOSEF forbici.....	39
Perforatori per aorta .....	190
Periostotomi - Elevatori .....	200, 201
Pinze anatomiche .....	47, 48
Pinze atraumatiche.....	49-53
Pinze atraumatiche micro.....	136
Pinze Bulldog.....	76-83
Pinze Bulldog con manici ad anelli .....	120
Pinze Carotis .....	118
Pinze chirurgiche.....	48
Pinze emostatiche .....	56-63
Pinze emostatiche <b>PRIMUSLINE</b> .....	56-59
Pinze micro .....	136, 137
Pinze per afferrare il pomone.....	68
Pinze per anastomosi .....	97-100
Pinze per aneurisma .....	107
Pinze per aneurisma della aorta.....	105, 106
Pinze per aorta .....	101-104
Pinze per bambini e neonati, molto fine.....	121-129
Pinze per bronchi e vascolari .....	69-71
Pinze per bronchi, atraumatiche .....	116
Pinze per coartazione.....	117
Pinze per legature.....	115
Pinze per mettere clips per vasi .....	142
Pinze per mettere pinze Bulldog.....	78, 86
Pinze per micro-suture.....	137
Pinze per occlusione tangenziale .....	108-110
Pinze per preparazione e suture.....	64-67
Pinze per preparazione e suture, atraumatiche .....	114
Pinze per tessuti ed intestino .....	72-75
Pinze per tessuti ed intestino <b>PRIMUSLINE</b> .....	55
Pinze profunda.....	119
Pinze serratubi.....	150, 151
Pinze sgorbie .....	191-195
Pinze taglia filo .....	229, 230
Pinze tecniche .....	231
Pinze vascolari.....	85-129
Pinze vascolari pediatriche.....	124
Pinze vascolari periferali .....	111-113
Pinze vascolari universali .....	85-96
POOLE tubi per aspirazione.....	6
Porta aghi .....	171-179
Porta aghi, micro .....	138, 139
Porta micro-lame - Micro-lame .....	14
POTTS pinze Bulldog con manici ad anelli.....	120
POTTS pinze per anastomosi.....	97
POTTS pinze per coartazione .....	117
POTTS-DE MARTEL forbici vascolari .....	28, 31
POTTS-SMITH (DE MARTEL) forbici vascolari .....	26
POTTS-SMITH forbici per caratalagine.....	33
POTTS-SMITH pinze anatomiche.....	47
PRICE-THOMAS pinze per bronchi .....	69
PROVIDENCE HOSPITAL pinze emostatiche .....	61
<b>Q</b>	
QUINBY forbici .....	43
<b>R</b>	
RESANO forbici.....	32

## Inhaltsverzeichnis Index

## Tables de matières

### Indice

### Indice

REYNOLDS (JAMESON) forbici .....	45
REYNOLDS forbici <b>PRIMUSLINE</b> .....	21
RONALD-EDWARDS divaricatori costali .....	218
ROSS pinze serratubi .....	151
ROSS terminali per aspirazione .....	10
RÖTTGEN-RUSKIN pinza sgorbia .....	194
RUMEL-BELMONT tourniquet .....	180
RUSKIN pinze sgorbie .....	191
RUSKIN-LISTON cesoie per ossa .....	196
RYDER porta aghi .....	177, 178

### S

SANTULLI pinza Bulldog .....	82
SAROT pinze per bronchi .....	70
SAROT porta aghi .....	176
SATINSKY forbici per torace .....	34
SATINSKY pinze per bronchi .....	71
SATINSKY-DE BAKEY pinze per occlusione tangenziale .....	108
SAUERBRUCH costotomo .....	204
SAUERBRUCH divaricatori .....	155
SAUERBRUCH pinze sgorbie .....	195
SAUERBRUCH-FREY costotomo .....	203
Scatole per sterilizzazione di acciaio inossidabile .....	140
SELLORS approssimatori costali .....	226
SELLORS divaricatori costali .....	219
SEMB cesoia per ossa .....	197
SEMB pinza sgorbia .....	194
SEMB pinze per bronchi .....	70
SEMB tenaglie per ossa .....	199
SIMON divaricatori .....	159
SOUTHAMPTON tubo per aspirazione .....	8
Spatole polmonare .....	225
ST. MARKS divaricatori .....	164
STANDARD pinze anatomiche .....	47
STANDARD Skalpellgriffe .....	11
STEVENS forbici <b>PRIMUSLINE</b> .....	23
STILLE costotomo .....	202
STILLE pinze sgorbie .....	192
STILLE-LISTON cesoie per ossa .....	196
STILLE-LUER pinze sgorbie .....	193
STILLE-RUSKIN pinze sgorbie .....	192
STRATTE porta aghi .....	174
Strumenti per filo di cerchiaggio .....	227, 228

### T

TAYLOR pinza anatomica .....	47
TEKNO-TWIST porta aghi .....	176
Tenaglie per ossa .....	198, 199
Terminali per aspirazione .....	10
TERRIER pinza emostatica .....	60
THOMS-ALLIS pinza per intestino .....	72
Tiravene .....	180
TOENNIS-ADSON forbici per tonsille .....	36
Tourniquet .....	180
TUBBS dilatatore aorta .....	186
Tubi per aspirazione .....	6-9
TUFFIER divaricatori costali .....	216

### V

VAN BUREN tenaglie per ossa .....	198
-----------------------------------	-----

VARADY dissettori .....	182
VASCULAR porta aghi .....	177, 179
VEHMEHREN costotomo .....	205

### W

WANGENSTEEN pinze anatomiche .....	47
WANGENSTEEN porta aghi .....	175
WEBER pinza per aorta .....	102
WEBSTER porta aghi .....	172
WEITLANER-LOCKTITE divaricatori autostatici .....	169
WESTCOTT forbici per tenotomia .....	35
WILLAUER forbici per lobectomia .....	32
WILLIAMS pinza per intestino .....	72
WILLIGER elevatori .....	201

### Y

YANKAUER tubo per aspirazione .....	6
YASARGIL forbici per microchirurgia .....	131, 132

### Z

ZENKER divaricatori .....	162
---------------------------	-----

**Notizen**  
*Notes*

---

Notices  
*Notas*  
Note



Notizen | Notices  
*Notes* | *Notas*  
Note

---

**Notizen**  
*Notes*

---

Notices  
*Notas*  
Note

## Wichtige Hinweise

---

Dieser Katalog bleibt Eigentum der Firma TEKNO-MEDICAL Optik-Chirurgie GmbH & Co. KG, auch wenn dafür eine Schutzgebühr bezahlt wurde. Er kann von uns jederzeit zurückgefordert werden, wenn er gegen unsere Interessen und nicht zum Vertrieb und Einkauf von TEKNO Produkten verwendet wird. Auch behalten wir uns in solch einem Falle weitergehende Maßnahmen vor.

Der Nachdruck oder Kopieren dieses Kataloges – im Gesamten oder auch nur auszugsweise – ist ohne unsere schriftliche Genehmigung verboten.

Modelländerungen vorbehalten. Gedruckt in der Bundesrepublik Deutschland

## Important notice

---

*This catalogue remains property of TEKNO-MEDICAL Optik-Chirurgie GmbH & Co. KG even if we have asked for a lending fee of charges. We can at any time recall the catalogue, in case that it has been not used according to our interests, i.e. sale or purchase of TEKNO products. We preserve the right for further steps in that case.*

*Reproduction or copying of this catalogue in whole or in parts is forbidden without our written permission.*

*Patterns are subject to change. Printed in Germany*

## Indications importantes

---

Ce catalogue reste la propriété de TEKNO-MEDICAL Optik-Chirurgie GmbH & Co. KG, même si nous avons demandé le paiement d'une taxe de protection. Nous pouvons demander le retour du catalogue dans le cas où celui-ci n'est pas utilisé conformément à nos intérêts, pour la vente ou l'achat de nos produits. Dans ce cas nous nous réservons le droit de mener des actions juridiques.

La reproduction ou la copie totale ou partielle de ce catalogue est interdite sans notre accord écrit.

Sous réserve des modifications techniques. Imprimé en Allemagne

## Avisos importantes

---

*Este catálogo es propiedad de TEKNO-MEDICAL Optik-Chirurgie GmbH & Co. KG, aún en el caso de haber abonado por él una tasa de colaboración. Podemos solicitar la devolución del catálogo en caso de que no sea utilizado para la compra o venta de nuestros productos. En este caso nos reservamos el derecho de tomar medidas jurídicas.*

*La reproducción o copia total o parcial de este catálogo esta prohibido sin nuestro consentimiento escrito.*

*Salvo modificaciones técnicas. Impreso en la República Federal de Alemania*

## Avvertenze importanti

---

Questo catalogo rimane proprietà della TEKNO-MEDICAL Optik-Chirurgie GmbH & Co. KG, anche se è stato rilasciato gratuitamente o contro pagamento. Possiamo in ogni momento richiederlo indietro, in caso non stato usato in accordo con i nostri interessi (acquisto e vendita dei prodotti TEKNO-Medical). Ci riserviamo in questo caso il diritto di prendere ulteriori provvedimenti.

La copia o la riproduzione di questo catalogo in parte o nella sua totalità è vietata senza il nostro permesso scritto.

Ci riserviamo la facoltà di cambiamenti nei modelli. Stampato in Germania



*TEKNO-MEDICAL Optik-Chirurgie GmbH*

*Sattlerstrasse 11 · 78532 Tuttlingen, Germany  
Telefon +49 (74 61) 17 01-0 · Fax +49 (74 61) 17 01-50  
mail@tekno-medical.com · www.tekno-medical.com*

© Copyright 11.2008 - **TEKNO-MEDICAL** Optik-Chirurgie GmbH  
**TEKNO** is a registered trademark of **TEKNO-MEDICAL** Optik-Chirurgie GmbH