



SEMIAUTOMATICHE H27

SEMIAUTOMATIC H27 | SEMI-AUTOMATIQUES H27

SEGATRICI A NASTRO - BAND SAWS - SCIES A RUBAN

*Fusione tra tecnologia e tradizione
per offrire al cliente la migliore soluzione.*

*Fusion of technology and tradition so to offer our
customers the best solution*

*Fusion entre technologie et tradition pour offrir
au client la solution la meilleure.*



L'Azienda - The Company - l'Entreprise



H27La FMB nasce nel 1982. In un mercato dominato da segatrici a disco è tra le prime a proporre le segatrici a nastro. Grazie alla sua capacità di evolversi, di ricercare prodotti innovativi e di adeguare le caratteristiche delle macchine alle esigenze dell'utilizzatore, si impone rapidamente sul suo mercato emergendo come leader del settore. Costruita secondo i criteri più moderni, improntati alla ricerca della massima funzionalità, ha razionalmente suddiviso gli spazi tra le aree preposte alla nascita del prodotto - quali progettazione, produzione e collaudo - e gli uffici commerciali, amministrativi, magazzino e spedizione.

Ad oggi la nostra gamma prevede 35 modelli, con una capacità di taglio da Ø 200 mm a Ø 540 mm, ed una serie completa di soluzioni per la movimentazione del materiale. In tutti questi anni i concetti alla base della progettazione delle nostre macchine sono rimasti gli stessi: qualità, solidità ed affidabilità.



FMB was set up in 1982 and was one of the very first companies to propose band sawing machines at a time when the market was dominated by circular saws. Since then, thanks to its great ability to evolve, to research innovative products and to modify the machine to suit the customer's actual needs, FMB has become a leading company in this sector. Its buildings represent the best in modern design, concentrating on maximum practicality and with sufficient space for all departments necessary to the creation of a new product: engineering, production and testing. Not to mention the commercial and administration office block, warehouse and dispatch area. Our present range is made of 35 models whose cutting capacity goes from Ø 200 mm up to Ø 540 mm together with a complete set of solutions for material handling.

In all these years the concepts behind the design of our machines have remained the same: quality, solidity and reliability.



La FMB naît en 1982 et propose, parmi les premiers à les fabriquer, les tronçonneuses à ruban dans un marché dominé par les tronçonneuses à disque. Grâce à sa capacité d'évolution, de recherche de produits innovants et d'adaptation des caractéristiques de ses machines aux exigences des utilisateurs, elle s'impose rapidement dans sa spécialité, ressortant comme leader dans ce domaine. Construite selon les critères les plus modernes, reflétant la recherche de la plus grande fonctionnalité, elle a rationnellement partagé l'espace entre les sites destinés à la naissance du produit - conception, production et contrôle - et les bureaux commerciaux, administratifs, magasin et service expédition. Aujourd'hui notre gamme comprend 35 modèles avec une capacité de coupe de Ø 200 mm à Ø 540 mm, et une série complète de solutions pour la manutention du matériel. Pendant tous ces ans les principes derrière la conception de nos machines sont restés les mêmes: qualité, solidité et fiabilité.

La Progettazione - Engineering - La Conception

I prodotti FMB sono il risultato di approfonditi studi, supportati dall'utilizzo di moderni sistemi di modellazione CAD 3D che consentono preliminari analisi statiche, dinamiche e strutturali.

FMB, consapevole di quanto sia importante la continua evoluzione delle macchine, investe notevolmente in risorse umane e tecnologiche dedicando particolare impegno alla ricerca ed alla progettazione.

All our products are the result of extensive studies, supported by the use of modern systems of 3D CAD modelling that allow preliminary static, dynamic and structural analyses.

FMB is always well aware of how important it is to be able to offer a continuously evolving machine - that's why we've invested heavily in our technical and engineering office.

Les produits FMB sont les résultats d'études approfondies, soutenues par l'utilisation de systèmes modernes de modélisation CAD 3D qui permettent une analyse préliminaire statique, dynamique et structurale.

La FMB, consciente de l'importance de l'évolution permanente des machines, investit considérablement en ressources humaines et technologiques, consacrant une ardeur particulière à la recherche et à la conception.

La Qualità - Process Quality - La Qualité

Per garantire il massimo livello qualitativo, ogni componente delle macchine FMB viene sottoposto a rigorosi test di controllo: dall'approvvigionamento dei singoli pezzi, alla successiva lavorazione, ai vari trattamenti.

Poiché la qualità di un prodotto nasce anche dalla qualità delle parti che lo compongono, FMB ha selezionato negli anni fornitori totalmente affidabili e di altissimo livello con cui collaborare.

Infine ogni macchina, una volta assemblata, viene collaudata minuziosamente dal punto di vista meccanico, elettrico e idraulico.

To guarantee maximum quality, each component of the machines FMB is subjected to strict tests of control: from the supplying of the single parts to their further processing, to their different treatments.

Knowing that the quality of a product depends heavily on the quality of its components, over the years, FMB has selected very reliable suppliers of the highest level to work with.

Finally, each machine, once assembled, is minutely tested from the mechanical, electrical and hydraulic point of view.

Pour garantir le plus haut niveau de qualité, chaque composant des machines FMB est soumis à des épreuves rigoureuses de contrôle: de la fourniture des différentes pièces à leur successif usinage, jusqu'aux différents traitements.

Puisque la qualité d'un produit dépend aussi de la qualité de ses composants, FMB a sélectionné, au fil des ans, des fournisseurs totalement fiables du plus haut niveau à travailler avec.

Enfin chaque machine, une fois assemblée, est testée minutieusement du point de vue mécanique, électrique et hydraulique.

DAL 1982

SINCE 1982 • DEPUIS 1982



FMB s.r.l.

Via Lodi 7

24044 Dalmine - BERGAMO

Phone +39 035 4157600 / +39 035 370555

Fax +39 035 370668

www.fmb.it - info@fmb.it

 FMB-segatricianastro  [fmbsaws](https://www.youtube.com/fmbsaws)

MANUALI

MANUALS • MANUELLES



JUNIOR+G



PHOENIX



TRITON



ANTARES



ORION



TITAN+G



MERCURY+G



SATURN+G



PEGASUS+G+VHZ



SEMIAUTOMATICHE H34-H41

SEMIAUTOMATIC H34 - H41 • SEMI-AUTOMATIQUES H34 - H41



HERCULES



HERCULES TUBES



PEGASUS



PEGASUS XL



PEGASUS DS



SOLAR



PLUTON AIR



ATALANTA



OLIMPIUS 1



OLIMPIUS 2



OLIMPIUS 3



OLIMPIUS 1 XL



OLIMPIUS 2 XL

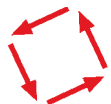

AUTOMATICHE

AUTOMATIC • AUTOMATIQUES



ZEUS+CN



JUPITER+CN



ATHENA 34A



PEGASUS+CN



POLARIS+CN



SCORPIO CNC

SEGATRICI A NASTRO SEMIAUTOMATICHE H27
SEMIAUTOMATIC • SEMI-AUTOMATIQUES

| | | | |
|----------------------|---------|-----------------------------------|---------|
| CENTAURO | PAG. 6 | ACCESSORI | PAG. 25 |
| SIRIUS | PAG. 8 | ACCESSORIES | |
| CALIPSO | PAG. 10 | ACCESSOIRES | |
| OMEGA | PAG. 12 | RULLIERE E SISTEMI DI AVANZAMENTO | PAG. 26 |
| MAJOR | PAG. 14 | ROLLER TABLES AND FEEDING SYSTEMS | |
| MERCURY | PAG. 16 | TABLES A ROULEAUX ET SYSTEMES | |
| GALACTIC | PAG. 18 | D'ENTRAINEMENT | |
| SATURN | PAG. 20 | CAPACITÀ DI TAGLIO | PAG. 28 |
| DOTAZIONI STANDARD | PAG. 22 | CUTTING CAPACITY | |
| STANDARD EQUIPMENTS | | CAPACITÉ DE COUPE | |
| EQUIPEMENTS STANDARD | | CARATTERISTICHE TECNICHE | PAG. 29 |
| OPTIONAL | PAG. 24 | TECHNICAL CHARACTERISTICS | |
| OPTIONALS | | CARACTÉRISTIQUES TECHNIQUES | |
| OPTIONS | | GUIDA ALL'ACQUISTO | PAG. 30 |
| | | PURCHASING GUIDE | |
| | | GUIDE D'ACHAT | |

legenda / legend / legende

| |  |  |  |
|--|--|--|---|
|  mm | dimensioni della lama | blade dimensions | dimensions du ruban |
|  m/min | velocità lama metri/minuto | blade speed meters/minute | vitesse ruban metres/minute |
|  kW | potenza motore lama | blade motor power | puissance moteur ruban |
|  kW | potenza motore pompa acqua | water pump power | puissance moteur pompe de l'eau |
|  kW | potenza motore centralina idraulica | hydraulic unit motor power | puissance moteur droupe hydraulique |
|  Kg | peso della macchina | machine weight | poids de la machine |
|  axbxc mm | dimensioni di ingombro | dimensions | dimensions |
|  mm | capacità di taglio max con optional DOTM | max cutting capacity with DOTM option | capacité de coupe maximum avec option DOTM |
|  mm | altezza del piano di lavoro | worktop height | hauteur du plan de travail |
| Capacità di taglio Cutting capacity Capacité de coupe | Le capacità di taglio fanno riferimento alla macchina standard. Alcuni optional possono diminuire la capacità di taglio. | Cutting capacities refer to standard machines. Some optionals may reduce cutting capacities. | Les capacités de coupe se réfèrent aux machines standard. Des options peuvent réduire la capacité de coupe. |

CENTAURO

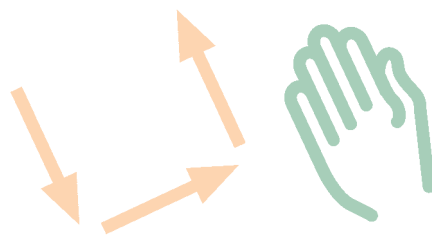

IT Segatrice a nastro semiautomatica per tagli da 0° a 60° destra.

Arco a gestione idraulica con regolazione del taglio tramite valvola di flusso monogiro, in posizione ergonomica.

Solida morsa in ghisa con avvicinamento manuale e bloccaggio rapido del pezzo a leva.

Rotazione arco con fermi di battuta a 0°, 45° e 60°.

Scala graduata per lettura angolo e robusta leva di bloccaggio.

UK Semiautomatic band saw machine to cut from 0° to 60° right.

Head hydraulic controlled with cutting adjustment by single-turn flow valve, in an ergonomic position.

Solid cast iron vice with manual feeding and lever fast piece clamping.

Head rotation angle stop at 0°, 45° and 60°.

Degrees measuring system, graduated scale and rugged in construction locking lever.

FR Scie à ruban semi-automatique pour coupes de 0° à 60° à droite.

Archet à contrôle hydraulique avec réglage de la coupe par soupape d'écoulement mono-tour, en position ergonomique.

Etau blocage matériel positionnable manuellement pourvu de système de blocage rapide de la pièce.

Rotation archet avec arrêts de butée à 0°, 45° et 60°.

Échelle graduée pour lecture de l'angle et robuste levier de blocage.

OPTIONAL
OPTIONALS • OPTIONS

DTI
LX
MT
NB1 / NB2
SENS
TM
VAT



CAPACITÀ DI TAGLIO

CUTTING CAPACITY • CAPACITÉ DE COUPE

| | ● Ø mm | a ■ axb mm b | a ■ axb mm b | a ■ axb mm b |
|-------|--------|-----------------|-----------------|-----------------|
| 0° | 240 | 240 | 210x280 | 240x260 |
| 45° → | 185 | 175 | 140x180 | 220x165 |
| 60° → | 115 | 110 | 110x110 | 110x110 |

CARATTERISTICHE TECNICHE

TECHNICAL CHARACTERISTICS • CARACTÉRISTIQUES TECHNIQUES

| mm | m/min | kW | m/min | kW | kW | kW | Kg | a x b x c m | h ± 10 mm |
|-------------|-------|--------------|--------|-----|------|------|-----|----------------|--------------|
| 2700x27x0,9 | 35-70 | 1,3 | 16÷120 | 1,5 | 0,08 | 0,36 | 365 | 0,85x1,45x1,45 | 950 |
| CENTAURO | | CENTAURO+VHZ | | | | | | | |

ALCUNE CARATTERISTICHE
A FEW FEATURES • QUELQUES CARACTÉRISTIQUES

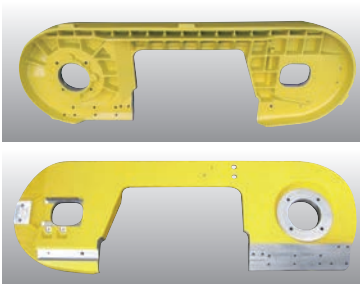

Struttura arco realizzata in lega speciale d'alluminio SGALSI 91 ad alta resistenza ed idonea ad assorbire le vibrazioni.



Battute meccaniche per la rotazione rapida dell'arco ai gradi 0°, 45° e 60°.

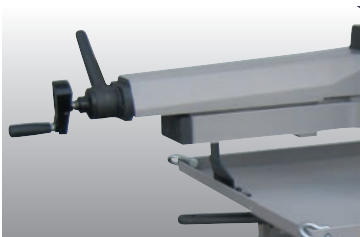

Solida morsa in ghisa con avvicinamento manuale e bloccaggio rapido del pezzo a leva.

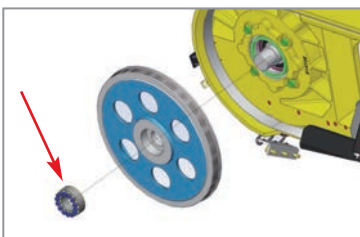

Riduttore ad albero portante ed esente da manutenzione (ingrassaggio). Albero d'uscita del riduttore di Ø 40 mm e fissaggio del volante motore con calettatore per attrito.



Rullo appoggio barre registrabile in altezza posizionato in lato carico.



Vasca refrigerante di 20 l posizionata all'interno del basamento facilmente asportabile per la pulizia e il riempimento.



Head structure made in high resistance aluminium special alloy SGALSI 91 suitable to dampen vibrations.

Mechanical stops for a fast rotation at 0°, 45° and 60° degrees.

Solid cast iron vice with manual feeding and lever fast piece clamping.

Load-bearing shaft gear box requiring no maintenance (greasing). Output shaft of the reduction gear box Ø 40 mm and motor wheel connection with a keyless shaft/hub connection.

Loading side bar supporting height adjustable roller.

20 l coolant tank placed inside the basement easy to move for cleaning and filling.



Structure archet en alliage spécial en aluminium SGALSI 91 de haute résistance et apte à amortir les vibrations.

Arrêts mécaniques pour une rotation rapide de l'archet à 0°, 45° et 60° degrés.

Etau solide en fonte avec décalage manuel et blocage rapide de la pièce par levier.

Réducteur à arbre portant qui ne nécessite aucun entretien (graisage). Arbre sortie réducteur de Ø 40 mm et blocage du volant moteur par pièce de calage.

Rouleau d'appui barre en coté chargement réglable en hauteur.

Bac réfrigérant capacité 20 l placé dans le bâti facile à déplacer pour nettoyage et remplissage.

FMB si riserva il diritto di modificare i dati indicati senza necessità di preavviso. - FMB srl reserves the right to modify any data quoted above without previous notice. - FMB srl se réserve d'apporter toutes modifications quelconque sans aucun préavis.

SIRIUS

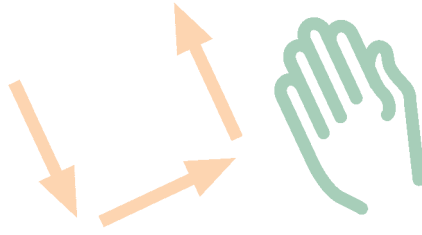

Segatrice a nastro semiautomatica
per tagli da 0° a 60° destra.

Arco a gestione idraulica con regolazione del taglio tramite valvola di flusso monogiro, in posizione ergonomica.

Morsa chiusura materiale a posizionamento manuale con cilindro di bloccaggio idraulico. Rotazione arco con fermi di battuta a 0°, 45° e 60°.

Scala graduata per lettura angolo e robusta leva di bloccaggio.

Semiautomatic band saw machine
to cut from 0° to 60° right.

Head hydraulic controlled with cutting adjustment by single-turn flow valve, in an ergonomic position.

Material clamping vice with manual positioning with hydraulic locking cylinder.

Head rotation angle stop at 0°, 45° and 60°.

Degrees measuring system, graduated scale and rugged in construction locking lever.

Scie à ruban semi-automatique pour coupes de 0° à 60° à droite.

Archet à contrôle hydraulique avec réglage de la coupe par soupape d'écoulement mono-tour, en position ergonomique.

Etau blocage matériel positionnable manuellement pourvu de vérin de blocage hydraulique.

Rotation archet avec arrêts de butée à 0°, 45° et 60°.

Échelle graduée pour lecture de l'angle et robuste levier de blocage.



OPTIONAL
OPTIONALS • OPTIONS

DOTM
DTI
LX
MT
RIA
NB1 / NB2
RPM1
SENS
TM
VAT

CAPACITÀ DI TAGLIO

CUTTING CAPACITY • CAPACITÉ DE COUPE

| | ● Ø mm | a ■ axb mm b | a ■ axb mm b | a ■ axb mm b |
|-------|--------|-----------------|-----------------|-----------------|
| 0° | 240 | 240 | 210x280 | 240x260 |
| 45° → | 185 | 175 | 140x180 | 220x165 |
| 60° → | 115 | 110 | 110x110 | 110x110 |

CARATTERISTICHE TECNICHE

TECHNICAL CHARACTERISTICS • CARACTÉRISTIQUES TECHNIQUES

| mm | m/min | kW | m/min | kW | kW | kW | Kg | a x b x c m | h ± 10 mm | mm a x b |
|-------------|-------|-----|------------|-----|------|------|-----|----------------|--------------|----------|
| 2700x27x0,9 | 35-70 | 1,3 | 16÷120 | 1,5 | 0,08 | 0,36 | 370 | 0,85x1,45x1,45 | 950 | 100x250 |
| SIRIUS | | | SIRIUS+VHZ | | | | | | | |

ALCUNE CARATTERISTICHE
A FEW FEATURES • QUELQUES CARACTÉRISTIQUES

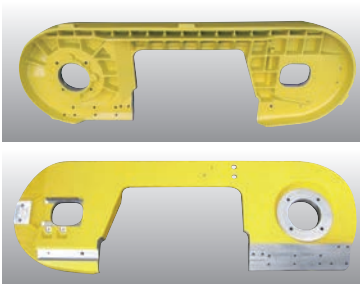

Struttura arco realizzata in lega speciale d'alluminio SGALSI 91 ad alta resistenza ed idonea ad assorbire le vibrazioni.



Battute meccaniche per la rotazione rapida dell'arco ai gradi 0°, 45° e 60°.



Morsa chiusura materiale in ghisa a posizionamento manuale, dotata di cilindro di chiusura idraulico.

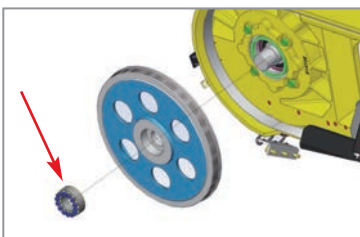

Riduttore ad albero portante ed esente da manutenzione (ingrassaggio). Albero d'uscita del riduttore di Ø 40 mm e fissaggio del volano motore con calettatore per attrito.



Rullo appoggio barre registrabile in altezza posizionato in lato carico.



Vasca refrigerante di 20 l posizionata all'interno del basamento facilmente asportabile per la pulizia e il riempimento.



Head structure made in high resistance aluminium special alloy SGALSI 91 suitable to dampen vibrations.

Mechanical stops for a fast head rotation at 0°, 45° and 60° degrees.

Clamping vice in cast iron movable by hand equipped with hydraulic locking cylinder.

Load-bearing shaft gear box requiring no maintenance (greasing). Output shaft of the reduction gear box Ø 40 mm and motor wheel connection with a keyless shaft/hub connection.

Loading side bar supporting height adjustable roller.

20 l coolant tank placed inside the basement easy to move for cleaning and filling.



Structure archet en alliage spécial en aluminium SGALSI 91 de haute résistance et apte à amortir les vibrations.

Arrêts mécaniques pour une rotation rapide de l'archet à 0°, 45° et 60° degrés.

Etau blocage matériel en fonte réglable à la main pourvu de vérin de blocage hydraulique.

Réducteur à arbre portant qui ne nécessite aucun entretien (graisage). Arbre sortie réducteur de Ø 40 mm et blocage du volant moteur par pièce de calage.

Rouleau d'appui barre en coté chargement réglable en hauteur.

Bac réfrigérant capacité 20 l placé dans le bâti facile à déplacer pour nettoyage et remplissage.

FMB si riserva il diritto di modificare i dati indicati senza necessità di preavviso. - FMB srl reserves the right to modify any data quoted above without previous notice. - FMB srl se réserve d'apporter toutes modifications quelconque sans aucun préavis.

CALIPSO

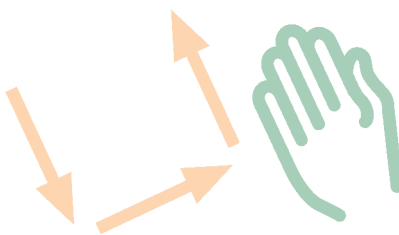

■ Segatrice a nastro semiautomatica per tagli da 0° a 60° destra e 45° sinistra.

Arco a gestione idraulica con regolazione del taglio tramite valvola di flusso monogiro, in posizione ergonomica.

Morsa chiusura materiale a traslazione manuale, posizionamento manuale e sistema di bloccaggio rapido del pezzo.

Rotazione arco con fermi di battuta a 0°, 45°, 60° e -45°.

Scala graduata per lettura angolo e robusta leva di bloccaggio.

■ Semiautomatic band saw machine to cut from 0° to 60° right and 45° left.

Head hydraulic controlled with cutting adjustment by single-turn flow valve, in an ergonomic position.

Large material support surface, manual positioning closing vice with fast clamping system.

Head rotation angle stop at 0°, 45°, 60° and -45°.

Degrees measuring system, graduated scale and rugged in construction locking lever.

■ Scie à ruban semi-automatique pour coupes de 0° à 60° à droite et 45° à gauche.

Archet à contrôle hydraulique avec réglage de la coupe par soupape d'écoulement mono-tour, en position ergonomique.

Etau blocage matériel à décalage manuel, positionnable manuellement et système de blocage rapide de la pièce.

Rotation archet avec arrêts d e butée à 0°, 45°, 60° et -45°.

Échelle graduée pour lecture de l'angle et robuste levier de blocage.

OPTIONAL
OPTIONALS • OPTIONS

DM
DT1
LX
MT
NB1 / NB2
SENS
TM
VAT













CAPACITÀ DI TAGLIO

CUTTING CAPACITY • CAPACITÉ DE COUPE

| | ● Ø mm | a ■ axb mm b | a ■ axb mm b | a ■ axb mm b |
|-------|--------|-----------------|-----------------|-----------------|
| 0° | 240 | 240 | 200x310 | 240x270 |
| 45° → | 175 | 170 | 170x170 | 240x155 |
| 60° → | 110 | 105 | 105x105 | 140x100 |
| 45° ← | 150 | 135 | 125x145 | 240x65 |

CARATTERISTICHE TECNICHE

TECHNICAL CHARACTERISTICS • CARACTÉRISTIQUES TECHNIQUES

|  mm |  m/min |  kW |  m/min |  kW |  kW |  kW |  Kg |  a x b x c m |  h ± 10 mm |
|---|--|---|--|---|---|---|---|---|---|
| 2700x27x0,9 | 35-70 | 1,3 | 16÷120 | 1,5 | 0,08 | 0,36 | 370 | 0,85x1,45x1,45 | 990 |
| CALIPSO | | CALIPSO +VHZ | | | | | | | |

ALCUNE CARATTERISTICHE
A FEW FEATURES • QUELQUES CARACTÉRISTIQUES

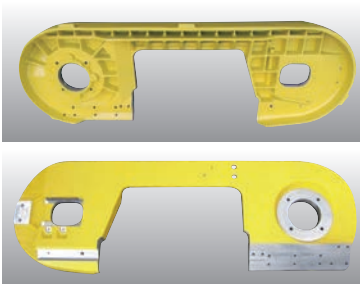

Struttura arco realizzata in lega speciale d'alluminio SGALSI 91 ad alta resistenza ed idonea ad assorbire le vibrazioni.



Battute meccaniche per la rotazione rapida dell'arco ai gradi 0°, 45°, 60° e -45°.



Morsa posta in posizione frontale, composta da:

- un ampio disco girevole per l'appoggio del materiale fino alla massima capacità di taglio,
- una stabile piastra per il sostegno del gruppo di bloccaggio.

Il gruppo di bloccaggio scorre trasversalmente sulla piastra per effettuare tagli angolari sia a destra che a sinistra, il bloccaggio del materiale è rapido grazie alla maniglia a ripresa. Ganasce con altezza 130mm, sostituibili in caso di usura. Possibilità di arretrare le ganasce fisse per estendere la capacità di taglio fino a 310 mm. L'angolo di taglio è leggibile tramite la scala graduata.

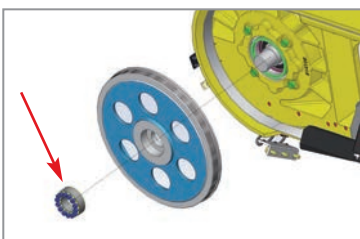
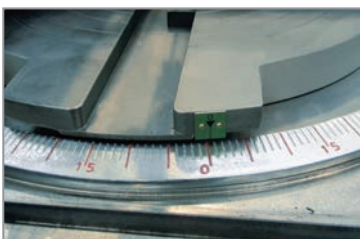

Riduttore ad albero portante ed esente da manutenzione (ingrassaggio). Albero d'uscita del riduttore di Ø 40 mm e fissaggio del volano motore con calettatore per attrito.



Vasca refrigerante di 20 l posizionata all'interno del basamento facilmente asportabile per la pulizia e il riempimento.



Head structure made in high resistance aluminium special alloy SGALSI 91 suitable to dampen vibrations.

Mechanical stops for a fast rotation at 0°, 45°, 60° and -45° degrees.

Vice placed in frontal position consisting of:

- a wide rotary disk for material supporting up to the most cutting capacity,
- a steady plate supporting the clamping unit.

The clamping unit transversally slides on the plate to perform angular cuttings both on the right and on the left, the fast material clamping is by lever. 130 mm high jaws replaceable in case of wear. Fixed jaws can be moved back in order to enlarge cutting capacity up to 310 mm. The cutting angle is readable by a graduated scale.

Load-bearing shaft gear box requiring no maintenance (greasing). Output shaft of the reduction gear box Ø 40 mm and motor wheel connection with a keyless shaft/hub connection.

20 l coolant tank placed inside the basement easy to move for cleaning and filling.



Structure archet en alliage spécial en aluminium SGALSI 91 de haute résistance et apte à amortir les vibrations.

Arrêts mécaniques pour une rotation rapide de l'archet à 0°, 45°, 60° et -45° degrés.

Etau en position frontale composé par:

- un large disque tournant pour l'appui du matériel jusque la capacité de coupe maximum,
- une plaque stable de soutien du groupe de blocage.

Le groupe de blocage glisse transversalement sur la plaque pour permettre des coupes à angle soit à droite soit à gauche, le blocage rapide du matériel est par levier. Mâchoires 130 mm de haut, remplaçables en cas d'usure. Possibilité de faire reculer les mâchoires fixes jusque à joindre une capacité de coupe de 310mm. L'angle de la coupe est lisible par une échelle graduée.

Réducteur à arbre portant qui ne nécessite aucun entretien (graisage). Arbre sortie réducteur de Ø 40 mm et blocage du volant moteur par pièce de calage.

Bac réfrigérant capacité 20 l placé dans le bâti facile à déplacer pour nettoyage et remplissage.

OMEGA

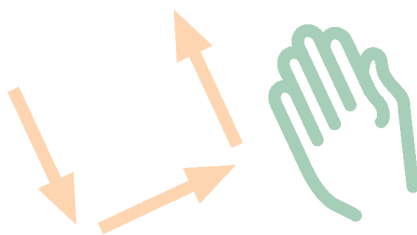

OPTIONAL
OPTIONALS • OPTIONS

Segatrice a nastro semiautomatica per tagli da 0° a 60° destra e 45° sinistra.

Arco a gestione idraulica con regolazione del taglio tramite valvola di flusso monogiro, in posizione ergonomica.

Morsa chiusura materiale a traslazione manuale, posizionamento manuale e dotata di cilindro di chiusura idraulico.

Rotazione arco con fermi di battuta a 0°, 45°, 60° e -45°.

Scala graduata per lettura angolo e robusta leva di bloccaggio.

Semiautomatic band saw machine to cut from 0° to 60° right and 45° left.

Head hydraulic controlled with cutting adjustment by single-turn flow valve, in an ergonomic position.

Large material support surface, manual positioning closing vice with hydraulic locking cylinder.

Head rotation angle stop at 0°, 45°, 60° and -45°.

Degrees measuring system, graduated scale and rugged in construction locking lever.

Scie à ruban semi-automatique pour coupes de 0° à 60° à droite et 45° à gauche.

Archet à contrôle hydraulique avec réglage de la coupe par soupape d'écoulement mono-tour, en position ergonomique.

Etau blocage matériel à décalage manuel, positionnable manuellement et pourvu de vérin de blocage hydraulique.

Rotation archet avec arrêts de butée à 0°, 45°, 60° et -45°.

Échelle graduée pour lecture de l'angle et robuste levier de blocage.



DMI
DOTM
DTI
LX
MT
NB1 / NB2
RPM1
SENS
TM
VAT

CAPACITÀ DI TAGLIO

CUTTING CAPACITY • CAPACITÉ DE COUPE

| | ● Ø mm | a ■ a x b mm b | a ■ a x b mm b | a ■ a x b mm b |
|-------|--------|-------------------|-------------------|-------------------|
| 0° | 240 | 240 | 200x310 | 240x270 |
| 45° → | 175 | 170 | 170x170 | 240x155 |
| 60° → | 110 | 105 | 105x105 | 140x100 |
| 45° ← | 150 | 135 | 125x145 | 240x65 |

CARATTERISTICHE TECNICHE

TECHNICAL CHARACTERISTICS • CARACTÉRISTIQUES TECHNIQUES

| mm | m/min | kW | m/min | kW | kW | kW | KG | a x b x c mm | h ± 10 mm | OPTIONAL mm a x b |
|-------------|-------|-----------|--------|-----|------|------|-----|----------------|-----------|----------------------|
| 2700x27x0,9 | 35-70 | 1,3 | 16÷120 | 1,5 | 0,08 | 0,36 | 490 | 0,85x1,45x1,45 | 990 | 120x280 |
| OMEGA | | OMEGA+VHZ | | | | | | | | |

ALCUNE CARATTERISTICHE

A FEW FEATURES • QUELQUES CARACTÉRISTIQUES

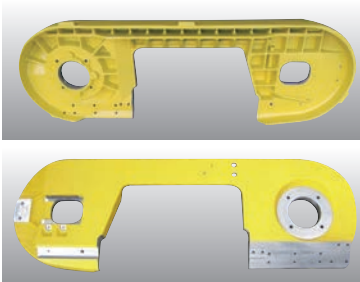

Struttura arco realizzata in lega speciale d'alluminio SGALSI 91 ad alta resistenza ed idonea ad assorbire le vibrazioni.



Battute meccaniche per la rotazione rapida dell'arco ai gradi 0°, 45°, 60° e -45°.



Morsa posta in posizione frontale, composta da:

- un ampio disco girevole per l'appoggio del materiale fino alla massima capacità di taglio,
- una stabile piastra per il sostegno del gruppo di bloccaggio.

Il gruppo di bloccaggio scorre trasversalmente sulla piastra per effettuare tagli angolari sia a destra che a sinistra, il bloccaggio del materiale avviene per mezzo di un cilindro idraulico.

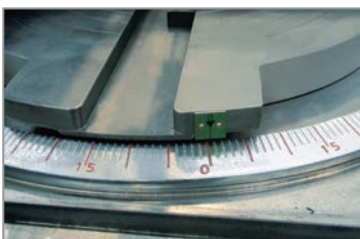

Ganasce con altezza 130 mm, sostituibili in caso di usura. Possibilità di arretrare le ganasce fisse per estendere la capacità di taglio fino a 310 mm. L'angolo di taglio è leggibile tramite la scala graduata.

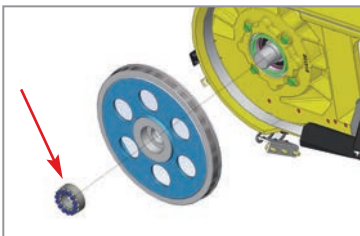

Riduttore ad albero portante ed esente da manutenzione (ingrassaggio). Albero d'uscita del riduttore di Ø 40 mm e fissaggio del volano motore con calettatore per attrito.



Vasca refrigerante di 20 l posizionata all'interno del basamento facilmente asportabile per la pulizia e il riempimento.



Head structure made in high resistance aluminium special alloy SGALSI 91 suitable to dampen vibrations.

Mechanical stops for a fast rotation at 0°, 45°, 60° and -45° degrees.

Vice placed in frontal position consisting of:

- a wide rotary disk for material supporting up to the most cutting capacity,
- a steady plate supporting the clamping unit.

The clamping unit transversally slides on the plate to perform angular cuttings both on the right and on the left, material clamping is by means of a hydraulic cylinder. 130 mm high jaws replaceable in case of wear. Fixed jaws can be moved back in order to enlarge cutting capacity up to 310 mm. The cutting angle is readable by a graduated scale.

Load-bearing shaft gear box requiring no maintenance (greasing).

Output shaft of the reduction gear box Ø 40 mm and motor wheel connection with a keyless shaft/hub connection.



Structure archet en alliage spécial en aluminium SGALSI 91 de haute résistance et apte à amortir les vibrations.

Arrêts mécaniques pour une rotation rapide de l'archet à 0°, 45°, 60° et -45° degrés.

Etau en position frontale composé par:

- un large disque tournant pour l'appui du matériel jusque la capacité de coupe maximum,
- une plaque stable de soutien du groupe de blocage.

Le groupe de blocage glisse transversalement sur la plaque pour permettre des coupes à angle soit à droite soit à gauche, Le blocage du matériel est par vérin hydraulique. Mâchoires 130 mm de haut, remplaçables en cas d'usure.

Possibilité de faire reculer les mâchoires fixes jusque à joindre une capacité de coupe de 310 mm. L'angle de la coupe est lisible par une échelle graduée.

Réducteur à arbre portant qui ne nécessite aucun entretien (graisage). Arbre sortie réducteur de Ø 40 mm et blocage du volant moteur par pièce de calage.

Bac réfrigérant capacité 20 l placé dans le bâti facile à déplacer pour nettoyage et remplissage.

MAJOR

Segatrice a nastro semiautomatica per tagli da 0° a 60° destra.

Arco a gestione idraulica con regolazione del taglio tramite valvola di flusso monogiro, in posizione ergonomica.

Morsa chiusura materiale a posizionamento manuale con cilindro di bloccaggio idraulico.

Rotazione arco con fermi di battuta a 0°, 45° e 60°.

Scala graduata per lettura angolo e robusta leva di bloccaggio.

Semiautomatic band saw machine to cut from 0° to 60° right.

Head hydraulic controlled with cutting adjustment by single-turn flow valve, in an ergonomic position.

Material clamping vice with manual positioning with hydraulic locking cylinder.

Head rotation angle stop at 0°, 45° and 60°.

Degrees measuring system, graduated scale and rugged in construction locking lever.

Scie à ruban semi-automatique pour coupes de 0° à 60° à droite.

Archet à contrôle hydraulique avec réglage de la coupe par soupape d'écoulement mono-tour, en position ergonomique.

Etau blocage matériel positionnable manuellement pourvu de vérin de blocage hydraulique.

Rotation archet avec arrêts de butée à 0°, 45° et 60°.

Échelle graduée pour lecture de l'angle et robuste levier de blocage.



OPTIONAL
OPTIONALS • OPTIONS

DOTM
DTI
LX
MT
NB1 / NB2
RPM1
SENS
TM
VAT









CAPACITÀ DI TAGLIO

CUTTING CAPACITY • CAPACITÉ DE COUPE

| | ● Ø mm | a ■ a x b mm b | a ■ a x b mm b | a ■ a x b mm b |
|-------|--------|-------------------|-------------------|-------------------|
| 0° | 260 | 260 | 260x370 | 260x370 |
| 45° → | 260 | 260 | 120x290 | 260x260 |
| 60° → | 180 | 180 | 90x190 | 180x180 |

CARATTERISTICHE TECNICHE

TECHNICAL CHARACTERISTICS • CARACTÉRISTIQUES TECHNIQUES

|  mm |  m/min |  kW |  kW |  kW |  KG |  a x b x c m |  h ± 10 mm |  mm a x b |
|---|--|---|---|---|---|---|---|---|
| 3300x27x0,9 | 16÷120 | 1,5 | 0,08 | 0,36 | 515 | 0,85x1,95x1,5 | 960 | 140x280 |

ALCUNE CARATTERISTICHE
A FEW FEATURES • QUELQUES CARACTÉRISTIQUES

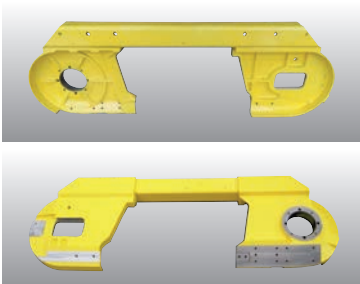

Struttura arco realizzata in 3 parti:

- testata folle in alluminio per diminuire il peso ed idonea ad assorbire la vibrazioni
- traversa in acciaio strutturale
- testata motore in ghisa per diminuire le vibrazioni durante il taglio.



Battute meccaniche per la rotazione rapida dell'arco ai gradi 0°, 45°, 60°.



Morsa chiusura materiale in ghisa a posizionamento manuale, dotata di cilindro di chiusura idraulico.



Rullo appoggio barre registrabile in altezza posizionato in lato carico.

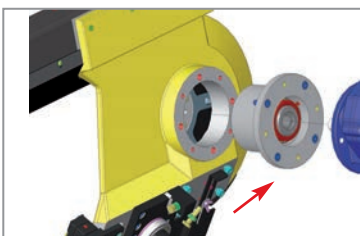

Gruppo flangia con cuscinetti conici contrapposti a sostegno del volano motore, soluzione che permette di preservare il riduttore dagli sforzi causati dalla tensione della lama e quindi di garantirne una lunga vita.



Vasca refrigerante di 20 l posizionata all'interno del basamento facilmente asportabile per la pulizia e il riempimento.



Head structure in three parts:

- idle head in aluminum to reduce the weight and suitable to dampen vibrations
- cross beam in structural steel
- motor head in cast iron to reduce vibrations during the cut.

Mechanical stops for a fast head rotation at 0°, 45°, 60°.

Clamping vice in cast iron movable by hand equipped with hydraulic locking cylinder.

Loading side bar supporting height adjustable roller.

Flange unit with conical bearings supporting the motor wheel, solution that allows preserving the gear unit by the efforts caused by the blade tensioning and thus ensuring it a long life.

20 l coolant tank placed inside the basement easy to move for cleaning and filling.



Structure archet en 3 parties:

- tête folle en aluminium pour en réduire le poids et apte à amortir les vibrations
- traverse en acier structural
- tête moteur en fonte pour réduire les vibrations pendant la coupe.

Arrêts mécaniques pour une rotation rapide de l'archet à 0°, 45°, 60°.

Etau blocage matériel en fonte réglable à la main pourvu de vérin de blocage hydraulique.

Rouleau d'appui barre en coté chargement réglable en hauteur.

Groupe bride avec roulements à cônes opposés à l'appui du volant moteur, solution qui permet de préserver le réducteur des efforts dus à la tension du ruban et de lui garantir une longue durée.

Bac réfrigérant capacité 20 l placé dans le bâti facile à déplacer pour nettoyage et remplissage.

MERCURY

Segatrice a nastro semiautomatica per tagli da 0° a 60° destra.

Arco a gestione idraulica con regolazione del taglio tramite valvola di flusso monogiro, in posizione ergonomica.

Morsa chiusura materiale a posizionamento manuale con cilindro di bloccaggio idraulico.

Rotazione arco con fermi di battuta a 0°, 45° e 60°.

Scala graduata per lettura angolo e robusta leva di bloccaggio.

Semiautomatic band saw machine to cut from 0° to 60° right.

Head hydraulic controlled with cutting adjustment by single-turn flow valve, in an ergonomic position.

Material clamping vice with manual positioning with hydraulic locking cylinder.

Head rotation angle stop at 0°, 45° and 60°.

Degrees measuring system, graduated scale and rugged in construction locking lever.

Scie à ruban semi-automatique pour coupes de 0° à 60° à droite.

Archet à contrôle hydraulique avec réglage de la coupe par soupape d'écoulement mono-tour, en position ergonomique.

Etau blocage matériel positionnable manuellement pourvu de vérin de blocage hydraulique.

Rotation archet avec arrêts de butée à 0°, 45° et 60°.

Échelle graduée pour lecture de l'angle et robuste levier de blocage.



OPTIONAL
OPTIONALS • OPTIONS

DOTM
DTI
LX
MT
NB1 / NB2
RPM1
SENS+SD
TM
VAT









CAPACITÀ DI TAGLIO

CUTTING CAPACITY • CAPACITÉ DE COUPE

| | ● Ø mm | a ■ a x b mm b | a ■ a x b mm b | a ■ a x b mm b |
|-------|--------|-------------------|-------------------|-------------------|
| 0° | 305 | 300 | 300x370 | 300x370 |
| 45° → | 260 | 240 | 155x260 | 300x220 |
| 60° → | 170 | 160 | 160x170 | 255x150 |

CARATTERISTICHE TECNICHE

TECHNICAL CHARACTERISTICS • CARACTÉRISTIQUES TECHNIQUES

|  mm |  m/min |  kW |  kW |  kW |  KG |  a x b x c m |  h ± 10 mm |  OPTIONAL a b mm a x b |
|---|--|---|---|---|--|---|---|---|
| 3420x27x0,9 | 16÷100 | 1,5 | 0,08 | 0,36 | 560 | 0,9x1,8x1,5 | 960 | 140x280 |

ALCUNE CARATTERISTICHE
A FEW FEATURES • QUELQUES CARACTÉRISTIQUES

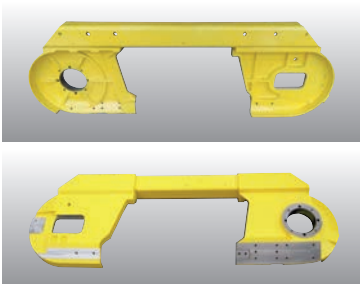

Struttura arco realizzata in 3 parti:

- testata folle in alluminio per diminuire il peso ed idonea ad assorbire la vibrazioni
- traversa in acciaio strutturale
- testata motore in ghisa per diminuire le vibrazioni durante il taglio.



Battute meccaniche per la rotazione rapida dell'arco ai gradi 0°, 45° e 60°.

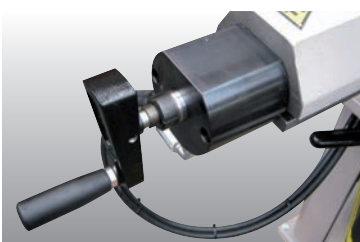

Morsa chiusura materiale in ghisa a posizionamento manuale, dotata di cilindro di chiusura idraulico.



Rullo appoggio barre registrabile in altezza posizionato in lato carico.

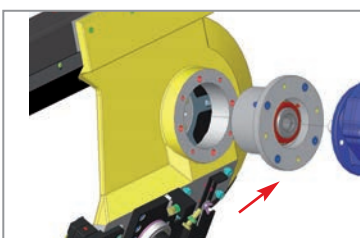

Gruppo flangia con cuscinetti conici contrapposti a sostegno del volano motore, soluzione che permette di preservare il riduttore dagli sforzi causati dalla tensione della lama e quindi di garantirne una lunga vita.



Vasca refrigerante da 40 l integrata nella parte superiore del basamento, facilmente accessibile per la pulizia e il riempimento, con tappo di scarico.



Head structure in three parts:

- idle head in aluminum to reduce the weight and suitable to dampen vibrations
- cross beam in structural steel
- motor head in cast iron to reduce vibrations during the cut.

Mechanical stops for a fast head rotation at 0°, 45° and 60° degrees.

Clamping vice in cast iron movable by hand equipped with hydraulic locking cylinder.

Loading side bar supporting height adjustable roller.

Flange unit with conical bearings supporting the motor wheel, solution that allows preserving the gear unit by the efforts caused by the blade tensioning and thus ensuring it a long life.

40 l coolant tank integrated in the upper part of the basement, easily accessible for cleaning and filling with exhaust plug.



Structure archet en 3 parties:

- tête folle en aluminium pour en réduire le poids et apte à amortir les vibrations
- traverse en acier structural
- tête moteur en fonte pour réduire les vibrations pendant la coupe.

Arrêts mécaniques pour une rotation rapide de l'archet à 0°, 45° et 60° degrés.

Etau blocage matériel en fonte réglable à la main pourvu de vérin de blocage hydraulique.

Rouleau d'appui barre en coté chargement réglable en hauteur.

Groupe bride avec roulements à cônes opposés à l'appui du volant moteur, solution qui permet de préserver le réducteur des efforts dus à la tension du ruban et de lui garantir une longue durée.

Bac réfrigérant de 40 l intégré dans la partie supérieure du bâti, facile à joindre pour le nettoyage et le remplissage, avec bouchon de vidange.

GALACTIC

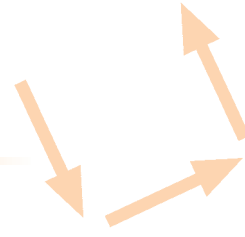

OPTIONAL
OPTIONALS • OPTIONS



Segatrice a nastro semiautomatica per tagli da 0° a 60° destra.
Arco a gestione idraulica con regolazione del taglio tramite valvola di flusso monogiro, in posizione ergonomica.
Morsa chiusura materiale a posizionamento manuale con sistema di scorrimento rapido a cremagliera e cilindro di bloccaggio idraulico.
Rotazione arco con fermi di battuta a 0°, 45° e 60°.
Scala graduata per lettura angolo e robusta leva di bloccaggio.



Semiautomatic band saw machine to cut from 0° to 60° right.
Head hydraulic controlled with cutting adjustment by single-turn flow valve, in an ergonomic position.
Material clamping vice with rack system, manual positioning and fast clamping system.
Head rotation angle stop at 0°, 45° and 60°.
Degrees measuring system, graduated scale and rugged in construction locking lever.



Scie à ruban semi-automatique pour coupes de 0° à 60° à droite.
Archet à contrôle hydraulique avec réglage de la coupe par soupape d'écoulement mono-tour, en position ergonomique.
Etau blocage matériel positionnable manuellement pourvu de système de glissement rapide à crémaillère et vérin de blocage hydraulique.
Rotation archet avec arrêts de butée à 0°, 45° et 60°.
Échelle graduée pour lecture de l'angle et robuste levier de blocage.



DOTM
LX
DTI
MT
NB1 BOX / NB2 BOX
RPM1
SENS+SD
TM
VAT









CAPACITÀ DI TAGLIO

CUTTING CAPACITY • CAPACITÉ DE COUPE

| | ● Ø mm | a ■ a x b mm b | a ■ a x b mm b | a ■ a x b mm b |
|-------|--------|-------------------|-------------------|-------------------|
| 0° | 305 | 300 | 240x420 | 260x410 |
| 45° → | 260 | 260 | 120x290 | 260x260 |
| 60° → | 180 | 180 | 90x190 | 180x180 |

CARATTERISTICHE TECNICHE

TECHNICAL CHARACTERISTICS • CARACTÉRISTIQUES TECHNIQUES

|  mm |  m/min |  kW |  kW |  kW |  KG |  a x b x c m |  h ± 10 mm |  OPTIONAL a b mm a x b |
|---|--|---|---|---|---|---|---|---|
| 3420x27x0,9 | 16÷100 | 1,5 | 0,08 | 0,36 | 710 | 1,1x1,9x1,5 | 950 | 150x380 |

ALCUNE CARATTERISTICHE
A FEW FEATURES • QUELQUES CARACTÉRISTIQUES

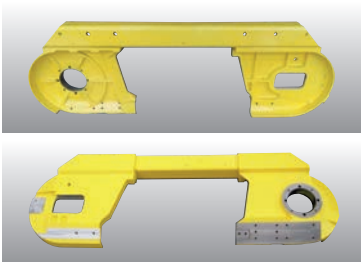

Struttura arco realizzata in 3 parti:

- testata folle in alluminio per diminuire il peso ed idonea ad assorbire la vibrazioni
- traversa in acciaio strutturale
- testata motore in ghisa per diminuire le vibrazioni durante il taglio.



Battute meccaniche per la rotazione rapida dell'arco ai gradi 0°, 45° e 60°.



Morsa chiusura materiale a posizionamento manuale con sistema di scorrimento rapido a cremagliera e cilindro di bloccaggio idraulico.

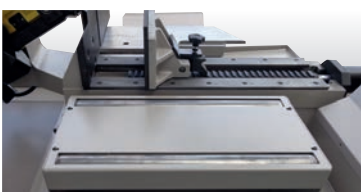

2 rulli per l'appoggio del materiale in lato carico posizionati sul basamento.

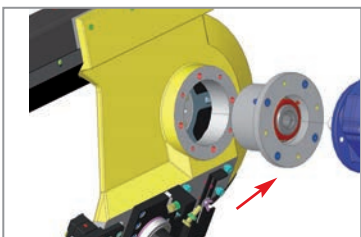

Gruppo flangia con cuscinetti conici contrapposti a sostegno del volano motore, soluzione che permette di preservare il riduttore dagli sforzi causati dalla tensione della lama e quindi di garantirne una lunga vita.



Pannello di comando a pulsanti per eseguire tutte le movimentazioni macchina e diagnostica eventuali allarmi.



Head structure in three parts:

- idle head in aluminum to reduce the weight and suitable to dampen vibrations
- cross beam in structural steel
- motor head in cast iron to reduce vibrations during the cut.

Mechanical stops for a fast head rotation at 0°, 45° and 60° degrees.

Material clamping vice with rack system, manual positioning and fast clamping system equipped with hydraulic locking cylinder.

2 material supporting rollers placed on the loading side of the basement.

Flange unit with conical bearings supporting the motor wheel, solution that allows preserving the gear unit by the efforts caused by the blade tensioning and thus ensuring it a long life.

Push buttons control panel to perform all the machine handlings and diagnostics of possible alarms.



Structure archet en 3 parties:

- tête folle en aluminium pour en réduire le poids et apte à amortir les vibrations
- traverse en acier structural
- tête moteur en fonte pour réduire les vibrations pendant la coupe.

Arrêts mécaniques pour une rotation rapide de l'archet à 0°, 45° et 60° degrés.

Etau blocage matériel positionnable manuellement pourvu de système de glissement rapide à crémaillère et vérin de blocage hydraulique.

2 rouleaux d'appui matériel placés sur le bâti en côté chargement.

Groupe bride avec roulements à cônes opposés à l'appui du volant moteur, solution qui permet de préserver le réducteur des efforts dus à la tension du ruban et de lui garantir une longue durée.

Panneau de contrôle à poussoirs pour effectuer toute manipulation de la machine et diagnostique des alarmes.

SATURN

Segatrice a nastro semiautomatica per tagli da 0° a 60° destra e 0° a 45° sinistra di profilati o pieni di medie dimensioni.

Arco a gestione idraulica con regolazione del taglio tramite valvola di flusso monogiro, in posizione ergonomica.

Morsa chiusura materiale in ghisa, posizionamento manuale con cilindro di bloccaggio idraulico.

Rotazione arco con fermi di battuta a 0°, 45°, 60° e -45°.

Scala graduata per lettura angolo e robusta leva di bloccaggio.

Semi automatic band saw machine for cutting from 0° to 60° right and from 0° to 45° left, of profiles or full of medium dimensions.

Head hydraulic controlled with cutting adjustment by single-turn flow valve, in an ergonomic position.

Material clamping vice in cast iron, with manual hand wheel and hydraulic lock cylinder.

Head rotation angle stop at 0°, 45°, 60° and -45°.

Degrees measuring system, graduated scale and rugged in construction locking lever.

Scie à ruban semi-automatique pour coupes de 0° à 60° à droite et de 0° à 45° à gauche de profilés ou pleins de dimensions moyennes.

Archet à contrôle hydraulique avec réglage de la coupe par soupape d'écoulement mono-tour, en position ergonomique.

Etau blocage matériel en fonte, positionnable manuellement pourvu de vérin de blocage hydraulique.

Rotation archet avec arrêts d e butée à 0°, 45°, 60° et -45°.

Échelle graduée pour lecture de l'angle et robuste levier de blocage.



OPTIONAL
OPTIONALS • OPTIONS

DMI
DOTM
DTI
LX
MT
NB1 / NB2
RPM1
SENS+SD
TM
VAT









CAPACITÀ DI TAGLIO

CUTTING CAPACITY • CAPACITÉ DE COUPE

| | ● Ø mm | a ■ axb mm b | a ■ axb mm b | a ■ axb mm b |
|-------|--------|-----------------|-----------------|-----------------|
| 0° | 305 | 300 | 300x375 | 300x375 |
| 45° → | 260 | 240 | 155x260 | 300x220 |
| 60° → | 170 | 160 | 160x170 | 265x150 |
| 45° ← | 280 | 255 | 180x280 | 300x245 |

CARATTERISTICHE TECNICHE

TECHNICAL CHARACTERISTICS • CARACTÉRISTIQUES TECHNIQUES

|  mm |  m/min |  kW |  kW |  kW |  KG |  a x b x c m |  h ± 10 mm |  OPTIONAL mm a x b |
|---|--|---|---|---|---|---|---|---|
| 3420x27x0,9 | 16÷100 | 1,5 | 0,08 | 0,36 | 800 | 1x1,8x1,55 | 990 | 150x300 |

ALCUNE CARATTERISTICHE
A FEW FEATURES • QUELQUES CARACTÉRISTIQUES

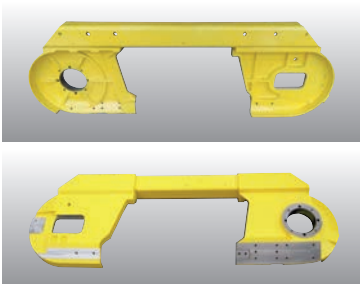

Struttura arco realizzata in 3 parti:

- testata folle in alluminio per diminuire il peso ed idonea ad assorbire le vibrazioni
- traversa in acciaio strutturale
- testata motore in ghisa per diminuire le vibrazioni durante il taglio.



Battute meccaniche per la rotazione rapida dell'arco ai gradi 0°, 45°, 60° e -45°.



Morsa chiusura materiale in ghisa a posizionamento manuale, dotata di cilindro di chiusura idraulico.

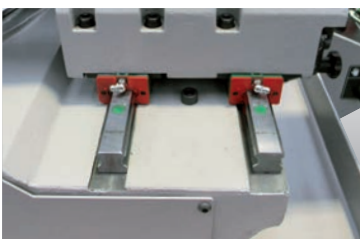

Traslazione su guide lineari della morsa per tagli a destra e sinistra.

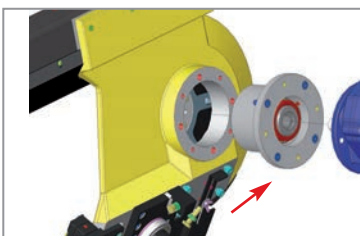

Gruppo flangia con cuscinetti conici contrapposti a sostegno del volano motore, soluzione che permette di preservare il riduttore dagli sforzi causati dalla tensione della lama e quindi di garantirne una lunga vita.



Vasca refrigerante da 40 l integrata nella parte superiore del basamento, facilmente accessibile per la pulizia e il riempimento, con tappo di scarico.



Head structure in three parts:

- idle head in aluminum to reduce the weight and suitable to dampen vibrations
- cross beam in structural steel
- motor head in cast iron to reduce vibrations during the cut.

Mechanical stops for a fast head rotation at 0°, 45°, 60° and -45° degrees.

Clamping vice in cast iron movable by hand equipped with hydraulic locking cylinder.

Translation on vice linear guides for right and left side cuttings.

Flange unit with conical bearings supporting the motor wheel, solution that allows preserving the gear unit by the efforts caused by the blade tensioning and thus ensuring it a long life.

40 l coolant tank integrated in the upper part of the basement, easily accessible for cleaning and filling with exhaust plug.



Structure archet en 3 parties:

- tête folle en aluminium pour réduire le poids et apte à amortir les vibrations
- traverse en acier structural
- tête moteur en fonte pour réduire les vibrations pendant la coupe.

Arrêts mécaniques pour une rotation rapide de l'archet à 0°, 45°, 60° et -45° degrés.

Etau blocage matériel en fonte réglable à la main pourvu de vérin de blocage hydraulique.

Décalage sur guides linéaires de l'étau pour coupes à droite et à gauche.

Groupe bride avec roulements à cônes opposés à l'appui du volant moteur, solution qui permet de préserver le réducteur des efforts dus à la tension du ruban et de lui garantir une longue durée.

Bac réfrigérant de 40 l intégré dans la partie supérieure du bâti, facile à joindre pour le nettoyage et le remplissage, avec bouchon de vidange.

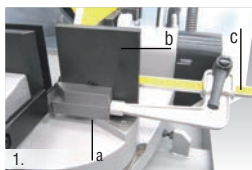

- a. La lunghezza del pezzo tagliato è corrispondente alla quota dell'asta di misura sia per i tagli dritti che inclinati.
- b. Ganasce sostituibili in caso di usura.
- c. Asta in alluminio per tagli a misura, con riscontro ribaltabile e scala serigrafata con doppia indicazione pollici/mm.



La lama è protetta su tutta la sua lunghezza in accordo alle norme di sicurezza.



La lama è tensionabile manualmente. Un sistema dinamometrico segnala la giusta tensione della lama. Il raggiungimento della tensione corretta è chiaramente visibile da una tacca, in caso di rottura della lama, un finecorsa ne interrompe la rotazione.



Elevata precisione di taglio e massima durata della lama assicurate da un corpo guida-lama composto da:

- 2 cuscinetti verticali sfalsati per un primo raddrizzamento della lama
- 2 placchette widia delle dimensioni 20x20 per mantenere dritta la lama
- 1 cuscinetto posto sul dorso lama per contrastare lo sforzo di taglio.



Riduttore ad assi paralleli con ingranaggi costruiti in acciaio legato, cementati e temprati con successiva lavorazione di rettifica sui fianchi dei denti per migliorarne il rendimento e la silenziosità di funzionamento anche sotto carico. L'albero di ingresso è realizzato con acciaio legato, cementato e temprato; quello in uscita con acciaio bonificato. Rendimento del riduttore pari a 95% contro il rendimento pari a circa 55% di un riduttore a vite senza fine comunemente utilizzato su segatrici a nastro.



Attacco cilindro oleodinamico arco con snodo sferico per un lineare avanzamento della discesa dell'arco.

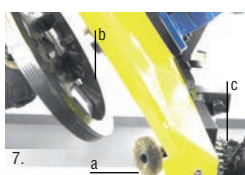

- a. Spazzola folle per la pulizia della lama con regolazione facile e pratica.
- b. Volano folle sostenuto da una coppia di cuscinetti conici.
- c. Perno di fulcro dell'arco sostenuto da due cuscinetti conici precaricati in modo da ottenere regolarità e rigidità della discesa arco durante il taglio.

- a. The cut piece length corresponds to the measure of the length stop, for both straight and inclined cuts.
- b. Replaceable jaws in case of wear.
- c. Rod in aluminum for measure cuttings, with tip-up striker and serigraphy scale with both inches/mm measure units.

The blade is entirely covered with a protection guard according to the safety regulation.

The blade can be manually tightened. A dynamometric system indicates the correct blade tension. The achievement of the correct tension is clearly visible by notch, in case of blade breakage, a limit switch interrupts its rotation.

High cutting precision and the longest blade life ensured by a blade-guide unit made of:

- 2 vertical staggered bearings for a first blade straightening
- 2 20x20-dimensioned hard metal plates keeping the blade straight
- 1 bearing placed on the back of the blade to contrast the cutting force.

Helical gear box with gears in carburized and hardened alloy steel. Teeth laterally rectified to increase efficiency and silentness even under maximum stress. The input shaft is in carburized and hardened alloy steel; the output shaft is in hardened steel. Gear box efficiency equal to 95% while efficiency of a worm gear box commonly used on band saw machines is of about 55%.

Hydraulic head cylinder connection with ball joint for a linear head drop.

- a. Blade cleaning idle brush easy to regulate and practical.
- b. Fly wheel supported by a couple of conical bearings.
- c. Head pivot supported by two conical bearings pre-loaded so to have a regular and rigid head descent during cutting.

- a. La longueur de la pièce coupée correspond à la cote de la règle soit pour les coupes droites que pour les coupes inclinées.
- b. Mâchoires remplaçables en cas d'usure.
- c. Règle en aluminium pour coupes à mesure, avec butée basculante et échelle sérigraphique avec la double indication en pouces/mm.

Le ruban est entièrement couvert par un carter de protection conformément à la loi sur la sécurité.

Le ruban est tendu manuellement. Un système dynamométrique signale la tension correcte du ruban. L'atteinte de la tension correcte est clairement visible grâce à un cran, en cas de rupture lame, un fin de course en bloque la rotation.

Haute précision de coupe et durée maximale du ruban assurées par un groupe guide-lame composé par:

- 2 roulements verticaux décalés pour un premier dressage de la lame
- 2 plaquettes en carbure 20x20 pour garder le ruban droit
- 1 roulement placé sur le dos du ruban pour opposer la force de coupe.

Réducteur à axes parallèles avec engrenages en acier allié, cémentés et trempés lesquelles dents ont été rectifiées sur les flancs afin d'améliorer son rendement et de le rendre plus silencieux même sous charge. L'arbre d'entrée est en acier allié, cémenté et trempé ; celui de sortie est en acier trempé et recuit. Le rendement de ce réducteur est de 95% contrairement au rendement d'un réducteur à vis sans fin généralement utilisé sur des scies à ruban qui est de 55%.

Attelage vérin archet hydraulique avec joint à rotule pour une descente de l'archet plus linéaire.

- a. Brosse pour le nettoyage du ruban facile à régler et pratique.
- b. Volant fou soutenu par une couple de roulements coniques.
- c. Pivot de l'archet soutenu par deux roulements coniques bandés afin d'avoir une descente de l'archet régulière et rigide pendant la coupe.



Avvicinamento della ganascia mobile tramite una vite trapezoidale che garantisce un sistema di manovra scorrevole ed efficiente anche ad elevati carichi. Accoppiamento slitta morsa prismatica per una maggior precisione. Ganascia d'appoggio per il sostegno del materiale in uscita.

Movable jaw approach by a trapezoidal screw granting a smooth and efficient manoeuvring system even at high loads. Slide vice prismatic coupling for more precision. Unloading side material supporting jaw.

Approche de la mâchoire mobile par vis trapézoïdale qui garantit un système de manœuvre roulant et efficace même à des charges élevées. Accouplement glissière étai prismatique pour plus de précision. Mâchoire de support pour le soutien du matériel en sortie.



Pannello elettronico per la gestione della macchina.
Il display visualizza:
• quantità dei tagli
• velocità della lama
• angolo di taglio (con optional VAT)
• allarmi
Selezione lubrificazione: attivata, disattivata, minimale (con optional NB1/NB2).
Non presente su Galactic - Mercury - Saturn

Electronic control panel for machine control. On the display are shown:
• cuttings quantity
• blade speed
• cutting angle (with optional VAT),
• alarms
Lubricant selection: on, off, nebulized (with NB1/NB2 optional).
Not on Galactic - Mercury - Saturn

Panneau électronique pour la gestion de la scie. L'afficheur montre:
• le nombre des coupes
• la vitesse lame
• l'angle de coupe (avec option VAT)
• les alarmes.
Sélection lubrification: activée, éteinte, nébulisée (avec option NB1/NB2).
Pas pour Galactic - Mercury - Saturn

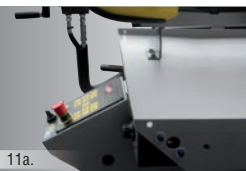

a. Il quadro comandi è in posizione ergonomica sul fronte macchina per poter comodamente comandare le funzionalità e le emergenze. Se il quadrante comandi fosse posizionato in alto dietro la morsa durante i tagli a gradi non sarebbe raggiungibile dall'operatore.

a. Control panel in ergonomic position on the front side of the machine so to easily operate on any function and alarm. If the control panel was placed high behind the vice, in case of degrees cut it could not be reached by the operator.

a. Le panneau des commandes est placé en position ergonomique sur le devant de la machine pour pouvoir contrôler au mieux les fonctions et les alarmes. Si le cadre des commandes était placé en haut derrière l'étau en cas de coupes à degrés il ne pourrait être joignable par l'opérateur.



b. Comoda posizione frontale della leva di blocco / sblocco dell'arco per i tagli inclinati.

b. Head lock/unlock lever placed in a practical position on the front side of the machine for an easy use in inclined cuts.

b. Position frontale très pratique du levier de blocage/déblocage de l'archet pour les coupes inclinées.



Sensore posizione arco. Ad ogni avvio, la macchina memorizza la posizione di partenza dell'arco. A fine ciclo, l'arco ritorna automaticamente alla quota di partenza. Questo permette all'operatore di risparmiare tempo quando i pezzi da tagliare hanno le stesse dimensioni.

Head position sensor. At every start, the machine stores the head starting position. At the end of the cycle, the head automatically returns to the starting quota. This allows the operator to save time when the pieces to be cut are the same size.

Capteur de position archet. A chaque démarrage, la machine mémorise la position de départ de l'archet. A la fin du cycle, l'archet revient automatiquement à la cote de départ. Ceci permet à l'opérateur de gagner du temps lorsque les pièces à usiner ont les mêmes dimensions.

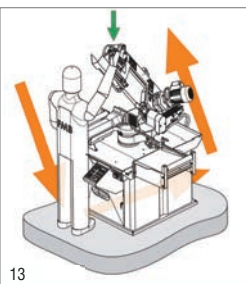

Dispositivo di serie per il taglio manuale per:
• Centauro
• Sirius
• Calipso
• Omega

Standard device for manual cutting for:
• Centauro
• Sirius
• Calipso
• Omega

Dispositif standard pour coupe manuelle pour:
• Centauro
• Sirius
• Calipso
• Omega



Sistema di movimentazione arco con cilindro idraulico e valvola di flusso monogiro per regolazione discesa in posizione frontale.

Head feeding system with hydraulic cylinder and single-turn front valve for feeding regulation.

Système mouvement archet par vérin hydraulique et soupape de réglage descente monotour en position frontale.



VAT
Visualizzatore angolo di taglio.
Cutting angle display.
Visualisation de l'angle de coupe.



VAT:
MERCURY
GALACTIC
SATURN



RPM1
Regolazione pressione morsa.
Vice pressure adjustment.
Reglage de la pression de serrage de l'etau.

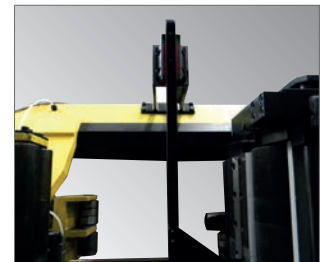

TM
Tastatore meccanico.
Fast approach.
Contacteur de ralentissement de descente.



DM
Doppia morsa manuale - tagli a 0°.
Manual double vice - cut at 0°.
Double étau manuel- coupes 0°.



DMI
Doppia morsa idraulica - tagli a 0°.
Hydraulic double vice - cut at 0°.
Double étau hydraulique - coupes 0°.



LX
Illuminazione linea di taglio con laser.
Laser lighting for cutting line.
Projection de la ligne coupe par laser.



NB1/NB2
Nebulizzatore per la lubrificazione lama ad uno e due ugelli.
Sprayer for blade lubrication one/two nozzle.
Micro pulvérisation pour la lubrification du ruban à un/deux buses.

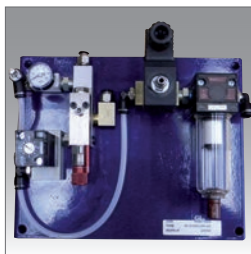

NEBULA OIL NB (5 KG)
Lubrificante ecologico di alta qualità.
Eco-friendly high quality lubricant.
Lubrifiant écologique de haute qualité.



DOTM
Dispositivo oleodinamico per taglio a pacco.
Oleodynamic device for bundle cutting.
Serrage vertical hydraulique pour paquets.



SENS
Sensore rotazione nastro
Blade rotation sensor
Contrôle de defilement du ruban par detecteur

| | DM | DMI | DOTM | DTI | LX | MT | NB1 | NB2 | NB1 BOX | NB2 BOX | RIA | RPM1 | SENS | TM | VAT |
|----------|----|-----|------|-----|----|----|-----|-----|---------|---------|-----|------|------|----|-----|
| CENTAURO | | | | 0 | 0 | 0 | 0 | 0 | | | | | 0 | 0 | 0 |
| SIRIUS | | | 0 | 0 | 0 | 0 | 0 | 0 | | | 0 | 0 | 0 | 0 | 0 |
| CALIPSO | 0 | | | 0 | 0 | 0 | 0 | 0 | | | | | 0 | 0 | 0 |
| OMEGA | | 0 | 0 | 0 | 0 | 0 | 0 | 0 | | | | 0 | 0 | 0 | 0 |
| MAJOR | | | 0 | 0 | 0 | 0 | 0 | 0 | | | | 0 | 0 | 0 | 0 |
| MERCURY | | | 0 | 0 | 0 | 0 | 0 | 0 | | | | 0 | 0 | 0 | 0 |
| GALACTIC | | | 0 | 0 | 0 | 0 | | | 0 | 0 | | 0 | 0 | 0 | 0 |
| SATURN | | 0 | 0 | 0 | 0 | 0 | 0 | 0 | | | | 0 | 0 | 0 | 0 |

0 = optional

FM..RS / FM..RSE

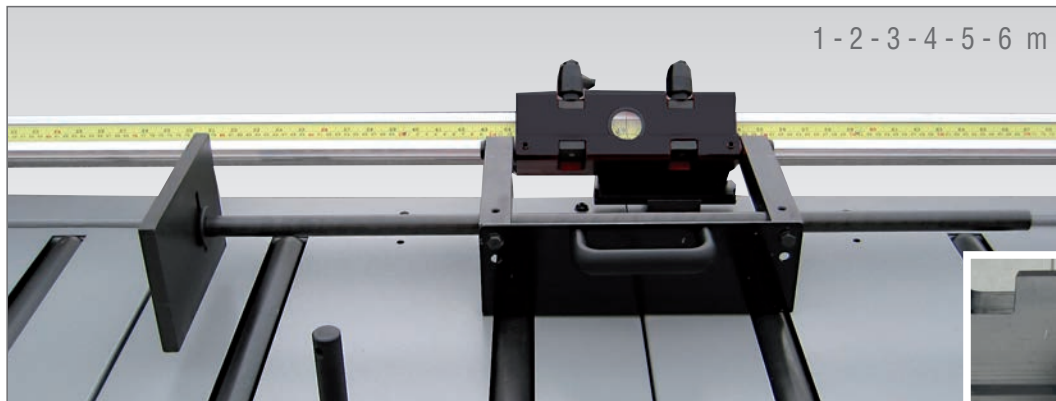

FM..RSP

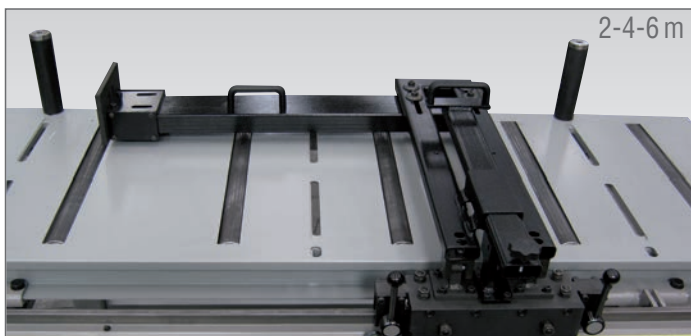

| | FM..RS | FM..RSE | FM..RSP | FM-RI | CRC | CRS | RRS | CREC | CRES |
|----------|--------|---------|---------|-------|-----|-----|-----|------|------|
| CENTAURO | | S | | | | | S | C | S |
| SIRIUS | | S | | S | | | S | C | S |
| CALIPSO | | S | | | | | S | C | S |
| OMEGA | | S | | S | | | S | C | S |
| MAJOR | S | | | S | C | S | S | | |
| MERCURY | S | | | S | C | S | S | | |
| GALACTIC | | | S | | | | | | |
| SATURN | S | | | S | C | S | S | | |

C = LATO CARICO/LOADING SIDE
S = LATO SCARICO/UNLOADING SIDE

FM - RI

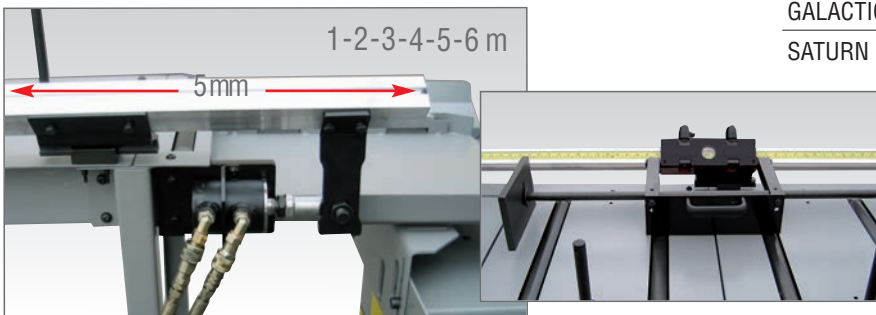

CRES



RRS



RRS

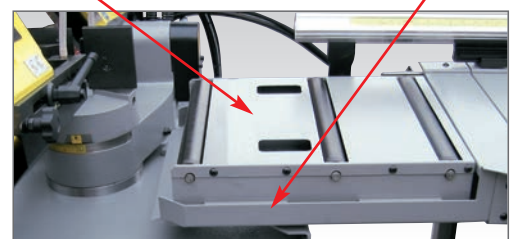

CRS

CRC

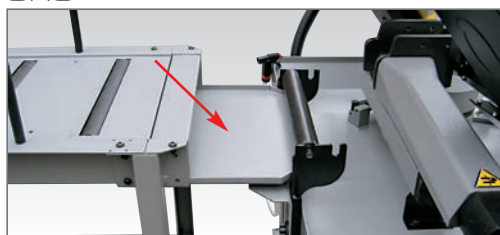

CRS

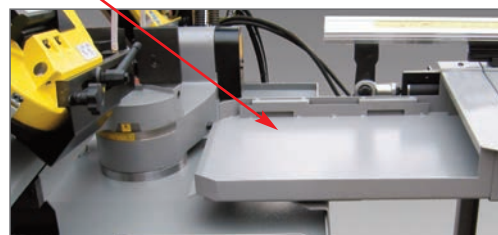

CREC



RFP2 - Max 1000 kg/m - 2m Galactic



Rullo / Roller / Rouleau - L = 550 mm

| | RFP2 | RP2G | RP1G | RE2G | RE1G | C2 | RMN | CNP | RCN | RM |
|----------|------|------|------|------|------|-----|-----|-----|-----|-----|
| CENTAURO | | | | C/S | C/S | C/S | S | | S | C/S |
| SIRIUS | | | | C/S | C/S | C/S | S | | S | C/S |
| CALIPSO | | | | C/S | C/S | C/S | S | | S | C/S |
| OMEGA | | | | C/S | C/S | C/S | S | | S | C/S |
| MAJOR | | C/S | C/S | | | C/S | S | | S | C/S |
| MERCURY | | C/S | C/S | | | C/S | S | | S | C/S |
| GALACTIC | C/S | | | | | C/S | | S | | C/S |
| SATURN | | C/S | C/S | | | C/S | S | | S | C/S |

C = LATO CARICO/LOADING SIDE / S = LATO SCARICO/UNLOADING SIDE

RP1G / RP2G - Max 300 kg/m - 1m



Rullo / Roller / Rouleau - L = 400 mm

RE1G / RE2G - Max 260 kg/m - 1m

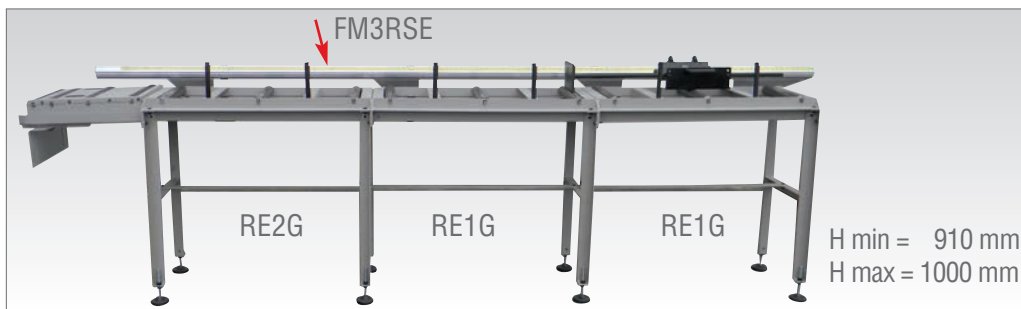

Rullo / Roller / Rouleau - L = 400 mm

RM



Sistema di avanzamento del materiale. Regolazione velocità rotazione rullo tramite VHZ. Da fissare alla rulliera o alla segatrice.

Material feeding system RM - Roller rotation speed control by VHZ. To be fixed to the roller table or to the band saw machine.

Système avance matériel. Réglage vitesse rotation rouleau par VHZ. À fixer à la table à rouleaux ou à la scie à ruban.

Rullo motorizzato: L = 780 mm / Motorized roller: L = 780 mm / Rouleau motorisé: L = 780 mm

C2
Max 750 kg

H min = 840 mm
H max = 1015 mm



Rullo / Roller / Rouleau
L = 550 mm



**Rulliere di misura a 1 montante
Lato scarico.**



**Stroke Reference Roller Table With 1 Guide
Unloading Side.**



**Tables de Mesure à 1 Montant
Côté déchargement.**

RMN - Max 260 kg/m
Centaurus - Sirius - Calipso - Omega - Major - Mercury - Saturn



2-3-4-5-6 m
Rullo / Roller / Rouleau - L = 400 mm

H min = 910 mm
H max = 1015 mm



Sistema di lettura misura digitale con posizionamento riscontro manuale tramite volantino.



Digital measuring reading system with manual striker positioning by handwheel.



Système de lecture de mesure digital avec déplacement manuel de la butée par petit volant.

RCN - Max 300 kg/m - 220 V/50Hz/1ph
Centaurus - Sirius - Calipso - Omega - Major - Mercury - Saturn



2-3-4-5-6 m
Rullo / Roller / Rouleau
L = 400 mm

H min = 910 mm
H max = 1015 mm



Sistema di lettura misura digitale con posizionamento riscontro automatico.



Digital measuring reading system with automatic striker positioning.



Système de lecture numérique avec décalage butée automatique.

CNP - Max 600 kg/m - 220V/50Hz/1ph
Galactic



4 - 6 m
Rullo / Roller / Rouleau - L = 550 mm

H min = 925 mm
H max = 980 mm



Sistema di lettura misura digitale con posizionamento riscontro automatico.

Riscontro misura con ribaltamento pneumatico.



Digital measuring reading system with automatic striker positioning. Measuring striker with pneumatic tilting.



Système de lecture numérique avec décalage butée automatique. Butée mesure avec renversement pneumatique.

TABELLE COMPARATIVE

COMPARATIVE TABLES • TABLEAUX COMPARATIFS

CAPACITÀ DI TAGLIO

CUTTING CAPACITY • CAPACITÉ DE COUPE

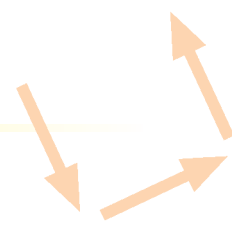











SEMIAUTOMATICHE

SEMI-AUTOMATIC • SEMI-AUTOMATIQUES

| | 0° | | | | 45° → | | | | 60° → | | | | 45° ← | | | |
|------------|------|------------------|------------------|------------------|-------|------------------|------------------|------------------|-------|------------------|------------------|------------------|-------|------------------|------------------|------------------|
| | Ø mm | a b axb mm | a b axb mm | a b axb mm | Ø mm | a b axb mm | a b axb mm | a b axb mm | Ø mm | a b axb mm | a b axb mm | a b axb mm | Ø mm | a b axb mm | a b axb mm | a b axb mm |
| H27 | | | | | | | | | | | | | | | | |
| CENTAURO | 240 | 240 | 210x280 | 240x260 | 185 | 175 | 140x180 | 220x165 | 115 | 110 | 110x110 | 110x110 | - | - | - | - |
| SIRIUS | 240 | 240 | 210x280 | 240x260 | 185 | 175 | 140x180 | 220x165 | 115 | 110 | 110x110 | 110x110 | - | - | - | - |
| CALIPSO | 240 | 240 | 200x310 | 240x270 | 175 | 170 | 170x170 | 240x155 | 110 | 105 | 105x105 | 140x100 | 150 | 135 | 125x145 | 240x65 |
| OMEGA | 240 | 240 | 200x310 | 240x270 | 175 | 170 | 170x170 | 240x155 | 110 | 105 | 105x105 | 140x100 | 150 | 135 | 125x145 | 240x65 |
| MAJOR | 260 | 260 | 260x370 | 260x370 | 260 | 260 | 120x290 | 260x260 | 180 | 180 | 90x190 | 180x180 | - | - | - | - |
| MERCURY | 305 | 300 | 300x370 | 300x370 | 260 | 240 | 155x260 | 300x220 | 170 | 160 | 160x170 | 255x150 | - | - | - | - |
| GALACTIC | 305 | 300 | 240x420 | 260x410 | 260 | 260 | 120x290 | 260x260 | 180 | 180 | 90x190 | 180x180 | - | - | - | - |
| SATURN | 305 | 300 | 300x375 | 300x375 | 260 | 240 | 155x260 | 300x220 | 170 | 160 | 160x170 | 265x150 | 280 | 255 | 180x280 | 300x245 |

CARATTERISTICHE TECNICHE

TECHNICAL CHARACTERISTICS • CARACTÉRISTIQUES TECHNIQUES

| H27 |  mm |  m/min |  kW |  m/min+VHZ |  kW+VHZ |  kW |  kW |  Kg |  a x b x c m |  h ± 10 mm |  0° mm a x b |
|------------|--|---|--|---|--|--|---|--|--|--|--|
| CENTAURO | 2700x27x0,9 | 35-70 | 1,3 | 16÷120 | 1,5 | 0,08 | 0,36 | 365 | 0,85x1,45x1,45 | 950 | - |
| SIRIUS | 2700x27x0,9 | 35-70 | 1,3 | 16÷120 | 1,5 | 0,08 | 0,36 | 370 | 0,85x1,45x1,45 | 950 | 100x250 |
| CALIPSO | 2700x27x0,9 | 35-70 | 1,3 | 16÷120 | 1,5 | 0,08 | 0,36 | 490 | 0,85x1,45x1,5 | 990 | - |
| OMEGA | 2700x27x0,9 | 35-70 | 1,3 | 16÷120 | 1,5 | 0,08 | 0,36 | 490 | 0,85x1,45x1,5 | 990 | 120x280 |
| MAJOR | 3300x27x0,9 | - | - | 16÷120 | 1,5 | 0,08 | 0,36 | 515 | 0,85x1,95x1,5 | 960 | 140x280 |
| MERCURY | 3420x27x0,9 | - | - | 16÷100 | 1,5 | 0,08 | 0,36 | 560 | 0,9x1,8x1,5 | 960 | 140x280 |
| GALACTIC | 3420x27x0,9 | - | - | 16÷100 | 1,5 | 0,08 | 0,36 | 710 | 1,1x1,9x1,5 | 950 | 150x380 |
| SATURN | 3420x27x0,9 | - | - | 16÷100 | 1,5 | 0,08 | 0,36 | 800 | 1x1,8x1,55 | 990 | 150x300 |

STAI ACQUISTANDO UNA BUONA SEGATRICE?

Durante la scelta della vostra segatrice a nastro, vi suggeriamo di tenere in considerazione alcuni fattori:

ROBUSTEZZA DELLA MACCHINA

- Più una macchina è robusta, maggiore è il suo peso, più sarà ingrado di smorzare le vibrazioni che si generano durante il processo di taglio: il dente della lama sarà meno sollecitato e perciò durerà maggiormente. Anche la qualità del taglio sarà migliore. **Preferite perciò macchine con strutture massicce!**

SVILUPPO DELLA LAMA

- Una lama con sviluppo corto verrà più sollecitata durante il taglio: i denti si romperanno più velocemente. Preferite macchine che possano montare lame con sviluppo maggiore. **Tempi morti e fermi macchina per il cambio lama hanno un costo!**

POTENZA ALLA LAMA

- La forza con la quale la lama effettuerà il taglio dipende, oltre che dalla potenza del motore lama, anche dal tipo di riduttore montato sulla segatrice! Facciamo un esempio: due segatrici hanno lo stesso motore lama, supponiamo da 1,1 kW. Una è dotata di un **riduttore a vite senza fine** mentre l'altra è dotata di un **riduttore ad ingranaggi**. Il rendimento medio di un riduttore a vite senza fine è del 55% mentre, con un riduttore ad ingranaggi, si otterrà un rendimento medio del 95%.

La potenza che arriverà alla lama sarà:

- Con **riduttore ad ingranaggi**: $1,1 \text{ kW} \times 0,95\% = 1,05 \text{ kW}$
 - Con **riduttore a vite senza fine**: $1,1 \text{ kW} \times 0,55\% = 0,6 \text{ kW}$
- A conti fatti, usando un riduttore a vite senza fine, si ha uno "spreco" di energia - dissipata in calore - che non arriva alla lama.**

MATERIALI DA TAGLIARE

- Oggi esistono in commercio un'infinità di materiali con strutture fisiche anche molto differenti tra loro. La parola d'ordine nell'odierno mondo del lavoro è FLESSIBILITA': anche ad una macchina utensile si chiede la stessa cosa. Una segatrice dotata di inverter (o di variatore meccanico) permette all'operatore di scegliere la velocità lama adattandola al tipo di materiale da tagliare. Una sola macchina potrà così coprire disparate esigenze di taglio!

AFFIDABILITA' DEL COSTRUTTORE

- Il costruttore della vostra segatrice vanta una lunga esperienza nel settore? La rete di assistenza è capillare ed efficace? In futuro potreste aver bisogno di pezzi di ricambio o di un'assistenza tecnica.

La FMB mette a vostra disposizione telefonica, GRATUITAMENTE, un tecnico che vi aiuterà a risolvere piccoli problemi o Vi fornirà consigli utili all'uso di una SEGATRICE FMB!

ARE YOU CHOOSING A GOOD BAND SAW MACHINE?

While you are choosing your band saw machine, we suggest you to consider a few factors:

MACHINE SOLIDITY

- The more a machine is solid, greater is its weight, the more it will be able to dampen vibrations generated during the cutting process: the blade tooth will not be so stressed and consequently it will last more. Even the quality of the cut will be better. **Therefore, prefer machines with a massive structure!**

BLADE DEVELOPMENT

- A blade with a short development is more stressed during the cut: the teeth will break more quickly. Prefer machines with a greater blade development. **Downtimes and machine stops for blade replacement have a cost!**

POWER TO THE BLADE

- The force with which the blade will perform the cut depends not only on the blade motor power but also on the type of gearbox mounted on the machine!

Here is an example:

Two band saw machines with the same blade motor mounted, let's suppose of 1,1 kW.

One machine is equipped with a worm gearbox while the other machine is equipped with a helical gearbox.

The average efficiency of a worm gearbox is 55%, while with a helical gearbox the average efficiency is 95%.

The power arriving to the blade will be:

- With **helical gear box**: $1,1 \text{ kW} \times 0,95\% = 1,05 \text{ kW}$
- With **worm gear box**: $1,1 \text{ kW} \times 0,55\% = 0,6 \text{ kW}$

Overall, using a worm gearbox, there is a “waste” of energy - dissipated into heat – that does not arrive to the blade.

MATERIALS TO BE CUT

- Today commercially, there is an infinity of materials with very different physical structures between them. The password in today's business world is FLEXIBILITY: also to a machine tool, customers request the same thing. A band saw machine equipped of inverter (or mechanical variator) allows the operator to choose the blade speed adapting it to the type of material to be cut.

One only machine covering different cutting needs!

RELIABILITY OF THE MANUFACTURER

- Does the manufacturer of your band saw machine boasts an extensive experience in the field? Is his service network widespread and effective? In the future, you may need spare parts or a technical assistance.

FMB provides you, FREE, phone assistance with a technician who will help you to solve all small problems or will give you useful advice in the use of a FMB BAND SAW MACHINE!

ETES-VOUS EN TRAIN D'ACHETER UNE SCIE DE QUALITE ?

Au moment de choisir votre scie à ruban, nous vous suggérons d'examiner les facteurs suivants :

SOLIDITE DE LA MACHINE

- Plus une machine est robuste, plus grand est son poids, et plus elle sera en mesure d'amortir les vibrations qui ont été générés au cours du processus de coupe : la dent de la lame sera moins stressée et elle durera donc plus longtemps. Même la qualité de la coupe sera meilleure.

Préférez donc des machines avec une structure massive!

DEVELOPPEMENT DE LA LAME

- Une lame avec un court développement sera plus soumise à des sollicitations pendant la coupe : les dents se casseront plus rapidement. Préférez des machines avec un grand développement de lames. Temps morts et arrêts de la machine pour le remplacement de la lame ont un coût !

PUISSANCE SUR LA LAME

- La force avec laquelle la lame effectuera la coupe dépend de la puissance du moteur mais aussi du type de moteur monté sur la scie.

Voici un exemple :

deux scies à ruban avec le même moteur lame, supposons de 1,1kW. Une est équipée avec **un réducteur à vis sans fin** tandis que l'autre est équipée avec **un réducteur hélicoïdal** (à engrenages).

Le rendement moyen d'un réducteur à vis sans fin est de

55% alors que, avec un réducteur hélicoïdal, vous obtiendrez un rendement moyen de 95%.

La puissance qui arrive à la lame sera :

- Avec **réducteur hélicoïdal** : $1,1 \text{ kW} \times 0,95\% = 1,05 \text{ kW}$
- Avec **réducteur à vis sans fin** : $1,1 \text{ kW} \times 0,55\% = 0,6 \text{ kW}$

Tout compte fait, en utilisant un réducteur à vis sans fin, on a un "gaspillage" de l'énergie – dissipée sous forme de chaleur – qui n'arrive pas à la lame.

MATERIAUX A COUPER

- Aujourd'hui sur le marché il y a un nombre infini de matériaux avec des structures physiques très différentes. La flexibilité pour une scie est très importante. Une scie à ruban équipée d'onduleur ou variateur mécanique de vitesse permet à l'opérateur de choisir la vitesse de la lame en l'adaptant au type de matériel à couper. Une seule machine pourra alors couvrir différents besoins de coupe !

FIABILITE' DU CONSTRUCTEUR

- Est-ce que le constructeur de votre scie à ruban peut se vanter d'une vaste expérience dans ce domaine ? Le réseau du SAV est-il répandu et efficace? Dans l'avenir vous pourriez avoir besoin de pièces détachées ou d'une assistance technique.

FMB met à votre disposition téléphonique, GRATUITEMENT, un technicien qui pourra vous aider à résoudre les petits problèmes ou vous fournira des conseils utiles à l'utilisation d'une SCIE FMB !

HIGH-FIDELITY MACHINES

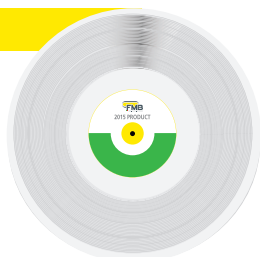

SEGATRICI A NASTRO MANUALI

MANUAL BAND SAWS | SCIES A RUBAN MANUELLES

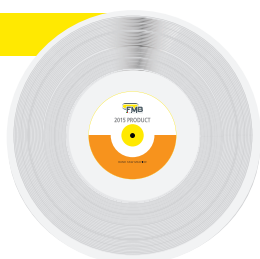

SEGATRICI A NASTRO SEMIAUTOMATICHE

SEMI-AUTOMATIC BAND SAWS | SCIES A RUBAN SEMIAUTOMATIQUES

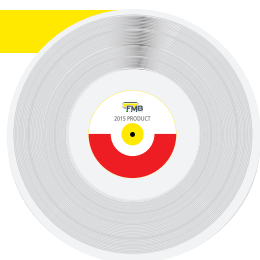

SEGATRICI A NASTRO AUTOMATICHE

AUTOMATIC BAND SAWS | SCIES A RUBAN AUTOMATIQUES

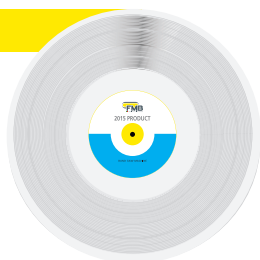

FORATRICI

DRILLING MACHINES | PERCEUSES



■ FABBRICA MACCHINE BERGAMO

FMB s.r.l.

Via Lodi 7 - 24044 Dalmine - (BG) - ITALY

Phone +39 035.4157600 - Fax +39 035 370668

info@fmb.it - www.fmb.it

 FMB-segatricianastro  fmbaws