

ANSI 1196 SERIES

CHEMICAL PROCESS PUMPS

ASME B73.1 STANDARD

ROTECH

QUALITY | COMMITMENT | ADAPTABILITY

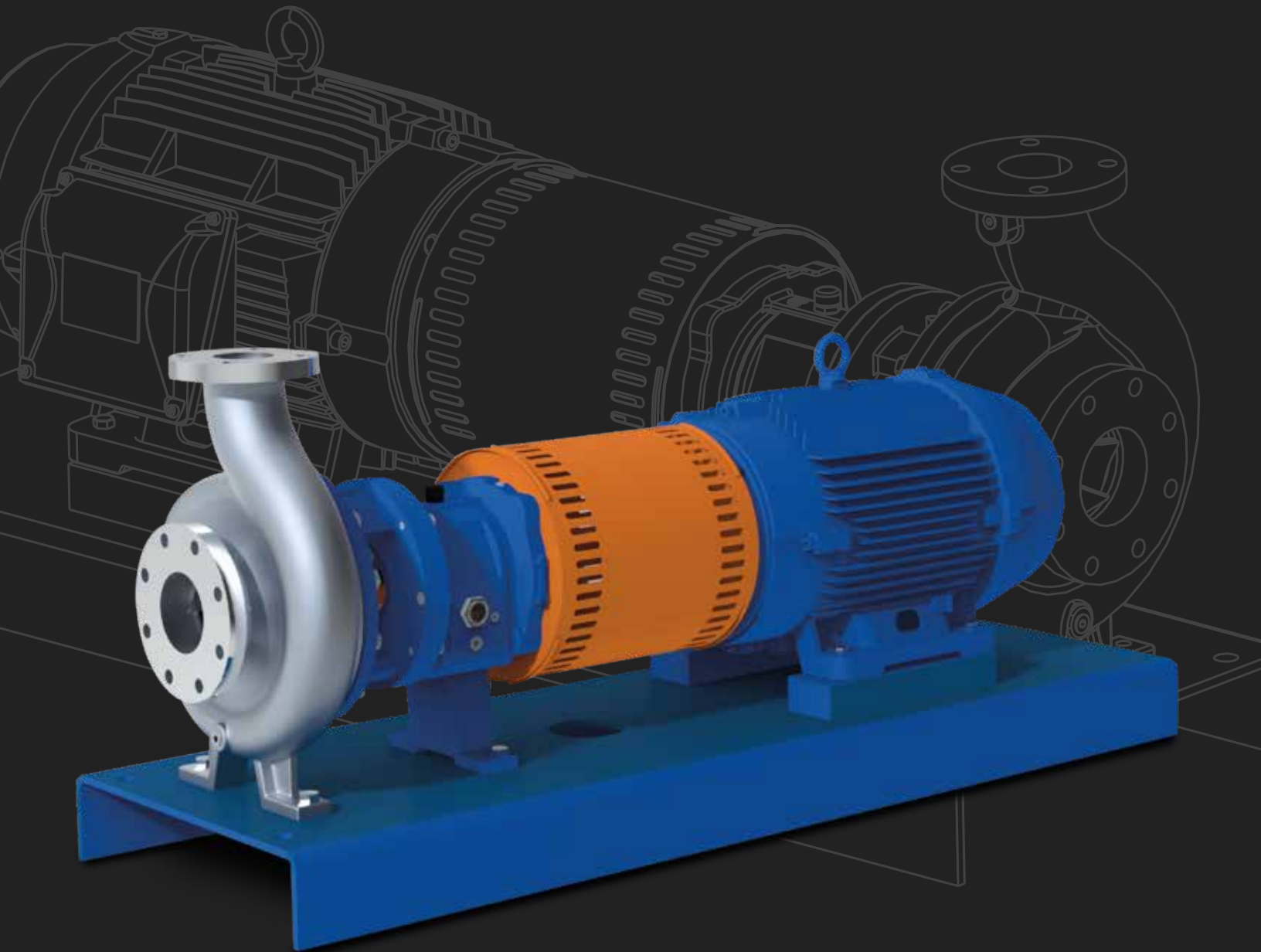

HIGH ON **PERFORMANCE**
GREAT ON **RELIABILITY**

ROTECH ANSI / ASME B73.1 PROCESS PUMP

Design Features

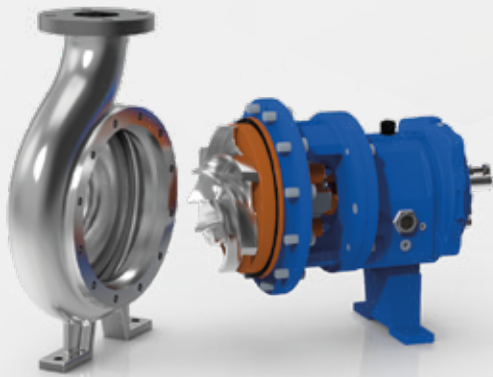

Material Options

- Ductile iron • Carbon steel • Stainless steel • Duplex SS • Alloy 20
- Hastelloy B & C • Nickel Alloys • Titanium and Any Other Special Alloys

Power Frame

- Bearing Frame: Ductile Iron Standard
Optional: Carbon Steel, 316SS.
- Internal surface cleaned, rust preventive applied, and enamel coated assuring internal casting cleanliness.

Shaft and Shaft Kit Assembly

- 4140 Steel Shaft as a standard,
Optional: 316SS Sleeved, 316SS Solid Shaft, 2205, 2507, Alloy 20 or any other special alloys against request.

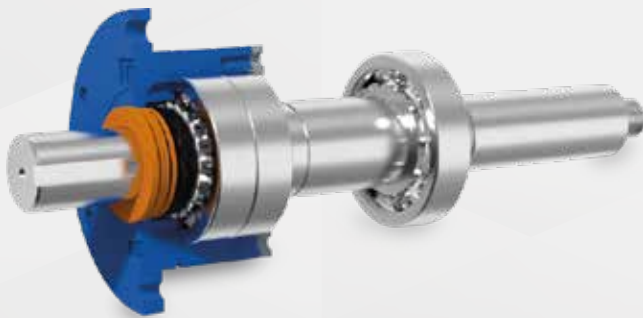

Base Frame Options

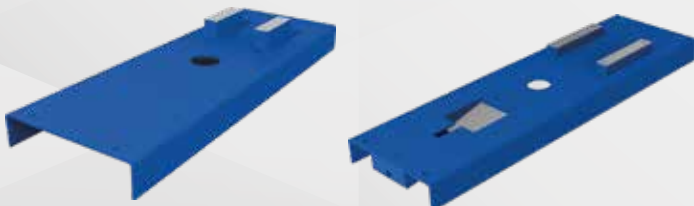

1196 Base Frame
Sheet Metal

1196 Drip Pan
Base Frame

Stuffing Box Covers / Sealing Options

- Standard Bore: Designed for packing & mechanical seal.
- Large Bore: Improved cooling & lubrication.
- Taper Bore: Lower seal face temperature, self-venting and draining, solid & vapours circulated away from seal face.



Standard Bore



Large Bore



Taper Bore



Component Seal



Single
Cartridge Seal



Dual
Cartridge Seal

High Temperature Application

- Finned Cooler: Directly cools oil for lower bearing temperature. Requires minimum cooling water. Corrosion resistant construction. Recommended for temperature over 350°F (177°C)
- Jacketed Stuffing Box: Keep proper temperature control of sealing environment. Perfect for polymerizing liquids.
- Jacketed Casing: Ideal for heating or cooling applications.



Jacketed Casing



Jacketed SBC



Finned Cooler

Dynamic Sealing Option

Sealing problem eliminated, Maintenance cost minimized, Utility costs reduced, No requirement of external seal water.

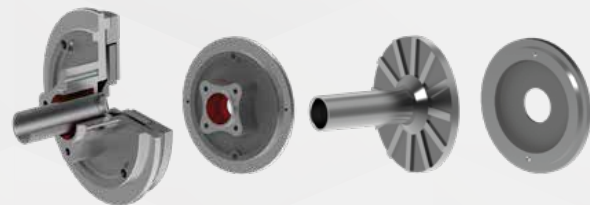

HYDRAULIC PERFORMANCE COVERAGE

4 Pole Motor

Capacity up to 7000 GPM (1570 m³/h) | Head up to 300 feet (92 m) | Temperature to 700°F (371°C) Pressure to 142 PSIG (979 kPa)

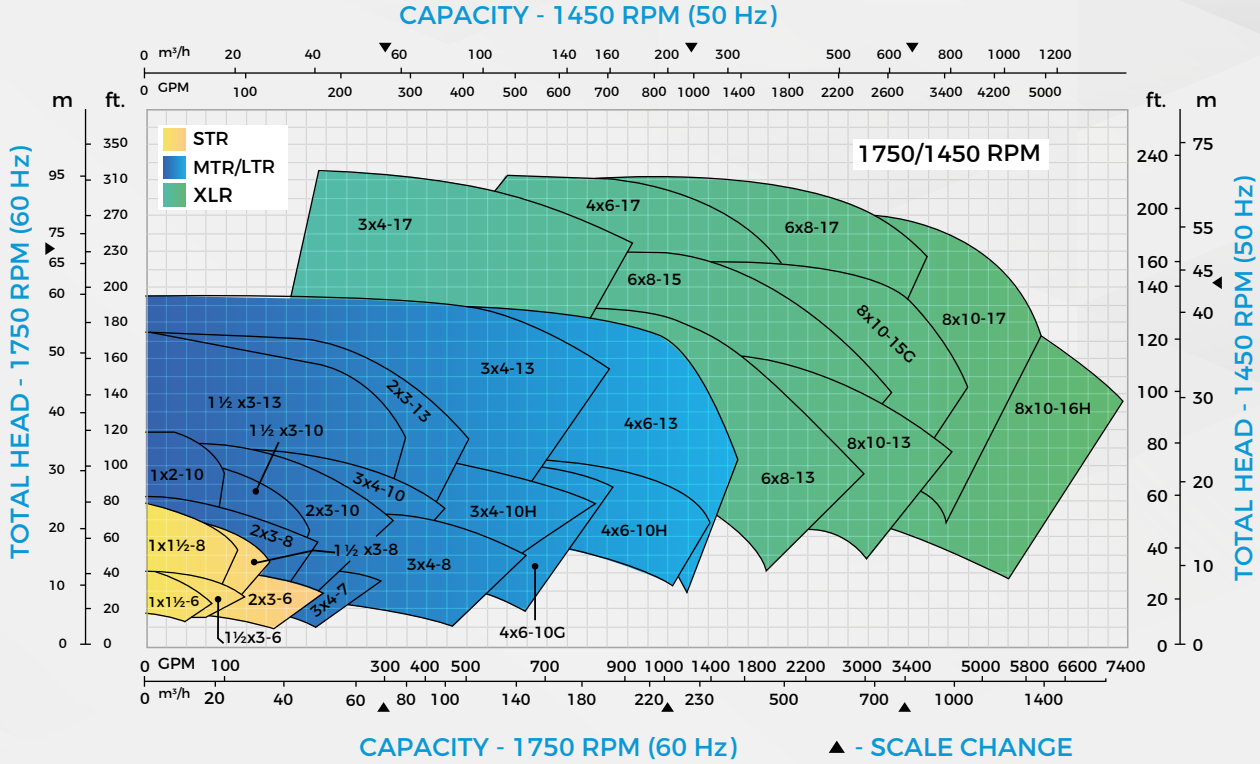

2 Pole Motor

Capacity up to 1400 GPM (318 m³/h) | Head up to 730 feet (223 m) | Temperature to 700°F (371°C) Pressure to 375 PSIG (2586 kPa)

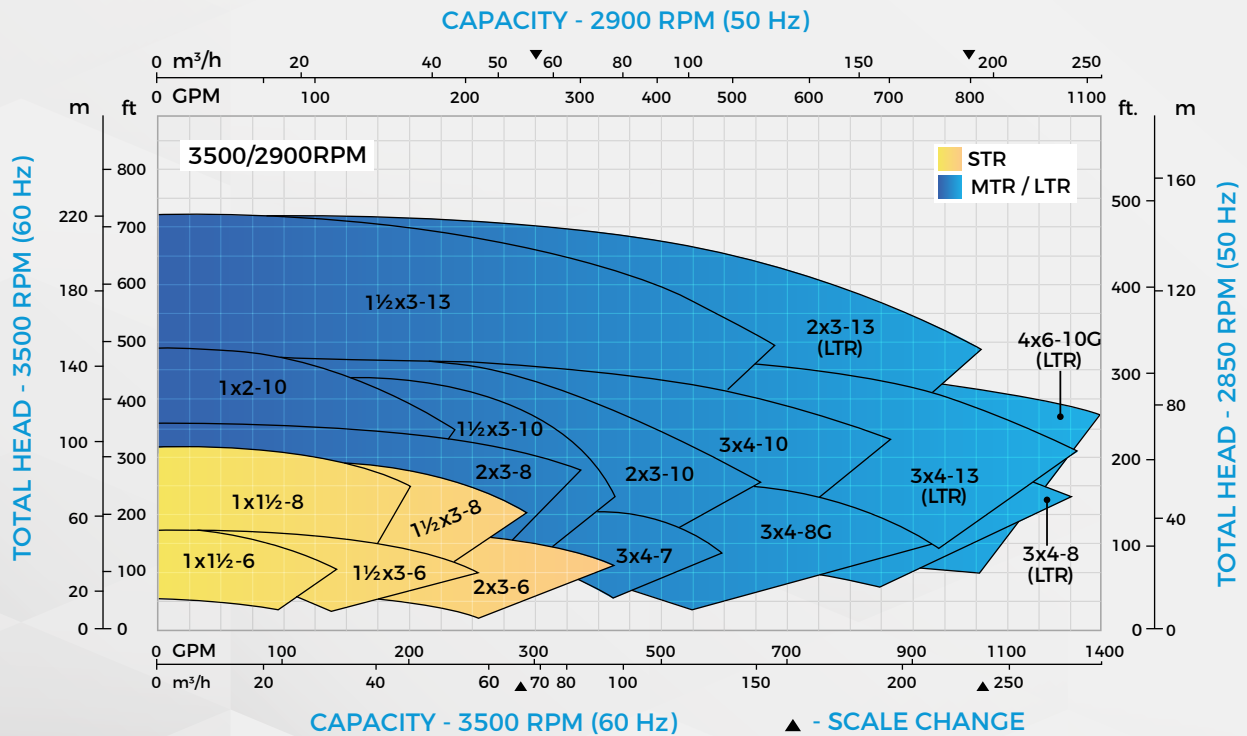

ROTECH ANSI/ASME B73.1 PROCESS PUMP

Sealing Options & Stuffing Box Cover

- Various component & ANSI cartridge seal configurations
- Various API Sealing Flush Plans
- Leak protection with maximum heat dissipation, extended seal life and pump reliability

Casing

- Full line of corrosive resistant materials
- Self venting, centerline mounted discharge flange
- Precision serrated flange face finish for optimum gasket retention and sealing
- Flange Options: Class 150# (Standard) and Class 300# (Optional)
- Increased casing thickness for extended casing life.
- Back Pull-out design for easy maintenance

Gasket

- Non-Asbestos Aramid Fibre
- PTFE, Glass filled Teflon
- Positive liquid sealing

Impeller

- Semi-open Impeller design for increasing abrasion, corrosion and solid wear resistance
- Solid handling capacity with ease in pumping fibrous material
- Back pump-out vanes reduces pressure on shaft seal
- Adjustment of clearance is easy when wear & tear takes place

Foot Mounted Casing

- Maximum casing stability and support for back pull out maintenance feature
- Reduced vibration

Casing Drain

- Casing drain port as standard
- Drain piping as optional

DELIVERY

Pumps / parts are strategically inventoried at various locations in North America, Asia for rush delivery in various material options.

PUMP SELECTOR PROGRAM

Access to end users and specifiers to select your pump application online at www.rotechpumps.com or Contact us for more help

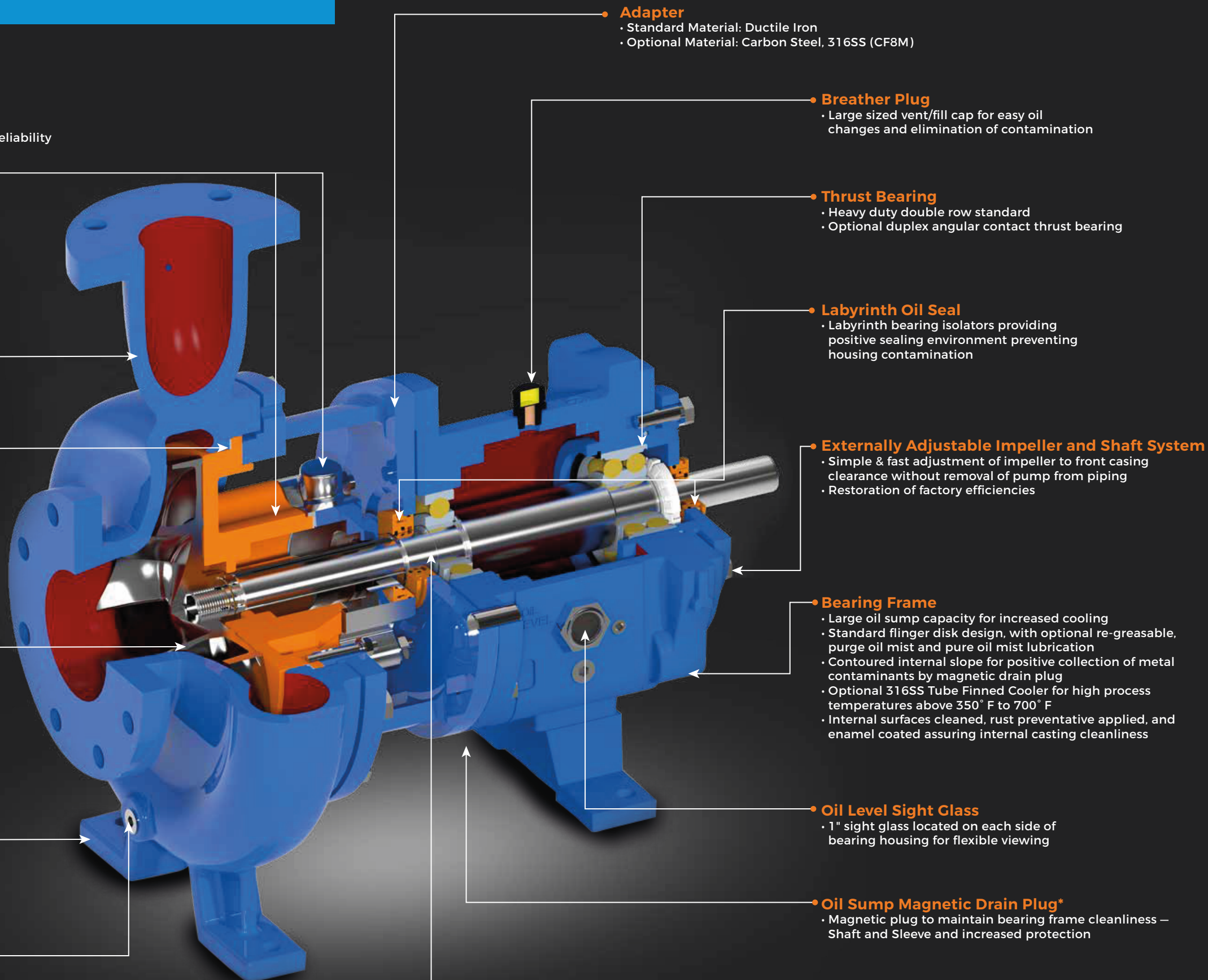

Adapter

- Standard Material: Ductile Iron
- Optional Material: Carbon Steel, 316SS (CF8M)

Breather Plug

- Large sized vent/fill cap for easy oil changes and elimination of contamination

Thrust Bearing

- Heavy duty double row standard
- Optional duplex angular contact thrust bearing

Labyrinth Oil Seal

- Labyrinth bearing isolators providing positive sealing environment preventing housing contamination

Externally Adjustable Impeller and Shaft System

- Simple & fast adjustment of impeller to front casing clearance without removal of pump from piping
- Restoration of factory efficiencies

Bearing Frame

- Large oil sump capacity for increased cooling
- Standard flinger disk design, with optional re-greasable, purge oil mist and pure oil mist lubrication
- Contoured internal slope for positive collection of metal contaminants by magnetic drain plug
- Optional 316SS Tube Finned Cooler for high process temperatures above 350° F to 700° F
- Internal surfaces cleaned, rust preventative applied, and enamel coated assuring internal casting cleanliness

Oil Level Sight Glass

- 1" sight glass located on each side of bearing housing for flexible viewing

Oil Sump Magnetic Drain Plug*













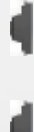

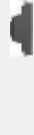
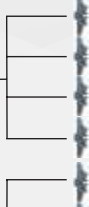

- Magnetic plug to maintain bearing frame cleanliness – Shaft and Sleeve and increased protection

Shaft and Sleeve

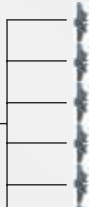
- Standard: 316SS Shaft sleeve with AISI 4140 Shaft
- Optional: Solid Shaft (MOC-AISI 4140, 316SS, 2205, 2507, Alloy 20, Monel, Nickel, Hastelloy B, C & G, Titanium) Sleeve
- Rigid heavy duty design for minimum shaft deflection at seal area and increased reliability

Note: (*) Not Illustrated

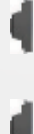
INTERCHANGEABILITY CHART

GROUP	SHAFT AND FRAME ASSEMBLY	ADAPTER	COVER	IMPELLER	CASING	SIZE
STR Shaft / Sleeve $\phi 1\text{-}3/8"$ Shaft end $\phi 0.875"$ Max BHP - 40HP						1x1.5-6 AA 1.5x3-6 AB 2x3-6 AC 1x1.5-8 AA 1.5x3-8 AB
MTR Shaft / Sleeve $\phi 1\text{-}3/4"$ Shaft end $\phi 1.125"$ Max BHP-122HP						3x4-7 A70 2x3-8 A60 3x4-8 A70 3x4-8G A70 1x2-10 A05 1.5x3-10 A50 2x3-10 A60 3x4-10 A70 3x4-10H A40 4x6-10G A80 4x6-10H A80 1.5x3-13 A20 2x3-13 A30 3x4-13 A40 4x6-13 A80
LTR Shaft / Sleeve $\phi 2\text{-}1/8"$ Shaft end $\phi 1.875"$ Max BHP-200HP						1x2-10 A05 1.5x3-10 A50 2x3-10 A60 3x4-10 A70 3x4-10H A40 4x6-10G A80 4x6-10H A80 1.5x3-13 A20 2x3-13 A30 3x4-13 A40 4x6-13 A80
XLR 15" Shaft / Sleeve $\phi 2\text{-}1/2"$ Shaft end $\phi 2.375"$ Max BHP-250HP XLR 17" Shaft / Sleeve $\phi 2\text{-}1/2"$ Shaft end $\phi 2.375"$ Max BHP-400HP						6x8-13 A90 8x10-13 A100 6x8-15 A110 8x10-15 A120 8x10-15G A120 8x10-16H A120 4x6-17 A105 6x8-17 A110 8x10-17 A120

PUMP DIMENSIONS AND WEIGHT

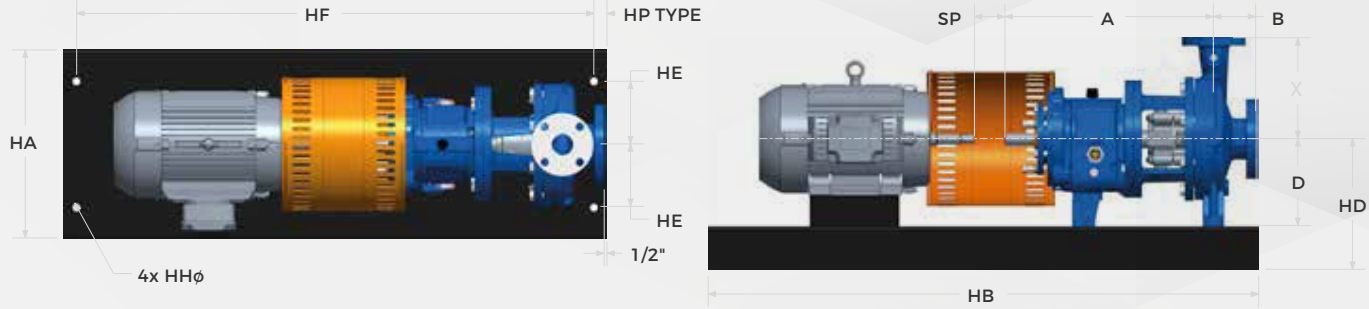

FRAME	SIZE	ANSI DESIGNATION	DISCHARGE SIZE	SUCTION SIZE	X	A	B	D	SP	WEIGHT BARE PUMP lb (kg)
STR	1x1.5-6	AA	1	1.5						110 (50)
	1.5x3-6	AB	1.5	3						120 (55)
	2x3-6	AC	2	3	6.5 (165)	13.5 (343)	4.0 (102)	5.25 (133)	3.75 (95)	125 (57)
	1x1.5-8	AA	1	L5						130 (59)
	1.5x3-8	AB	1.5	3						135 (61)
MTR/LTR	3x4-7	A70	3	4	11 (280)	19.5 (496)	4.0 (102)	8.25 (210)	3.75 (95)	270 (122)
	2x3-8	A60	2	3	9.5 (242)					265 (120)
	3x4-8	A70	3	4						270 (122)
	3x4-8G	A70	3	4	11 (280)					270 (122)
	1x2-10	A05	1	2						280 (127)
	1.5x3-10	A50	1.5	3	8.5 (216)	285 (129)				
	2x3-10	A60	2	3	9.5 (242)	275 (125)				
	3x4-10	A70	3	4	11 (280)	290 (132)				
	3x4-10H	A40	3	4	12.5 (318)	305 (138)				
	4x6-10G	A80	4	6		385 (175)				
	4x6-10H	A80	4	6	13.5 (343)					
	1.5x3-13	A20	1.5	3	10.5 (267)	19.5 (496)	4.0 (102)	10 (254)		350 (159)
	2x3-13	A30	2	3	11.5 (292)					355 (161)
	3x4-13	A40	3	4	12.5 (318)					370 (168)
4x6-13	A80	4	6	13.5 (343)				440 (200)		
XLR	6x8-13	A90	6	8	16 (406)					620 (281)
	8x10-13	A100	8	10						740 (336)
	6x8-15	A110	6	8	18 (457)					700 (318)
	8x10-15	A120	8	10						800 (363)
	8x10-15 G	A120	8	10	19 (483)	27.875 (708)	6 (152)	14.5 (368)	5.25 (133)	775 (352)
	8x10-16 H	A120	8	10						1030 (467)
	4x6-17	A105	4	6	16 (406)					720 (327)
	6x8-17	A110	6	8	18 (457)					815 (370)
8x10-17	A120	8	10	19 (483)					885 (401)	

BASE FRAME DIMENSIONS AND WEIGHT

NEMA MOTOR FRAME SIZE	ANSI BASE FRAME NUMBER	HA	HB	HD Max.				HE	HF	HH	HP (typ.)	WEIGHT lb (kg)
				D=5.25 (133)	D=8.25 (210)	D=10 (254)	D=14.5 (368)					
143T-184T	139	15 (381)	39 (991)	9 (229)				4.5 (114)	36.5 (927)	0.75 (19)	1.25 (32)	66(30)
213T-256T	148	18 (457)	48 (1219)	10.5 (267)				6 (152)	45.5 (1156)	0.75 (19)	1.25 (32)	82(37)
182T-184T	245	15 (381)	45 (1143)		12 (305)	13.75 (349)		4.5 (114)	42.5 (1080)	0.75 (19)	1.25 (32)	88(40)
213T-215T	252	18 (457)	52 (1321)		12.38 (314)	14.13 (359)		6 (152)	49.5 (1257)	0.75 (19)	1.25 (32)	106(48)
284T-286T	258	21(533)	58 (1473)		13 (330)	14.75 (375)		7.5 (191)	55.5 (1410)	1 (25)	1.25 (32)	179(81)
324T-326T	264	21(533)	64 (1626)		13.88 (353)	14.75 (375)		7.5(191)	61.5(1562)	1 (25)	1.25 (32)	218(99)
364T-365T	264	18 (457)	64 (1626)		13.88 (353)	14.75 (375)		7.5(191)	61.5(1562)	1 (25)	1.25(32)	172(78)
213T-215T	368	26 (660)	68 (1727)				19.25 (489)	9.5(241)	65.5(1664)	1 (25)	1.25(32)	387(176)
254T-256T	368	26 (660)	68 (1727)				19.25 (489)	9.5(241)	65.5 (1664)	1 (25)	1.25(32)	390(177)
284T-286T	368	26 (660)	68 (1727)				19.25 (489)	9.5 (241)	65.5 (1664)	1 (25)	1.25 (32)	392(178)
324T-326T	380	26 (660)	80 (2032)				19.25 (489)	9.5 (241)	77.5 (1969)	1 (25)	1.25 (32)	447(203)
364T-365T	380	26 (660)	80 (2032)				19.25 (489)	9.5 (241)	77.5 (1969)	1 (25)	1.25 (32)	427(194)
404T-405T	380	26 (660)	80 (2032)				19.25 (489)	9.5 (241)	77.5 (1969)	1 (25)	1.25 (32)	427(194)
444T-445T	398	26 (660)	98 (2489)				19.25 (489)	9.5 (241)	95.5 (2426)	1 (25)	1.25 (32)	443(201)
447T-449T	398	26 (660)	98 (2489)				19.25 (489)	9.5 (241)	95.5 (2426)	1 (25)	1.25 (32)	443(201)

NEMA MOTOR DIMENSIONS AND WEIGHT

NEMA MOTOR FRAME	182T	184T	213T	215T	254T	256T	284T	286T	324T	326T	364T	365T	405T	444T	445T	447T	449T
Weight lb (kg)	98 (45)	128 (58)	197 (89)	226 (103)	375 (170)	412 (187)	495 (225)	519 (235)	700 (318)	756 (343)	948 (430)	1009 (458)	1330 (603)	1820 (826)	1893 (859)	2343 (1073)	3020 (1370)

*Weight and dimensions are approximate and not to be used for construction.

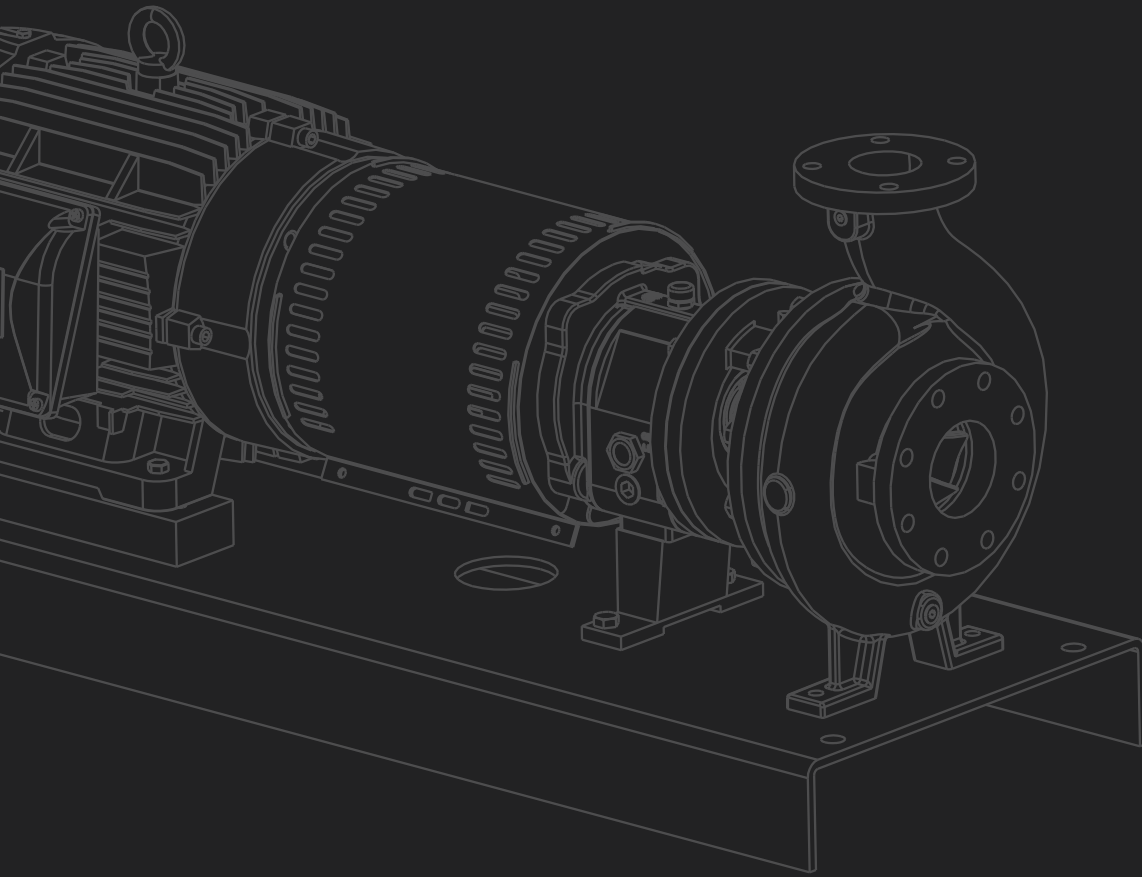

ROTECH

QUALITY | COMMITMENT | ADAPTABILITY

CANADA

Headquarters

1180 Britannia Road East,
Mississauga, Ontario, L4W 1C8

☎ 1 - 866 - 217 - 7867

✉ sales@rotechpumps.com



USA

Headquarters

16640, W Basin St,
Odessa, Texas 79763

☎ 432 - 556 - 8652

✉ usasales@rotechpumps.com

www.rotechpumps.com