



U24-10586-01  
 6,5 cm/2 1/2"  
 Fig.1



U24-10586-02  
 6,5 cm/2 1/2"  
 Fig.2



U24-10586-03  
 6,5 cm/2 1/2"  
 Fig.3



U24-10587-01



U24-10587-02



U24-10587-03



Goldsmith ( Thudichum)



Voltolini



Hartmann-Halle



U24-10588-01  
 15,5 cm/6"  
 Fig.1



U24-10588-02  
 15,5 cm/6"  
 Fig.1



U24-10588-03  
 15,5 cm/6"  
 Fig.1



U24-10589-13  
 13 cm/5"

## Rhinology Instruments

Nasal Specula      nasale spèculer  
Nasenspekula      Espèculo nasal



U24-10590-13  
1.5 cm/5"



U24-10591-13  
13 cm/5"

Teck-Halle



Killian

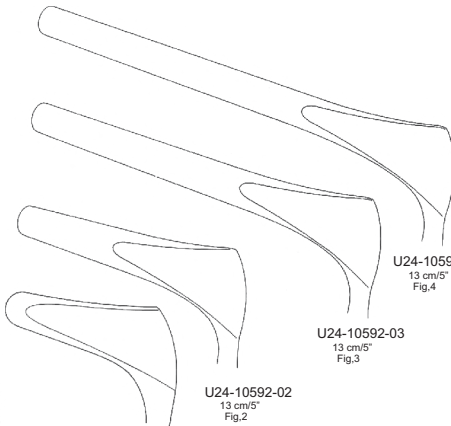

U24-10592-01  
13 cm/5"  
Fig.1

U24-10592-02  
13 cm/5"  
Fig.2

U24-10592-03  
13 cm/5"  
Fig.3

U24-10592-04  
13 cm/5"  
Fig.4



Model-Wien



U24-10593-14  
12.5 cm/5 1/4"  
Fig.4



Cittle

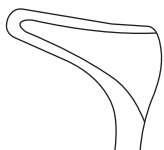

U24-10594-35  
13,5 cm/5 1/4"  
Fig.1  
35 mm

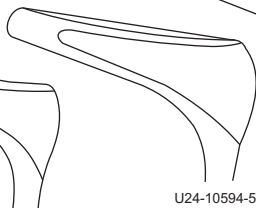

U24-10594-50  
13,5 cm/5 1/4"  
Fig.1  
50 mm

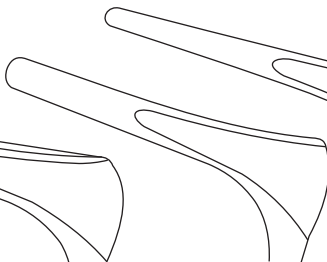

U24-10594-75  
13,5 cm/5 1/4"  
Fig.1  
75 mm

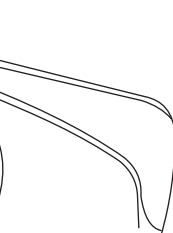

U24-10594-90  
13,5 cm/5 1/4"  
Fig.1  
90 mm



Cittle

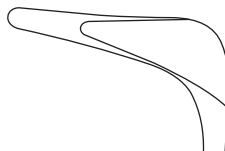

U24-10595-45  
13,5 cm/5 1/4"  
Fig.1  
45 mm



U24-10595-75  
13,5 cm/5 1/4"  
Fig.1  
75 mm

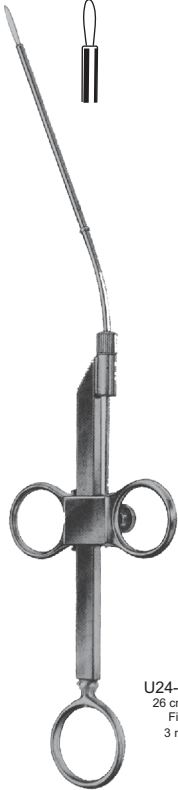

U24-10596-26  
26 cm/10 1/4"  
Fig.1  
3 mm Ø

Krause

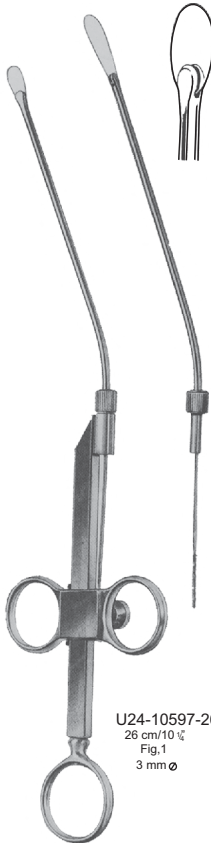

U24-10597-26  
26 cm/10 1/4"  
Fig.1  
3 mm Ø

Krause-Voss



U24-10598-10  
10,5 cm/4 1/4"  
0,3 mm Ø



## Rhinology Instruments

Nasal Tempon Forceps  
Nasal Tempon Zange

Nasale Tempon Forceps  
Pinza nasal Tempon



**Troltsch**  
U24-10599-15  
14,5 cm/5½"



**Troltsch**  
U24-10600-15  
18 cm/7"



**Grunwald (Jansen)**  
U24-10601-20  
21,5 cm/8½"

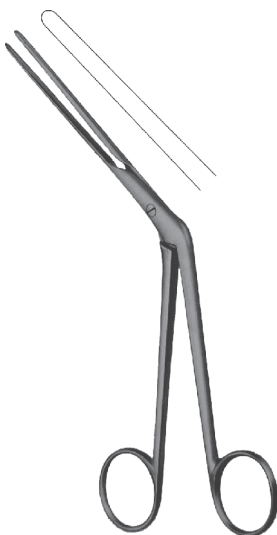

**Lubet-Barbon**  
U24-10602-20  
18,5 cm/7¼"



**Hartmann**  
U24-10603-15  
15 cm/6"

## Rhinology Instruments

Nasal Polypus Forceps, Septum Forceps    Nasale Polypus, forceps septum  
Nasenpolypen Pinzetten, Zangen Septum    Pólipos nasales Pinzas, Pinzas Septum

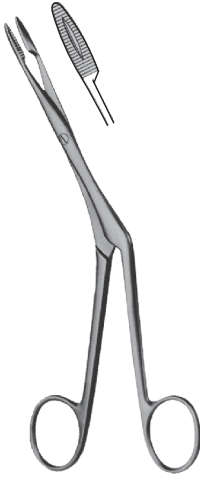

**Hartmann**  
U24-10604-20  
18,5 cm/7 ¼"



**Killian**  
U24-10605-17  
16 cm/6 ¼"



M24-8366-01

M24-8366-02

M24-8366-03



**Heymann**  
U24-10606-18  
18 cm/7"



**Knight**  
U24-10607-18  
17 cm/6 ¾"

## Rhinology Instruments

Septum Forceps, Ethmoid Bone Forceps    Pince septum, pincas à os Ethmoid  
 Septum Forceps, Ethmoid Knochenzange    Pinzas, Pinzas Septum Ethmoid hueso



U24-10608-01  
16 cm/6 1/4"



U24-10608-02  
16 cm/6 1/4"

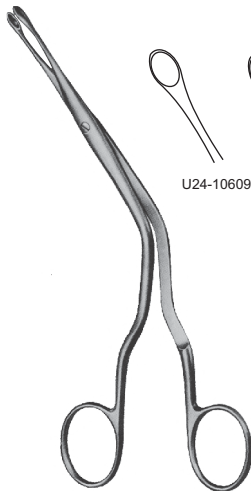

U24-10609-01    U24-10609-02

**Luc**  
U24-10609-20  
20 cm/8"



U24-10610-20  
18.5 cm/7 1/4"  
Fig.1

**Luc**

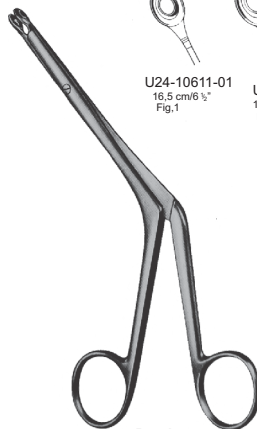

U24-10611-01  
16.5 cm/6 1/2"  
Fig.1



U24-10611-02  
16.5 cm/6 1/2"  
Fig.2



U24-10611-03M24-8371-04  
16.5 cm/6 1/2"  
Fig.3



U24-10611-04  
16.5 cm/6 1/2"  
Fig.4

**Brunings**

## Rhinology Instruments

Ethmoid Bone Forceps  
Ethmoid Knochenzange

Ethmoid daviers  
Ethmoid hueso Pinzas

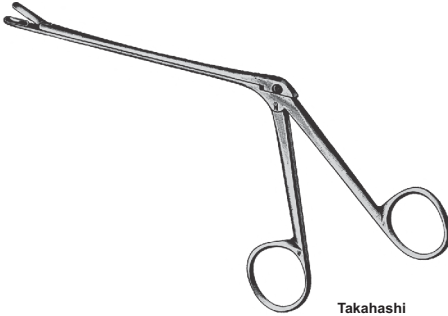

Takahashi

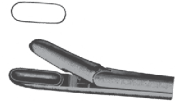

U24-10612-12  
19 cm/7 1/2"  
Straight  
gerade  
droit  
recto



U24-10613-12  
19 cm/7 1/2"  
Bent Upwards  
Bent Upwards  
Bent Vers le haut  
Bent Hacia arriba

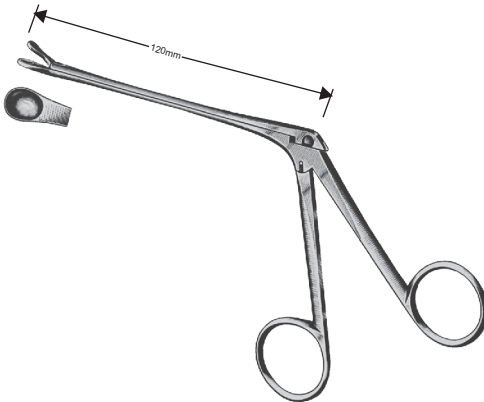

Weil  
U24-10614-12  
12 cm/4 3/4"  
with neck  
mit Hals  
avec col  
con cuello

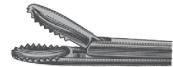

Watson-Williams  
U24-10615-12  
19 cm/7 1/2"



## Rhinology Instruments™

Ethmold Bone Forceps, Nasal Cutting Forceps  
Ethmold Knochenzange, Nasal Cutting Forceps

Daviers Ethmold, les naseaux Forceps coupe  
Ethmold Pinzas de hueso, naseaux Forceps de corte

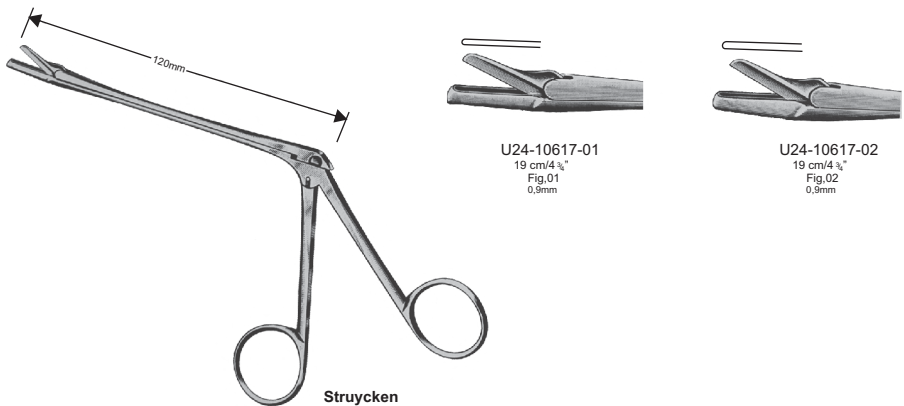
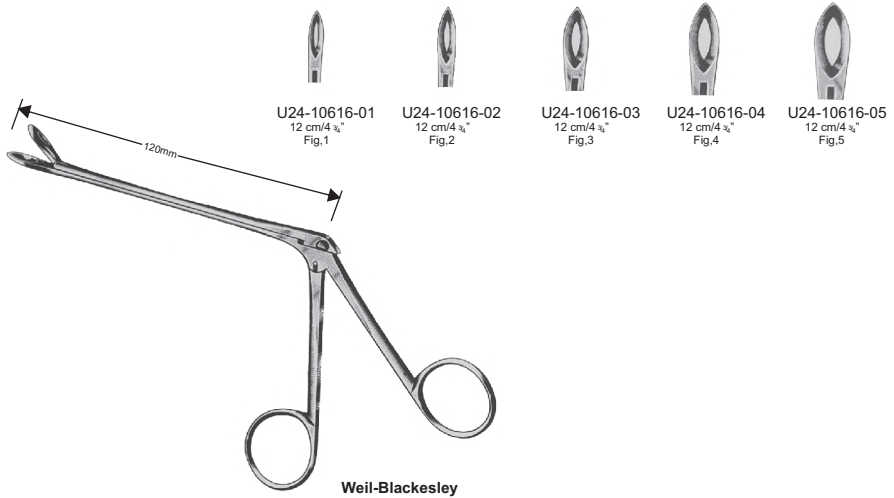

## Rhinology Instruments

Sphenoid Bone Punches  
Keilbein Punches

Poinçons os sphénoïde  
Punzones de hueso esfenoides



**Middleton-Jansen**  
U24-10618-19  
19 cm/7½"

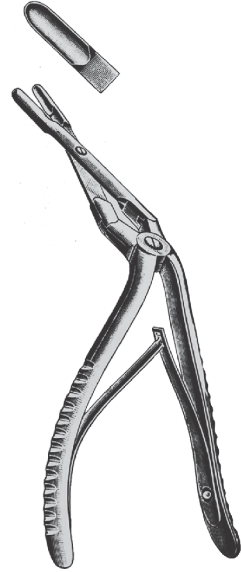

**Middleton-Jansen**  
U24-10619-19  
19 cm/7½"



**Kazanjan**  
U24-10620-18  
18 cm/7"

## Rhinology Instruments

Sphenoid Bone Punches  
Keilbein Punches

Poinçons os sphénoïde  
Punzones de hueso esfenoïdes

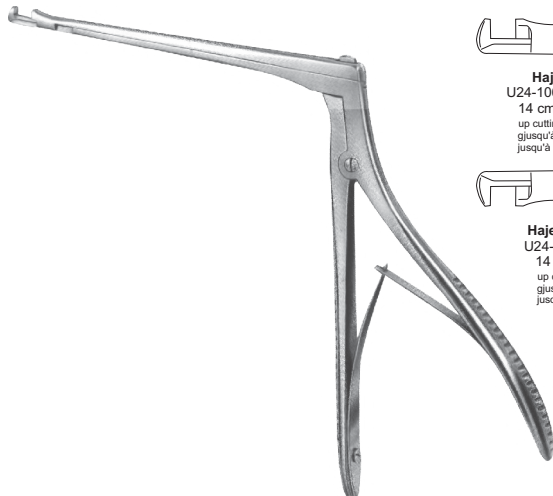

**Hajek**  
U24-10621-13  
14 cm/5 1/2"  
up cuttin  
giusqu'à la coupe  
jusqu'à la coupe...

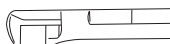

**Hajek-Kofler**  
U24-10623-12  
14 cm/5 1/2"  
up cuttin  
giusqu'à la coupe  
jusqu'à la coupe...



**Hajek**  
U24-10622-18  
14 cm/5 1/2"  
down cutting  
unten schneiden  
à coupe descendante  
tala



**Hajek-Kofler**  
U24-10624-12  
14 cm/5 1/2"  
down cutting  
unten schneiden  
à coupe descendante  
tala



**Ferris-Smith-Kerrison**

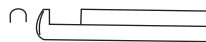

U24-10625-17  
18 cm/7 "  
up cuttin  
giusqu'à la coupe  
jusqu'à la coupe...

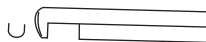

U24-10626-17  
18 cm/7 "  
down cutting  
unten schneiden  
à coupe descendante  
tala





## Rhinology Instruments

Septum Knives, Swivel Knives  
Septum Messer, Messer Swivel

Couteaux, Couteaux septum pivotantes  
Cuchillos Septum, cuchillos giratorios



Freer

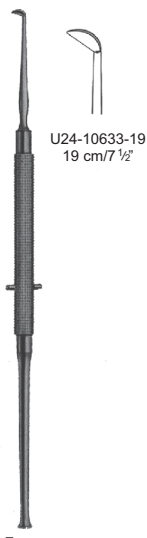

Freer

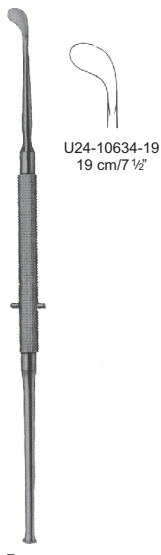

Freer

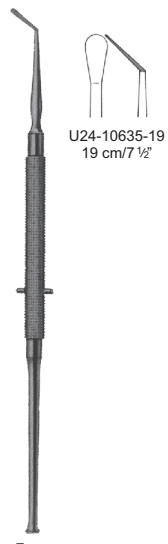

Freer



Ballenger



Ballenger



U24-10636-03 3,0 mm  
21cm/8 1/4"



U24-10636-04 4,0 mm  
21cm/8 1/4"



U24-10636-05 5,0 mm  
21cm/8 1/2"

U24-10637-03  
21cm/8 1/4"

U24-10637-04  
21cm/8 1/4"

U24-10637-05  
21cm/8 1/2"



**Bruenings**  
U24-10638-16  
16 cm/6 1/2"

**24**

## Rhinology Instruments

Septum Elevators  
Septum Aufzüge

Ascenseurs septum  
Elevadores septum



**Mckenty**

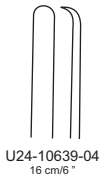

U24-10639-04  
16 cm/6"

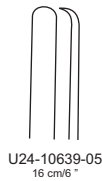

U24-10639-05  
16 cm/6"



**Joseph**



U24-10640-16  
16 cm/6 1/4"



**Cottle**  
24-3401-19  
19.5 cm/7 1/2"



**Freer**



U24-10642-19  
19 cm/7 1/2"  
5mm



**Freer**



U24-10643-19  
19 cm/7 1/2"  
6mm



**Freer**



U24-10644-18  
18.5 cm/7"  
5/5 mm



**Freer**

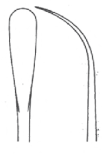

U24-10645-20  
20.5 cm/8"  
6/5 mm



## Rhinology Instruments

Septum Elevators  
Septum Aufzüge

Ascenseurs septum  
Elevadores septum

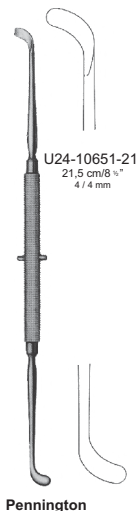
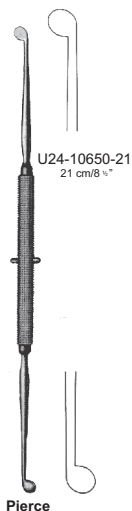
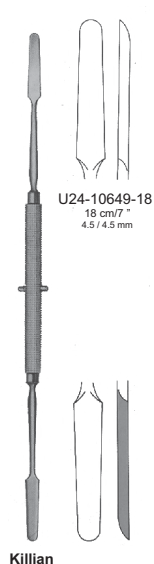
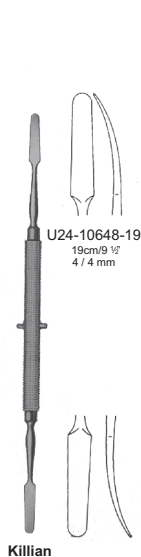
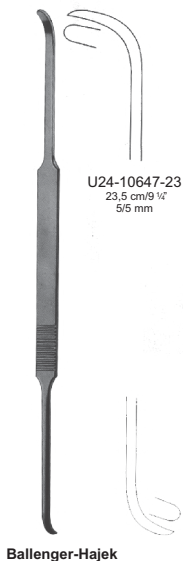

## Rhinology Instruments

Periosteel Elevators & Septum Chisels  
Periosteel Elevators & Septum Meißel

Ascenseurs Periosteel et burins septum  
Elevadores Periosteel y cinceles Septum



U24-10652-22  
19,5 cm/8 1/2"  
4 / 4 mm

Roger



U24-10653-22  
19,5 cm/8 1/2"  
4 mm

Joseph-Masing

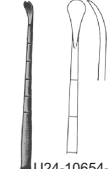

U24-10654-23  
23 cm/9"  
3.3 / 3.7 mm

Cottle

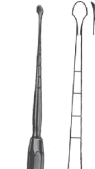

U24-10655-21  
21,5 cm/7 1/2"  
3 / 2 mm

Masing

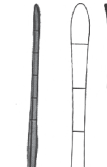

U24-10656-21  
22 cm/7"  
4.5 / 4.5 mm

Cottle



U24-10657-22  
22 cm/7"  
6.5 mm

Joseph



U24-10658-16  
16 cm/6 1/4"  
4 mm

Freer



U24-10659-17  
16,5 cm/6 1/2"  
4 mm

Freer



Freer  
U24-10660-15  
15 cm/6"  
6 mm

## Rhinology Instruments

Septum Knives, Swivel Knives    Couteaux, Couteaux septum pivotantes  
 Septum Messer, Messer Swivel    Cuchillos Septum, cuchillos giratorios

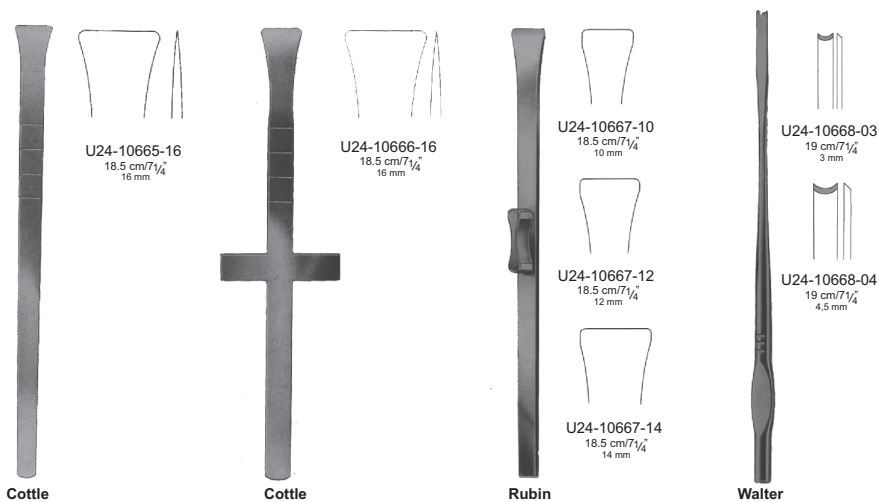
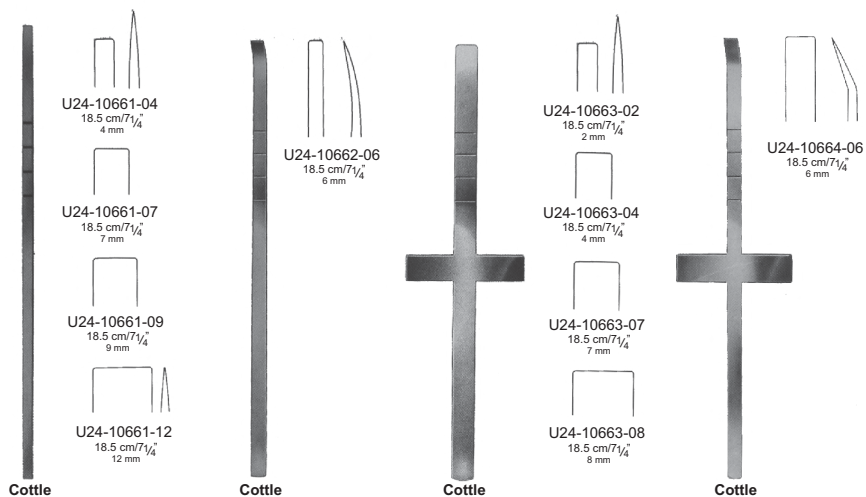

## Rhinology Instruments

Septum Gouges      Gouges septum  
Septum Gouges      Gouges septum



Ballenger



U24-10669-02  
15 cm/6"  
2 mm



U24-10669-04  
15 cm/6"  
4 mm



U24-10669-06  
15 cm/6"  
6 mm



U24-10669-08  
15 cm/6"  
8 mm



Killian

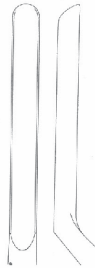

U24-10670-16  
16 cm/6 $\frac{1}{4}$ "  
5 mm

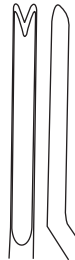

U24-10671-16  
16 cm/6 $\frac{1}{4}$ "  
5 mm



Killian-Claus

## Rhinology Instruments

Osteotomes, Gouges, Chisels  
Osteotome, Hohlmeißel, Flachmeißel

Ostéotomes, gouges, ciseaux  
Osteotomos, gubias, cinceles



**Walter**

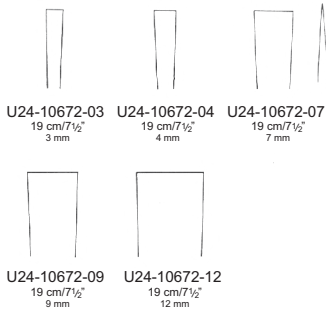

**Fomon**

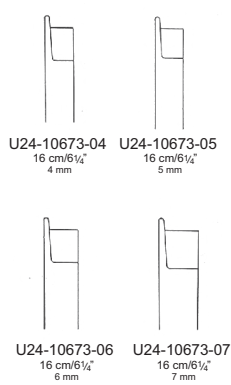

**Cinelli**

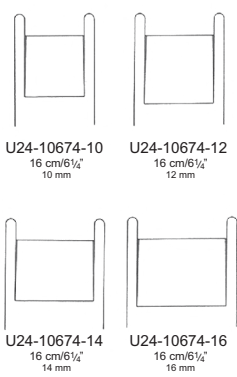

### Rhinology Instruments

Rhinoplastic Chisels, Osteotomes, Nasal Saws  
 Ciseaux rhinoplastie, ostéotomes, scies nasaux  
 Rhinoplastischen Flachmeißel, Osteotome, Nasal Sägen  
 Cinceles Rhinoplastic, los osteotomos, Sierras nasales

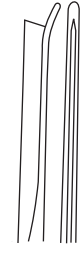

U24-10675-01  
18 cm/7"  
5 mm

Silver

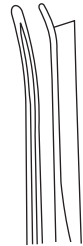

U24-10675-02  
16 cm/7"  
5 mm

Silver

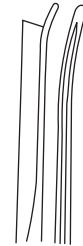

U24-10675-03  
18 cm/7"  
5 mm

Silver



U24-10676-20  
17 cm/6 3/4"  
5 mm

Joseph

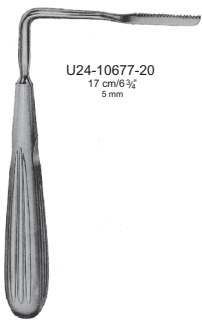

U24-10677-20  
17 cm/6 3/4"  
5 mm



U24-10678-00  
19 cm/7 1/2"

Joseph

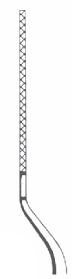

U24-10678-01  
19 cm/7 1/2"

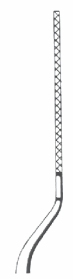

U24-10678-02  
19 cm/7 1/2"



## Rhinology Instruments

Nasal Resps, Bone File Antrum Rasps  
 Nasal RESPS, Bone Datei Antrum Raspeln

Resps nasale, Râpes os de fichiers Antre  
 PRAE nasal, hueso Escofinas antro de archivos

## International

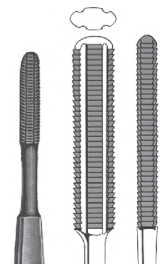

U24-10679-02  
 17.5 cm/7"  
 40 x 9 mm

**Maltz**



U24-10680-01  
 17 cm/6 5/8"  
 45 x 6 mm

**Gallaher**



U24-10680-02  
 17 cm/6 5/8"  
 45 x 6 mm



U24-10680-03  
 17 cm/6 5/8"  
 45 x 6 mm

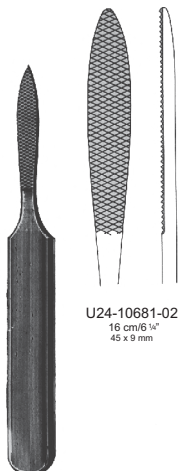

U24-10681-02  
 16 cm/6 1/4"  
 45 x 9 mm

**Joseph**



**Cottle**

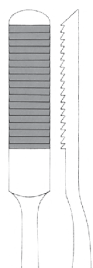

U24-10682-21  
 20.5 cm/8"  
 30 x 6 mm



**Aufrecht**



U24-10683-21  
 21 cm/8 1/4"  
 32 x 9 mm



U24-10684-21  
 21 cm/8 1/4"  
 32 x 9 mm

**24**

## Rhinology Instruments

Glabella & Nasal Rasps      Râpes glabêlle et nasale  
 Glabella Nasal & Raspeln      Glabêla y nasal Escofinas



**Lewis**

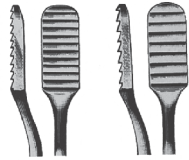

U24-10685-18      U24-10686-18  
 19 cm/7 1/2"      19 cm/7 1/2"  
 15 x 8 mm      15 x 8 mm

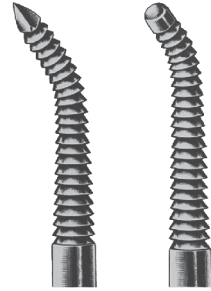

U24-10687-18      U24-10688-18  
 18 cm/7"      18 cm/7"



**Wiener**



**Fomon**



U24-10689-21  
 21 cm/8 1/4"



**Fomon**

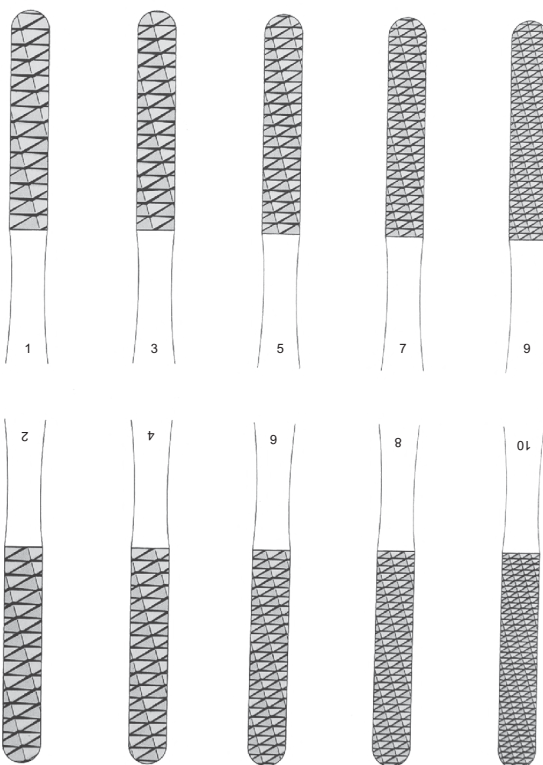

**U24-10690-01**  
20.5 cm/8"  
Fig. 1/2  
30 x 8 mm

**U24-10690-02**  
20.5 cm/8"  
Fig. 3/4  
40 x 7 mm

**U24-10690-03**  
20.5 cm/8"  
Fig. 5/6  
40 x 7 mm

**U24-10690-04**  
20.5 cm/8"  
Fig. 7/8  
40 x 7 mm

**U24-10690-05**  
20.5 cm/8"  
Fig. 9/10  
40 x 7 mm

### Rhinology Instruments

Nasal Hooks, Nasal Retractors, Mucose Hooklets      Nasale Crochets, écarteurs nasaux, petits crochets mucose  
 Nasal Haken, Retraktoren Nasal, Schleimhäute Häkchen      Ganchos nasal, retractores nasales, mucosa ganchillos



**Joseph**  
 U24-10691-15  
 15.5 cm/6"



**Cottle**  
 U24-10692-16  
 17 cm/6¾"



**Cottle**



U24-10693-01  
 14.5 cm/5¾"



U24-10693-02  
 14.5 cm/5¾"



U24-10693-03  
 14.5 cm/5¾"



**Fomon**  
 U24-10694-17  
 17 cm/6¾"



**Lange**  
 U24-10695-23  
 23 cm/9"



**Africht**  
 U24-10696-19  
 19 cm/7½"



**Kilner**  
 U24-10697-08  
 8 cm/3¼"



**Converse**  
 U24-10698-12  
 11.5 cm/4½"

## Rhinology Instruments

Alar Hooklets, Nasal Retractors  
Alar Hakchen, Nasal Retraktoren

Petits crochets Alar, Retracteurs nasaux  
Alar ganchillos, Retractores nasales



**Joseph**



U24-10699-02  
16.5 cm/6½"  
2 mm



U24-10699-05  
16.5 cm/6½"  
5 mm



U24-10699-07  
16.5 cm/6½"  
7 mm



U24-10699-10  
16.5 cm/6½"  
10 mm



**Fomon**



U24-10700-16  
16 cm/6¼"



**Cottle-Neivert**  
U24-10701-20  
19.5 cm/7½"



**Cottle**



U24-10702-14  
14.5 cm/5¾"



U24-10703-01  
14.5 cm/5¾"



U24-10703-02  
14.5 cm/5¾"

## Rhinology Instruments

Alar Hooklets, Nasal Retractors  
Alar Häkchen, Nasal Retraktoren

Petits crochets Alar, Rétracteurs nasaux  
Alar ganchillos, Retractores nasales



**Cottle**  
U24-10704-14  
14 cm/5½"



**Cottle**  
U24-10705-16  
17 cm/6¾"



**Cottle**  
U24-10706-15  
14 cm/6½"



**Cottle**  
U24-10707-15  
16 cm/6¼"



**Aufricht**  
U24-10708-14  
12 cm/4¾"

## Rhinology Instruments

Septum Forceps, Septum Straightening Forceps  
Septum Pinzetten, Zangen Septum Aufrichtung

Pince septum, Forceps à dresser septum  
Pinzas, Pinzas Septum Septum Alisar



**Cottle-Walsham**



**U24-10709-01**  
23 cm/9"



**U24-10709-02**  
23 cm/9"



**U24-10709-03**  
23 cm/9"



**Asch**



**U24-10710-23**  
22.5 cm/8 1/4"



**Kressner**  
U24-10711-20  
21 cm/8 1/4"



**Rubin**  
U24-10712-20  
20 cm/8"

## Rhinology Instruments

Skin Grasping Forceps Pince à préhension de la peau  
Haut Faßzange Pinzas de agarre de la piel



**Ogura**  
U24-10713-11  
11 cm/4 1/4"



**Cottle**

U24-10714-14  
14 cm/5 1/2"  
1.7 mm  
wide with teeth  
breit mit Zähnen  
largeur des dents  
de ancho con dientes



**Cottle**

U24-10715-11  
11 cm/4 1/4"  
12 mm wide  
wide  
breite  
large  
ancho



## Rhinology Instruments

Adenoid Curettes  
adenoid KÜretten

adenoide Curettes  
adenoides Curetas



**Coakly**  
17 cm / 6 3/4"



U24-10716-01



U24-10716-02



U24-10716-03



U24-10716-04



U24-10716-05



U24-10716-06



**Beckmann**

U24-10717-01 - U24-10717-06



**Beckmann**

U24-10718-01 - U24-10718-06



U24-10717-01  
22.5 cm / 8 3/4"  
Fig. 1  
13 mm



U24-10717-02  
22.5 cm / 8 3/4"  
Fig. 2  
15 mm



U24-10717-03  
22.5 cm / 8 3/4"  
Fig. 3  
17 mm

U24-10718-01  
22 cm / 8 3/4"  
Fig. 1  
13 mm

U24-10718-02  
22cm / 8 3/4"  
Fig. 2  
15 mm

U24-10718-03  
22 cm / 8 3/4"  
Fig. 3  
17 mm



U24-10717-04  
22.5 cm / 8 3/4"  
Fig. 1  
19 mm



U24-10717-05  
22.5 cm / 8 3/4"  
Fig. 2  
21 mm



U24-10717-06  
22.5 cm / 8 3/4"  
Fig. 3  
23 mm

U24-10718-04  
22 cm / 8 3/4"  
Fig. 1  
19 mm

U24-10718-05  
22cm / 8 3/4"  
Fig. 2  
21 mm

U24-10718-06  
22 cm / 8 3/4"  
Fig. 3  
23 mm

## Rhinology Instruments

Suction Rasparatory    Rasparatory aspiration  
Saug Rasparatory    succión Rasparatory



**Guilen**

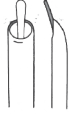

U24-10719-20  
19 cm / 7 1/2"



**Elcken - Killian**  
U24-10720-03  
3 mmø



**Ritter - Halle**  
U24-10721-25 2.5 mm  
U24-10721-30 3.0 mm  
U24-10721-40 4.0 mm