

## Cardiovascular Instruments

Rib Shears  
Rib Shears

Costotome  
Tijeras de costilla



**U13-9254-23**  
23 cm/9"  
Bone Shears



**U13-9255-23**  
23 cm/9"  
Bone Shears



**Glick**  
U13-9256-23  
23 cm/9"  
Drawing Cut

## Cardiovascular Instruments

Rib Shears, Sternum Chisels Costotome, ciseaux Sternum  
 Rib, Sternumscheren Meißel Tijeras de costillas, esternón cinceles



**Sauerbruch**  
 U13-9257-24 24 cm/9½"  
 U13-9257-26 26 cm/10¼"



**Giertz-Stille**  
 U13-9258-27  
 27 cm/10½"



**Sauerbruch-Frey**  
 U13-9259-36  
 36 cm/14"



**Brunner**  
 32 cm/12½"

U13-9260-32  
 For the Right Hand  
 Für die rechte Hand  
 Pour la main droite  
 Para la mano derecha

U13-9261-32  
 For the left Hand  
 Für die linke Hand  
 Pour la main gauche  
 Para la mano izquierda



**Lebsche**  
 U13-9262-24  
 24.5 cm/9¾"

### Cardiovascular Instruments

Rib Spreaders    Épandeurs Rib  
Wundsperrerr    Separadores de costilla

Scheme of Dimensions  
Schema der Dimensionen  
Schéma des dimensions  
Esquema de Medidas

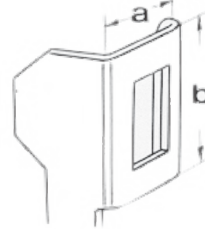

Size of Blades  
Größe der Blätter  
Taille des lames  
Tamaño de Espadas



Finocchietto-Baby

	a	b	c
U13-9263-00	18 mm	20 mm	75 mm

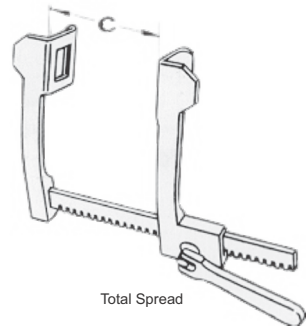

Total Spread



Finocchietto

	a	b	c
U13-9264-01	38 mm	45 mm	165 mm
U13-9264-02	44 mm	65 mm	200 mm
U13-9264-03	44 mm	65 mm	250 mm
U13-9264-04	44 mm	65 mm	300 mm
U13-9264-05	65 mm	65 mm	200 mm
U13-9264-06	65 mm	65 mm	250 mm
U13-9264-07	65 mm	65 mm	300 mm



## Cardiovascular Instruments

Rib Spreaders  
Wundsperrer

Épandeurs Rib  
Separadores de costilla

13

With 2 Pairs of Interchangeable Blades  
Mit 2 Paar Wechselklingen  
Avec 2 paires de lames interchangeables  
Con 2 pares de cuchillas intercambiables

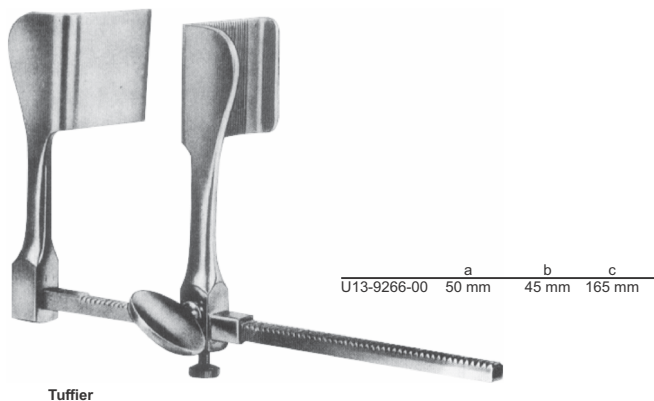
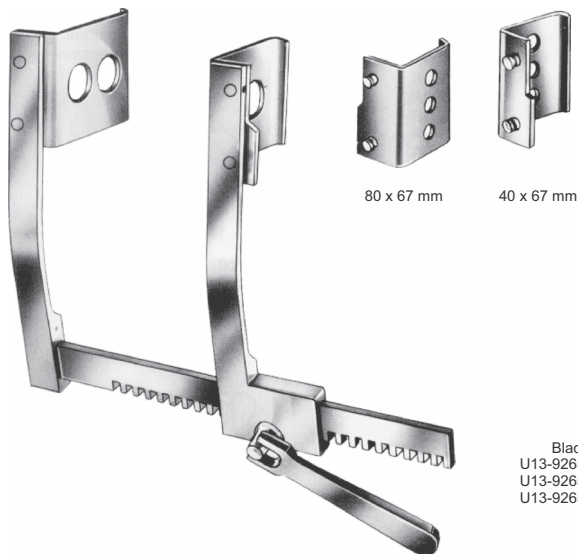



## 13

### Cardiovascular Instruments

Rib Spreaders      Épandeurs Rib  
Wundsperrer      Separadores de costilla



Cooley  
(Cooley-Baby)

	a	b	c
U13-9267-01	12 mm	17 mm	75 mm
U13-9267-02	16 mm	30 mm	105 mm
U13-9267-03	37 mm	49 mm	200 mm



Castaneda

	a	b	c
U13-9268-01	10.5 mm	32 mm	65 mm
U13-9268-02	12 mm	45 mm	70 mm
U13-9268-03	15 mm	60 mm	120 mm



Finocchietto-Baby-Haight

	a	b	c
U13-9269-01	15 mm	15 mm	75 mm
U13-9269-02	31 mm	31 mm	100 mm



**Haight**

	a	b	c
U13-9270-01	30 mm	30 mm	65 mm
U13-9270-02	30 mm	30 mm	90 mm

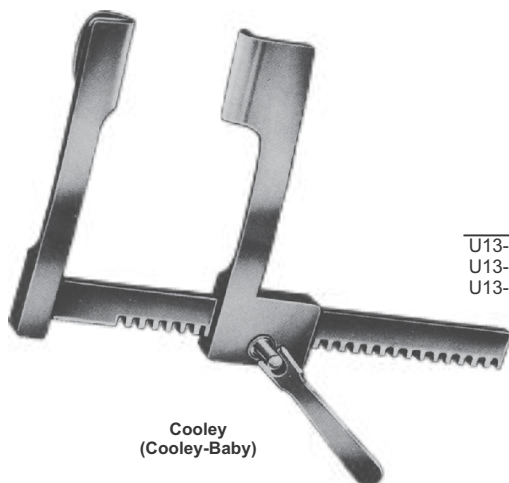

**Cooley  
(Cooley-Baby)**

	a	b	c
U13-9271-01	15 mm	30 mm	75 mm
U13-9271-02	21 mm	45 mm	145 mm
U13-9271-03	32 mm	50 mm	190 mm

### Cardiovascular Instruments

Rib Spreaders      Épandeurs Rib  
Wundsperrerr      Separadores de costilla

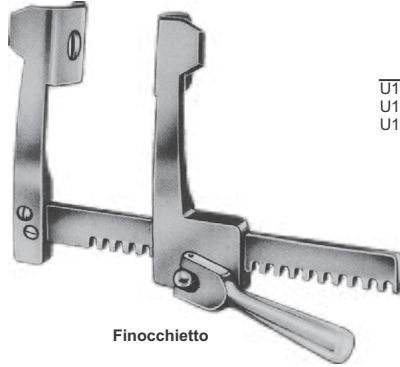

**Finocchetto**

	a	b	c
U13-9272-01	38 mm	44 mm	135 mm
U13-9272-02	52 mm	62 mm	175 mm
U13-9272-03	85 mm	65 mm	175 mm

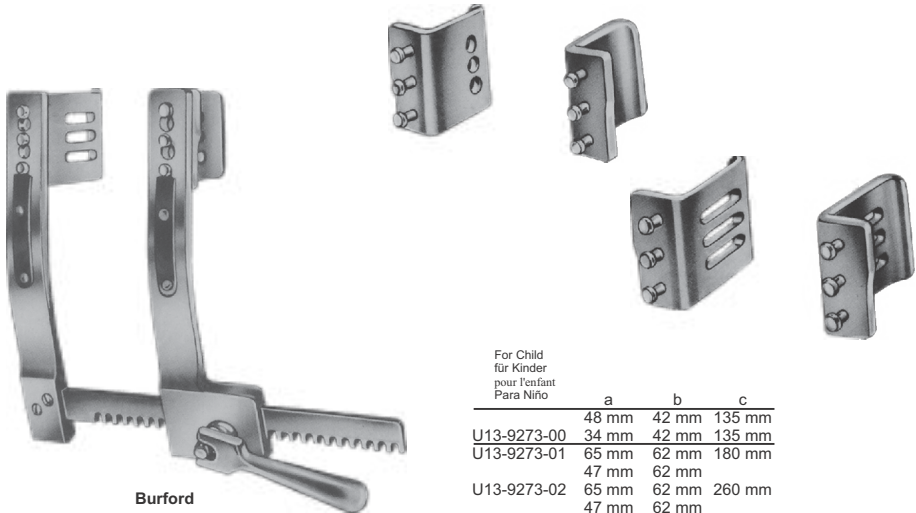

**Burford**

With 2 Pairs of Blades  
Mit 2 Paar Blades  
Avec 2 paires de lames  
Con 2 pares de hojas

For Child  
für Kinder  
pour l'enfant  
Para Niño

	a	b	c
U13-9273-00	48 mm	42 mm	135 mm
U13-9273-01	34 mm	42 mm	135 mm
U13-9273-02	65 mm	62 mm	180 mm
U13-9273-03	47 mm	62 mm	260 mm
U13-9273-04	65 mm	62 mm	300 mm
U13-9273-05	47 mm	62 mm	

With 2 pairs of interchangeable blades  
Mit 2 Paar auswechselbaren Klingen  
Avec 2 paires de lames interchangeables  
Con 2 pares de hojas intercambiables

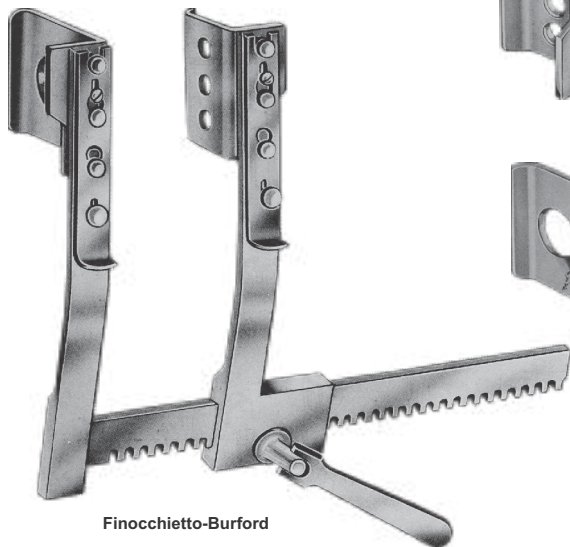

**Finocchietto-Burford**



Blades  
U13-9274-31  
80x67 mm

Blades  
U13-9273-30  
40x67 mm

**Total Spread**

U13-9275-01	200mm/8"
U13-9275-02	250mm/10"
U13-9275-03	305mm/12"



**Tuffier**

	a	b	c
U13-9276-00	50 mm	45mm	165mm

### Cardiovascular Instruments

Rib Spreaders    Épandeurs Rib  
Wundsperrer    Separadores de costilla

◀ 200 mm ▶

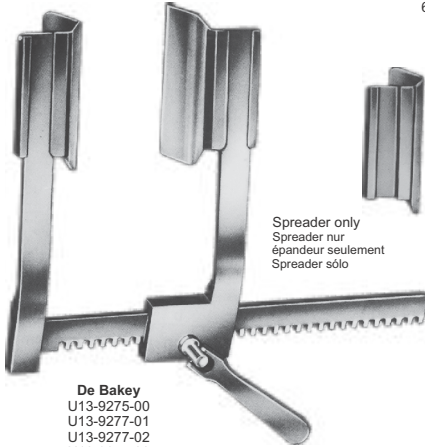

**De Bakey**  
U13-9275-00  
U13-9277-01  
U13-9277-02  
U13-9277-03  
With 5 Pairs of Blades  
Mit 5 Paar Blades  
Avec 5 paires de lames  
Con 5 pares de cuchillas



U13-9277-01  
60 x 60 mm

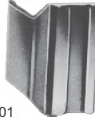

U13-9277-02  
50 x 80 mm



U13-9277-03  
40 x 100 mm

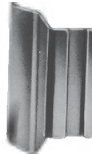

U13-9277-04  
80 x 60 mm



U13-9277-05  
50 x 66 mm



◀ 150 mm ▶



**De Bakey**  
M13-7168-00  
With 3 Pairs of Blades  
Mit 3 Paar Blades  
Avec 3 paires de lames  
Con 3 pares de cuchillas



U13-9278-01  
30 x 30 mm



U13-9278-02  
40 x 40 mm

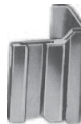

U13-9278-03  
50 x 50 mm



◀ Fig. 1 15 cm/6" ▶  
◀ Fig. 2 20 cm/8" ▶



**Morse-Favaloro**  
Fig. 1 U13-9279-01  
Fig. 2 U13-9279-02

75 x 75 mm

Thoracic Retractor



42 x 65 mm



**(Mercedes-Retractor)**  
U13-9280-00

Complete  
vervollständigen  
completar  
completar

13

## Cardiovascular Instruments

Rib Contractors and Lung Spatulas  
Rib Contractors und Lungenforschung Spatel

Entrepreneurs des côtes et du poumon Spatules  
Contratistas de costilla y espátulas de pulmón



**Sellers**  
U13-9281-19  
19 cm/7½"



**Bailey-Baby**  
U13-9282-14  
14 cm/5½"



**Bailey**  
U13-9283-16  
16 cm/6¼"



**Bailey-Gibbon**  
U13-9284-16  
16 cm/6¼"



**Allison**  
U13-9285-25 25.5 cm/10"  
U13-9285-30 30.0 cm/12"

Lung Spatulas  
Lung Spatel  
Spatules pulmonaires  
Espátulas de pulmón

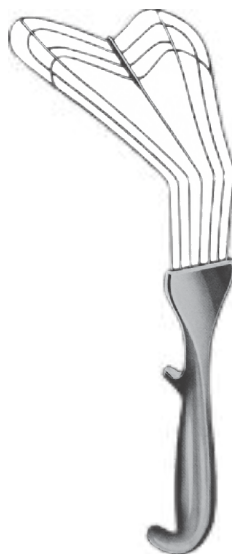

U13-9286-30  
30 cm/12"



**13**

## Cardiovascular Instruments

Bronchus Clamps and Blood Vessel Clamps Pincers des bronches et des colliers Vasculopathies  
 Bronchus Schellen und Blutgefäßen Schellen Abrazaderas Abrazaderas de los bronquios y los vasos sanguíneos

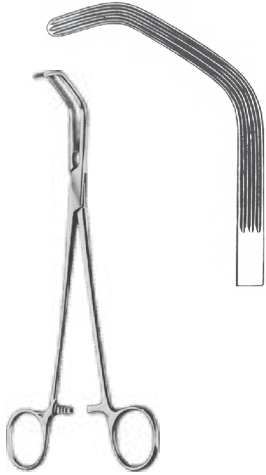

**Price-Thomas**  
 U13-9287-22  
 22 cm/8¾"

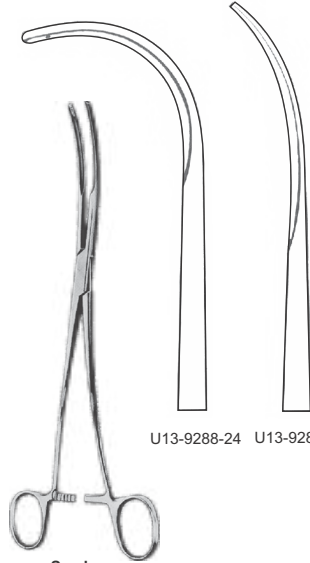

U13-9288-24 U13-9289-24

**Semb**  
 24 cm/9½"

Lung grasping forceps



**Lovlace**  
 U13-9290-20  
 20 cm/8"



**Lovlace**  
 U13-9291-20  
 20 cm/8"

## Cardiovascular Instruments

Blood Vessel Clamps  
Blutgefäß Schellen

Pinces Vasculopathies

Las abrazaderas de los vasos sanguíneos



U13-9292-01  
U13-9292-02

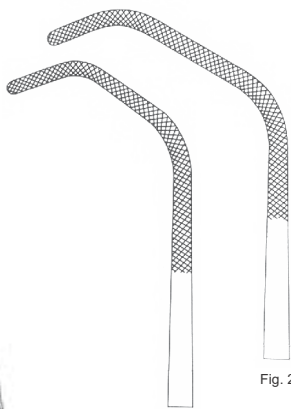

Fig. 2

Fig. 1

**Satinsky**  
26.5 cm/10½"  
Fig. 1  
Fig. 2



U13-9293-01  
U13-9293-02



**Baby-Satinsky**  
U13-9294-15  
15 cm/6"



**Harken**  
24 cm/9½"



U13-9295-01

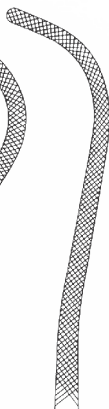

U13-9295-02



U13-9295-03



U13-9295-04

13

## Cardiovascular Instruments

Atrauma Bulldog Clamps  
Atrauma Bulldogklemmen

Atraumatique Pincés Bulldog  
Atrauma Bulldog Clamps



**De Bakey-Satinsky**  
U13-9296-07  
7 cm/2¾"



**De Bakey-Satinsky**  
U13-9297-09  
9 cm/3½"

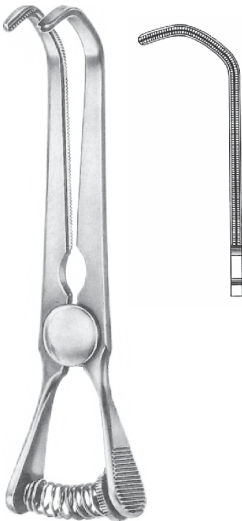

**De Bakey-Satinsky**  
U13-9298-10  
10 cm/4"



**Glover**  
U13-9299-06  
6 cm/2 ¼"

## Cardiovascular Instruments

Atrauma Bulldog Clamps  
Atrauma Bulldogklemmen

Atraumatique Pincés Bulldog  
Atrauma Bulldog Clamps



**Santulli**  
U13-9300-07  
7 cm/2¾"

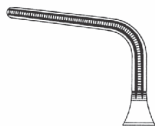

**Gregory-Soft**



U13-9301-09  
9 cm/3½"

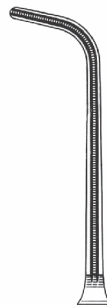

U13-9301-11  
11 cm/4½"



**Gregory**



U13-9302-09  
10.5 cm/4"



U13-9302-10  
10.5 cm/4"

13

## Cardiovascular Instruments

Bulldog Clamps      Pincas Bulldog  
 Bulldogklemmen      Bulldog Clamps



Glover

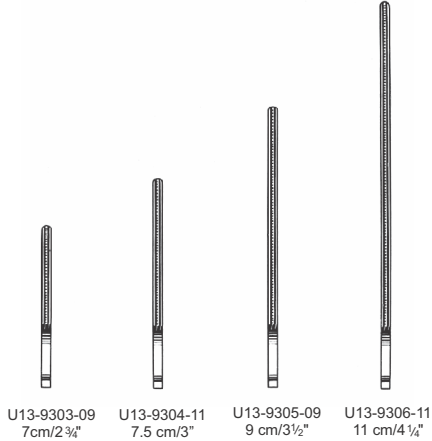

Glover

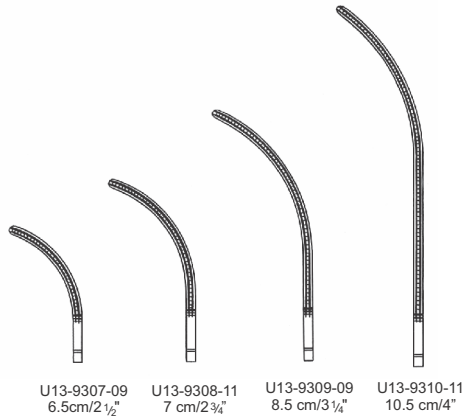



**DeBakey**



U13-9311-07  
7.5 cm/3"



U13-9311-08  
8.5 cm/3 1/4"

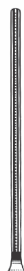

U13-9311-10  
10 cm/4"



U13-9311-12  
12 cm/4 3/4"

Applying Forceps  
for Bulldog clamps

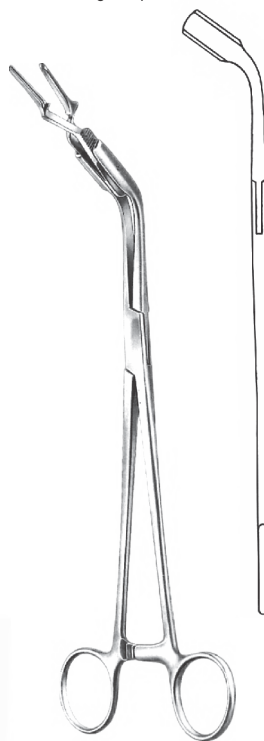

U13-9313-23  
23.5 cm/9 1/4"



**DeBakey**



U13-9312-07  
7.5 cm/3"



U13-9312-08  
8.5 cm/3 1/4"



U13-9312-09  
9.5 cm/4 3/4"



U13-9312-12  
11 cm/4 1/4"

## Cardiovascular Instruments

Haemostatic Forceps and Aortic Clamps    Forceps Hémostatique et clamps aortiques  
Arterienklemme und Aorten-Schellen    Pinzas hemostáticas y Abrazaderas aórticas



DeBakey-Rankin

U13-9314-01  
16 cm/6 1/4"

U13-9314-02  
16 cm/6 1/4"



DeBakey-Mosquito

U13-9315-01  
15 cm/6"

U13-9315-02  
16 cm/6"



Ochsner

U13-9316-23  
23.5 cm/9 1/4"



Diethrich

U13-9317-22  
22cm/6 3/4"



## Cardiovascular Instruments

Multi Purpose vascular Clamps  
Multi Purpose Gefäßklemmen

Pinces Multi Purpose vasculaires  
Pinzas Multiuso vasculares

13



U13-9318-00

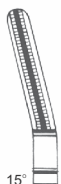

15°  
U13-9318-15

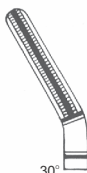

30°  
U13-9318-30

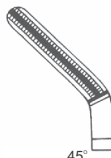

45°  
U13-9318-45

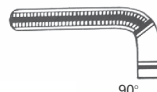

90°  
U13-9318-90



U13-9319-00

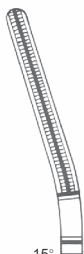

15°  
U13-9319-15

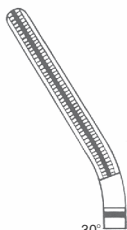

30°  
U13-9319-30

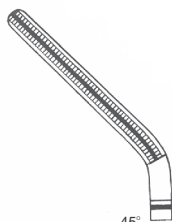

45°  
U13-9319-45

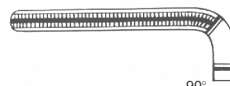

90°  
U13-9319-90



**Dardik**  
17 cm/6¾"



13

## Cardiovascular Instruments

Peripheral Vascular Clamps  
Peripheral Vascular Clamps

Clamps vasculaires périphériques  
Pinzas vasculares periféricas

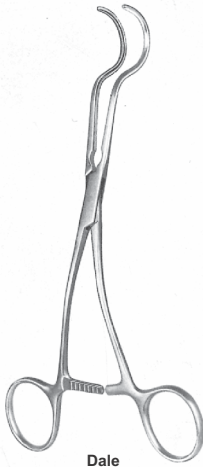

U13-9320-17  
17.5 cm/6 3/4"



U13-9320-18  
18 cm/7"

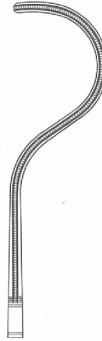

U13-9320-19  
18.5 cm/7 1/4"

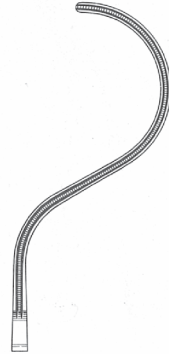

U13-9321-18  
18 cm/7"





**Gregory**

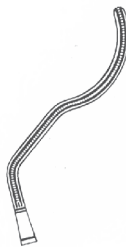

U13-9322-14  
13 cm/5"

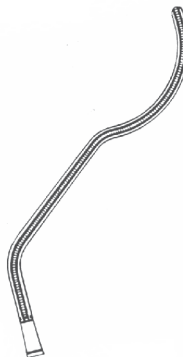

U13-9322-16  
16 cm/6 1/4"

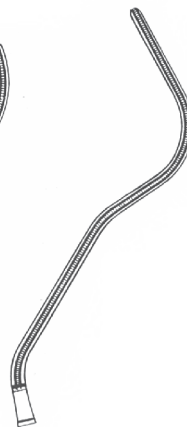

U13-9322-18  
18 cm/7"



**Javid**



U13-9323-17  
17.5 cm/7"

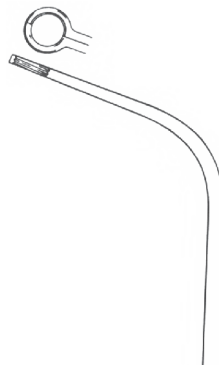

U13-9323-18  
18 cm/7"

13

## Cardiovascular Instruments

Catheter Clamps      Pincas cathéter  
Katheter-Klemmen      Abrazaderas catéter



U13-9324-01  
16 cm/6 1/4"  
24 Charr

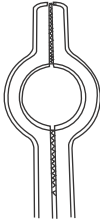

U13-9324-02  
16 cm/6 1/4"  
26 Charr

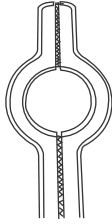

U13-9324-03  
20 cm/8"  
28 Charr

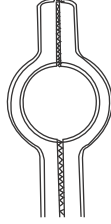

U13-9324-04  
20 cm/8"  
30 Charr



U13-9324-05  
20 cm/8"  
32 Charr

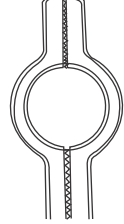

U13-9324-07  
20 cm/8"  
36 Charr

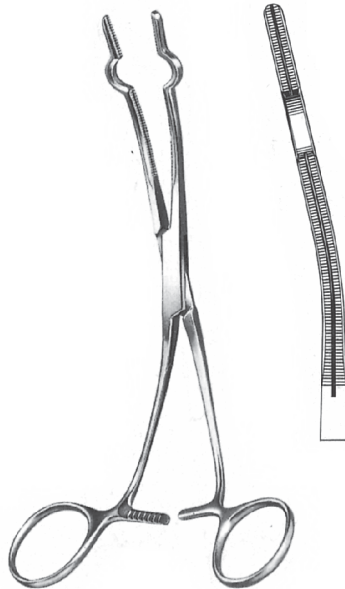

Cooley

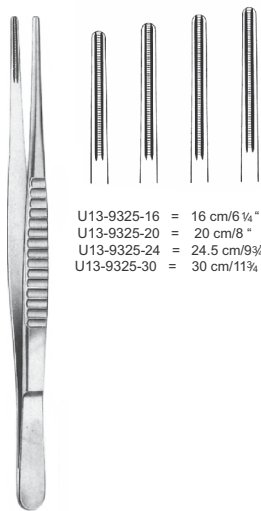

U13-9325-16 = 16 cm/6 1/4 "  
U13-9325-20 = 20 cm/8 "  
U13-9325-24 = 24.5 cm/9 3/4 "  
U13-9325-30 = 30 cm/11 3/4 "

**DeBailey**  
2.7mm

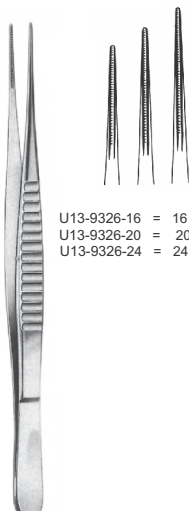

U13-9326-16 = 16 cm/6 1/4 "  
U13-9326-20 = 20 cm/8 "  
U13-9326-24 = 24.5 cm/9 3/4 "

**DeBailey**  
1.5mm

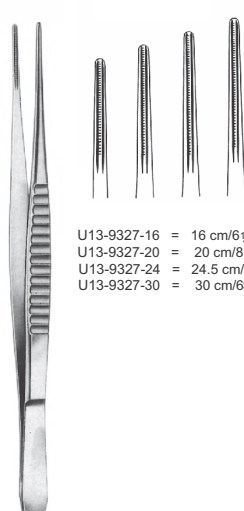

U13-9327-16 = 16 cm/6 1/4 "  
U13-9327-20 = 20 cm/8 "  
U13-9327-24 = 24.5 cm/9 3/4 "  
U13-9327-30 = 30 cm/6 3/4 "

**DeBailey**  
2.5mm

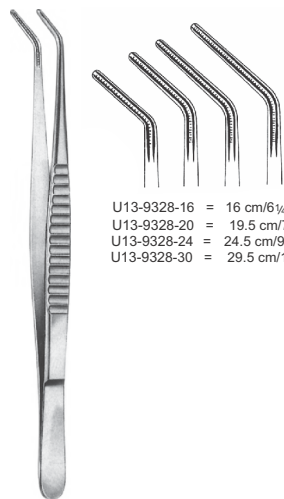

U13-9328-16 = 16 cm/6 1/4 "  
U13-9328-20 = 19.5 cm/7 3/4 "  
U13-9328-24 = 24.5 cm/9 "  
U13-9328-30 = 29.5 cm/11 1/4 "

**DeBailey**  
2.0mm

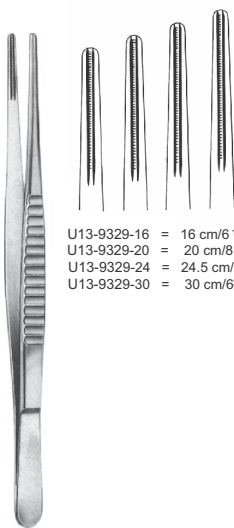

U13-9329-16 = 16 cm/6 1/4 "  
U13-9329-20 = 20 cm/8 "  
U13-9329-24 = 24.5 cm/9 3/4 "  
U13-9329-30 = 30 cm/6 3/4 "

**DeBailey**  
3.5mm



U13-9330-16 = 16 cm/6 1/4 "  
U13-9330-20 = 20 cm/8 "

**DeBailey**  
2.0mm

## Cardiovascular Instruments

Peripheral Vascular Clamps  
Peripheral Vascular Clamps

Clamps vasculaires périphériques  
Pinzas vasculares periféricas

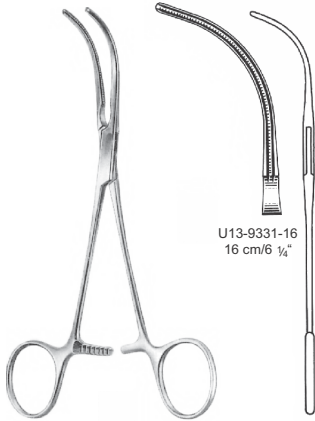

DeBakey

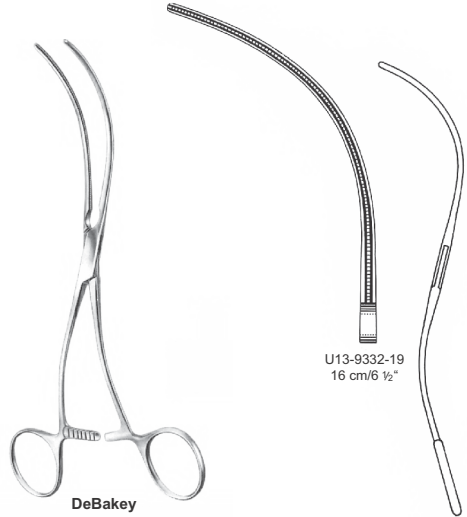

DeBakey

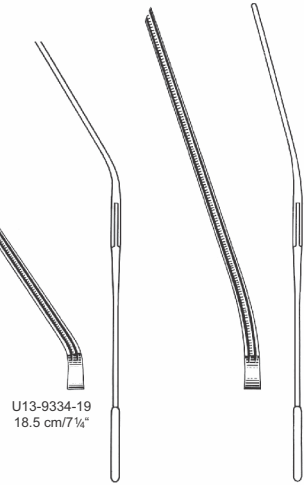
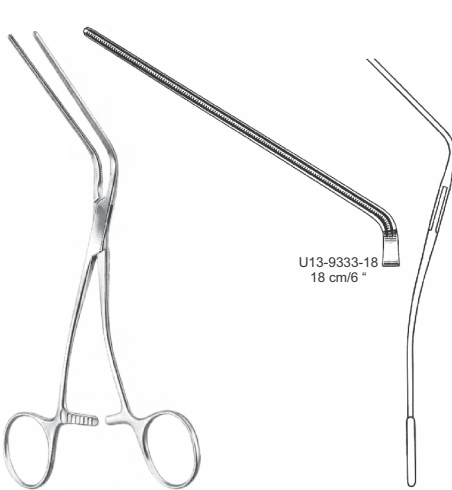

## Cardiovascular Instruments

Multi Purpose vascular Clamps  
Multi Purpose Gefäßklemmen

Pinces Multi Purpose vasculaires  
Pinzas Multiuso vasculares



**Bainbridge**



U13-9335-15  
15 cm/6"



U13-9336-18  
18.5 cm/7 1/4"



**Bainbridge**



U13-9337-15  
15 cm/6"



U13-9338-18  
18.5 cm/7 1/4"



**DeBaKey**

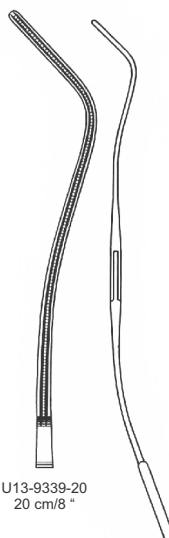

U13-9339-20  
20 cm/8"

13

## Cardiovascular Instruments

Aortic Aneurysm Clamps  
Aortenaneurysma Schellen

Pinces anévrisme aortique  
Las abrazaderas de aneurismas aórticas

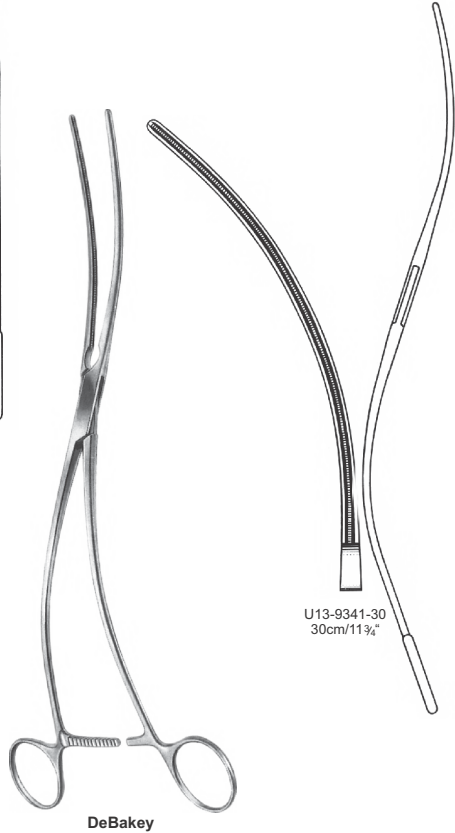
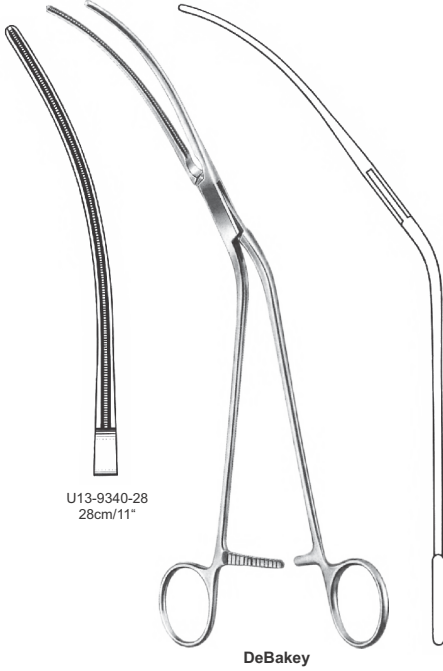



## Cardiovascular Instruments

Aortic Aneurysm Clamps  
Aortenaneurysma Schellen

Pinces anévrisme aortique  
Las abrazaderas de aneurismas aórticas

13



DeBakey



U13-9342-26  
26cm/10 1/4"

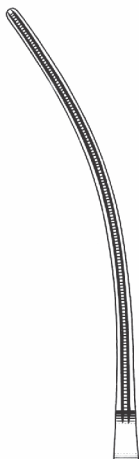

U13-9342-27  
26cm/10 3/4"

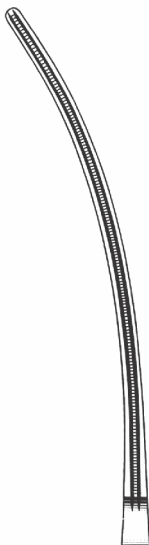

U13-9342-31  
31cm/12 1/4"



U13-9342-33  
33cm/13"





13

## Cardiovascular Instruments

Aortic Clamps, Ligature Forceps  
Aorten-Klemmen, Ligaturklemmen

Clamps aortiques, pincés de ligature  
Abrazaderas aórticas, pinzas de ligadura

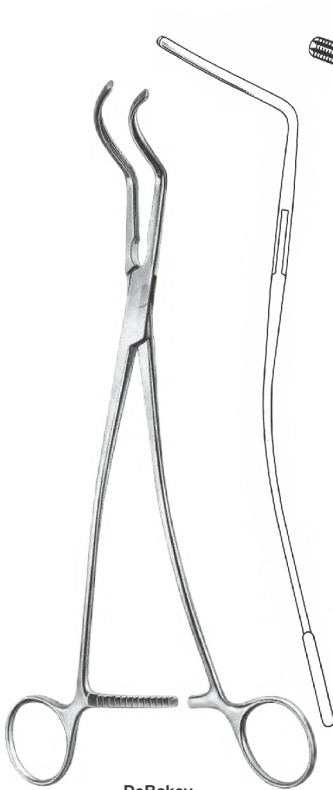

**DeBakey**  
U13-9343-27  
27cm/10 3/4"

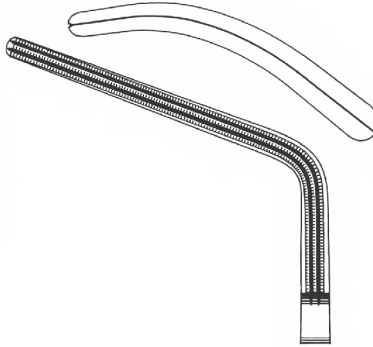

**DeBakey**  
U13-9344-24  
24.5cm/9 3/4"

## Cardiovascular Instruments

Aortic Clamps, Ligature Forceps  
Aorten-Klemmen, Ligaturklemmen

Clamps aórticas, pinces de ligature  
Abrazaderas aórticas, pinzas de ligadura



13

## Cardiovascular Instruments

Aortic Clamps, Ligature Forceps  
Aorten-Klemmen, Ligaturklemmen

Clamps aortiques, pincas de ligature  
Abrazaderas aórticas, pinzas de ligadura

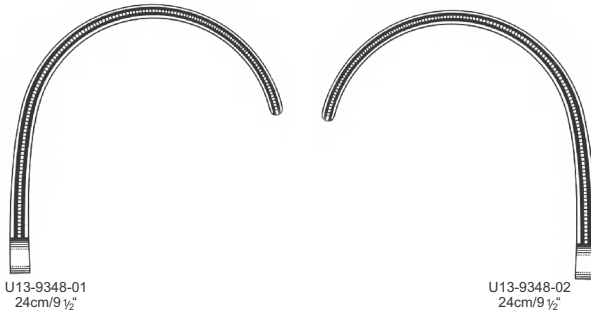



## Cardiovascular Instruments

Auricle Clamps  
Ohrmuschel Schellen

Pinces oreillette  
Abrazaderas auricula

13



Harken

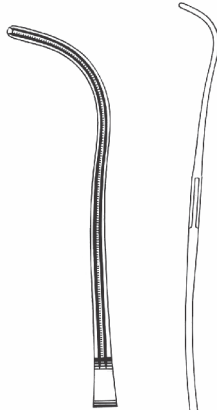

U13-9349-01  
24.5cm/9 3/4"

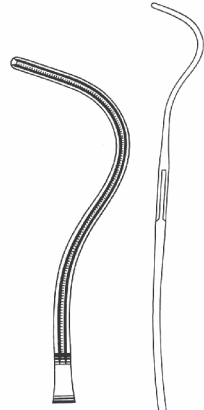

U13-9349-02  
24.5cm/9 1/2"

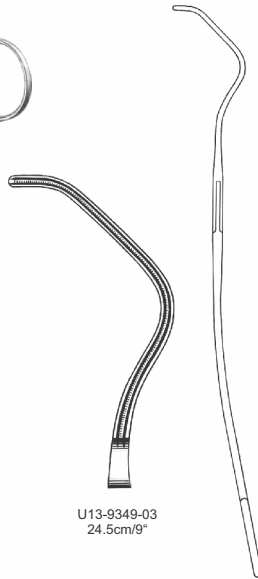

U13-9349-03  
24.5cm/9"

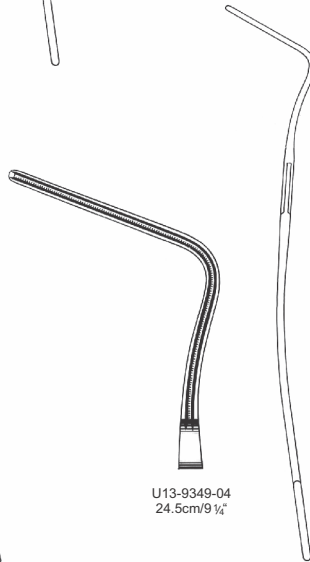

U13-9349-04  
24.5cm/9 1/4"

13

## Cardiovascular Instruments

Tangential Occlusion Clamps  
Tangentielle Occlusion Schellen

Pincés d'occlusion tangentielles  
Abrazaderas tangenciales de oclusión

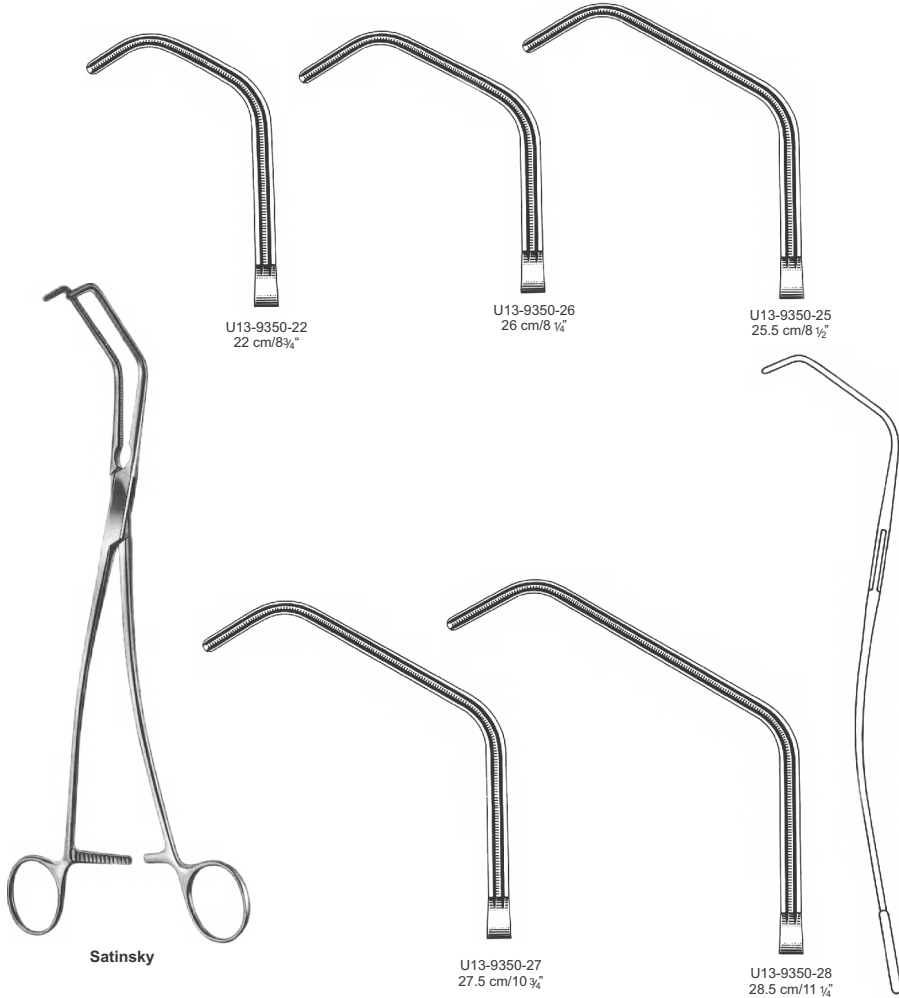



Lees

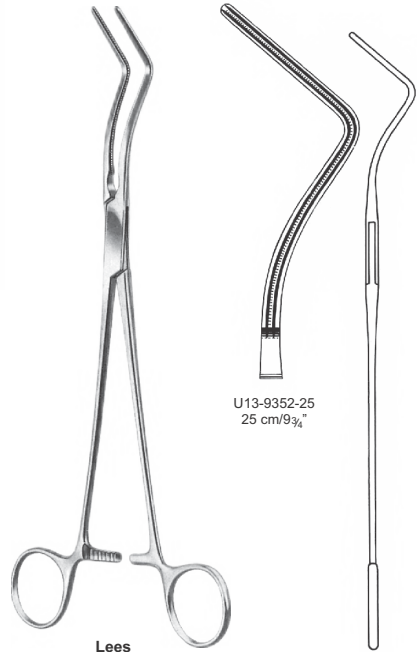

Lees

13

## Cardiovascular Instruments

Aortic Clamps      clamps aortiques  
Aorten-Schellen      Abrazaderas aórticas



U13-9353-16  
16.5 cm/6 1/2"

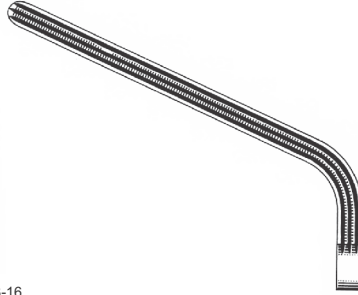

U13-9353-20  
20 cm/8"



Morris-DeBakey

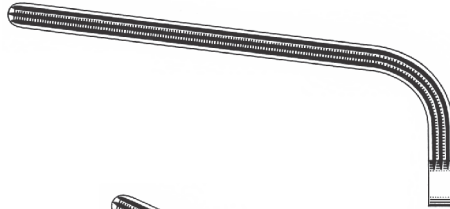

U13-9353-24  
24 cm/9 1/2"

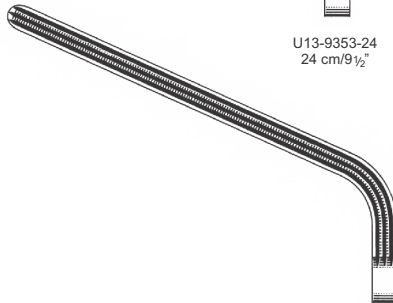

U13-9353-26  
26 cm/10 1/4"

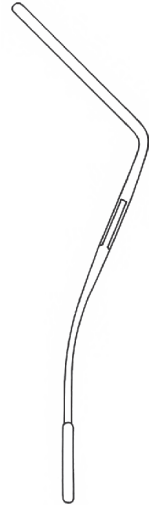



**Morris-DeBakey**



U13-9354-22  
22.5 cm/8 ¾"



U13-9354-22  
22.5 cm/8 ¾"

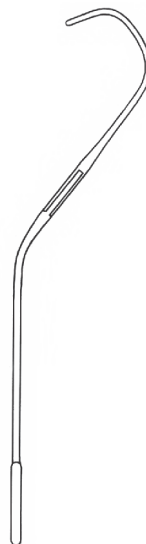

**DeBakey**

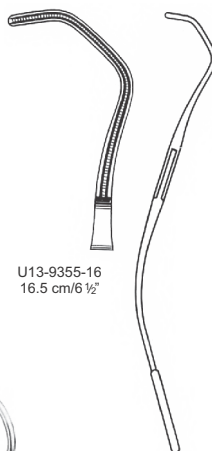

U13-9355-16  
16.5 cm/6 ½"



## Cardiovascular Instruments

Aneurysm Clamps  
Aneurysma Schellen

Pincas anévrisme  
Abrazaderas Aneurisma



DeBakey-Bahnsen

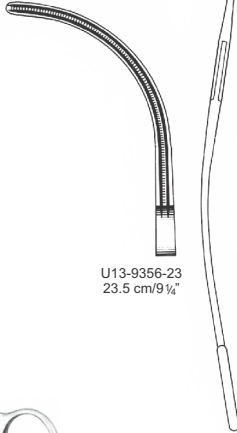

U13-9356-23  
23.5 cm/9 1/4"

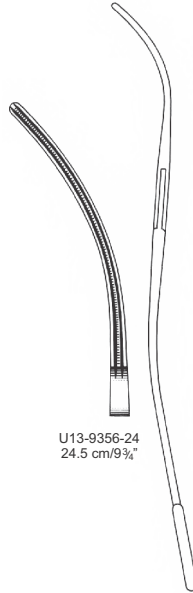

U13-9356-24  
24.5 cm/9 3/4"

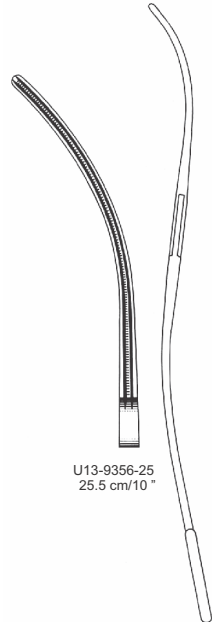

U13-9356-25  
25.5 cm/10"



# Instrument Design & Production Company

## Cardiovascular Instruments

Multi Purpose vascular Clamps  
Mehrzweck Gefäßklemmen

Pinces Multi Purpose vasculaires  
Abrazaderas multipropósito vasculares

13



DeBakey

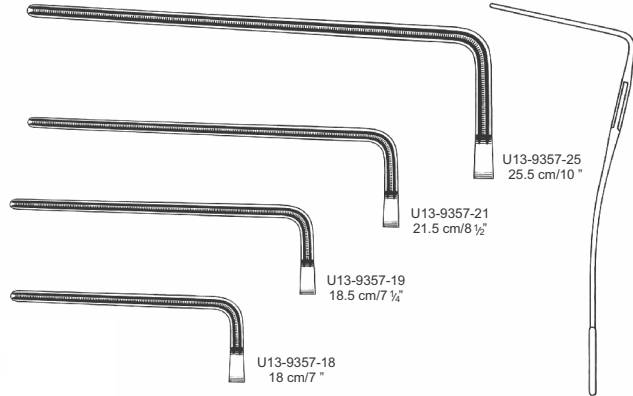

DeBakey

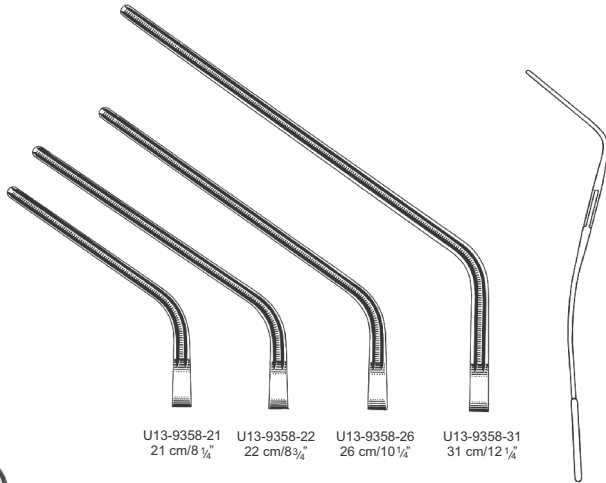

### Cardiovascular Instruments

Multi Purpose vascular Clamps  
Mehrzweck Gefäßklemmen

Pinces Multi Purpose vasculaires  
Abrazaderas multipropósito vasculares



**Potts**



U13-9359-21  
21.5 cm/8 1/2"



U13-9359-23  
23.5 cm/9 1/4"



U13-9359-27  
27 cm/9 3/4"



U13-9359-31  
31 cm/12 1/4"



U13-9360-21  
21 cm/8 1/4"



U13-9360-23  
23 cm/9"



U13-9360-26  
26 cm/9 1/2"

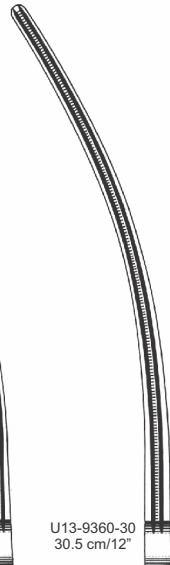

U13-9360-30  
30.5 cm/12"



**DeBakey-Pean**



U13-9361-14  
14.5 cm/5 3/4"

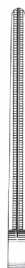

U13-9361-16  
16.5 cm/5 1/4"



U13-9361-18  
18.5 cm/7 1/4"



U13-9361-20  
20.5 cm/8"



**DeBakey-Pean**



U13-9362-14  
14.5 cm/5 3/4"



U13-9362-16  
16.5 cm/5 1/4"



U13-9362-18  
18.5 cm/7 1/4"



U13-9362-20  
20.5 cm/8"

13

## Cardiovascular Instruments

Multi Purpose vascular Clamps  
Mehrzweck Gefäßklemmen

Pinces Multi Purpose vasculaires  
Abrazaderas multipropósito vasculares

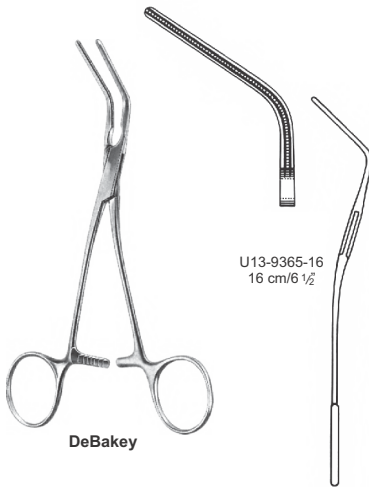
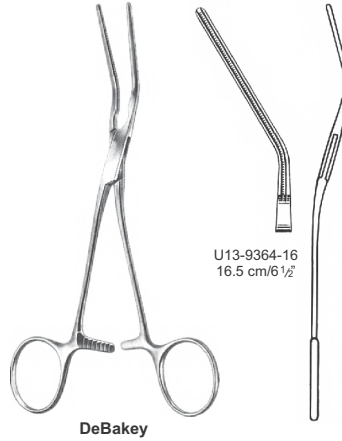

## Cardiovascular Instruments

Multi Purpose vascular Clamps  
Mehrzweck Gefäßklemmen

Pinces Multi Purpose vasculaires  
Abrazaderas multipropósito vasculares



**DeBakey**

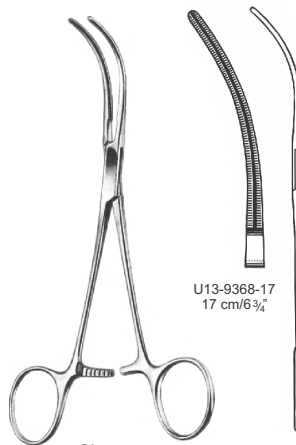

**Glover**

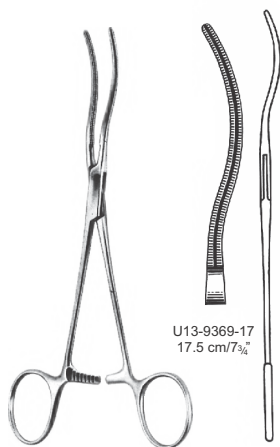

**Glover**

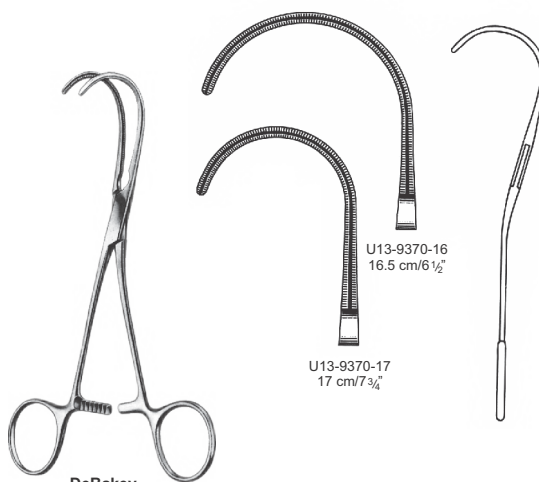

**DeBakey**

### Cardiovascular Instruments

Anastomosis Clamps, Multi purpose Vascular Clamps  
 Anastomose Klemmen, Mehrzweck Gefäßklemmen  
 Pincas Anastomose, colliers multi usages vasculaires  
 Abrazaderas, Abrazaderas anastomosis vasculares multipropósito



**Derra**

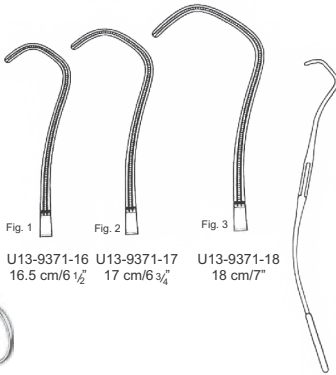

Fig. 1 U13-9371-16 16.5 cm/6 1/2"  
 Fig. 2 U13-9371-17 17 cm/6 3/4"  
 Fig. 3 U13-9371-18 18 cm/7"



**DeBakey-Beck**

U13-9372-17  
 17 cm/6 3/4"



**DeBakey**

U13-9373-10  
 10 cm/4"

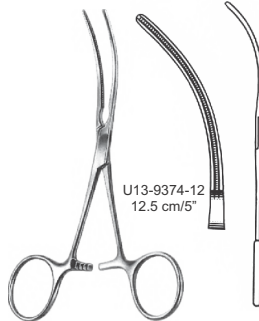

**DeBakey**

U13-9374-12  
 12.5 cm/5"



U13-9375-12  
 12 cm/5"

## Cardiovascular Instruments

Pediatric Vascular Clamps  
 Pediatric Gefäßsklemmen

Pédiatriques clamps vasculaires  
 Pediátricos pinzas vasculares



**DeBakey**

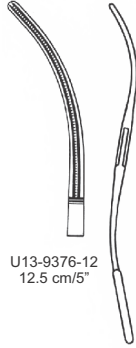

U13-9376-12  
 12.5 cm/5"



**DeBakey**

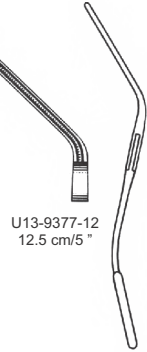

U13-9377-12  
 12.5 cm/5"

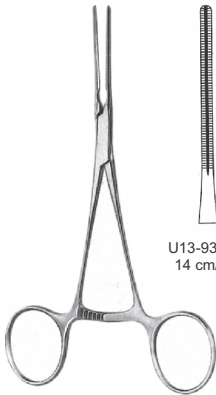

**DeBakey**



U13-9378-01  
 14 cm/5 1/2"

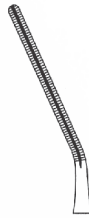

U13-9378-02  
 12.5 cm/5 3/4"

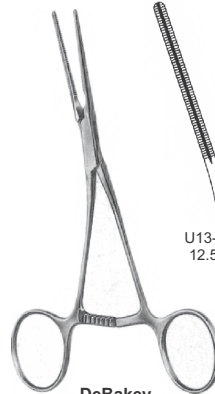

**DeBakey**

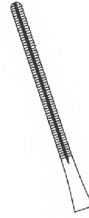

U13-9379-03  
 12.5 cm/5 1/2"



### Cardiovascular Instruments

Pediatric Vascular and Anastomosis Clamps  
Pediatrik Vasculär Anastomose und Schellen

Vasculaire pédiatrique et pinces Anastomose  
Vascular pediátrica y abrazaderas Anastomosis



U13-9380-14  
14 cm/5 1/2"

Cooley



Cooley  
U13-9381-14  
14 cm/5 1/2"



U13-9382-22  
22 cm/8 3/4"

Cooley  
Iliac Clamp



U13-9383-17  
17 cm/6 3/4"

Cooley

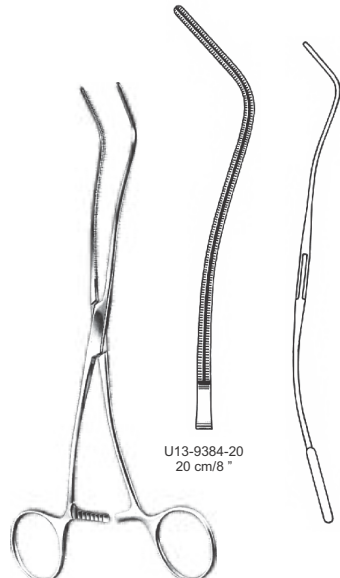

U13-9384-20  
20 cm/8"

Cooley

## Cardiovascular Instruments

Anastomosis Clamps, Multi purpose Vascular Clamps  
Anastomose Klemmen, Mehrzweck Gefäßklemmen

Pinces Anastomose, colliers multi usages vasculaires  
Abrazaderas, Abrazaderas anastomosis vasculares multipropósito



U13-9385-16  
16cm/6 1/4"

Cooley

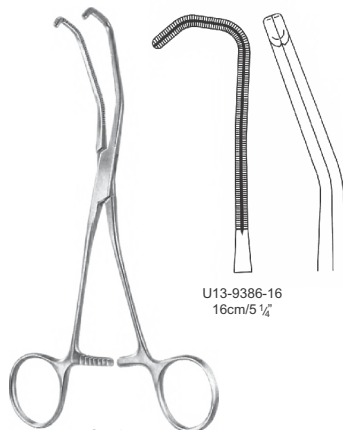
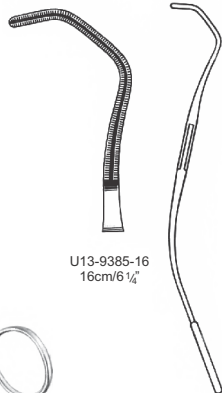

U13-9386-16  
16cm/5 1/4"

Cooley

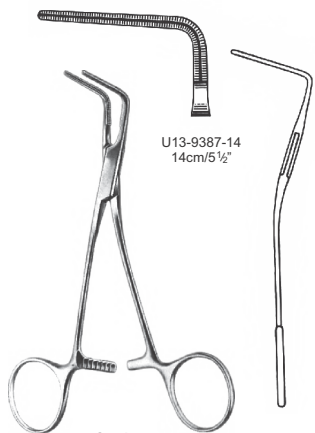

U13-9387-14  
14cm/5 1/2"

Cooley

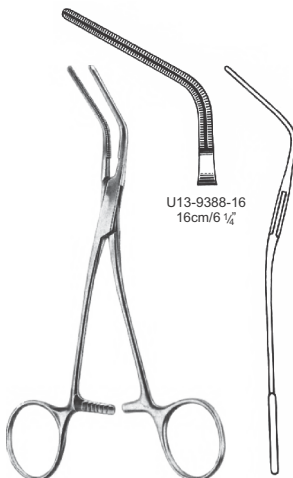

U13-9388-16  
16cm/6 1/4"

Cooley

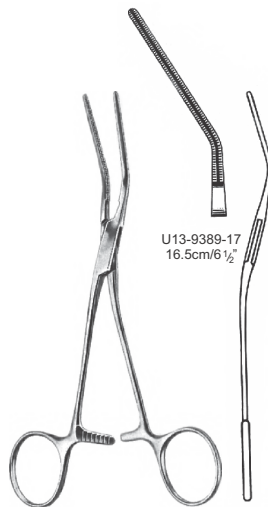

U13-9389-17  
16.5cm/6 1/2"

Cooley

**13**

## Cardiovascular Instruments

Multi Purpose vascular Clamps  
Multi Purpose Gefäßklemmen

Pinces Multi Purpose vasculaires  
Pinzas Multiuso vasculares

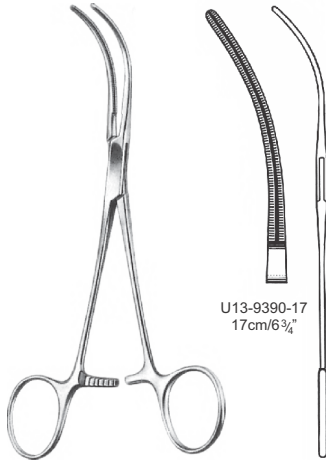

U13-9390-17  
17cm/6 3/4"

Cooley



U13-9391-17  
17cm/6 3/4"

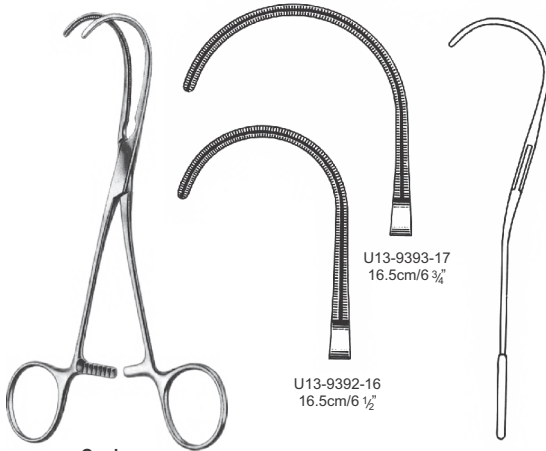

U13-9393-17  
16.5cm/6 3/4"

U13-9392-16  
16.5cm/6 1/2"

Cooley

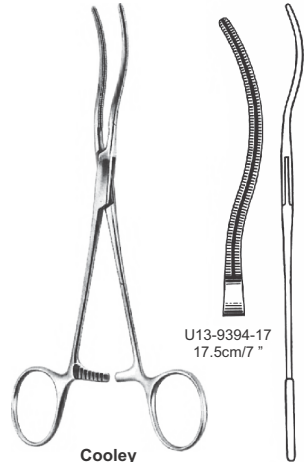

U13-9394-17  
17.5cm/7"

Cooley

## Cardiovascular Instruments

Multi Purpose vascular Clamps  
Multi Purpose Gefäßklemmen

Pinces Multi Purpose vasculaires  
Pinzas Multiuso vasculares



U13-9395-16  
16.5cm/7 1/2"

**DeBakey**



U13-9396-16  
16cm/7 1/4"

**DeBakey**



U13-9397-16  
15.5cm/6"

**DeBakey**



U13-9398-16  
15.5cm/6"

**Cooley**



U13-9399-16  
16cm/6"

**Cooley**

## Cardiovascular Instruments

Neonatal and Pediatric Clamps

Neonatalogischen und pädiatrischen Schellen

Pinces néonatale et pédiatrique

Abrazaderas neonatal y pediátrica

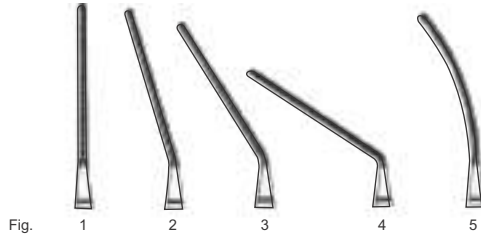

Fig.



Fig.

Fig.	Straight gerade droit recto
1	U13-9400-01
2	U13-9400-02
3	U13-9400-03
4	U13-9400-04
5	U13-9400-05
6	U13-9400-06
7	U13-9400-07
8	U13-9400-08
9	U13-9400-09



Fig.	Angled Anglé incliné angular
1	U13-9401-01
2	U13-9401-02
3	U13-9401-03
4	U13-9401-04
5	U13-9401-05
6	U13-9401-06
7	U13-9401-07
8	U13-9401-08
9	U13-9401-09



Fig.	Curved Gebogene courbé Curvo
1	U13-9402-01
2	U13-9402-02
3	U13-9402-03
4	U13-9402-04
5	U13-9402-05
6	U13-9402-06
7	U13-9402-07
8	U13-9402-08
9	M13-7292-09





## Cardiovascular Instruments

Neonatal Vascular Clamps  
Neonatal Gefäßklemmen

Néonatales clamps vasculaires  
Neonatales pinzas vasculares

13



Castaneda

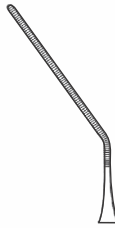

U13-9403-01  
12cm/5"

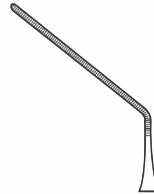

U13-9403-02  
11.5cm/4½"



U13-9403-03  
11cm/4¼"

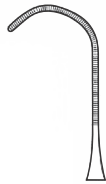

U13-9404-01  
11.5cm/4½"

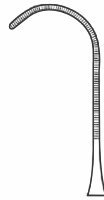

U13-9404-02  
12cm/4¾"



U13-9404-03  
12cm/4¾"

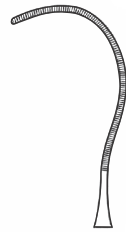

U13-9404-04  
12cm/4¾"

**13**

## Cardiovascular Instruments

Intima Spatula, Vascular Dissectors  
Lingerie Spachtel-, Gefäß-Dissektoren

Spatule intime, dissecteurs vasculaires  
Intima Spatula, Vascular disector



U13-9405-18  
18.5cm/7 1/4"

Intima Spatula

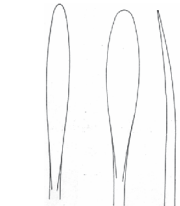

U13-9406-14  
14cm/5 1/2"

U13-9406-23  
23.5cm/9 1/4"



5 mm



4 mm



2.5 mm Ø

**Robb**  
U13-9407-01  
24cm/9 1/2"  
Fig. 1



2.0 mm Ø

**Robb**  
U13-9407-02  
24cm/9 1/2"  
Fig. 2



3 mm

1.5 mm Ø

**Robb**  
U13-9407-03  
24cm/9 1/2"  
Fig. 3



2 mm

1.0 mm Ø

**Robb**  
U13-9407-04  
24cm/9 1/2"  
Fig. 4

## Cardiovascular Instruments

Nerve Hooklets, Toruniqetes  
Nerve Häkchen, Toruniqetes

Petits crochets nerveuses, Toruniqetes  
Ganchillos nerviosas, Toruniqetes

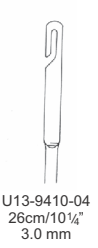
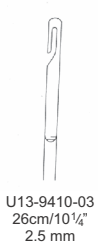

U13-9411-27  
26cm/10 3/4"  
3.0 mm  $\phi$

U13-9411-30  
30.5cm/12"  
6.4 mm  $\phi$



13

## Cardiovascular Instruments

Aortic Dilators  
Aorten-Dilatatoren

Dilatateurs aortiques  
dilatadores aórticos

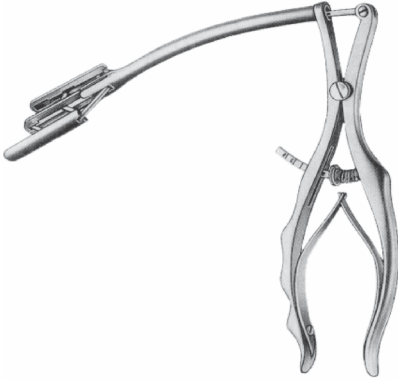

**Cooley**  
U13-9412-00



**Gerbode**  
U13-9413-00

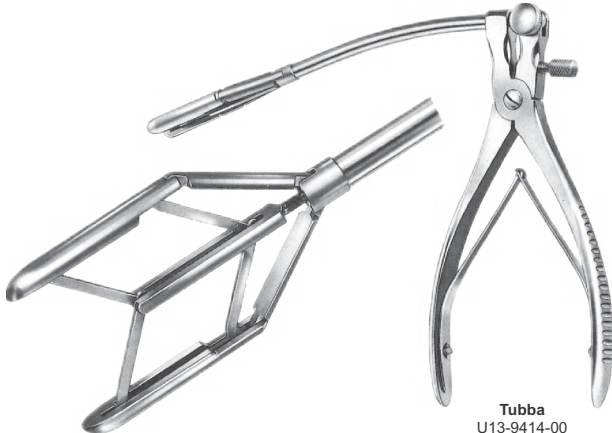

**Tubba**  
U13-9414-00