

CHEVY | GMC

 **LEER**



 **LEER**[®]
ENGINEERED TO ENDURE

NORTH AMERICA'S
NUMBER ONE
TRUCK CAP
BRAND





REPUTATIONS ARE EARNED, NOT GIVEN

For over 50 years, LEER® has never rested. We constantly push every process, every component, latch, and knob to exceed expectations, last longer, and be stronger. We fully believe beauty, brawn, and brains are never optional but mandatory. Protecting your valuable cargo is paramount. This is our commitment to you: a relentless passion for unsurpassed quality that makes LEER not only a leader, but a legend.



North America's Most
Trusted Truck Caps



Custom Created to
Match Every Truck Model



Aerodynamic Styling for
Improved Airflow



Limited Lifetime
Warranty†

† See complete warranty statement for details.

BEAUTY. BRAWN. BRAINS.

LEER fiberglass truck caps are the perfect blend of capability, capacity, and convenience designed to make life easier, more successful, and more fun. With multiple models to choose from – all loaded with standard features and customizable options – LEER offers incredible flexibility to get exactly what you want, including upgraded security, window functionality, and the latest innovations like keyless entry.

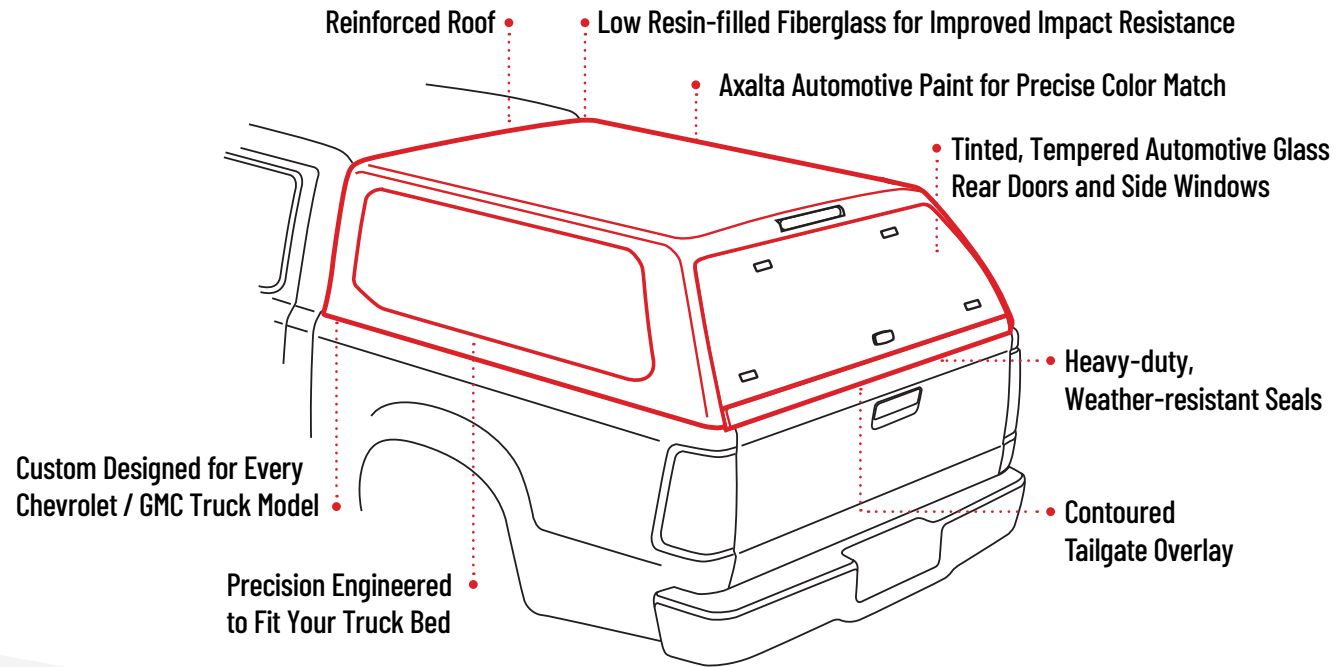

LEER CAP HEIGHTS

Capacity should never hold you back. LEER offers three cap heights so you never fall short on any challenge. And with our balanced design approach of cargo capacity, fuel-efficiency, low road noise and stunning aesthetics, LEER truck caps always deliver on both form and function.

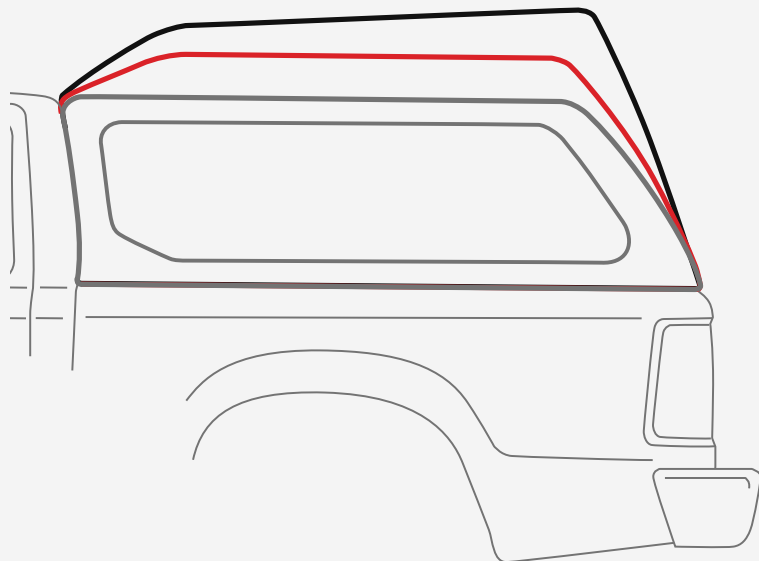

High-Rise

up to 40% more storage capacity on LEER 122

Mid-Rise

up to 15% more storage capacity on LEER 180 Series

Cab-High

Consistent height with your truck cab

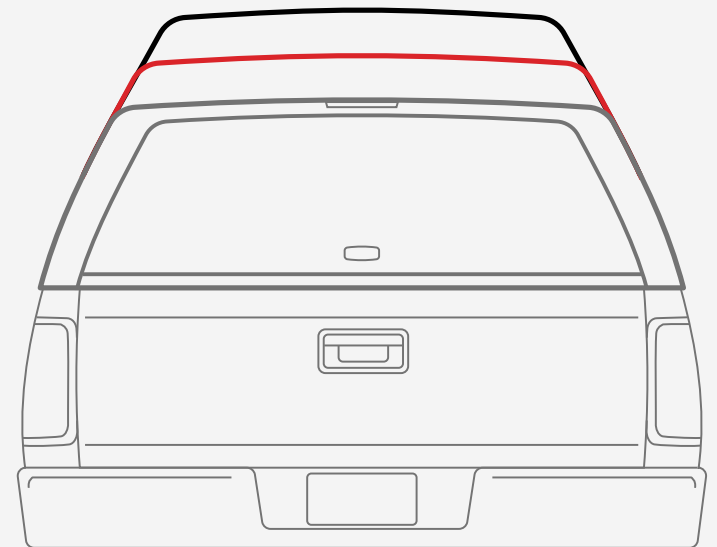

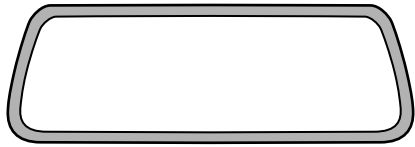

Fixed Front Window

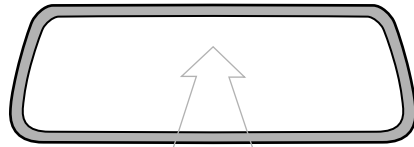

Removable Front Picture Window*

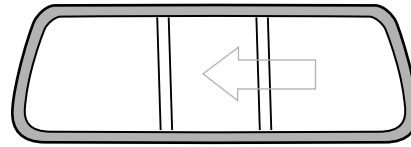

Front Slider Window

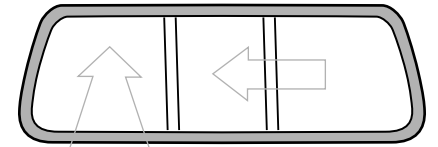

Removable Front Slider Window*

FRONT WINDOWS

WINDOWS TO THE WORLD

Windows matter. But not one window is right for everyone, so LEER gives you many options for both cab and side windows to get the look, ventilation, and utility you're after. From solid windows to tip outs, 50/50 sliding to removable, it's your truck cap, and we aim to make it not just meet but exceed your expectations.

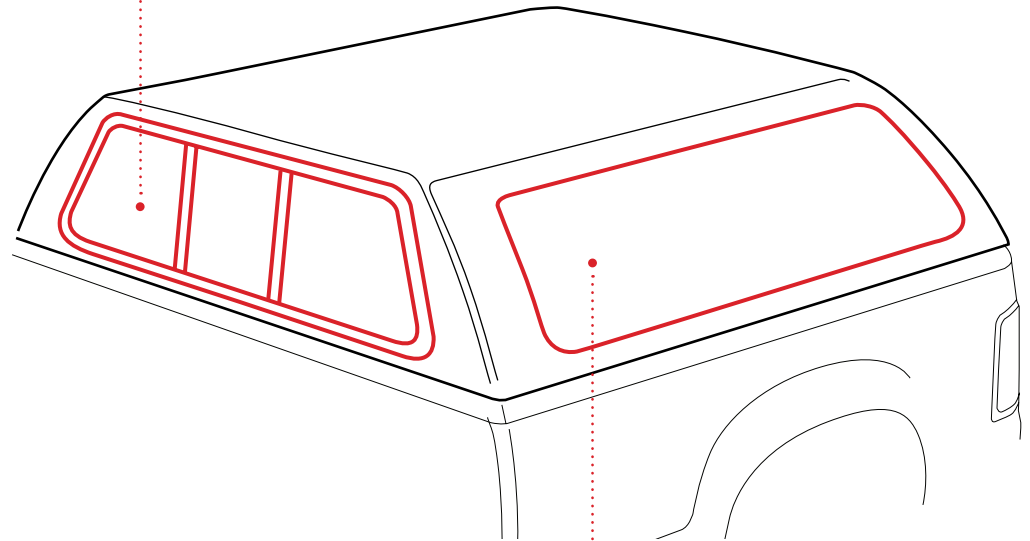

SIDE WINDOWS

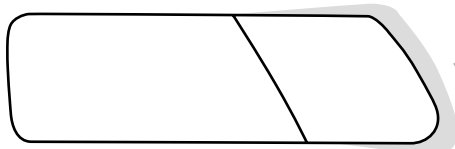

Side Windows w/Twist-Out Vents and Screens

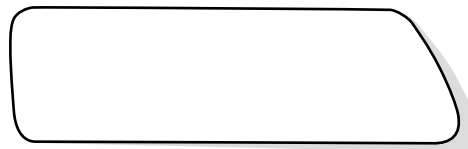

One-Piece Tip-Out Side Windows w/Screen (back part only)

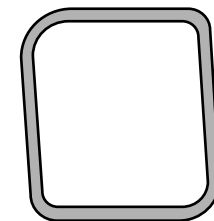

Side Bay Windows

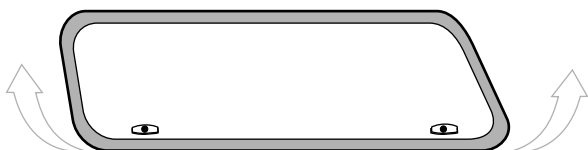

Radius Side Windows

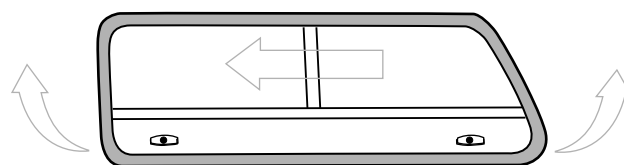

Radius Side Window Sliders

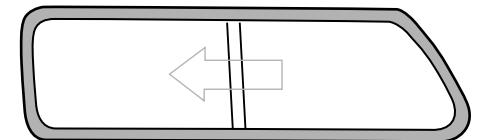

50/50 Sliding Windows w/Screens

* May use a tilt-down front window vs. a removable window in some regions. Consult your authorized LEER dealer in your market.

STANDARD FEATURES ON ALL MODELS

- One-Piece Fiberglass Base Rails
- Recessed Third Brake Light (LED Clear Lens)
- Limited Lifetime Warranty†



100XQ

Substance Meets Style

Our premium LEER 100XQ features frameless, tip-out side windows while providing optimal airflow. Its curved-glass rear door completes the look with premium hidden hinges and weather-resistant door skirt. In other words, if you want it all, 100XQ delivers.

- One-Piece Tip-Out Side Windows with Removable Screens
- Frameless Curved Glass Rear Door
- Headliner Standard
- Rotary Latch System
- + Keyless Entry (optional)



100XL

Safer. Sleeker. Smarter.

LEER 100XL dials up the amenities, security, and design to enjoy more of every mile. Its fluid lines and premium components give the 100XL the look of an high-end SUV with the utility and capacity to win at any adventure.

- Recessed Side Windows with Twist-Out Vents and Screens
- Frameless Curved Glass Rear Door
- Rotary Latch System
- + Keyless Entry (optional)

- Tinted Rear Glass Doors
- Fixed Front Window

- Custom Fit for Every Model
- Axalta Automotive Paint

- Insulated Roof
- Gas Door Props

- Installation Bulb Seal**
- J-Bolt Installation Clamps**

- Skirted Rail (Varies by Model)



100XR In Full View

LEER enthusiasts love the wide viewing angles of the 100XR all-glass rear door with center-mounted LEER flip lock. And with its recessed 50/50 sliding windows, 100XR provides incredible ventilation throughout the cap.

- Recessed Tinted Side Sliding Windows & Screens
- Frameless Curved Glass Rear Door
- Rotary Latch System
- + Keyless Entry (optional) W/Upgraded Lock



100R 'Air' to the Throne

LEER 100R opens new opportunities with our screened 50/50 sliding side windows. Perfect for traveling pets[§], camping, or just adding some fresh air to your sports equipment, plants, or any cargo, LEER 100R helps make any haul an easy breeze.

- 50/50 Sliding Side Windows + Windoor Slider (optional)
- Dome Light + Windoor (optional)

[§] While vehicle is not in motion or running



100S Smooth Operator

LEER 100S is a smooth-side truck cap for those looking for cargo privacy, protection, or even promotion thanks to its large area for branding or graphics.

- Smooth Sides
- Double T-Handle Locks
- + 50 / 50 Slider (optional)†
- + Windoor (optional)†
- + Windoor Slider (optional)†
- Framed Glass Rear Door
- Front Glass Window
- + J-Bolt Installation (optional)
- + Installation Bulb Seal (optional)

** Standard on all models except for 100S †Non-recessed windows



180XL

Above & Beyond

Long considered a truck favorite, LEER 180XL delivers on capability, convenience, and capacity with up to 15% more cargo space than cab-high models. This premium, mid-rise truck cap features recessed one-third flip-out windows, providing excellent airflow for pets[§] and cargo, large curved rear window, and a rotary rear door latch system for easy locking.

- Frameless Side Windows
- Up to 15% more Interior Room over Cab-High Models
- + Keyless Entry (optional)

Limited Availability. Consult your local dealer for details

[§] While vehicle is not in motion or running



180XR

Curve Appeal

Gorgeous design lines bring exceptional fit and finish to the LEER 180XR including its custom-curved glass and convenient rotary rear door handle with locking latch system.

- Frameless Curved Glass Rear Door
- Rotary Latch System
- Up to 15% more Interior Room over Cab-High Models
- Recessed 50/50 Sliding Side Windows with Screens
- + Keyless Entry (optional)

Limited Availability. Consult your local dealer for details



180

Elevated Experience

Take capability to new heights with the LEER 180. This mid-rise cap features double T-handle locks for advanced security with a twist of the wrist and easy slide 50/50 side windows with screens to help keep things cool.

- Double T-Handle Locks
- Recessed Framed Door
- Up to 15% more Interior Room over Cab-High Models
- Recessed 50/50 Sliding Side Windows with Screens

Limited Availability. Consult your local dealer for details

122 High-Rise Reach New Heights

No order is too tall for LEER 122. This spacious high-rise is crafted for the most demanding jobs, giving you both extra room and height to carry once impossible loads. The LEER 122 features a full-height door, so now tall items can stand straight and load with ease. LEER 122 not only looks great but its streamlined design also helps reduce road noise.

- Aerodynamic High-Rise profile
- Up to 40% more Interior Room over Cab-High Models
- 50/50 Slider and Side Bay Window
- Full Length 50/50 Slider (optional)[†]
- Window Slider (optional)[†]
- Window (optional)[†]

Limited Availability. Consult your local dealer for details

[†]Non-recessed windows



UPGRADES

Every LEER comes loaded with standard features to help you work hard and play easy. Additional accessories are also available to customize your cap for added utility, ventilation, security, and convenience. Find what's for you.



SCREEN PROTECTORS



KEYLESS ENTRY (Using Your Truck's Keyfob)



INTERIOR CLOTHES HANGER (Single or double)



FISHING ROD HOLDER



LED TUBE LIGHTING



SWITCH ACTIVATED LIGHTING



INTERIOR HEADLINER



THREE-OUTLET 12V POWERBLOCK



OVERHEAD GEAR NET (Requires Roof Rack)



INTERIOR ROOF-MOUNT CARGO HOOKS

THULE[®]

SWEDEN

Top off your LEER truck cap with a wide assortment of Thule roof racks and track systems. It's the finishing touch that helps you pile on the possibilities.



TRACKER II ROOF RACK SYSTEM
(Locks included)



WING BAR EVO ROOF RACK SYSTEM
(Locks included)



TRACKS ONLY
(Works with Most Track Mounted Crossbars)



LEER Locker

Organization is key. LEER Locker transforms space into sliding shelving to make order out of any chaos. Tools, sports equipment, landscaping – you name it.

LEER Locker is the pros' tried, true, and tested storage solution forged to handle the toughest wear, and the most random of requests.

- LEER Locker not available on 122
- May not be available for all trucks/bed sizes. Consult your authorized LEER dealer.

BEDSLIDE®

Your world now at your fingertips with BEDSLIDE®. This innovative slide system puts everything easily within reach. And with multiple compartments to organize tools and recreation gear with a load rating of up to 2,000 lbs., BEDSLIDE is a proven winner.



COMPARISON CHART

● Standard + Option	100 X0	100 XL	100 XR	100 R	100 S	180 XL	180 XR	180	122 High-Rise
Frameless Hidden Hinge Curved Rear Door	●	●	●			●	●		
Recessed Framed Door w/Double T-Handle Locks				●	●			●	●
LEER Twist Handle Lock w/Flip-up Weather Cover	●	●				●			
LEER Flip-lock Handle			●				●		
Automotive Style Rotary Latches	●	●	●			●	●		
Interior Headliner (Black or charcoal grey)	●	+	+	+	+	+	+	+	+
Interior LED Dome Light	●	●	●	●	+	●	●	●	●
LED Tube Lighting	+	+	+	+	+	+	+	+	+
Keyless Remote	+	+	+			+	+		
Additional Battery or 12V Dome Light	+	+	+	+	+	+	+	+	+
12V Gas Prop Switch for Interior Lighting	+	+	+	+	+	+	+	+	+
Blank Sides (No windows)				+	●		+	+	+
Screen Protectors		+	+	+	+	+	+	+	+
Side Windows w/Twist-Out Vents		●				●			
One-Piece Tip-Out Side Windows	●								
50/50 Sliding Windows			●	●	+		●	●	●
Radius Side Windows			+	+	+		+	+	+
Radius Side Window Sliders			+	+	+		+	+	+

Not all options are available for all models and trucks. LEER maintains the right to add, delete, or change designs and/or suppliers of options when necessary to maintain or improve the overall quality without written notice.



LOAD UP WITH THE LEADER

Complete your Chevrolet / GMC Truck with North America's Most Trusted Truck Cap Brand
Visit leer.com

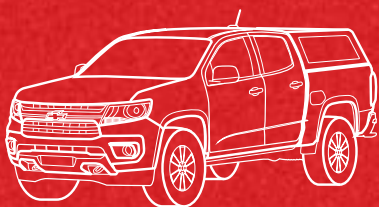

Colorado | Canyon

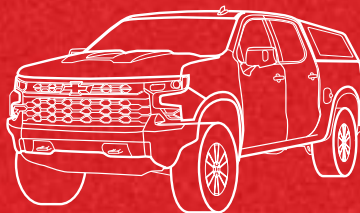

Silverado | Sierra

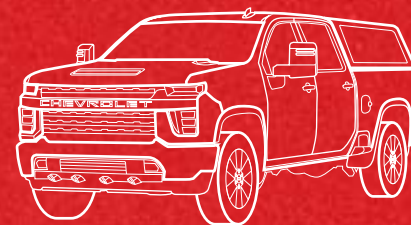

Silverado HD | Sierra HD



All illustrations and specifications contained in this literature are based on the latest product information at the time of publication. Check with your local LEER Retailer for complete product information. LEER reserves the right to make changes in prices, colors, materials, equipment, specifications, and models at any time without notice or prior obligation. ©2022 LEER®, LEER Group LLC; A J.B. Poindexter Company. Part #800009 • Form #10781

AUTHORIZED LEER RETAILER

⚠ CALIFORNIA PROPOSITION 65 WARNING ⚠

WARNING: This product contains chemicals known to the State of California to cause cancer and birth defects or other reproductive harm.

For more information: www.P65Warnings.ca.gov



Serving the Motor Vehicle Aftermarket



† See complete warranty statement for details.